



AAEON PICO-EHL4-A11-0004 Intel Atom x6000E/Intel Pentium/Celeron Pico-ITX Board

Key Features:

- Intel Atom x6000E series, Intel Pentium, and Celeron N and J series processors (formerly Elkhart Lake)
- HDMI2.0b x 2 + LVDS/eDP1.3 x 1
- GbE x 2
- 2 x USB 3.2 Gen 2, 2 x USB2.0
- LPDDR4x onboard memory, In-Band ECC
- eMMC x 1, SATA x 1
- COM x 2 Full, CANBUS x 2(optional), mSATA x 1, M.2 E-Key 2230 x 1

Description

The PICO-EHL4 Series brings the latest Intel Atom, Celeron and Pentium processors (formerly Elkhart Lake) to the compact PICO-ITX form factor. The Intel Atom x6000E series processors, Intel Pentium and Celeron N and J series processors (formerly Elkhart Lake) deliver greater computing performance over previous generations along with key technologies like in-band ECC to ensure data accuracy and integrity. The PICO-EHL4 takes advantage of the support for faster memory speeds and higher capacities by providing up to 16GB of LPDDR4x 4267MHz memory on-board.

The PICO-EHL4-A11-0004 provides a host of features allowing for flexibility to meet the needs of individual applications. Expansion slots include both M.2 2230, perfect for adding Wi-Fi or Bluetooth functionality; and full sized Mini-Card for expanded storage, AI accelerators, and more.

The PICO-EHL4-A11-0004 can connect with a range of devices thanks to 4-bit GPIO as well as dual Gigabit Ethernet LAN ports, two USB3.2 and two USB2.0 ports, and two serial port headers (RS232/422/485). The PICO-EHL4 also features two HDMI 2.0 ports supporting 4K graphics at 60Hz, as well as on-board co-lay LVDS/eDP allowing the board to output up to three independent displays.

PICO-EHL4

Pico-ITX Board with Intel® Atom™ x6000E Series, Intel® Pentium®, and Celeron® N and J series processors

Pico-ITX Boards

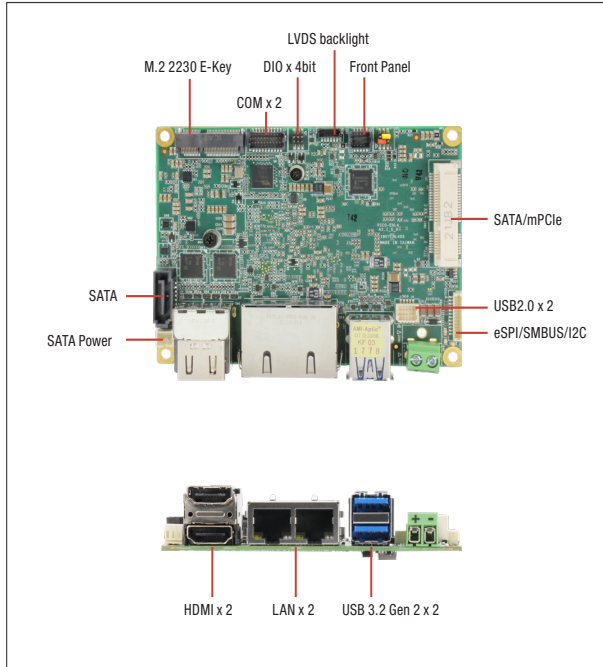

Features

- Intel® Atom™ x6000E series, Intel® Pentium®, and Celeron® N and J series processors (formerly Elkhart Lake)
- HDMI2.0b x 2 + LVDS/eDP1.3 x 1
- GbE x 2
- 2 x USB 3.2 Gen 2, 2 x USB2.0
- LPDDR4x onboard memory, In-Band ECC
- eMMC x 1, SATA x 1
- COM x 2 Full, CANBUS x 2(optional), mSATA x 1, M.2 E-Key 2230 x 1



AUDIO	
CODEC	—
AUDIO INTERFACE	—
Speaker	—
EXTERNAL I/O	
ETHERNET	Realtek RTL8111H-CG , 10/100/1000Base-TX, RJ-45 x 2
USB	USB 3.2 Gen 2 x 2
SERIAL PORT	COM1, COM2 (RS232/422/485, supports 5V/12V/RI)
VIDEO	HDMI 2.0b x 2 (4K x 2K 60Hz)
INTERNAL I/O	
USB	USB 2.0 x 2
SERIAL PORT	COM1, COM2 (RS232/422/485, supports 5V/12V/RI)
VIDEO	eDP (up to HBR3, 8K x 4K 30Hz) LVDS (18/24bit 2CH)
SATA	SATA III x 1 +5V SATA Power Connector x 1 Onboard eMMC 5.1, up to 128GB
AUDIO	—
DIO/GPIO	4-bit
SMBus/I2C	SMBus/I2C and eSPI x 1 (SMBus as default, I2C select by HW BOM)
Touch	—
FAN	4pins Smart Fan x1
SIM	—
Front Panel	HDD LED, PWR LED, Power Button, Buzzer, Reset
Others	—
EXPANSION	
Mini PCI-E/mSATA	Full size mPCIe/mSATA x 1 (SATA as default, PCIe selected by BIOS)
M.2	M.2 E key 2230 x 1 (PCIe x 1/USB2.0)
Others	CANBUS x 2 (optional, N6210/J6412 not support, support up to 5Mbit/s)
ENVIRONMENT & CERTIFICATION	
OPERATING TEMP	32°F ~ 140°F (0°C ~ 60°C)
STORAGE TEMP	-40°F ~ 185°F (-40°C ~ 85°C)
OPERATING HUMIDITY	0% ~ 90% relative humidity, non-condensing
MTBF (HOURS)	489,989
EMC	CE/FCC Class A

Specifications

SYSTEM	
FORM FACTOR	PICO-ITX
CPU	Intel® Atom™ x6000E series, Intel® Pentium®, and Celeron® N and J series processors: Intel® Atom™ x6425RE (4C, 1.9GHz, TDP 12W) Intel® Atom™ x6414RE (4C, 1.5GHz, TDP 9W) Intel® Atom™ x6212RE (2C, 1.2GHz, TDP 6W) Intel® Atom™ x6425E (4C, 2.0GHz, up to 3GHz, TDP 12W) Intel® Atom™ x6413E (4C, 1.5GHz, up to 3GHz, TDP 9W) Intel® Atom™ x6211E (2C, 1.3GHz, up to 3GHz, TDP 6W) Intel® Pentium® J6426 (4C, 2.0GHz, up to 3GHz, TDP-up 10W) Intel® Pentium® N6415 (4C, 1.2GHz, up to 3GHz, TDP 6.5W) Intel® Celeron® J6412 (4C, 2.0GHz, up to 2.6GHz, TDP-up 10W) Intel® Celeron® N6210 (2C, 1.2GHz, up to 2.6GHz, TDP-up 6.5W) (Intel® Atom™ x6414RE/x6413E/x6427FE/x6200FE/N6415 by customer's request)
CHIPSET	Intel® Elkhart Lake SoC Processor
MEMORY TYPE	LPDDR4x up to 3200MHz, up to 16GB
BIOS	UEFI
WAKE ON LAN	Yes
WATCHDOG TIMER	255 Levels
SECURITY	Intel® PTT (Integrated TPM)
RTC Battery	Lithium Battery 3V/240mAh
DIMENSION	3.94" x 2.84" (100mm x 72mm)
Gross Weight	0.18 lbs (0.08 kg)
OS Support	Windows 10 (64 bit) Ubuntu 20.04.3(IOT)/Kernel 5.13
POWER	
POWER REQUIREMENT	+12V
POWER SUPPLY TYPE	AT/ATX
CONNECTOR	Phoenix 2-pin Connector (Default) Lockable DC Jack Connector (colay)
POWER CONSUMPTION	Intel® Atom™ x6425E, LPDDR4x onboard 16GB, 2.48A@ +12V(TYPICAL) Intel® Atom™ x6425E, LPDDR4x onboard 16GB, 2.62A@ +12V(MAX)
DISPLAY	
CONTROLLER	Intel® UHD Graphics for 10th Gen Intel® Processors
LVDS/eDP	eDP (up to HBR3, 8K x 4K 30Hz) LVDS (18/24bit 2CH)
Display Interface	HDMI 2.0b x 2 (4K x 2K 60Hz)
Multiple Display	Up to 3 Simultaneous Displays

Optional Accessories

Part Number	Description	Qty.
170X000231	COM cable	1
170010010D	USB2.0 cable	1
1709070500	SATA cable	1
1702150155	SATA power cable	1
1703120130	eSPI/SMBUS/I2C cable	1
1709100108	Front panel cable	1
PICO-EHL4-HSP01	Heat Spreader.AL.100*72*6.8mm.for Pentium/Celeron of PICO-EHL4	1
PICO-EHL4-HSP02	Heat Spreader.AL.100*72*5.8mm.for Atom series of PICO-EHL4	1
PICO-EHL4-HSK01	Heat Sink.100*72*15.5mm.Silver.To be used with HSP	1
PICO-EHL4-FAN01	Cooler.100*72*20.3mm.for Pentium/Celeron of PICO-EHL4	1
PICO-EHL4-FAN02	Cooler.100*72*19.3mm.for Atom series of PICO-EHL4	1

Note:
eDP Panel : B173ZAN01.0-AUO LVDS Panel : G121XN01 V0-AUO

Note: All specifications are subject to change without notice.

PICO-EHL4

03

PICO-ITX Boards

Block Diagram

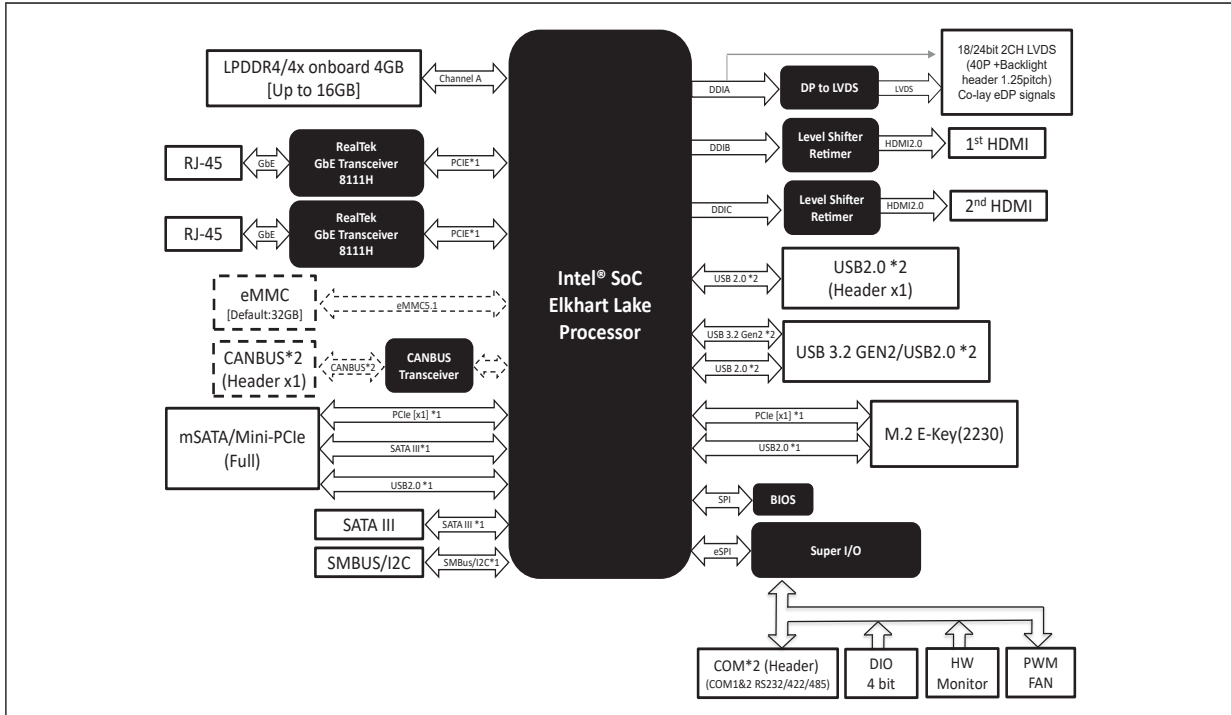

Dimension Unit: mm

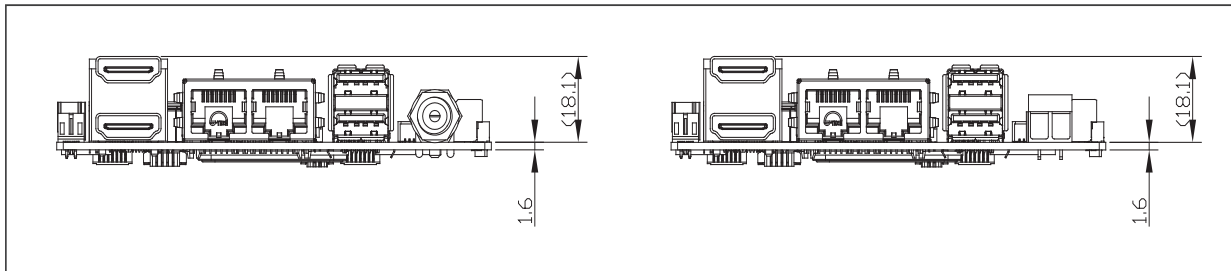

Packing List

- PICO-EHL4

Ordering Information

Part number	CPU	Memory	Display	Storage	LAN	USB	RS-232/422/485	Expansion slot	Power	Operating Temp	Others
PICO-EHL4-A11-0001	N6210	4GB	HDMI x 2 LVDS x 1	SATAIII x 1 eMMC 32GB	GbE x 2	USB3.2 Gen 2 x 2 USB2.0 x 2	2	M.2 2230 E-key x 1 mSATA(Full-size) x 1	+12V	0°C ~ 60°C	DIO 4 bit SMBUS/eSPI x 1
PICO-EHL4-A11-0002	J6412	4GB	HDMI x 2 LVDS x 1	SATAIII x 1 eMMC 32GB	GbE x 2	USB3.2 Gen 2 x 2 USB2.0 x 2	2	M.2 2230 E-key x 1 mSATA(Full-size) x 1	+12V	0°C ~ 60°C	DIO 4 bit SMBUS/eSPI x 1
PICO-EHL4-A11-0003	J6412	4GB	HDMI x 2 eDP x 1	SATAIII x 1 eMMC 64GB	GbE x 2	USB3.2 Gen 2 x 2 USB2.0 x 2	2	M.2 2230 E-key x 1 mSATA(Full-size) x 1	+12V	0°C ~ 60°C	DIO 4 bit SMBUS/eSPI x 1
PICO-EHL4-A11-0004	J6412	8GB	HDMI x 2 LVDS x 1	SATAIII x 1	GbE x 2	USB3.2 Gen 2 x 2 USB2.0 x 2	2	M.2 2230 E-key x 1 mSATA(Full-size) x 1	+12V	0°C ~ 60°C	DIO 4 bit SMBUS/eSPI x 1

Images

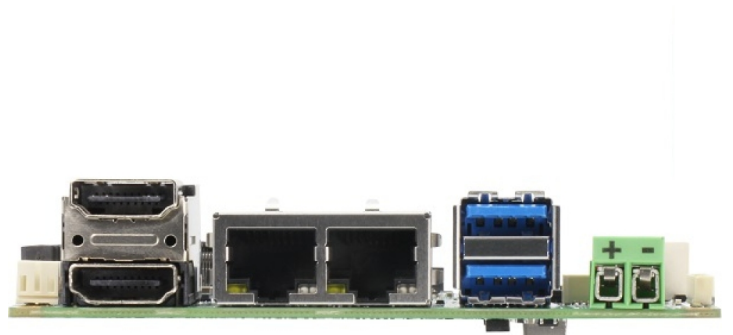
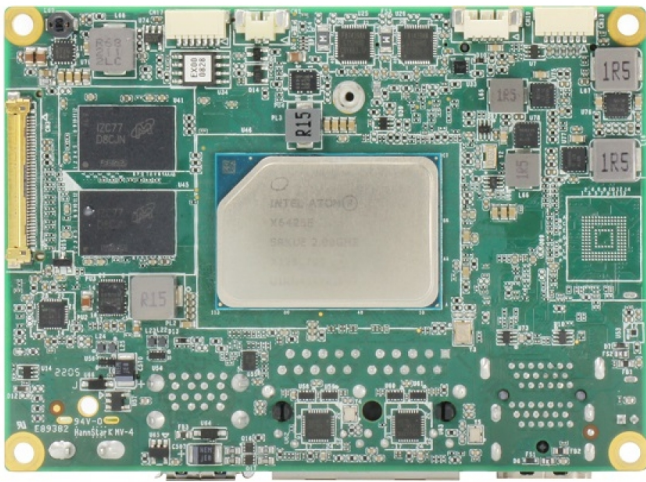
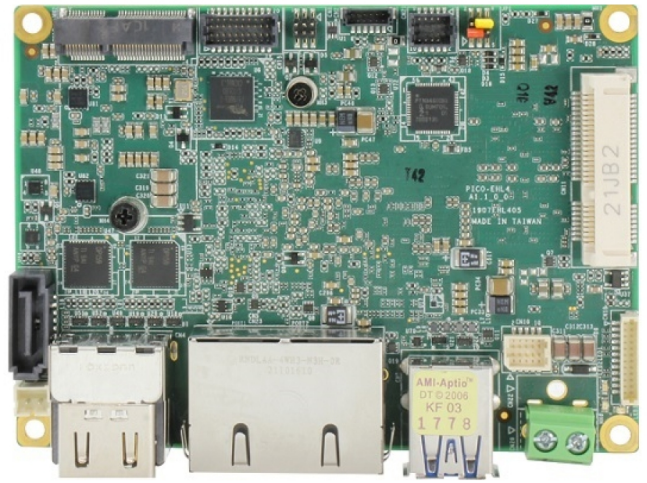

Assured Systems

Assured Systems is a leading technology company with over 1,500 regular clients in 80 countries, deploying over 85,000 systems to a diverse customer base in 12 years of business. We offer high-quality and innovative rugged computing, display, networking and data collection solutions to the embedded, industrial, and digital-out-of-home market sectors.

US

sales@assured-systems.com

Sales: +1 347 719 4508
Support: +1 347 719 4508

1309 Coffeen Ave
Ste 1200
Sheridan
WY 82801
USA

EMEA

sales@assured-systems.com

Sales: +44 (0)1785 879 050
Support: +44 (0)1785 879 050

Unit A5 Douglas Park
Stone Business Park
Stone
ST15 0YJ
United Kingdom

VAT Number: 120 9546 28
Business Registration Number: 07699660