

Foreword

Thank you for purchasing this car.

This instruction manual applies to the model of NEW D70 series. Before using the vehicle for the first time, please be sure to read this manual carefully and get familiar with the vehicle structure, various functions, operation methods and relevant regulations of BAIC as soon as possible. The user will lose the right to claim because of failed following the instruction of the user manual, or the modification without the approval of BAIC. The contents contained in the instruction manual will help you learn the correct method of driving and maintenance, so that you can fully enjoy the fun of driving.

This manual aims to provide users with instructions on the use and maintenance of vehicles. Please check the purchase contract for the specific configuration of the vehicles you purchased. If you have any questions about this car and this manual, please contact BAIC distributor in your country.

The pictures, data and instructions contained in this manual conform to the current product definition. In view of BAIC will continue to modify and improve the vehicle, the pictures, data and instructions in the operation manual are only for the introduction of the use method, not as a basis for order acceptance.

We will continue to improve all models. Therefore, we reserve the right to change the vehicle, equipment or part of the technical specifications at any time. Please understand. Data relating to delivery scope, appearance, performance, size, weight, fuel consumption, specifications and vehicle functions are correct as of the time of delivered. Some of the equipment/functions described in this article may not be installed on your vehicle ((For more details, please consult the authorized dealer of BAIC). All information, drawings or descriptions in this manual shall not be deemed as a legal commitment.

BAIC solemnly declares that it is solely responsible for the revision of this manual, and reserves all rights and interests stipulated in the copyright law and the right to modify.

Without the prior written consent of BAIC, it is not allowed to reproduce, copy or translate

Foreword

The equipment/functions marked with "*" are only applicable to some models or only used as optional parts or optional functions for some models. Please refer to the real car configuration.

"Warning", "attention", "prompt" and some special symbols will appear frequently in this instruction manual. Special attention should be paid to these contents, ignoring these warning instructions may lead to personal injury or damage to your vehicle.



"Warning" means that failure to follow instructions is likely to result in serious bodily injury or even death;



"Caution" means that dangerous or unsafe operation will result in personal injury or vehicle damage;



Tips give helpful information.



" " Indicate, which means "do not do this" or "do not let this happen."



" " Indicate, which means "please do this" or "this operation is feasible".



" " A similar sign that in order to indicate an item in the diagram.



" " A similar sign indicates the direction of movement or action.

BAIC International Development Co., Ltd

1. Before you use the vehicle, please be sure to carefully read this instruction manual, in the process of using the vehicle comply with the operation method suggested in the instruction manual, to ensure that familiar with the operation and maintenance of the vehicle and safe driving vehicles. We are not responsible for any loss caused by improper use of the vehicle.

2. Please be sure to carry out regular vehicle maintenance and maintenance in accordance with the provisions of the maintenance information form.

3. In order to adapt to drivers of different sizes, the driving position should be adjusted as follows:

- Seat forward and backward adjustment, height adjustment *, backrest inclination adjustment, headrest adjustment;Steering wheel position adjustment;

- Internal and external rearview mirror position adjustment.

4. Wearing safety belt is a necessary guarantee for the safety of drivers and passengers. Adults should wear seat belts correctly and children should correctly select and use child restraints and seat belts in accordance with the relevant requirements in this instruction manual.

Notes to users

- Whether the vehicle lamps work normally;
- Cleanliness of windscreen and rearview mirror, working condition of wiper;

- Rearview mirror view angle position;

- Tire pressure and tire wear. The condition of the tire has a direct impact on the vehicle's power, economy and comfort, more related to traffic safety, please correctly use and maintain the wheels (including spare wheels) according to the regulations. Check the tire pressure when the tire is cold.

- Engine oil, coolant, brake fluid and other liquid level height;

- Battery status.

6. Put the start/stop button in "RUN" mode to

check the alarm lights.

7. Engine operation:
●Do not run the engine in the closed warehouse for a long time to prevent exhaust poisoning;

- When the battery power failure, the engine electronic control unit and starter will not work properly, the engine cannot start

- When the engine is shut off, the vacuum booster device will not work, and the brake pedal trample force will be significantly increased, and the braking efficiency will be sharply reduced. Therefore, it is strictly prohibited for vehicles to slide when the engine is shut down

- For vehicles equipped with automatic transmission, stop the vehicle before leaving the vehicle, put the shift handle in the position of "N", apply parking brake and then put the shift handle in the position of "P". For vehicles equipped with manual transmission, stop the vehicle before leaving the vehicle, and then put the shift handle in neutral position and apply parking brake

●When braking in emergency or on wet road, ABS can prevent the wheels from locking, which is conducive to the stability of driving direction. However, careful and safe driving is still necessary

9. About the combined instrument alarm lamp:

●If, while driving on combination instrument have red alarm lamp (such as brake, engine oil, coolant

temperature, etc.) to light, should be safe parked car as soon as possible, according to this instruction manual instructions to check the vehicle, if necessary please contact BAIC shop of distribute of engage by special arrangement.

●If there is yellow alarm light on the combination instrument on the way, please check the vehicle according to the instructions in this operation manual. If necessary, please contact BAIC special dealership for maintenance

10. Electrical accessories

●Any electrical accessories must be connected in accordance with the specified wiring location and wiring methods, please go to BAIC dealership

11. The car is equipped with a catalytic converter. It is strictly prohibited to use leaded gasoline, otherwise the catalytic converter will be damaged soon

12. Safety tips

Follow the following important driving rules to help ensure the safety of drivers and passengers throughout the journey!

●Strictly abide by traffic rules and drive safely

●Do not drive after drinking or taking drugs;

●Observe the speed limit sign and do not exceed the speed limit

13. When the front windshield is coated internally, pay special attention not to let water into the instrument panel; Daily use vehicles don't take wet umbrellas, aside the water glass with the liquid on the dashboard, otherwise the water into the dashboard may lead to electrical components damage is installed on the dashboard

14. Please go to BAIC dealership for vehicle repair and modification. BAIC shop of distribute of engage by special arrangement with the necessary tools, diagnostic equipment, maintenance information and have the qualification of the staff.

General contents

| | |
|---|--------------------------------|
| 1 | Instructions on safe operation |
| 2 | Control systems and equipment |
| 3 | Driving guide |
| 4 | Maintenance and service |
| 5 | Emergency treatment |
| 6 | Technical data |
| 7 | Maintenance information |

1. Instructions on safe operation

| | |
|---|----|
| Driving safety..... | 2 |
| Correct Sitting Posture of Driver..... | 3 |
| Pedal area..... | 5 |
| Seat belt..... | 7 |
| Correctly fasten the seat belt..... | 10 |
| Seat belt inspection and maintenance..... | 13 |
| Maintenance and disposal of seat belt pretensioner *..... | 14 |
| Airbag system..... | 14 |
| Conditions under airbag fold..... | 22 |
| Conditions under airbag does not unfold..... | 23 |
| The collision at bottom of the vehicle..... | 26 |
| Safety of child..... | 27 |
| Child seat..... | 28 |

Driving safety

This chapter mainly introduces important information, operation essentials, Suggestions and safety precautions of safe driving. For the safety of drivers and passengers, please read carefully and observe relevant regulations

Caution

- Be sure to carry this instruction manual with you. If you lend or resell a vehicle, be sure to give the user manual to the user or new owner.

Keep the vehicle in safe driving c

Driving a faulty vehicle is very dangerous, in order to keep the vehicle in a safe driving state, the driver should follow the provisions of the "maintenance information table" and go to BAIC brand authorized service center for regular maintenance, and checking the cars before drive.

Correctly adjust the seat

Before driving, the driver and passenger should make the seat back upright and adjust the seat position.

Fasten the seat belt while driving

The airbag only has an auxiliary protection function and cannot replace the protective effect of the seat belt in an accident. Therefore, the driver and passengers must fasten the seat belts correctly during driving.

Properly place all the child passengers

The children should be properly placed in the two sides of the back seat, in case of the child is too young to fasten the seat belt, it must be properly placed in the child protection device, adjust the children lock in the LOCK state, and never leave children alone in the car.

Be alert to the danger of airbags

Although the airbag have protect function, but if the passengers is too close to the airbag or it is not properly protected, when the airbag open may cause injury to the driver and passenger, especially to the infant. Be sure to follow all instructions in this manual.

Do not drive after drunk

Do not drive after drunk because people's reaction to environment will be reduced after drinking, and also same for your friends.

Never overspeed

Overspeed is one of the main causes of vehicle collision and casualty accidents. Do not drive beyond the speed limit specified by the road, and do not exceed the safe speed allowed by the actual road conditions while driving.

Carrying pets safely

When carrying a pet in the car, make sure that the pet is properly fixed. Do not play with the pet while driving. Do not leave the pet alone in the car.

Warning

- Do not be distracted by external factors, such as smoking, eating, talking with passengers or talking on the phone.
- Do not drive a vehicle when the reaction capacity is declining. For example taking drugs, alcohol, and medicine which can prone to lethargy can reduce people's reaction capacity.
- Strictly abide by traffic regulations and speed limits
- When driving the vehicle, avoid crushing crop straw, weeds, etc., in case of hooking to the vicinity of the vehicle exhaust pipe, causing the vehicle to catch fire.

Correct Sitting Posture of Driver

Correct Sitting Posture of Driver

The driver sitting correctly can reduce driving fatigue and ensure the safety of the vehicle.



To ensure driving safety, the driver should be done before driving the following operations:

- move the seat to the appropriate location, make knee close section in the condition of slightly curved, fully oil under the door pedal, brake pedal and the clutch pedal dispatch back to the right Angle, and back to back.

- Adjust the headrest so that the middle of the headrest is flush with the middle of the driver's ear and keep the back side of the head as close as possible to the headrest.
- Adjust the steering wheel so that the chest and the steering wheel are at least 25 cm distance. Make sure the elbow is slightly bent and hold the highest point of the steering wheel.
- Adjust the mirror to the proper position.
- Fasten the seat belt in the correct way.

Front passenger correct sitting

In order to ensure the safe ride, the front row passenger should do the following:

- Adjust the seat as much as possible to maintain a proper distance between the front passenger and the dashboard so that the most effective safety is provided when the airbag is triggered.
- Adjust the seat back to fit the back. Adjust the headrest so that the middle of the headrest is aligned with the middle of the ear of the passenger in the front row, and the back of the head is as close to the headrest as possible.
- Correctly fasten the seat belt.
- Place your feet in the foot space in front of the front seat.

Warning

- In order to reduce the risk of accidents and injuries, the following must be strictly observed:
 - The distance between the driver's chest and the steering wheel should not be too close. Otherwise, the airbag cannot provide effective protection and may cause harm to the driver when deployed.
 - The hands of the driver should always be on the outer ring of the steering wheel (9 o'clock and 3 o'clock positions) to ensure that all instruments and indicators on the combined instrument can be seen.
 - When the vehicle is moving, the driver is not allowed to adjust the seat and the headrest. If need, should park the car and adjust the seat and headrest to the correct position, then continue to drive.

Warning

- The front passenger should not be too close to the instrument panel, otherwise the airbag will not be able to provide effective protection and may even cause injury to the front passenger when deployed.
- Do not rest your feet on the instrument panel or on the window during driving, also do not sit cross-legged on the seat, always keep the feet inside foot space, otherwise it will be easy to get hurt in case of emergency brake or accident.
- During driving, the seat back should not be tilted excessively. The seat belt must be properly worn to maintain the correct sitting position to avoid injury during emergency braking.

Back row passenger correct sitting

To ride safely, rear passengers should do the following:

- Adjust the headrest so that the middle of the headrest is aligned with the middle of the rear passenger's ear and the back of the head is as close as possible to the headrest
- Keep your seated posture as close as possible to the back of the seat
- Place your feet in the foot space in front of the rear seats and close to the floor
- Correctly fasten the seat belt.
- When carrying children, appropriate protective measures must be taken in accordance with relevant regulations.

Pedal area

M/T vehicle

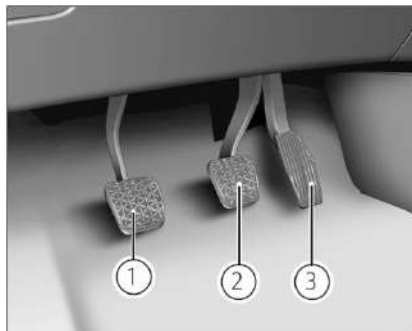

- ① Clutch pedal
- ② Brake pedal
- ③ Accelerator pedal

A/T vehicle*

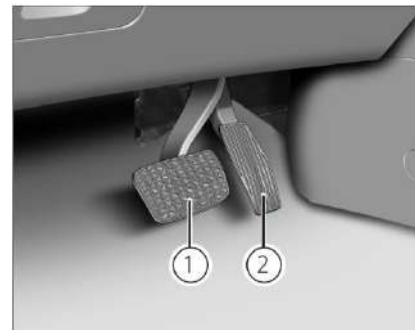

- ① Brake pedal
- ② Accelerator pedal

Caution

- Before driving, you must ensure that all pedals can be easily stepped on at any time and can automatically return to the position.

 **Caution**

● It is strictly prohibited to drive when fastening high heels and slippers. High heels may impede the brake pedal and the clutch pedal to be depressed to the end. Sliding may happen when depressing the brake pedal when fastening slippers. You cannot apply the maximum braking force in a timely manner, which easily leads to accidents.

Driver position foot mat

The foot mat should be fixed in the foot space. After installation, please make sure that the foot mat is close to the carpet, and ensure that there is a certain distance between the foot mat and the clutch pedal, brake pedal and accelerator pedal, so that there is no interference between the foot mat and the pedal.

 **Caution**

- When the brake pedal is pressed, if it is blocked by the foot mat and other things, it will affect the vehicle's brake and may cause serious traffic accidents.
- Do not put anything in the driver's foot space, otherwise it may slip into the pedal area and prevent the driver from operating the pedal. In case of emergency braking or sudden situation, the driver can easily cause serious accidents if he cannot operate the brake pedal.
- Must ensure that the foot mats are securely fastened to the floor
- Do not put any other foot mats or coverings on the vehicle foot mats to prevent less pedal movement distance and hindering the pedal movement
- Do not use more than 10mm thick mat

Seat belt

All seats in the car are equipped with three-point seat belts.

The height of the upper fulcrum on the front seat belt is adjustable. Some models' front seat belts have

pre-tightening force limiting function. For driving safety, all passengers must wear seat belts correctly.

Proper wearing of the seat belt can limit the passengers to the appropriate position, effectively preventing the passengers from colliding with the interior parts of the vehicle and absorbing a lot of kinetic energy, reducing the damage to the passengers.

At the same time, the correct wearing of the seat belt is also an important prerequisite for the protection of the airbag. At the moment of airbag deployment, the body position, sitting posture and movement of the driver and passenger have a greater impact on the protection effect of the airbag.

Improper wearing of the seat belt and abnormal seating posture may cause the vulnerable parts of the head and neck of the passenger to be injured

by the instantaneous impact force when the airbag is deployed. Especially for children, this kind of injury can be fatal. In the moment of crash, the seat belt can restrain the upper body of the driver and passenger in time, ensuring that the people inside the car is within the protection range after the airbag is deployed, make the airbag work most effectively.

Caution

In order to reduce the risk of accidents, the following matters must be strictly observed:

- As long as the vehicle is driving, the driver and passenger must always wear the seat belt. This will reduce the damage to the vehicle during emergency braking and traffic accidents.
- It is strictly forbidden to wear one seat belt for two person(even for children)
- Pregnant women or those who need care from others must also wear seat belts. If you do not wear a seat belt, you may be seriously injured.
- take off the heavy clothe (such as big coat) before wearing the seat belt, in order to avoid seat belt not fit the

Caution

- When wearing the seat belt, it should not be pressed against fragile or sharp things (such as glasses, pens, etc.), otherwise the passengers may be injured.
- Make sure that the buckle socket is not stuck by other things, otherwise the lock cannot be inserted into the buckle
- The locking of the seat belt must be correctly inserted into the buckle. Wrong wearing of the seat belt will affect the protection of the seat belt.
- Seat belts must be kept clean at all times, and heavily soiled seat belts may cause the retractor rolling not smooth.
- If the belt webbing is broken or cracked, the fixing bolts are loose, and the retractor malfunctions, the seat belt will not provide protection in the event of an accident. You should regularly check all parts of the seat

Caution

- In the event of a serious crash, the used seat belt or the stretched seat belt should be replaced at BAIC Service Center. Even if there is no obvious deformation in the appearance, it needs to be replaced. Also check the seat belt fixtures.
- It is strictly forbidden to repair, disassemble and install the parts on the retractor or the seat belt. It is strictly forbidden to modify the seat belt in any way. Please repair the seat belt parts at BAIC service center.

Seat belt height adjustment



Use the seat belt height adjustment device to adjust the height of the fulcrum on the seat belt to accommodate the shoulder height of different driver and passenger.

1. Hold the lower end of the regulator guide block 1.
2. Press the upper end lock button of the guide block and hold it.
3. Move the guide block up and down to adjust the seat belt to the proper position.
4. Loosen the regulator guide block.

5. After the height adjustment is completed, pull the seat belt firmly and check that the adjuster is securely locked.

 **Warning**

- The driver is forbidden to adjust the seat belt height while driving.

Seat belt pre-tightening force limiting function

Some models' seat belts are equipped with pretightening force limiting devices, which aimed to ensure that the seat belt fastens the passenger's while crash.

When the severity of the crash accident reaches a certain level, the pre-tightening force limiting device may be activated, and the retractor tightens the seat belt in the rewinding direction to slow the passenger's forward motion.

If the tightening force exceeds a certain limit, the force limiting device will release the seat belt and reduce the force acting on the body.

When the pre-tightening force-limiting device is triggered, white smoke may be emitted. This is a normal phenomenon. It does not mean that the car has a fire, so don't worry.

 **Caution**

- The seat belt with pre-tightening function can only be used once. A new seat belt must be replaced after the pretensioner is detonated.
- When the pre-tightening force-limiting device is triggered, white smoke may be emitted. This is a normal phenomenon. It does not mean that the car has a fire, so don't worry.
- The seat belt pretensioner will become very hot after the detonation, so do not touch the relevant parts within a few minutes after the pretensioner is detonated.

The consequences of not wearing the seat belt

Many people think that in the event of a mild crash, you can use your own hands to support the body and will be without injury, it is absolutely wrong.

Driver and passengers who are not wearing seat belts will move forward at the speed before the crash due to inertia. At this time, the vehicle does not move at the same speed as the driver and passenger, which may cause injury to the driver and passenger.



Even if the speed of the car is very low, the force acting on the human body in the event of a frontal crash is great. The passengers cannot support his body only using hands, and the people who are not wearing the seat belt will be forcefully thrown forward. Hit the steering wheel, the dashboard, the windshield, or any things on the way forward.

Correctly fasten the seat belt

How to Wear a Front Seat Belt



Before using the seat belt, first adjust the front, rear, height and backrest angle of the front seats to the proper position.

The upper part of the seat belt is close to the front chest and over the shoulder.

The lower part of the seat belt is close to the hip and should not be applied to the abdomen. If the seat belt is not used correctly, it not only cannot provide protection, but also may cause other serious injuries

Warning

- Do not wrap the seat belt when using the seat belt. When the seat belt is wrapped around the body, it will increase the pressure on the body of the seat belt and reduce the protection of the seat belt.
- Seat belts should be tightened as much as possible without affecting comfort, which can provide better protection. The seat belt is not fastened and will greatly reduce the protection.

Seat belt lock

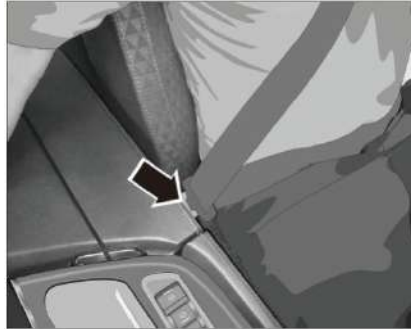

Slowly pull the seat belt out of the retractor, then insert the locking bolt into the buckle until you hear the “click” buckle, then pull back the seat belt to confirm the reliable lock.

Seat belt adjustment



Gently pull the seat belt to adjust the length of the seat belt, and adjust it to a comfortable position as required. First, lower the lower part of the seat belt as far as possible, across the hips, and then lift the upper part of the seat belt upwards so that the lower part of the seat belt is in close contact with the body. In this way, the body's strong pelvic area can withstand greater impact, thereby reducing the chance of internal injuries to the abdomen

Seat Belt Unfastened

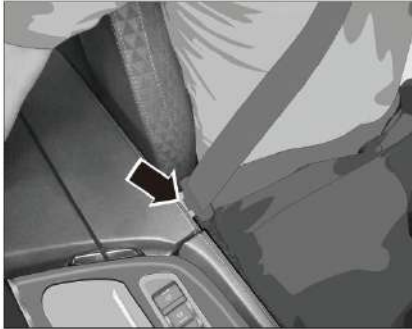

Press the red button beside the buckle of the seat belt, and the latch will automatically eject. Hold the seat belt, then return it and the tensioner will automatically retract it.

Wear the Rear Seat Belt

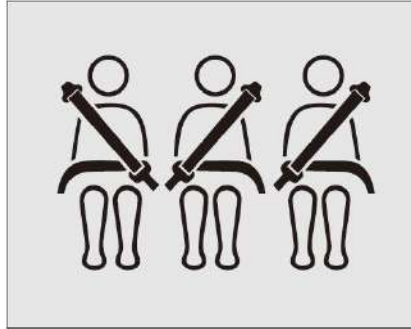

The rear seat belts are worn in the same way as the front seat belts

Pregnant woman wears seat belt



If the driver is pregnant, to protect the safety of the pregnant woman and the fetus, the belt should be passed evenly through the chest and in front of the hip as low as possible, and then flattened so that the lower abdomen is not under pressure

Children wearing seat belts

The seat belts for this model are designed for adults. It is recommended that children 12 years of age and younger and children up to 1.5 m in height use specially fitted child restraints

Seat belt inspection and maintenance

Seat belt reliability check

The seat belt retractor will lock the seat belt slip when the following three conditions are encountered

When the seat belt is quickly pulled out of the retractor; when the vehicle is decelerating rapidly;

When the seat belt retractor is tilted at a large angle.

In order to check the reliability of the seat belt, grasp the upper part of the seat belt and pull it quickly. At this time, the retractor should lock the seat belt. If the retractor cannot lock the seat belt, please go to the BAIC Dealer for inspection or repair.

Seat belt maintenance

Regularly check that the seat belt and all its components (such as buckles, bolts, retractors, webbing and seat belt height adjustments) are working properly. If the seat belt part is found to be damaged, the webbing is cracked or otherwise damaged, replace the entire seat belt assembly.

Maintenance and disposal of seat belt pretensioner *

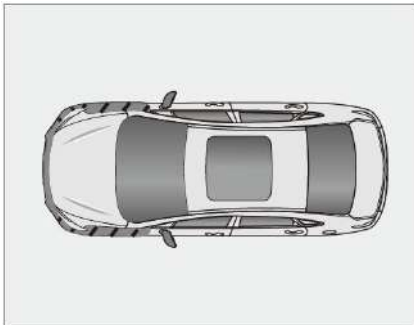

Please go to authorized BAIC Dealer as soon as possible when the following conditions:

An accident occurred in the front of the vehicle (shaded in the picture, but the seat belt pretensioner did not work.

An accident occurred in the front of the vehicle (shaded in the picture, but the seat belt pretensioner did not work.

When performing any work on the belt retractor with pre-tensioning device, please carry it out by BAIC authorized Dealer.

Otherwise, the pre-tensioning device may not work properly in the event of an accident.

When you need to scrap the pretensioner, you must abide by the relevant safety regulations. The BAIC authorized Dealer is familiar with the relevant safety regulations and can provide you with inquiries.

Warning

- If the seat belt retractor is repaired by a repair shop or non-professional authorized by BAIC, or if the seat belt retractor is not used properly, the potential risk of accidents will be increased.
- It is not permissible to repair, disassemble or install the seat belt or seat belt retractor parts by yourself.

Airbag system

The airbag system serves as an auxiliary protection. In order to fully protect the triggered airbag system, the driver and passenger must maintain a correct sitting position and the child must be protected by a suitable child seat.

Caution

- Dust generated during the deployment of the airbag can irritate the skin and eyes, and may cause some people to become asthmatic. In the event of an accident, the airbag is deployed and thoroughly clean all exposed skin with water and warm soap.
- After the airbag is deployed, the components of the airbag system will be hot and should not be touched to avoid burns.

 **Warning**

- The airbag only has an auxiliary protection function and cannot replace the protective effect of the seat belt in an accident.

Active airbags



When a serious collision occurs in the vehicle, the airbag system quickly opens one or more gas-filled air cushions between the person and the vehicle body to reduce the collision damage of the driver and passenger.

When a serious collision occurs in the vehicle, the airbag system quickly opens one or more gas-filled air cushions between the person and the vehicle body to reduce the collision damage of the driver and passenger.

In the event of a serious collision, the occupants who are not wearing the seat belt cannot control themselves and will move randomly or be thrown out of the vehicle. Even if the airbag is rapidly inflated, it cannot effectively protect the human body. The position of the occupant in the normal sitting position must be at an appropriate distance from the forward airbag in the front row, so that the airbag can be fully inflated when triggered, effectively protecting the occupants.

 **Caution**

- In the event of a collision of the vehicle, the decisive factor whether the airbag is triggered is related to the magnitude of the collision energy, the type of collision, the collision angle, the obstacle and the speed of the vehicle when the vehicle collides. Therefore, it is possible that the airbag does not trigger even if the vehicle is severely damaged.

Airbag working conditions

Airbag working Conditions Start, when the start/stop button is in RUN mode; On the cluster instrument, the airbag system fault warning light must be in a normal state (normal state: after starting the vehicle, the alarm light is turned off after a few seconds, and is extinguished in normal use). If there is no water immersion in the passenger compartment of the vehicle, if the vehicle is immersed in water, the airbag controller may be short-circuited and the airbag system may not work properly.

Airbag System Fault Warning Light



The airbag system fault warning light on the instrument cluster will remind you any fault in the airbag system.

When the ignition switch is at the “ON” position or when the Start/ Stop button is in the “Run” mode, the warning light will go off after being lit for several seconds when the system performs self-detection.

If the following symptoms occur, it shows that the system is faulty and the airbag and seat belt pre-tensioner may not work normally in a collision. In such a case, you must go to an authorized BAIC dealership to arrange a check:

- When the ignition switch is at the “ON” position or when the Start/Stop button is in the “Run” mode, the airbag fault warning light is not lit.
- When the ignition switch is at the “ON” position or when the Start/ Stop button is in the “Run” mode, the warning light is on for long time
- While the vehicle is running, the airbag fault warning light is lit.

Airbag Repair, Maintenance and

Components of the airbag system are mounted in different positions around the car.

All operations of the airbag system or operations that require the dismantling of airbag system components to allow the repair of other vehicle components must be performed by professional persons. Otherwise, the airbag system may be damaged. As a result, in the event of an accident, the system may abnormally trigger the airbag or fail to trigger the airbag at all.

If the vehicle is scrapped, the unexpanded airbag is potentially dangerous, so when the vehicle is scrapped, the airbag must be safely detonated by a professional.

Warning

- Do not use solvent-based cleaning agents when cleaning the steering wheel or instrument panel. Otherwise, the surface materials of these parts may be embrittled. Once the airbag is triggered, the broken plastic may seriously injure the driver and passenger.
- Do not attempt to repair, disassemble or install the components of the airbag system by yourself. If the airbag system is repaired by non-professional personnel, the potential risk of accidents will be increased. The airbag system is not properly repaired, and in the event of an accident, the airbag may not deploy or unfold when it should not be deployed
- Do NOT try to refit the front bumper or any of the vehicle body structure on your own.
- The airbag can only be triggered once, and the entire airbag system component must be replaced after the trigger.

Front Airbags



The driver's forward airbag ① is located in the dashboard above the middle of the steering wheel. The occupant's forward airbag ② is located in the glove box.

The forward airbag inflates when the vehicle is hit by a frontal violent impact, and may also inflate due to a similar impact (such as hitting a gully on the road). It may also not inflate during some frontal collisions (such as when the front of the vehicle hits a trunk or a thin column of wire rods).

The degree of damage to the vehicle is not a sufficient condition for inflation of the forward airbag.

Caution

- The expansion and contraction of the forward airbag is completed in a short period of time and can only be used once and does not protect against a second impact that may occur subsequently.

Please contact BAIC Dealer as soon as possible if:

- The front airbag has been deployed
- collision occurred in the front of the vehicle, but the forward airbag did not deploy.
- The upper part of the airbag (arrow position in the figure) is broken or has other damage.

The airbag is provided with a venting hole. When an accident occurs, the airbag is inflated and inflated in an instant. After the airbag is fully deployed, the airbag begins to deflate, thereby reducing the impact damage of the driver's head, chest and other parts of the body. It also enables the driver to maintain a forward view and perform steering or other operations. When the airbag is deployed, it makes a loud noise, and then a small amount of smoke is generated, which is normal.

Seating Position

To ensure the best protective function, during serious impacts, the front airbags must unfold within a certain period of time. If the vehicle occupants are too close to the front airbag, the expanding and deploying front airbag may bruise the face or injure other parts of the body.

Front side Airbags



The side airbag ③ is located in the backrest lining of the front seat door side

Warning

- It is forbidden for the driver and the front occupant to lean their head or body against the door, or to place their arms on the door or out of the window, otherwise it will cause injury when the side airbag is deployed.
- It is forbidden to place anything between the driver, the front passenger and the door. Otherwise, it will hinder the deployment of the side airbag and affect its protection.
- It is forbidden to use the seat cover to wrap the seat side airbag, otherwise it will hinder the deployment of the side airbag.

In a lateral collision of the vehicle, the lateral airbag determines whether the airbag is deployed according to the strength of the lateral collision, the impact angle, the speed, and the impact point. In some side collisions, the lateral airbag may also not deploy. The degree of damage to the vehicle is not a sufficient condition for inflation of the side airbag.

In some collisions, the side airbag does not deploy, and if you do not wear a seat belt, it will cause personal injury. The airbag system is only optimally protected by the correct wearing of the seat belt, so all drivers must always wear the seat belt correctly

Caution

- Side airbags are not intended for front and rear impacts and slight side impacts, nor for vehicle overturning, and do not work when the vehicle is braking or driving on bumpy roads or passing through the ground

Caution

- Lateral airbags may not inflate when the engine compartment and luggage compartment of the vehicle are subjected to strong side impacts.

Please contact BAIC Dealer as soon as possible if:

- Any of the side airbags has been deployed.
- There is an accident at the vehicle door position, but the side airbag fails to unfold.
- The surface of the seat with a side airbag has been scratched, broken or has other types of damage.

Seating Position

In order to provide optimum protection under severe side impact, the side airbags will deploy in a very short time. If the occupant is too close to the side airbag, the inflated side airbag may cause abrasions to the occupants, so keep the correct sitting position

*Side Curtain Airbags



Side curtain airbags ④ are located at the side members of the roof. The word "AIRBAG" is marked on the B and C columns

In the event of a side collision of the vehicle, the system may trigger a side curtain airbag on the collision side of the vehicle.

Once triggered, the gas generated by the gas generator will quickly fill the side curtain airbag. The side curtain airbag is rapidly inflated and deployed to cover the side windows and the door post to protect the human head.

To provide the desired additional protection in an accident, the side curtain airbag will expand rapidly in an instant. It is normal for a small amount of smoke to be released when the curtain is inflated.



The side of the vehicle, the gasfilled side curtain airbag can effectively reduce the risk of injury to the occupant's head and upper body.

When a certain side collision occurs in the vehicle, the side curtain airbag deployment depends on factors such as the strength of the collision, the impact angle, the speed, and the impact point. Lateral curtain airbags are not deployed in all side impact accidents and do not deploy in frontal collisions, rear impacts or most rollover accidents.

When there is some collision in the vehicle, the front airbag, the side curtain airbag, and the front seat side airbag may be deployed at the same time

Caution

- In order to ensure that the side curtain airbag can be normally inflated and deployed, there should be no obstruction between the side curtain airbag and the occupant
- | The expansion and contraction of the side curtain airbag is completed in a short period of time and can only be operated once and does not protect against the second side impact that may occur subsequently.

Warning

- Side curtain airbags provide additional protection only in the event of severe side impacts and are not a substitute for seat belt protection.
- It is forbidden for the occupant to lean his head or body against the door, or put his or her arm on the door or out of the window, otherwise it will cause injury when the side curtain airbag is deployed

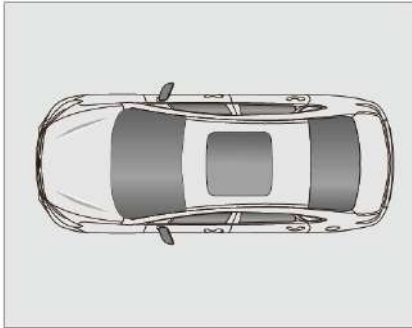

Please contact BAIC Dealer as soon as possible if:

- Any of the air curtains has unfolded
- A collision occurred in the side wall of the vehicle (shaded in the figure), but the side curtain airbag was not deployed
- The side curtain airbag exterior trim panel is cracked or otherwise damaged

Seating Position

In order to provide optimum protection against severe impact, the side curtain airbag must be deployed in a very short time. If the occupant is too close to the side curtain airbag, the inflated side curtain airbag will cause head injury or other damage, so please maintain the correct sitting position.

Conditions under airbag fold

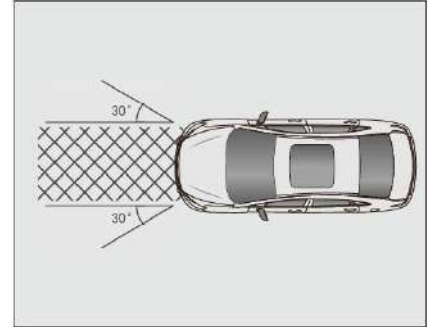

If the impact is received in the direction of about 30° or so in front of the vehicle and the degree exceeds the set critical level, the front airbag may be deployed.

Installing other guards in front of the vehicle, the sensor will not be able to sense the impact normally, will hinder the normal operation of the forward airbag.

The side airbag may deploy if the side of the vehicle is impacted and the extent exceeds the set critical level.

Warning

- Be sure to wear the seat belt correctly. Otherwise, in the event of an accident, the deployment of the airbag may cause an impact on the occupant, resulting in serious injury or even death of the occupant

Conditions under airbag does not unfold

The airbag provides protection to the occupants during a collision. In a collision accident, the airbag determines whether the airbag is deployed based on the strength of the collision, the angle of impact, the speed, and the point of impact

In many types of crashes, such as rear-end collisions, diagonal collisions, rollover accidents, and frontal collisions with thinner columns, the airbag may not deploy.

Rear-end collision

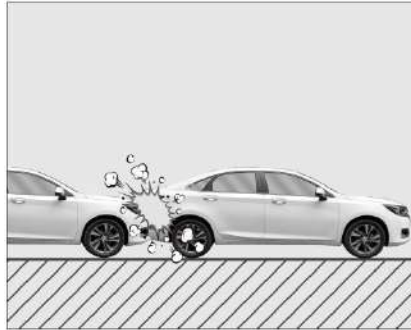

When a rear-end collision or collision occurs, the occupant moves in the direction of the backrest under the action of inertial force. The airbag deployed from the front does not play any protective effect on the occupants. At this time, the forward airbag may not be deployed, and the side direction may not be deployed. The airbag and the side curtain airbag do not work.

Side collision

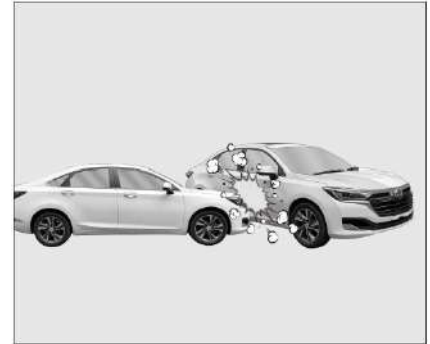

In the event of a side collision, the occupant has a lateral displacement, so the airbag deployed from the front does not protect the occupants. At this time, the front airbag may not be deployed, and the side airbag and the side curtain airbag may be deployed.

Slanted Collision (oblique collision)

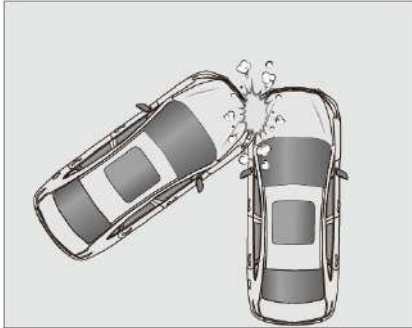

When a diagonal collision occurs, the impact energy received by the airbag system may not be sufficient to trigger the forward airbag deployment. At this time, the forward airbag may not be deployed, and the lateral airbag and the side curtain airbag do not work.

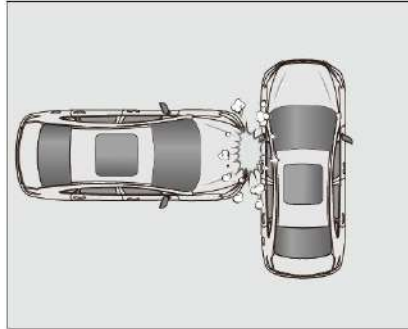

When the side other than the passenger compartment is hit, the vehicle body is weakly collided, and the forward airbag, the side airbag, and the side curtain airbag do not work.

Rear collision



In the event of a rear-end collision with a large truck, the driver instinctively performs an emergency braking, at which time the front of the vehicle body sinks. Due to the high ground clearance of large trucks, the front part of the vehicle will be drilled to the bottom of the truck. The collapse deformation of the front part of the vehicle will absorb the impact energy, so that the collision speed detected by the airbag sensor is not large. At this time, the front airbag may not be deployed. Side airbags, side curtain airbags are not working.

Slanted Collision (oblique collision)

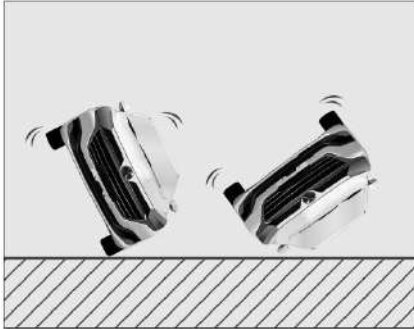

In the case of a rollover accident, the airbag may not be deployed, and the passenger may not be protected if the airbag is accidentally deployed

Special Collisions

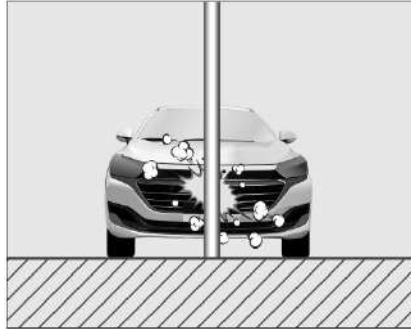

If the vehicle collides with some finer objects such as poles or trees, in which the collision points are concentrated in one place and the impact energy is quickly absorbed by the vehicle's severe deformation, and the entire collision force is not transmitted to the airbag sensor. The airbag may not be deployed at this time.

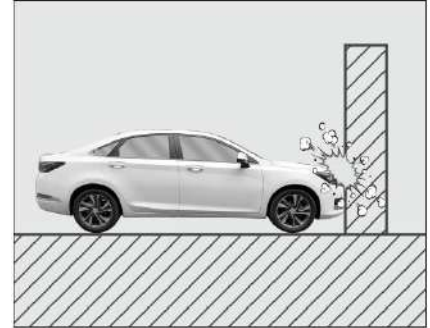

When the front side of the vehicle hits a wall, the body is weakly collided, but the collision strength does not reach the airbag deployment condition, the forward airbag will not expand, and the side airbag and the side curtain airbag do not work.

The collision at bottom of the vehicle

If the vehicle is subjected to severe impact such as flying over a step, impacting a shoulder or a hard object, or crossing a deep pit, even if the deformation of the vehicle is slight, the vehicle component is affected by the rigidity, and the detected deceleration reaches the airbag deployment condition. The airbag may also unfold

Impact on road shoulder or hard object



Vehicle crossing the pit



The vehicle falls or flies over the stairs



Safety of child

⚠ Warnings

- Do not allow children to stand or kneel on the seats.
- During vehicle traveling, never let the children enter into the trunk. In the event of an accident or emergency braking, the children may suffer serious injury.
- As the driver, you shall be liable for the safety of children on board. Do not distract driver's attention by the child while driving.
- Never leave children alone in the vehicle. Otherwise, fatal injuries may happen due to suffocation.
- Child needs adult supervision to ride a vehicle. Please select the appropriate child restraint device according to the body of child.

When several children are taken

ISOFIX child safety seat fixtures are provided on both sides of the rear seats, which can be used to fix 2 groups of ISOFIX child safety seat.

If the children have grown up and are suitable for fastening seat belt, just arrange the oldest child to sit on front passenger seat:

- Move the front passenger seat to the rear as far as possible.
- Let the child sit up straight against the seat backrest.
- Reduce the height of the seat belt, and fasten seat belt correctly.



Never hold infant in arms when traveling. Otherwise, injury or death of children may occur in the event of an accident.

The statistics of accident reveals that: a child sitting on rear seat is safer than sitting on front seat.

It is recommended that children less than 1.5 should sit in the rear seats. And select appropriate child seats according to age, height, and weight, or ensure the safety of children on the rear seats depending on the existing seat belts.

Child seat

You are advised to keep the operation instructions of child seat together with these Operation Instructions.

Warnings

- If there is no child protection device, child at the age of 12 years old or below, or child's height 1.5m or less, shall not use the seat belt only. Otherwise, it may result in children stomach and neck injuries during an emergency braking or an accident.
- One child seat can only be used for a child.
- A seat belt can only be used for one person, and it is not allowed to let two children share a seat belt.
- Never let child sit on an adult's lap, and it is extremely dangerous for children if two persons share a seat belt.

Note

- Installation and use of child seats should observe traffic regulations and the child seat manufacturer's instructions.



It is prohibited to install a rearward child seat on the front seat. Otherwise, the airbag will impact the child seat backrest with tremendous force when it expands, resulting in serious injury or even death of children.



There is a warning sign on the sun visor for front passenger, which reminds you to correctly install the child seat. Please read and comply with the instructions given on such nameplates.

Don't use any backward-facing child restriction system on the seat which is protected by frontal airbag (in activated state)!

Classification of child seat(for reference only)

Child seat of grade 0/0+:



For infants less than 18 months of age and weighing less than 13 kg, it is best to use grade 0/0+ child seat which can be adjusted to a lying position.

Child seat of grade I :



For a baby or young child less than 4 years old weighing 9 kg to 18kg, it is best to select the grade I child seat equipped with seat belt.

Child seat of grade II :



For children less than 7 years of age, weighing 15kg to 25kg, it is best to use the grade II child seat together with the three-point seat belt.

Child seat of grade III :



For children over 7 years old, weighing 22kg to 36kg, height below 1.50m, it is best to use the grade III child seat together with the three-point seat belt.

Tips

- For a child whose height is higher than 1.50m, please use the seat belt on vehicle rather than child seat.

Warnings

- The upper portion of seat belt shall pass the center of shoulder rather than neck, and shall closely press against the body.
- The lower portion of seat belt shall pass the hip rather than abdomen, and closely press against the body. If necessary, just adjust the seat belt.

Correct installation of child seat

The front seat must be adjusted to appropriate position according to the side of the child seat and the child before installing the child seat onto the rear seat. In the event of a collision or emergency braking, a child sitting on the rear seat is less likely injured by a hard object, and the child sitting on the rear seat will not be injured due to expansion of the airbag.

ISOFIX child safety seat fixing device

The rear two seats on both sides are equipped with a set of ISOFIX child safety seat fixing device, each device includes 2 lower fixing anchors and 1 upper anchor.

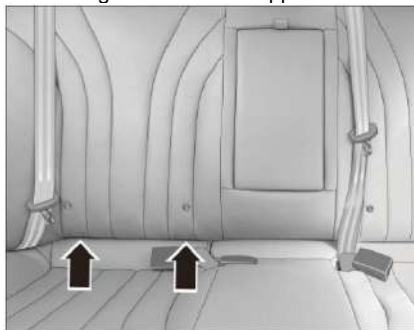

The lower fixing anchors are located in the gap between the seat backrest and the seat cushion below "ISOFIX" sign, and you can only touch them by pulling open the backrest and seat cushion. Please install a child seat in accordance with the instructions offered by the manufacturers.



upper fixing anchor is located ON the part of the seat (with prompt of  in the position).

Note

- The "ISOFIX" upper fixing anchor behind the rear seat backrest can only be used to fix "ISOFIX" child safety seat.
- The upper and lower child safety seat fixing anchors can only support the load of the child safety seat. In any case, it is prohibited to fix other items and equipment with it.

ISOFIX fixing position corresponding to a ISOFIX child seat

| Quality team | Size category | Fixed module | Fixing position | | |
|--------------------|---------------|--------------|-------------------------------------|--------------------------|------------------|
| | | | Seat for passenger in the front row | Rear seats on both sides | Rear middle seat |
| Portable bed | F | ISO/L1 | X | IL** | X |
| | G | ISO/L2 | X | IL** | X |
| Group 0: < 10kg | E | ISO/R1 | X | IL* | X |
| Group 0+: < 13kg | E | ISO/R1 | X | IL* | X |
| | D | ISO/R2 | X | IL* | X |
| | C | ISO/R3 | X | IL* | X |
| Group I : 9-18kg | D | ISO/R2 | X | IL* | X |
| | C | ISO/R3 | X | IL* | X |
| | B | ISO/F2 | X | IUF | X |
| | B1 | ISO/F2X | X | IL* | X |
| | A | ISO/F3 | X | IUF | X |
| Group II: 15-25kg | | | X | | X |
| Group III: 22-36kg | | | X | | X |

Note: meaning of letters filled in the table: IUF- suitable for universal "forward facing" ISOFIX child seat fixed with drawstrings in this quality group class.

IL - suitable for semi-universal ISOFIX child seat installed in one of the following methods.

- Fixed "Rearward facing" with up pulling string or support legs;
- Fixed "Forward facing" with support legs;
- Infant seat fixed with up pulling string or support legs.

X- Not suitable for installation of indicated children weight child seat or infant seat.

*: You should be careful to install a child seat with support legs, and see the child seat manufacturer's installation instructions. **: Infant seat fixed with the two lower fixing rings of the ISOFIX be fixed, taking two rear seats.

Safety label



The location of the safety sign is shown in the figure:

- Airbag warning label is on the front and back surface of the front passenger sun visor;
- Cooling fan warning label is on the right side of the engine compartment upper front beam;

These labels are used to alert potential hazards likely to cause serious injury. Please carefully read these signs. If the labels are removed or blurred, please go to the BAIC Dealer for replacement. 38

2. Control systems and equipment

| | |
|--|-----|
| Instrument and control mechanism arrangement (model with AT) | 36 |
| Instrument and control mechanism arrangement (models with MT)..... | 38 |
| Combination instrument (7 inches)..... | 40 |
| Driving computer screen (7 inches)*..... | 42 |
| Indicator light and alarm light of combination instrument (7 inches)*..... | 49 |
| Combination instrument (full LCD)..... | 51 |
| Instrument display (full LCD)*..... | 53 |
| Indicator light and alarm light of combination instrument (full LCD)..... | 59 |
| Indicator light and alarm light of combination instrument (full LCD)*..... | 60 |
| Steering wheel..... | 67 |
| Remote Key..... | 69 |
| Central door lock system..... | 78 |
| Engine hood..... | 501 |
| Trunk..... | 82 |
| Fuel filler..... | 85 |
| Power window..... | 86 |
| Light combination switch..... | 92 |
| Light control..... | 92 |

| | |
|--|-----|
| Interior light..... | 99 |
| Wiper combination switch..... | 101 |
| Interior rearview mirror..... | 103 |
| Exterior rear-view mirror..... | 104 |
| Sun visor..... | 107 |
| Seat..... | 108 |
| Storage device..... | 111 |
| Air conditioning system..... | 116 |
| Air conditioning control panel..... | 117 |
| Navigation and multimedia audio system..... | 123 |
| Speed Sensing Sound Compensation System..... | 123 |
| Digital Video Recorder *..... | 123 |
| Intelligent Vehicle System *..... | 128 |
| Diagnostic interface..... | 129 |
| Microwave window..... | 129 |
| Accessories and retrofitting..... | 130 |

Instrument and control mechanism arrangement (model with AT)



1. Tweeter
2. Side windshield defrosting/defogging air outlet
3. A/C vent
4. Light combination switch
5. Steering wheel multi-function button
6. Instrument cluster
7. Wiper and washer combination switch
8. Multimedia display
9. Hazard warning light switch
10. Glove box
11. Front passenger frontal airbag
12. Interior rearview mirror

Instrument and control mechanism arrangement (model with AT)



- 13. Gearshift lever*
- 14. Air conditioning control panel
- 15. Storage slot
- 16. Electronic parking brake switch
- 17. Accelerator pedal
- 18. Keyless start/stop button*
- 19. Brake Pedal:
- 20. Steering wheel adjustment lock handle
- 21. Driver's frontal airbag
- 22. Hood opening handle
- 23. Multifunction switch panel (headlight height adjustment knob*, and backlight brightness adjustment switch, etc.

Instrument and control mechanism arrangement (models with MT)



1. Tweeter
2. Side windshield defrosting/defogging air outlet
3. A/C vent
4. Light combination switch
5. Steering wheel multifunction button
6. Instrument cluster
7. Wiper and washer combination switch
8. Multimedia Control Panel
9. Hazard warning light switch
10. Glove box
11. Front passenger frontal airbag
12. Interior rearview mirror

Instrument and control mechanism arrangement (models with MT)



- 13. Gearshift lever
- 14. Air conditioning control panel
- 15. 12V power supply
- 16. Electronic parking brake switch
- 17. Accelerator pedal
- 18. Start / Stop button
- 19. Brake Pedal:
- 20. Clutch pedal
- 21. Steering wheel adjustment lock handle
- 22. Driver forward airbag
- 23. Hood opening handle
- 24. Multifunction switch panel
(headlight height adjustment knob*, and
backlight brightness adjustment switch, etc.

Engine coolant temperature

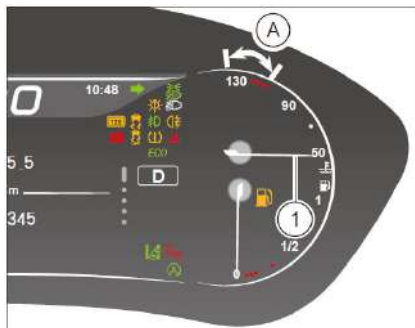

This gauge indicates the temperature of the engine coolant. During normal driving, the pointer ① should indicate near the middle position.

If the pointer ① indicates entering the red scale A area, indicating that the coolant temperature is too high, which may cause serious damage to the engine, stop the engine immediately for inspection or help if the safety conditions permit.

If the corresponding scale enters the red scale A area several times, stop the engine at the proper position as soon as possible and turn off the engine, and check the coolant level.

Engine

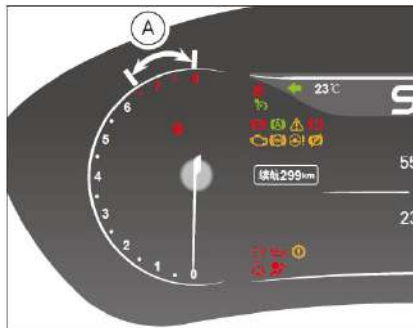

The tachometer indicates the number of engine revolutions per minute (x1000rpm). The tachometer can also assist in evaluating engine performance.

Danger

- To prevent damage to the engine, do not allow the speed to stay in the red area-A for a long time.

Speedometer



The speedometer shows the vehicle's real-time speed in km / h.

Warning

- When the vehicle is driving, observe the speedometer from time to time, and do not overspeed.

Note

- Shifting into high gear in time will help save fuel and reduce engine noise.

Fuel gauge



The fuel gauge ① shows the amount of fuel remaining in the fuel tank. When braking, accelerating, turning or driving on a ramp, the fuel in the fuel tank will shake, which will affect the accuracy of the fuel gauge display.

The vehicle should be placed on a flat surface to check the fuel quantity. When the fuel is insufficient, the fuel gauge pointer points to the red area, and the fuel shortage alarm light is on.

Warning

- Do not run out of fuel to the tank. Irregular fuel supply may lead to abnormal engine ignition, unburned fuel entering the exhaust device and damaging the catalytic converter!

Driving computer screen (7 inches)*





The contents of the trip computer display screen include: alarm information, trip information and instrument functions. The instrument operation button on the left side of the steering wheel, can view the driving information, menu and instrument function settings.

Instrument operation Button





Confirm Button: press the paddle

①; Return key 

Upturn:  Move the paddle upward①);



Down:  (Move the paddle down①) :

Left turn: 

Right turn: 

Travel information



When the keyless start / stop button is in the "run" mode, in the travel information interface, Can view the travel information cycle by short press.  /  KEY The information that can be viewed includes: mileage, fuel consumption since starting, resetting and refueling.

Mileage



The mileage interface shows two kinds of information: total mileage and subtotal mileage.

The total mileage is the total mileage of the vehicle, with the display range of 0-99999999km;

The subtotal mileage can accumulate the driving mileage in a certain section. Display range: 0.0 ~ 9999.9km;

Clearing method of subtotal mileage:

1. In the display interface, short press the confirm key to enter the reset interface, or long press the confirm key to directly reset;
2. The subtotal mileage reaches the maximum of 9999.9km;
3. Disconnect the battery.



After start, the interface shows four kinds of information: the subtotal mileage, the average fuel consumption, the driving time and the average speed.

The subtotal mileage can accumulate the driving mileage in a certain section. Display range: 0.0 ~ 9999.9km;

Average fuel consumption is the average fuel consumption of the sub total mileage.

Start counting time since start / stop key is in run mode. The maximum displayed time is 99:59. Average vehicle speed is the value that driving distance divided by driving time

Reset mode:

1. In the display interface, short press the confirm key to enter the reset page, or long press the confirm key to clear directly;
2. The start / stop button is in "off" mode for more than 2 hours;
3. The subtotal mileage reaches the maximum of 9999.9km;
4. Disconnect the battery. During resetting, the subtotal mileage / average fuel consumption will be cleared at the same time.

Since last Reset



This interface shows four kinds of information from last reset till now, including subtotal mileage, average fuel consumption, driving time and average vehicle speed. Subtotal mileage can be accumulated for driving in a certain section

Mileage. Display range: 0.0 ~ 9999.9km;
Average fuel consumption is the average fuel consumption of the sub total mileage.
Driving time is the accumulated time of this driving.

Start counting time when start / stop key is in run mode. The maximum displayed time is 99:59.

Average vehicle speed is the value of driving distance divided by driving time in driving time.

Reset mode:

1. In the display interface, short press the confirm key to enter the reset page, or long press the confirm key to clear directly;
2. The subtotal mileage reaches the maximum of 9999.9km;
3. Disconnect the battery.

When reset, the subtotal mileage / average fuel consumption will be cleared at the same time.

Since last Refuel



This interface shows four kinds of information: the subtotal mileage, the average fuel consumption, the driving time and the average vehicle speed.

The subtotal mileage is the accumulated mileage after last refueling.

Display range: 0.0 ~ 9999.9km;

The average fuel consumption is the average fuel consumption of the mileage after this refueling.

The driving time is the cumulative time of driving after refueling. The start / stop button starts timing when it is in "run" mode. The maximum value displayed is 99:59.

Average vehicle speed is the value of driving distance divided by driving time in driving time.

Reset mode:

1. It is detected that the change of oil quantity is greater than 6L (it shall be ensured that the oil quantity is greater than 6L at one time);

2. The subtotal mileage reaches the maximum of 9999.9km;

3. Disconnect the battery.

When clearing, the subtotal mileage / average fuel consumption will be cleared at the same time.

Fuel consumption

The fuel consumption interface displays three kinds of information: average fuel consumption, instantaneous fuel consumption and endurance mileage. The average fuel consumption shows the fuel consumption per unit mileage of the vehicle, in L / 100km. The average fuel consumption value displayed from the last reset to the time of view.

Instantaneous fuel consumption indicates the magnitude of transient fuel consumption, which can help users adjust driving habits to achieve the desired fuel consumption. The driving time is the accumulated time of this driving. The start / stop button starts timing when it is in "run" mode. The maximum value displayed is 99:59.

Reset mode:



1. In the display interface, short press the confirm key to enter the reset page, or long press the confirm key to clear directly;
2. Disconnect the battery.

Endurance Mileage



The distance you can drive can be estimated and displayed based on the current driving mode and the fuel quantity in the tank. If you drive your car in a more economical way or in a better road condition, this effective distance may be further increased.

Service information

When the keyless start / stop button is in the "run" mode, under the service menu interface, the service information can be viewed circularly by short press  /  key. The information that can be viewed includes: fault, tire pressure, maintenance mileage.

Tire pressure



When all tire pressures are normal, the corresponding position of the instrument cluster tire pressure displays the tire pressure and temperature.

When the temperature or pressure is abnormal, the tire on the tire pressure interface turns red and the corresponding abnormal temperature or pressure turns red, and text and sound prompts are made at the same time.

The warning light of the tire pressure system is on. When other tire pressure faults occur, text and sound prompts pop up. At this time, the user should timely check the tire status or contact the 4S shop for maintenance. The instrument has potential safety hazards.

Note

- After the engine stopped, restart the vehicle. After the self check of the instrument, the instrument can display the tire temperature and pressure value, which is the historical value before the start, and the tire temperature and pressure value not in the current vehicle status.
- When the vehicle starts to drive, the system will update the current tire status in real time.
- After the vehicle starts, the running speed exceeds 30km / h and after a period of time, the instrument updates to display the current tire pressure / temperature value of the tire, and the tire pressure monitoring system automatically enters the normal working mode.



Maintenance mileage



The maintenance mileage shows the distance to the next vehicle maintenance. The first maintenance mileage of the whole vehicle is 5000km, and the interval maintenance mileage is 7500km. It is recommended that the user check it regularly and maintain it in time. In the maintenance information display interface, press the confirm key to reset the maintenance mileage according to the instrument prompt.

Instrument information



The menu contents include auxiliary, telephone, itinerary, navigation, radio, music and service. The menu icon can be selected by turning left key  and right key  of the instrument. After selection, press OK key to enter this menu. (Refer to "instrument cluster (Full LCD only)")

Indicator light and alarm light of combination instrument (7 inches)*

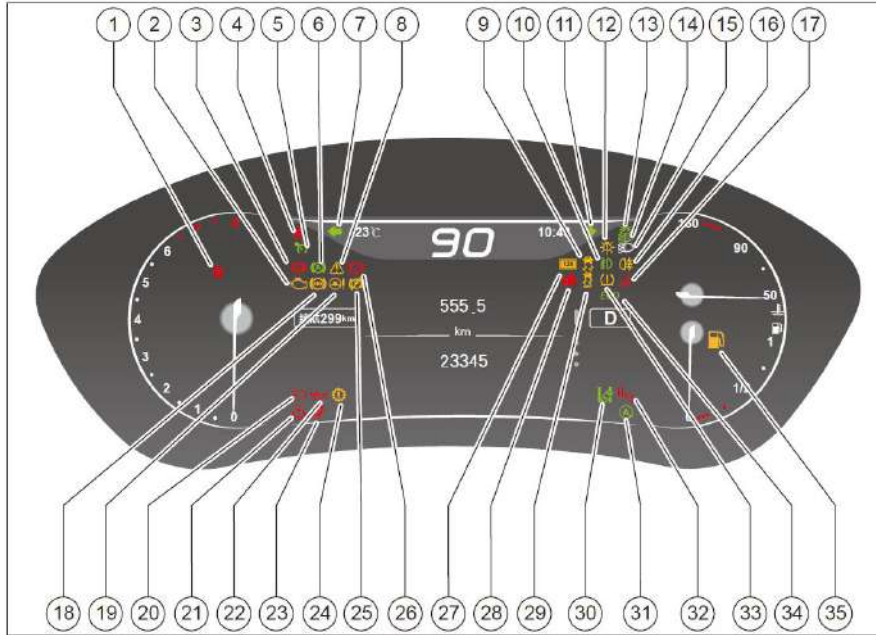

1. Vehicle anti-theft indicator
2. Engine system fault warning lamp
3. Parking brake indicator
4. Driver's seat belt unfastened warning light
5. Cruise indicator
6. Automatic parking indicator
7. Left turn indicator
8. Fault indicator
9. ESP working / fault indicator
10. Front fog lamp on indicator
11. Right turn indicator
12. Light system fault indicator
13. Position lamp on indicator
14. High / low beam on indicator
15. Automatic headlamp indicator*
16. Rear fog lamp on indicator
17. Coolant overheat alarm indicator
18. ABS fault alarm lamp

Indicator light and alarm light of combination instrument (7 inches)*

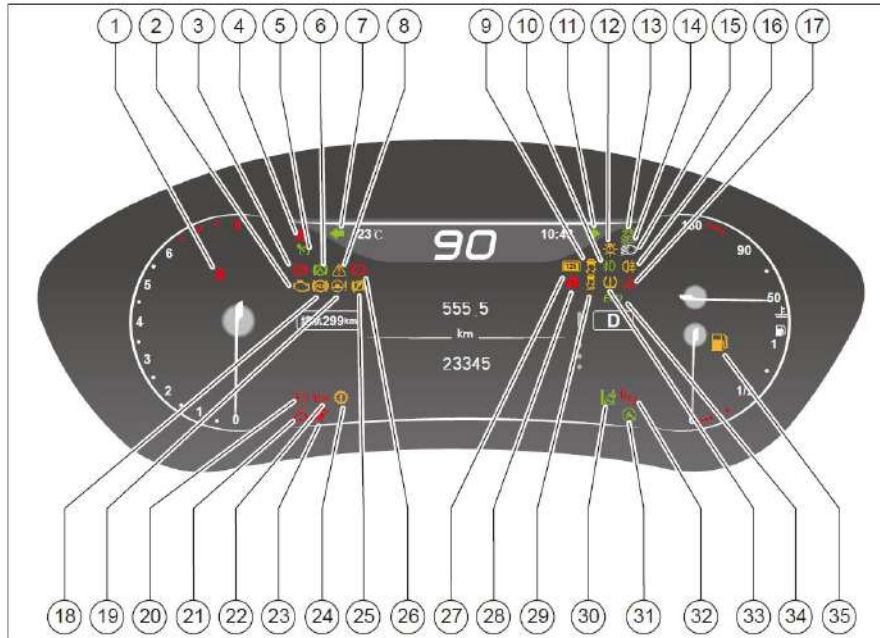

19. Electric power steering system fault warning lamp
20. Battery charging fault alarm lamp
21. Door state indicator
22. Oil pressure warning lamp
23. Airbag system fault warning lamp
24. Transmission failure warning lamp
25. Electronic parking fault indicator
26. Brake system fault / low brake level warning light
27. Overspeed alarm indicator*
28. Engine anti-theft indicator
29. ESP off indicator
30. Lane departure warning indicator*
31. Idle start stop system working indicator*
32. Work indicator of blind area monitoring system*
33. Tire pressure monitoring warning lamp
34. ECO*
35. Fuel level warning lamp

Combination instrument (full LCD)

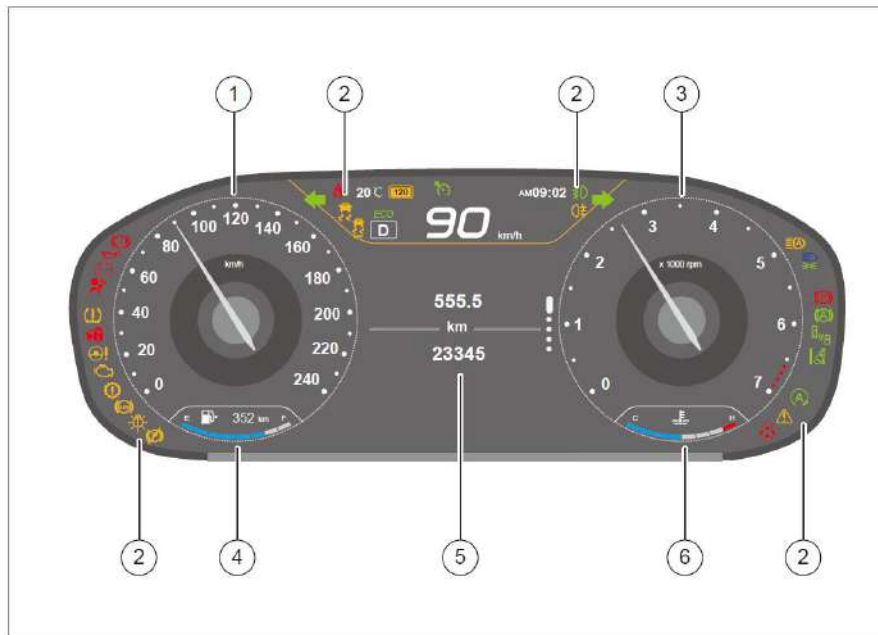

1. Speedometer
2. Indicator light and alarm light
3. Engine tachometer
4. Fuel gauge
5. Trip computer display
6. Engine coolant temperature gauge

Engine coolant temperature gauge



This lamp indicates the temperature of the engine coolant. During normal driving, the blue indicator bar should indicate near the middle position. If the indicator strip enters into the red scale area, indicating that the coolant temperature is too high, which may cause serious damage to the engine, stop the engine immediately for inspection or help if the safety conditions permit. If the corresponding indicator strip enters the red scale area several times, stop the engine at the proper position as soon as possible and turn off the engine, and check the coolant level.

Engine tachometer



The tachometer indicates the number of engine revolutions per minute (x1000rpm). The tachometer can also assist in evaluating engine performance.

Danger

- To prevent damage to the engine, do not allow the speed to stay in the red A area for a long time.

Speedometer



The speedometer shows the vehicle's real-time speed in km / h.

Warning

- When the vehicle is driving, observe the speedometer from time to time, and do not overspeed.

Note

- Shifting into the high gear in time helps to save fuel and reduce engine running noise.

燃油表



The fuel gauge shows the amount of fuel remaining in the fuel tank and the cruise mileage.

When braking, accelerating, turning or driving on a ramp, the fuel in the fuel tank will shake, which will affect the accuracy of the fuel gauge display. The vehicle should be placed on a flat road to check the fuel quantity.

When the fuel is insufficient, the last section of the fuel gauge will be on, and the insufficient fuel warning lamp will be on at the same time.

The range can be estimated and displayed based on the existing driving mode and the fuel in the tank. If you drive your car in a more economical way or in a better road condition, this effective distance may be further increased.

Danger

- Do not drive until the tank is completely empty of fuel. Irregular fuel supply may lead to poor engine ignition, unburned fuel entering the exhaust device and damaging the catalytic converter.

Instrument display (full LCD)*

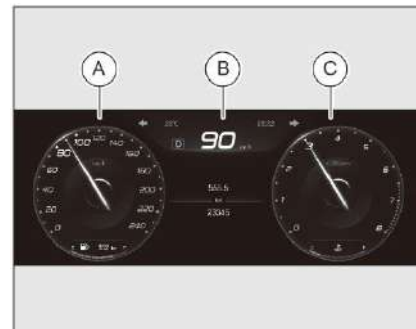





The whole LCD instrument is divided into three areas: A area, B area and C area.

By operating the instrument operation key on the left side of the steering wheel, you can view the driving information, menu and instrument function settings.



Instrument operation key



Confirm Button: press the paddle ① ;
Instrument return key ;
Upturn:  Move the paddle upward①);
Down:  (Move the paddle down①) ;
Left turn: ;
Right turn: 

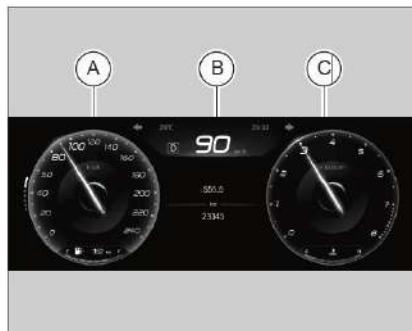

Instrument area A



Press the left turn key  of the instrument to move  /  the halo to the left, and the toggle / key switching contents include: vehicle speed, after self startup, after self reset, after self refueling, music and clock.

Instrument area B



Press the instrument return key to call up the menu. All the contents of the menu can be displayed in area B. the menu contents include: auxiliary, telephone, journey, navigation, radio, music, style and service. Press the key  and the  key to select the menu, and short press the confirm key to enter the corresponding menu. (see "service information" for service menu.)

Assist



Press key ▲ / ▼ in the auxiliary interface to select the functions of "attention assist", "overspeed alarm" and "driving assist *", press the confirm key  briefly to confirm the current selection, and press the key briefly to return to the previous interface after confirmation.

Attention Assist



Select "attention assist" in the assist interface and press the confirm key briefly to enter the attention assist setting. After entering the attention assist setting interface, toggle ▲ / ▼ Press the key to select "close", "standard" and "sensitive". Short press the confirm key to confirm the current selection. After confirmation, short  press the key to return to the previous interface.

Speed Alarm



After selecting "overspeed alarm" in the auxiliary interface, press the confirm key briefly to enter the overspeed alarm setting. After entering the overspeed alarm setting interface, the overspeed alarm function can be selected by operating the left key of steering wheel, and the current selection can be confirmed by short pressing the confirm key. After confirmation,  short pressing the key returns to the upper interface.





Driving assistance



After selecting "driving aid" in the auxiliary interface, press the confirm key briefly to enter the full screen assistance. Press the key  briefly to return to the previous interface.





Phone



Dial in phone interface  /  can select the number of "call record", short press the confirm key to dial the current number, and short press the confirm key to hang up the current call during the call. When calling, select the answer or end call by pressing the key , and the key , and confirm the current selection by short pressing the confirm key.

Navigation



Press the key  /  in the navigation interface to select "driving direction", "small map" and "navigation full screen display". Short press the confirmation key to confirm the current selection. After confirmation, enter the full screen map, short press the key  to exit the full screen interface, and short press the key  to return to the upper level interface.



Navigation full screen



1. Select "navigation full screen display" in the navigation interface, and press the Enter key to enter the full screen display. Press the key  briefly to exit the full screen.
2. Under the navigation interface, the audio head unit can swipe left to display the full screen and right to exit the full screen.





Trip



In the travel interface, press the key  /  to select "mileage", "fuel consumption", "after starting", "after reset" and "after refueling". Short press the confirm key to enter the current selection reset interface, and select whether to reset or not; long press the confirm key to directly reset the current selection interface. Press the key  briefly to return to the previous interface. (see trip information)

Radio



In the radio interface, by press  /  to switch the radio station, press the confirm key briefly to enter the selection page to select the radio type. Press the key  /  to select "Favorites", "FM", "am" and "online radio". Short press the confirm key to confirm the current selection. After confirmation, short press the key  to return to the previous interface.

Music



In the music interface, toggle press the key / to switch the radio station, and short press the confirm key to enter the selection page to select the music type.

Press the key / to select "Bluetooth music", "USB music", "local music" and "online music". Short press the confirm key to confirm the current selection. After confirmation, short press the key to return to the previous interface.

Style



In the style interface, press / to select "classic" and "minimalist". Short press the confirm key to confirm the current selection. After confirmation, short press to return to the previous interface.

Instrument area C



Press the right turning key of the instrument to move the halo to the right, and press / to switch the contents including: speed, driving assistance, map, fuel consumption and tire pressure.

Indicator light and alarm light of combination instrument (full LCD)

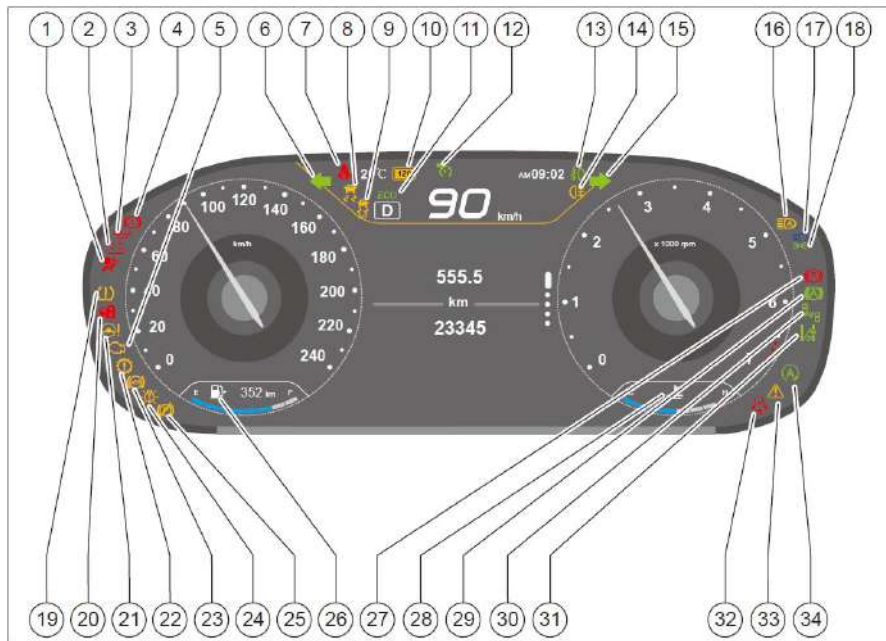

1. Airbag system fault alarm lamp
2. Battery charging fault alarm lamp
3. Oil pressure warning lamp
4. Brake system fault / low brake level warning light
5. Engine system fault warning lamp
6. Left turn indicator
7. Driver's seat belt unfastened warning light
8. ESP working / fault indicator
9. ESP off indicator
10. Overspeed alarm indicator*
11. ECO*
12. Cruise indicator*
13. Front fog lamp on indicator
14. Rear fog lamp on indicator
15. Right turn indicator
16. Intelligent high beam auxiliary indicator*
17. High / low beam on indicator
18. Position lamp on indicator

Indicator light and alarm light of combination instrument (full LCD)*

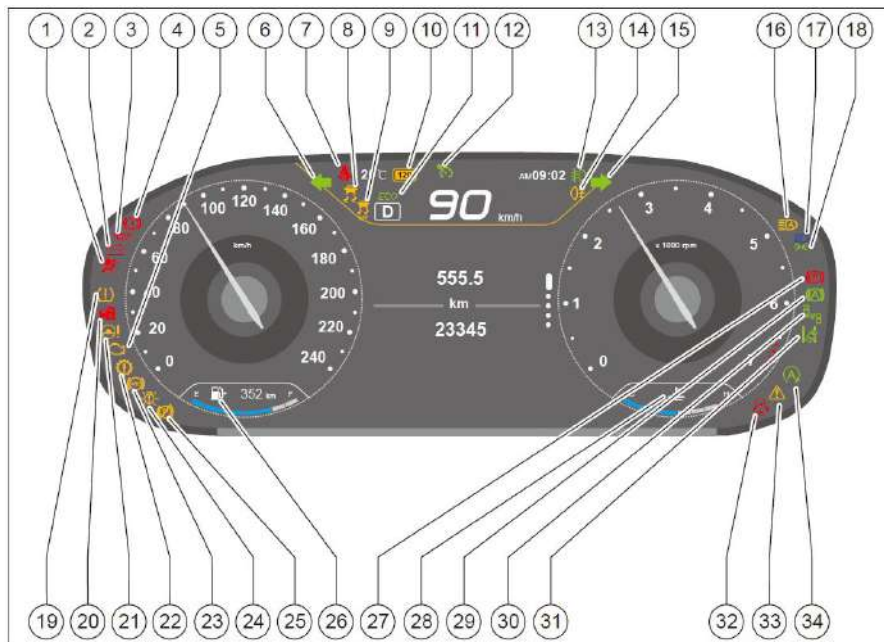

19. Tire pressure monitoring warning lamp
20. Engine anti-theft indicator
21. Electric power steering system fault warning lamp
22. Transmission failure warning lamp
23. ABS fault alarm lamp
24. Light system fault indicator
25. Electronic parking fault indicator
26. Low fuel warning lamp
27. Parking brake indicator
28. High water temperature alarm indicator
29. Automatic parking indicator
30. Work indicator of blind area monitoring system
31. Lane departure warning indicator
32. Door ajar indicator
33. Fault indicator
34. Idle start stop system working indicator*

Description of warning and indicator

Engine system fault warning lamp (yellow)

When the start / stop button is in the "run" mode, this lamp will be on for self inspection. When the vehicle is started, if there is no fault, this lamp will be off. When the warning lamp does not turn off after the engine is started or lights up during driving, it indicates that the engine system is faulty.

Danger

- If the warning light is on during driving, should contact the special BAIC dealer or maintenance as soon as possible. If no measures are taken, the engine performance may be seriously affected.

Cruise standby indicator (white) *

When the cruise control switch is on, but the system is not activated, the indicator light is on.

Constant speed cruise operation indicator (green) *

This indicator illuminates when the cruise control system is active.

ESP Work / fault indicator (yellow)

When the start / stop button is in the "run" mode, this light will be on for self-test, and it will be off after self-test. During driving, if the indicator light flashes rapidly, it indicates that the ESP is in operation; after self-test or during driving, if the indicator light is on, it indicates that the ESP system is faulty. The alarm pop-up window displays the prompt message "please check ESP", accompanied by a prompt tone. If the alarm indicator light is on for a long time, please check and repair it at the nearby 4S shop as soon as possible.

ESP close indicator light (yellow)

This light indicates whether the ESP system is turned off or not. This light is on when the ESP system is turned off.

Danger

- Under normal driving conditions, open the ESP system helps to improve the comfort and safety of the vehicle, but you should drive carefully at any time when driving on curves and slippery roads.

Low beam on indicator (green)

Indicates the working status of the low beam lamp, which is on when the low beam of the headlamp is turned on.

High beam on indicator (blue)

Indicates the working state of the high beam lamp, which is on when the high beam of the headlamp is turned on.

Position light on indicator (green)

Indicates the working status of the position lamp, which is on when the position lamp is turned on.

Left turn indicator  (green)

Indicates the working status of the left turn signal lamp. When the left turn signal lamp or hazard warning lamp is turned on, the indicator lamp flashes. If the indicator light flashes faster than normal, it means that the left steering light is faulty. Please check and repair it at the nearby dealer shop as soon as possible.

Right turn indicator  (green)

Indicates the working status of the right turn signal lamp. When the right turn signal lamp or hazard warning lamp is turned on, the indicator lamp flashes. If the indicator light flashes faster than normal, it means that the right steering light is faulty. Please check and repair it at the nearby dealer shop as soon as possible.

Rear fog lamp on indicator  (yellow)

Indicates the working state of the rear fog lamp, which is on when the rear fog lamp is turned on.

Front fog lamp on indicator  (green)

*
Indicates the working status of the front fog lamp, which is on when the front fog lamp is turned on.

Automatic light indicator  (white) *

This indicator light indicates the working state of the automatic light system. When the automatic light system is working, this light is on.

Intelligent high beam auxiliary standby indicator  (white) *

This indicator light indicates the standby state of the intelligent high beam assist system. When the intelligent high beam assist system is in the standby state, this light is on.

Intelligent high beam auxiliary work indicator  (green) *

This indicator light indicates the working status of intelligent high beam assist system. When the intelligent high beam assist system is working, this light is on.

Intelligent high beam auxiliary work indicator  (yellow) *

This indicator is displayed in case of system failure. Please contact the dealer for maintenance.

Parking brake indicator  (red)

Indicates the working state of the EPB. When this light is on, it indicates that the EPB parking function has been turned on. If

the parking function is on, it will not turn off after self check

Extinguish. When the vehicle is off, the parking function is automatically turned on.

Driver's seat belt unfastened warning light  (red)

This light indicates the status of the driver's side safety belt. When the driver does not fasten the safety belt, this light is on.

When the vehicle speed $\geq 25\text{km/h}$ or the vehicle driving time $\geq 60\text{s}$ or the vehicle driving distance $\geq 500\text{m}$, and the driver's safety belt is not fastened, the driver's safety belt not fastened warning light flashes, accompanied by an audible alarm. At the same time, the seat at the corresponding position in the alarm pop-up window turns red.

Transmission fault warning lamp  (yellow)

When the start / stop button is in the "run" mode, this light will be on for self-test, and it will be off after self-test. After the self-test, if the indicator light is on, it indicates that the automatic transmission system is faulty. If there is a gearbox fault, the driving performance of the vehicle will be significantly reduced and the engine speed will be limited to about 3500r / min.

Airbag system fault warning lamp

(red)

When the start / stop button is in the "run" mode, this light will be on for self-test, and it will be off after self-test.

After the self-test, if the indicator light is on, it indicates that there is a fault in the airbag system. When this fault indicator is on, the function of the airbag system cannot be guaranteed to be normal.

Warning

- When the airbag system fault alarm light is on, it cannot guarantee the normal function of the airbag system.
- If the alarm indicator is not on during the self inspection, it means that the airbag system or the alarm indicator is damaged. Please go to the nearby dealer shop for repair and inspection as soon as possible.

Vehicle anti-theft indicator light (applicable to 7-inch instrument)

(red)

When anti-theft intrusion is detected, the alarm indicator is all ways on .

Engine anti-theft indicator (red)

When the start / stop button is in the "run" mode, this light will be on for self-test, and it will be off after self-test.

When the key fails to pass the engine anti-theft certification, the light is always on and the engine cannot be started.

Brake system fault / low brake level warning light (red)

When the start / stop button is in the "run" mode, this light will be on for self-test, and it will be off after self-test. If the warning lamp does not go out or is on during driving, it indicates that the brake fluid level is low or the brake system is faulty.

If the warning light is on during driving, stop the vehicle immediately under safe conditions. Do not press the brake pedal repeatedly.

ABS Alarm lamp (yellow)

When the start / stop button is in the "run" mode, this light will be on for self-test, and it will be off after self-test.

If the warning lamp does not turn off or illuminates during driving, it indicates that there is a fault in the ABS system.

Oil pressure warning lamp (red)

When the start / stop button is in the "run" mode, this lamp will light up the self-test and will turn off after the engine starts.

If the alert indicator illuminates after the engine is started, the oil pressure is low. The alarm pop-up window displays "low oil pressure", accompanied by three warning tones. At this time, stop the vehicle immediately under the condition of ensuring safety, and do not continue to drive.

Economy mode indicator (green)*

When the economy mode is on, the indicator light is on.

The fuel shortage alarm light (yellow)

will be in the "run" mode when the start button is on. It will be on and self check will be carried out. It will be off after self check. It does not turn off after self-test or the warning lamp lights up during driving, indicating that the fuel is insufficient. Replenish the fuel in time at this time.

If the warning light flashes, the fuel sensor is faulty. At this time, the fuel gauge cannot indicate the current fuel quantity normally. Please go to the nearby 4S shop for repair and inspection as soon as possible to avoid vehicle breakdown.

water temperature alarm indicator (red)

When the start / stop button is in the "run" mode, this light will be on for self-test, and it will be off after self-test.

This warning lamp will not turn off after self-test or will be on during driving, indicating that the current engine coolant temperature is high. The alarm pop-up window displays "engine water temperature is high", accompanied by a prompt sound. (at this time, reduce the engine speed, and stop the engine immediately when ensuring safety.

Tire pressure monitoring warning lamp (yellow)

When the start / stop button is in the "run" mode

When the lamp is on for self inspection, it will

go out after self inspection. If it does not turn off after self inspection or the indicator light is on for a long time during driving, it indicates that there is abnormal tire pressure. The warning pop-up window displays "abnormal tire pressure", accompanied by a prompt tone; It does not turn off after self-test or the indicator lights up for 60 seconds after flashing during driving. Indicates a problem with the tire pressure system. The warning pop-up window displays "tire pressure system failure".

In case of the above situations, safety shall be ensured.

Pull over and check the condition of the tires.

Battery charging fault warning lamp (red)

When the start / stop button is in the "run" mode, this light will be on for self-test, and the engine will be off after starting.

If the light is on during driving, stop the vehicle as soon as possible and turn off the engine.

Door status indicator (red)

Indicates the switch status of four doors, engine compartment cover and luggage compartment cover. When any door is not closed, the indicator light is on.

EPS system fault warning lamp (yellow)

When the start / stop button is in the "run" mode, this lamp will light up the self-test and turn off after the self-test.

If it does not turn off after the self-test or illuminates during driving, it indicates that there is a fault in the EPS system. The alarm pop-up window displays "please check EPS".

Idling start-stop system working indicator light  (green)*

The start/stop button is in the the "RUN" mode, the light self-checking, then go out. The light indicates start/stop system status. When the vehicle enters into idle stop mode, the light goes on.

Idle start/stop OFF/fault indicator light  (yellow)*

The start/stop button is in the the "RUN" mode, the light self-checking, then go out. When Idle start/stop turn off or the system has a fault, the light lights up.

Lane departure indicator  (white) *

The indicator light indicates a lane departure warning system standby mode, when the lane departure warning system standby, it light.

Lane departure indicator  (green) *

The indicator light indicates a lane departure warning system open, when the lane departure warning system normally open, it light.

Lane departure indicator  (yellow) *

The indicator light indicates a lane departure warning system in fault state, when the lane departure warning system can not work normally, it lights. Alarm window shows "lane departure warning system fault" at the same time with three whistles.

Blind Zone Monitoring System indicator  (white) *

The indicator light indicates Blind Zone Monitoring System standby mode, it light.

Blind Zone Monitoring System indicator  (green) *

The indicator light indicates Blind Zone Monitoring System open, when the system open, it lights.

Blind Zone Monitoring System indicator  (yellow) *

The indicator light indicates Blind Zone Monitoring System in fault state, when the system can not work normally, it lights. Alarm window shows "Alarm window shows fault", at the same time with three whistles.

Light system fault warning light  (yellow) *

This indicator light presents the condition of the outside light, when the light outside the vehicle is in error, it will turn on. The warning window will pop out "Light system error" with a prompt tone. If the warning light turn on during a trip, please pull out to check the outside light under a safe situation.

Fault indicator light  (yellow) *

When a fault information confirmed and deposit under the fault view menu, it lights.

Over-speed warning light  *

This light indicates whether the current speed is over the speed that driver set. when speed exceeds, and trigger the overspeed alarm.

The system default setting is 120 km/ h, the driver can set speed or shut down the system.

Auto parking brake indicator light

 (green)

It indicate automatic parking system state, when green light, the automatic parking system has been activated.

Auto parking brake indicator light 

(yellow)

It indicate automatic parking system state, when yellow light, indicate automatic parking function failure.

Electronic parking failure indicator light

 (yellow) *

The start/stop button is in the "RUN" mode, the warning light remains about 3 seconds check by itself, this light 3 seconds, and goes out after self-test.

The light indicate state of EPB system. When EPB system has a fault, warning light goes on, please contact the authorized dealer of BAIC for repair as soon as possible.

Steering wheel

Adjust the position of steering wheel



The driver may adjust the height of steering wheel, on the basis of his physique and driving habit.



Loose the steering wheel adjustment lock lever to the lower to adjust the steering wheel up and down, facilitating driving comfort, and safety of different persons.

After appropriate adjustment, hold the steering wheel, push back the lock lever up, and shake the steering wheel to confirm the steering wheel position is locked reliably.

Warning

- Do not adjust the steering wheel violently up and down when the locking handle is not released, because this will cause damage to components.

Danger

- Forbidden to adjust the steering wheel position when the vehicle run, in order to avoid accidents.
- Please forcibly press down the locking lever, so as to prevent the position of steering column changes when the vehicle is running.

Multifunction steering wheel





The multifunction steering wheel is equipped with the following function button switches:

- ① Constant speed cruise and instrument setting buttons
- ② Cruise control and Sound system control button
- ③ Horn

Constant speed cruise and instrument setting buttons *



Turn on or off constant speed cruise function. 

Release current cruise control 

Confirm key: Press lever①;

Return key: 

Turn up:  (Upward lever①) ;

Turn down  (Down lever①) ;

Turn left: 

Turn right: 

One-click photo: 

Constant speed cruise and Sound system control button *



Speech recognition 

Mode switch: 

Mute:(Press lever②);

Volume up  (Up lever②) ;

Volume down  (Down lever②) ;

Next chapter, answer phone 

Previous chapter, hang up phone: 

Reset or ascend cruising speed: 

One-click photo: 

Caution

- The function of media player system control buttons refer to media player system operating instructions.

Horn



Press the region near the horn logo  on the steering wheel, the horn will sound and stop when your hand releases.

Warning

- Do not hit or struck horns with fists, so as not to damage the horns.
- Observe horn-blowing control traffic regulations for civilized use of horns.

Remote Key

Smart key*

Vehicle equipped with an ignition switch is equipped with a remote control key and a spare mechanical key. Effective range of the remote control key may be reduced under the effect of external environment, which is a normal phenomenon. Short-term fault of remote control key could be affected by other key, cardiac pacemakers or other radio transmitters. You can try the following operations if the remote control key fails:

- You can walk near the vehicle, and then try again. In the rain and snow weather, the effective range of smart key may decrease.
- Walk a few steps to the left or right, hold the smart key a little higher, and then try again. Other vehicles or objects between the vehicle and the Smart key may block the transmitting of signal.

- Check the battery inside the key The remote key contains a folded mechanical key. Folded mechanical key can unlock and lock all doors. You can unlock and lock all doors with the spare key. You can also start the engine with the key.

If the key is lost, please contact with the authorized dealer of BAIC as soon as possible to adapt the key again, so as the vehicle will not be stolen.

Warning

- Do not let any object which will interfere with electromagnetic wave adhere onto the smart key (such as a metal film).
- Don't use the remote control key to knock any other article forcibly.
- Don't expose the remote control key to heat for long time. For example , don' t place it on instrument panel or engine hood under direct sunshine.
- Do not wet the remote control or clean it in the ultrasonic washer.

Warning

- Don't put the remote keys and launch electromagnetic waves device, such as mobile phones.
- The interior materials could affect vehicle remote control distance (such as metal tint, etc.), please select the appropriate vehicle interior materials.
- When taking airplane with the smart key, you should ensure do not press any button on the remote control key in the compartment.
- Pressing the button may cause the remote control key to emit radio wave, which may interfere with the aircraft flight.

Mechanical key open door

Smart key contains a mechanical key, it can be used in case of an emergency. If smart key lose efficacy for battery battery runs out or other malfunction, you can take out the mechanical key as follow steps, and open door.

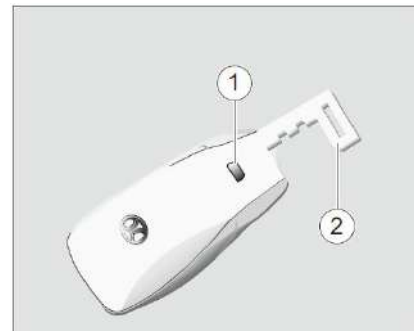

Smart key contains a mechanical key. If the smart key does not work, you can use the mechanical key to unlock the door.

Steps to take out the mechanical key:

1. Press and hold the lock button ①, the mechanical key ② popup.
2. Pull out the mechanical key ②.
3. Rotate counter-clockwise door lock core unlock and rotate clockwise lock.

Steps to putback the mechanical key :

1. Press and hold the lock button ①.
2. Insert the mechanical key ②, after the mechanical key ② completely was put into the smart key, loose the lock button①.

Note

- After use, please make sure to put the mechanical key back to its original place.

Mechanical key emergency lock the door

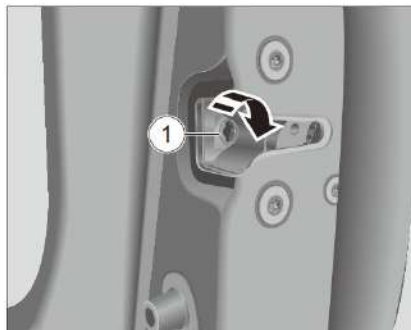

In case of vehicle power interruptions, the mechanical key lock the left front door, others 3 doors were locked by emergency lock.

Emergency lock method :

1. Take out the mechanical key
2. Open the door, using mechanical key clockwise turn the emergency lock locking switch①.
3. Close the door.

Wireless Remote Control



The unlocking key  : Unlcok all doors

The locking key  : Lcok all doors

MODE The trunk unlocking key:  :
Unlock the trunk.

The vehicle searching key  Pressed
down the key in protection mode The
vehicle will issue a vehicle searching sound
and help locate the vehicle.



Warning

- If the unlocking/locking key is pressed continuously, the door lock protection function will be triggered, and the unlocking and locking functions will be invalid for a short period of time.

Lock vehicle doors



When all doors, engine hood and trunk lid are closed, press the lock button  all the turn signal lamps light about 2 seconds.



Caution

- Check and confirm that all vehicle doors have been firmly locked.

Some conditions that some doors are not locked

- When any door (4 doors) is not lock, press the lock button, doors should not lock and exterior rearview mirrors will automatically be folded.(If functionality).
- If the doors are closed, but the engine hood and the trunk lid are not closed, press lock button, sound and light remind (Horn ring 3 times and the turn signals will flash 3 times), and then the vehicle is in alarm, press unlock button discharged alarm.

Unlocking of doors



When all doors, engine hood and trunk lid are closed, press the unlock button , 4 doors are unlocked, turn signal lamps flash twice.

Open the trunk



Press and hold the trunk lid unlock button  on the key for more than 1s to unlock the trunk lid.

Vehicle locating function



When the vehicle is in fortification state, press the locking button  on the remote control key in the distance of <15m (open space), then all turn signal lamps flash twice and the horn sounds twice.

Replace the battery

Press the button on the remote key, the remote key indicator light does not go on, indicating that the key power is low, and then the battery should be replaced.

The key may be damaged when replacing the battery, so it is recommended to go to the authorized BAIC dealer for replacement. If you replace it by yourself, bring CR2032 lithium battery your own

Danger

- Be careful not to touch the remote control circuit board, otherwise may product static, to damage the remote key.
- When replacing the key battery, be careful not to lose any part
- Replacement CR2032 lithium battery.
- How to disposal waste battery low should be according to local law.

 Note

- Ensure that the positive and negative terminals of battery of key are installed correctly.
- Don't use wet hand to replace the battery of the remote key, water can lead to battery rust.
- Avoid touching and moving other parts in the key, otherwise it may affect the function of the key.
- Be careful not to bend electrodes inside the battery when loading key battery. The battery box shall not have dirt or oil.

Replacement method of remote key battery

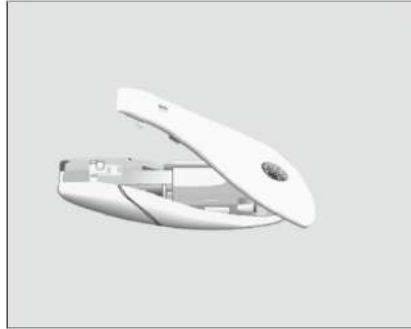

1. Take out the Mechanical key .
2. Pry up the rear cover of smart key;

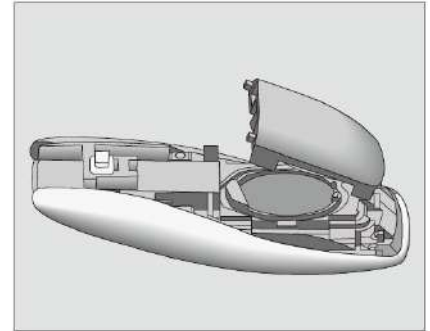

3. Open the battery cover.

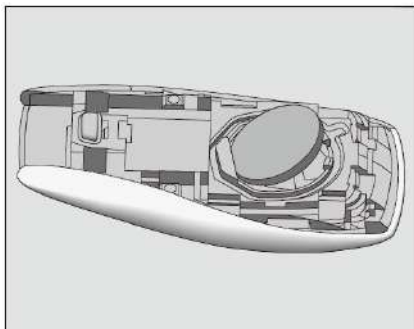

4. Remove the used battery, and avoid touching on the circuit board and the battery clamps.

5. When inserting a new battery, be sure to avoid touching the battery surface. Before inserting, wipe the new battery clean.

6. When inserting, ensure that the battery cover is fully engaged and prevent dust and vapour come inside.

7. After replaced battery it is necessary to test whether the smart remote key functions normally. If the smart remote key still doesn't work normally, please contact an authorized BAIC dealership.

The Key-less Entry and Starting System

Key-less Unlocking

As long as there is a legitimate remote control key within an extent of 1m from the two front doors of the vehicle, hold the door handle on the driver or the passenger-side and the vehicle door will be unlocked and opened.



Key-less Locking

With remote key, in the range of about 1 m front door handle, start/stop button in the "ACC" or "OFF" mode, , all doors, engine hood and trunk lid closed, touch front door handle whole vehicle closed and is in fortification state.

The Key Reminder Function

Key is left inside the vehicle

When a smart key stay in the vehicle (excluding trunk area), when from any door open to four doors are closed, lock the vehicle with outside remote key, or press the door handle to lock or unlock with an other smart key, instrument screen will be prompted information: key forgot inside, does not perform locking request.

Smart key is not inside the vehicle:

When the start/stop button is in the "RUN" model, from any door open to four doors are closed, detect the smart key is not inside, instrument screen will be prompted information: the key is not inside.

Anti-theft alarm system

Your vehicle is equipped with vehicle anti-theft system and engine electronic anti-theft system. In order to ensure maximum safety and ease of operation, we strongly recommend that you carefully read the instructions in order to fully understand their characteristics and methods of use.

Warning

- When the door is unlocked, the vehicle exits anti-theft alarm status, but if you do not open any door, the trunk lid or engine hood within about 30s, then all the doors automatically lock again, and vehicle anti-theft alarm will automatically return to the alarm state.

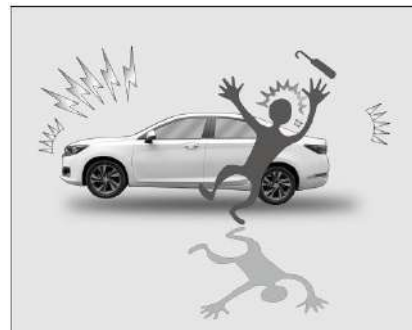

After locking the vehicle with smart key or remote control key, the vehicle is fortified, and all doors, the engine hood and trunk lid are in a monitored state. If any door, engine hood, or trunk lid is opened illegally, for example, someone open the door forcibly, the alarm will be activated. Only when all doors, engine hood and trunk lid are in locked state, the vehicle anti-theft alarm function can be activated. If the smart key or remote control key is used to lock the vehicle, the vehicle horn sounds, and turn

lights flash, reminding the vehicle does not enter into the alarm state, you should check whether the engine hood and trunk lid are closed reliably. If so, but you still cannot activate the alarm, please go to the authorized dealer of BAIC for repair, in order to avoid property loss due to alarm fault.

Triggering conditions of the alarm status:

- If you lock doors with the smart key, all doors locked, but engine hood or trunk lid unlock, the vehicles prompt alarm.
- If you lock doors with the smart key, any door(include hood and trunk lid) open, the vehicles prompt alarm.
- If lock doors with the smart key, unlock and open door with mechanical key, the vehicles prompt alarm.

Phenomenon triggered the alarm status

- All turn signal lamps flash simultaneously and the horn beeps.

Methods to release the anti-theft alarm status after triggering:

- Press the unlock button on the smart key or the remote control key to release anti-theft alarm, lights and sound signal are stopped, and the vehicle is unlocked.
- The alarm state can also be release after the vehicle engine is started .

i Note

- Only lock with the smart key , the vehicle is in fortification state.

Oil system automatic cutting system

When (collision) traffic accident, the ECU receives the vehicle collision signal will immediately turn off the fuel pump relay, to stop the vehicle gas supply, prevent danger happen.

Central door lock system

Central control door lock system

Central lock system can lock and unlock all doors:

1. Operate the central lock system with a smart key or remote control key.
2. The central lock system can be operated with the central lock button in the vehicle.

Central lock button

Central lock button locate at left front door glass lifts and down switch panel, the driver can easy lock and unlock doors.



Unlock doors:

Press button  all doors unlock.

Lock doors:

Press button  all doors lock, can not open from outside

After lock all doors, you can alone open every door inside vehicle. When one of four doors opened, you cannot lock operation with the button. 

Note

- Never leave a child or limited mobility alone in the vehicle! They might accidentally press lock button, lock the vehicle. In an emergency, children or limited mobility hard to leave the vehicle, and the car door lock will increase the difficulty that others rescue..

Open the doors from inside the vehicle



Doors are locked state, you need to pull the inner handle twice if you want to open the door with the handle inside the vehicle. Pull one time to unlock the door, pull the second time, open the door. Doors are unlocked state, pull the handle one time, you can open the door.

Warning

- When the door is locked, pull the inner handle once, and do not pull the door forcibly, in order to avoid damages to the handle and the door lock.

Automatic locking function

When the vehicle speed is higher than the set value during vehicle traveling, the central lock will automatically lock all doors.

Caution

- You can turn on , turn off and set the effect speed of automatic locking function in multimedia screen. (The detailed operation see separate operating instructions).

Automatic unlocking function

After parking, the keyless start/stop button is in the "OFF" mode, the central lock automatically unlock. If a collision occurs during vehicle traveling, the airbag inflate and the four doors will automatically unlock.

Caution

- Automatically unlocked can be set to single unlock left front door or all doors. This function can be set by the multimedia screen. (The detailed operation see separate operating instructions).

Four doors, two covers are not closed reminder



The door, engine hood cover and trunk cover are not closed properly.

Danger

- Before driving, it is necessary to ensure that all doors, engine hood and trunk cover are closed. If there is a warning on the computer display screen that the door, engine hood and trunk cover are not closed properly, driving is strictly prohibited.

Child safety lock



When there are children in the back row, be sure to adjust the child lock to the locked state. Dial the child safety lock lever obliquely to the right, the child safety lock will be locked; Dial the child safety lock lever obliquely to the left, the child safety lock will be unlocked.

Notice

- In order to prevent children from accidentally opening the rear door and causing accidents, it is recommended to lock the children safely when traveling with children.
- For child safety lock door, even if the door has been unlocked, it can only be opened from outside the vehicle.
- There are child safety locks in both rear doors.

Warning

- When the child safety lock is locked, the door cannot be opened from the car. When the rear door cannot be opened by the inner handle, it may be that the child safety lock is working. Do not force the inner handle so as not to cause damage.

Engine hood

Open engine hood



1. Pull the open handle of the engine hood at the front of the driver's side threshold along the arrow direction, then the engine hood is unlocked and it will bounce up slightly.



2. Lift the engine hood slightly. Push the safety engine hood handle to the right with your finger from the gap in the middle of the engine hood. Lift the engine hood upward.



3. Open the engine hood to the appropriate position, pinch the rubber sleeve part of the support rod, pull the support rod out of the buckle, and insert its head into the elliptical hole on the engine hood to confirm the reliable support.

Close the engine hood

1. Check and make sure there is no other sundries in the engine room to prevent the parts of the vehicle from being damaged.
2. Hold the engine hood firmly and push slightly upward so that the support rod can be removed from the support hole, and the support rod can be retracted and clamped.
3. Slowly lower the engine hood to about 20 cm above the front grille, loosen your hands and use the gravity of the engine hood itself to lock it. After locking, push and pull the engine hood up and down to confirm that the safety lock is in place.

Danger

- If the distance between the engine cover and the upper part of the front grille is too large and the hand is released quickly, or the engine hood is closed down forcefully, the headlight and the front grille may be injured.
- If steam or smoke comes out of the engine room, do not open the engine hood to prevent injury.
- If the engine hood is not locked while the vehicle is running, the engine hood may be opened by high-speed airflow and cause serious accidents. Therefore, after closing the engine hood, it is necessary to check whether the locking device has been reliably locked.

Trunk

Cautions for trunk

Danger

- Keep the trunk cover closed during driving. If the trunk cover is opened, the luggage in it may be accidentally thrown out during driving, resulting in accidents or losses. So before driving, you must make sure that the trunk cover is closed.
- It is strictly forbidden to carry passengers in the trunk. Otherwise, serious injury or even death will be easily caused when emergency braking or collision occurs.
- Children should not be allowed to enter the trunk. If children are accidentally locked in the trunk, it may lead to overheating or suffocation.

Open the trunk

Use remote control key:



The trunk cover can be unlocked by pressing the unlock button on the remote control key for a long time.

Use the trunk cover to request the switch to unlock:



When the whole vehicle has been unlocked or carrying intelligent keys, the trunk cover can be unlocked by pressing the request switch on it.

Use in-car multi-function switch:



The trunk cover can be unlocked by pressing the unlock button on the multi-functional switch in the vehicle.

Emergency Open the trunk cover



1. Remove the back seat and enter the trunk. (For details, please contact BAIC distributor)
2. When the emergency open switch of the trunk is pulled, it can be unlocked, and the trunk cover can be opened by pushing outward.

Danger

When using the trunk, the following precautions should be observed, otherwise the body parts may be clamped, causing serious injury:

- When opening the trunk cover upward, it will pop up to the fully open position, and pay attention to the top safety.
- Before opening the trunk cover, the debris (such as snow or ice) on it should be removed to prevent pinch injury.

Warning

- When there are too many items in the trunk and it is not sure whether they will touch the cover, you can hold it firstly, slowly try to close it, after confirming that there is no problem, then close it.

Close the trunk

1. Press the trunk cover slowly to the position near the rear bumper.
2. Press the lid of the trunk forward and down with a little force on both hands and close it. When the trunk cover is closed, the warning icon of the unlocked trunk displayed on the computer display screen of the driving car will disappear.

Notice

- When closing the trunk cover, please check carefully so as not to clip on other people's fingers and other parts in the trunk.

Fuel filler



The open switch of the fuel filler is located on the inner floor of the driver's side threshold.

Upward pulling switch can open the fuel port located at the rear side of the vehicle.



When filling the fuel, slowly unscrew the nozzle cap counterclockwise. Before completely unscrewing, stop the nozzle cap at the nozzle to release the internal pressure. Then remove the nozzle cap and put it into the clamp.

When the filling is completed, rotate the filling cover clockwise until the "click" sound is heard, indicating that the filling cover has been tightened completely.

When tightening the cover of the refueling port, close the fuel filler by hand.

In order to ensure the performance of the vehicle, unleaded gasoline that meets the requirements of this vehicle must be used. (92 # and above)

Warning

- It is necessary to add gasoline to regular gas stations. Using substandard gasoline will shorten the life of the engine and even damage the engine.
- Don't add diesel to the vehicle. If you add diesel incorrectly, don't start the engine. You should contact BAIC distributor to clean the fuel system thoroughly.
- This vehicle is equipped with catalytic converter. Only unleaded gasoline is allowed to be used. If only once the leaded gasoline is added, the catalytic converter will be damaged.



Warning

- When filling fuel, as long as the filling gun stops automatically, indicating that the tank is "full", do not continue to force refueling, otherwise the expansion space in the tank will be filled with fuel, fuel may overflow when heated expansion.

- This vehicle is equipped with catalytic converter.

Before the fuel alarm lamp is lit, the fuel is injected, so that the fuel is not used up. When the oil level is too low, the irregular fuel supply will cause the engine to be short of fire, which will lead the unburned fuel into the exhaust device and cause the catalytic converter to be overheated and damaged. When the oil level is too low, it is not conducive to fuel pump lubrication.

- Fuel vapor is extremely flammable and causes fire. When filling fuel, the engine must be shut down. Smoking, mobile phones and other sparks or open fires must be strictly prohibited.



Danger

- Before fully opening the filling nozzle cap, it should be screwed loose to release the internal fuel pressure. Otherwise, the fuel vapor will be ejected from the filling port and cause people injury.

- When the fuel filling is completed, make sure that the cover of the refueling nozzle is tightened to prevent the fuel from flowing out and causing fire.

Power window



Danger

- When closing the electric windows, be careful not to pinch people. If the head, neck or hand of the passenger is clamped by the window, it may cause serious injury.

Driver Side Electric Window Control Switch

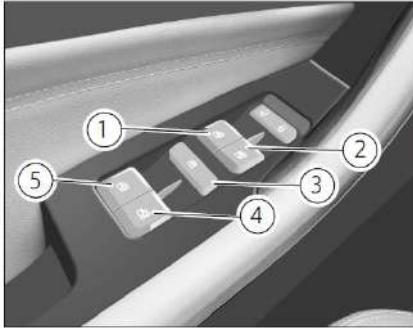

The electric window control switch is located at the door arm of the driver's side.

- ① Driver Side Window Lift Switch
- ② Front row passenger side window glass lift switch
- ③ Passenger Side Window Lift Ban Switch
- ④ Rear right window glass lift switch
- ⑤ Rear left window glass lift switch

Control of Driver Side Window

Pull the switch ① upward and keep it. The driver's side window glass rises and stops when he releases his hand.

Press down the switch ① and hold it. The driver's side window glass drops and stops immediately after releasing his hands.

If the switch ① is short pressed (release quickly after pressing the switch gently), the driver side window glass will automatically drop to the bottom. If the switch is activated during the automatic drop of the window glass, the window glass will remain in the current position.

If a vehicle with one key lift function is installed, the driver side window glass will automatically rise to the top after pulling up switch ①. If the driver touches the switch during the automatic lift process, the window glass will remain in the current position.

Driver's control of passenger side window lift

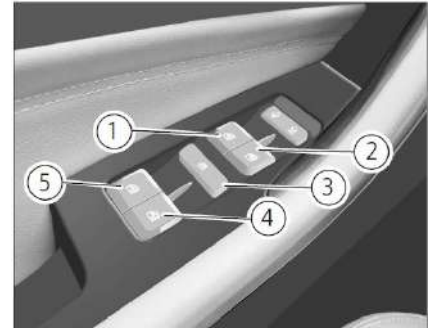

Driver's control of passenger side window lift: Pull up the switch ② ④ ⑤ and hold it. The corresponding window glass rises and stops when it is released. Press down the switch ② ④ ⑤ and hold it. The corresponding window glass drops and stops when it is released.

Passenger Side Window Lift Ban Switch

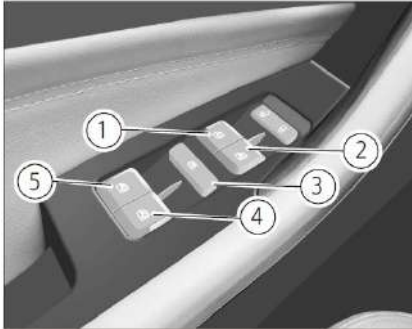

When the passenger side window lift ban switch ③ is pressed, the front and rear passenger side window glass lift switch will not be able to control the window glass lift. The driver side window lift switch can still control the window glass lift of each door. If the switch ③ is pressed again, the ban can be lifted. At this time, the switch will pop up.

Danger

- Don't leave children or people with mobility problems alone in the car! They may inadvertently touch switches or controllers, leading to serious accidents.
- Pay attention to closing the window glass to prevent it from pinching others.
- When there are children in the vehicle, when driving, the window lift ban switch should be pressed to prevent the children from opening the window on their own and causing accidents.

Passenger Side Window Control Switch





The electric window glass lift switch on the front passenger side and the rear passenger side is located on the armrest of the doors. The window glass lift switch can be controlled by pulling it up or pressing it down.

Panoramic sunroof *

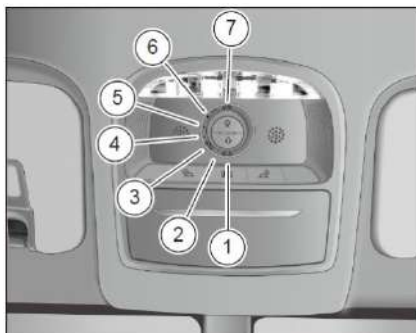
Panoramic sunroof switch



When the start/stop button is in "RUN" mode, the sunroof can be opened or closed by panoramic sunroof switch.

The sunroof switch has two buttons and knob switches, one is the sun shade closing button , the other is the sun shade opening button  and the other is the sunroof knob switch.

The opening and closing of the shade curtain can be realized by operating two buttons, and the opening, closing and warping of the sunroof can be realized by selecting 7 corresponding gears (as shown in the left picture) by operating the sunroof knob switch.

Panoramic sunroof sliding open/close

The start/stop button is in "RUN" mode. The sunroof knob switch is rotated to gear 3, gear 4, gear 5 and gear 6, and the sunroof automatically slides to the corresponding position of the switch gear.

Turn the sunroof knob switch to gear 7 and slide

the sunroof to full open position. If the glass moves from gear 6 to gear 7, the release switch bounces back from gear 7 to gear 6 again.

When the glass moves to gear 7, release the

switch from gear 7 to gear 6 without triggering new movement. The start/stop button is in RUN mode. Turn the sunroof knob switch to gear 1 and automatically close the sunroof.

Sunroof Anti-clip Function*

Anti-clip function can prevent large items from clipping when the sunroof is closed. When closing the sunroof, if the movement of the sunroof is blocked, the sunroof will stop closing and then slightly open.

When the sunroof is closed, if the anti-clip function is triggered, the sunroof will move in the open direction for a certain distance and stop moving.

Warning

- Sunroof anti-clip function can not prevent finger clipping.

 **Danger**

- Be careful when closing the sunroof. Make sure that no one is in the open and closed sunroofs to avoid serious injuries or injuries to others.
- The driver must close the sunroof when leaving the vehicle.
- The sunroof should not be operated when the temperature is very low (below – 20 degrees). In such an environment, it may not be able to activate the anti-clip function of the sunroof, thus causing accidents, and the low temperature will also cause some damage to the motor.
- In order to ensure traffic safety, the driver is forbidden to operate the sunroof switch during the driving process.



 **Danger**



- The sunroof may stop monitoring the obstacles in the position that is about to be completely closed. At this time, it does not have anti-pinch function.
- Don't try to activate the anti-clip function with your hands or a part of your body. Otherwise, it is very likely to cause serious harm to the body.

Turn on/off of warping ventilation

The start/stop button is in "RUN" mode. When the window is closed, rotate the sunroof knob switch to gear 2, raise the rear of the sunroof glass, tilt to the open position and stop automatically. The start/stop button is in "RUN" mode. Turn the sunroof knob switch to gear 1 and automatically close the sunroof.

Electric shade

The shade can be opened with the skylight. The start/stop button is in "RUN" mode. When the window is closed, press the button  to open the shade, and the shade opens automatically. In the process of opening the sunroof, press the button  to close the shade, and the sunroof will stop at the current position.

The start/stop button is in "RUN" mode. When the window is closed, press the shutter button , and the shutter closes automatically. In the process of opening the sunroof, press the shutter button , and the sunroof will stop at the current position.

Warning

- When the sunroof opens, do not close the sunroof shade forcibly.

Light combination switch

Models without automatic headlights

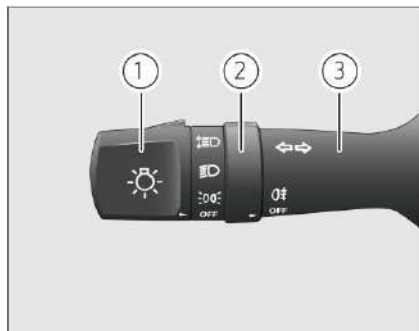

- ① Light control knob
- ② Fog lamp control knob
- ③ Light control lever

Models equipped with automatic headlights

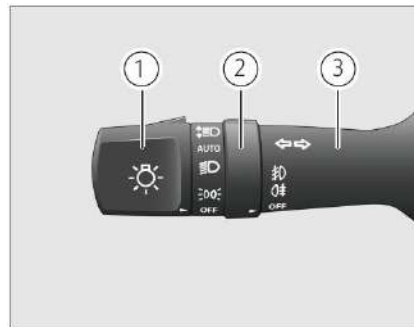



- ① Light control knob
- ② Fog lamp control knob
- ③ Light control lever

Light control

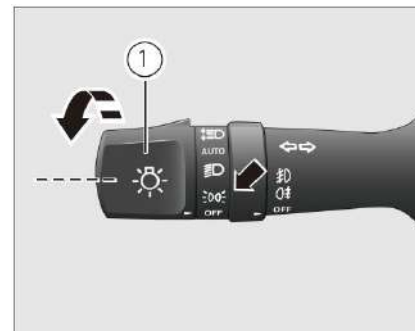

Position light

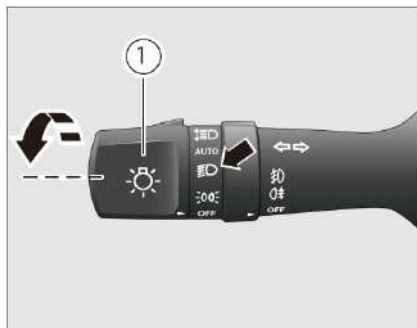

Turn the light control knob 1 to align the mark  on the light control knob with the  position. The front and rear position lights, the rear license plate lights, the key backlights and the position lights on the combination instrument will be turned off when turning back to the OFF position.

Headlight



When the start / stop button is in the "run" mode, turn the light control knob to make the mark  on the light control knob ① align with the position , the headlamp will be on, and turn it back to the off position to turn it off.





Notice

- When the low beam light is on, push the light control lever outwards from the vertical steering wheel plane to turn on the high beam light, and pull the light control lever toward the steering wheel plane again to turn off the high beam light.

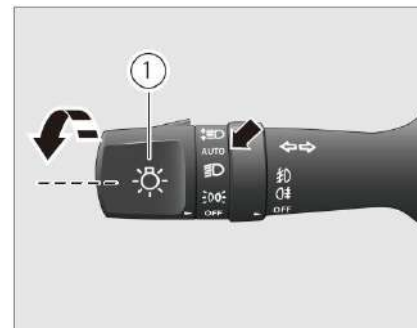
Headlights turn on automatically *



When the keyless start / stop button is in the "run" mode, turn the light control knob ① to make the mark  on the light control knob align with the  position. When the light outside the vehicle is dark (such as at night or driving through the tunnel, etc.), the headlight will automatically light up and turn back to the  position to turn off.

Notice

In wet or cold weather conditions, or when the vehicle is exposed to rain or after washing the car, the inner surface of the lampshade may appear tiny water drops, water mist, white fog or frost phenomenon:

- This situation is due to the condensation of water vapor in the high temperature air in the lamp when it is cold, which does not affect the normal use of the vehicle.
- When the vehicle is parked in a dry environment, turn off the engine, turn on the water vapor of the lamp will gradually evaporate, and the fog on the inner surface of the lamp shade will dissipate, or there may be residues only in the non functional areas such as the corner of the lamp.
- This phenomenon will not affect the service life and lighting effect of the vehicle lighting device. You do not need to replace the lamp assembly.

High beam warning



Pull the light control lever towards the steering wheel plane, and the high beam light will be on. When released, the light control lever will spring back automatically, and the high beam light will go out to warn the vehicles and pedestrians ahead.

Turn signal lamp

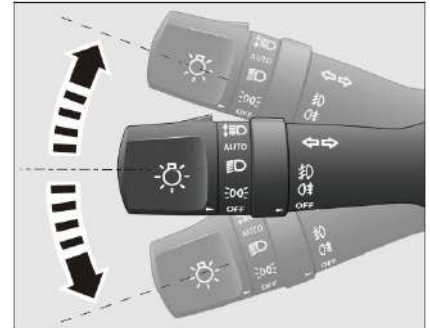

Move the light control lever all the way down, the external left turn light and the left turn indicator light in the instrument cluster flash, accompanied by a tick.

Move the light control lever up all the way, and the right turn indicator light in the external right turn indicator light and the instrument cluster will flash, accompanied by a tick prompt sound.

When the steering is completed, the control lever will automatically return to its position with the steering wheel returning to the normal position, and the external steering light and the steering indicator light in the instrument cluster will go out.

Lane change flashing signal

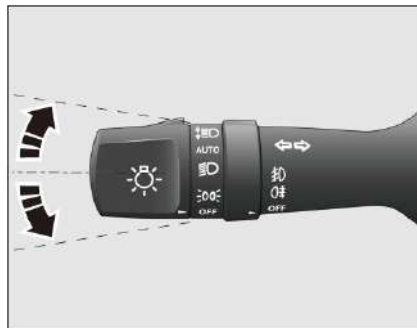

Move the light control lever down or up but not beyond the limit point, the lever will automatically return to its position after releasing, and the corresponding external turn light and the turn indicator on the instrument cluster will flash for three times at the same time, accompanied by a tick prompt.



Warning



- When the steering or lane change is completed, please confirm that the light control lever has been reset, otherwise, it should be manually reset.

Front fog lamp control *



When the start / stop button is in "run" mode, turn the fog lamp control knob to realize different mode control of fog lamp:

When the fog lamp control knob ① is turned to the off position, the front and rear fog lamps are turned off.



When the light control knob is in position , turn the fog lamp control knob to position  and the front fog lamp will be on. When the knob is turned back to the off position, the front fog lamp is turned off.

Rear fog lamp control



When the start / stop button is in "run" mode, turn the fog lamp control knob to realize different mode control of fog lamp:

When the fog lamp control knob ① is turned to the off position, the front and rear fog lamps are turned off.

When the light control knob is in position  or position , turn the fog lamp control knob to position  and the rear fog lamp will be on. When the knob is turned back to the off position, the rear fog lamp turns off.

Warning

- The fog lamp needs to be turned on only in rainy, foggy and snowy weather or when the visibility is poor.

Headlamp height manual adjustment



The angle of low beam is affected by the weight distribution of passengers and luggage inside the vehicle. By adjusting the height of the headlamp to ensure that the angle of low beam on the road surface can provide sufficient lighting for the front of the vehicle and will not cause dizziness to other road users.

Using the following road conditions as a reference, adjust the light height of the headlamp by turning the headlamp height adjustment switch: (position indicated by arrow in the figure)

Position "0" for the driver or driver and front passenger (without luggage).
Position "1" for all seats fully loaded.
Position "2" for full load of all seats and uniformly distributed load of the trunk (up to the permissible axle load of the rear axle and not exceeding the maximum permissible laden mass).
Position "3" for the driver and uniformly distributed load in the trunk (up to the permissible axle load of the rear axle and not exceeding the maximum permissible laden mass).

Auxiliary lighting for curve *

In the driving process, when the headlamp is on, and the driver turns the steering wheel to turn or turns on the steering lamp (reaching a certain angle), the front fog lamp on the corresponding side will be on to help the driving vehicle illuminate the blind area of the curve road.

When the steering wheel is back to normal or the steering lamp is turned off, the auxiliary lamp on the corresponding side will be off.

Backlight brightness adjustment



The backlight brightness adjusting knob  is located on the multifunction switch panel on the lower left side of the instrument panel.

When the position light is on, the backlight of each key of the instrument and the vehicle is on. When the backlight brightness adjustment button is pushed up, the backlight brightness of the instrument backlight and the buttons of the vehicle increases; when the backlight adjustment button is pushed down, the backlight brightness of the instrument backlight and the buttons of the vehicle decreases. The backlight brightness is 10 levels in total. When the backlight is adjusted, the current backlight brightness level will be displayed on the instrument cluster.

Hazard light switch



The hazard switch is located on the multimedia control panel.

In case of emergency, use hazard warning lights to remind other road users of their attention to avoid causing traffic accidents.

Turn on the hazard warning lights when:

1. When the vehicle breaks down due to technical failure.

2. When the vehicle is in a traffic jam and at the end of the convoy.

3. In case of emergency.

4. When towing another vehicle or being towed.

When the hazard switch is pressed down, all the turn signal lamps will flash at the same time and the two turn signal indicators in the instrument cluster will flash at the same time.

The hazard warning lamp will operate even when the start / stop button is in the off mode.

If you need to turn off the hazard lights, press the hazard light switch again.

Warning

- When the engine is not started, if there is no special need, do not turn on the hazard warning lamp for a long time to avoid battery power loss.

Emergency brake signal

When the vehicle speed exceeds 50km / h and emergency braking occurs, the brake light will flash;

When the vehicle speed exceeds 70km / h, emergency braking occurs and continues until the vehicle speed drops below 10km / h, the brake light flashes and the hazard warning light is automatically turned on. After that, if the brake is released and the vehicle accelerates to more than 20km / h, and the vehicle speed is maintained above 20km / h for more than 5 seconds, the hazard warning lamp will automatically turn off. It can also be turned off manually by operating the hazard switch.

Warning that the driving lights are not turned off







When the start / stop button is in the "off" mode, the light switch is in the position light or low beam light and the vehicle position light is on. When the driver's door is opened, the instrument will give an alarm that the driving light is not off.

Interior light

Front reading light



- Press the switch  to turn on the driver's side reading lamp; press the switch  again after 10 minutes or within this time to turn off the reading lamp.
- Press the switch , the front passenger's side reading lamp will be on; after lighting for 10 minutes or pressing the switch  again within this time, the reading lamp will be off.

Function of door open light on

Pressing switch a will open the function of door open light on.

When the start / stop button is in the "run" mode, open any door, and the front reading lamp will be on.



After all the doors are closed, the front reading lamp will gradually go out. If any door is not closed, the front reading lamp will stay on for about 30

seconds and then go out. When the start / stop button is not in the "run" mode, the front reading lamp will be on after any door is unlocked.

After all doors are locked, the front reading lamp will turn off gradually. If any door is not locked, the front reading lamp will stay on for about 30 seconds and then turn off.

Front reading light (with sunroof switch)*



- Press the switch - arrow - to turn on the front reading light. Press the switch - arrow - again to turn it off.
- When the switch  is not pressed, the ceiling lamp will automatically light up after the door is opened, and will continue to light out for about 3 seconds after the door is closed. The interior lighting has a power saving mode, and will automatically go out after lighting up for about 10 minutes at most.
- When the switch  is pressed, the door open dome lamp will not light up automatically.

Rear ceiling light *

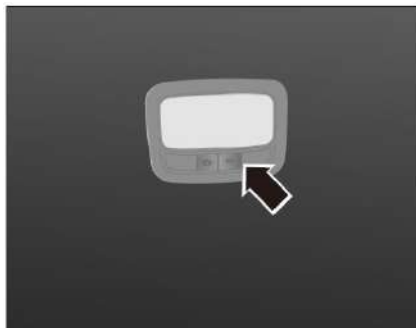

- Press the switch - arrow - to turn on the rear dome light. Press the switch - arrow - again to turn it off.
- After pressing this switch , the ceiling lamp will automatically light up after the door is opened, and will continue to light out for about 3 seconds after the door is closed. The interior lighting has a power saving mode, and will automatically turn off after lighting up for about 10 minutes at most.

Rear light *

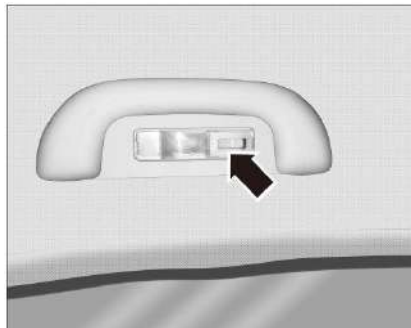

- Press the lampshade - arrow - to turn on the rear ceiling light. Press the lampshade - arrow - again and turn it off.

Trunk light

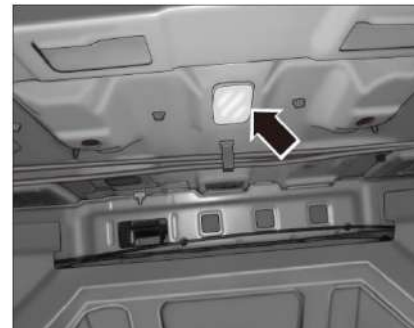

When the trunk cover is opened, the trunk light will be on automatically. When the trunk cover is closed, the light will be off automatically.

Warning

- When the engine is not started, do not turn on the interior lights for a long time to avoid battery power loss.

Wiper combination switch

Wiper combination switch (without rain sensor)

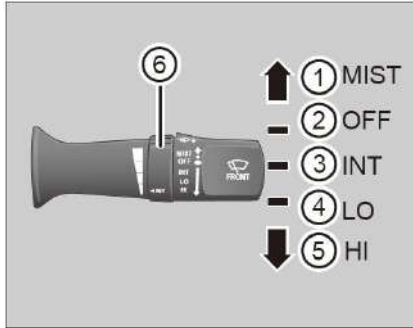

- ①MIST: Single wiper
- ②OFF: Stop
- ③INT: Intermittent wiper
- ④LO: Low speed wiper
- ⑤HI: High speed wiper
- ⑥Intermittent time adjustment knob

When the start / stop button is in the "run" mode, the wipers and washers can work. If the start / stop button is not in the "run" mode during the action of the wiper, the wiper will stop immediately and return to the initial position when it is in the "run" mode the next time. If you want to select a gear, push or press the lever up or down:

MIST:When the wiper control lever is turned to "mist" position and released, the wiper control lever will automatically jump back to "off" position. At this time, the front wiper wipes at a low speed once. When the wiper control lever is set to "mist" and held, the front wiper will continue to wipe until it is released.

OFF: The wipers do not work.

INT: The front wiper is in intermittent wiping state.

LO: The front wiper wipes slowly.

HI: The front wiper wipes quickly.

Intermittent time adjustment knob: rotate this knob to adjust the intermittent time of the front wiper. The intermission time is divided into four levels. Rotate the knob up to the highest level of 4 (the shortest intermission time), rotate the knob down to the lowest level of 1 (the longest intermission time), and the middle position is level 3 and level 2 in turn.

Warning

- When the windshield is dry, water shall be sprayed first, and then the windshield shall be wiped. It is forbidden to wipe the windshield without water.
- In case of low temperature, make sure that the wiper blade is not frozen on the windshield.
- In winter, the snow and ice on the wiper arm and wiper blade shall be removed in time, including the area involved in wiper operation.

Wiper combination switch (with rain sensor)

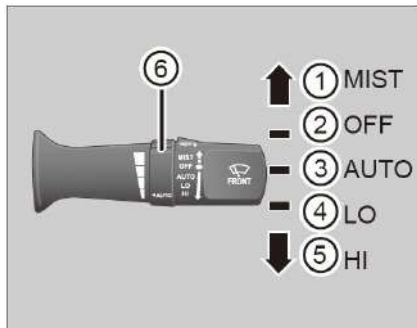

- ①MIST: Single wiper
- ②OFF: Stop
- ③INT: Intermittent wiper
- ④LO: Low speed wiper
- ⑤HI: High speed wiper
- ⑥ Automatic wiper sensitivity adjustment knob

When the system senses the rain, the keyless start / stop button is in "run" and the wiper switch is in "auto" position, the windshield wiper will be turned on automatically, and the wiper speed will be changed according to the rainfall.

When the wiper control lever is in the "Lo" (low speed wipe) or "Hi" (high speed wipe) position, the front wiper will wipe at the set speed, and the auto sensing function will not work at this time.

Warning

- Do not place the wiper control lever in the "auto" position when washing the car with the automatic car washer, otherwise the wiper may be damaged. Turn off the system when the wipers are not required.

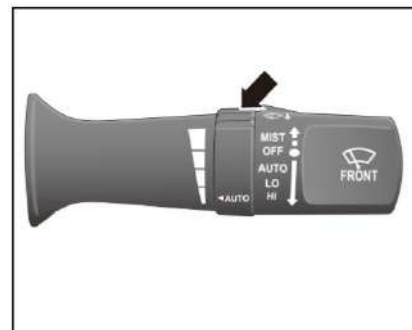

The automatic wiping speed of the system can be adjusted by turning the automatic wiping sensitivity adjusting knob.

The sensitivity is divided into four levels. Rotate the knob up to the highest level 4 (the fastest), rotate the knob down to the lowest level 1 (the slowest), and the order of the middle position is level 2 and level 3. Adjust the speed of the automatic wiper to meet your driving habits.

Rain / light sensor*



The rain / light sensor is located on the windshield near the inside rearview mirror. If the sensor is covered by mud, oil, dust, etc., the function of wiper "auto" and headlight automatic lighting may not work normally.

Windshield washing



When the start / stop button is in the "run" mode, move the wiper control lever towards the steering wheel, the washing motor will start to work, and the front windshield washing nozzle will spray water. Release it to stop spraying water, and the front wiper will stop automatically after several times of continuous brushing.

Move the wiper control lever towards the steering wheel and hold it, the washer will spray water continuously for up to 12 seconds, and then it will stop automatically.

Interior rearview mirror

Manual anti glare interior rearview mirror*

Before driving the vehicle, adjust the interior rearview mirror to obtain the best angle of view, and keep the interior rearview mirror clean.

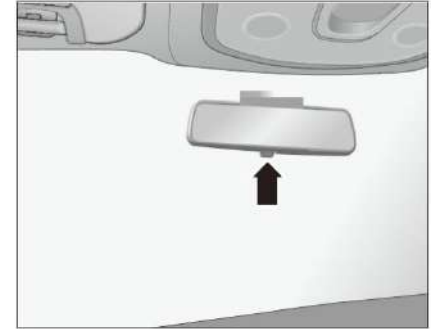

At night, move the paddle on the mirror base to the anti glare position. By adjusting the Interior rearview mirror, the glare caused by the rear vehicle light to the eyes can be reduced.

Automatic anti glare interior rearview mirror *



At night, the automatic anti glare interior rearview mirror can automatically adjust the color depth of the interior rearview mirror according to the intensity of the rear light, so as to reduce the glare caused by the rear vehicle light to the driver's eyes.



Warning

- To ensure the normal function of the anti glare sensor in front of and behind the interior rearview mirror, it is forbidden to touch or cover the sensor.
- In order to ensure driving safety, when adjusting the rear-view mirror, the "blind area" of the viewing angle should be minimized.
- The position of all rearview mirror should be adjusted before driving. Do not adjust the rearview mirror when driving.

Exterior rear-view mirror

The exterior rear-view mirror has the functions of electric adjustment, electric heating and electric folding.

Danger

- The object image reflected by the outside rearview mirror is smaller than the real situation. The actual distance between the object and the vehicle will be closer than it looks. Do not misestimate the distance from the vehicle behind to cause an accident.
- The position of the rearview mirror should be adjusted before driving. Do not adjust the rearview mirror when driving.

Outside rearview mirror lens angle adjustment





The exterior mirror adjustment switch is located on the multifunction switch on the lower left side of the instrument panel.

Select the exterior rear-view mirror to be adjusted, and move the selection switch ① to the left (left exterior rear-view mirror) or right (right exterior rear-view mirror) position.

Press the up or down adjustment key to adjust the up or down angle of the exterior rearview mirror; press the left or right adjustment key to adjust the left or right angle of the exterior rearview mirror.

Exterior mirror power fold *

Press the exterior rearview mirror fold switch  the exterior rearview mirrors on both sides will fold at the same time.

Press the exterior rear-view mirror open switch  the exterior rear-view mirrors on both sides will expand automatically at the same time.

After all the doors, engine hood and trunk cover are closed, press the key lock key, the exterior rearview mirror will fold automatically, and press the key unlock key, the exterior rear-view mirror will unfold automatically.

Notice

- If the outside rearview mirror frame is displaced due to external force, the rearview mirror must be fully folded by electric way, and the rearview mirror frame cannot be adjusted manually, otherwise the rearview mirror adjustment function will be affected.

Outside rearview mirror manual fold *



For the model with manual folding of exterior rearview mirror, pull the exterior rear-view mirror backward by hand to fold the exterior rear-view mirror on the side of the vehicle.

Warning

- It is forbidden to drive the vehicle with any exterior rearview mirror folded, which will reduce the judgment on the rear vehicles and obstacles, and may cause accidents!

Outside rearview mirror heating *



Start the engine, press the defrost / defog button  on the air conditioning panel, the indicator light on the button will be on, and the rear-view mirror and the rear-view windshield will start to heat for defrosting and defogging. After about 15 minutes, the system will turn off automatically. If heating is still needed, press the button again.

If you need to turn off the heating function in advance during heating, press the defrost / demist button  of the rear windshield again.

Notice

- The exterior rear-view mirror and windshield heating can only work when the engine is running.

Warning

- Do not turn on the heating function of the rear-view mirror without special necessity, so as to avoid overheating of the exterior rear-view mirror and the rear-view windshield and waste of battery power.

Sun visor

Turn the sun visor down



Both the driver side sun visor and the front passenger side sun visor can be turned down from their respective supports to block the sunlight from the windshield.

Turn the sun visor sideways

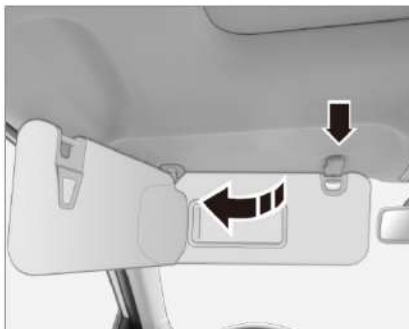

First, turn down the sun visor, then release the hinge on the right side of the sun visor from the buckle, and then turn the sun visor to the window glass to block the sunlight from the side of the door.

Danger

- When driving, do not turn the sun visor sideways to avoid danger.

Vanity mirror



Use the vanity mirror by sliding the vanity mirror cover on the sun visor to the right.

Danger

- When driving the vehicle, it is forbidden to use the vanity mirror. Front row passengers should also not use vanity mirror when driving, so as to avoid injury during emergency braking or collision.

Seat

Proper seat adjustment ensures that the seatbelt and airbag system are fully protected.

Danger

- It is forbidden to adjust the driver's seat in the process of driving, so as to prevent the driver from losing control of the vehicle due to the movement of the seat, resulting in serious accidents.
- Do not place items under the manually adjusted seat, otherwise these items may accidentally push the seat adjustment lever upward, and the seat will suddenly move, causing the vehicle to lose control during driving. Objects placed under the driver's seat may also hinder the operation of the brake pedal, leading to serious accidents.
- When adjusting the seat, pay attention to the personnel or objects behind the seat to avoid personal injury or damage.

Warning

- After the seat position is adjusted, try to move the seat cushion and backrest forward and backward to ensure the seat is locked reliably.

Notice

- When measuring the depth of the seat cushion, the seat position is the design position: the backrest angle is 25° , and the front and rear positions are to adjust the seat to the last position, and then slide the seat forward for 20 mm.
- Front row: the maximum adjustment angle of the seat back is $(76 \pm 4)^\circ$ and it can be turned forward $(24 \pm 2)^\circ$ and backward $(52 \pm 2)^\circ$ at the design position.
- Rear row: the rear row is an integral backrest with an angle of $(28 \pm 2)^\circ$ and cannot be turned over.

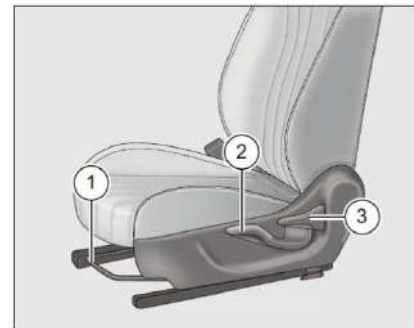

Seat adjustment:

Pull up the adjusting rod ① under the front of the seat and move the seat back and forth to a proper position; release the adjusting rod ① and move the seat back and forth slightly until the seat is locked reliably.

Seat cushion adjustment *:

Pull up the adjusting handle ② to raise the seat cushion; Pull down the adjusting handle ② to lower the seat cushion.

Driver's seat manual adjustment

Driver's seat electric adjustment*

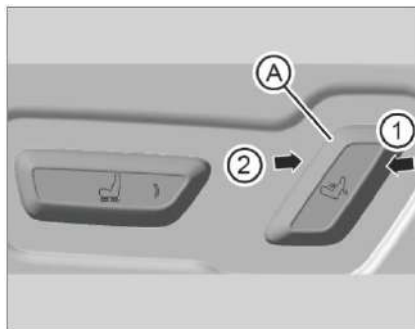

Switch A:

Press the switch a in all directions indicated by

the arrow to adjust the seat back.

Direction ① seat back inclines forward;

direction ② seat back inclines backward.



Switch B:

Press the switch in all directions indicated by A C the arrow to adjust the seat.

Direction ① . The seat is adjusted backwards as a whole.

Direction ② seat overall upward adjustment;

Direction ③ . The seat is adjusted forward as a whole.

Direction ④ seat overall downward adjustment.

Front passenger seat manual adjustment

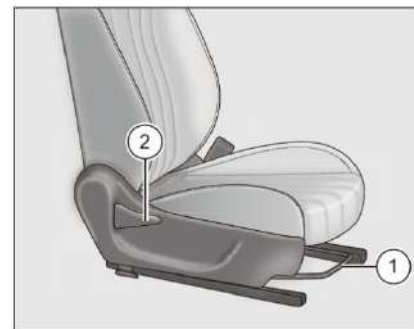

Seat adjustment:

Pull up the adjusting rod ① under the front of the seat and move the seat back and forth to a proper position; release the adjusting rod ① and move the seat back and forth slightly until the seat is locked reliably.

Backrest recline adjustment:

Pull up the adjusting handle ②, and at the same time, shake the seat back forward and backward to a proper angle; release the adjusting handle ②, and slightly shake the backrest forward and backward until the backrest is reliably locked.

Seat headrest adjustment

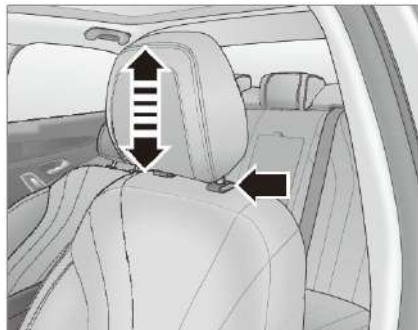

Front seat headrest adjustment:

In order to ensure safety and comfort, please adjust the headrest to the proper position before driving the vehicle.

Move up: grasp both sides of the headrest, lift the headrest vertically and move it to the required position.

Move down: first press and hold the locking button, then move the headrest vertically downward, move it to the required position, and release the locking button.



Rear seat headrest adjustment:

In order to ensure safety and comfort, please adjust the headrest to the proper position before driving the vehicle.

Move up: grasp both sides of the headrest, lift the headrest vertically and move it to the required position.

Move down: first press and hold the locking button, then move the headrest vertically downward, move it to the required position, and release the locking button.

Notice

- If it is necessary to remove the headrest, press and hold the locking button, and take out the headrest completely.

Danger

- It is forbidden to remove the headrest for driving, otherwise serious injury will be caused in the event of an accident.
- After installing the headrest, the headrest position must be adjusted correctly according to the height to obtain effective protection.
- In order to ensure a good view of the interior rearview mirror, the headrest of the rear seat can be adjusted to the lowest position at ordinary times. When there are people in the back row, the headrest must be adjusted upward to a proper position.

Seat heating *



Press the seat heating button, the seat heating function is activated, and the seat heating is divided into three gears. Select the seat heating gear and turn off the seat heating function by briefly pressing the seat heating button.

Storage device

Danger

- It is forbidden to place inflammables and explosives in the vehicle. For example, gas lighter, spare gasoline, alcohol, beer, etc. Especially in hot summer, the temperature in the car is very high, which will cause explosion of sealed containers or fire.
- There are relative movements between metal parts in many positions of the vehicle. Do not leave dangerous goods such as gas lighter on the seat slide, engine compartment, etc. Once the dangerous goods are squeezed and broken, it may cause explosion or even fire accident, causing serious damage to life or property.
- It is forbidden to use lighters to provide lighting in the storage area.

Storage box on the interior trim panel of the driver's door

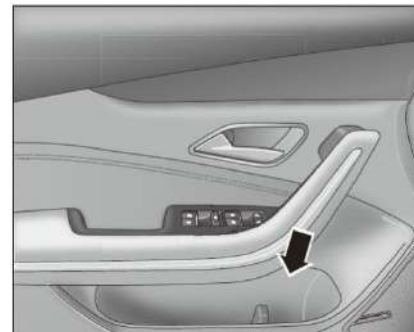

The storage box on the interior trim panel of the driver's door can be used to store beverage bottles and other items. The position of the storage box on the interior trim panel of other doors is basically the same.

Glove box



Warning

- When storing the liquid container in the glove box, the sealing cover shall be tightened to avoid the damage of vehicle electrical appliances caused by liquid outflow.
- Close the glove box cover when driving to avoid personal injury in case of emergency braking or accident.

Front center armrest inner storage box



Press the switch on the center armrest to open the center armrest storage box.

Cup holder with emergency start mark



There are two cup holders at the back of the shift handle, which can be used to place beverage bottles or sealed tea cups.

Danger

- This cup holder is forbidden to be used as an ashtray, which may cause fire.

Storage tank, 12V power outlet, USB interface



A storage tank is arranged in front of the gearshift lever, which can place bills, cards and other small objects.

12V power outlet: remove the plug cover of the power outlet, and then use the vehicle power plug to power through the power outlet.

Vehicle machine interconnection interface: used for vehicle machine interconnection.
USB interface: used to connect USB devices. These interfaces are powered only when the keyless start / stop key is in "ACC" or "run" mode.

Warning

- When the engine is not started, long-time power supply shall be avoided to avoid battery power loss.

Danger

- It is forbidden to use electrical equipment exceeding the maximum power allowed to avoid vehicle failure or serious accident.
- If the connected electrical equipment is overheated, it shall be closed immediately and the plug shall be pulled out from the power outlet to avoid fire.
- Do not let children play with the electrical outlet and the electrical equipment connected with the outlet, so as to avoid accidents.
- After use, cover the protective cover of power socket in time to prevent foreign matters falling into it and causing danger.

Glasses box



In the closed state, press the back of the glasses box to eject automatically. Push the glasses box up until you hear a "click" sound, and then close the glasses box.

Warning

- Only light items such as glasses are allowed to be placed in the glasses box, and other heavier items such as mobile phones are not allowed to be placed.

USB connector at the back of the central armrest box



The USB interface is located at the back of the central armrest box, which only supports USB charging function and does not support multimedia playback.

⚠ Danger

- Improper use of power socket and electrical equipment may cause fire and serious injury.
- Do not leave children in the car alone. When the start / stop button is turned on, children may misuse the socket and connect electrical equipment with it. If the connected electrical equipment is overheated, immediately turn off the electrical equipment and unplug the plug from the socket.

Rear seat center armrest (with cup holder)

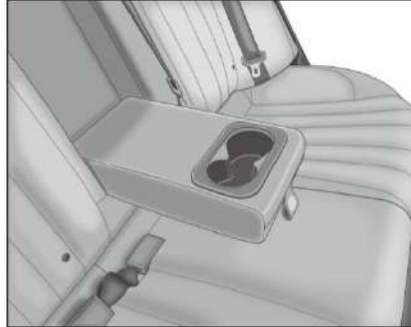

Pull down the center armrest of the seat to open the center armrest of the rear seat. When turning back the center armrest, push it into the back of the rear seat.

Front seat back storage bag



The storage bag behind the front seat backrest can be used to place some light and soft items, such as newspapers, etc.

👁 Warning

- If too thick objects are placed, it is easy to affect the comfort of rear passengers, and may cause irrecoverable deformation of the storage bag.

Air conditioning system

The vehicle air conditioning system is a device which can cool, dehumidify, heat, change air and purify the air in the vehicle.

The air conditioner can only work when the engine and blower are running. In order to achieve better air conditioning effect, keep the windows and sunroof closed when using the air conditioner.

When the air conditioning system is running, it will increase the extra load and fuel consumption of the engine. Turn it off when the air conditioning is not needed.

If the ambient humidity is high, when the air conditioning system is turned on, the windshield may be slightly fogged, which is a normal phenomenon. After the air conditioning system operates for a period of time, the fogging phenomenon will disappear. When the blower is off or the temperature is close to zero, the air conditioner cannot be cooled.

Notice

- In order to keep the air conditioning system in good condition, it should be ensured that the air conditioning system operates for a period of time at least every week (even in cold winter).
- Keep the air inlet outside the air conditioning vehicle under the front of the windshield clean and unblocked to ensure that the air inlet outside the air conditioning system is normal.
- In summer, when the vehicle is exposed to the sun, the temperature in the vehicle will be very high. Opening the window and sunroof for ventilation in a short time can help reduce the temperature in the vehicle quickly.
- When the air conditioning system is cooling, water stains may be left on the ground under the vehicle, which is a normal phenomenon.

Air conditioning control panel



1. Air volume adjustment knob
2. Temperature adjusting knob
3. Air purification system button
4. Air conditioner on / off key (A / C key)
5. Rear windshield defrosting and defogging button
6. Internal and external circulation switch key
7. Mode switch key
8. Windshield defrosting and defogging button
9. Fully automatic operation key (auto key)
10. System off key(OFF key)

1. Air volume adjustment knob

Turn the knob clockwise to increase the air speed at the air outlet.

Turn the knob anticlockwise to reduce the air speed at the air outlet.

2. Temperature adjustment knob This key can adjust the temperature of the air outlet. Turn the knob clockwise to increase the temperature, and turn the knob anticlockwise to decrease the temperature.

3. Air purification system button Operate the air purification button to turn on / off the air purification system

4. Air conditioning system on / off key (A / C key) Press the air conditioning system on / off key (A / C) and the display will show that AC is on. When the key is pressed again, the display shows that AC is off.

When the system is in the fully automatic operation mode, press this key to exit the automatic operation state of the air conditioning system. Only press the fully automatic operation key again, the air conditioning system will resume automatic operation.

5. Rear windshield defrosting and defogging button Press the rear windshield defrost button to turn the rear windshield heater on / off. After pressing the defrosting button of the rear windshield, the computer on the vehicle body will open it for about 15 minutes and then close it, or directly press the button again to close it manually.

6. Internal and external circulation switch key When the indicator light is on, it indicates internal circulation mode; when the indicator light is off, it indicates external circulation mode. After pressing the internal and external circulation switch key, the system switches the circulation mode (if it is internal circulation before pressing, it will switch to external circulation after pressing; and vice versa).

7. Mode switch key

Press the key, mode cycle switching sequence:

: Air flow to face.

: The air blows to the face and feet.

: The air blows to the feet.

: : The air blows forward to the windshield and feet.

During mode switching, in order to increase comfort, the air volume gradually reaches the set gear with mode switching.

8. Windshield defrosting and defogging button Press the windshield defrost button to enter the windshield defrost / demist mode. After the defrosting / demisting switch is turned on, the A / C cooling function will be turned on automatically, and the air volume will be adjusted to 5th gear automatically. It is recommended not to turn off a / C manually, otherwise the demisting efficiency will be affected.

9. Fully automatic operation key (auto key) Press the auto key to enter the automatic operation mode of the air conditioning system. At this time, the key indicator lights up and the air conditioning automatic mode has been turned on auto will appear on the display.

In the fully automatic operation mode, press any key in the mode switch key, air volume adjustment key, a / C key, internal / external circulation switch key, and windshield defrosting and defogging key, and the system will execute the key command to exit the auto state. When the screen cancels the icon, the key indicator light will go out. Other functions of the original automatic operation will continue to be automatically controlled by the system; press the rear windshield defrosting and defogging button and the temperature adjustment button, and the auto mode will continue to operate without being affected; press the off button, and the air conditioning system will stop running, and the controller will also close.

10. System off key(OFF key) When the air conditioning system is on, press the "OFF" key, the system will enter the standby state, in which only the air output mode and internal / external circulation icon will be displayed on the display. The corresponding functions can be operated through the mode switch key, and the system is still in standby mode. The rest of the function icons are turned off and not displayed.

Warm tip: during the demisting period, if you feel the temperature is low, you can adjust the air temperature by manually adjusting the air conditioning temperature adjustment button to ensure the comfort and demisting efficiency in the car.

Use air conditioning

Air conditioning can provide cooling, heating and dehumidification functions. Cooling can reduce the air conditioning temperature and remove the air humidity; heating can increase the air temperature. Air conditioning is only available when the engine and blower are running, keep the windows and sunroof closed when using air conditioning.

The operation of the air conditioning system will add extra load to the engine. Under extremely hot conditions, or when the engine needs to run at full load (such as climbing a long mountain road or driving in crowded traffic), the engine temperature will be higher. If the pointer in the engine coolant temperature gauge is close to the red area, turn off the air conditioning until the engine temperature returns to normal.

If the humidity is high, the window may be slightly fogged when the air conditioning system is turned on, which is normal. After a few seconds of operation of the air conditioning system, the mist will disappear.

Notice

- The air conditioning can only operate when the engine and blower are on. When the blower is off or the outside temperature is close to zero, the air conditioner will stop cooling.

Fast Cooling

Start the engine, turn on the air conditioner and adjust the temperature to reduce the key to the minimum limit position, the cold air is exported through the dashboard vent; adjust the air volume to the maximum limit position, open the maximum speed of the blower and open the air internal circulation (which can prevent the outdoor temperature and hot air from entering the interior of the vehicle). Once the internal refrigeration is completed, close the internal air circulation, and then reset the air volume as needed.

Fast Heating

Start the engine, turn on the air conditioner and adjust the temperature to the maximum, hot air is exported through the lower vent; the heating system heats the air through the heat transfer between the engine coolant and the cab air, so the heating system only works effectively when the engine is running

Reduce Humidity

Air conditioning can reduce the humidity of the air in the car and quickly defog the windows in humid environment.

Cooperating with the director, it can also health and try the air insight the vice.

This setting is suitable for most driving conditions when the external temperature is above zero. After turning on the air conditioner, display and adjust the temperature control and the air outlet speed as required.

Note

- In high temperature climate, if the temperature inside the vehicle is very high when the engine is started, the blower is set to the highest speed and the windows and sunroof are opened before the air conditioning is opened, and the air conditioning mode is set to OSA, which can circulate and exchange the air inside the vehicle in a short time, which is conducive to rapidly reducing the temperature inside the vehicle.

Air Conditioning Pollen Filtration Function

Pollen filtering function can filter fresh air and indoor circulating air, effectively remove pollen and dust particles in the air, and provide clean air for cab crew

Air Conditioning Outlet



- ① Bilateral outlets
- ② Central outlet

Air Conditioner Maintenance

The air conditioning system is fully sealed. The main maintenance work of the system should only be done by qualified technical personnel.

To enable the system remains in its best state, the vehicle owner should make sure to operate the system for a short period of time each week (even in winter). When the engine is at normal operating temperature, start the air conditioner and keep it on for at least 10 minutes while driving the vehicle at a stable speed.

The extra moisture generated during the dehumidification process is drained outside by the system via the drainage pipe under the vehicle. This may cause water accumulation on the road surface when the vehicle is still. This is normal, and you don't need to worry about it.

Air Purification Function *

The air-conditioning system of some models integrates the air purification function. When the vehicle engine is started and the central control display screen is lit up, the air-conditioning interface of the central control display screen can display the PM2.5 concentration value and concentration level in the vehicle.

The air purifier and AQS functions can be turned on and off by clicking the virtual button on the display. The air purification function can use the air conditioning system to filter the air inside the vehicle to reduce the PM2.5 concentration. The AQS function can automatically switch the air inside and outside circulation mode according to the air quality inside and outside the vehicle, which can prevent the pollutants outside the vehicle from entering the vehicle and protect the inside of the vehicle. air quality.

Please refer to the separate manual for the specific method of use.

Central Air Outlet



Adjust the wind direction by adjusting the center air outlet on the top, bottom, left and right.

Left side air outlet, slide to the right to open the air outlet; slide to the left to close the air outlet.

Right side air outlet, slide to the left to open the air outlet; slide to the right to close the air outlet.

Left Air outlet



Adjust the wind direction on the left air outlet of the instrument panel by up, down, left and right.

The outlet can be opened by sliding to the right and closed by sliding to the left.

Right Air outlet



Adjust the wind direction on the right side of the dashboard to adjust the wind direction up, down, left, and right.

Slide to the left to open the air outlet; slide to the right to close the air outlet.

Rear Air Outlet



After the up, down, left, and right adjustments, the exhaust vents change the wind direction.

Left side air outlet, slide to the right to open the air outlet; slide to the left to close the air outlet.

Right side air outlet, slide to the left to open the air outlet; slide to the right to close the air outlet.

Navigation and multimedia audio system



Some models are equipped with navigation functions and multimedia sound systems. Please refer to the separate manual for the specific method of use.

Speed Sensing Sound Compensation System

When a vehicle is running at high speed, the background noise will increase with the increase of the speed. The speed perception sound compensation system will dynamically adjust the volume of entertainment sound source according to the speed of the vehicle, so as to ensure that the driver's hearing remains in a good state.

Digital Video Recorder *

Digital Video Recorder (DVR) The driving recorder is a driving information recording system for automobiles. The main function is to collect the video information in front of the vehicle during use, and to record through the built-in microphone, and store the audio and video information in the memory card to provide evidence for driving.

TF (micro SD) Card

Driving video recorder has no integrated storage device, it needs to insert TF card alone to work normally, otherwise it has no recording function. The installation position of TF card is on the left side of the inner rearview mirror shield. The insertion direction is shown in the following figure.

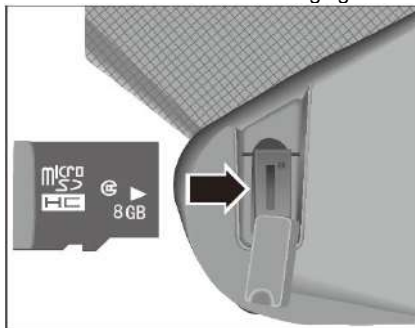

TF Card Specification Requirements

Because DVR stores data at high speed for a long time, in order to ensure the performance and reliability of DVR and safeguard your personal rights and interests, it is necessary to use TF cards with normal brand storage capacity of 8-128GB and transmission grade of class10 or above.

Storage time (1080P) :

| | | | | |
|----------------------|-------|-------|-------|------|
| Memory Card Capacity | 64G B | 32G B | 16G B | 8G B |
| Storage time | 8h | 4h | 2h | 1h |

Note

- The above storage time is for reference only. The actual storage time will be different according to the brightness and complexity of the scene.
- Please insert the TF card exactly as shown in the figure, otherwise the DVR will be damaged!

Note

- All functions of DVR are realized on the basis of equipping TF cards with correct specifications. If you do not use TF cards as required, the system may not work properly and lead to system failure.
- Because TF card is consumable and has many fault conditions, the system will only mention typical fault conditions, which can not cover all fault conditions. During the use, the driver has the responsibility to confirm whether DVR works properly.
- DVR supports hot-swap TF card, but hot-swap will cause the loss of recording content in the current period. To ensure the integrity of the video, it is recommended to use the "SD card removal" button in the APP setting option to safely remove the SD card.

Enter DVR System

Users can operate DVR through App, a locomotive travel recorder.



View Real-time Screen

Click the DVR icon to enter the main interface of the digital video recorder app, and the system automatically plays the real-time screen.

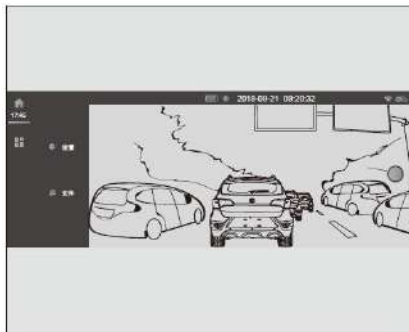

Note

- In order to ensure driving safety, the DVR interface will automatically exit after the speed exceeds 15 Km/h, and the DVR will remain in the recording state before the exit.
- DVR and locomotive transmit video through WiFi mode. Due to transmission rate limitation, the real-time picture delay of locomotive is a normal phenomenon, which will not affect the quality of video recording. Do not use this as a reference when driving. Please take the actual road conditions as the criterion.
- If the WIFI signal is disturbed, the real-time picture may have some phenomena such as carton and flower screen, but it will not affect the quality of recorded video.
- Under extreme conditions (higher ambient humidity and greater temperature difference), the lens of the driving recorder may fog, which is a normal phenomenon. The fog of the endoscope head will dissipate automatically one hour after the environment returns to normal.

Video and recording

In order to ensure your rights and privacy, DVR will turn on the recording function and turn off the recording function by default when it leaves the factory. You can set its status by setting the recording and recording options in the interface.



Video recording time: DVR video is recorded in segments, with 1 min, 3 min and 5 min for each segment. The default time is 3 min.

Recording resolution: DVR video resolution is 720p, 1080p optional, default clear 1080p.

Note

- To ensure your rights and interests, the DVR will turn on the circular recording function by default every time the vehicle is powered on. The circular video files are stored in the circular video folder. When the folder is full, the earliest video will be covered by the latest video.

Photography and Emergency Video

Photograph

Photography can be done by clicking on the 'Photo' button of the real-time display interface or the 'Photo' button  on the steering wheel

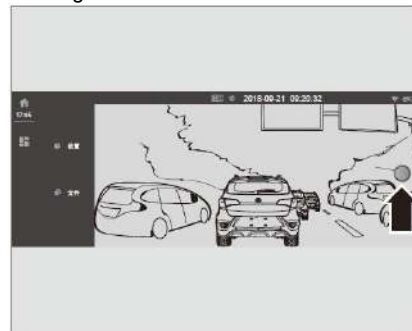

Emergency Recording

DVR has the function of automatic emergency recording. When the vehicle appears emergency braking, collision or severe yaw, DVR automatically triggers emergency recording. The system records 15 seconds before and after triggering time points, a total of 30 seconds of video, which is stored in the emergency recording folder. Users can also press the "one-click photo" button on the steering wheel (>1s) for emergency recording operation..

Note

- Traffic recorder does not support continuous shooting, and the interval of taking pictures should be more than 1s. When taking pictures, the "click" prompt sound will only be emitted when the volume of the audio-visual system is not zero.
- To ensure data security, the system will not automatically overwrite the 'Emergency Recording' folder, only support user manual operation. If this folder is full, the system will prompt the 'emergency recording' storage space is full, users need to clean up in time, otherwise this function can not be used.
- If the user does not turn on the recording function, only the last 15 seconds audio information of the emergency recorded 30s video file will be recorded.

View Files

Click on the "File" button of the real time interface to enter the file browsing interface. You can view emergency recording, circular recording and photo files. Long-click thumbnails can delete and save selected files..



Note

- The selected circular recording files can be moved to the emergency recording folder by the removal operation, so as to avoid being automatically overwritten by the system. The files in the emergency recording can only be deleted manually.

Set WiFi

WiFi password settings: DVR default password: 12345678, users can change to any other 8-32-bit password.

Note

- In order to ensure the security of video data, it is suggested to change the password as soon as possible.
- If you forget the modified WiFi password, you can reset the system through the locomotive < owner mode setting system resetting the password of the driving recorder > or you can go to an authorized BAIC dealership

Intelligent Vehicle System *

Some models are equipped with intelligent vehicle-borne systems that integrate satellite navigation, wireless Internet access, voice interaction, Bluetooth calls, network music, radio and network radio. For specific usage, please refer to separate instructions.

Diagnostic interface



The diagnostic interface is located at the bottom left of the dashboard.

The diagnostic interface is used for the digital communication between the vehicle electronic control unit and the diagnostic equipment, and the vehicle identification code information can be read through the diagnostic interface.

Danger

- This diagnostic interface is only used to connect the special diagnostic equipment of BAIC Motor Corporation. Do not connect other diagnostic equipment by yourself.

Microwave window

Without rear view mirror cover

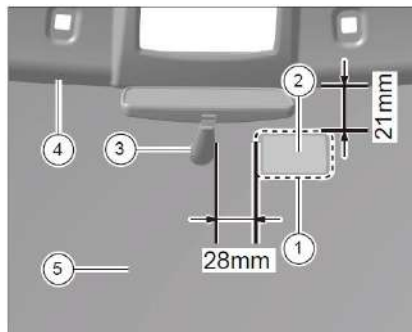

- ① Microwave window
- ② Electronic identification
- ③ Interior mirror base
- ④ Ceiling
- ⑤ Front windshield

The microwave window is located on the front windshield and is used to install the automobile electronic logo. Installation location does not allow film sticking, heating wire, etc., to ensure the effective reading of data.

Equipped with DVR model

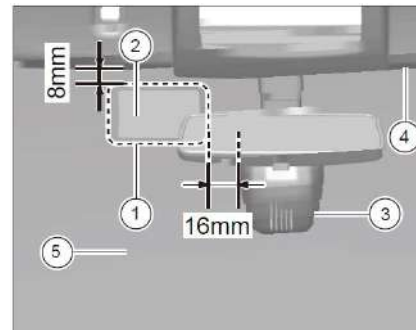

- ① Microwave window
- ② Electronic identification
- ③ Inside rearview mirror base shield
- ④ Ceiling
- ⑤ Front windshield

The microwave window is located on the front windshield and is used to install the automobile electronic logo. Installation location does not allow film sticking, heating wire, etc., to ensure the effective reading of data.

Equipped with AEB forward-looking camera model

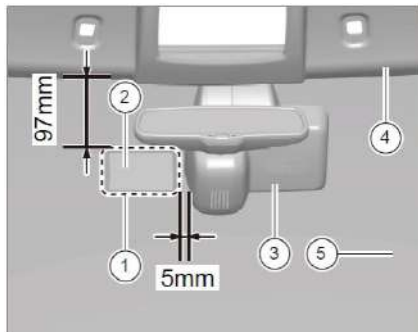

- ① Microwave window
- ② Electronic identification
- ③ Inside rearview mirror base shield
- ④ Ceiling
- ⑥ Front windshield

The microwave window is located on the front windshield and is used to install the automobile electronic logo. Installation location does not allow film sticking, heating wire, etc., to ensure the effective reading of data.

Accessories and retrofitting

Please be sure to contact an authorized BAIC dealership store before installing accessories or replacing parts. It is recommended that you always use accessories and parts approved by the company.

The improper modification will seriously damage the performance of vehicles and even cause serious accidents. For example:

- Installation of larger or smaller wheels will affect the normal operation of ABS and other systems.
- The modification of steering wheel and other safety facilities may cause system failure.
- In vehicles equipped with lateral curtain airbags, the installation of other accessories at the longitudinal beams on both sides of the roof will hinder the normal operation of the lateral curtain airbags.

Danger

- Improper attachment or modification may weaken the protective effect of the airbag system and even cause fatal injury.
- Attachment of the beverage cup holder, telephone holder, etc., on the cover of the airbag system or within the scope of the airbag system can cause serious personal injury when the airbag is deployed.
- The modification of the front of the vehicle may damage the pedestrian protection performance of the vehicle.
- Do not coat the bottom protective layer or anti corrosive material on the exhaust pipe, catalytic converter and heat insulation board to avoid affecting the heat dissipation.

It is forbidden to install other high-power electrical appliances besides the original vehicle configuration.

After installing high-power electrical appliances other than rated power, the wiring harness will be easily heated and short-circuited due to excessive load, which may cause fire.

The wiring harness should not be changed casually when installing the traveling recorder, navigation and DVD machine.

When wiring harness is installed, wiring with high internal resistance will generate high heat, which may cause fire.

Prohibit the use of high-power light bulbs

In order to make the lamp brighter and use more than the rated power of the bulb, the wiring harness load is too large and may lead to fire.

3. Driving guide

| | |
|---|-----|
| New car run-in..... | 134 |
| Precautions before driving..... | 135 |
| Start / stop button..... | 136 |
| Transmission..... | 141 |
| Parking safety precautions..... | 144 |
| Parking method..... | 145 |
| Electric power steering system..... | 146 |
| Braking System..... | 148 |
| Electric park brake (EPB)..... | 151 |
| ABS anti-lock brake system..... | 153 |
| EBD electronic brake force distribution system..... | 153 |
| Hill start assist..... | 153 |
| Hydraulic brake assist..... | 154 |
| Hydraulic brake assist..... | 154 |
| E SP electronic stability system..... | 154 |
| Set Cruise..... | 155 |
| Direct tire pressure monitoring system..... | 158 |
| Parking radar system..... | 160 |

| | |
|-----------------------------------|-----|
| Reversing Rear view System..... | 163 |
| Around View Monitor(AVM) * | 166 |
| Idle Stop-Start System * | 173 |
| security inspection..... | 176 |
| Driving in running-in period..... | 177 |

New car run-in

Precautions

In order to improve the service life of the vehicle, the new vehicle should be run-in at the initial stage of use before it can be used normally. The following are the rules for run-in period:

- run-in mileage is 1500km.
- Choose better roads and drive lightly.
- Do not exceed 80% of the maximum speed.
- Do not press the accelerator pedal to the bottom for fast acceleration.
- Avoid emergency braking within the initial 500 km.
- Strict implementation of operating procedures to maintain the normal working temperature of the engine. Carefully do the daily maintenance work of vehicles, check regularly, pay attention to the sound and temperature changes of each assembly in operation.

run-in engine

The engine can not only prolong service life, but also reduce fuel consumption after run-in as required. The new engine must be run-in at 1500 km, and the following regulations must be observed during the run-in period:

- Avoid engine running at high speed. Do not exceed 80% of the maximum speed.
- Do not tow other vehicles. From 1000 km to 1500km, the engine speed and vehicle speed can be gradually increased to the maximum allowable range.

At the beginning of run-in, the internal friction resistance of the engine is much greater than that after run-in. The oil consumption may be higher than normal. The engine oil should be checked regularly. All the moving parts of the engine can reach the best fit state after run-in.

run-in tires and brake linings

In the initial 500 km should be driven at a moderate speed, good run-in of new tyres. In the initial 500 km, the new brake lining and brake disc can not reach the optimal friction state, so emergency braking should be avoided and enough safe braking distance should be maintained.

Note

- If the vehicle has changed the engine or other transmission system parts, the run-in precautions should also be observed.

 **Danger**

- New tyres and brake pads that have not been run-in do not achieve the best adhesion and friction, so it is necessary to drive carefully within the first 500 km to avoid accidents.
- The new brake pad after replacement must also be run in according to the above requirements.
- When driving, keep a proper distance from other vehicles to prevent emergency braking. Because the tires and brake pads are not run in at this time, the adhesion and friction are insufficient, which is easy to cause traffic accidents.

Precautions before driving

Before driving, we should pay attention to the following points:

- Make sure all windows, exterior mirrors and exterior lights are clean.
- Check the condition of the tire and confirm that the tire pressure is normal.
- Check whether there is liquid leakage at the bottom of the vehicle.
- If you want to reverse, make sure there is no obstacle behind the vehicle.
- Regularly check the oil position (such as engine oil, engine coolant, brake fluid and windshield washer fluid).
- Close all doors.
- Adjust the seat to a proper position.
- Wear the seat belt.
- Adjust the interior and exterior rearview mirrors to proper positions.
- Confirm that all lights of the vehicle work normally.

- Confirm that the combination instrument works normally.
- when the start / stop button is in the "run" mode, whether the functions of each alarm lamp are normal.
- release the parking brake and confirm that the parking brake indicator is off.

Start / stop button

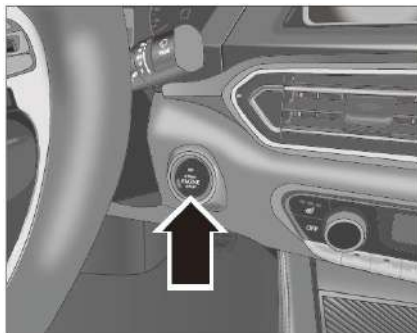

The start / stop button is located on the dashboard to the right of the steering wheel.

Power mode switching

Automatic transmission model: put the shift lever in P or n position, when the brake pedal is not pressed; manual transmission model: when the clutch pedal is not pressed; press the start / stop button, the power mode will be switched in the following order:

- When the key is not pressed: the start / stop key is off, which means "off" mode (the key backlight is not on);
- When pressing the key for the first time: turn on the "run" mode (the key background light is green), the instrument will be on, and all the electrical equipment will be in the on state;
- The second time you press the button, turn on the "ACC" mode (the button background light is red), and connect the radio, cigarette lighter and other accessories.
- The third time you press the button: return to "OFF" mode (the button background lights out). Press the start / stop button one by one to switch in three modes: "off" → "run" → "ACC".

Note

- Automatic transmission model: the shift lever is in P or n gear and the brake pedal must be pressed to start the engine.
- Manual transmission model: the clutch pedal must be pressed to start the engine. For safety reasons, it is strongly recommended to put the shift lever in the neutral position before starting the engine.
- Press the start / stop button to switch the engine start or power mode, but it must be ensured that the smart key is placed in the effective area that can be detected by the vehicle.

Start the engine

Start the engine with the start / stop key
When the smart key is in the effective detection range, the starting method of the vehicle equipped with start / stop function is as follows:

Manual transmission models:

- Press the clutch pedal to the bottom and hold it;
- Put the shift lever in neutral position;
- Press the start / stop button once to start the engine.

Automatic transmission models:

- Press the brake pedal to the bottom and hold it;
- Put the shift lever in P or n position;
- Press the start / stop button once to start the engine.

Model of manual transmission: start the engine when the start / stop button is in "off" mode. If the clutch pedal is not pressed at this time, the engine cannot be started.

"Please step on the clutch to start" will be displayed on the trip computer display of some models. (the specific configuration shall be subject to the actual vehicle)

Automatic transmission model: start the engine when the start / stop button is in "off" mode. If the brake pedal is not pressed at this time, the engine cannot be started.

"Please step on the brake to start" will be displayed on the trip computer display of some models. (the specific configuration shall be subject to the actual vehicle)

When the start / stop button is in "off" or "ACC" mode, start the engine, press the brake pedal, and press the start / stop button. If the gear is not in P or N at this time, the "please engage P or n gear to start" will be displayed on the display screen of the driving computer. The vehicle will not start, and the start / stop button will jump to "run" mode. When it is necessary to stop and turn off the engine, press the start / stop button to turn off the engine. If the gear is not in position P at this time, it will display "please switch to position P to stop" on the display screen of the trip computer for prompt. .



Smart key standby start function



If the vehicle is in a strong signal interference area, or the battery power of the smart key is insufficient, when you press the start / stop button to try to start the vehicle, you need to use the standby start function at this time.



Press the clutch pedal, the gear is in neutral (manual transmission model) or the brake pedal, the gear is in P or n (automatic transmission model), place the smart key in the cup holder with the emergency start mark, and press the start / stop button to start the engine.

Note

Application scope of standby start function:

- when the battery of smart key is insufficient and cannot be replaced in time.
- when the vehicle is in a strong signal interference area, use the standby start function to drive the vehicle out of the area, and the keyless start function can return to normal.

Note

- When the battery is low enough to start the engine, try to use a jumper cable to start the engine through the battery of another vehicle.

 **Danger**

- Do not run the engine for a long time in a place with poor ventilation or in a closed room. Because of the toxic gas in the exhaust gas of the engine, people may be comatose or even suffocate.
- Do not leave the vehicle unattended when the engine is running to avoid accidents.
- Do not start the engine by pushing or pulling the vehicle. This may lead to a collision accident. It may also cause the unburned gasoline to enter the catalytic converter and burn again, which may cause fire hazard.

 **Warning**

- If it is difficult to start the engine, the continuous running time of the starter shall not exceed 10 seconds each time the engine is started. If the engine cannot be started, the start operation must be stopped, and try to start again after waiting for about 30 seconds to avoid overheating damage of the starter and battery power loss.
- when the ambient temperature is $-10\text{ }^{\circ}\text{C}$ or lower, the engine starting time may increase. Because the starter needs to run for a longer time to overcome the greater running resistance and harsh combustion environment, all unnecessary electrical equipment should be shut down when starting.

Turn off the engine

Assemble the manual transmission vehicle to step on the clutch pedal, put the shift rod in neutral, apply parking brake, press the keyless start/stop button once, the engine will stall and release the clutch pedal. When assembling the automatic transmission, step on the brake pedal, stop the vehicle, place the shift lever in the N position, apply the parking brake, and then place the shift lever in the P position. Press the keyless start / stop button once, the engine will shut down and release the brake pedal.

 **Warning**

- The cooling fan may still be running for some time after the engine is off. When working in the engine compartment at this time, be careful to be injured by the fan.
- After heavy load operation, it is recommended to run the engine at idle speed for a few minutes before flameout, so that the cooling system can continue to work, so as to quickly reduce the temperature of the engine.

Method of emergency shut down

For vehicles equipped with start / stop buttons, when the engine fails to shut down normally, the emergency shutdown method can be used.

Press the clutch pedal or the brake pedal, press the keyless start / stop button twice in 2 seconds or press the start / stop button for more than 2 seconds to stop the engine.

 **Danger**

- Do not turn off the engine when driving! Otherwise, the vehicle may lose control and cause an accident.
- After the engine is shut down, the vacuum assistance does not work. It is necessary to step down the brake pedal with great force to slow down the vehicle.
- In case of an accident, the vehicle may have fuel leakage, the engine shall be shut down immediately to prevent fire.

Transmission

Automatic transmission models



Vehicle start and stop

1. Press the brake pedal to the bottom, put the shift lever in "P" or "n" position, and start the engine.
2. Step on the brake pedal, press and hold the lock button in front of the shift lever handle, place the shift lever in the "d" position, then release the brake pedal, slowly step on the accelerator pedal, the electronic parking will be released automatically, and the vehicle can start to drive. When parking, press the brake pedal, stop the vehicle, apply the parking brake, and place the shift lever in the "P" position.

Shift instructions

"P" (Park):

Used when parking or starting the engine. Before placing the shift lever in "P", make sure that the vehicle stops completely.

"R" gear (reverse gear):

Used when reversing. Before placing the shift lever in "R", make sure that the vehicle is completely stopped and the engine is idling.

When shifting from "P" to "R", the brake pedal must be pressed and the locking button in front of the shift handle must be pressed. When shifting into "R", the reversing light will be on automatically.

"N" gear (neutral):

When the vehicle needs to stop for a short time and the engine is idling (such as waiting for traffic lights), the gear can be placed in "n". When in the "n" position, the transmission is not locked. At this time, it is necessary to step on the brake pedal or apply the parking brake.

If it is necessary to shift the shift lever from "n" to "R", first step on the brake pedal to make the vehicle stop completely, then press the locking button in front of the shift lever handle to shift.

"D" gear (driving gear):

When the vehicle is driven forward, the transmission will automatically upshift or downshift according to the engine speed and vehicle speed.

"M" gear (manual mode):

CVT model: when the shift lever is in the "d" position, pull the shift lever to the left to the "m" position, when the transmission enters the manual mode, push the shift lever forward and backward to reduce the "m + or M -".

Hang down gear

1. Stop the vehicle stably.
2. Press the brake pedal and the lock button in front of the shift lever handle, and then put the shift lever into the "R" position.
3. After putting into gear, slowly release the brake pedal, and timely press the accelerator pedal, so that the vehicle can drive in reverse gear.

At this time:

- The reversing signal light is on.
- the rear view system will start automatically and display the reversing image in the multimedia display screen (applicable to some models).
- The parking radar is activated, and when it is close to the obstacle, it will give an alarm through different frequencies.

Danger

- During the driving process, do not suddenly switch the shift lever to the "R" or "P" position, the transmission may be damaged or even an accident.
- When driving, please do not put into "n" gear to slide.

Note

- According to the change of resistance (such as traction, climbing long slope, etc.), the vehicle will start the corresponding shift program, and provide more power to the vehicle by shifting into a lower gear. This prevents frequent gear changes.
- The speed of the cold engine is very high when it is just started, so before the engine warms up, please be careful when you put into "d" or "R" gear.
- When the vehicle stops, do not speed up the engine, otherwise it may cause the vehicle to move accidentally.
- Before starting the engine, please make sure that the gear is in "P" or "n", do not try to start the engine in other gears.
- When shifting the shift handle from "n" to other gears, please keep the engine at idle speed.

How to use automatic transmission

For drivers unfamiliar with vehicles with automatic transmission, the following information is particularly important.

Start-up

The engine can only be started when the shift lever is in "P" or "n" gear.

Before starting the engine, press the brake pedal. After selecting "d" or "R" gear, if the vehicle is stationary, do not let the engine run at high speed.

Always apply the parking brake until you are ready to drive the vehicle away, remember that once the drive gear is selected, the automatic vehicle will move forward or backward slowly.

Do not leave the vehicle stationary when the drive gear is selected and the engine is running (always select "n" if idle for a long time is required).

Manual transmission models *



| Manual transmission model gear description |
|--|
|--|

"1-6" gear (forward gear):

In upshift, shift from low gear to high gear in turn. When downshifting, shift from high gear to low gear.

"R" gear (reverse gear):

When reversing, put into this gear. Before putting into "R" gear, make sure that the vehicle has completely stopped and the gear is in idle running state.

Vehicle start and stop

1. Check and make sure that the gear is in neutral.
2. Press the clutch pedal all the way to start the engine.
3. Place the shift lever in "1" or reverse gear.
4. Slowly lift the clutch pedal, add oil properly, release the parking brake, and the vehicle can start.
5. When parking, depress the brake pedal to slow down the vehicle; downshift timely according to the vehicle speed. After the vehicle stops stably, apply the parking brake and place the shift lever in neutral.

 **Warning**

- The speed of the cold engine is very high when it is just started, so please be careful when putting into gear before the engine warms up.
- Do not step on the accelerator pedal when shifting the shift lever from neutral to other gears.
- When shifting, always press the clutch pedal to the bottom, and release the clutch pedal slowly after shifting to the next gear.
- When decelerating, additional braking force can be obtained from the engine by downshifting, which helps to maintain a safe speed and prevent the brake from overheating when going downhill.
- When driving, please do not slide in neutral.

Hang down gear

1. Stop the vehicle stably.
2. After depressing the clutch pedal for about 3-5 seconds, put the shift handle into the "R" position.
3. After putting into gear, slowly release the clutch pedal, and press the accelerator pedal to release the parking brake, so that the vehicle can drive in reverse gear.

At this time:

- The reversing signal light is on.
- The rear view system will start automatically and display the reversing image in the multimedia display screen (applicable to some optional models).
- The rear view system will start automatically and display the reversing image in the multimedia display screen (applicable to some optional models).

Parking safety precautions **Danger**

- Do not park the vehicle near inflammable or explosive materials to avoid fire.
- Do not park the vehicle near inflammable or explosive materials to avoid fire.
- Confirm that the parking brake is reliable.
- Always carry the vehicle key with you when you leave the vehicle. Otherwise, people who remain in the car may accidentally start the engine or electrical equipment, causing serious casualties.
- Never leave a child or someone who needs someone else's care in the car alone! Failure to do so may result in suffocation or inadvertent movement of the vehicle, resulting in a serious accident.

Danger

- It is strictly forbidden to leave the air conditioner or warm air in the vehicle for a long time while the vehicle is stopped and the engine is running. Otherwise, the vehicle may be poisoned and cause death.

Never park your vehicle on flammable materials such as dead leaves or hay, or high-temperature engines or exhaust pipes may ignite such flammable materials.

Also, do not step on the accelerator pedal for a long time while parking or stopping while the engine is running. Failure to do so may cause the engine or exhaust system to overheat and cause a fire.

Parking method

1. Stop the vehicle and apply the parking brake to confirm that the parking brake is reliable.
2. For automatic transmission models, place the shift lever in the "P" position; for manual transmission models, place the shift lever in the appropriate gear according to the safety requirements of the parking position (flat: neutral; uphill: 1 block) Downhill: reverse gear).
3. Check that all lights and electrical equipment are turned off, confirm that the sunroof (if equipped) and the window are closed, and turn off the engine.
4. Carry valuables, car keys, and lock all doors. When the anti-theft indicator on the meter flashes at a low frequency, the anti-theft system has been activated.
5. When parking on the ramp, to prevent the vehicle from entering the road when it is accidentally moving, turn the steering wheel as shown. Stop the wheel by applying a stop when parking on a steeper ramp.

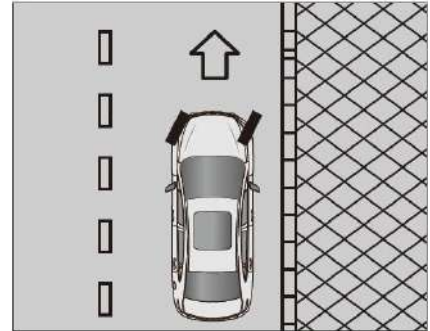

When parking on the downhill road with the road along the stone, turn the steering wheel to make the wheel face the direction of the road along the stone.

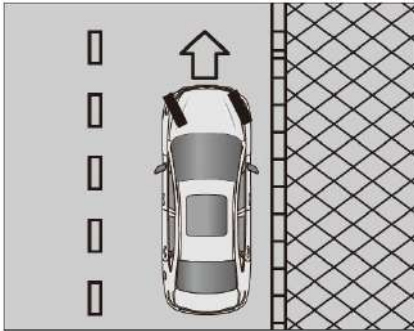

When parking on an uphill road with a curb, turn the steering wheel so that the wheels are away from the curb.

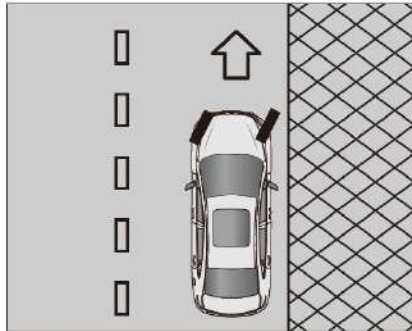



When the car is facing uphill or downhill and there is no curb, turn the steering wheel to make the wheel face the side of the road.

Electric power steering system

Instructions

Electric power steering system (EPS) can provide steering power under various driving conditions according to different vehicle speed and steering wheel torque in the process of vehicle steering, so as to reduce the disturbance to the steering system caused by uneven road surface. It can not only reduce the steering control force at low speed, but also greatly improve the handling stability at high speed.

When parking or driving at very low speed, if the steering wheel is operated continuously for many times, the EPS system will reduce the steering power to prevent the system from overheating and the operation of the steering wheel becomes more laborious. If you continue to operate like this, the electric power steering system will enter the overheat protection mode. At this time, the electric resistance steering fault alarm light will be on,  the power will be reduced, and the hand force will gradually increase. At this time, the steering should be stopped until the temperature decreases, and the power will be restored automatically.

When the engine is running, the electric power steering system fault warning light  is always on, indicating that the electric power steering system is not working properly. Please contact the authorized BAIC dealer to check the electric power steering system.



EPS self learning

The battery is disconnected for a long time, and the ESP system fault light is on . After reconnecting the power supply, the EPS will lose the active return function (which can improve the return performance of the steering wheel) and the soft stop function (which can reduce the impact feeling when the steering

wheel hits the bottom quickly). Carry out the EPS self-learning according to the following steps to restore the function:

1. Start the engine.
2. In the parking state, turn the steering wheel from the middle position to the left for 1 second, then to the right for 1 second, and then to the middle position;
3. Driving in a straight line at a speed greater than 30 km / h over 300 m;
4. Stop and stop the engine, restart the engine, complete EPS selflearning, and turn off the ESP fault light. 

Warning

- In case of steering system failure, please contact BAIC dealer immediately for inspection and maintenance. Even if you don't feel any difference in the steering process, there may be serious problems in the system, leading to steering failure and other situations.
- After the steering column and steering gear are replaced or the vehicle's four-wheel alignment is completed again, the EPS angle needs to be calibrated in the middle position, otherwise the vehicle will deviate and the return function will fail.

Braking System

The braking system mainly includes:

1. Four wheel disc brake, with good thermal stability.
2. Double circuit hydraulic system, if one oil circuit fails, the other oil circuit can still brake two wheels.
3. Vacuum booster, use engine vacuum to reduce brake pedal force.
4. Anti lock braking system (ABS) can still maintain good directional stability during emergency braking.
5. Electronic brake force distribution system (EBD) can automatically adjust the front and rear axle brake force distribution ratio to improve the braking efficiency.
6. Electronic stability system (ESP) can improve the driving stability of the vehicle.
7. Electronic parking brake (EPB) ensures reliable parking effect.

Warning

- When the vehicle is running normally, do not habitually put your foot on the brake pedal, which will cause the brake to overheat by unintentionally pressing the brake pedal, reduce the efficiency of the brake, shorten the service life of the brake pad, and increase the fuel consumption of the vehicle. If the brake light is always on, it will also cause the rear driver to misjudge the road conditions ahead.
- When going down a long slope, the continuous use of the brake will make it accumulate heat, thus reducing the efficiency of the brake. At this time, shift to a lower gear and use the engine to assist in braking. If you want to increase the braking force, do not brake continuously, but brake intermittently.

Warning

- After the vehicle wades through the water, it is necessary to check the braking effect, press the brake pedal moderately, and feel whether the braking is normal. If there is any abnormality, under the condition of ensuring safety, the brake pedal can be pressed frequently to dry the brake until it returns to normal.
- When driving, make sure to keep enough distance from other vehicles to ensure enough response time and a longer distance in case of emergency braking.
- Do not step on the brake pedal frequently, which will accelerate the wear of the brake pad.
- In the process of vehicle driving, if the engine is off, do not use multiple continuous snubs, which will reduce the vacuum degree of the vacuum booster. At this time, it is necessary to use a lot of force to continuously step on the brake pedal to make the vehicle slow down and stop.

Factors affecting braking effect

1. Wear

The wear of the brake pads depends to a great extent on the service conditions and driving mode, especially for those vehicles that often drive in urban traffic and short distance or in sports mode. Therefore, it is necessary to check the thickness of the brake pad within the specified time interval of maintenance.

2. Wet or salty roads

Wet road: when driving in ponding or heavy rain, or after washing the car, the brake disc and brake pad will be wet or frozen in winter, the braking efficiency will be reduced. Lightly press the brake pedal to dry the brake and restore the performance.

Road for sprinkling salt: when driving on the road for sprinkling salt, if the brake is not used for a long time, there will be salt layer on the brake disc and brake pad, and the braking efficiency will be reduced. Lightly press the brake pedal to remove the salt layer on the brake disc and brake pad.

3. Mountain Environment

Because of the high mountain and long slope in mountain environment, the brake has high frequency and long time, and often works continuously under high-intensity braking conditions, these factors will make the braking efficiency worse. Therefore, when the vehicle goes downhill, do not slide in neutral and avoid frequent braking. Try to use the low gear to control the vehicle speed through the auxiliary brake action of the engine, which can reduce the working strength of the wheel brake and reduce the brake temperature. When using engine assisted braking, the lower the transmission gear, the higher the engine speed, the greater the drag force and the more obvious the braking effect.

4. Plateau environment

Due to the thin air and low air pressure in plateau area, the brake vacuum power will become smaller, so it is necessary to apply more brake pedal force when braking in plateau area.

When it is necessary to brake, do not step on the brake pedal with the method of snub, but keep the foot on the brake pedal to ensure the braking efficiency by controlling the brake pedal force.

5. Ice and snow weather

Due to the low friction coefficient of ice and snow road, the braking distance will be greatly extended when braking, and the braking distance will increase with the increase of vehicle speed, so when driving on ice and snow road, special attention should be paid to control the speed and keep a large safety distance from the front and side vehicles.



- It is forbidden to slide in the air on snow and ice roads.

6. Brake disc surface rust

If the vehicle is parked for a long time, the brake disc may be rusted and the brake pads may be fouled. It is recommended that you drive at a low speed and brake several times before the official driving to clean the brake disc.

7. Brake system failure

If you find that the braking distance suddenly becomes longer or the brake pedal stroke becomes longer, there is a possibility that the brake system is faulty. The driving style should be adjusted while ensuring safety, and the brake pedal should be applied with greater force during braking, and travel at a low speed to the nearest Beijing car dealership.



- When the vehicle completely loses the brake, do not drive forcibly. At this time, pull over safely and contact the special BAIC dealer or wait for rescue.

8. Brake overheating

Do not put your foot on the brake pedal when you do not need to brake, but make the brake "slip", which will cause the brake to overheat, reduce the braking efficiency, extend the braking distance and increase the wear of the brake pad and brake disc.

Brake wear indicator *

The brake pad is equipped with a wear sound reminder. If the squeal or scratch is heard when stepping on the brake during driving (this is different from the brake squeeze, which is usually caused by the dust on the brake surface when braking slightly), it indicates that the brake pad needs to be replaced.

Hydraulic brake system

The hydraulic brake system transmits hydraulic pressure to the brake through two circuits. If one of the circuits fails, the other circuit will continue to operate. At this time, it is necessary to drive to the nearest BAIC dealer for maintenance at a low speed under the condition of ensuring safety. In this case, more force should be applied to the pedal.

Brake system fault warning lamp

If the brake system fault alarm lamp  is on during driving, it indicates that there is a fault in the brake system. At this time, it is necessary to check the brake fluid level. If the brake fluid level is normal, there are other faults in the brake system. At this time, it is necessary to pull over the side of the car immediately to ensure safety, and contact BAIC dealer for inspection and maintenance.

Electric park brake (EPB)



Manually release or apply the electric park brake

The keyless start / stop button is in the "run" mode, and the parking is in the tightened state. Press the brake pedal and the electric parking brake **(P)** switch downward to release the electric parking brake. The electric park brake indicator is off. The switch indicator (1) is off and the parking brake indicator on the instrument cluster **(P)** is off.

After the vehicle stops stably and the keyless start / stop button is in the "run" mode, the parking is in the released state. Pull up the electric parking brake switch to apply the electric parking **(P)** brake. At this time, the electric parking brake switch indicator lamp ① is on, and the parking brake indicator lamp on the instrument cluster **(P)** is on.

Automatic release or application of electric parking

The keyless start / stop button is in the "run" mode, and the parking is in the tightened state. Fasten the driver's safety belt, close all doors, and the gear position is in "d" or "R" (without operating the electronic parking brake switch), and press the accelerator pedal to release the electronic parking brake automatically. At this time, the electric parking brake switch indicator ① is off, and the parking brake indicator on the instrument cluster **(P)** is off.

After the vehicle stops stably, when the keyless start / stop button is switched to "off" mode, the vehicle can automatically apply the parking brake. At this time, the electric parking brake switch indicator lamp ① is on, and the parking brake indicator lamp on the instrument cluster is on.

Automatic parking system (AVH)



The AVH automatic parking system helps the vehicle to remain stationary under any stationary condition. The driver does not need to keep the brake pedal pressed all the time to keep the vehicle stationary.

Stand by

The keyless start / stop button is in the "run" mode. Close all doors, fasten the driver's safety belt, press the automatic parking switch \$, and the automatic parking function is on standby. At this time, the automatic park switch indicator (1) is on.

Execution

When AVH is in standby state, the gear is in "d" or "R", and the brake pedal is pressed during driving. When the vehicle stops stably, AVH will enter the execution state, that is to say, it will automatically maintain the parking state. At this time, the automatic parking switch indicator ① remains on, and the automatic parking indicator on the instrument cluster  is on.

Automatic relief

In the AVH execution state, the gear is in the "d" or "R" gear. Press the accelerator pedal, and AVH will be released automatically, and the parking state will be released automatically. At this time, the automatic parking switch indicator ① remains on, and the automatic parking indicator on the instrument cluster  goes out.

Danger

- When in the parking state, do not press the accelerator pedal quickly, otherwise the electronic parking life will be reduced.
- The electronic parking auto release function will reduce the service life of the parking system. It is recommended to use it only when starting on a ramp.

Warning

- If the brake pedal is not pressed, push down on the electric park switch, the electric park will not release. The instrument cluster display indicates "please apply the brake to release the electric park"
- After the automatic stop is stable, the electronic Park shall be applied first, and then the shift lever shall be placed in the "P" position.
- In some special cases, if the electronic parking brake is not required for parking, push down the electronic parking switch before turning off the start / stop button, keep it for more than 3 seconds and turn off the vehicle power at the same time, the vehicle will not apply the parking brake.
- Make sure that the driver's safety belt is fastened, or the electronic parking auto release function cannot be realized.

ABS anti-lock brake system

ABS can prevent the wheels from locking when braking, which helps the driver to better control the direction of the vehicle and reduce the side slip when braking on the slippery road.

How ABS works

When the ABS system works, you can feel the brake pedal shake and hear the "tap" sound. This is a normal phenomenon and does not mean that there is a fault.

In case of emergency braking, never release the brake pedal before the vehicle stops or breaks away from the danger (this is crucial!), and do not repeatedly press the brake pedal, which will stop ABS and may increase the braking distance. If the road is wet and slippery, even if the brake pedal is lightly pressed, The ABS system will also be enabled,

so that the driver can obtain the road surface characteristic information by braking, and then adjust his driving mode.



Warning

- The functions of ABS have some limitations. Good driving habits are the basic guarantee of safe driving. Do not be careless when driving because you are equipped with ABS system.
- In order to obtain the shortest braking distance and braking stability, the brake pedal should be pressed as hard as possible. ABS.
- After the failure of the system, the normal braking system of the vehicle can still work normally, but there is no wheel anti lock function, and in some cases, the braking distance may be correspondingly longer.

ABS fault warning lamp

If the ABS fault alarm light is on during driving, it indicates that there is a fault in the ABS system. At this time, drive to the nearest BAIC dealer for maintenance at a low speed.

EBD electronic brake force distribution system

EBD electronic brake force distribution system can automatically adjust the front and rear axle brake force distribution ratio, improve the braking efficiency, shorten the braking distance to a certain extent, and cooperate with ABS to improve the braking stability.

Hill start assist

When the vehicle is on a ramp, the hill start assist function prevents the vehicle from sliding backward when the driver releases the brake pedal by delaying the release of the brake system pipeline pressure. The driver has 1.5 seconds to move his foot from the brake pedal to the accelerator pedal and start. If the vehicle sideslips when starting from the ramp, the brake line pressure will be released immediately to ensure the vehicle can be controlled. Hill start assist can work together with the engine idle start

stop function.

Hydraulic brake assist

In view of the fast but insufficient brake pedal input, the ESP is used to increase the brake line pressure. As the brake pressure is increased to the level of ABS intervention, the braking distance is shortened. This function can be triggered in any driving state and style.

Hydraulic brake assist

When the ESP controller detects that the vacuum degree is insufficient through the vacuum degree sensor (such as high altitude, cold engine start), the ESP controller actively increases the brake line pressure by driving the motor to compensate for the temporary vacuum degree deficiency.

When the hydraulic brake assist function is involved, you can feel the brake pedal shake and hear the "tap" sound at the same time, which is a normal phenomenon.

ESP electronic stability system

ESP electronic stability system can improve the driving stability of vehicles, for example, it can reduce the risk of vehicle sideslip when accelerating and driving in curves.

The system integrates an anti-lock braking system (ABS), an electronic brake force distribution system (EBD), an emergency brake assist system (EBA) and a traction control system (TCS).

ESP will only work when the engine is run-in special cases, the ESP function shall be disabled, such as:

- When the vehicle is equipped with snow chains.
- When driving on deep snow or soft road.
- When the vehicle is stuck in a muddy road section and needs to move back and forth.



ESP indicator light



If the ESP indicator  flashes during driving, it means that the ESP system is currently performing stable adjustment work.

If the ESP indicator light  is on continuously during driving, it means that the ESP system is in fault, and the vehicle shall drive to the nearest BAIC dealer for maintenance at a low speed.

Turn off ESP function



Every time the engine is started, the ESP function will automatically turn on. Press the ESP  off button to turn off the ESP function, and the  ESP off indicator on the instrument cluster will light up.

再次按下 ESP 关闭按钮 ，即可开启 ESP 功能，此时组合仪表上的 ESP 关闭指示灯  将熄灭。

Danger

● The Electronic Stability System (ESP) has certain limitations on the stability control of the vehicle. Even if the vehicle has an Electronic Stability System (ESP), the driving method should be adjusted at any time depending on the road conditions and traffic conditions. This is especially important for driving on smooth and wet roads. Do not risk driving because this system improves vehicle stability, other wise there is a danger of accidents!

Set Cruise

General description

Vehicle cruise control system is a kind of system which uses electronic program to control the accelerator and make the vehicle keep constant speed automatically. When using the constant speed cruise function in the longdistance driving on the highway, the driver does not need to step on the accelerator pedal, the vehicle can keep driving at the set speed, so as to reduce driving fatigue and improve driving comfort.

Control conditions for cruise control:

- The constant speed cruise only works when the vehicle speed is between 40km / h and 130km / h. If the vehicle speed is not within this range, it cannot enter the constant speed cruise.
- The shift handle is in "D" (automatic transmission) or above gear 3 (manual transmission).
- Any conditions leading to cruise exit (e.g. brake pedal pressed) are not met.



- Cruise control must be selected.

Danger

- When driving on heavily trafficked roads, windy areas, rough roads, rain, snow, ice, etc., do not use the cruise control function to avoid loss of control and accidents.
- The set cruise speed and the distance from the preceding vehicle must be compatible with the traffic conditions at that time. The cruise control system is only a driver assistance system and should be used with caution.
- The cruise control system should be closed in time after use.

Launch Cruise



1. Press the  button of the switch to activate the cruise function, and the white cruise indicator light  in the instrument cluster will light up.
2. Increase the vehicle speed to the starting cruising speed (no less than 40 km / h).
3. Push down the cruise setting button, the vehicle can be set to cruise at the current speed, and the green cruise indicator  in the instrument cluster will be on. If the cruise recovery key **RES/+** is pushed up when the speed memory is not cleared, the last memory speed cruise will be recovered.

4. Release the accelerator pedal and the vehicle enters the cruise control state.

Reduce cruise speed



In cruise control, press the **SET/-** key downward to reduce the cruise speed:

1. Turn down the cruise speed setting key **SET/-** to reduce the cruise target speed by 2km / h.

2. Press and hold down the cruise speed setting key “**SET/-**”, the speed will continue to decrease but not be lower than 40km / h, release the key, and the automatic cruise will be realized according to the new set speed.

Increase cruise speed



In cruise control, press the “key upward to increase the cruise speed:

1. Move the cruise speed setting key “**RES/+**” upward, and the cruise target speed will be increased by 2km / h.

2. Press and hold the cruise speed setting key “**RES/+**” upward, and the speed will continue to increase but not higher than 130km / h. release the key, and the cruise will be realized automatically according to the newly set speed.

Overtake

When overtaking is needed, step on the accelerator pedal to accelerate and exceed the cruising speed (the same as overtaking). After the accelerator pedal is released, the vehicle will gradually resume the previously set cruise speed.

Suspend Cruise



The following four operations will temporarily cancel the current cruise, but the vehicle speed memory will not be cleared. At this time, the white cruise indicator light in the instrument cluster  will be on.

- Press the brake pedal.
- The transmission is in neutral.
- Press the **CANCEL** button.
- When ESP is working.



Resume cruise



After the cruise is temporarily released, when the vehicle speed is higher than 40km/h, push the “**RES/+ SET/**” button upwards, the color cruise indicator of the instrument cluster lights “ RSET/” up, and the vehicle speed returns to the last cruise set speed memory value and maintains the vehicle speed. Press the **SET/-** button down to cruise at the current speed.

Close cruise



When the cruise function is on, press the cruise control main switch button  to exit the cruise control, and the green cruise indicator  of the instrument cluster is off.

Direct tire pressure monitoring system

The direct tire pressure monitoring system uses a tire pressure sensor mounted on the rim to monitor the tire pressure and temperature, and then transmits the information to the receiving device via the wireless transmitter and displays the corresponding information on the combination meter.

Tire information



When the tire pressure is abnormal, the tire pressure monitoring alarm light in the instrument cluster is on, accompanied by a prompt tone. The trip computer display screen displays the car icon and the corresponding defective tire flashes.

When the tire pressure monitoring system is abnormal, the tire pressure monitoring alarm light in the instrument cluster will flash for 60 seconds and then light up for a long time, accompanied by a prompt tone. When the tire pressure monitoring system signal is lost, there is no tire pressure display on the driving computer display screen, and the tire pressure monitoring alarm light flashes.

Note

- This figure is of reference only, and the specific value is subject to the actual vehicle display.
- After the vehicle stalls, restart the vehicle. After the self check of the instrument, the instrument can display the tire temperature and pressure value, which is the historical value before the last stop and stalling, and the tire temperature and pressure value not in the current vehicle status. When the vehicle starts to drive, the system will update the current tire status in real time.
- After the vehicle starts, the running speed exceeds 30km / h and after a period of time, the instrument updates or displays the current tire pressure / temperature value of the tire, and the tire pressure monitoring system automatically enters the normal working mode.

Tire temperature / pressure alarm



When the tire has abnormal tire pressure, rapid air leakage, high pressure, low pressure, high temperature, etc., the corresponding abnormal tire alarm will be displayed in the alarm pop-up window of the instrument cluster, and the tire pressure monitoring alarm light on the instrument cluster will also be on accordingly. The driver shall stop the vehicle in a safe condition and contact the BAIC dealer immediately.

Tire pressure system failure alarm



When the tire pressure system fails, the tire pressure sensor fails, the tire pressure sensor is lost, and the power of the tire pressure sensor is low, the corresponding tire pressure system failure alarm will be displayed in the alarm pop-up window of the instrument cluster, and the tire pressure monitoring alarm light on the instrument cluster will also be on accordingly. At this time, please check the tire pressure system in the BAIC dealer in time to avoid affecting the driving safety

Note

- The tire pressure monitoring system is not a tire pressure gauge, nor can it prevent the tire from leaking or bursting. Its main function is to monitor the tire temperature and pressure.
- If a radio transmitter (such as a wireless headset, walkie talkie) is used in or near the vehicle, the operation of the tire pressure monitoring system may be disturbed.
- After the wheels of the vehicle are transposed, the tire pressure sensor shall be re-adapted to the special dealer of BAIC Motor Corporation, otherwise the tire position displayed on the driving computer screen will not conform to the actual situation.
- After wheel replacement, the tire pressure sensor shall be installed and adapted at the BAIC dealer. (there is no tire pressure sensor in the spare tire equipped with the vehicle)

Parking radar system

Parking radar system is a safety assistant device when parking or reversing. It uses ultrasonic to detect the approximate distance between the vehicle and the obstacles, and displays the results (through an intermittent sound signal) on the multimedia display screen to inform the driver. Parking radar system is only a kind of auxiliary tool, and it can't replace you to observe the surrounding environment. You should still be responsible for safe moving and parking operation. Please make sure that no people, animals or other objects are within the range of moving and parking. When the vehicle is put into R gear, the parking radar system starts to work, the instrument cluster will give an audible prompt alarm according to the distance of the obstacles, and the display screen will give an image prompt alarm according to the distance and orientation of the obstacles. When the vehicle exits R gear, the parking radar system will automatically turn off. The parking radar system uses four sensors on the rear bumper to detect objects behind the vehicle. Two sensors

in the middle can detect the objects at the farthest 1.5m behind the vehicle, which are the four alarm segments of Zone1, zone2, Zone3 and Zone4, corresponding to the red, yellow, green and green segments of the display screen; two radars at the corner can detect the objects at the farthest 0.6m, which are Zone1 and zone2, corresponding to the red and yellow segments of the display screen. The display only displays the color segment corresponding to the obstacle position, and the rest is not displayed. When there is no obstacle behind the vehicle, no color segment will be displayed.

Zone2, Zone3 and Zone4 are the early warning areas, and the combination instrument buzzer will give intermittent beeps of different frequencies to indicate the distance of obstacles; Zone1 is the long warning area, and the combination instrument buzzer will give continuous beeps. When the combination instrument sends out a continuous beep and the display indicates the red color segment, the driver shall immediately stop reversing to avoid collision and scratching with obstacles.

When there are multiple obstacles, the nearest obstacle shall prevail.

Rear parking radar on condition

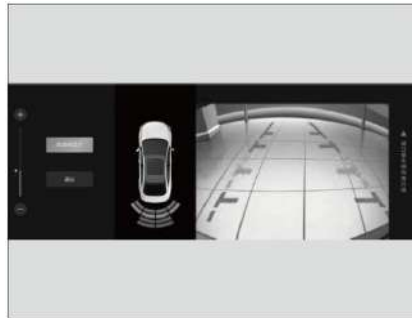
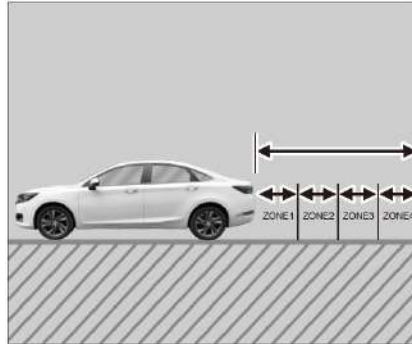

| Distance | display screen | color |
|----------|----------------|--------|
| 0~30cm | 1st Section | Red |
| 30~60cm | 2st Section | Yellow |
| 60~90cm | 3st Section | Green |
| 90~150cm | 4st Section | Green |

Note: the above distance information is approximate value, which is for reference only, please refer to the actual situation.

Parking radar system fault alarm description

Radar fault warning



When the parking radar system is on, if the fault is detected, instrument cluster will give a sound prompt and display the fault prompt.

Danger

Obstacles cannot be detected in following situation:

- ultrasonic sensor in the detection of obstacles in the blind area, it can not detect under the bumper, under the car, too close to the car or too far away from the object.
 - parking radar system can not detect small wire, cable and block mesh objects, soft snow, cotton, sponge and other easy to absorb ultrasonic objects, rocks, wood blocks, road edge and other low objects, pillars, small trees, bicycles, corner, cornerstone, corrugated paper and other shapes of special objects.
 - The surfaces of some objects do not reflect ultrasonic, which cause that these kinds of objects or people wearing such clothing cannot be detected by sensors.
- Radar system failure

warning

The following situations may result in false alarm or no alarm:

- vehicle horn sound, engine roar, vehicle exhaust, tire inflation and other sounds that near the ultrasonic sensor transceiver band may produce a false alarm.
- when reversing in narrow places or uphill, the system may detect railings, trees or slope surface, which may produce a false alarm.
- car equipped with or near the use of high frequency radio or antenna, may produce a false alarm.
- in rain and snow weather, the sensor surface with ice or dirt may produce no alarm or false alarm.
- In hot or humid weather, the distance detected may decrease. If there are water droplets attached to the surface of the ultrasonic sensor, the sensitivity will decrease, wipe it off can restore its sensitivity.



warning

Other important notes:

- do not spray the sensor surface directly with high-pressure water such as water gun, and do not squeeze or impact the sensor surface, otherwise it may cause its failure.
- parking radar system sensor is a precision component, do not disassemble and repair without permission. The company does not guarantee the quality of any damage caused by uninstall and repair without permission.

Reversing Rear view System

There is a reverse camera equipped on the trunk cover. The reverse imaging system use this camera to capture the rear image of the vehicle and transmit it to the multimedia display screen in the cab to assist the driver in reversing.

When reversing, the driver can clearly see the scene behind the vehicle through the multimedia display screen to avoid damage to the vehicle. But the system also has blind spots, such as the inability to detect small objects under the bumper and objects near the rear of the bumper and corners on either side.

Turn on/off reversing rear view system

When the car is in R gear, the rear-view camera starts to work and the rear-view image shown on multimedia display in real time. At the same time, the reversing image is accompanied with dynamic and static track line indication. The driver can judge the distance between the ground obstacle and the vehicle according to the identification of the static track line. The static track line represents the distance as shown in the figure below.

When the vehicle is out of R gear, the rear-view camera stops working and the multimedia display screen returns to the previous display interface.

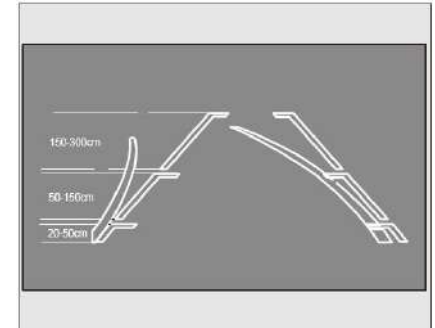

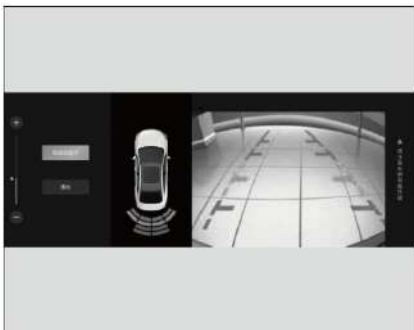

Reversing rear view system failure

When the reverse image is opened, if the system detects the fault , the multimedia display screen will show the fault prompt interface.

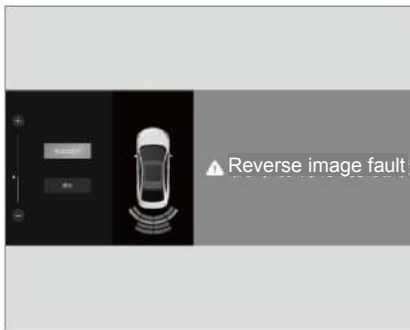

Condition that affects the effect of rear view system

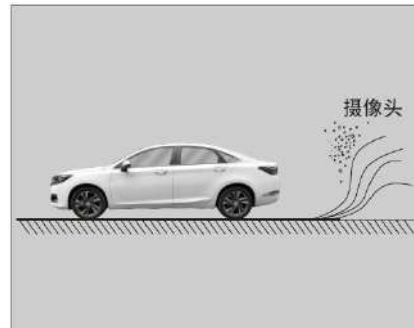

in storm or foggy

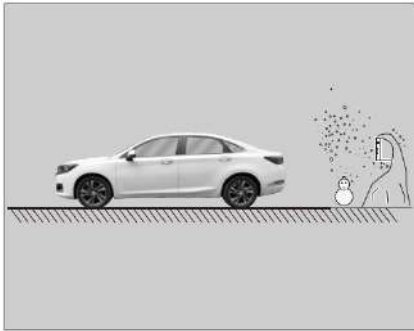

The surface of the camera is frozen or stained with dirt, dust or snow.

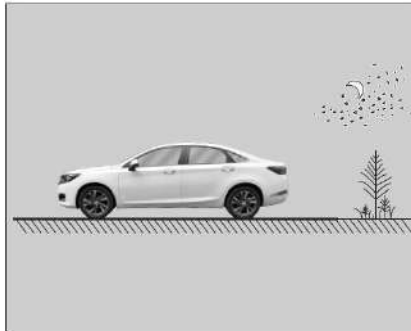

reverse in the night

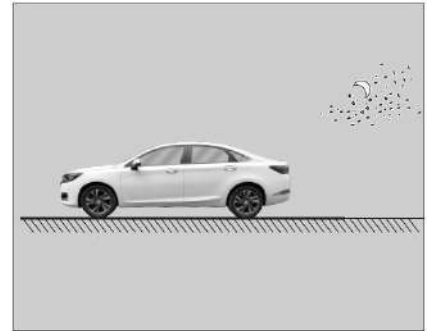

reverse in the night without reverse lamps

Around View Monitor(AVM) *

AVM is a comfort system, which consists of four CMOS wide-angle cameras and a panoramic system controller. Panoramic system can assist the driver to observe the surrounding environment in reversing, parking or turning , so as to expand the driver's field of vision and assist the driver to drive. The system includes the following main functions:

- 360°panoramic image The controller seamlessly combines the images of the four cameras around the car body to form a 360° panorama image. The display effect is similar to the image taken from the air, and the image around the car body can be presented 360°.
- 3D view when enter the AVM system, click the car model,it will display 3D view of the vehicle dynamically.

- viewpoint switching In the AVM, when clicking the left (right) area of the car image or turning on the left (right) turning light, the single view area can be switched to the left (right) view.
- Moving object recognition

AVM system switch

The console panel is equipped with a AVM switch. Press down to open AVM system, press the switch again to close AVM system.



AVM system open condition

When the start/stop button is in "RUN" mode, it can be opened with any of the following conditions:

1. Shift to R;
2. vehicle speed is less than 15km/h, press the AVM switch

AVM system quit contion

When AVM is opened, the system can be quit if any of the following conditions are met:

- 1.Shift to "P" (MT model is in neutral) for 5 seconds;
- 2.Press the "exit" button on the left side of the display screen when not under "R";
- 3.Non-" R "gear, the vehicle speed is above 15km/h;
- 4.Non R gear, Press down the AVM switch

5. Press the start/stop button to "OFF" or "ACC" mode.

Note: when entering by opening condition 2, it cannot be closed by quit condition 1.VM

system interface switch off

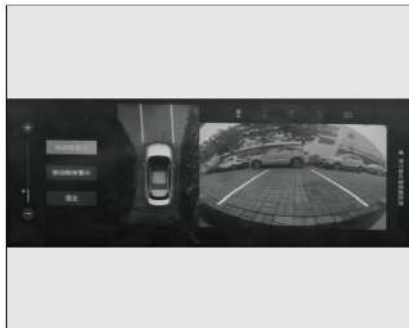

When the system starts up, the default screen of the system is front view + panorama, which can be switched to other views through shifting gear, turning light or touch screen operation.

The vehicle is in the "R" , the default screen is rearview + panorama, in which dynamic and static auxiliary lines are integrated.

When the steering wheel is not rotating, the dynamic track line coincides with the static track line. When rotating the steering wheel, the dynamic auxiliary line will calculate the vehicle trajectory line according to the steering wheel Angle to assist the driver to park.

MOD Moving object detection *

When the vehicle is stop, AVM can recognize the moving object in the camera image. When the system detects the moving object in the image, the system will give the corresponding prompt to remind the driver that there is a moving object around the vehicle and drive cautiousness

Function switch

Click the "MOD" switch on the left side on the AVM system interface to turn the MOD function on and off. When the system detects a moving object, a triangle is displayed in the corresponding area of the panoramic image as a reminder

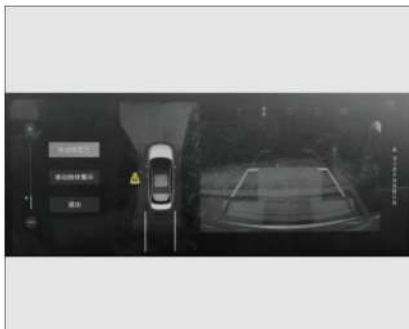

- the smallest object that the system can detect is about 50cm*50cm;
- The system can only detect objects within 3.5 meters in front and rear of the body and about 2 meters in left and right side, excluding the blind area of the camera.

Note

- this function is only helpful for safety drive, but not belong to the vehicle driving safety system. It only plays an auxiliary role and cannot instead the driver's control.
- when the camera is covered by rain, snow, mud, ice and snow, the function will show false alarm or missing alarm, please drive carefully.
- In the night, rain, snow, fog, shadow, etc., this function may produce false alarm and missing alarm, please drive carefully.

LDW Lane deviation warning system*

When non-driver intention is detected to deviate from the lane (no corresponding turning signal), LDW will send out an alarm to remind the driver that the vehicle is deviating from the lane, so as to avoid accidents caused by lane deviation.

open and close



open condition:

When the keyless start/stop button is in "RUN" mode or the vehicle has started, and the vehicle speed is greater than 60km/ h, it can be started if any of the following conditions are met:

- press LDW key;
- security setting on host interface.

close condition:

When LDW is turned on, you can exit if any of the following conditions are met:

- speed less than 60km/h;
- press LDW key;
- security setting on host interface.

Alarm

The system can provide icon visual alarm and continuous sound alarm.



When the system detects the change of vehicle status, the instrument cluster displays the lane deviation alarm interface.

Enter the auxiliary interface:



Non-auxiliary interface:



LDW Setting

The user can set LDW alarm mode and alarm sensitivity in the host interface. High sensitivity means that vehicle alarm when it is about to press the line; Low sensitivity means that vehicle has alarms after pressed the line



Notice

- this function is only helpful for safety drive, but not belong to the vehicle driving safety system. It only plays an auxiliary role and cannot instead the driver's control.
- when the camera is covered by rain, snow, mud, ice and snow, the function will show false alarm or missing alarm, please drive carefully.
- In the night, rain, snow, fog, shadow, etc., this function may produce false alarm and missing alarm, please drive carefully.

BSD blind spot detection *

BSD is to use the side camera to detect the blind spot of the rear view mirror and remind the driver to avoid accidents caused by this blind spot during lane changing.

When a moving vehicle is detected in the blind spot set by system, the monitoring indicator of corresponding rear view mirror will be on. In this case, when the corresponding side turning signal is on, the indicator will flash, and the system will give an alarm to remind the driver that there is a vehicle in the blind area of the rear view mirror.

BSD Alarm

Auxiliary interface:

When the system detects the moving object, the combination instrument displays the BSD and alarm interface. And make external rear view mirror BSD alarm light on and sound alarm.





Non-auxiliary interface:

When the system detects a moving object, only the external rear view mirror BSD provided for visual alarm and sound alarm.

turn on and off

turn on:

When the vehicle started, one of the following conditions can be met:

- when the speed is greater than 30km/h;
- host security setting interface. turn off :

When BSD is turned on, you can exit if any of the following conditions are met:

- when the speed is less than 30km/h;
- host security setting interface.

detect scope

- the system can only recognize 4-wheel vehicles;
- the system does not give an alarm to vehicles moving in the opposite direction.

alarm

When the system detects moving objects, it can provide LED light visual alarm and sound alarm

功能配置

The user can configure BSD on and off in the host interface.

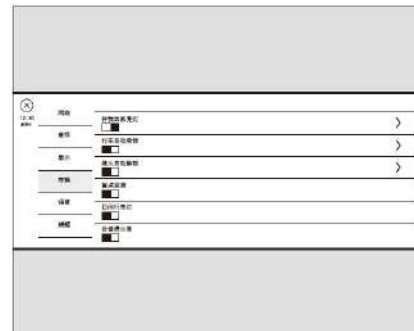

Notice

- change lane carefully.this function is only helpful for safety drive, but not belong to the vehicle driving safety system. It only plays an auxiliary role and cannot instead the driver's control.
- when the camera is covered by rain, snow, mud, ice and snow, the function will show false alarm or missing alarm, please drive carefully.
- In the night, rain, snow, fog, shadow, etc., this function may produce false alarm and missing alarm, please drive carefully.

Idle Stop-Start System *



The start-stop system control the engine ECU, enhanced starter, large capacity electric storage pool and battery sensor and other components to work together, which realize the engine automatically shut down when idling, and started automatically when moving,it can effectively reduce engine fuel consumption and emissions and noise at idle speed



When driving on traffic jam, the idling start-stop function can be opened, and when driving at high speed, the idling start-stop system can be closed.

usage method



When the keyless start/stop button is switched to "RUN" mode, the idle start/stop function is enabled by default.If the vehicle meets the idling start-stop condition, the idling start-stop running indicator light  is on.

If the idle start and stop function needs to be turned off, press its switch  on the multifunction switch panel, and the indicator  on the combination instrument will be on.

Press the start/stop switch again . The function will be turned on again and indicator light  will be off.

When function is on, if there is a fault in the system, the idling start-stop/fault indicator light on the combination instrument  will stay on after flashing for a period of time, and the system cannot realize the idling start-stop function.

working condition

1. The function is in the open state, and the relevant parts are no fault (such as sensors, relays, etc.);
2. The battery sensor detects enough energy to start the next time;
3. The coolant temperature reaches above 60°C;
4. Sufficient vacuum of brake vacuum booster;
5. Engine hood is closed;
6. The driver's side door is closed and the main driving seat belt is fastened;
7. Air conditioning or mist function is off;
8. The acceleration pedal is completely released;
9. The vehicle is relatively stationary (the speed is less than 3km/h);
10. The vehicle had a start of more than 10km/h.

operation method

After the vehicle meets the working conditions:

For CVT transmission models: the gear position is put in "D" gear, and the brake pedal is pressed down and maintained. After the vehicle stops steadily, the engine will automatically turn off. When ready to start again, just release the brake pedal to start the engine automatically.

For manual transmission models: gear position in neutral and release the clutch pedal, the engine will automatically turn off. When ready to start again, just press the clutch pedal to start the engine.



warning

- When the engine starts automatically, if the driver does not shift gear or press the accelerator within 15 seconds, the engine will stop automatically again.

 warning

When the engine is in the state of automatic shutdown, once the following situation occurs, the engine will automatically start quickly.

- battery power less than the limit value, or battery signal failure;
- insufficient vacuum of brake vacuum booster;
- the vehicle appears to "slip" forward or backward, and the speed is greater than 1.1km/h;
- close idle start stop switch;
- open the defogging switch or the air conditioner controller to send A/C request;
- steering wheel Angle change $> 2^\circ$;
- open the driver side door, open the main driving seat belt;
- shift lever out of D gear.

 warning

If the following situations occur, the system cannot realize the idle start and stop function, and the engine will not stop automatically:

- too frequent use of idle start stop function;
- the current altitude is higher than about 3,200m;
- when the battery internal temperature is very high or very low;
- engine coolant temperature below 60°C or above 105°C ;
- after the battery power off and reconnected, the system will carry out self-learning, this stage idling startstop function cannot be realized, when the vehicle runs for a period of time, can use idling start-stop function;
- uphill slope $< 4\%$, downhill slope less than 10% ;
- steering wheel Angle $> \pm 25^\circ$.

battery sensor

The battery sensor is a precise electronic component, which monitors the working state of the battery by detecting the internal voltage, current, temperature and other information of the battery. There are contact resistance

requirements between battery negative wire harness and battery sensor, so disassembly is not allowed, otherwise it will lead to idle start stop system failure.

Battery is not allowed to charge after disassembly, otherwise the battery sensor will not be able to output the correct power signal, idle start and stop system may fail, the battery sensor needs to be re-fitted to Beijing auto dealership.



- if the battery needs to be replaced, only the battery of the same model is allowed to be replaced. After the battery is replaced, the battery sensor needs to be adapted in dealership. Otherwise, the accuracy of sensor parameters will be affected, which will affect the normal operation of the idling start-stop system.
- when the engine cannot start due to a long time of vehicle parking and insufficient battery power, jumper start can be carried out; Do not remove the car's battery or battery sensor, or the idle start - stop system may fail.

security inspection

It is a good idea to have a safety check before the vehicle starts. A few minutes' check will help you to drive safely.

发动机启动之前

external of vehicle

tire:

Check tire pressure, as well as tires for cuts, damage, or excessive wear and bulging.

Wheel nut:

Make sure no nuts are missing or loose.

Lamp:

Ensure that all headlights, brake lights, reverse lights, steering lights and other lights are working properly. Check the direction of headlight exposure.

Engine compartment:

oil level

Ensure all oil levels of the vehicle are normal, such as engine oil, coolant, brake fluid, etc.

Battery and cable condition:

Check the shell of the battery for cracks, the junction post for corrosion or looseness, and check whether the cable connection is in good condition.

vehicle cabin

Check and confirm that the latch and buckle are fastened. Make sure the safety belt is free from wear and tear.

In particular, make sure that the indicator light and defrost/mist removal functions are working normally.

Check to make sure the pedals have enough free travel.

engine started

before moving:

oil leakage

After the vehicle has stopped for a moment, check the underside for any oil, oil, water or other liquid leakage. Water dripping after air conditioning is normal.

driving

Instrument cluster:

Ensure that the red and yellow alarm lights on the cluster are not on.

Brakes:

Under the condition of ensuring safety, drive at a low speed, step on the brake pedal, check whether the brake is reliable, the vehicle will not deviate, the brake does not sound abnormal.

Noise:

Check the vehicle for unusual noise.

Driving in running-in period

In order to improve the service life of the vehicle, the new car in the use of the initial should be run in, can be used normally. The following provisions for the run-in period:

- the mileage of run-in is 1500km.
- choose a better road and drive light load.
- do not exceed 80% of the maximum speed.
- do not press the accelerator pedal to the bottom for rapid acceleration.
- avoid emergency braking for the first 500km.
- strictly follow the operating procedures to maintain the normal engine temperature .Do the daily maintenance work carefully, check frequently, pay attention to the sound and temperature change of each assembly in operation.

Engine Run-in

After the engine runs in following the requirements, it can not only prolong the service life, but also reduce the fuel consumption. The new engine must be run in for 1500km, and the following regulations must be observed during the run in:

- avoid high engine speed , do not exceed the maximum speed of 80%.
- do not use as a tractor trailer.

At 1000-1500km, the engine speed and vehicle speed can be gradually increased to the maximum allowable range.

In the early run-in, the engine's internal friction resistance larger , oil consumption may be higher than normal, should regularly check the engine oil.

All the moving parts of the engine can reach the best performance after running in.

Tire and brake pads run-in

For the first 500km, drive at moderate speed to run in tire well

If the new brake pads and brake disc do not reach the optimal friction state within the initial 500km, emergency braking should be avoided and sufficient safety braking distance should be maintained to gently press on the brakes to achieve the optimal run-in state

Danger

- None run-in tires and brake pads do not have the best adhesion and friction, so the first 500km must be driven carefully to avoid accidents.
- New brake pads must also be in accordance with the above requirements.
- when driving, should keep a proper distance from other vehicles, beware of the need for emergency braking. Because right now new brake pads did not run in that is easy to cause traffic accidents.

Driving essentials in different situation

In the manual mode of CVT, when the vehicle is driving on a severe bumpy road or emergency braking, the vehicle may temporarily exit the manual mode to protect the transmission. At this time, the gear position display D. When the vehicle resumes normal driving, the manual mode M will be automatically restored.

CVT vehicle in extreme uphill condition (stop to uphill 32%, uphill 33%), clutch will be in long term (or short time repeatedly) slip friction condition which cause the clutch temperatures soared to limit the transmission alarm, even transmission will enter self-protect mode to cut off the power until the oil temperature decreases.

Drive in the rain

When it rains, visibility is low, windshield is foggy and roads are slippery, so drive carefully.

- driving in heavy rain can worsen vision. Turn on headlights, fog lights and hazard warning lights.
- the water will affect the brake performance, driving in rainy days need to increase the distance, and reduce the speed.
- do not drive at high speed on the road when it is raining, because the higher the speed, the more likely it is to form a water slide between the tire and the road surface.

Danger

- When driving on slippery roads, emergency braking, acceleration and sharp steering can cause tires to slip, reducing handling and causing accidents.

Drive in water

Warning

- be aware of water waves caused by front vehicles. This may cause water depth to exceed the maximum allowable depth. Once the water reaches the bottom of the car, do not force to drive in water
- Do not accelerate the vehicle to enter a flooded road. The eddies created by accelerated driving can cause water to enter the car and damage the engine and other assemblies.
- do not open any doors while wading. Otherwise, water may enter the vehicle and damage the vehicle's electrical system and equipment.
- The engine turned off when wading, do not forcibly start the engine again, the engine may inhale some water, start the engine again will cause irreversible damage to the engine.

If you need to go through water, please note the following:

- before wading, should correctly estimate or verify the depth and water characteristics, for unknown water area, do not force wading.
- the engine idling start-stop function must always be turned off.
- shift to a low gear, but avoid high engine speed.
- choose a flat place, smooth, slow walking speed over the water road.
- when wading through the water, do not stop or stall the engine.
- after wading, lightly step on the brake pedal a few times, so that the brake dry, so as to restore braking force.
- wading should be timely removal of the tread mud.
- salt water is corrosive, the car has been immersed in salt water parts must be washed with water.

Driving essential in winter

Danger

- if you try to increase engine braking by shifting down on slippery surfaces, the drive wheel may lose its grip on the ground, which increases the risk of skidding and accidents.
- toxic gases such as carbon monoxide (CO) may enter the vehicle if the exhaust pipe is blocked or poorly ventilated. There is a risk of fatal injuries, especially when vehicles are trapped in snow.

warning

- if the engine or auxiliary heating system is running, make sure the exhaust pipes and areas around the vehicle are free of snow and ice. Ensure adequate supply of fresh air in the car.
- when deicing the rear window, be careful not to damage the sealing strip and plastic parts on the rear window.
- drive with special care on slippery roads. Avoid sharp acceleration, sharp steering and emergency braking. Do not use cruise control.
- when winter comes, please go to Beijing car dealership for winter protection and maintenance of vehicles.

Prepare before winter:

1. Winter Oil needs to be replaced in advance:
 - choose suitable for low temperature environment viscosity value of oil;
 - choose the coolant suitable for low temperature environment;
 - choose antifreeze detergent suitable for low temperature environment.
2. Check tires to make sure have enough tread depth.
3. If necessary, buy a set of tire chains that match the front wheels.
4. Ensure good battery performance.
5. According to the driving destination, it is recommended to bring some necessary emergency supplies: snow and ice scraper, flash signal device, spatula, jumper cable, inflator pump, etc.

Before driving:

1. Do not forcibly open the frozen window or move the frozen windscreen wiper. Use warm water to melt the frozen part. Wipe the water off immediately to prevent freezing.
2. Remove snow and ice from the fender.

When driving:

For AT, if the vehicle is kept in a cold environment for a long time (such as the whole night), the vehicle may start late when the engine is started and the shift handle is placed in the driving gear. This phenomenon is only obvious after vehicle cold start, and will disappear after the vehicle driving.

Do not press the acceleration pedal during a late start. Otherwise, you may damage the transmission.

Start driving steadily and choose appropriate speed according to road conditions.

Parking:

When parking on the flat ground, shift in "P" gear (AT) or put the shift handle in neutral (MT), such as blocking the wheels with rocks, please also be sure to apply parking brake.

**Danger**

- Parking brake must be applied when parking on a steep slope.

Brake essential

Do not use the brake pedal as a foot rest. If you put your foot on the brake pedal while driving, the brake system may overheat. This will increase the braking distance and may even cause the braking system to fail, which is an accident risk.

Do not press the brake pedal and accelerator pedal while driving.

Continuous use of the brake pedal can lead to excessive brake lining and premature wear.

Effective vehicle usage

- maintain correct tire pressure. Insufficient air pressure can cause tire wear and waste fuel.
- accurate wheel alignment, otherwise will lead to excessive tire wear, increase engine load, waste of fuel.
- don't place unnecessary items in your car. Excessive load will increase engine load, resulting in increased fuel consumption.
- slow and smooth acceleration, avoid rapid start. Try to drive in high gear.
- avoid heavy traffic jam as much as possible and avoid continuous acceleration and braking. Stop-and-go driving is a waste of fuel. Avoid unnecessary parking and braking to maintain a steady speed. Drive with traffic lights to reduce the number of stops. Try to choose the road without traffic lights.

Keep a proper distance from other vehicles to avoid emergency braking, which will also reduce brake wear.

- do not place your foot on the brake pedal. This will lead to premature wear of brake liners, overheating and fuel waste.
- be sure to drive at a low speed in side gust, so that it is easy to control the vehicle.
- avoid hitting the side road when driving. Slow down when driving on rough roads.
- avoid vehicle chassis with soil and other dirt, which can not only reduce the weight of the vehicle, but also prevent corrosion. Maintain the vehicle in good working condition. Dirty air filters, improper valve clearance, dirty spark plugs, dirty oil and grease will reduce the performance of the engine and waste fuel. To extend the service life of all parts

and reduce operating costs, must be regularly maintained. If driving frequently in poor conditions, the mileage and cycle of maintenance should be shortened.

- while cleaning the vehicle or driving through deep water, brake may be wet. It is necessary to drive at a low speed first and tread the brake pedal lightly for several times to ensure the safety of driving, so that the brake can dry quickly. Drive carefully, if the brake still cannot work safely, stop the car under the condition of ensuring safety, and contact dealership for help.



- make sure parking brake is released before driving.
- do not place your foot on the brake pedal while driving as this can lead to overheating of brake linings, unnecessary wear and fuel waste.
- drive down a long and steep slope, to slow down and gear down. Overuse of brakes will cause them to overheat and not work properly.
- when driving on a smooth road, be careful when accelerating, shifting, shifting or braking. Sudden acceleration or the use of engine braking may cause the vehicle to skid or idle wheels.
- avoid the water surface when driving, so as not to wet the brake.

Fuel-saving drive

Fuel-save driving is not only a way to save fuel, but also a way to protect the environment. Here are some tips for fuel efficient driving:

- unload unnecessary loads before driving.
- maintain proper tire pressure.
- smooth start, try to avoid rapid acceleration and deceleration.
- cold car start slowly drive a few minutes, and then accelerate after the engine warm up, generally do not need to run the engine in situ to preheat.
- plan the driving route, choose a good road driving.
- try to drive at an economical speed.
- according to the driving speed, choose the appropriate gear, avoid low gear high-speed driving.
- don't open the window when driving at high speed.

- reasonable use of air conditioning, but also to reduce the use of high power audio and other high-power electrical equipment.
- the idle start-stop system should be turned on.
- stop for a long time, should close the engine, to avoid starting captain time idle operation.
- regularly maintain the vehicle in good condition according to the maintenance requirements.

4. Maintenance and Service

| | |
|--|-----|
| Maintenance summarize..... | 186 |
| Regular maintenance..... | 186 |
| Routine maintenance..... | 186 |
| Engine compartment layout (A151E Engine)..... | 191 |
| Engine compartment layout (A150TD Engine)..... | 192 |
| Safety instructions for working in engine compartment..... | 193 |
| Engine coolant..... | 194 |
| Engine oil..... | 196 |
| Brake fluid..... | 199 |
| Battery..... | 201 |
| Windshield washing fluid..... | 204 |
| Tire and wheels inspection..... | 208 |
| Check tire pressure..... | 209 |
| Tire selection and replacement..... | 212 |
| Accidental burst handling..... | 214 |
| Replacement of rim..... | 214 |
| Tire chain..... | 215 |
| Clean the outside of the vehicles..... | 215 |

| | |
|---|-----|
| Clean the inside of the vehicle..... | 218 |
| Anti-corrosion measures..... | 219 |
| Recycling and environmental protection..... | 220 |

Maintenance summarize

With the increase of mileage, the parts and components of the vehicle will gradually wear out and the technical condition will become worse. In order to guarantee the good performance of the vehicle and maintain the value of the vehicle when it is resold, it is necessary to maintain the vehicle in the process of use.

Maintenance is divided into periodic maintenance and daily maintenance. Periodic maintenance please go to dealership, daily maintenance mainly by the driver.

All maintenance or inspection operations must be carried out in accordance with the safety operation specifications, incorrect operation may cause functional failure or damage to the vehicle, or even accident.

Regular maintenance

Timely periodic maintenance is an essential link in the use of vehicles. Please refer to the maintenance information table for the mileage interval or time interval of periodic maintenance and the maintenance items. Also follow the maintenance mileage reminder in the instrument cluster (see "maintenance mileage") timely to dealership for regular maintenance.



warning

- Not timely maintenance for the vehicle, will reduce the use performance, resulting in vehicle damage, at the same time will lose the right to claim for warranty.

Routine maintenance

Daily maintenance is a daily check before normal driving. This is necessary if the vehicle is to operate continuously. It is the driver's responsibility to carry out daily maintenance.

Daily maintenance, inspection can be completed by the driver himself, if necessary to Beijing car dealership.

Caution for daily maintenance

Drivers must pay attention to safety when carrying out daily maintenance, and comply with the safety operation specifications, so as not to cause injury to themselves or damage to the vehicle.

If it is necessary to disassemble and replace the vehicle parts, the maintenance of the vehicle should be carried out by professional personnel. If you have any questions about the maintenance of the vehicle, please consult dealership.

Danger

- Prior to routine maintenance, park the vehicle in a safe area on a flat, load-bearing surface and apply parking brakes. Do not carry out daily maintenance operations in unsafe areas such as traffic flow, high traffic, near inflammable and explosive dangerous areas or on ramps.

Danger

- if have to run engine in a closed environment such as a garage, make sure adequate ventilation
- before the daily maintenance operation, should take off loose clothes, dish up long hair, and take off bracelets, watches and other jewelry, wear gloves.
- timely remove foreign matter in the engine compartment when daily inspection or periodic maintenance, do not leave gloves, rags and other flammable items or tools in the engine compartment. Items left behind can cause engine failure or damage, or even cause a fire.
- engine and exhaust system in the work will produce high temperature, easy to cause burns. Therefore, the engine should wait for at least 30 minutes after the shutdown, the engine and exhaust system cooling before the relevant daily maintenance operations.

Danger

- do not get under the vehicle with only the jack assembly to support the vehicle. If personnel must go under the vehicle, support the vehicle with a safety support frame.
- when the start/stop button is in "RUN" mode, do not disconnect or connect the battery cable or other electrical component connector.
- when the engine is closed, the pressure in the fuel line is still very high. Do not disassemble the fuel line. Please go to Beijing auto dealership for maintenance of the fuel system.
- do not allow sparks, flames or sparks near fuel system parts and batteries.
- avoid direct skin contact with used engine oil or coolant.

Vehicle external daily maintenance

Door and engine hood

Check all doors, engine hood and trunk open and close properly.

Check that all door locks function properly. Lubricate hinges and door locks as necessary.

After confirming that the engine hatchcover lock has been opened, the safety hook will keep the engine hatchcover closed.

lamps

Check and ensure that headlights, brake lights, position lights, turn signals and other lighting equipment are working properly and are fixed and reliable.

Tire

Before a long journey, check your tires carefully for damage, cracking, or excessive wear. Use a tire barometer to measure the pressure on your tires. (see "tires and wheels")

A/C air inlet

The air conditioning inlet is located at the lower right of the front window. The outside air is inhaled from the air inlet and enters the car through the air conditioning system.

The leaves and other sundries on the air conditioning ventilation panel should be cleaned regularly; Especially in rainy and snowy weather, the snow should be removed from the front wind window and the ventilation panel of the front wind window in time to ensure that the air inlet and water passage of the air conditioner are unimpeded. Otherwise, the outlet of the water channel may be blocked, affecting the air conditioning effect, and even cause the failure of the air conditioning system.

Vehicle interior daily maintenance

Acceleration pedal

Check whether the pedal is normal, ensure that the pedal operation is not stuck and uneven force, ensure that the floor mat do not interfere with the operation of the pedal.

clutch pedal

Check whether the pedal is normal, ensure that the pedal operation is not stuck and uneven force, ensure that the floor mat do not interfere with the operation of the pedal.

brake pedal

Check that the brake pedal is operating properly to ensure that there is an appropriate gap under the brake pedal when it is fully pressed and that the floor MATS do not interfere with the operation of the brake pedal.

Parking brake

Operate electronic parking brake switch to ensure reliable parking function.

steering wheel

Check the steering wheel for excessive free travel, heavy steering, or other unusual noises.

safety belt

Check that all parts of the safety belt (such as buckles, latch and retractor) work properly and smoothly and are securely installed. Check the belt for cracks, scratches, wear, or damage.

Clean and maintain instrument panel and plastic

Clean instrument panel and plastic surface regularly with a clean soft cloth. And can spray appropriate amount of dashboard wax for protection. Special stains can be cleaned with special solvent-free plastic cleaner.

Danger

- Do not use solvent cleaner to clean the surface of instrument panel and air bag module. Otherwise, materials on the surface of the airbag module may be damaged and serious injuries may be caused when the airbag is deployed.

Leather cleaning and maintenance

Use vacuum cleaner to suck the dirt of leather surface, wipe leather with the wet soft cloth that twist works, reoccupy another dry soft cloth wipes its dry. After it is completely dry, it can be sprayed with appropriate amount of leather care agent for protection.

If the above cleaning is not enough to remove the stain, can cooperate with the special leather

warning

- wipe with a soft dry cloth as soon as possible after using leather cleaner.
- do not place soft cloth soaked in cleaning agent in any part of the interior for a long time, so as not to cause local fading of the interior.

Other parts daily maintenance items

Alarm light, indicator light and buzzer

Ensure all alarm lights, indicators and buzzers are working properly

Windscreen defroster/mist remover

When operating the air conditioning system, check that air can be properly and adequately blown out of the outlet of the defroster and mist remover.

Wiper and scrubber

Check whether the wiper and scrubber can work normally. If the wiper leaves scratches after scraping, you should immediately go to dealership to replace the wiper blade.

windshield clean water

Check whether there is enough washing liquid in the storage tank.

brake fluid level

Ensure that the brake fluid level in the brake fluid storage tank is between the MIN line and the MAX line.

engine coolant level

When the engine is cooled, check the coolant level in the tank.

engine oil

Park on a flat, solid ground, turn off the engine, and after 10 minutes, check the oil level with the engine oil gauge.(see "check method of engine oil level")

fluid leakage

After a vehicle has stopped for a period of time, check for any leakage of fuel, oil, coolant or other liquids under the vehicle. Water dripping from the air conditioner is normal.If any leakage or gasoline is detected, please find the cause and contact the dealership immediately for repair.

Engine accessory belt

Ensure that the accessory belt is free from wear, slack, cracking or grease.

Engine compartment layout (A151E Engine)



- 1.engine coolant tank filling cap
- 2.engine oil dipstick
- 3.brake liquid tank filling cap
- 4.Battery maintenance cover
- 5.fuse box
- 6.air filter
- 7.engine oil filling cap
- 8.windshield washing liquid tank cap

Warning

- It is suggested that the user should not disassemble the engine compartment cover plate by himself to avoid unnecessary damage. For disassembly and assembly, please go to the dealership.

Engine compartment layout (A150TD Engine)



- 1.engine coolant tank filling cap
- 2.engine oil dipstick
- 3.brake liquid tank filling cap
- 4.Battery maintenance cover
- 5.fuse box
- 6.air filter
- 7.engine oil filling cap
- 8.windshield washing liquid tank cap



warning

- It is suggested that the user should not disassemble the engine compartment cover plate by himself to avoid unnecessary damage.For disassembly and assembly, please go to the dealership.

Safety instructions for working in engine compartment

General instruction

The engine compartment is a dangerous area. If you are not familiar with necessary operations and general safety precautions, do not work in the engine compartment without proper tools! Please transfer all operations to dealership. Improper work can lead to injury. Before all operations in the engine compartment, the following operations shall be performed:

1. Park the vehicle in a safe area, on a flat, load-bearing surface.
2. Apply parking brake, put the gear in "P" or neutral, close the engine and wait for the engine to cool down.
3. Keep children away from the vehicle.
4. Open engine hood.
5. Please make sure the car doesn't slip by accident.

Danger

- Before opening the engine hood, if steam or coolant overflow from engine compartment, do not open the engine cover, beware of scald! Waiting for engine cooling, until can not see steam or coolant overflow
- Do not operate in the engine compartment when overheating, such as inspection and addition of oil, so as to avoid injury and scald operators, or even cause a fire.
- Do not touch the cooling fan. The cooling fan is controlled by temperature and may turn on automatically when the engine is out.
- Check your vehicle for oil leakage. Avoid dripping oil onto a hot engine or exhaust, which can be a fire hazard.

Danger

- When adding oil, do not mix up all kinds of oil, otherwise it will cause serious functional failure of the vehicle.
- If under the car operation, should take appropriate measures to prevent the car slip or with the appropriate support vehicle. In this case, it is not suitable to support the vehicle with the jack assembly only, beware of causing injury to the operator under the car!
- If you have to start or run the engine operation, be careful at all times, beware of accessories such as belts, generators, cooling fans and other rotating parts and high-pressure ignition system injury operators!

Engine coolant

general instruction

The cooling fluid can prevent corrosion, cavitation corrosion and leakage, radiator boiling, scale and freezing, etc., which can make the cooling system always in the best working state and ensure the normal working temperature of the engine.

warning

- It is forbidden to drive a vehicle without engine coolant, otherwise it will cause water pump failure and engine stuck

Over heating alarm light (red)

If the coolant temp is too high during driving, the alarm light  is on, indicating that the engine coolant temperature is too high.

Danger

- Do not continue driving when the  engine coolant temperature is too high and the alarm light is on, otherwise the engine will damage

coolant level check



Check the coolant level after engine cooling.
MAX: coolant upper limit mark.
MIN: mark the lower limit of coolant.
The coolant level should be between the upper and lower mark.
If the liquid level is lower than the lower limit mark, the specified type of coolant should be added in time.

add engine coolant



Check the liquid level of the coolant after engine cooling. If a small amount of coolant is found missing, open the filling cap of the coolant tank and add the coolant between the upper and lower mark

If there is a large or frequent lack of coolant, please check the cooling system at the dealership.

Danger

- do not open the filling cover of the coolant tank before the engine is cooled, because the coolant temperature is very high at this time, and hot coolant or steam may be ejected when opened, causing burns to personnel.
- do not mix coolant of different models or brands. Do not add other liquids or additives to the coolant, or it may damage the engine.
- if the coolant in the reservoir is discolored, the coolant should be replaced in time.

warning

- Please go to dealership to supplement and replace engine coolant.

Coolant replacement

Please refer to the "maintenance information table" for periodic replacement of engine coolant, please go to dealership for replacement.

Danger

- in winter or cold areas should be replaced with the environment temperature with a stronger antifreezing ability of the coolant, to prevent the engine from being frozen.
- coolant must be stored in an enclosed container and kept away from children.

Engine oil

general instruction

Refer to the provisions in the 《 maintenance information table 》 to replace engine oil regularly, please go to dealership , to ensure the service life of the engine.,please follow the provisions

When purchasing engine oil, please check whether the type and specification are applicable to the engine and the corresponding operating environment.

Notice

Oil used in factory:

- SN 5W-30, quantity 4.3L

Recommended SAE viscosity for engine oil

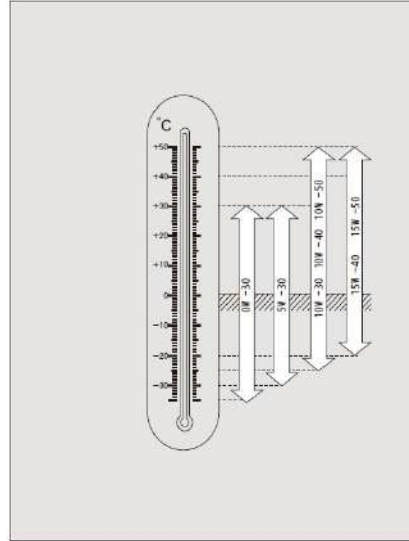

Please select the appropriate engine oil according to the ambient temperature.

oil pressure indicator (red)

If the engine oil pressure alarm lamp continues to light up after the engine starts, indicating that the engine lubrication system is in trouble, the engine should be shut down immediately and the engine oil level should be checked.

If the oil level is normal, but the alarm light is still on, do not continue to drive, at this time should close the engine, contact the dealership to check the engine lubrication system.

warning

- Driving after the engine oil pressure alarm light is on can seriously damage the engine.

Oil level checking method

check the level by oil dipstick:

1. Park on flat and solid ground.
2. Start the engine and warm it up until the engine temperature reaches the normal operating temperature (about 5 minutes).
3. Turn off the engine and wait for at least 10 minutes to let the engine oil flow back into the oil pan.
4. Pull out the oil dipstick, wipe off the oil with a clean cloth, and re-insert the oil dipstick to the bottom.
5. Pull out the oil dipstick again and check whether the liquid level is between the upper and lower marks.

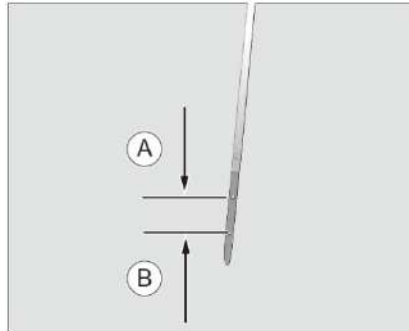

A : upper limit

B : lower limit

Engine operation will consume a certain amount of oil, oil consumption depends on the driving mode and vehicle use conditions. Therefore, it is necessary to check the oil level regularly, and it is best to check the oil level after each refueling and before long distance driving.

When long distance driving in summer or driving in mountain zone, in this harsh conditions, the oil level should not exceed the upper mark (A).

add engine oil



1. Park on a flat, solid surface.
2. Open engine hood.
3. Remove engine trim cover.
4. Put a cloth around the filling port to prevent oil from dripping onto the engine.
5. Turn counterclockwise to open the oil filling cap.
6. In order to avoid excessive oil filling, oil added should little by little in several times

(it takes several minutes for the oil to flow from the filling port to the oil pan)

7. When the oil level reaches between the upper and lower mark, stop oil filling and tighten the oil filling cap.

8. Put away the cloth and clean around the filling port.

 **warning**

- Do not start the engine if the oil level exceeds the upper mark. Otherwise, the catalytic converter and the engine may be damaged. If the injection is too much, contact the dealership to remove the excess oil.

 **Danger**

- Engine oil is a highly combustible substance. Be careful when filling oil. Do not spill oil on hot engine parts or exhaust system parts.

Engine oil replacement

 **warning**

- Be sure to change engine oil regularly according to < maintenance information sheet >

Please go to BAIC dealership to change the engine oil.

If the vehicle is driving in bad conditions, such as:

- frequent short distance driving
- idling for long periods of time (e.g. taxis).
- driving in dusty areas.
- often traction driving.
- driving in cold areas. In the periodic maintenance must increase the maintenance times for the related items, or shorten the maintenance cycle.

 **Notice**

- new engine oil running for a period of time will change color soon, this is a normal phenomenon, do not need to change the oil in advance.
- disposal of waste oil is a very professional work, must have the corresponding professional knowledge and equipped with necessary special tools. It is suggested that the car should be recycled by dealership.
- waste oil is extremely harmful to the environment and water sources. Do not pour waste oil into sewage pipes or into the soil or lawn.



warning

- in winter or cold areas, it should be replaced with a stronger anti-freezing ability of the engine oil, in order to facilitate the engine low temperature start and good lubrication.
- do not mix different types or brands of engine oil.
- continue driving after the engine oil pressure alarm light is on, which will  seriously damage the engine.
- if the engine oil is too little may damage the engine; Excessive engine oil can also damage the engine and catalytic converters.



Danger

- do not change engine oil without relevant professional knowledge and tools.
- be careful not to touch the radiator hose when checking or adding engine oil, because the radiator hose is hot and will burn you.
- if your skin is stained with oil, rinse thoroughly.
- do not add any other additives in the engine oil, otherwise it may damage the engine.
- the oil filling cap must always be in a tight position to prevent oil spatter and fire when the engine is running.

Brake fluid

general instruction

Brake fluid is used to transfer pressure in the hydraulic braking system of vehicles. If the stroke of the brake pedal is getting unexpectedly longer or the brake fluid level drops obviously, contact dealership to overhaul the brake system.



Warning

- the brake fluid has a strong water absorption, should be stored in a closed container to prevent the deterioration.
- brake fluid has a corrosive effect on the body paint, should be promptly removed brake fluid splash on the paint

Danger

- brake fluid should be stored in a place that is not accessible to children. If accidental drink brake fluid occurs, seek for medical immediately.
- avoid contact with brake fluid by skin or eyes. In case of accidental contact, rinse immediately with plenty of water and seek medical advice.
- be careful not to splash brake fluid on the hot engine, it may cause a fire.

brake system failure / low fluid level alarm  (red color)

If the brake system failure/low brake level alarm light is on during driving, it means the brake system failure or low brake level.



Dange

- If the warning light is on during driving, do not step on the brake pedal repeatedly. Stop immediately and check the brake level under the safety condition. If necessary, please contact the dealership to overhaul the brake system.

Brake fluid level checking



Observe the mark on fluid reservoir

- “MAX”: upper limit
- “MIN”: lower limit

The brake fluid level shall be between the upper limit and the lower limit. If the liquid level drops obviously within a short time, it indicates that the brake system has leakage phenomenon, please contact dealership for maintenance as soon as possible.

Add fluid

If the liquid level is lower than the min. limit, the brake fluid must be added in time.

Danger

- do not mix different brands or models of brake fluid, also do not use waste brake fluid, so as not to reduce the braking efficiency, resulting in the braking system failure.
- the brake fluid level must not exceed the upper limit of "MAX" mark, so as not to overflow and cause paint corrosion, parts pollution, and even cause fire.

Warning

- Please go to dealership for brake fluid supplement and replacement.

Fluid Replacement







In order to ensure the normal operation of the braking system, brake fluid should be replaced regularly according to the provisions of the <maintenance information table>. Please go to dealership for brake fluid replacement.

Danger

- It may cause failure of the brake system and cause serious accidents if not replace the brake fluid in accordance with the specified time
- if the brake liquid level is lower than the Min. limit, do not drive the vehicle to avoid accident.
- if the brake fluid remains in the hydraulic system for many years, the brake fluid will deteriorate, air resistance may generated in brake pipeline, which affect the braking efficiency and driving safety, and may even lead to the brake system completely failure, resulting in accidents.

Battery

Battery warning sign and instructions

| | | |
|---|---|---|
| 1 |  | No open flames, spark, bright light and smoking in the workplace! |
| 2 |  | Must wear goggles when operating! |
| 3 |  | Children must stay away from electrolyte and vehicle batteries! |
| 4 |  | Battery electrolyte is a strong corrosive substance, the operation must wear protective gloves and goggles! |
| 5 |  | Be sure to read the battery manual carefully before starting the operation! |
| 6 |  | Battery charging will produce explosive mixture of gases! |

Danger

- do not allow flames or sparks to near the battery.
- do not make the battery terminal short circuit, or the high-energy spark generated by short circuit may hurt the operator.
- before operating the battery, touch the body to eliminate any existing static build-up, so as not to generate sparks that may ignite highly explosive battery gas.
- acid in the battery is strongly corrosive, should wear protective gloves and protective glasses. Do not turn over the battery, or the acid may flow out of the vent.
- children should stay away from acid and battery.

Danger

- If acid gets into your eyes, rinse immediately with water for a few minutes and seek medical attention immediately. If the acid splash on the skin or clothes, immediately with a dry cloth to absorb, and then rinse with soap and water. If you drink acid by mistake, seek medical advice immediately.

Environmental instruction



The battery contains pollutants. It is against the law to dispose of a battery together with household waste. Batteries must be sorted and collected and recycled in an environmentally friendly way.



Please dispose of batteries in an environmentally friendly manner. The battery will be exhausted to the dealership or a special battery recycling point.

Check battery

1. Check whether the battery is fixed.
2. Check whether the positive and negative pole of the battery Loose or corrosive.
3. Check whether the insulating layer of the battery positive and negative broken.
4. Keep the the surface of battery dry and clean, prevent to block the battery vent. Before long-distance traveling or after use of the battery for more than one year, you should go to the BAIC dealer to check battery power.

Jumper start

If the vehicle needs to be driven over a long distance or in a hot region or the battery is used for more than 1 year, you should check battery power in BAIC dealer.

If you need start engine by using the battery of another car via a jumper cable, see "jumper start". If you cannot start, should replace battery. Please contact an authorized BAIC dealership to replace battery.

Changing battery

If the vehicle is parked for a long time without using, or driven for frequent short trips, or operated in cold environment, the battery needs to be charged regularly. Please come an authorized BAIC dealership to charge.

Warning

- Do not charge the battery when it is not removed. Otherwise, it could seriously damage the electrical components of the vehicle.
- Do not attempt to charge the battery if the battery is frozen in cold environments, because there is the risk of explosion.

Protection in winter

Since the starting power provided by the battery at low temperature is lower than that at normal temperature. Therefore, before winter, you'd better go to the authorized dealer of BAIC for inspection of the vehicle battery, and charge the battery or replace it if necessary.

In extremely cold weather conditions, battery charging will take longer. If the battery is insufficiently charged, the battery fluid will freeze and damage the battery. To ensure effectiveness of the battery, you should check it regularly.

If the vehicle is parked for several weeks or longer in extremely cold environments, the vehicle battery should be removed and stored at room temperature to protect the battery from freeze damage.

Vehicle is not used for a long time

When the vehicle is not used for more than a month, you should disconnect the negative battery cable, and charge the battery once a month.

If the vehicle is not used and the battery is not used for a long time, the battery will fail due to self-discharge.

Replace Battery

Before the operation, be sure to carefully read and comply with the safety instructions relating to handling of battery.



When replacing the battery, ensure the battery is installed correctly, and terminal toward the middle of the vehicle and positive terminal facing forward. Ensure the battery tray and plate is properly fixed to prevent movement of the battery in an accident or emergency braking.

Note

- When remove the battery, please disconnect the negative cable firstly, and then disconnect the positive cable . Before connecting the battery again, please turn off all electrical equipment on the vehicle. Firstly connect the positive cable, and then the negative cable.

Warnings

- Replace only with battery of the same specification. When using battery of other specifications, they may be cannot installed in place or it is difficult to connect the battery cable due to terminal position, and may even lead to electrical component fault or damage.
- Removing and instal l ing the battery requires a certain expertise and tools, because in some cases, it may damage the battery and fuse box. It is recommended to go to the authorized dealer of BAIC for replacement of battery

Windshield washing fluid

Add windshield washing fluid



The washing fluid of the windshield washer is supplied by the washing fluid reservoir located in the engine compartment. When using windshield washer, the washer nozzle can only spray washing fluid intermittently, or does not spray the washing fluid, it indicates that the washing fluid may be lack. If it is found that the washing fluid level is too low, you should add the washing fluid to the fluid reservoir.

If windshield washing system still does not work when you add enough washing fluid, please contact the authorized dealer of BAIC for inspection.

In order to obtain good washing effects, please use special washing fluid. You should fill the washing fluid slowly.



Warning

- You should promptly add special windshield washing fluid, avoid scraping in dry state. Otherwise, it will damage the wiper blade and easily scratch the windshield.

- When ambient temperature is below 0°C, the washing fluid with the corresponding freezing ability should be used.



Danger

- Be sure to observe safety rules when working in the engine compartment.
- You shall not add coolant or any other additive to the windshield washing fluid. Otherwise, it will leave oil stain when cleaning the glass, which will seriously affect vision and cause an accident.
- Do not let dirt enter into the washing fluid, or it may clog or damage the washer nozzles.

Replace windshield wiper blades



Warning

- Wipers must be kept in good state, that it is necessary to get a clear view.
- In order to prevent horizontal stripes forming on the glass surface when wiping, the wiper blade should be cleaned regularly.
- If wipers were very dirty, you could use a sponge and cloth to clean wiper films.
- If the weather is cold, you should check whether the wiper blades are frozen every time you turn on the front windshield washer. You can only turn on the windshield washer in the case of no interference and obstacles.

Wiper wiping noise may be caused by the following reasons:

- Hard wax residues are consolidated on a windshield when washing the vehicle in an automatic vehicle washing equipment. This hard waxy residue can only be removed with a special cleaner.

- If the wiper blade is damage, it also may cause friction sound, and then you replace the wiper blade.

- There is dust or foreign material on external surface of windshield.

- The positioning angle of the wiper arm is not correct. In such case, please get the angle inspected and adjusted by the authorized dealer of BAIC.

Suggest that regular check wiper films, and as requiredOtherwise, it may scratch the windshield.



1. Lift up the wiper arm from windshield. Place a thick towel in the lower part of the wiper arm to prevent damage to windshield because the wiper arm accidentally bounce back.



Warning

- When you replace wiper, you should ensure turn off the power, to avoid accidentally action of wiper, damage wiper arm or injure others.

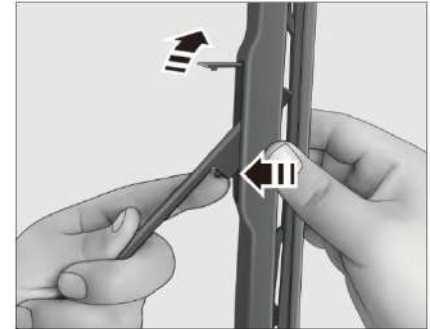

2. Opened the cover, turn the wiper with about 15 ° angles wiper arm.

3. index finger lightly touch wiper chip lock card buckle and maintain.

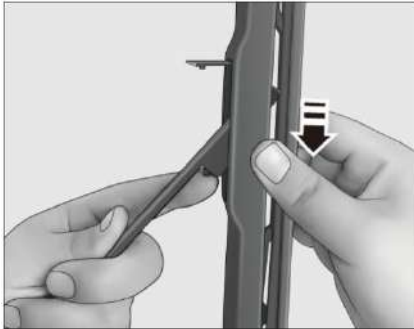

4. hold the wiper along the direction of the arrow take off the wiper film.

 **Warning**

- After removing the wiper blade, you should be very careful, and place a thick towel in the lower part of the wiper arm to prevent damage to windshield because the wiper arm accidentally bounce back.

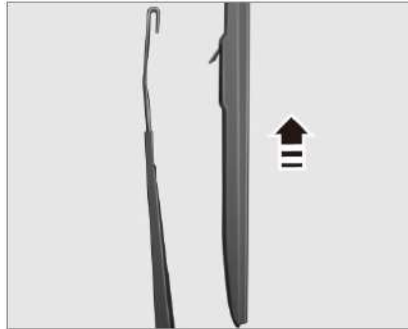

5. Replace with new wiper blade
6. Block the wiper blade wiper arm up ward into the groove, and it indicates it is installed in place when you hear the "click".
7. Check the wiper blade installation is reliable, remove the towel, place the wiper arm gently back into place.

 **Note**

- In driving should keep good vision.
- Regularly clean the wiper blades
- and all window glass.
- Wiper blades should be replaced
- 1-2 times per year.
- Please try to avoid wiper scrape glass without washing liquid, in order to avoid wear and damage of the adhesive tape and scratch of the windshield, thus affecting driving safety.

Warning

- Before replacement of wiper blade is completed, do not turn on the power, to avoid damages to windshield and engine hood due to sudden movement of wipers.
- After remove the wiper assembly, take care the wiper arm, avoid it suddenly back, damage to the wind window.

Tire and wheels inspection

Inspect appearance of tire and wheels

Check the all tires before driving, and regularly check for bulge, scratches, abnormal wear, cracks and iron nail on the tread and sidewall. You should not drive if above phenomena exist, and contact the authorized dealer of BAIC inspection and replacement. Some tire damage is difficult to detect.

If abnormal vibration or deviation is found when the vehicle is traveling, one tire may have fault. You should go to the authorized dealer of BAIC for tire inspection as soon as possible at this time.

Common causes for damage of tire:

- The tire collides or rubs with road shoulder;
- Drive quickly passing through pit on the road;
- Tire pressure is too low or too high.

Regularly check the whole tire depth and width. Too low tread depth is will reduce tire adhesion. Especially in the wet road, it will increase the risk of water slide appearance, which would serious affect driving safety.



There are wear marks on every genuine tire, which are located at the bottom of thread pattern and distributed along the circumference of tire. If the tread wear to the mark, and you should replace the tire.

Check all wheels equipped with the valve cap, and check tire valve for dirty and leakage. Please do not install any parts on the tire valve.

You should always check the condition of the rim. If the rim distorts, deforms, cracks, severe corrode or scratches, it should be replaced. If the wheel mounting bolts often become loose, you should replace the rim and wheel mounting bolts.

 **Warning**

- You should not continue driving when tire bulge, cracks, and other phenomena exist. Because the tire may burst during driving, causing a traffic accident and injury.

Check tire pressure.

General descriptions

Suitable tire pressure can extend the life of the tire, while improving driving comfort, fuel economy, and handling stability.

When the tire pressure is too low, it will increase tire wear and will greatly affect the steering stability and fuel economy of the vehicle, and increases the risk of tire fault. Too high tire pressure may cause unsmooth running of vehicle and uneven wear of tire, so that the service life of tire will be shortened.



Check the tire pressure at least once one month, after driving on the bumpy road or before a long distance driving (including spare wheel). The spare wheel pressure should be 4.2 bar.

You should only check the tire pressure when the tire is cold. Cold tire means the vehicle is not driven at least for three hours or after the vehicle travels no more than 1.6km.

About cold tire pressure standard, see "Tire Information".

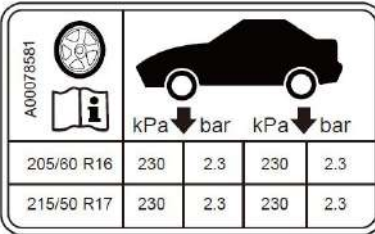
Tire information



| | | | | | |
|-----------|---|---|-----|-----------|-----|
| A00075581 |  |  | | | |
| | | kPa ↓ bar | | kPa ↓ bar | |
| | 205/60 R16 | 230 | 2.3 | 230 | 2.3 |
| | 215/50 R17 | 230 | 2.3 | 230 | 2.3 |

Data label about tire information is pasted on the left B pillar, and you should inflate the tire in accordance with the specified the tire pressure on the data label.

Tire pressure inspection with pressure

You can check tire pressure with a tire gauge when the tire is cold.



1. Remove the valve cap from the tire valve, and check the tire valve with soap method for leakage.

Caution

- You may add domestic detergent into fresh water, apply the solution to the valve inside, and observe whether there is any bubble generated. If there is bubble generated, it means that the air leaks.



2. Place the tire pressure gauge against the valve with force, and the gauge will show the tire pressure.

3. Check and adjust the tire pressure until it meets the standard value. See "Tire Information for standard tire pressure sign. After the inspection is completed, be sure to mount the valve cap onto the valve inside. Valve cap can prevent dust and moisture from entering into the tire valve.

Caution

- After traveling for some time, the pressure in the tire should rise by 0.2 ~ 0.5bar. You check the tire pressure at this time. Never deflate tires in order to make measured tire pressure meet the standards. Otherwise, the tire pressure in cold state will be lower than the standard value.

Danger

- If the vehicle travels at high speed when the tire pressure is obviously insufficient, the tire will deform continuously, which can easily lead to overheating and tire burst.

Wheels transposition

The purpose of regular wheel transposition is to make all the tires are worn evenly, thus extending the overall life of tires. Implement wheel transposition after driving every about 10,000km.

Before wheel transposition, you should check the tire and wheel for damages, and continue wheel transposition and wheel alignment if there is no damage.

Warning

- During wheel transposition, the front wheel should maintain a better state.
- If one tire is worn unevenly or excessively, you should go to the authorized dealer of BAIC for wheel alignment.

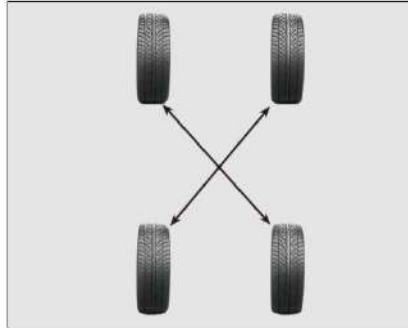

During wheel transposition, wheel transposition shall be carried out in diagonal manner. Spare wheel does not participate in transposition.

After transposition of rear wheels, ensure all the wheel bolts are tightened to $110\pm 10\text{N}\cdot\text{m}$. And adjust pressure of all tires to the specified value. After traveling 1000km, check the wheel bolts tightening situation again.

Danger

- Dirt on the joint surface between wheel and brake disc may cause wheel bolts loosening, causing the wheel to fall off and traffic accidents. Therefore, when replacing the wheels, the corrosion or dirt on the joint surface between the wheel and the brake disc should be cleaned

Wheel balance inspection

Wheel dynamic balancing has been carried out for the vehicle in the factory, but many factors will affect the wheel balancing in the use course of the vehicle.

Dynamic wheel imbalance can lead to wheel wobble and abnormal tire wear during operation, thus affecting vehicle stability. Therefore, you should regularly check the vehicle BAIC dealership for wheel balancing inspection.

Tire selection and replacement

Purchasing tire



Check the vehicle tire label, you can know the models and sizes of tire.

On the one axle, you must use the same brand, specifications, size, tread pattern and new degree Tire.

Tire replacement

If any of the following situations occurs, tires will need to be replaced:

- The tire wear indication mark has shown signs of wear.
- Cord threads or fabric in the tire rubber are visible.
- Treads or tire walls crack to a depth that makes cord threads or fabric visible.
- Tires bulge, warp or stratify.
- Tires are punctured, scratched or bear other damage, and the size and position of the damage can hardly be repaired.
- The date of produce of tire , from the date of production, the tire age(Including spare parts) reaches 6 years.

Warning

- After replacement tires, you should adjust tire pressure to the standard, and initialize tire pressure system (see "tire information").

Danger

- Don't use any used wheel or used tire come from unknown resource, because though there is no visible damage on such wheel or tire, may be it has been damaged, and when the vehicle is running, they may get the vehicle out of control and cause traffic accident.
- Road adhesion of new tires may not reach optimal state during the first 500km, so you should drive carefully at appropriate speed, and implement running-in of new tires to prevent accidents.

 **Danger**

- Even if the tire is not used, it will age with the time. No matter how much the tire tread remains, the tire should be replaced after 6 years.
- Often traveling in hot environments or with overload will lead to accelerated aging of the tire due to overheating, tire life will be reduced, so you should more frequently inspect tires to prevent tire suddenly bursting, causing the accident.
- Mix using tires of different brands, with different structures (radial and bias belted tires), different sizes, and different treads will result in adverse effects on braking and handling performance, and may cause an accident.

Winter tire

 **Caution**

- Winter tires can improve the manipulation stability when vehicles running on the icy road. Suggested that change when the temperature is below $-7\text{ }^{\circ}\text{C}$ in winter tires.

 **Warning**

- If the highest allowed speed of installation winter tires are lower than the maximum design speed, corresponding warning labels must be post in the driver's sight range.
- The vehicle can not run over the maximum permissible on the winter tires speed. If that tires may be a sudden loss of pressure, hulling, even puncture, easy to cause an accident!

Recommended to use the same size winter tires, and replace four tires. In winter, winter tires can improve the vehicle's stability . Once the temperature rises to more than $7\text{ }^{\circ}\text{C}$, you should immediately replace summer tires. Because in road without snow and ice, summer tires' stability is better than winter tires.

Accidental burst handling

In case of a burst, it is recommended to take the following countermeasures:

- If one front tire bursts, the vehicle will deviate to the side under the dragging effect of the flat tire. You should immediately release the accelerator pedal, hold the steering wheel to control the steering, keep the vehicle in the original lane, and slightly depress the brake pedal to stop the vehicle in the emergency lane or safe location, and then replace with the spare wheel.

- If one rear tire bursts during driving, the vehicle may have abnormal vibration and noise, but you can still control the steering. Release the accelerator pedal at this time, turn the steering wheel to the desired direction to drive the vehicle, in order to maintain control of the vehicle, and slightly depress the brake pedal to stop the vehicle in the emergency lane or safe location, and then replace with the spare wheel.

Replacement of rim

If the rim distorts, deforms, cracks, severe corrode or scratches, it should be replaced. If a flat tire is caused by rim damage, the rim should be replaced (except some repairable aluminum rims).

The new rim should have the same load capacity, diameter, width and alignment as those of the original wheels. The new rim should also be mounted identically as the original wheels.

Warning

- Use of an improper rim will affect the vehicle's braking and handling, and may cause the tire to disengage from the rim, resulting in loss of control of the vehicle and causing the accident.
- Use of rims not meeting specification will result in problems in bearing life, brake cooling, speedometer and odometer calibration, vehicle ground clearance, clearance between tires or tire chains and the body and chassis and other aspects.
- It will also be dangerous if the vehicle is installed with old rims. Because you cannot know how the old rim had been used and how much mileage has it been used. Invisable cracks could lead to accidents when driving

Tire chain

Do not install tire chains without the approval by BAIC. Improper snow chains can damage vehicle tires, rims, brakes, and body. During use, pay attention to the following issues:

- Tire chains only can be installed on front wheels;
- Please observe the installation instruction of tire chains and speed limits for different road conditions;
- To prevent wheels being damaged and tire chains being abraded severely, be sure to remove tire chains when traveling on road without snow.

Clean the outside of the vehicles

Clean the vehicles

Regular maintenance vehicles is necessary for long-term quality.

Warning

- Do not implement maintenance of vehicle with fuel, turpentine, engine oil, nail polish remover, or other volatile fluids, which are all toxic and flammable, and can easily lead to fires and explosions!
- After cleaning vehicle, the braking effect will be reduced, the increased risk. After cleaning, the vehicle should be drive a few minutes at low speed, in safety you can lightly brake many times, quickly dry the brake, and recover braking efficiency.

Note

- Do not clean surfaces of the vehicle with harsh household soap, harsh chemical detergents, and other dissolving agents.
- Do not wash the vehicle when the vehicle body surface is very hot. Otherwise, water spots will form on the paint surface.。
- Do not clean vehicle in direct sunlight.

When clean vehicles

In the following cases, you should clean the vehicle to protect the body paint:

- After traveling in rain, acidic rain may cause damage to the paint surface.
- After traveling along the coast, sea erosion may cause the body to rust.
- When soot, bird droppings, tree oil, metal particles, or bodies of insects and other pollutants remain on the body surface, it may cause damage to the paint surface.

- When dust or mud blocks are left on the body surface, it may cause damage to the paint surface.

Automatic washing machine to clean vehicles

Warning

- The vehicle with sunroof can be cleaned in automatic washing machine, but cancel the last hot wax processes, because the wax be into the roof, can damage the roof after a long time.

Manual clean vehicles

When cleaning vehicles, pay attention to the following:

- Do not use hot water, do not in direct sunlight to clean vehicles.
- With sponge to clean vehicles.
- Use neutral detergent low.
- Use moderate injection water to clean vehicles.
- Do not use water gun pointed directly at the air intake.
- Use lot of water washing sponge frequently.
- The seams, doors, windows, engine hood and other parts of the vehicle are susceptible to corrosion by deicing salt. Therefore, these positions must be cleaned.
- Ensure the drainage holes underneath the door are smooth.
- Rinse the vehicle with clear water, and wipe dry the vehicle with oiltanned leather.
- Don't let the paint dry cleaners.



Warning

- Do not wash the engine compartment with water, because it may cause fault of electrical lines, engines, and related components in the engine compartment.
- It is prohibited to contact electrical components and vents with water or other fluids, as this may damage the electrical components.
- Do not clean surfaces of the vehicle with harsh household soap, harsh chemical detergents, and other dissolving agents.

Remove the stains

You should remove oil stains, chemical pollutant, insect body, oil and fruit juice dripping from trees, etc., at the bottom of the vehicle or elsewhere, so as not to damage the body paint.

Vehicles waxing

Often vehicle waxing can protect the paint and helps to maintain the appearance of the vehicle.

Polishing is required after using wax, in order to remove the wax remaining on body surface.

Warning

- Thoroughly clean the vehicle before waxing.
- You should not use wax containing abrasives, detergents, or mixture, which can damage the body paint.

Clean parts of the vehicle

Wipe the glass outside the vehicle

Clean the windshield, window glass, and rearview mirror with alcohol-based glass cleaner, and wipe glass surface dry with non-woven fabric or suede.

Warning

- When cleaning the dust on windshield surface, do not wipe the windshield directly with a dry cloth or duster, because the dust contains a large number of fine sand, which will leave scratches on the glass in the above described manner.

Vehicle bottom maintenance

In winter, in regions with deicing salts used, you should clean the bottom of the vehicle timely, to prevent corrosion of the bottom of the vehicle and suspension system components due to accumulation of dirt or salt. In the winter or spring, you must check the vehicle bottom for corrosion and sealing conditions.

If necessary, please contact the authorized dealer of BAIC for repairs.

Clean the aluminum alloy rim

Aluminum alloy wheels should be cleaned regularly, particularly when used on road with deicing salt in freezing winter. If wheels are stained with salt, it will corrode aluminum rim and make it fade.

Warning

- Do not clean the wheel with cleaners containing acid or alkali component, in order to avoid corrosion of the aluminum alloy rims.
- After using detergents, rinse the wheel within 15 minutes to wash the detergent completely, so as not to leave marks on the aluminum rims.

Wheels

- When washing the vehicle, you should clean the inside of the wheel.
- When cleaning the wheels, do not use abrasive cleaners.
- Regularly check whether the rim flange for deformation or erosion. Deformation or corrosion may cause leakage or damage to the tire edge.
- Timely remove the stone tablets embedded in the tire tread, so as not to affect tire performance.
- It is recommended to wax the wheels, to reduce erosion to the wheel by soil.

Clean the chrome plated parts

It is recommended to wash the plated parts with chrome polishing agent not containing abrasive, in order to keep bright.

Clean the inside of the vehicle

Wipe the glass inside the vehicle

When wiping the glass in vehicle, do not use tools with a blade or wipe with chlorinated disinfectant, which will damage the rear windshield defogger wire. During vehicle glass fogging in winter, right amount of dedicated glass antifog agent can be sprayed to prevent fogging.

Seat belt

Seat belt webbing can be washed with sponge moistened with neutral detergent. After cleaning, the seat belt webbing should be completely dry before use. You should not withdraw the wet webbing directly within the retractor, to avoid damage to the retractor. Do not wash the seat belt webbing with bleach, dye, and chemical solvents. Otherwise, it will seriously damage the webbing.。

Foot mat

Whatever foot pad is used, you should confirm it is suitable to the vehicle, and it is reliably and properly fixed, so as not to interfere with the pedal.

Warning

- If you use non-fixed foot pad, after sliding it may hinder the operation of the brake pedal and the accelerator pedal, causing serious accidents.

Anti-corrosion measures

Ensure vehicle be free of corrosion

- Regularly clean and wax the vehicle to keep it clean.
- Always check whether there is minor paint damage and make repairs as soon as possible.
- Check the vehicle bottom for accumulation of sand, dirt, or salt, and wash with water as soon as possible if so.

Warning

- It is prohibited to remove dirt, sand or other debris by washing the passenger compartment with water, but rather with a vacuum cleaner or broom.
- Do not allow water or other liquids to contact with the electrical components inside the vehicle. Otherwise, it will damage the electrical components.

Anti-freezing agent and snow-melting agent used on road are corrosive, and they will accelerate corrosion and aging of underbody parts such as the exhaust system, parking brake cable, brake pipelines, bottom plate and the fenders. Therefore, after traveling on such roads, you should clean the bottom of the vehicle timely. Other rust-proof and anticorrosion measures may have special requirements in some regions, please consult with the authorized BAIC dealer .

Most common factors for vehicle corrosion

- Moist dirt or debris accumulates in the body sheet metal cavity or other parts.
- Sand and small stones or small accidents cause damages to paint surface or other protective layer.

Recycling and environmental protection

Material recycling

Plastic

Plastic and rubber parts according to the current regulations as marked. In order to facilitate recovery, the range of materials used has limitations: most plastics are recycled to be thermoplastic materials by melting, granulating, crushing.

Metal

100% can be recycled.

Glass

Can be processed by the glass factory after removed .

Rubber

Tires and seal ring can be used for waterproofing materials, rubber runway, etc after be crushed.

Environmental protection

You can delegate BAIC dealer to maintenance your vehicle to control all kinds of pollution hazards, contribute to environmental protection.

Scrap or damaged parts

Don't throw away, BAIC dealer will take measures with recycling and protecting environment.

Waste oil

BAIC dealer will be responsible for collecting and processing, entrust them to replace can control all kinds of pollution hazard.

Don't throw battery and remote control device battery, they are harmful to the environment, please give them to the collection point.

5. Emergency treatment

| | |
|--|-----|
| Tool kit..... | 222 |
| Warning triangle..... | 223 |
| Spare tire..... | 224 |
| Fuse..... | 230 |
| Fuse box in engine compartment..... | 233 |
| Specification and function of engine compartment fuse..... | 233 |
| Instrument panel fuse box..... | 235 |
| Specification and function of instrument panel fuse..... | 235 |
| Jumper start..... | 238 |
| Emergency towing..... | 239 |

Tool kit

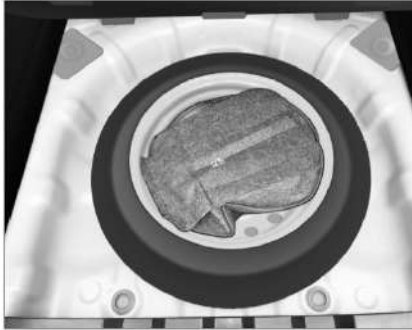

The tool kit is under the luggage compartment floor. Please open the compartment cover, pull up the luggage compartment floor mat hook belt, pull compartment floor mat upward to the top.

CAUTION

- After use, the jack must be put back to its original place. Also pay attention to the supporting angle of the jack and ensure that the jack can be put into the installation box.

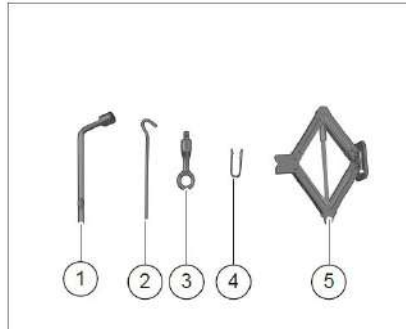

Open the vehicle tool kit, tools that can be used are as follows:

- ① Wheel dismantling wrench;
- ② Jack operating handle;
- ③ Removable traction ring;
- ④ wheel nut cover removal tool
- ⑤ Jack assembly

Reflective Vest

The reflective Vest is in the glove box , when the driver or company used at night or low visibility to process the vehicle failure, to enhance the recognition of outside the car.

Warning

The improper use of jack may cause serious injury.

- Jack assembly is the lift device for emergency replacement wheels, it cannot be used to support vehicle for a long time, and can lift up one wheel.
- The jack may only be used for replacement of wheel. The jack may not be used to lift up any other heavy article or vehicle.
- Please only use the jack on hard and flat ground.
- When using the jack, don't start up the engine, otherwise accident may occur.
- When using the jack to lift up the vehicle, be sure not to place any portion of your body under the vehicle, otherwise accident may occur.
- If it is necessary to carry out operation under the vehicle, be sure to place the appropriate support under the vehicle.

Warning triangle

Warning triangle location

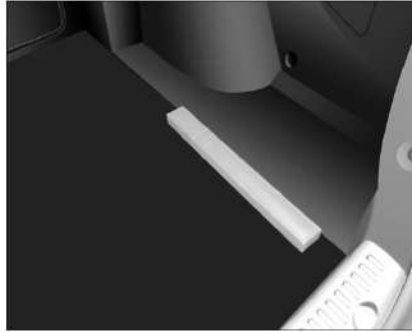

Warning triangle is fixed in the luggage compartment floor mat.

Open and place the warning triangle

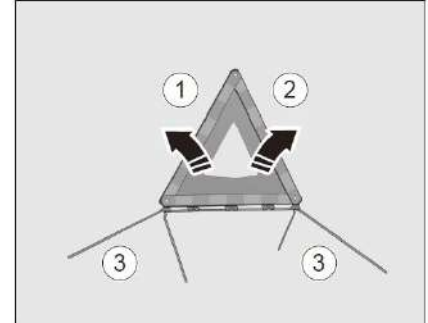

Open two flange of warning triangle ① and ②, lock the top of the mouth. Pull open four stents ③ at the bottom, placed behind the vehicle, and make reflective face back.

The distance of warning triangle

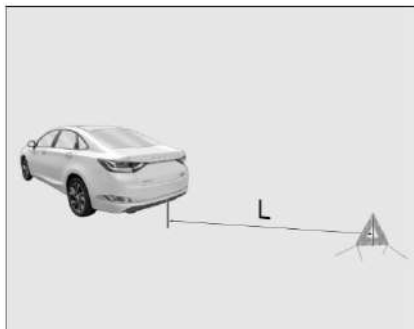

| | Road | Highway |
|------------|---------|---------|
| Distance L | 50-100m | ≥ 150m |

Note

- It is only a reference number, please place warning triangle according to the traffic rules.

Spare tire

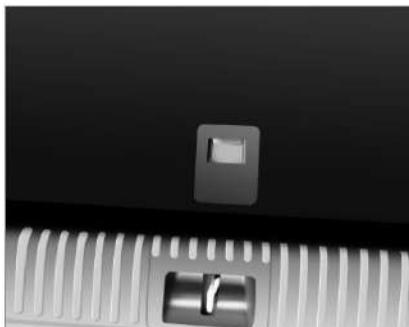

The spare tire is under the luggage compartment floor mat, when you use, please follow the steps below :

1. Open the compartment cover.
2. Lift up the drawstring of luggage compartment floor mat .

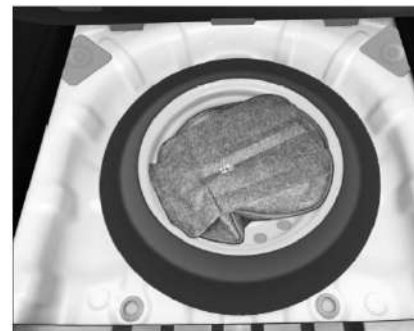

3. open the compartment floor mat completely, take out tool kit.

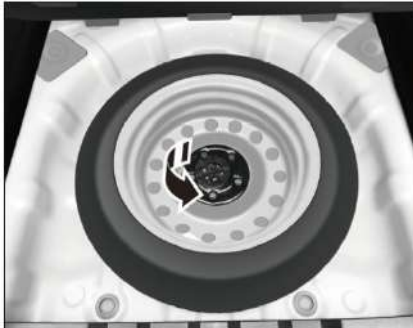

4. Counterclockwise screw out the special-shaped fixed screw I in the center of spare wheel , take out spare tire.

Warning

- Spare wheel rim sizes and tire sizes may be different from those of the damaged wheels. After installing the spare wheel, the vehicle controllability will change. Please reasonably control the vehicle speed, avoid sharp acceleration and emergency braking.
- Spare wheel can only be used in short term. Don't let the vehicle speed exceed 80km/h.
- Do not use 2 or more spare wheels when traveling.

Preparatory work

If the tire burst, puncture, bulge, leakage, and other phenomena exist, you should drive slowly to a flat place where safe operation can be carried out to replace the spare wheel, to avoid further damage to tires and rims. Turn on the hazard warning light at the same time and place the warning triangle in a predetermined distance behind the vehicle.

Warning

It is dangerous to replace the wheel. The vehicle may slide down from the jack, overturn, and hold the operator or others down, causing serious injury or death.

Replace the wheel in a safe flat place. Please strictly comply with the relevant regulations. All occupants shall leave the vehicle and wait in a safe place.

In order to prevent the vehicle from moving, please take the following measures:

- Pull up the parking brake to apply parking brake.
- Place the shift lever to gear "P". (Models with autotransmission)
- Shut down the engine, and do not start the engine during vehicle lifting process.
- Do not allow any person to leave in the vehicle.

Remove the wheel with fault



1. Place appropriate stoppers in front and rear of the wheel which is in diagonal to the wheel with fault, to prevent vehicle movement when jacked up.
2. Place the jack at correct support point. Make sure that the jack is positioned on flat and solid ground.

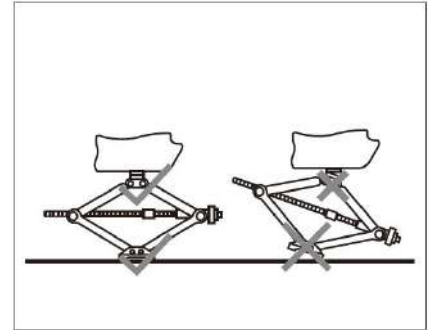

Warning

- Make sure that jack assembly vertical jacking up the vehicle.



3. Rotate the jack screw so that jack head notch blocks the body supporting point, but do not jack up the vehicle.

4. Place the spare wheel below the wheel with fault, in order to play a role in safety precautions.



5. Remove the wheel nut cover with a wheel nut cover removal tool.

6. Counterclockwise unscrew the fault wheel fixed nut with wheel nut wrench

Caution

- You must fully loosen the bolts of the wheel with fault before jacking up the vehicle.
- Do not remove the wheel mounting bolts before the wheel leaves the ground.



7. Rotate clockwise the jack and lift up until the wheel with fault leaves the ground.

8. Remove the wheel mounting bolts, remove the wheel with fault, and place the wheel with fault in the appropriate position below the vehicle with the outer surface upward, and replace the spare wheel.

Note

- When the vehicle is traveling, the heat generated by the brake system can cause wheel mounting bolts hot, so you should be careful not to be injured when dismantling the wheels.

 **Warning**

- Strictly comply with the notices for operation of jack.
- Do not jack up the vehicle at the position other than a predetermined support point.
- Do not place a pad above or below the jack.
- Do not use any jack not equipped with the vehicle.
- Never jack up the vehicle too high.
- In the course of lifting, please continuously observe the conditions of vehicle. If you find that the vehicle is obviously tilted or acts abnormally, please stop the lifting operation, identify and eliminate the problem, and then carry out the operation again.

Install the spare wheel

 **Warning**

- It is prohibited to use the spare wheel with damage or reaching wear limit. Try to avoid using tires more than 6 years.
- After installing the spare wheel, tire pressure should be checked and adjusted to within a predetermined range.
- Spare wheel is only used in emergency situations, so you should drive carefully at speed less 80km/h when spare wheel is used, and avoid sharp acceleration and emergency braking.



1. Align the installation holes on spare wheel with the installation holes on brake disc.

 **Note**

- Before installing the spare wheel, the mud and dirt between the wheel and the brake disc fit surfaces shall be cleaned.

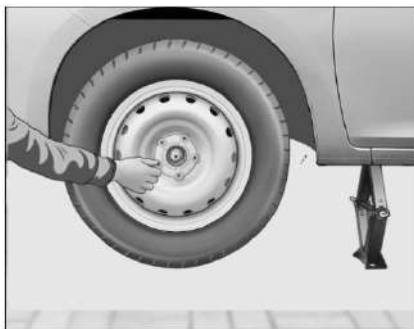

2. Mount all wheel fixing bolts, first tighten them with hand as far as possible, and then push the wheel inward, and then see if you can tighten them further, to confirm wheels are fully fixed.
3. Rotate jack handle counterclockwise, 4. and lower the vehicle.



4. Tighten the wheel fixing bolts clockwise with the wheel bolt wrench, do not use any other tool, such as a hammer and a pipe barrel, and ensure that the wrench completely entangle the bolt.
5. Tighten the wheel fixing bolts in the diagonal sequence as shown in ① to ⑤. The predetermined torque is $110 \pm 10\text{N}\cdot\text{m}$.

Danger

- Please keep the wheel bolts and the thread on rim clean, and make sure no oil stain.
- Please correctly tighten up the
- wheel bolts in accordance with the specified tightening torque, otherwise when the vehicle is running, the bolts may get loosened and thus traffic accident may occur.
- Tighten the wheel bolts with the wheel bolt dismantling wrench provided with the vehicle, but you cannot confirm the torque. Reasonably control the traveling speed, avoid sharp acceleration and emergency braking, and go to the authorized dealer of BAIC as soon as possible to check and ensure the predetermined torque is reached.

Note

- When changing wheels, if bolts have corrosion or hard to be unscrewed, then you must replace the bolts and clean the threaded holes when checking the tightening torque.
- After installing the spare wheel, you should go to the authorized dealer of BAIC for repair as soon as possible, after the wheel with fault is repaired, the spare wheel should be immediately replaced.

Tools and parts are put away

- The dismantled wheel with fault should be placed at the position .
- After being used, the tool kit shall be cleaned in time and then placed in their original position.
- After replacing the wheel, do not forget to take the warning triangular.

Fuse

Instrument panel fuse box



The instrument panel fuse box is located in the lower left side of the instrument panel, and you can see it by removing the instrument panel fuse box cover①.

Fuse box in engine compartment



Engine compartment fuse box is in the left side of the engine compartment.

Check or replace fuse

If any electrical equipment does not work, firstly inspect whether it is caused by damage of fuse. You can determine which one or several fuses control the component in accordance with the chart.

Before determining whether the damaged fuse is the fault reason, replace all the fuses with fault and check whether electrical equipment can work properly. If the fault persists, please contact the authorized dealer of BAIC for repair.

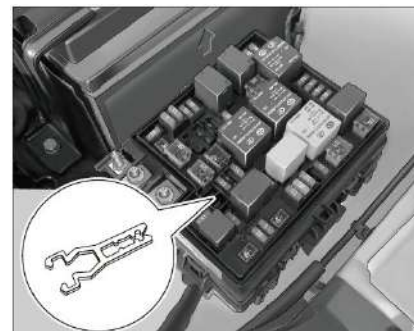

You can pull the fuse out with the fuse puller on the box.

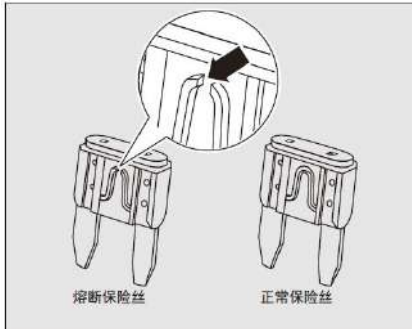

Unplug the fuse corresponding to the electrical equipment not working and check it.

Check whether the fuse wire is blown. If it has blown (the fuse indicated by the arrow has disconnection phenomenon), and replace it with spare fuse of the same or lower amperage.

If the fuse with the same rating blows in a short time again, it indicates that the vehicle may have a serious electrical fault. It is prohibited to use the faulty electrical equipment, leave the blown fuse in the fuse box, and contact the authorized dealer of BAIC for repair.

Caution

- If there is no spare fuse can be replaced with and the vehicle cannot move, you can remove a fuse with equal or lower amperage from other circuit. But you ensure the electrical equipment is not temporarily used, and it will not affect driving, such as the cigarette lighter or the radio.

Note

- If you replace the blown fuse with a spare fuse with lower amperage and the fault is eliminated, you should also replace it with fuse of the correct rating as soon as possible.

Fuse box in engine compartment

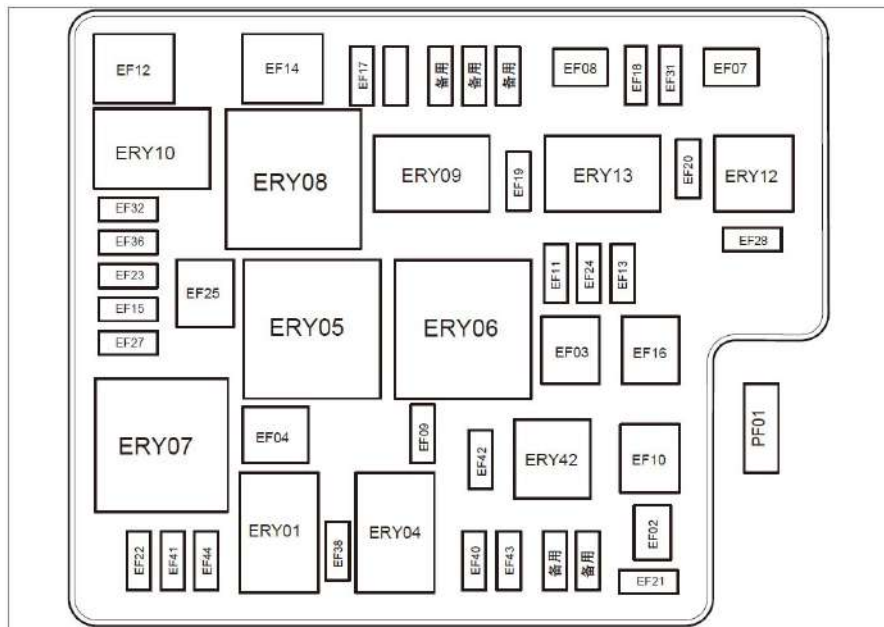

Specification and function of engine compartment fuse

| Number | Specific ations | Protective Circuit |
|--------|-----------------|--|
| PF01 | 125A | Generator |
| EF02 | 30A | Start power supply |
| EF03 | 40A | High-speed fan |
| EF04 | 40A | Blower |
| EF07 | 40A | ESP |
| EF08 | 40A | ESP |
| EF09 | - | Reserved |
| EF10 | 30A | Low-speed fan |
| | 50A | PWM Fan2* |
| EF11 | 15A | Horn relay |
| EF12 | 50A | Power of instrument board electrical box |
| EF13 | 15A | Power of body control module(BCM) |
| EF14 | 60A | Power of instrument board electrical box |
| EF15 | 5A | Battery power sensor |
| EF16 | 60A | Electronic power steering motor |
| EF17 | 15A | Fuel pump relay |
| EF18 | 5A | Blower relay |
| EF19 | 20A | Front washer |
| EF20 | 5A | EMS ST |
| EF21 | 10A | Compressor |
| EF22 | 10A | EMS |

| Number | Class | Protective Circuit |
|--------|-------|---|
| EF23 | 15A | TCU |
| EF24 | 5A | Double module headlamps |
| EF25 | - | Reserved |
| EF27 | 15A | High beam light |
| EF28 | 15A | Body control module(BCM) |
| EF31 | 10A | Brake switch power supply |
| EF32 | 10A | Lift light lamps / backlight adjust / headlight switch to adjust height |
| EF36 | 10A | Right front combination lights |
| EF38 | 5A | Start feedback signal |
| EF40 | 10A | Rear oxygen sensor / Air intake OVC/ carbon canister solenoid valve/ Front oxygen sensor /pressure-increasing leaking control valve/ the waste gate control valve/ neutral switch / Electronic thermostatic |
| EF41 | 10A | fuel spray nozzles |
| EF42 | 15A | Electronic vacuum pump |
| EF43 | 10A | Engine control unit |
| EF44 | 15A | Ignition coil |
| ERY01 | - | main relay |
| ERY42 | - | Electronic vacuum pump relay |

| Number | Class | Protective Circuit |
|--------|-------|---------------------------------|
| ERY03 | - | Compressor relay (built-in) |
| ERY04 | - | Starter relay |
| ERY05 | - | High speed fan relay |
| ERY06 | - | Low speed fan relay |
| ERY07 | - | Blower fan relay |
| ERY08 | - | Front wiper relay 1 |
| ERY09 | - | Front wiper relay 2 |
| ERY10 | - | dipped headlight relay |
| ERY11 | - | High beam light relay(built-in) |
| ERY12 | - | Fuel pump relay |
| ERY13 | - | Transmission chain R2 relay |
| ERY14 | - | Reserved |
| ERY15 | - | Horn relay (built-in) |

Instrument panel fuse box

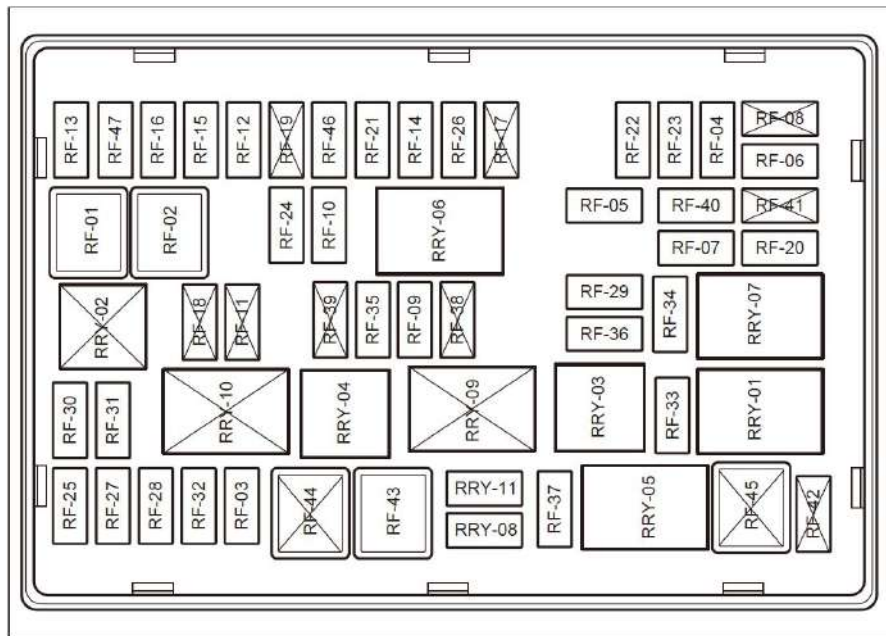

Specification and function of instrument panel fuse

| Number | Class | Protective Circuit |
|--------|-------|---|
| RRY-01 | - | Rear wind heat relay |
| RRY-05 | - | ACC relay |
| RRY-06 | - | IG1 relay |
| RRY-07 | - | IG2 relay |
| RRY-08 | - | Left front fog lamp relay (built-in) |
| RRY-11 | - | Right front fog lamp relay (built-in) |
| RF01 | 30A | Left front / Right rear window |
| RF02 | 30A | Right front/ left rear window |
| RF03 | 20A | Power lock |
| RF04 | 10A | Washer/indoor light* |
| RF06 | 30A | AM1 |
| RF07 | 20A | AM2 |
| RF09 | 10A | Right front fog light |
| RF10 | 5A | Passengers seat heating motor/driver seat heating motor |
| RF12 | 5A | EMS |
| RF13 | 5A | TCU |

| Number | Class | Protective Circuit |
|--------|-------|--|
| RF14 | 5A | Vehicle body controller/ Instruments/ Gateway controller/ Keyless start system controller/ T controller |
| RF15 | 5A | Adaptive cruise |
| RF16 | 7.5A | A/C pressure switch/ ESP controller/ EPB switch/ Transverse angular velocity sensor/ Electronic power steering controller |
| RF20 | 7.5A | Vehicle body controller/ AQS sensor/ Electronic anti glare rearview mirror / Keyless start system controller/A/C control panel/PM2.5 sensor/ Anion generator |
| RF21 | 10A | A/C controller/ Reversing radar controller/ Left rearview mirror/ Tire pressure monitoring controller/panoramic images controller/ rearview mirror/ Channel switch |

| Number | Class | Protective Circuit |
|--------|-------|---|
| RF22 | 7.5A | Vehicle body controller/ Audio controller/gateway controller/keyless start system controller/T controller |
| RF23 | 15A | Cigarette lighter |
| RF24 | 5A | rearview mirror adjust switch |
| RF25 | 15A | Audio controller |
| RF26 | 20A | Sunroof motor |
| RF28 | 7.5A | automobile data recorder/ T controller/ A/C controller panel/ panorama image controller/ |
| RF29 | 7.5A | Electronic steering column lock |
| RF30 | 7.5A | PEPS |
| RF32 | 10A | Instruments/ OBD diagnostic interface/A/C controller/ Gateway controller |
| RF33 | 5A | Left/ right rearview mirror heating |
| RF34 | 30A | Rear windshield heating |
| RF37 | 10A | Left fog light |
| RF40 | 15A | Passenger seat heating motor/ driver seat heating motor |

| Number | Class | Protective Circuit |
|--------|-------|---------------------------|
| RF43 | 20A | Driver seat adjust switch |
| RF46 | 10A | PEPS |
| RF47 | 10A | Airbag |

Danger

- Forbidden to use other materials replace the fuse, in order to avoid damage the vehicle, even may cause fire or casualty.
- Use of an improper fuse may cause a fire or casualties.

Caution

- For different models, the fuse may be slightly different, please check the real vehicle.
- It is likely that an electrical device is equipped with several fuses, and it is also likely that some electrical devices share a fuse.

Replacement of light bulb

Turn signal lamps, brake lights, headlights are related to traffic safety. Check the vehicle lighting before driving each time. Usually you need to remove other related parts when replacing the bulbs, and some bulbs need to be replaced in the engine compartment. Such situation is complex and requires specialized skills and tools, and we recommend you go to the authorized dealer of BAIC for replacement of the bulbs.

Warning

- The bulb may be hot when it just goes out, you should replace it after waiting for the lamp cooling.
- Do not touch the bulb with bare hands, and wrap it with lint-free cloth, so as not to affect the lighting effects.

Specification of bulbs

| Light name | Model | Quantity | Light color |
|-------------------------|------------|-------------------|-------------|
| Front turn signal lamp | PY21VV/LED | Left right each 1 | Amber |
| Front position lamp | LED | Left right each 1 | White |
| Daytime running lamp | LED | Left right each 1 | White |
| Low beam lamp | LED | Left right each 1 | White |
| High beam lamp | LED | Left right each 1 | White |
| Front fog lamp | H8 | Left right each 1 | White |
| Rear position lamp | LED | Left right each 1 | Red |
| Brake lamp | LED | Left right each 1 | Red |
| Rear turn signal lamp | LED | Left right each 1 | Amber |
| Reversing lamp | W16W | Left right each 1 | White |
| High mounted brake lamp | LED | Left right each 1 | Red |
| License plate lamp | WSW | Left right each 1 | White |
| Rear fog lamp | P21W | Left right each 1 | Red |
| Trunk lamp | C5W | 1 | White |
| Door lamp | WSW | 2 | White |
| Glove box light | C5W | 1 | White |
| Front indoor lamp | ciowVled | - | White |
| Rear indoor lamp | C10W | - | White |
| Ambient lamp | LED | - | - |

Jumper start

If the engine can't be started up owing to the fact that the battery has discharged electricity excessively, please start up the engine by connecting the battery on another vehicle with the jumper cable. In such case, please pay attention to the following notices:

- Rated voltage of the battery must be 12V or more, and the capacity (Ah) should not be less than the battery with fault.
- Use only jumper cables with sufficiently large cross-section.
- Only use the jumper cable equipped with insulated electrode holder.

Note

- Before carrying out any operation relating to battery, be sure to carefully read and comply with the safety instructions relating to handling of battery.

Warning

- Don't charge the battery which has been frozen - Danger of explosion! Even for the unfrozen battery, in the course of charging, battery electrolyte may also overflow and cause corrosion. The frozen battery must be replaced.
- There may be explosive hydrogen in the vicinity of the battery. The battery must stay away from sparks and open flames.
- In jump state, the two vehicles may not touch with each other. Otherwise, once the positive poles of two batteries are connected, the circuit will be closed immediately, and thus danger may occur.

When connecting the jumper cable, firstly connect the positive terminal, and then connect the negative terminal.

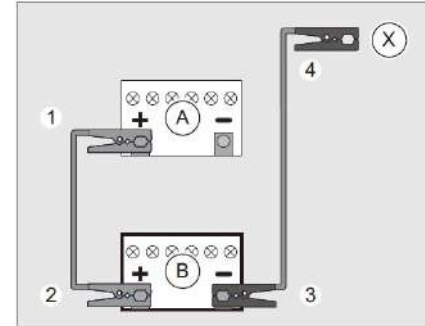

1. Turn off the start/stop button.
2. Connect one end - 1- of the red power cable to the positive pole (+) of the power-receiving battery "A".
3. Connect the other end - 2- to the positive pole (+) of the power supplying battery "B".

4. Connect one end - 3 - of the black power cable to the negative pole (-) of the power-supplying battery "B" and the other end - 4- to the engine cylinder of the power-receiving battery "A" or a metal part which is connected with the engine cylinder.

5 Start the vehicle with the power supplying battery and let it run in idle speed, and then start the engine of the vehicle with the power-receiving battery and let run for a period of time so that the motor charges the power-receiving battery.

CAUTION

- When connecting or removing jumper cables, first fully connector disconnect a jumper cable, then the other jumper cable, never cause a short circuit.
- When removing the jumper cables, first let the fault vehicle engine idle, to prevent stalling.

Warnings

The improper use of jumper cable may cause explosion of battery and serious injury.

- The engine compartment is a high risk area. Improper maintenance could cause fatal accidents extremely easily.
- Absolutely do NOT directly connect the negative power cable to the negative pole of the power receiving battery. Otherwise, sparks will be generated the moment when the power cables are connected. The inflammable gases generated by the battery may be ignited by the sparks, thus causing explosive accidents.
- Absolutely do NOT connect the negative power cable with any part of the fuel system or the brake pipeline. Doing so may cause fire.
- While performing maintenance, be absolutely sure to NOT bend down and face the battery so as to protect against scalding by acids.
- Do NOT touch open flames. Doing so may cause explosiveness, be absolutely sure to NOT bend down and face the battery so as to protect against scalding by acids.

Emergency towing

When you need to tow the vehicle, you must comply with traffic regulations. Improper towing equipment can damage the vehicle. To ensure correct towing method and protect vehicle against accidental damage, it is recommended to find a professional roadside assistance personnel to tow the vehicle. In preparation for towing, the driver and rescue personnel should observe the following precautions:

- Before towing, ensure that transmission, steering and transmission systems are in working status. If the systems are damaged, it is necessary to load the vehicle with a plate rescue vehicle or lift the front wheels for traction.
- The driving (front) wheels of automatic transmission models vehicle must get off the ground while being towed.

Front towing of the vehicle



Install front towing ring

1. Take the wheel dismantling wrench and removable towing ring from the tool kit in the trunk.
2. Press the bottom right corner of towing ring mounting hole cover on the front bumper (shown by the arrow part) to open.



3. Screw the traction ring clockwise completely into the mounting hole of the towing ring.



4. Tighten the towing ring securely with wheel dismantling wrench.

Rear towing of the vehicle



Install rear traction ring

1. Take the wheel dismantling wrench and removable towing ring from the tool kit in the trunk.
2. Press the bottom right corner of towing ring mounting hole cover on the rear bumper (as shown by the arrow) to open it.



3. Screw the traction ring clockwise completely into the mounting hole of the towing ring.



4. Tighten the towing ring securely with wheel dismantling wrench.

Warning

- The inexperienced driver may not tow any other vehicle, otherwise accident may occur.
- When towing the vehicle, be sure to carry out operation under the instruction of professional personnel, otherwise unnecessary injury may occur.

Note

- The hazard warning lamps of the towed vehicle must be turned on, and you should obey traffic laws.
- When towing the vehicle with wire rope, metal chain, or metal bar, it may cause damage to the body, and it is recommended to use a dedicated towing rope.
- Maintain the towing rope on the same straight traveling line with the front and rear vehicles. If the vehicle is towed not in straight, it may damage the body.
- Please ensure that towing rope is always in the tense state.

Dragging the Vehicle

If the vehicle needs to be dragged, we suggest that you entrust an authorized BAIC dealership or an commercial towing company to do it for you. When you contact them, you must tell them how the vehicle needs to be dragged.

To drag the vehicle, a suitable towing device may be used to ensure that the vehicle is dragged without damage. Personnel from commercial towing companies are familiar with the national/provincial/municipal and local towing laws. You may seek help from them.

Using a Flatbed Truck to Drag the Vehicle



The best drag way is to load and fix the fault vehicle on the rescue, the accident vehicle need be dragged, should use this way first.

Warning

- After loaded the fault vehicle, you should apply the electronic parking brake and fix all four wheels properly to prevent the vehicle from moving in the event of emergency braking.

Dragging from the Front



Release the electronic parking brake, lift and fixed front wheels.

Warning

- When the wheels are lifted, be sure to confirm that the opposite end of the lifted side keeps a suitable clearance off the ground. Otherwise, during the dragging the bumper or body of the dragged vehicle might be damaged.

Dragging from rear



Release the electronic parking brake, lift and fixed rear wheels, and fix the front wheels on the small skateboards.

6. Technical Data

| | |
|--|-----|
| Vehicle identification number, product signs and microwave window..... | 245 |
| Vehicle Parameter..... | 249 |
| General technical characteristics..... | 250 |
| Main specifications and capacity of oil..... | 253 |

Vehicle identification number, product signs and microwave window

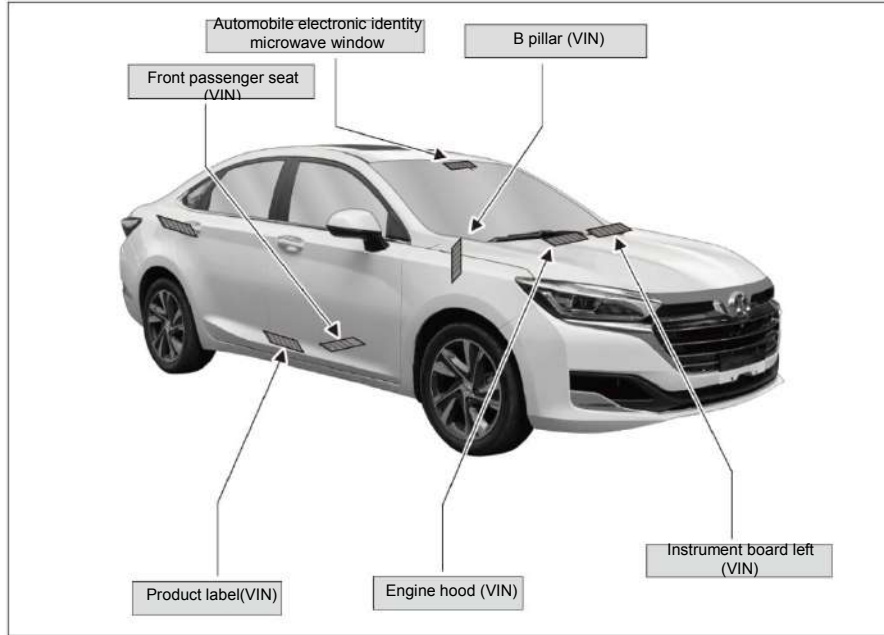

Vehicle identification code (VIN) is a unique identification number of the vehicle, which is marked in the front and rear.



The product label plate is situated under the B pillar on the front passenger side, contains information

Vehicle manufacturers;

Vehicle identification code (VIN);

Brand, the vehicle model; Engine type and engine maximum net power; Engine displacement, maximum allowable total mass; Passenger number, manufacturing date.

Microwave window is used to install auto electronic identification. It is not allowed to have film heating wire, etc., that can ensure the data can be effectively loaded.

Engine And Transmission number (MT model)

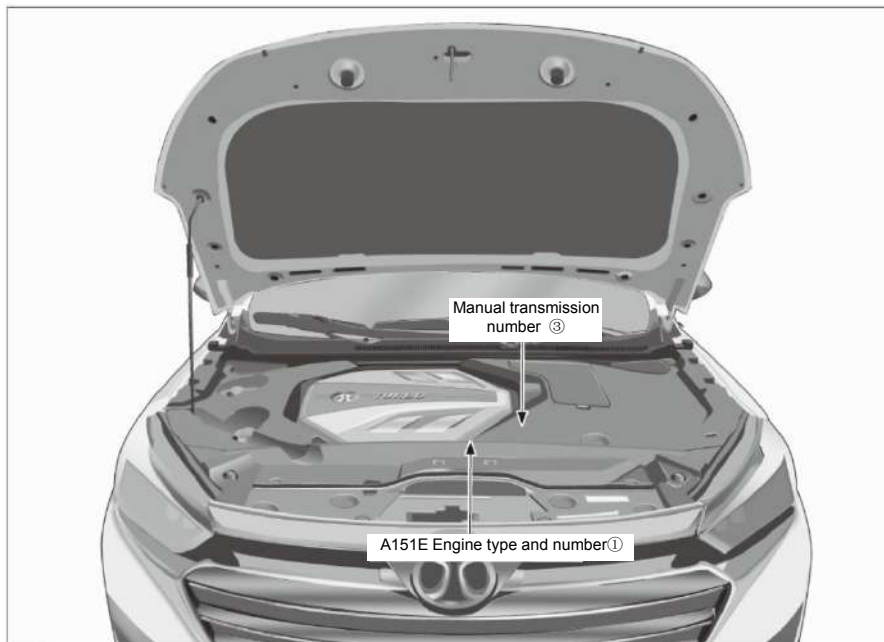

A151E Engine type and number ① is printed on the engine body.
The Manual transmission number is on the transmission label.

Engine And Transmission number (CVT model)

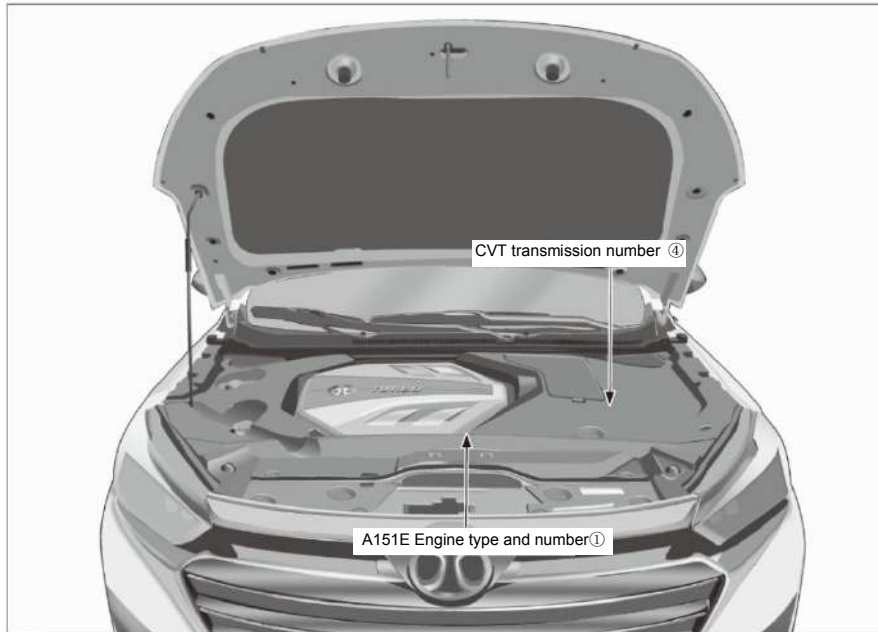

A151E Engine type and number ① is printed on the engine body.
CVT transmission number④ is print the end of transmission cover.

Engine And Transmission number (AT model)

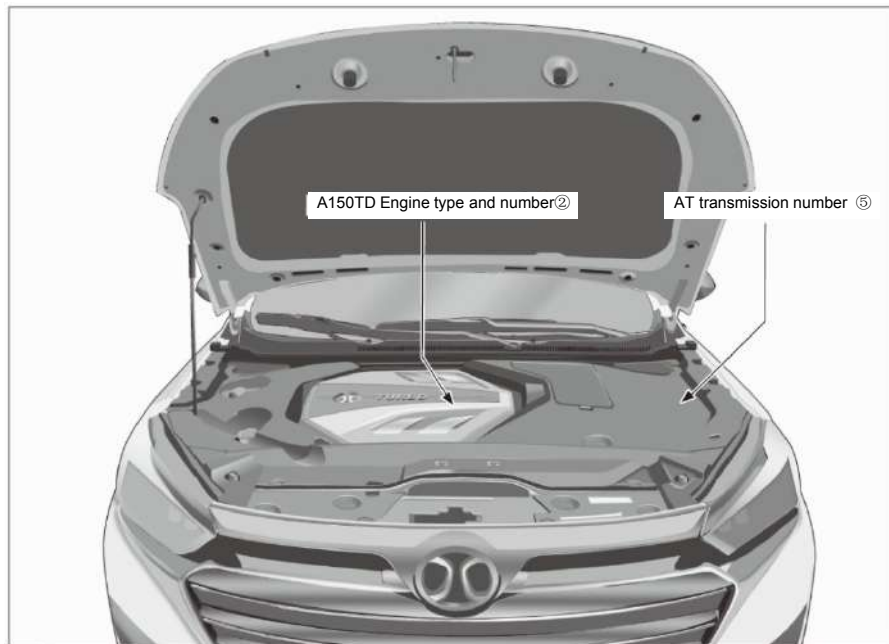

A150TD Engine type and number ② is printed on the engine body.
AT transmission number ⑤ is printed on the rear end of the transmission.

Vehicle Parameter

Dimension: mm

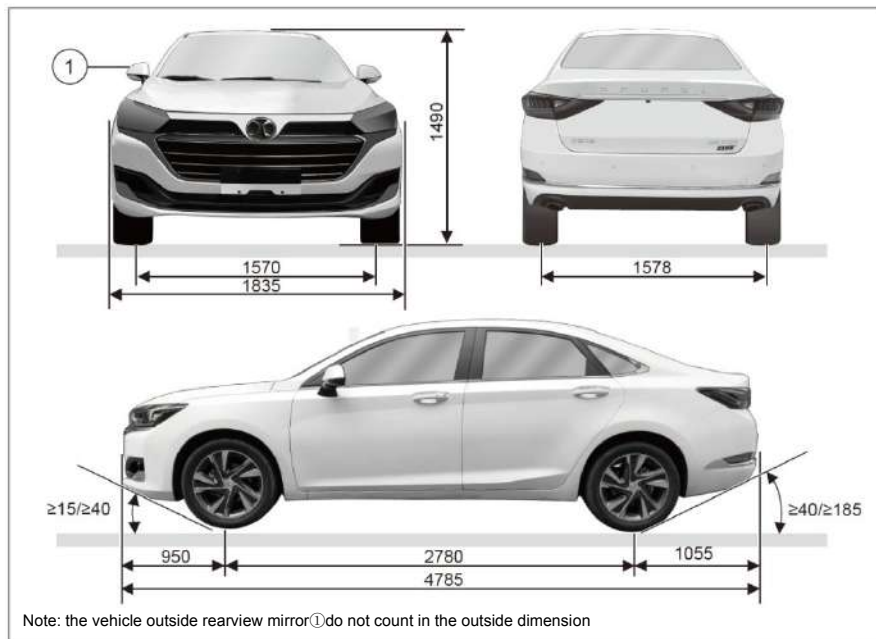

General technical characteristics

| Vehicle type | | BJ7150C5FMB | BJ7150C5FMB-BSG | BJ7150C5FCB | BJ7150C5FCB-BSG | BJ7151C5FAB |
|------------------------------------|----------------------------|--------------|-----------------|-------------|-----------------|-------------|
| Total length (mm) | | 4785 | | | | |
| Total width (mm) | | 1835 | | | | |
| (without exterior rearview mirror) | | 1490 | | | | |
| Total height (no-load) | | 2780 | | | | |
| Wheelbase (mm) | | 1570 | | | | |
| Front wheel track (mm) | | 1578 | | | | |
| Rear wheel track (mm) | | 950 | | | | |
| Front suspension (mm) | | 1055 | | | | |
| Wheel alignment parameters | Wheel camber | Front wheels | -0.45° ±0.5° | | | |
| | | Rear wheels | -0.47° ±0.3° | | | |
| | King pin inclination angle | Front wheels | 13.74° ±0.5° | | | |
| | Kingpin caster | Front wheels | 4.06° ±0.5° | | | |
| | Total toe-in | Front wheel | 0.02° ±0.1° | | | |
| Rear wheel | | 0.09° ±0.04° | | | | |
| Max. gradeability (%) | | ≥ 40 | | | | |
| Maximum vehicle speed(km/h) | | 190 | | 185 | | 200 |
| Number of seats (include driver) | | 5 | | | | |

General technical characteristics

| Vehicle type | BJ7150C5FMB | BJ7150C5FMB-BSG | BJ7150C5FCB | BJ7150C5FCB-BSG | BJ7151C5FAB |
|--|--|-----------------|-------------|-----------------|---|
| Curb weight (kg) | 1345 | | 1355 | | 1435 |
| Front axle load/ rear axle load of curb weight (kg) | 783/562 | | 790/565 | | 870/565 |
| Maximum permissible total mass (kg) | 1785 | | 1795 | | 1875 |
| Front axle load/ rear axle load of Maximum permissible total mass (kg) | 897/888 | | 905/890 | | 997/878 |
| Engine model: | A151E | | | | A150TD |
| Engine type | Inline four-cylinder, water-cooled, multipoint efi gasoline engine | | | | Inline four-cylinder gasoline engine, water cooling, direct injection |
| Emission level | Country V | | | | |
| Fuel | Unleaded petrol of 92# and above | | | | |
| Engine displacement (ml) | 1499 | | | | 1499 |
| Cylinder diameter and Piston stroke (mm) | 75×84.8 | | | | 76×82.6 |
| Compression ratio | 9:1 | | | | 10:1 |
| Maximum net power (kW/rpm) | 100/5500 | | | | 120/5500 |
| Rated output (kW/RPM) | 110/5500 | | | | 124/5500 |
| Maximum net torque (N-m/rpm) | 210/2000-4500 | | | | 250/1600-4400 |
| Idle speed (r/min) | 700±30 | | | | |
| Ignition order | 1-3-4-2 | | | | |
| Fuel consumption (L/100km) | 6.5 | 6.2 | 6.9 | 6.5 | 6.6 |
| Capacity of fuel tank (L) | 52 | | | | |

General technical characteristics

| Vehicle type | | BJ7150C5FMB | BJ7150C5FMB-BSG | BJ7150C5FCB | BJ7150C5FCB-BSG | BJ7151C5FAB |
|---|---------------|-------------------------|---|-------------|-----------------|-------------|
| Brake pedal free travel (mm) | | 6-14 | | | | |
| Wheels | Driving wheel | Tire specification | 205/60R16, 215/50R17 | | | |
| | | Rim specification | 16×6J,17×7J | | | |
| | | Tire pressure | 205/60R16 tire: 230kPa(2.3bar) 215/50R17 tire: 230kPa(2.3bar) | | | |
| | Spare wheel | Tire specification | T125/80R15 | | | |
| | | Rim specification | 15*4T steel rim | | | |
| | | Tire pressure (kPa) | 420 | | | |
| Fore of brake pedal | | < 500 | | | | |
| The distance: form initial position of brake pedal to carpet (mm) (vertical height) | | 172 | | | | |
| Thickness of front brake disc (mm) | standard size | 25 | | | | |
| | wear limit | 23 | | | | |
| Thickness of front brake disc (mm) | standard size | 11 | | | | |
| | wear limit | 2 | | | | |
| Thickness of rear brake disc (mm) | standard size | 10 | | | | |
| | wear limit | 8 | | | | |
| Thickness of rear brake disc (mm) | standard size | 10 | | | | |
| | wear limit | 2 | | | | |
| residual amount of unbalance wheel assembly | | ≤ 6g, reinspection ≤ 8g | | | | |

Main specifications and capacity of oil

| Description of oil and fluid | Specifications | Filling amount of the complete vehicle |
|------------------------------|--|--|
| Oil A115E Engine | SN 5W/30 | 3.5 L (maintenance filling amount) |
| Oil A150TD Engine | SN 5W/30 | 4.0 L (maintenance filling amount) |
| CVT Transmission oil | CVTF-EX1 | 4.35 - 4.45L |
| AT Transmission oil | - | maintenance-free |
| Manual Transmission oil | GL-4 75W-90 | 1.9 - 2.1L |
| Coolant (A151E Engine) | All organic liquid coolant (freezing point [^] -40°C) | 5.5L |
| Coolant (A150TD Engine) | All organic liquid coolant (freezing point [^] -40°C) | 6.5L |
| Windshield washer fluid | Water based cryogenic windshield washer fluid | 1.8 L (volume 3 L) |
| Braking fluid | DOT 4+ | 1L |
| Air conditioning refrigerant | HFC-134a | 500g |

Note:

1. Above capacity is approximate, and the actual amount will be slightly different.
2. The capacity in this table is the design value, and the manufacturer is entitled to adjust the actual amount according to products, equipment, and climate change.
3. The maintenance filling amount is suggested, concrete filling amount need be judged by oil level gauge.

7. Maintenance Information

| | |
|------------------------------------|-----|
| Maintenance Specifications..... | 255 |
| Maintenance Information Sheet..... | 256 |

Maintenance Specifications

Maintenance of the vehicle is generally divided into "General Conditions" and "Harsh Conditions", please make the appropriate maintenance in accordance with conditions of use.

If it is not "harsh conditions", it will be the "General Conditions".

The following are the "harsh conditions":

- Often traveling in dusty regions or frequently exposed to air with high salt-content.
- Driving on uneven road, road with water or mountain road.
- Often driving in cold regions.
- In the cold season, the Engine run idle speed a long time or drive a short distance.
- Frequent use of the brake and emergency braking.
- Often used as a towing vehicle.
- Used as taxi or rental vehicle.

- with traffic jam at the temperature higher than 32 °C exceeds 50 % of total driving time.
- Time of vehicle driving at above 120km/h at the temperature higher than 30 °C exceeds 50% of the total driving time.
- Often travel with overloaded.

Note

- If there is component fault or any other abnormality, you should timely go to the authorized dealer of BAIC for vehicle inspection and maintenance and retain the maintenance records at any time.

Maintenance Information Sheet

| Regular Maintenance Items | Initial maintenance time is 5,000km/6 months (subject to vehicle purchase invoice), whichever comes first. | Regular maintenance interval is 7,500km/6 months (from the last service), whichever comes first. | Additional information |
|--|--|--|--|
| Engine oil/ engine oil filter | • | • | Replace every 2500km under severe using conditions |
| Transmission oil | — | — | Maintenance-free |
| | 6MT | | |
| | CVT | | |
| Spark Plug | — | — | Replace every 50000km/2.5 year (whichever comes first) |
| Fuel filter | — | — | Replace every 15000km/1 year (whichever comes first) |
| Air filter element | — | — | Under general conditions, clean at interval of 10.000 km/6 months cleaning (whichever comes first), and replace in interval of 20000km/1 year (whichever comes first); Under harsh conditions, clean at interval of 5000km/3 months (whichever comes first), and replace at interval of 10000km/6 months (whichever comes first) |
| The air filter element of the air conditioning | o | o | Clean at interval of 10000km/6 months; Replace every 20000km/1 year (whichever comes first) |

Note: •representing replacement orepresenting inspection “—”representing no operation or see additional instructions

| Regular Maintenance Items | Initial maintenance time is 5000km/6 months (subject to vehicle purchase invoice), whichever comes first. | Regular maintenance interval is 7500km/6 months (from the last service), whichever comes first. | Additional information |
|--|---|---|--|
| Check whether ventilation control system of the crankcase is normal or not | — | — | Inspect every 30000km/2 year (whichever comes first) |
| Engine coolant | o | o | Inspect every 40000km/2 year (whichever comes first) |
| Braking fluid | o | o | Inspect every 40000km/2 year (whichever comes first) |
| Front and rear brake pads: Check the thickness and wear of the pads. | — | o | |
| Tire/rim (including the spare wheel) | o | o | Check the tire wear, adjust the tire pressure, and implement wheel transposition or tire hange if necessary. |
| Suspension and steering tie rod ball, steering gear housing, and drive shaft dust shield | o | o | |
| Radiator, brake, fuel pipelines and connections thereof | o | o | If you find abnormal wear rubber hose, swelling, scratch, bums, and oil leakage, you should replace. |
| Door hinge and door stopper, door lock, engine hood, trunk lid hinge and buckle | — | v | Inspect every 20000km/1 year (whichever comes first) |
| Electrical equipment functions (including power window lifter, electric rearview mirrors, air conditioning, sunroof, etc.) | o | o | |

Note: ●representing replacement ○representing inspection “—”representing no operation or see additional instructions

| Regular Maintenance Items | Initial maintenance time is 5000km/6 months (subject to vehicle purchase invoice), whichever comes first. | Regular maintenance time is 7500km/6 months (from the last service), whichever comes first. | Additional information |
|--|---|---|------------------------|
| Idling speed of the engine | o | o | |
| exhaust systems leak or | o | o | |
| Computer-based check: Read out the fault storage information in various system controllers with specialized diagnostic equipment | o | o | |
| Wiper and washing devices | o | o | |
| Battery | o | o | |
| Check the instrument display and the lighting both inside and outside the vehicle | o | o | |
| Maintenance mileage prompt reset | o | o | |
| Parking brake | o | o | |

Note: ●representing replacement orepresenting inspection “—”representing no operation or see additional instructions