



**CFR 47 FCC PART 15 SUBPART C
ISED RSS-247 ISSUE 2**

TEST REPORT

For

Robotic Vacuum Cleaner

MODEL NUMBER: Q100TSC

HVIN: Q100TSC-BLM6

REPORT NUMBER: 4790648002-1-RF-1

ISSUE DATE: January 29, 2023

FCC ID:2AN2O-Q100TSC01

IC:23317-Q100TSC01

Prepared for

Beijing Roborock Technology Co., Ltd.

**Floor 6, Suite 6016, 6017, 6018, Building C, Kangjian Baosheng Plaza, No. 8
Heiquan Road, Haidian District, Beijing, P.R. China**

Prepared by

UL Verification Services (Guangzhou) Co., Ltd, Song Shan Lake Branch

Building 10, Innovation Technology Park, No. 1, Li Bin Road, Song Shan Lake Hi-Tech Development Zone Dongguan, 523808, People's Republic of China

Tel: +86 769 22038881

Fax: +86 769 33244054

Website: www.ul.com

The results reported herein have been performed in accordance with the laboratory's terms of accreditation. This report shall not be reproduced except in full without the written approval of the Laboratory. The results in this report apply to the test sample(s) mentioned above at the time of the testing period only and are not to be used to indicate applicability to other similar products.



Revision History

Rev.	Issue Date	Revisions	Revised By
V0	January 29, 2023	Initial Issue	



Summary of Test Results

Test Item	Clause	Limit/Requirement	Result
Antenna Requirement	N/A	FCC Part 15.203/15.247 (c) RSS-GEN Clause 6.8	Pass
AC Power Line Conducted Emission	ANSI C63.10-2013, Clause 6.2	FCC Part 15.207 RSS-GEN Clause 8.8	Pass
Conducted Output Power	ANSI C63.10-2013, Clause 11.9.1.3	FCC Part 15.247 (b)(3) RSS-247 Clause 5.4 (d)	Pass
6dB Bandwidth and 99% Occupied Bandwidth	ANSI C63.10-2013, Clause 11.8.1	FCC Part 15.247 (a)(2) RSS-247 Clause 5.2 (a) ISED RSS-Gen Clause 6.7	Pass
Power Spectral Density	ANSI C63.10-2013, Clause 11.10.2	FCC Part 15.247 (e) RSS-247 Clause 5.2 (b)	Pass
Conducted Band edge and spurious emission	ANSI C63.10-2013, Clause 11.11	FCC Part 15.247(d) RSS-247 Clause 5.5	Pass
Radiated Band edge and Spurious Emission	ANSI C63.10-2013, Clause 11.12 & Clause 11.13	FCC Part 15.247 (d) FCC Part 15.205/15.209 RSS-247 Clause 5.5 RSS-GEN Clause 8.9	Pass
Duty Cycle	ANSI C63.10-2013, Clause 11.6	None; for reporting purposes only.	Pass

*This test report is only published to and used by the applicant, and it is not for evidence purpose in China.

*The measurement result for the sample received is <Pass> according to <CFR 47 FCC PART 15 SUBPART C><ISED RSS-247 ISSUE 2> when <Accuracy Method> decision rule is applied.

CONTENTS

1. ATTESTATION OF TEST RESULTS	6
2. TEST METHODOLOGY	7
3. FACILITIES AND ACCREDITATION	7
4. CALIBRATION AND UNCERTAINTY	8
4.1. <i>MEASURING INSTRUMENT CALIBRATION</i>	8
4.2. <i>MEASUREMENT UNCERTAINTY</i>	8
5. EQUIPMENT UNDER TEST	9
5.1. <i>DESCRIPTION OF EUT</i>	9
5.2. <i>CHANNEL LIST</i>	9
5.3. <i>MAXIMUM EIRP</i>	9
5.4. <i>TEST CHANNEL CONFIGURATION</i>	10
5.5. <i>THE WORSE CASE POWER SETTING PARAMETER</i>	10
5.6. <i>DESCRIPTION OF AVAILABLE ANTENNAS</i>	11
5.7. <i>SUPPORT UNITS FOR SYSTEM TEST</i>	12
6. MEASURING EQUIPMENT AND SOFTWARE USED	13
7. ANTENNA PORT TEST RESULTS	16
7.1. <i>CONDUCTED OUTPUT POWER</i>	16
7.2. <i>6DB BANDWIDTH AND 99% OCCUPIED BANDWIDTH</i>	17
7.3. <i>POWER SPECTRAL DENSITY</i>	19
7.4. <i>CONDUCTED BAND EDGE AND SPURIOUS EMISSION</i>	21
7.5. <i>DUTY CYCLE</i>	23
8. RADIATED TEST RESULTS	24
8.1. <i>RESTRICTED BANDEDGE</i>	31
8.2. <i>SPURIOUS EMISSIONS(1 GHZ~3 GHZ)</i>	47
8.3. <i>SPURIOUS EMISSIONS(3 GHZ~18 GHZ)</i>	53
8.4. <i>SPURIOUS EMISSIONS(9 KHZ~30 MHZ)</i>	77
8.5. <i>SPURIOUS EMISSIONS(18 GHZ~26 GHZ)</i>	80
8.6. <i>SPURIOUS EMISSIONS(30 MHZ~1 GHZ)</i>	82
9. ANTENNA REQUIREMENT	84
10. AC POWER LINE CONDUCTED EMISSION	85
11. TEST DATA	89
11.1. <i>APPENDIX A: DTS BANDWIDTH</i>	89



11.1.1.	Test Result	89
11.1.2.	Test Graphs	90
11.2.	<i>APPENDIX B: OCCUPIED CHANNEL BANDWIDTH</i>	<i>94</i>
11.2.1.	Test Result	94
11.2.2.	Test Graphs	95
11.3.	<i>APPENDIX C: MAXIMUM CONDUCTED AVG OUTPUT POWER.....</i>	<i>99</i>
11.3.1.	Test Result	99
11.4.	<i>APPENDIX D: MAXIMUM POWER SPECTRAL DENSITY</i>	<i>100</i>
11.4.1.	Test Result	100
11.4.2.	Test Graphs	101
11.5.	<i>APPENDIX E: BAND EDGE MEASUREMENTS</i>	<i>105</i>
11.5.1.	Test Result	105
11.5.2.	Test Graphs	106
11.6.	<i>APPENDIX F: CONDUCTED SPURIOUS EMISSION</i>	<i>109</i>
11.6.1.	Test Result	109
11.6.2.	Test Graphs	110
11.7.	<i>APPENDIX G: DUTY CYCLE.....</i>	<i>122</i>
11.7.1.	Test Result	122
11.7.2.	Test Graphs	123



1. ATTESTATION OF TEST RESULTS

Applicant Information

Company Name: Beijing Roborock Technology Co., Ltd.
Address: Floor 6, Suite 6016, 6017, 6018, Building C, Kangjian Baosheng Plaza, No. 8 Heiquan Road, Haidian District, Beijing, P.R. China

Manufacturer Information

Company Name: Beijing Roborock Technology Co., Ltd.
Address: Floor 6, Suite 6016, 6017, 6018, Building C, Kangjian Baosheng Plaza, No. 8 Heiquan Road, Haidian District, Beijing, P.R. China

EUT Information

EUT Name: Robotic Vacuum Cleaner
Model: Q100TSC
Brand: roborock
Sample Received Date: November 30, 2022
Sample Status: Normal
Sample ID: 5583806
Date of Tested: November 30, 2022 to January 28, 2023

APPLICABLE STANDARDS	
STANDARD	TEST RESULTS
CFR 47 FCC PART 15 SUBPART C ISED RSS-247 ISSUE 2	Pass

Prepared By:

Kebo Zhang
Senior Project Engineer

Checked By:

Denny Huang
Senior Project Engineer

Approved By:

Stephen Guo
Operations Manager



2. TEST METHODOLOGY

All tests were performed in accordance with the standard CFR 47 FCC PART 15 SUBPART C ISED RSS-247 ISSUE 2, KDB 558074 D01 15.247 Meas Guidance v05r02, KDB 414788 D01 Radiated Test Site v01r01, CFR 47 FCC Part 2, CFR 47 FCC Part 15, ANSI C63.10-2013, ISED RSS-247 Issue 2 and ISED RSS-GEN Issue 5

3. FACILITIES AND ACCREDITATION

Accreditation Certificate	<p>A2LA (Certificate No.: 4102.01) UL Verification Services (Guangzhou) Co., Ltd. Song Shan Lake Branch. has been assessed and proved to be in compliance with A2LA.</p> <p>FCC (FCC Designation No.: CN1187) UL Verification Services (Guangzhou) Co., Ltd. Song Shan Lake Branch. Has been recognized to perform compliance testing on equipment subject to the Commission's Declaration of Conformity (DoC) and Certification rules</p> <p>ISED (Company No.: 21320) UL Verification Services (Guangzhou) Co., Ltd. Song Shan Lake Branch. has been registered and fully described in a report filed with ISED. The Company Number is 21320 and the test lab Conformity Assessment Body Identifier (CABID) is CN0046.</p> <p>VCCI (Registration No.: G-20019, R-20004, C-20012 and T-20011) UL Verification Services (Guangzhou) Co., Ltd. Song Shan Lake Branch. has been assessed and proved to be in compliance with VCCI, the Membership No. is 3793. Facility Name: Chamber D, the VCCI registration No. is G-20019 and R-20004 Shielding Room B , the VCCI registration No. is C-20012 and T-20011</p>
---------------------------	---

Note1:

All tests measurement facilities use to collect the measurement data are located at Building 10, Innovation Technology Park, No. 1, Li Bin Road, Song Shan Lake Hi-Tech Development Zone Dongguan, 523808, People’s Republic of China.

Note2:

The test anechoic chamber in UL Verification Services (Guangzhou) Co., Ltd. Song Shan Lake Branch had been calibrated and compared to the open field sites and the test anechoic chamber is shown to be equivalent to or worst case from the open field site.

Note3:

For below 30 MHz, lab had performed measurements at test anechoic chamber and comparing to measurements obtained on an open field site. And these measurements below 30 MHz had been correlated to measurements performed on an OFS.

4. CALIBRATION AND UNCERTAINTY

4.1. MEASURING INSTRUMENT CALIBRATION

The measuring equipment utilized to perform the tests documented in this report has been calibrated in accordance with the manufacturer's recommendations and is traceable to recognized national standards.

4.2. MEASUREMENT UNCERTAINTY

Where relevant, the following measurement uncertainty levels have been estimated for tests performed on the apparatus:

Test Item	Uncertainty
Conduction emission	3.62 dB
Radiated Emission (Included Fundamental Emission) (9 kHz ~ 30 MHz)	2.2 dB
Radiated Emission (Included Fundamental Emission) (30 MHz ~ 1 GHz)	4.00 dB
Radiated Emission (Included Fundamental Emission) (1 GHz to 26 GHz)	5.78 dB (1 GHz ~ 18 GHz)
	5.23 dB (18 GHz ~ 26 GHz)
Note: This uncertainty represents an expanded uncertainty expressed at approximately the 95% confidence level using a coverage factor of k=2.	

5. EQUIPMENT UNDER TEST

5.1. DESCRIPTION OF EUT

EUT Name	Robotic Vacuum Cleaner
Model	Q100TSC
Frequency Range:	2412 MHz to 2462 MHz
Radio Technology	IEEE802.11b/g/n HT20/n HT40
Type of Modulation:	IEEE 802.11b: DSSS(CCK, DQPSK, DBPSK) IEEE 802.11g/n: OFDM(64-QAM, 16-QAM, QPSK, BPSK)
Normal Test Voltage:	14.4 Vdc

5.2. CHANNEL LIST

Channel List for 802.11b/g/n (20 MHz)							
Channel	Frequency (MHz)	Channel	Frequency (MHz)	Channel	Frequency (MHz)	Channel	Frequency (MHz)
1	2412	4	2427	7	2442	10	2457
2	2417	5	2432	8	2447	11	2462
3	2422	6	2437	9	2452	/	/

Channel List for 802.11n (40 MHz)							
Channel	Frequency (MHz)	Channel	Frequency (MHz)	Channel	Frequency (MHz)	Channel	Frequency (MHz)
3	2422	5	2432	7	2442	9	2452
4	2427	6	2437	8	2447	/	/

5.3. MAXIMUM EIRP

IEEE Std. 802.11	Frequency (MHz)	Channel Number	Maximum Conducted AVG Output Power (dBm)	Maximum AVG EIRP (dBm)
b	2412 ~ 2462	1-11[11]	16.54	19.08
g	2412 ~ 2462	1-11[11]	9.76	12.30
n HT20	2412 ~ 2462	1-11[11]	9.26	11.80
n HT40	2422 ~ 2452	3-9[7]	9.55	12.09

5.4. TEST CHANNEL CONFIGURATION

IEEE Std. 802.11	Test Channel Number	Frequency
b	CH 1(Low Channel), CH 6(MID Channel), CH 11(High Channel)	2412 MHz, 2437 MHz, 2462 MHz
g	CH 1(Low Channel), CH 6(MID Channel), CH 11(High Channel)	2412 MHz, 2437 MHz, 2462 MHz
n HT20	CH 1(Low Channel), CH 6(MID Channel), CH 11(High Channel)	2412 MHz, 2437 MHz, 2462 MHz
n HT40	CH 3(Low Channel), CH 6(MID Channel), CH 9(High Channel)	2422 MHz, 2437 MHz, 2452 MHz

5.5. THE WORSE CASE POWER SETTING PARAMETER

The Worse Case Power Setting Parameter under 2400 ~ 2483.5MHz Band							
Test Software		ADB					
Modulation Mode	Transmit Antenna Number	Test Channel					
		NCB: 20MHz			NCB: 40MHz		
		CH 1	CH 6	CH 11	CH 3	CH 6	CH 9
802.11b	1	99	99	99	/		
802.11g	1	45	45	45			
802.11n HT20	1	45	45	45			
802.11n HT40	1	/			70	70	70

WORST-CASE CONFIGURATIONS

The EUT was tested in the following configuration(s):

Controlled in test mode using a software application on the EUT supplied by customer. The application was used to enable a continuous transmission and to select the mode, test channels, bandwidth, data rates as required.

Test channels referring to section 5.4.

Maximum power setting referring to section 5.5.

Worst-case data rates as provided by the client were:

802.11b mode: 1 Mbps
 802.11g mode: 6 Mbps
 802.11n HT20 mode: MCS0
 802.11n HT40 mode: MCS0

The measured additional path loss was included in any path loss calculations for all RF cable used during tested.



5.6. DESCRIPTION OF AVAILABLE ANTENNAS

Antenna	Frequency (MHz)	Antenna Type	MAX Antenna Gain (dBi)
1	2412-2462	PCB	2.54

Test Mode	Transmit and Receive Mode	Description
IEEE 802.11b	<input checked="" type="checkbox"/> 1TX, 1RX	ANT 1 can be used as transmitting/receiving antenna.
IEEE 802.11g	<input checked="" type="checkbox"/> 1TX, 1RX	ANT 1 can be used as transmitting/receiving antenna.
IEEE 802.11n HT20	<input checked="" type="checkbox"/> 1TX, 1RX	ANT 1 can be used as transmitting/receiving antenna.
IEEE 802.11n HT40	<input checked="" type="checkbox"/> 1TX, 1RX	ANT 1 can be used as transmitting/receiving antenna.

Note: The value of the antenna gain was declared by customer.

5.7. SUPPORT UNITS FOR SYSTEM TEST

Item	Equipment	Brand Name	Model Name	Remark
1	PC	Lenovo	E42-80	/

I/O CABLES

Cable No	Port	Connector Type	Cable Type	Cable Length(m)	Remarks
1	USB	/	/	1.0	/

ACCESSORIES

Item	Accessory	Brand Name	Model Name	Description
1	Charging Pile	roborock	EWFD04LRR config 1	100-127V~, 50-60Hz, 9.5A

TEST SETUP

The EUT can work in engineering mode with a software through a Laptop.

SETUP DIAGRAM FOR TESTS

For others test:

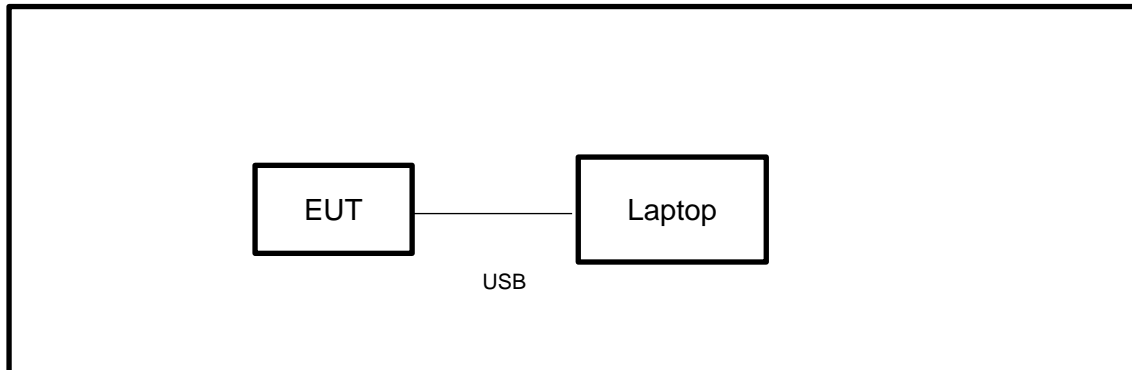

For AC POWER LINE CONDUCTED EMISSION test:

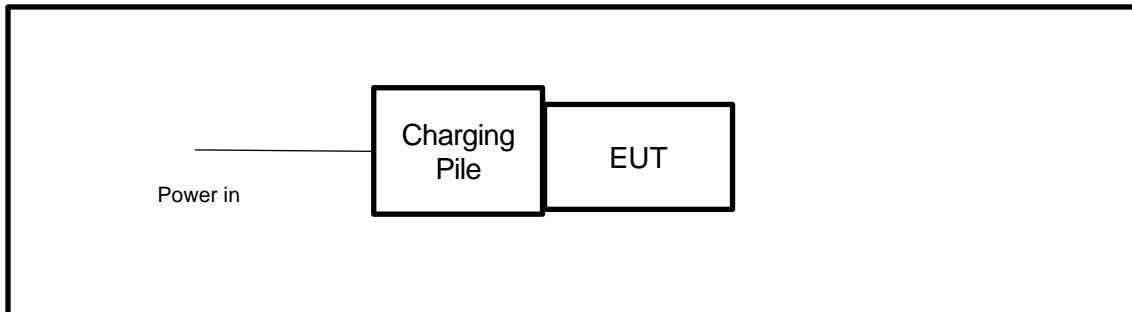

**6. MEASURING EQUIPMENT AND SOFTWARE USED**

R&S TS 8997 Test System					
Equipment	Manufacturer	Model No.	Serial No.	Last Cal.	Due. Date
Power sensor, Power Meter	R&S	OSP120	100921	Apr.02,2022	Apr.01,2023
Vector Signal Generator	R&S	SMBV100A	261637	Oct.17, 2022	Oct.16, 2023
Signal Generator	R&S	SMB100A	178553	Oct.17, 2022	Oct.16, 2023
Signal Analyzer	R&S	FSV40	101118	Oct.17, 2022	Oct.16, 2023
Software					
Description	Manufacturer	Name		Version	
For R&S TS 8997 Test System	Rohde & Schwarz	EMC 32		10.60.10	
Tonsend RF Test System					
Equipment	Manufacturer	Model No.	Serial No.	Last Cal.	Due. Date
Wideband Radio Communication Tester	R&S	CMW500	155523	Oct.17, 2022	Oct.16, 2023
Wireless Connectivity Tester	R&S	CMW270	1201.0002N75-102	Sep.28, 2022	Sep.27, 2023
PXA Signal Analyzer	Keysight	N9030A	MY55410512	Oct.17, 2022	Oct.16, 2023
MXG Vector Signal Generator	Keysight	N5182B	MY56200284	Oct.17, 2022	Oct.16, 2023
MXG Vector Signal Generator	Keysight	N5172B	MY56200301	Oct.17, 2022	Oct.16, 2023
DC power supply	Keysight	E3642A	MY55159130	Oct.17, 2022	Oct.16, 2023
Temperature & Humidity Chamber	SANMOOD	SG-80-CC-2	2088	Oct.17, 2022	Oct.16, 2023
Software					
Description	Manufacturer	Name		Version	
Tonsend SRD Test System	Tonsend	JS1120-3 RF Test System		2.6.77.0518	



Conducted Emissions					
Equipment	Manufacturer	Model No.	Serial No.	Last Cal.	Due Date
EMI Test Receiver	R&S	ESR3	101961	Oct.17, 2022	Oct.16, 2023
Two-Line V-Network	R&S	ENV216	101983	Oct.17, 2022	Oct.16, 2023
Artificial Mains Networks	Schwarzbeck	NSLK 8126	8126465	Oct.17, 2022	Oct.16, 2023
Software					
Description			Manufacturer	Name	Version
Test Software for Conducted Emissions			Farad	EZ-EMC	Ver. UL-3A1

Radiated Emissions					
Equipment	Manufacturer	Model No.	Serial No.	Last Cal.	Due Date
MXE EMI Receiver	KESIGHT	N9038A	MY56400036	Oct.17, 2022	Oct.16, 2023
Hybrid Log Periodic Antenna	TDK	HLP-3003C	130959	Aug.02, 2021	Aug.01, 2024
Preamplifier	HP	8447D	2944A09099	Oct.17, 2022	Oct.16, 2023
EMI Measurement Receiver	R&S	ESR26	101377	Oct.17, 2022	Oct.16, 2023
Horn Antenna	TDK	HRN-0118	130940	July 20, 2021	July 19, 2024
Preamplifier	TDK	PA-02-0118	TRS-305-00067	Oct.17, 2022	Oct.16, 2023
Horn Antenna	Schwarzbeck	BBHA9170	697	July 20, 2021	July 19, 2024
Preamplifier	TDK	PA-02-2	TRS-307-00003	Oct.17, 2022	Oct.16, 2023
Preamplifier	TDK	PA-02-3	TRS-308-00002	Oct.17, 2022	Oct.16, 2023
Loop antenna	Schwarzbeck	1519B	00008	Dec.14, 2021	Dec.13, 2024
Preamplifier	TDK	PA-02-001-3000	TRS-302-00050	Oct.17, 2022	Oct.16, 2023
Preamplifier	Mini-Circuits	ZX60-83LN-S+	SUP01202035	Oct.17, 2022	Oct.16, 2023
High Pass Filter	Wi	WHKX10-2700-3000-18000-40SS	23	/	/
Highpass Filter	Wainwright	WHKX10-5850-6500-1800-40SS	4	/	/
Band Reject Filter	Wainwright	WRCJV12-5695-5725-5850-5880-40SS	4	/	/
Band Reject Filter	Wainwright	WRCJV20-5120-5150-	2	/	/



		5350-5380-60SS			
Band Reject Filter	Wainwright	WRCJV20-5440-5470-5725-5755-60SS	1	/	/
Band Reject Filter	Wainwright	WRCJV8-2350-2400-2483.5-2533.5-40SS	4	/	/
Band Reject Filter	Wainwright	WRCD5-1879-1879.85-1880.15-1881-40SS	1	/	/
Notch Filter	Wainwright	WHJ10-882-980-7000-40SS	1	/	/
Software					
Description			Manufacturer	Name	Version
Test Software for Radiated Emissions			Farad	EZ-EMC	Ver. UL-3A1

Other Instrument					
Equipment	Manufacturer	Model No.	Serial No.	Last Cal.	Due Date
Temperature humidity probe	OMEGA	ITHX-SD-5	18470007	Oct.22, 2022	Oct.21, 2023
Barometer	Yiyi	Baro	N/A	Oct.24, 2022	Oct.23, 2023
Attenuator	Agilent	8495B	2814a12853	Oct.18, 2022	Oct.17, 2023



7. ANTENNA PORT TEST RESULTS

7.1. CONDUCTED OUTPUT POWER

LIMITS

CFR 47 FCC Part15 (15.247) Subpart C ISED RSS-247 ISSUE 2			
Section	Test Item	Limit	Frequency Range (MHz)
CFR 47 FCC 15.247(b)(3) ISED RSS-247 5.4 (d)	AVG Output Power	1 watt or 30 dBm	2400-2483.5

TEST PROCEDURE

Refer to ANSI C63.10-2013 clause 11.9.2.3.1.

Connect the EUT to a low loss RF cable from the antenna port to the power sensor (video bandwidth is greater than the occupied bandwidth).

Measure peak emission level, the indicated level is the average output power, after any corrections for external attenuators and cables.

The test result in dBm by adding $[10 \log (1 / D)]$, where D is the duty cycle.

TEST SETUP

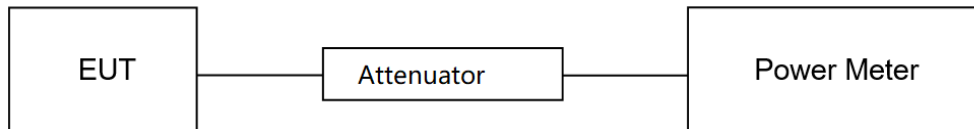

TEST ENVIRONMENT

Temperature	25.2°C	Relative Humidity	50.5%
Atmosphere Pressure	101.2kPa	Test Voltage	DC 14.4 V

TEST DATE / ENGINEER

Test Date	December 29, 2022	Test By	Walker Yuan
-----------	-------------------	---------	-------------

TEST RESULTS

Please refer to section "Test Data" - Appendix C

7.2. 6DB BANDWIDTH AND 99% OCCUPIED BANDWIDTH

LIMITS

CFR 47 FCC Part15 (15.247) Subpart C ISED RSS-247 ISSUE 2			
Section	Test Item	Limit	Frequency Range (MHz)
CFR 47 FCC 15.247(a)(2) ISED RSS-247 5.2 (a)	6 dB Bandwidth	≥ 500 kHz	2400-2483.5
ISED RSS-Gen Clause 6.7	99 % Occupied Bandwidth	For reporting purposes only.	2400-2483.5

TEST PROCEDURE

Refer to ANSI C63.10-2013 clause 11.8 for DTS bandwidth and clause 6.9 for Occupied Bandwidth.

Connect the EUT to the spectrum analyser and use the following settings:

Center Frequency	The center frequency of the channel under test
Frequency Span	For 6 dB Bandwidth: Enough to capture all products of the modulation carrier emission For 99 % Occupied Bandwidth: Between 1.5 times and 5.0 times the OBW
Detector	Peak
RBW	For 6 dB Bandwidth: 100 kHz For 99 % Occupied Bandwidth: 1 % to 5 % of the occupied bandwidth
VBW	For 6 dB Bandwidth: ≥3 × RBW For 99 % Occupied Bandwidth: ≥3 × RBW
Trace	Max hold
Sweep	Auto couple

a) Use the 99 % power bandwidth function of the instrument, allow the trace to stabilize and report the measured bandwidth.

b) Allow the trace to stabilize and measure the maximum width of the emission that is constrained by the frequencies associated with the two outermost amplitude points (upper and lower frequencies) that are attenuated by 6 dB relative to the maximum level measured in the fundamental emission.



TEST SETUP

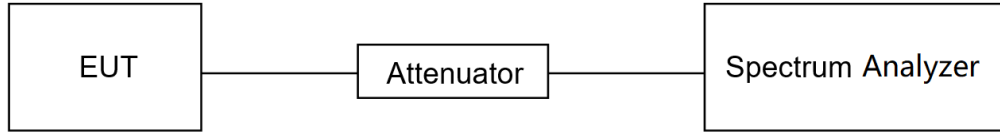

TEST ENVIRONMENT

Temperature	25.2°C	Relative Humidity	50.5%
Atmosphere Pressure	101.2kPa	Test Voltage	DC 14.4 V

TEST DATE / ENGINEER

Test Date	December 29, 2022	Test By	Walker Yuan
-----------	-------------------	---------	-------------

TEST RESULTS

Please refer to section "Test Data" - Appendix A&B

7.3. POWER SPECTRAL DENSITY

LIMITS

CFR 47 FCC Part15 (15.247) Subpart C ISED RSS-247 ISSUE 2			
Section	Test Item	Limit	Frequency Range (MHz)
CFR 47 FCC §15.247 (e) ISED RSS-247 5.2 (b)	Power Spectral Density	8 dBm in any 3 kHz band	2400-2483.5

TEST PROCEDURE

Refer to ANSI C63.10-2013 clause 11.10.5.

Connect the EUT to the spectrum analyser and use the following settings:

Center Frequency	The center frequency of the channel under test
Detector	power averaging (rms)
RBW	$3 \text{ kHz} \leq \text{RBW} \leq 100 \text{ kHz}$
VBW	$\geq 3 \times \text{RBW}$
Span	1.5 x OBW bandwidth
Trace	Average
Sweep time	Auto couple

Allow trace to fully stabilize and use the peak marker function to determine the maximum amplitude level within the RBW.

If measured value exceeds limit, reduce RBW (no less than 3 kHz) and repeat.

TEST SETUP

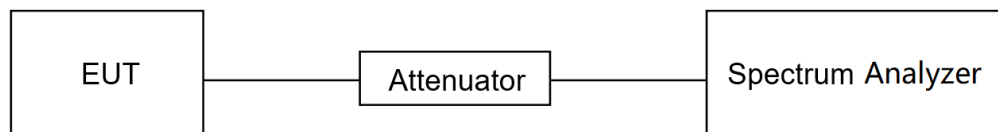

TEST ENVIRONMENT

Temperature	25.2°C	Relative Humidity	50.5%
Atmosphere Pressure	101.2kPa	Test Voltage	DC 14.4 V

TEST DATE / ENGINEER

Test Date	December 29, 2022	Test By	Walker Yuan
-----------	-------------------	---------	-------------



TEST RESULTS

Please refer to section "Test Data" - Appendix D

7.4. CONDUCTED BAND EDGE AND SPURIOUS EMISSION

LIMITS

CFR 47 FCC Part15 (15.247) Subpart C ISED RSS-247 ISSUE 2		
Section	Test Item	Limit
CFR 47 FCC §15.247 (d) ISED RSS-247 5.5	Conducted Bandedge and Spurious Emissions	at least 30 dB below that in the 100 kHz bandwidth within the band that contains the highest level of the desired power

TEST PROCEDURE

Refer to ANSI C63.10-2013 clause 11.11 and 11.13.

Connect the EUT to the spectrum analyser and use the following settings for reference level measurement:

Center Frequency	The center frequency of the channel under test
Detector	Peak
RBW	100 kHz
VBW	$\geq 3 \times \text{RBW}$
Span	1.5 x DTS bandwidth
Trace	Max hold
Sweep time	Auto couple.

Allow trace to fully stabilize and use the peak marker function to determine the maximum PSD level.

Change the settings for emission level measurement:

Span	Set the center frequency and span to encompass frequency range to be measured
Detector	Peak
RBW	100 kHz
VBW	$\geq 3 \times \text{RBW}$
measurement points	$\geq \text{span}/\text{RBW}$
Trace	Max hold
Sweep time	Auto couple.

Allow trace to fully stabilize and use the peak marker function to determine the maximum PSD level. Ensure that the amplitude of all unwanted emissions outside of the authorized frequency band (excluding restricted frequency bands) is attenuated by at least the minimum requirements specified in 11.11.



TEST SETUP

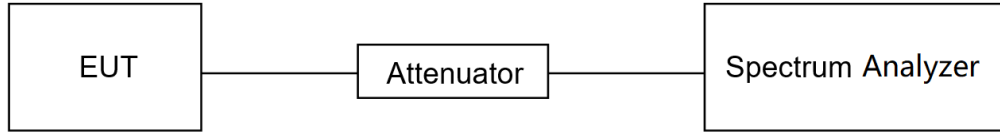

TEST ENVIRONMENT

Temperature	25.2°C	Relative Humidity	50.5%
Atmosphere Pressure	101.2kPa	Test Voltage	DC 14.4 V

TEST DATE / ENGINEER

Test Date	December 29, 2022	Test By	Walker Yuan
-----------	-------------------	---------	-------------

TEST RESULTS

Please refer to section "Test Data" - Appendix E&F



7.5. DUTY CYCLE

LIMITS

None; for reporting purposes only.

TEST PROCEDURE

Refer to ANSI C63.10-2013 clause 11.6 Zero – Span Spectrum Analyzer method.

TEST SETUP

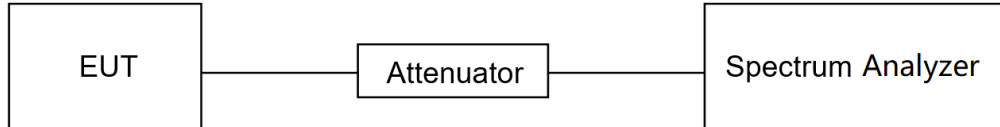

TEST ENVIRONMENT

Temperature	25.2°C	Relative Humidity	50.5%
Atmosphere Pressure	101.2kPa	Test Voltage	DC 14.4 V

TEST DATE / ENGINEER

Test Date	December 29, 2022	Test By	Walker Yuan
-----------	-------------------	---------	-------------

TEST RESULTS

Please refer to section "Test Data" - Appendix G

8. RADIATED TEST RESULTS

LIMITS

Please refer to CFR 47 FCC §15.205 and §15.209.

Please refer to ISED RSS-GEN Clause 8.9 and Clause 8.10.

Radiation Disturbance Test Limit for FCC (Class B) (9 kHz ~ 1 GHz)

Emissions radiated outside of the specified frequency bands above 30 MHz			
Frequency Range (MHz)	Field Strength Limit (uV/m) at 3 m	Field Strength Limit (dBuV/m) at 3 m	
		Quasi-Peak	
30 - 88	100	40	
88 - 216	150	43.5	
216 - 960	200	46	
Above 960	500	54	
Above 1000	500	Peak	Average
		74	54

FCC Emissions radiated outside of the specified frequency bands below 30 MHz		
Frequency (MHz)	Field strength (microvolts/meter)	Measurement distance (meters)
0.009-0.490	2400/F(kHz)	300
0.490-1.705	24000/F(kHz)	30
1.705-30.0	30	30

ISED General field strength limits at frequencies below 30 MHz

Table 6 – General field strength limits at frequencies below 30 MHz		
Frequency	Magnetic field strength (H-Field) (uA/m)	Measurement distance (m)
9 - 490 kHz ^{Note 1}	6.37/F (F in kHz)	300
490 - 1705 kHz	63.7/F (F in kHz)	30
1.705 - 30 MHz	0.08	30

Note 1: The emission limits for the ranges 9-90 kHz and 110-490 kHz are based on measurements employing a linear average detector.



ISED Restricted bands please refer to ISED RSS-GEN Clause 8.10

Table 7 – Restricted frequency bands ^{Note 1}		
MHz	MHz	GHz
0.090 - 0.110	149.9 - 150.05	9.0 - 9.2
0.495 - 0.505	156.52475 - 156.52525	9.3 - 9.5
2.1735 - 2.1905	156.7 - 156.9	10.6 - 12.7
3.020 - 3.026	162.0125 - 167.17	13.25 - 13.4
4.125 - 4.128	167.72 - 173.2	14.47 - 14.5
4.17725 - 4.17775	240 - 285	15.35 - 16.2
4.20725 - 4.20775	322 - 335.4	17.7 - 21.4
5.677 - 5.683	399.9 - 410	22.01 - 23.12
6.215 - 6.218	608 - 614	23.6 - 24.0
6.26775 - 6.26825	960 - 1427	31.2 - 31.8
6.31175 - 6.31225	1435 - 1626.5	36.43 - 36.5
8.291 - 8.294	1645.5 - 1646.5	Above 38.6
8.362 - 8.366	1660 - 1710	
8.37625 - 8.38675	1718.8 - 1722.2	
8.41425 - 8.41475	2200 - 2300	
12.29 - 12.293	2310 - 2390	
12.51975 - 12.52025	2483.5 - 2500	
12.57675 - 12.57725	2655 - 2900	
13.36 - 13.41	3260 - 3267	
16.42 - 16.423	3332 - 3339	
16.69475 - 16.69525	3345.8 - 3358	
16.80425 - 16.80475	3500 - 4400	
25.5 - 25.67	4500 - 5150	
37.5 - 38.25	5350 - 5460	
73 - 74.6	7250 - 7750	
74.8 - 75.2	8025 - 8500	
108 - 138		

Note 1: Certain frequency bands listed in table 7 and in bands above 38.6 GHz are designated for licence-exempt applications. These frequency bands and the requirements that apply to related devices are set out in the 200 and 300 series of RSSs.

FCC Restricted bands of operation refer to FCC §15.205 (a):

MHz	MHz	MHz	GHz
0.090-0.110	16.42-16.423	399.9-410	4.5-5.15
¹ 0.495-0.505	16.69475-16.69525	608-614	5.35-5.46
2.1735-2.1905	16.80425-16.80475	960-1240	7.25-7.75
4.125-4.128	25.5-25.67	1300-1427	8.025-8.5
4.17725-4.17775	37.5-38.25	1435-1626.5	9.0-9.2
4.20725-4.20775	73-74.6	1645.5-1646.5	9.3-9.5
6.215-6.218	74.8-75.2	1660-1710	10.6-12.7
6.26775-6.26825	108-121.94	1718.8-1722.2	13.25-13.4
6.31175-6.31225	123-138	2200-2300	14.47-14.5
8.291-8.294	149.9-150.05	2310-2390	15.35-16.2
8.362-8.366	156.52475-156.52525	2483.5-2500	17.7-21.4
8.37625-8.38675	156.7-156.9	2690-2900	22.01-23.12
8.41425-8.41475	162.0125-167.17	3260-3267	23.6-24.0
12.29-12.293	167.72-173.2	3332-3339	31.2-31.8
12.51975-12.52025	240-285	3345.8-3358	36.43-36.5
12.57675-12.57725	322-335.4	3600-4400	(²)
13.36-13.41			

Note: ¹Until February 1, 1999, this restricted band shall be 0.490-0.510 MHz.

²Above 38.6c

TEST PROCEDURE

Below 30 MHz

The setting of the spectrum analyser

RBW	200 Hz (From 9 kHz to 0.15 MHz)/ 9 kHz (From 0.15 MHz to 30 MHz)
VBW	200 Hz (From 9 kHz to 0.15 MHz)/ 9 kHz (From 0.15 MHz to 30 MHz)
Sweep	Auto

1. The testing follows the guidelines in ANSI C63.10-2013 clause 6.4.
2. The EUT was arranged to its worst case and then turntable (from 0 degree to 360 degrees) to find the maximum reading. A pre-amp and a high pass filter are used for the test in order to get better signal level. Both Horizontal, Face-on and Face-off polarizations of the antenna are set to make the measurement.
3. The EUT was placed on a turntable with 80 cm above ground.
4. The EUT was set 3 meters from the interference receiving antenna, which was mounted on the top of a 1 m height antenna tower.
5. The radiated emission limits are based on measurements employing a CISPR quasi-peak detector except for the frequency bands 9-90 kHz, 110-490 kHz and above 1000 MHz Radiated emission limits in these three bands are based on measurements employing an average detector.
6. For measurement below 1 GHz, the initial step in collecting conducted emission data is a spectrum analyzer peak detector mode pre-scanning the measurement frequency range. Significant peaks are then marked and then Quasi Peak and average detector mode re-measured. If the emission level of the EUT measured by the peak detector is 3 dB lower than the applicable limit, the peak emission level will be reported. Otherwise, the emission measurement will be repeated using the quasi-peak and average detector and reported.
7. Although these tests were performed other than open field site, adequate comparison measurements were confirmed against 30m open field site. Therefore sufficient tests were made to demonstrate that the alternative site produces results that correlate with the ones of tests made in an open field site based on KDB 414788.
8. The limits in CFR 47, Part 15, Subpart C, paragraph 15.209 (a), are identical to those in RSS-GEN Section 8.9, Table 6, since the measurements are performed in terms of magnetic field strength and converted to electric field strength levels (as reported in the table) using the free space impedance of 377Ω. For example, the measurement frequency X KHz resulted in a level of Y dBuV/m, which is equivalent to $Y-51.5 = Z$ dBuA/m, which has the same margin, W dB, to the corresponding RSS-GEN Table 6 limit as it has to be 15.209(a) limit.

Below 1 GHz and above 30 MHz

The setting of the spectrum analyser

RBW	120 kHz
VBW	300 kHz
Sweep	Auto
Detector	Peak/QP
Trace	Max hold

1. The testing follows the guidelines in ANSI C63.10-2013 clause 6.5.
2. The EUT was arranged to its worst case and then tune the antenna tower (from 1 m to 4 m) and turntable (from 0 degree to 360 degrees) to find the maximum reading. A pre-amp and a high pass filter are used for the test in order to get better signal level. Both horizontal and vertical polarizations of the antenna are set to make the measurement.
3. The EUT was placed on a turntable with 80 cm above ground.
4. The EUT was set 3 meters from the interference receiving antenna, which was mounted on the top of a variable height antenna tower.
5. For measurement below 1 GHz, the initial step in collecting conducted emission data is a spectrum analyzer peak detector mode pre-scanning the measurement frequency range. Significant peaks are then marked and then Quasi Peak detector mode re-measured. If the emission level of the EUT measured by the peak detector is 3 dB lower than the applicable limit, the peak emission level will be reported. Otherwise, the emission measurement will be repeated using the quasi-peak detector and reported.

Above 1G

The setting of the spectrum analyser

RBW	1 MHz
VBW	PEAK: 3 MHz AVG: see note 6
Sweep	Auto
Detector	Peak
Trace	Max hold

1. The testing follows the guidelines in ANSI C63.10-2013 clause 6.6.
2. The EUT was arranged to its worst case and then tune the antenna tower (from 1 m to 4 m) and turntable (from 0 degree to 360 degrees) to find the maximum reading. A pre-amp and a high pass filter are used for the test in order to get better signal level. Both horizontal and vertical polarizations of the antenna are set to make the measurement.
3. The EUT was placed on a turntable with 1.5 m above ground.
4. The EUT was set 3 meters from the interference receiving antenna, which was mounted on the top of a variable height antenna tower.
5. For measurement above 1 GHz, the emission measurement will be measured by the peak detector. This peak level, once corrected, must comply with the limit specified in Section 15.209.
6. For measurements above 1 GHz the resolution bandwidth is set to 1 MHz, then the video bandwidth is set to 3 MHz for peak measurements and 1 MHz resolution bandwidth with 1/T video bandwidth with peak detector for average measurements. For the Duty Cycle please refer to clause 7.5.ON TIME AND DUTY CYCLE.

X axis, Y axis, Z axis positions:

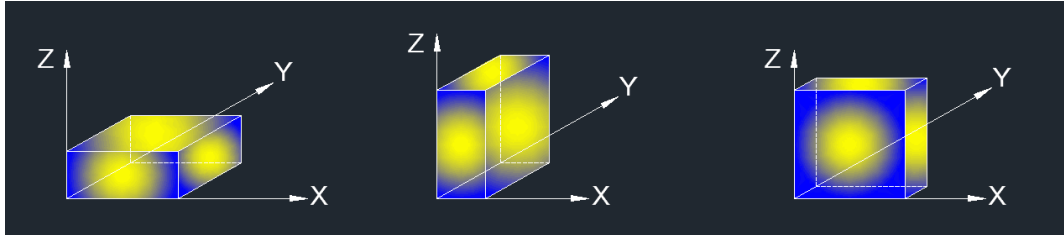

Note: 1. The manufacturer has recommended that the EUT only be used in the desktop (horizontal) orientation; therefore, all radiated testing was performed in desktop orientation.

2. The EUT was placed on normal orientation and all radiated emissions were performed with the EUT shown on the setup photo.

For Band edge note:

1. Measurement = Reading Level + Correct Factor.
2. If the peak values are less than the average limit of 54 dBuV/m, the average result is deemed to comply with average limit.
3. Peak: Peak detector.
4. AVG: $VBW=1/Ton$, where: Ton is the transmitting duration.
5. For the transmitting duration, please refer to clause 7.5.
6. Only the worst data was recorded, if it complies with the limit, the other emissions deemed to comply with the limit.
7. Horizontal and Vertical have been tested, only the worst data was recorded in the report.
8. All modes and channels have been tested, only the worst data was recorded in the report.

For Radiate Spurious emission 1GHz-3GHz note:

- Note:
1. Measurement = Reading Level + Correct Factor.
 2. If the Peak values are less than the Average limit of 54 dBuV/m, the Average result is deemed to comply with Average limit.
 3. Peak: Peak detector.
 4. AVG: $VBW=1/Ton$, where: Ton is the transmitting duration.
 5. For the transmitting duration, please refer to clause 7.5.
 6. Filter losses were only considered in the spurious frequency bands and the authorized band was not corrected for Band reject filter losses.
 7. Proper operation of the transmitter prior to adding the filter to the measurement chain.
 8. All modes and channels have been tested, only the worst data was recorded in the report.



For Radiate Spurious emission 3GHz-18GHz note:

Note: 1. Peak Result = Reading Level + Correct Factor.

2. If the Peak values are less than the Average limit of 54 dBuV/m, the Average result is deemed to comply with Average limit.

3. Peak: Peak detector.

4. AVG: $VBW=1/Ton$, where: Ton is the transmitting duration.

5. For the transmitting duration, please refer to clause 7.5.

6. Filter losses were only considered in the spurious frequency bands and the authorized band was not corrected for High Pass Filter losses.

7. Proper operation of the transmitter prior to adding the filter to the measurement chain.

8. All modes and channels have been tested, only the worst data was recorded in the report.

For Radiate Spurious emission 9kHz-30MHz note:

1. Measurement = Reading Level + Correct Factor.

2. If the Peak values are less than the QP limit, the QP result is deemed to comply with QP limit.

3. All 3 polarizations (Horizontal, Face-on and Face-off) of the loop antenna had been tested, but only the worst data recorded in the report.

4. All modes and channels have been tested, only the worst data was recorded in the report.

For Radiate Spurious emission 18GHz-26GHz note:

1. Measurement = Reading Level + Correct Factor.

2. If the Peak values are less than the Average limit of 54 dBuV/m, the Average result is deemed to comply with Average limit.

3. Peak: Peak detector.

4. All modes and channels have been tested, only the worst data was recorded in the report.

For Radiate Spurious emission 30MHz-1GHz note:

1. Result Level = Read Level + Correct Factor.

2. If the Peak values are less than the QP limit, the QP result is deemed to comply with QP limit.

3. Test setup: RBW: 120 kHz, VBW: 300 kHz, Sweep time: auto.

4. All modes and channels have been tested, only the worst data was recorded in the report.



TEST ENVIRONMENT

Temperature	25.3°C	Relative Humidity	61%
Atmosphere Pressure	101kPa	Test Voltage	DC 14.4 V

TEST DATE / ENGINEER

Test Date	December 12, 2022	Test By	Rex Huang
-----------	-------------------	---------	-----------

TEST RESULTS



8.1. RESTRICTED BANDEDGE

Test Mode:	802.11b PK	Channel:	2412
Polarity:	Horizontal	Test Voltage:	DC 14.4 V

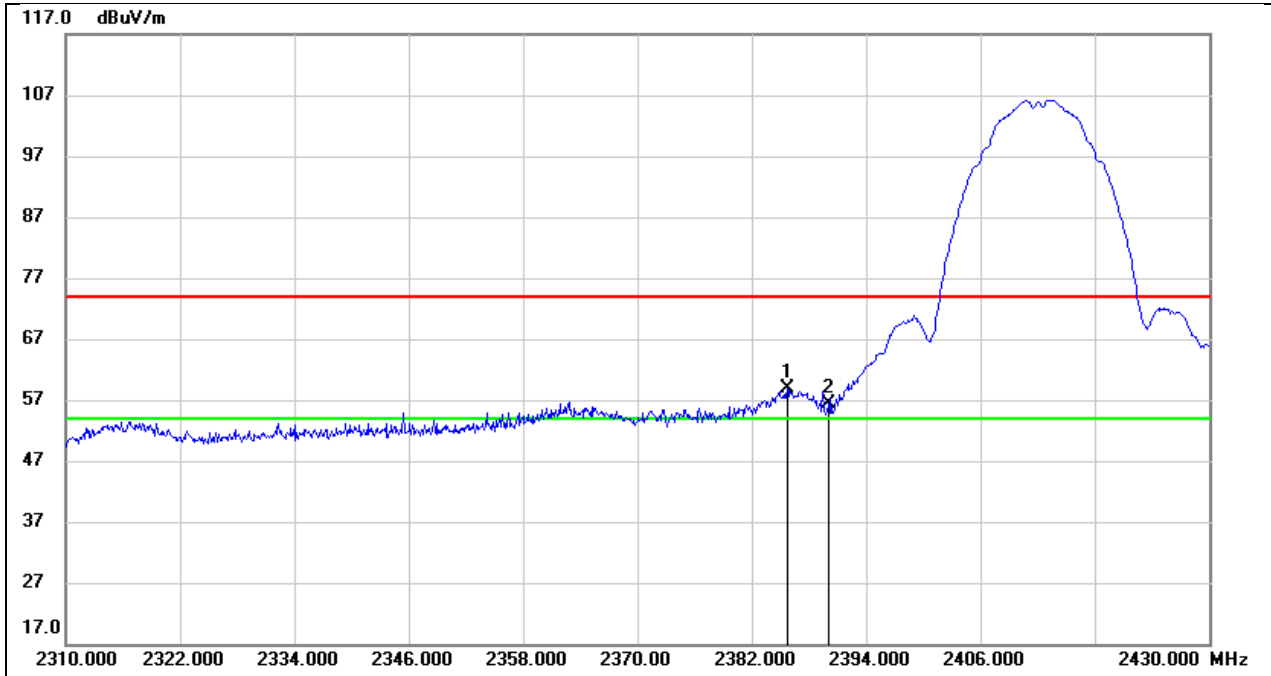

No.	Frequency (MHz)	Reading (dBuV)	Correct (dB/m)	Result (dBuV/m)	Limit (dBuV/m)	Margin (dB)	Remark
1	2385.720	26.69	32.14	58.83	74.00	-15.17	peak
2	2390.000	24.21	32.16	56.37	74.00	-17.63	peak



Test Mode:	802.11b AV	Channel:	2412
Polarity:	Horizontal	Test Voltage:	DC 14.4 V

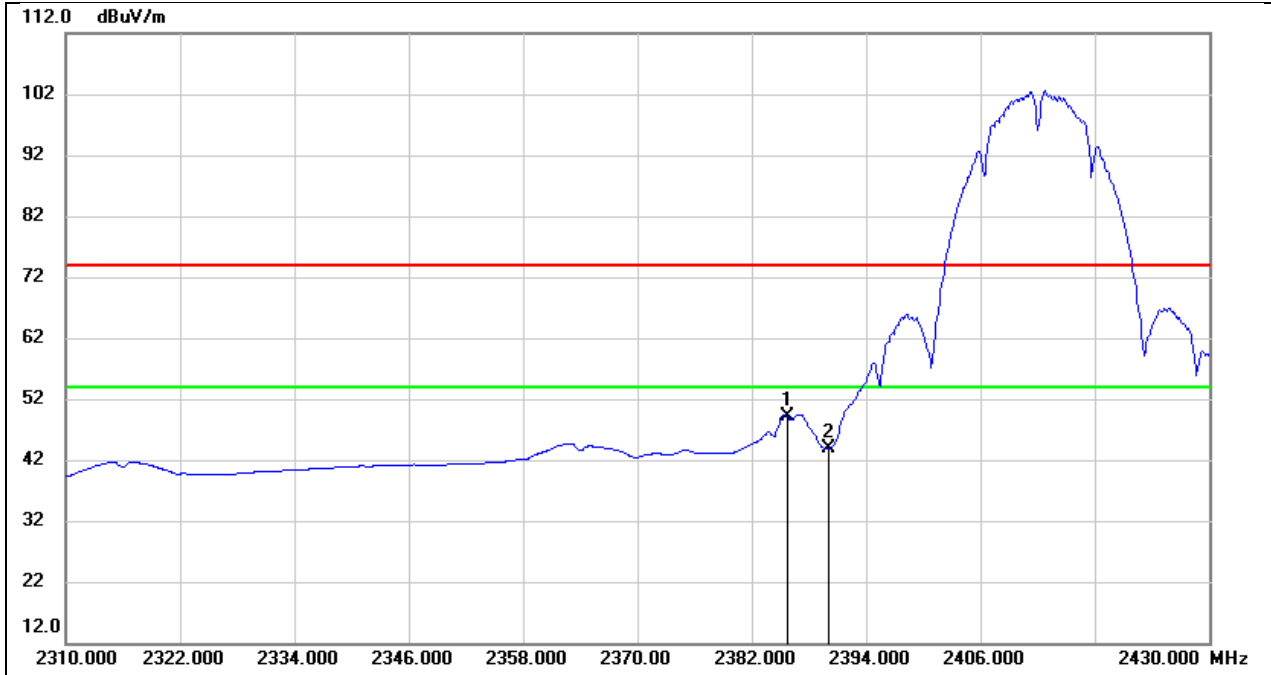

No.	Frequency (MHz)	Reading (dBuV)	Correct (dB/m)	Result (dBuV/m)	Limit (dBuV/m)	Margin (dB)	Remark
1	2385.720	16.88	32.14	49.02	54.00	-4.98	AVG
2	2390.000	11.83	32.16	43.99	54.00	-10.01	AVG



Test Mode:	802.11b PK	Channel:	2462
Polarity:	Horizontal	Test Voltage:	DC 14.4 V

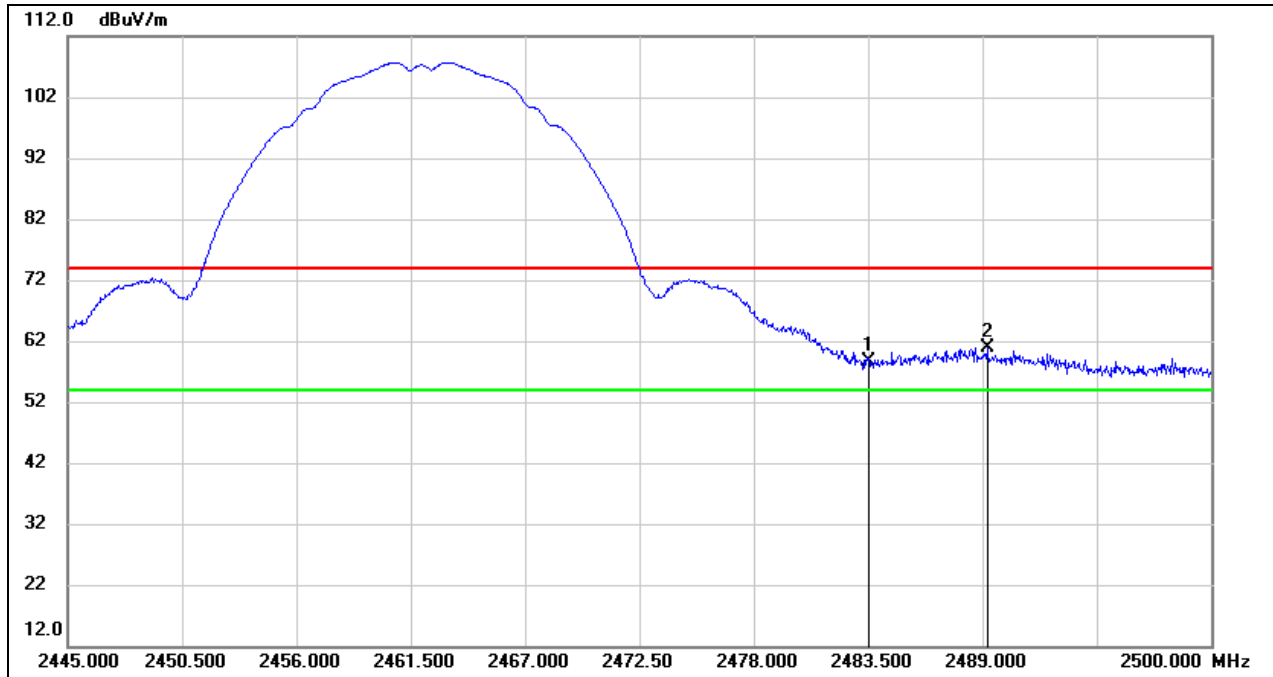

No.	Frequency (MHz)	Reading (dBuV)	Correct (dB/m)	Result (dBuV/m)	Limit (dBuV/m)	Margin (dB)	Remark
1	2483.500	26.18	32.44	58.62	74.00	-15.38	peak
2	2489.220	28.41	32.46	60.87	74.00	-13.13	peak



Test Mode:	802.11b AV	Channel:	2462
Polarity:	Horizontal	Test Voltage:	DC 14.4 V

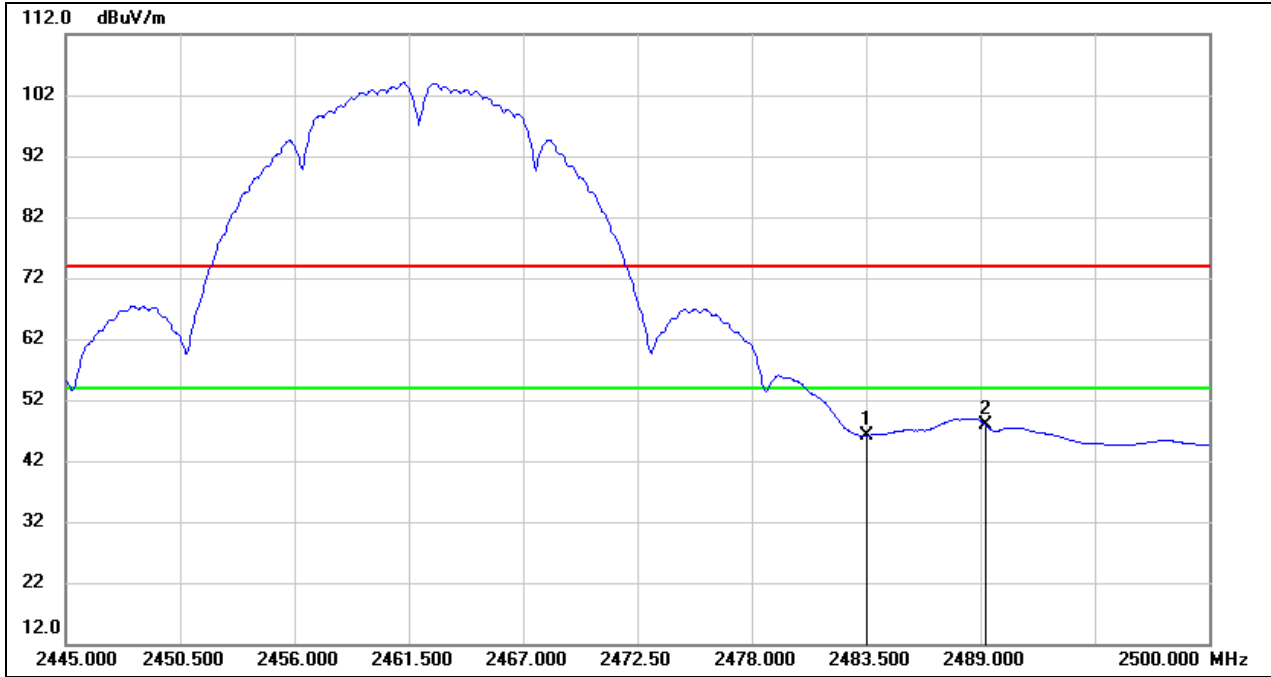

No.	Frequency (MHz)	Reading (dBuV)	Correct (dB/m)	Result (dBuV/m)	Limit (dBuV/m)	Margin (dB)	Remark
1	2483.500	13.75	32.44	46.19	54.00	-7.81	AVG
2	2489.220	15.51	32.46	47.97	54.00	-6.03	AVG



Test Mode:	802.11g PK	Channel:	2412
Polarity:	Horizontal	Test Voltage:	DC 14.4 V

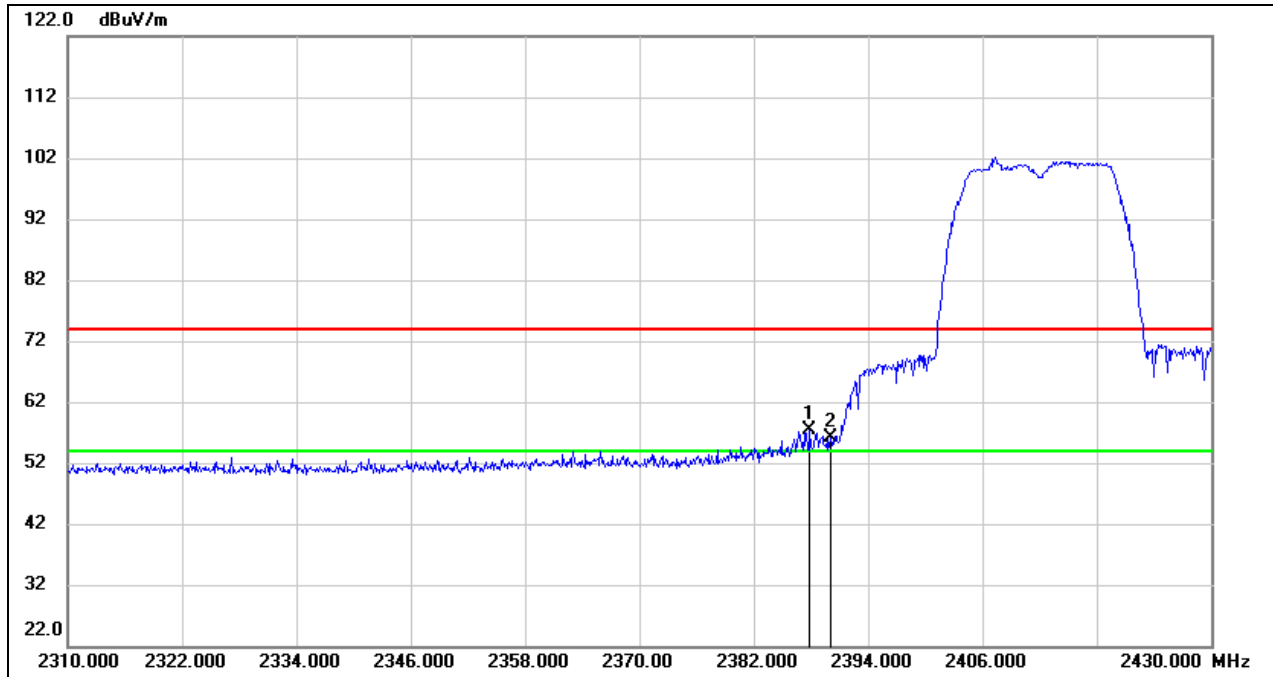

No.	Frequency (MHz)	Reading (dBuV)	Correct (dB/m)	Result (dBuV/m)	Limit (dBuV/m)	Margin (dB)	Remark
1	2387.880	25.31	32.16	57.47	74.00	-16.53	peak
2	2390.000	23.87	32.16	56.03	74.00	-17.97	peak



Test Mode:	802.11g AV	Channel:	2412
Polarity:	Horizontal	Test Voltage:	DC 14.4 V

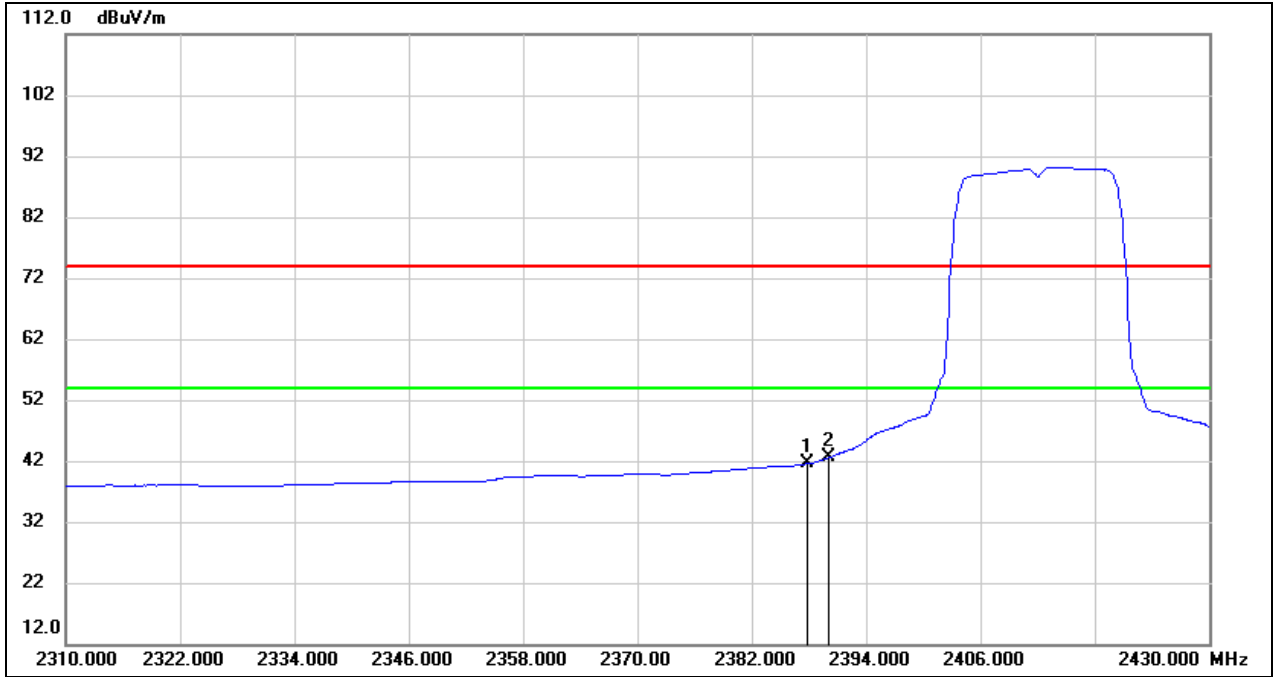

No.	Frequency (MHz)	Reading (dBuV)	Correct (dB/m)	Result (dBuV/m)	Limit (dBuV/m)	Margin (dB)	Remark
1	2387.880	9.37	32.16	41.53	54.00	-12.47	AVG
2	2390.000	10.37	32.16	42.53	54.00	-11.47	AVG



Test Mode:	802.11g PK	Channel:	2462
Polarity:	Horizontal	Test Voltage:	DC 14.4 V

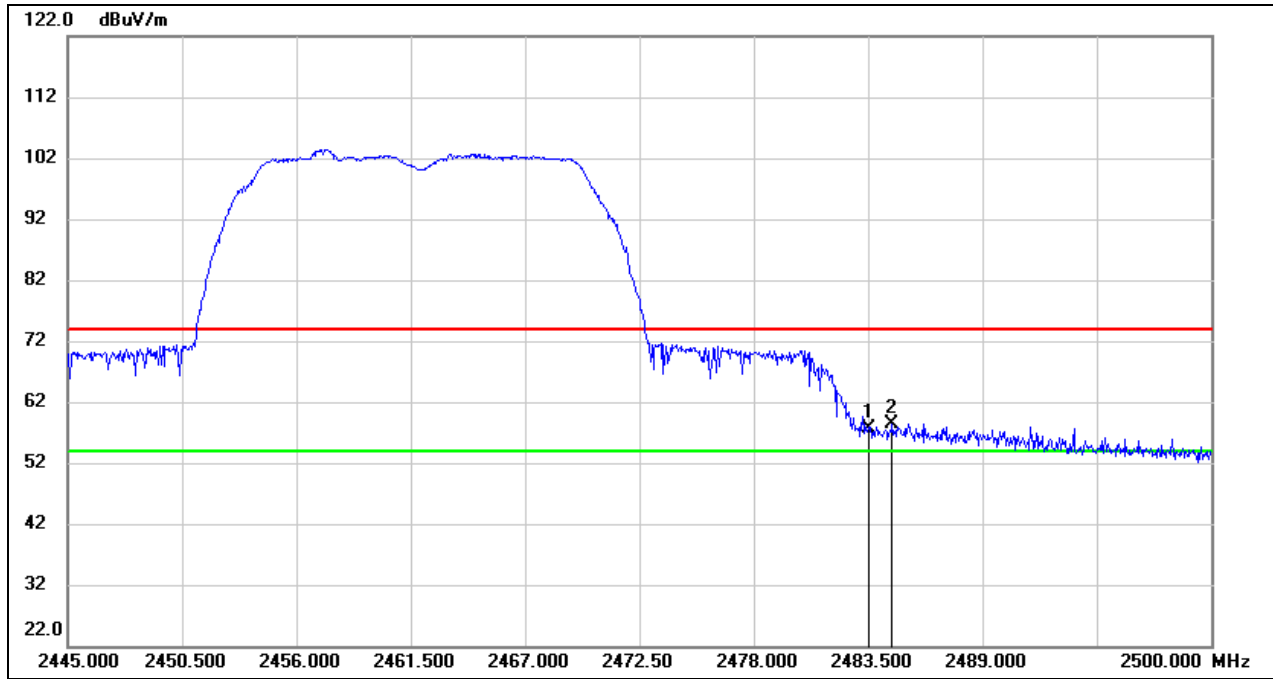

No.	Frequency (MHz)	Reading (dBuV)	Correct (dB/m)	Result (dBuV/m)	Limit (dBuV/m)	Margin (dB)	Remark
1	2483.500	25.13	32.44	57.57	74.00	-16.43	peak
2	2484.655	25.96	32.44	58.40	74.00	-15.60	peak



Test Mode:	802.11g AV	Channel:	2462
Polarity:	Horizontal	Test Voltage:	DC 14.4 V

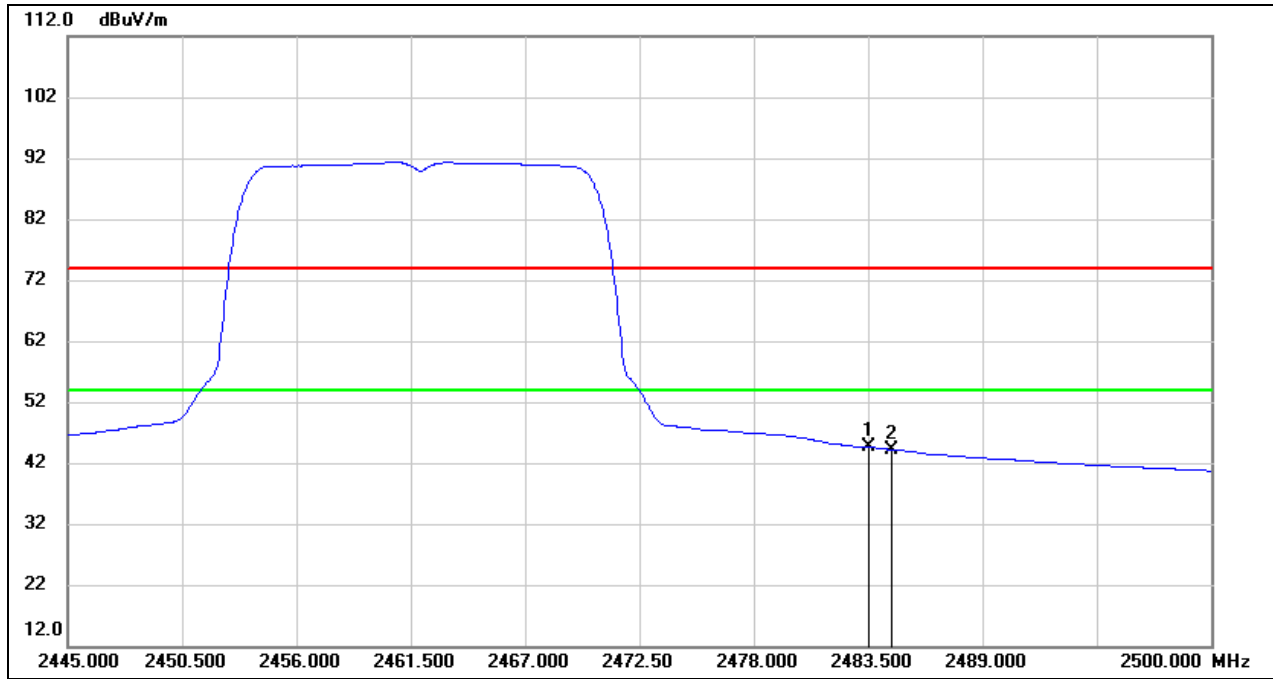

No.	Frequency (MHz)	Reading (dBuV)	Correct (dB/m)	Result (dBuV/m)	Limit (dBuV/m)	Margin (dB)	Remark
1	2483.500	12.24	32.44	44.68	54.00	-9.32	AVG
2	2484.655	11.74	32.44	44.18	54.00	-9.82	AVG



Test Mode:	802.11n HT20 PK	Channel:	2412
Polarity:	Horizontal	Test Voltage:	DC 14.4 V

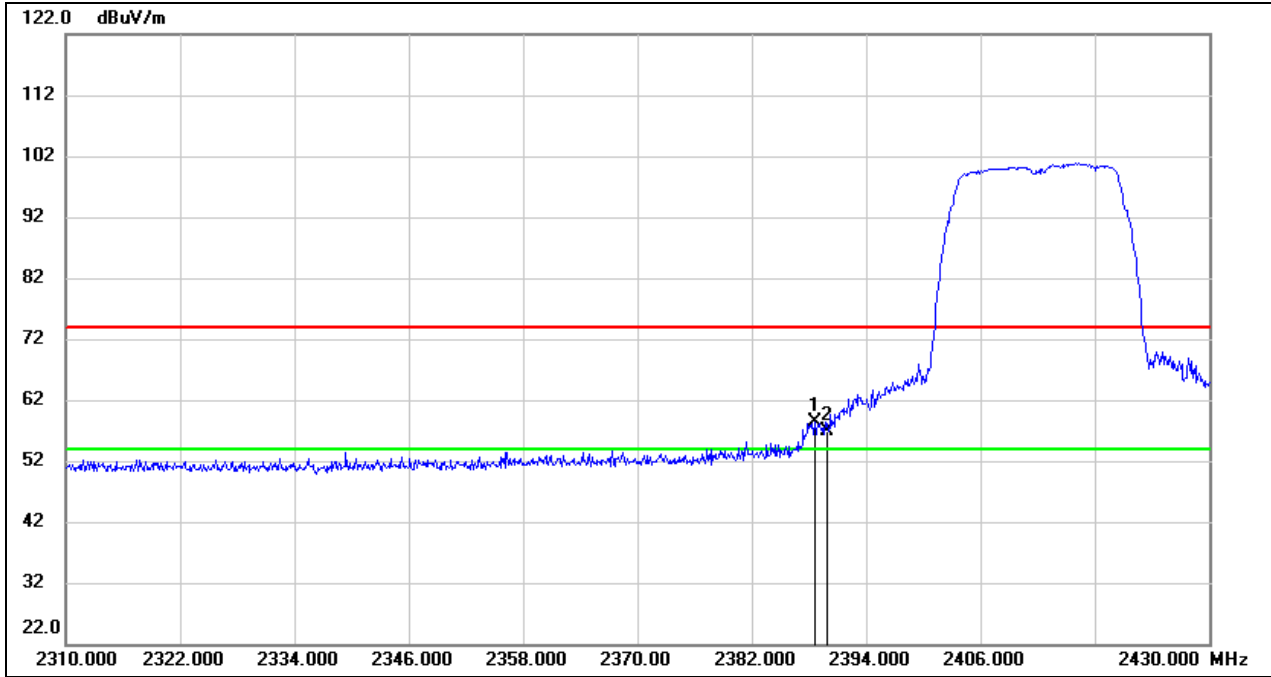

No.	Frequency (MHz)	Reading (dBuV)	Correct (dB/m)	Result (dBuV/m)	Limit (dBuV/m)	Margin (dB)	Remark
1	2388.600	26.20	32.16	58.36	74.00	-15.64	peak
2	2390.000	24.79	32.16	56.95	74.00	-17.05	peak



Test Mode:	802.11n HT20 AV	Channel:	2412
Polarity:	Horizontal	Test Voltage:	DC 14.4 V

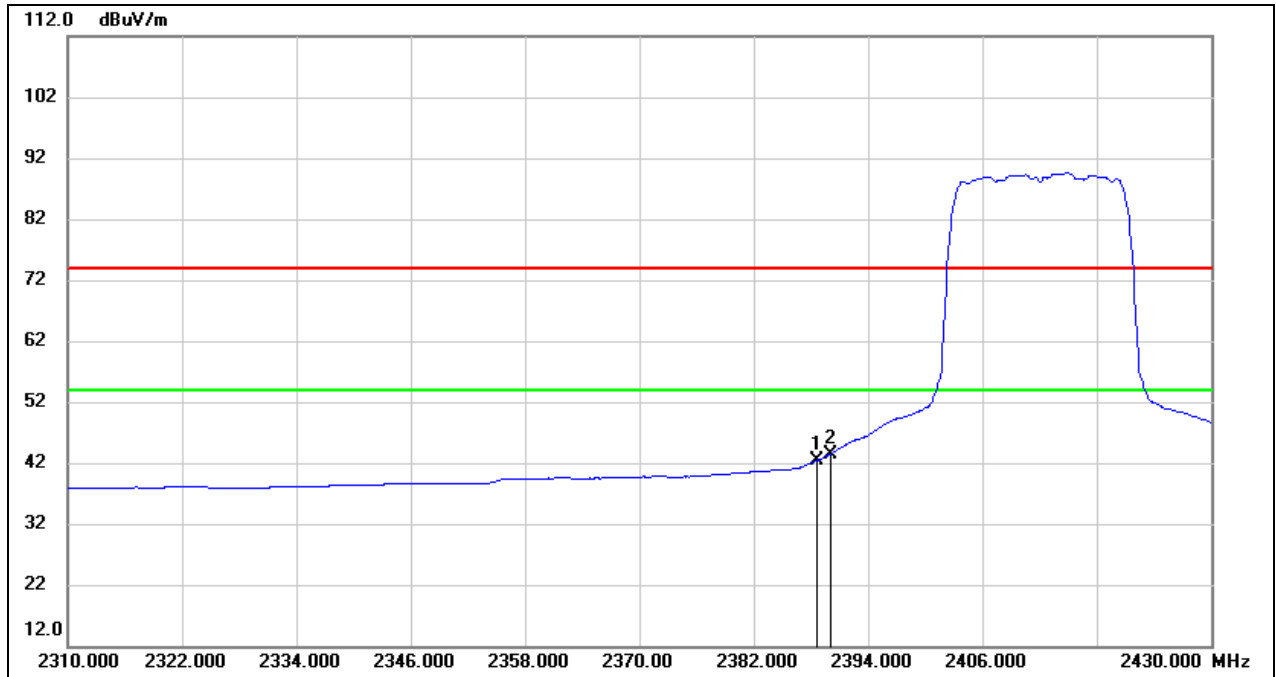

No.	Frequency (MHz)	Reading (dBuV)	Correct (dB/m)	Result (dBuV/m)	Limit (dBuV/m)	Margin (dB)	Remark
1	2388.600	10.22	32.16	42.38	54.00	-11.62	AVG
2	2390.000	11.29	32.16	43.45	54.00	-10.55	AVG



Test Mode:	802.11n HT20 PK	Channel:	2462
Polarity:	Horizontal	Test Voltage:	DC 14.4 V

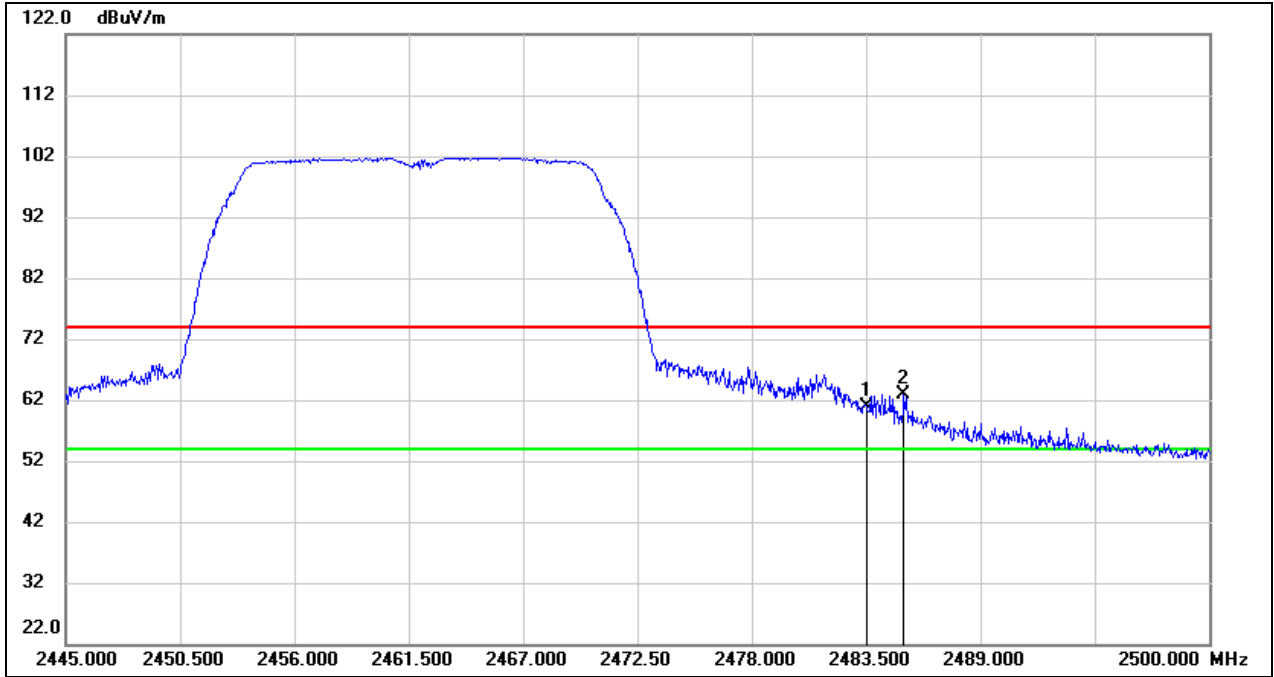

No.	Frequency (MHz)	Reading (dBuV)	Correct (dB/m)	Result (dBuV/m)	Limit (dBuV/m)	Margin (dB)	Remark
1	2483.500	28.44	32.44	60.88	74.00	-13.12	peak
2	2485.315	30.49	32.44	62.93	74.00	-11.07	peak



Test Mode:	802.11n HT20 AV	Channel:	2462
Polarity:	Horizontal	Test Voltage:	DC 14.4 V

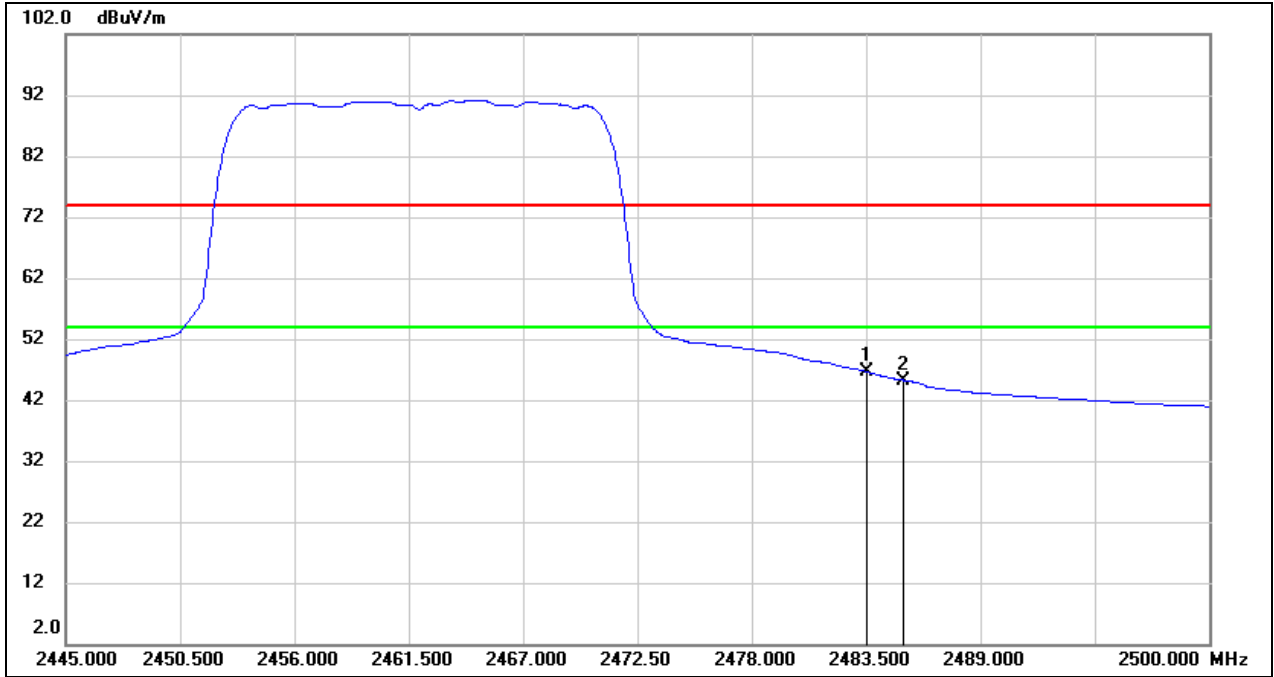

No.	Frequency (MHz)	Reading (dBuV)	Correct (dB/m)	Result (dBuV/m)	Limit (dBuV/m)	Margin (dB)	Remark
1	2483.500	14.22	32.44	46.66	54.00	-7.34	AVG
2	2485.315	12.77	32.44	45.21	54.00	-8.79	AVG



Test Mode:	802.11n HT40 PK	Channel:	2422
Polarity:	Horizontal	Test Voltage:	DC 14.4 V

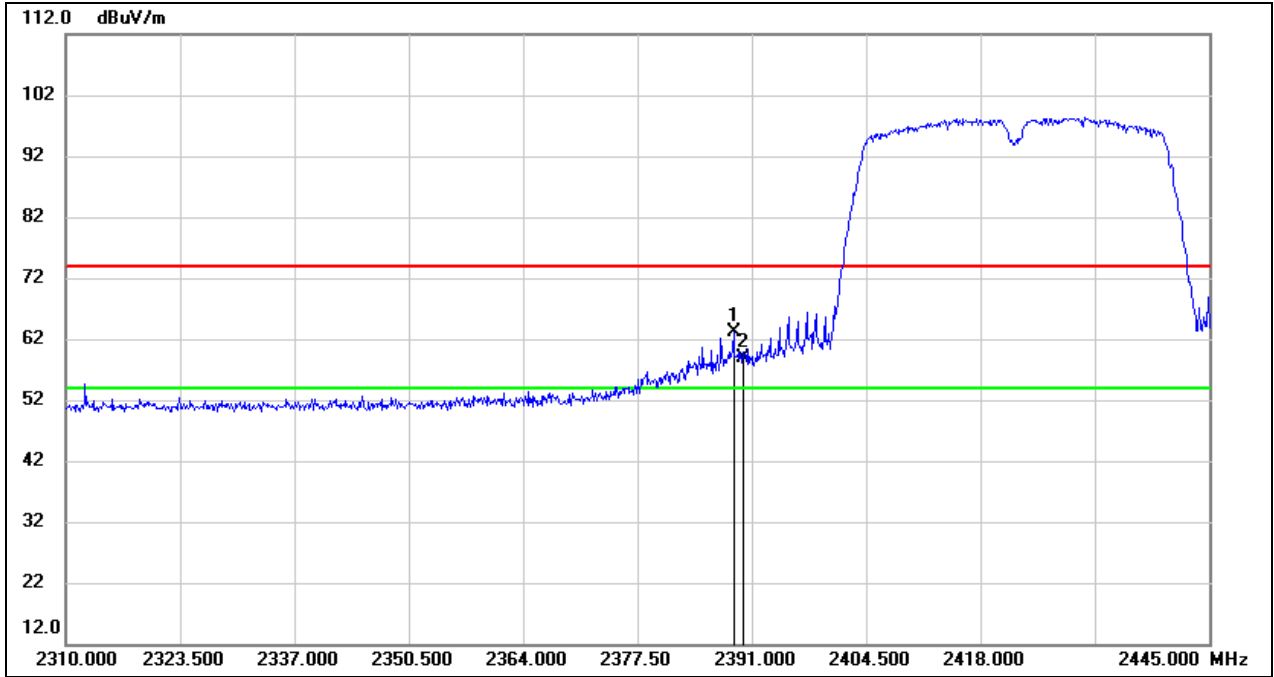

No.	Frequency (MHz)	Reading (dBuV)	Correct (dB/m)	Result (dBuV/m)	Limit (dBuV/m)	Margin (dB)	Remark
1	2388.840	30.88	32.16	63.04	74.00	-10.96	peak
2	2390.000	26.77	32.16	58.93	74.00	-15.07	peak



Test Mode:	802.11n HT40 AV	Channel:	2422
Polarity:	Horizontal	Test Voltage:	DC 14.4 V

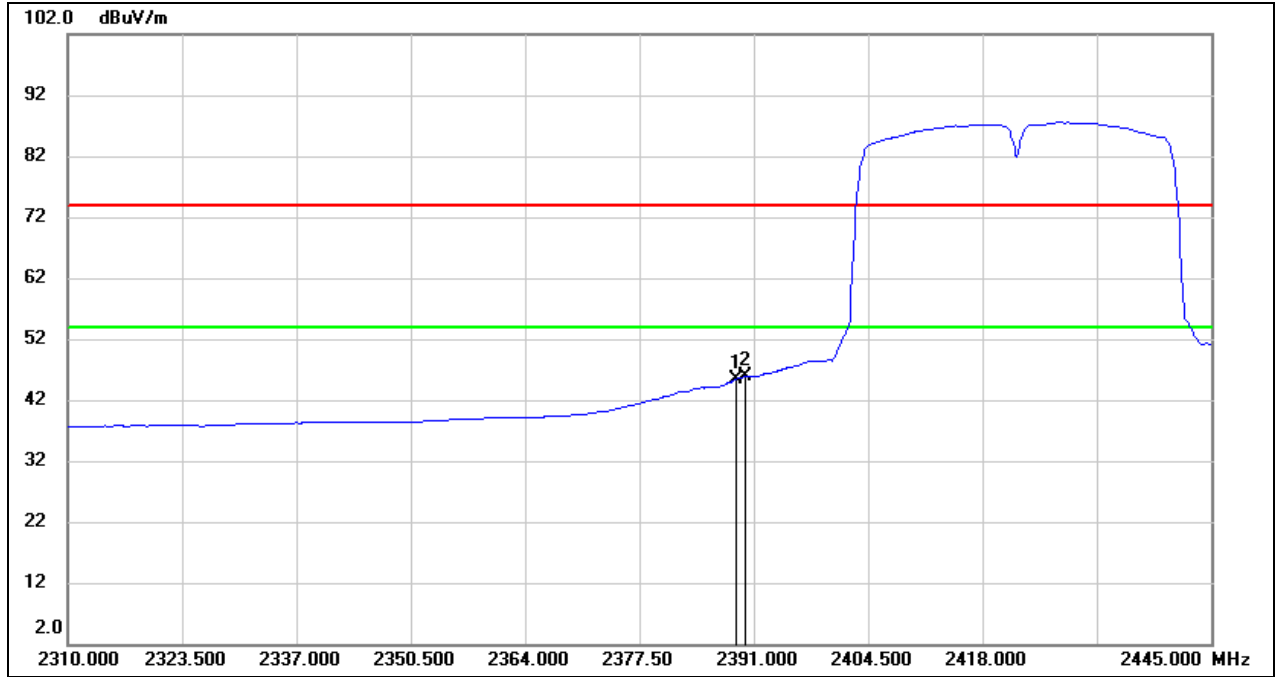

No.	Frequency (MHz)	Reading (dBuV)	Correct (dB/m)	Result (dBuV/m)	Limit (dBuV/m)	Margin (dB)	Remark
1	2388.840	13.22	32.16	45.38	54.00	-8.62	AVG
2	2390.000	13.73	32.16	45.89	54.00	-8.11	AVG



Test Mode:	802.11n HT40 PK	Channel:	2452
Polarity:	Horizontal	Test Voltage:	DC 14.4 V

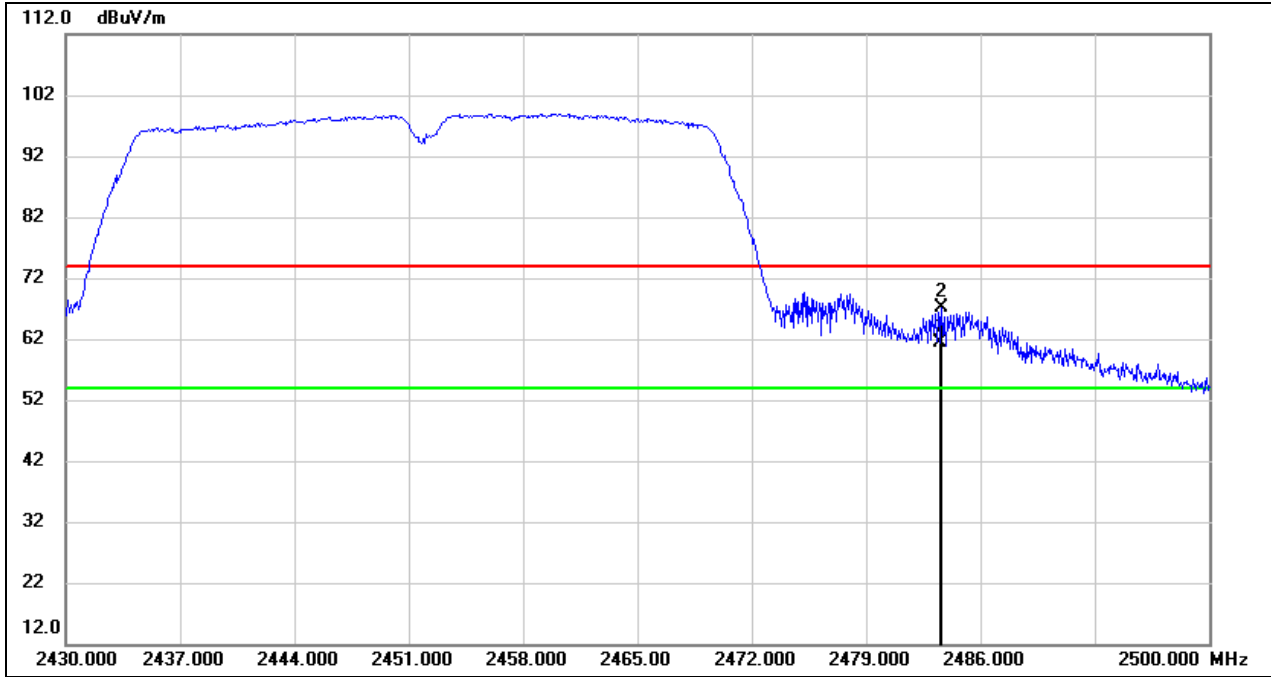

No.	Frequency (MHz)	Reading (dBuV)	Correct (dB/m)	Result (dBuV/m)	Limit (dBuV/m)	Margin (dB)	Remark
1	2483.500	28.98	32.44	61.42	74.00	-12.58	peak
2	2483.620	34.63	32.44	67.07	74.00	-6.93	peak



Test Mode:	802.11n HT40 AV	Channel:	2452
Polarity:	Horizontal	Test Voltage:	DC 14.4 V

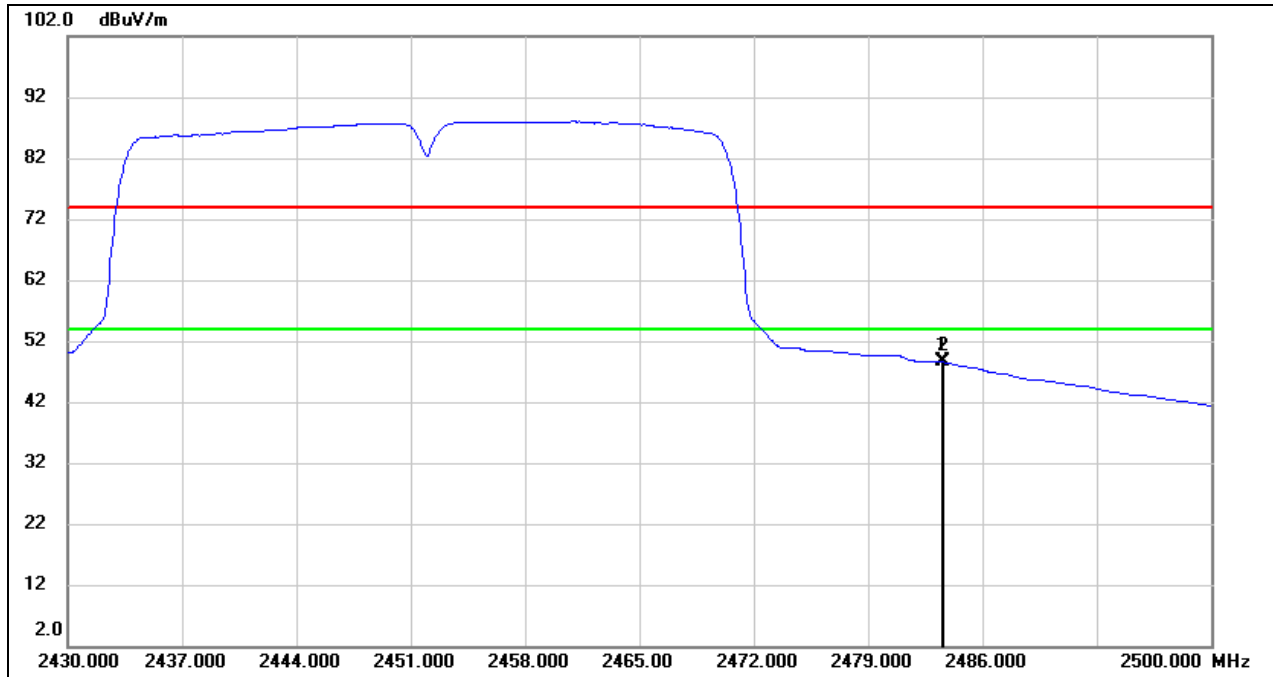

No.	Frequency (MHz)	Reading (dBuV)	Correct (dB/m)	Result (dBuV/m)	Limit (dBuV/m)	Margin (dB)	Remark
1	2483.500	16.15	32.44	48.59	54.00	-5.41	AVG
2	2483.620	16.11	32.44	48.55	54.00	-5.45	AVG



8.2. SPURIOUS EMISSIONS(1 GHZ~3 GHZ)

Test Mode:	802.11b	Channel:	2412
Polarity:	Horizontal	Test Voltage:	DC 14.4 V

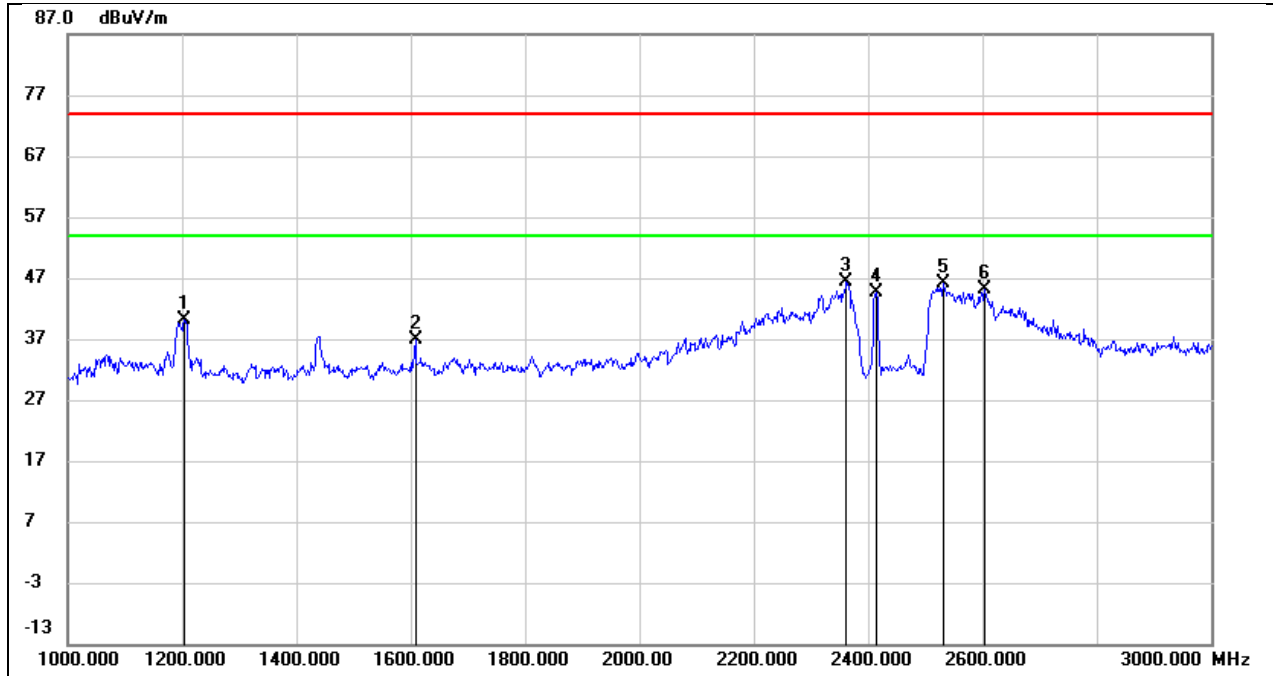

No.	Frequency (MHz)	Reading (dBuV)	Correct (dB/m)	Result (dBuV/m)	Limit (dBuV/m)	Margin (dB)	Remark
1	1204.000	54.12	-14.09	40.03	74.00	-33.97	peak
2	1608.000	49.21	-12.35	36.86	74.00	-37.14	peak
3	2362.000	55.59	-9.20	46.39	74.00	-27.61	peak
4	2412.000	53.59	-8.93	44.66	/	/	fundamental
5	2532.000	54.48	-8.39	46.09	74.00	-27.91	peak
6	2604.000	53.21	-8.18	45.03	74.00	-28.97	peak



Test Mode:	802.11b	Channel:	2412
Polarity:	Vertical	Test Voltage:	DC 14.4 V

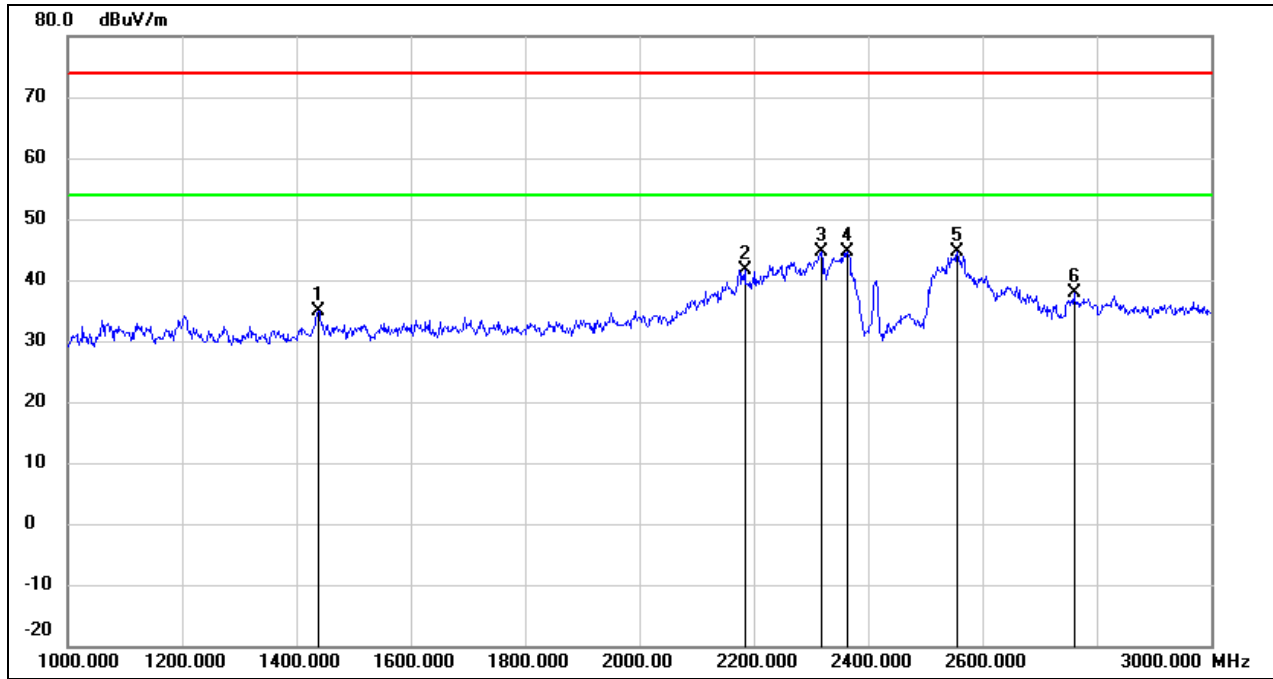

No.	Frequency (MHz)	Reading (dBuV)	Correct (dB/m)	Result (dBuV/m)	Limit (dBuV/m)	Margin (dB)	Remark
1	1438.000	47.99	-13.00	34.99	74.00	-39.01	peak
2	2184.000	51.74	-10.11	41.63	74.00	-32.37	peak
3	2318.000	54.17	-9.42	44.75	74.00	-29.25	peak
4	2364.000	53.72	-9.19	44.53	74.00	-29.47	peak
5	2556.000	52.94	-8.32	44.62	74.00	-29.38	peak
6	2760.000	45.63	-7.70	37.93	74.00	-36.07	peak



Test Mode:	802.11b	Channel:	2437
Polarity:	Horizontal	Test Voltage:	DC 14.4 V

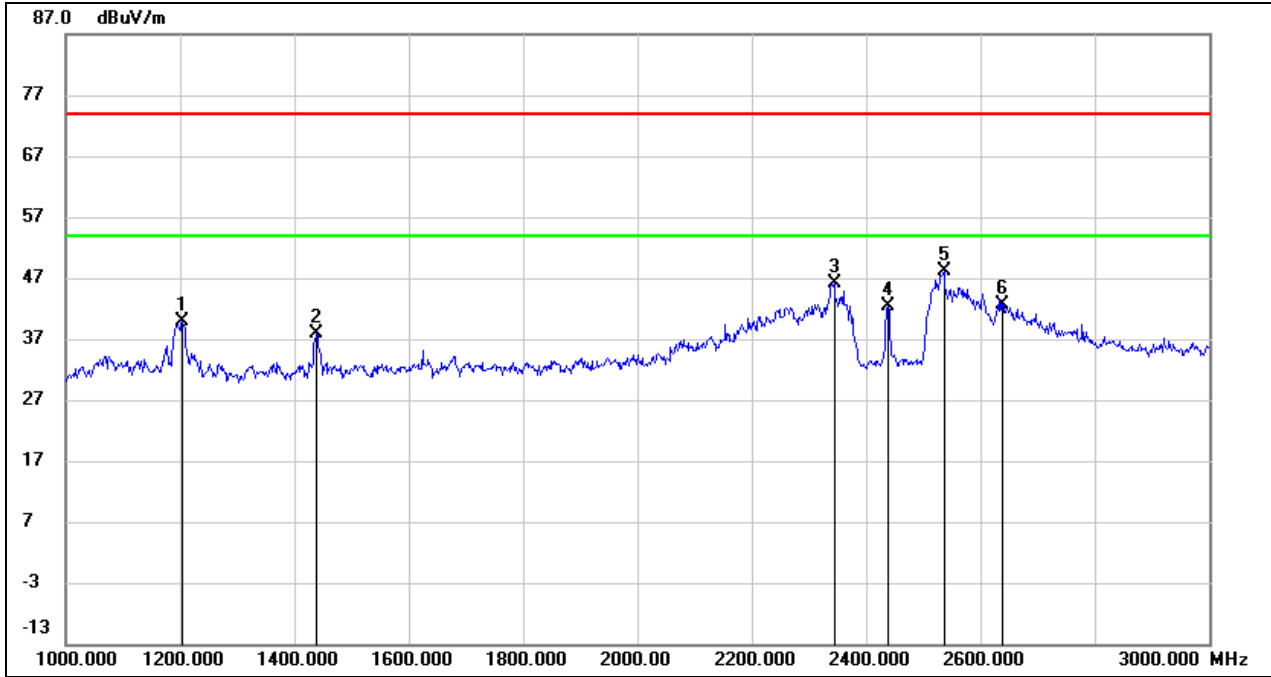

No.	Frequency (MHz)	Reading (dBuV)	Correct (dB/m)	Result (dBuV/m)	Limit (dBuV/m)	Margin (dB)	Remark
1	1204.000	53.89	-14.09	39.80	74.00	-34.20	peak
2	1438.000	50.83	-13.00	37.83	74.00	-36.17	peak
3	2344.000	55.39	-9.30	46.09	74.00	-27.91	peak
4	2437.000	51.26	-8.80	42.46	/	/	fundamental
5	2536.000	56.42	-8.38	48.04	74.00	-25.96	peak
6	2638.000	50.77	-8.07	42.70	74.00	-31.30	peak



Test Mode:	802.11b	Channel:	2437
Polarity:	Vertical	Test Voltage:	DC 14.4 V

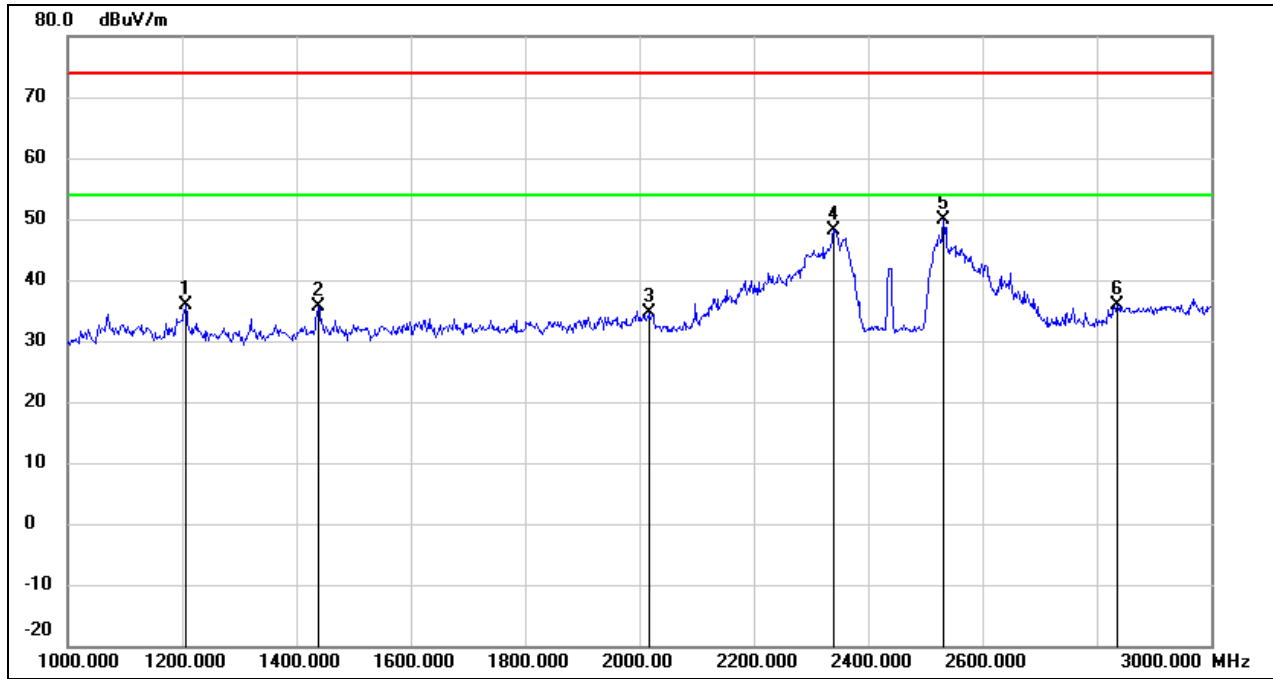

No.	Frequency (MHz)	Reading (dBuV)	Correct (dB/m)	Result (dBuV/m)	Limit (dBuV/m)	Margin (dB)	Remark
1	1206.000	49.96	-14.07	35.89	74.00	-38.11	peak
2	1438.000	48.74	-13.00	35.74	74.00	-38.26	peak
3	2016.000	45.59	-10.98	34.61	74.00	-39.39	peak
4	2340.000	57.52	-9.31	48.21	74.00	-25.79	peak
5	2532.000	58.17	-8.39	49.78	74.00	-24.22	peak
6	2836.000	43.42	-7.48	35.94	74.00	-38.06	peak



Test Mode:	802.11b	Channel:	2462
Polarity:	Horizontal	Test Voltage:	DC 14.4 V

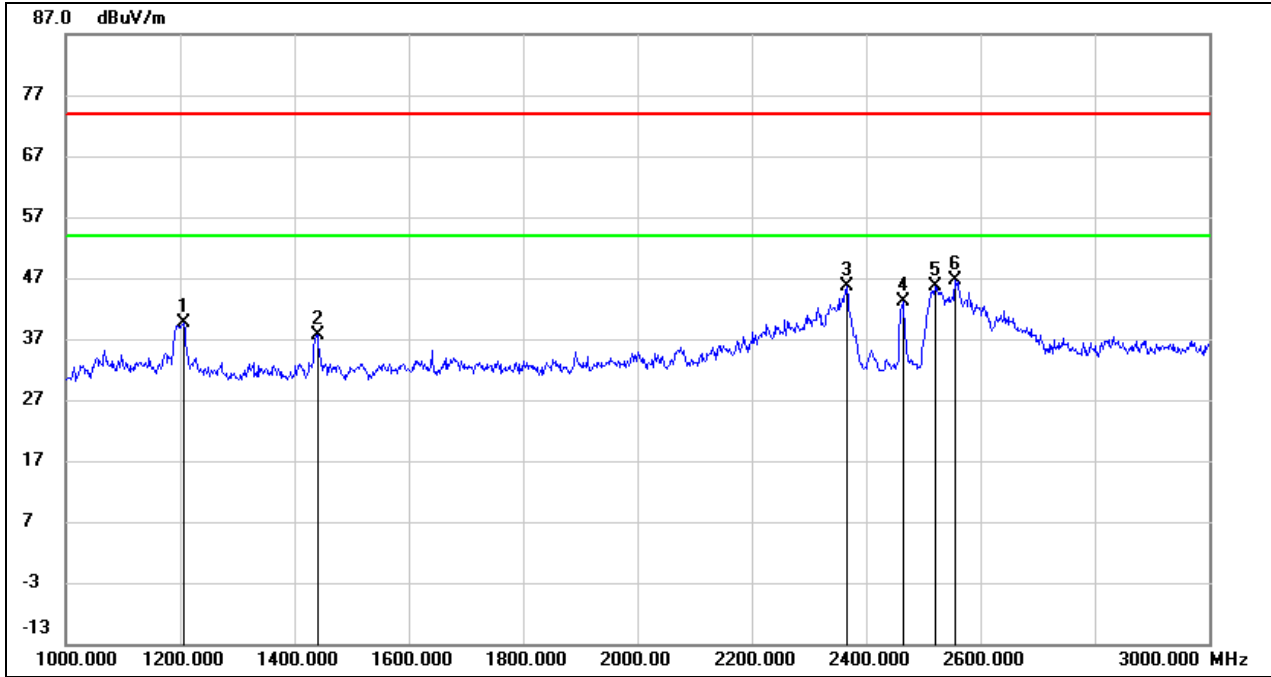

No.	Frequency (MHz)	Reading (dBuV)	Correct (dB/m)	Result (dBuV/m)	Limit (dBuV/m)	Margin (dB)	Remark
1	1206.000	53.80	-14.07	39.73	74.00	-34.27	peak
2	1440.000	50.69	-12.98	37.71	74.00	-36.29	peak
3	2366.000	54.74	-9.18	45.56	74.00	-28.44	peak
4	2462.000	51.83	-8.68	43.15	/	/	fundamental
5	2520.000	53.97	-8.43	45.54	74.00	-28.46	peak
6	2556.000	54.93	-8.32	46.61	74.00	-27.39	peak



Test Mode:	802.11b	Channel:	2462
Polarity:	Vertical	Test Voltage:	DC 14.4 V

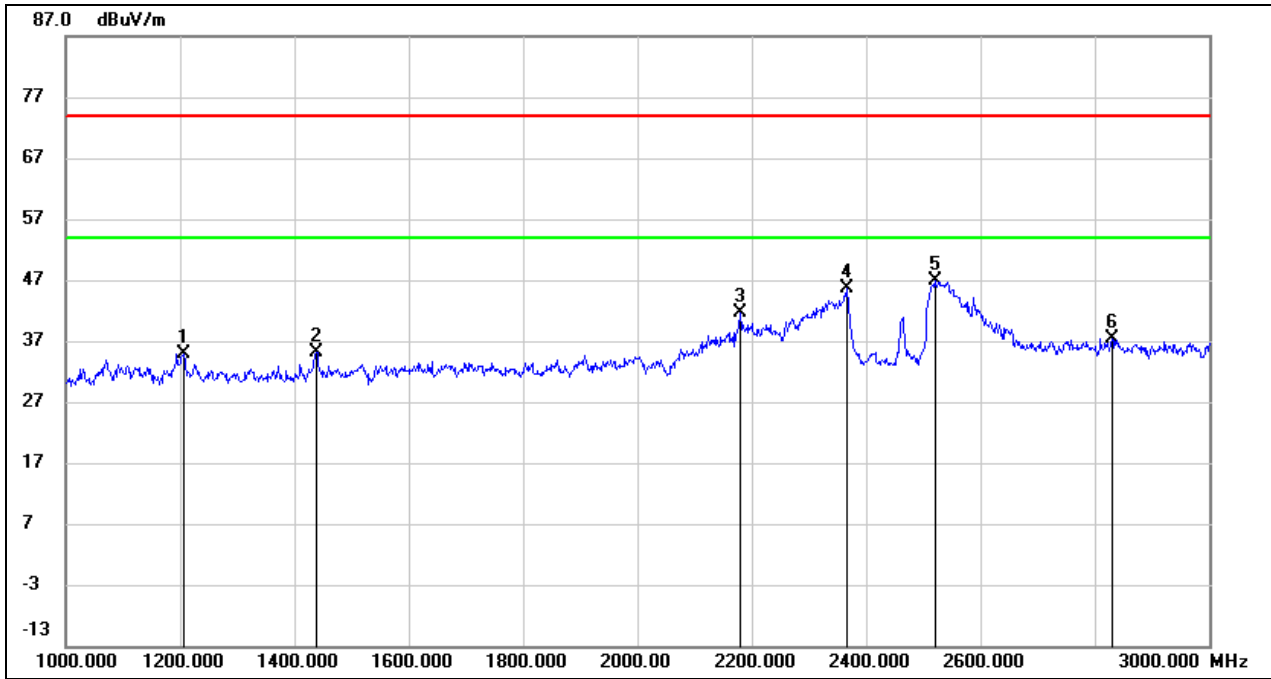

No.	Frequency (MHz)	Reading (dBuV)	Correct (dB/m)	Result (dBuV/m)	Limit (dBuV/m)	Margin (dB)	Remark
1	1206.000	49.02	-14.07	34.95	74.00	-39.05	peak
2	1438.000	48.08	-13.00	35.08	74.00	-38.92	peak
3	2180.000	51.75	-10.13	41.62	74.00	-32.38	peak
4	2366.000	54.77	-9.18	45.59	74.00	-28.41	peak
5	2520.000	55.30	-8.43	46.87	74.00	-27.13	peak
6	2830.000	44.88	-7.50	37.38	74.00	-36.62	peak



8.3. SPURIOUS EMISSIONS(3 GHZ~18 GHZ)

Test Mode:	802.11b	Channel:	2412
Polarity:	Horizontal	Test Voltage:	DC 14.4 V

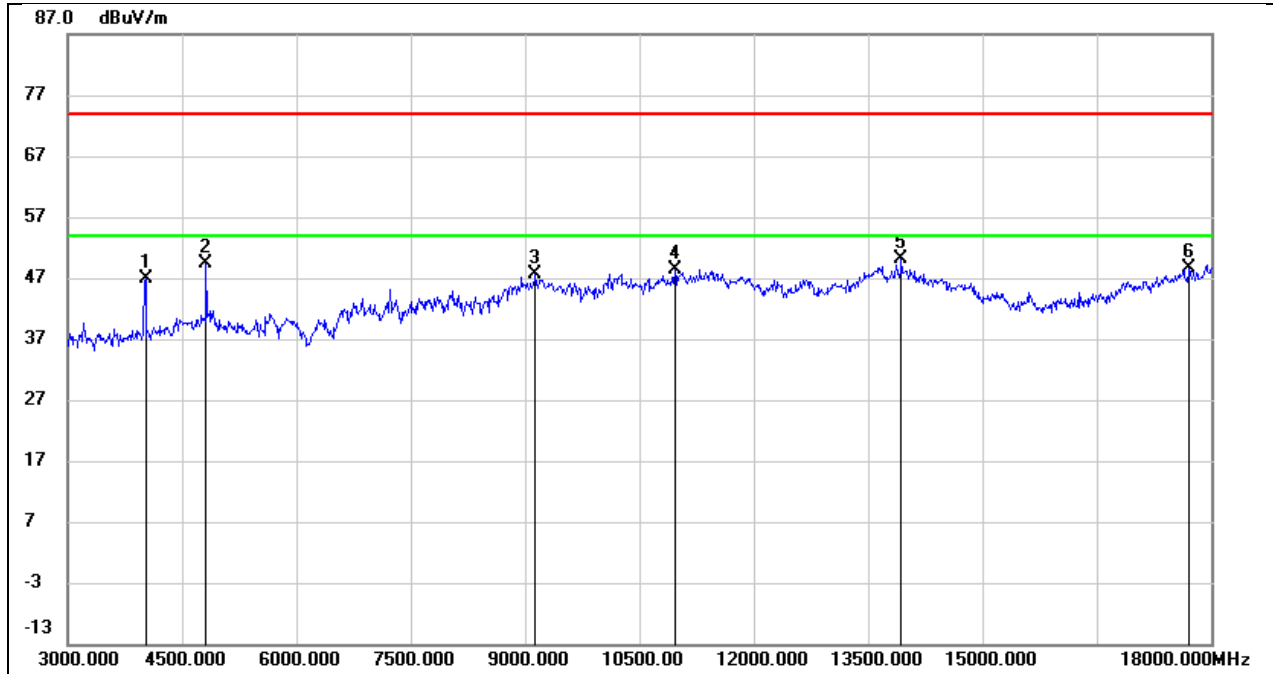

No.	Frequency (MHz)	Reading (dBuV)	Correct (dB/m)	Result (dBuV/m)	Limit (dBuV/m)	Margin (dB)	Remark
1	4020.000	50.57	-3.71	46.86	74.00	-27.14	peak
2	4815.000	49.65	-0.26	49.39	74.00	-24.61	peak
3	9135.000	37.02	10.55	47.57	74.00	-26.43	peak
4	10965.000	33.70	14.64	48.34	74.00	-25.66	peak
5	13935.000	28.19	21.82	50.01	74.00	-23.99	peak
6	17715.000	24.61	24.00	48.61	74.00	-25.39	peak



Test Mode:	802.11b	Channel:	2412
Polarity:	Vertical	Test Voltage:	DC 14.4 V

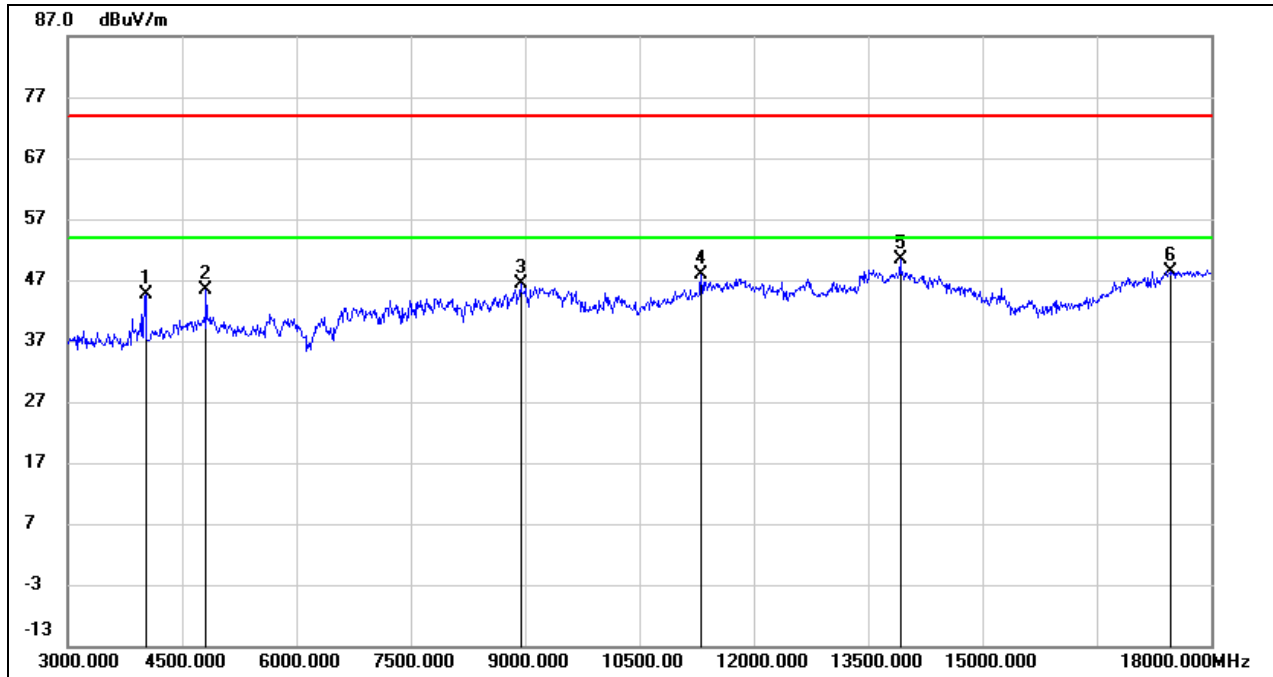

No.	Frequency (MHz)	Reading (dBuV)	Correct (dB/m)	Result (dBuV/m)	Limit (dBuV/m)	Margin (dB)	Remark
1	4020.000	48.35	-3.71	44.64	74.00	-29.36	peak
2	4815.000	45.53	-0.26	45.27	74.00	-28.73	peak
3	8940.000	36.34	10.04	46.38	74.00	-27.62	peak
4	11310.000	31.93	15.91	47.84	74.00	-26.16	peak
5	13920.000	28.59	21.79	50.38	74.00	-23.62	peak
6	17475.000	25.85	22.64	48.49	74.00	-25.51	peak



Test Mode:	802.11b	Channel:	2437
Polarity:	Horizontal	Test Voltage:	DC 14.4 V

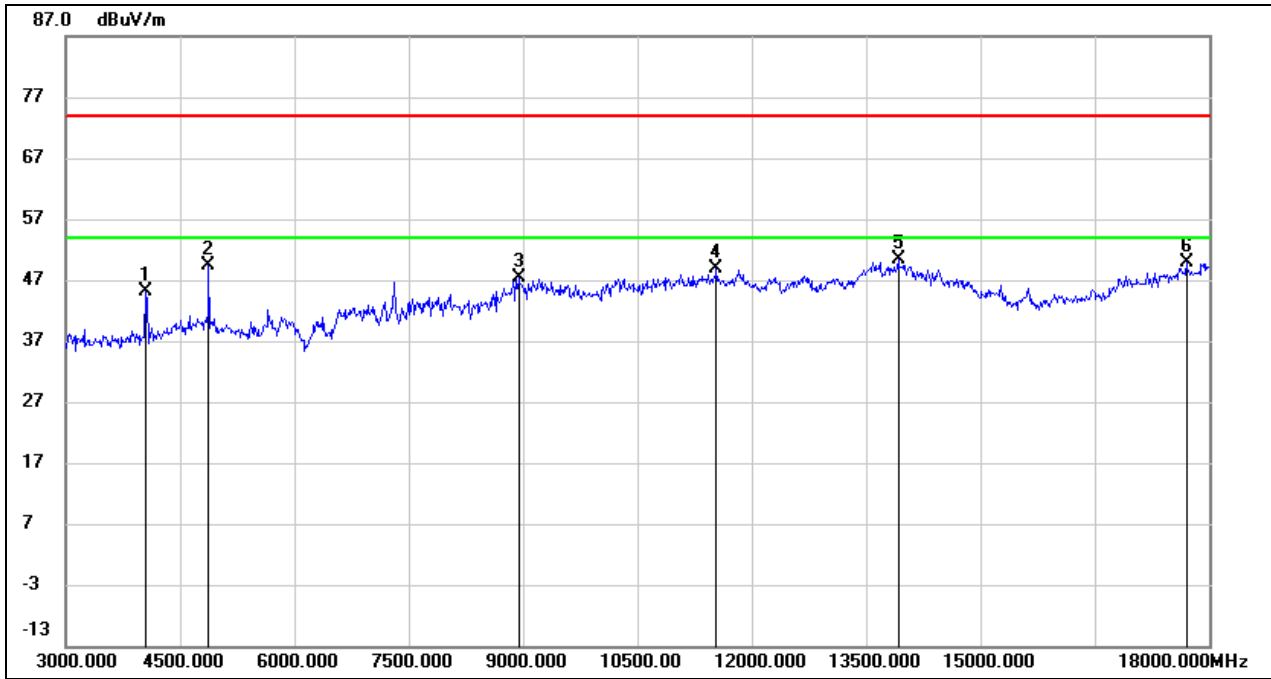

No.	Frequency (MHz)	Reading (dBuV)	Correct (dB/m)	Result (dBuV/m)	Limit (dBuV/m)	Margin (dB)	Remark
1	4050.000	48.81	-3.56	45.25	74.00	-28.75	peak
2	4875.000	49.32	-0.03	49.29	74.00	-24.71	peak
3	8940.000	37.30	10.04	47.34	74.00	-26.66	peak
4	11535.000	32.07	16.70	48.77	74.00	-25.23	peak
5	13920.000	28.69	21.79	50.48	74.00	-23.52	peak
6	17700.000	25.90	23.91	49.81	74.00	-24.19	peak



Test Mode:	802.11b	Channel:	2437
Polarity:	Vertical	Test Voltage:	DC 14.4 V

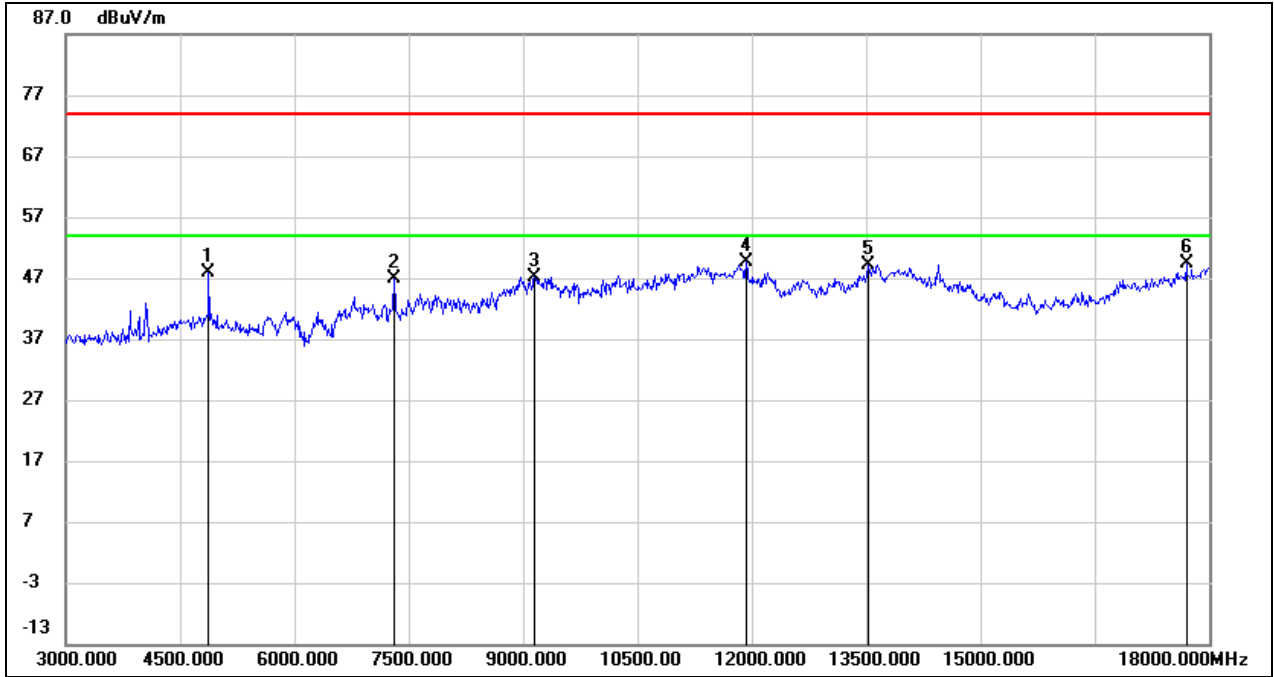

No.	Frequency (MHz)	Reading (dBuV)	Correct (dB/m)	Result (dBuV/m)	Limit (dBuV/m)	Margin (dB)	Remark
1	4875.000	48.01	-0.03	47.98	74.00	-26.02	peak
2	7305.000	40.33	6.47	46.80	74.00	-27.20	peak
3	9150.000	36.68	10.54	47.22	74.00	-26.78	peak
4	11925.000	31.91	17.75	49.66	74.00	-24.34	peak
5	13530.000	28.25	20.96	49.21	74.00	-24.79	peak
6	17700.000	25.35	23.91	49.26	74.00	-24.74	peak



Test Mode:	802.11b	Channel:	2462
Polarity:	Horizontal	Test Voltage:	DC 14.4 V

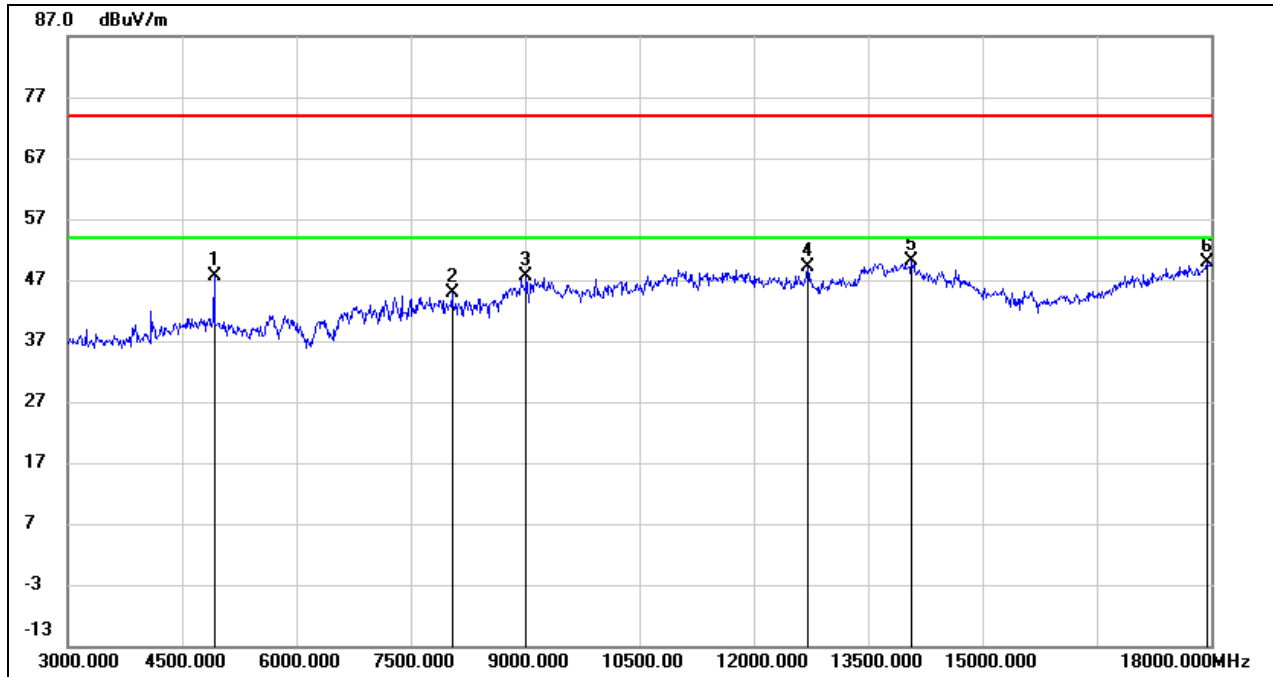

No.	Frequency (MHz)	Reading (dBuV)	Correct (dB/m)	Result (dBuV/m)	Limit (dBuV/m)	Margin (dB)	Remark
1	4920.000	47.41	0.14	47.55	74.00	-26.45	peak
2	8040.000	38.44	6.34	44.78	74.00	-29.22	peak
3	9015.000	37.07	10.49	47.56	74.00	-26.44	peak
4	12705.000	31.01	18.06	49.07	74.00	-24.93	peak
5	14070.000	28.42	21.67	50.09	74.00	-23.91	peak
6	17940.000	24.56	25.34	49.90	74.00	-24.10	peak



Test Mode:	802.11b	Channel:	2462
Polarity:	Vertical	Test Voltage:	DC 14.4 V

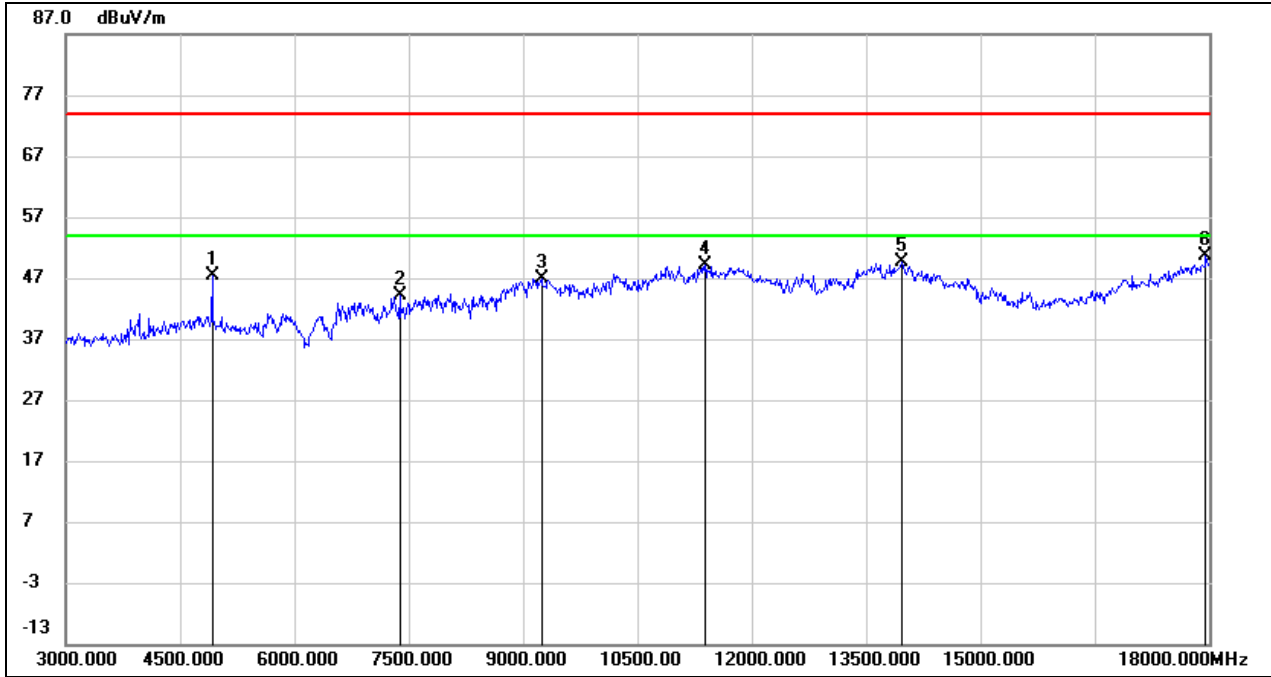

No.	Frequency (MHz)	Reading (dBuV)	Correct (dB/m)	Result (dBuV/m)	Limit (dBuV/m)	Margin (dB)	Remark
1	4920.000	47.31	0.14	47.45	74.00	-26.55	peak
2	7380.000	37.68	6.42	44.10	74.00	-29.90	peak
3	9240.000	36.23	10.58	46.81	74.00	-27.19	peak
4	11385.000	32.89	16.17	49.06	74.00	-24.94	peak
5	13965.000	27.76	21.89	49.65	74.00	-24.35	peak
6	17955.000	25.21	25.42	50.63	74.00	-23.37	peak



Test Mode:	802.11g	Channel:	2412
Polarity:	Horizontal	Test Voltage:	DC 14.4 V

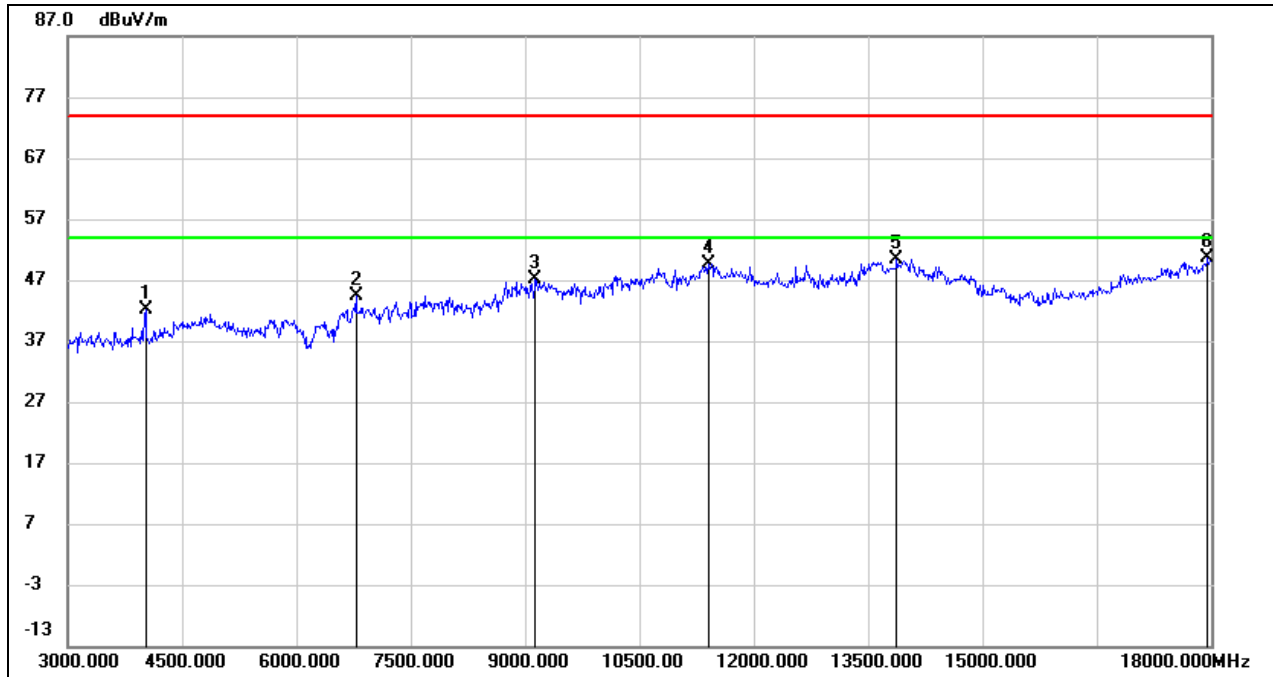

No.	Frequency (MHz)	Reading (dBuV)	Correct (dB/m)	Result (dBuV/m)	Limit (dBuV/m)	Margin (dB)	Remark
1	4020.000	45.83	-3.71	42.12	74.00	-31.88	peak
2	6780.000	38.84	5.60	44.44	74.00	-29.56	peak
3	9135.000	36.54	10.55	47.09	74.00	-26.91	peak
4	11400.000	33.41	16.23	49.64	74.00	-24.36	peak
5	13875.000	28.70	21.70	50.40	74.00	-23.60	peak
6	17955.000	25.26	25.42	50.68	74.00	-23.32	peak



Test Mode:	802.11g	Channel:	2412
Polarity:	Vertical	Test Voltage:	DC 14.4 V

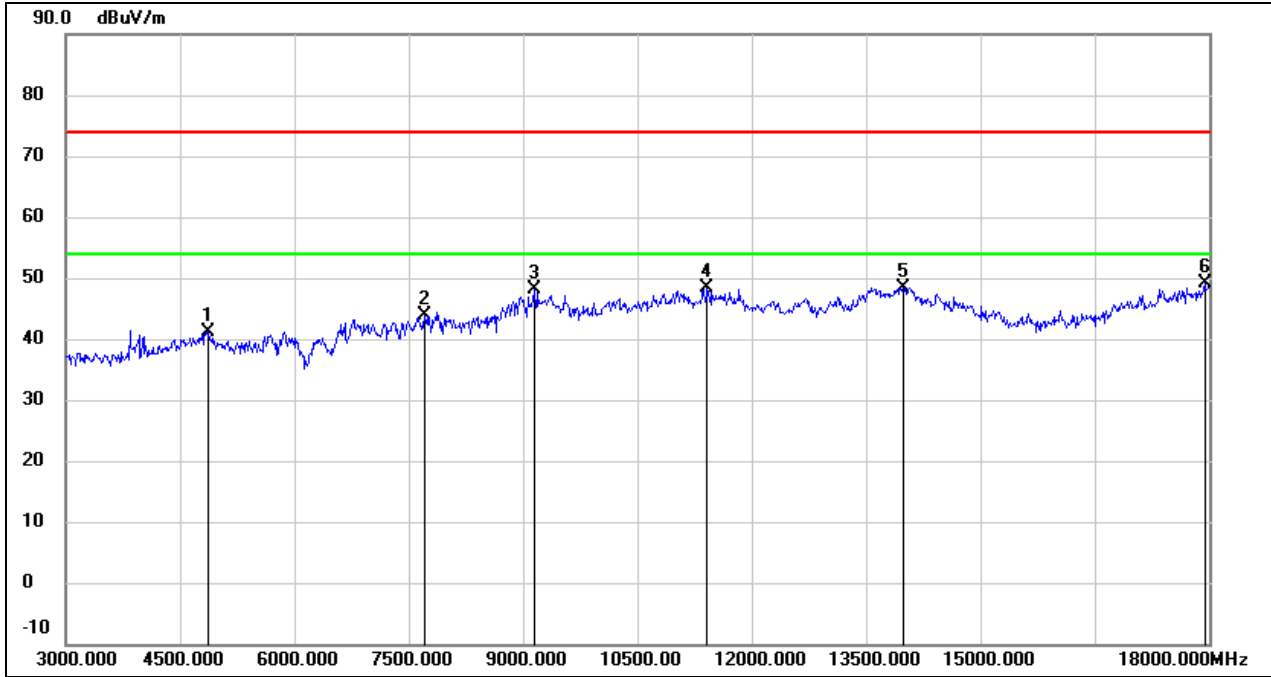

No.	Frequency (MHz)	Reading (dBuV)	Correct (dB/m)	Result (dBuV/m)	Limit (dBuV/m)	Margin (dB)	Remark
1	4875.000	41.11	-0.03	41.08	74.00	-32.92	peak
2	7710.000	37.48	6.33	43.81	74.00	-30.19	peak
3	9150.000	37.56	10.54	48.10	74.00	-25.90	peak
4	11415.000	32.08	16.29	48.37	74.00	-25.63	peak
5	13980.000	26.49	21.92	48.41	74.00	-25.59	peak
6	17940.000	23.73	25.34	49.07	74.00	-24.93	peak



Test Mode:	802.11g	Channel:	2437
Polarity:	Horizontal	Test Voltage:	DC 14.4 V

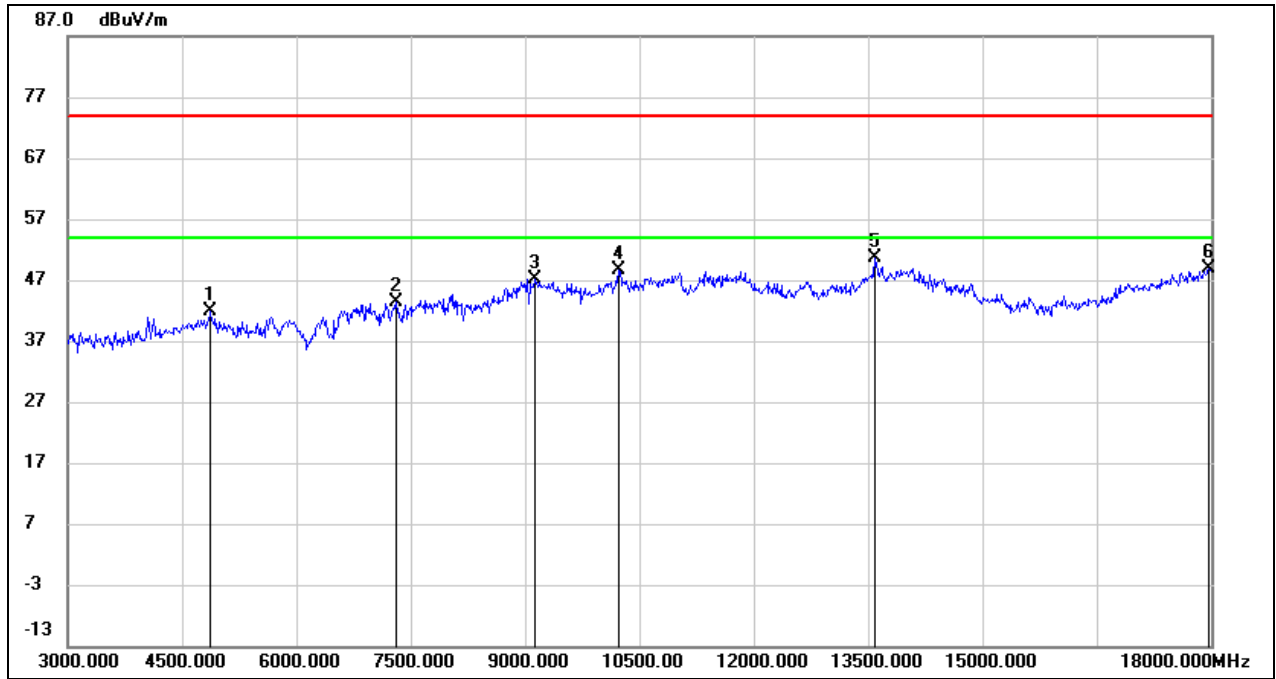

No.	Frequency (MHz)	Reading (dBuV)	Correct (dB/m)	Result (dBuV/m)	Limit (dBuV/m)	Margin (dB)	Remark
1	4875.000	41.95	-0.03	41.92	74.00	-32.08	peak
2	7305.000	36.84	6.47	43.31	74.00	-30.69	peak
3	9120.000	36.71	10.53	47.24	74.00	-26.76	peak
4	10230.000	36.20	12.46	48.66	74.00	-25.34	peak
5	13590.000	29.51	21.09	50.60	74.00	-23.40	peak
6	17970.000	23.25	25.51	48.76	74.00	-25.24	peak



Test Mode:	802.11g	Channel:	2437
Polarity:	Vertical	Test Voltage:	DC 14.4 V

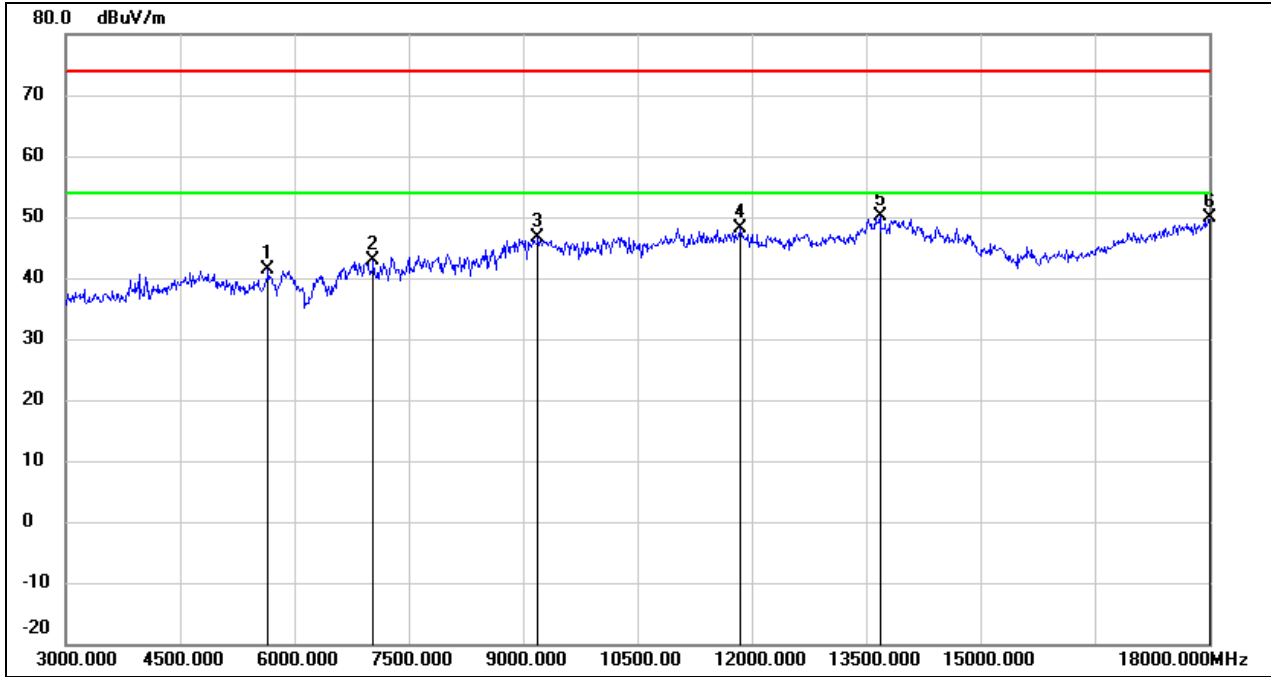

No.	Frequency (MHz)	Reading (dBuV)	Correct (dB/m)	Result (dBuV/m)	Limit (dBuV/m)	Margin (dB)	Remark
1	5655.000	39.99	1.29	41.28	74.00	-32.72	peak
2	7035.000	36.13	6.67	42.80	74.00	-31.20	peak
3	9195.000	36.05	10.56	46.61	74.00	-27.39	peak
4	11850.000	30.60	17.56	48.16	74.00	-25.84	peak
5	13680.000	28.94	21.29	50.23	74.00	-23.77	peak
6	18000.000	24.22	25.69	49.91	74.00	-24.09	peak



Test Mode:	802.11g	Channel:	2462
Polarity:	Horizontal	Test Voltage:	DC 14.4 V

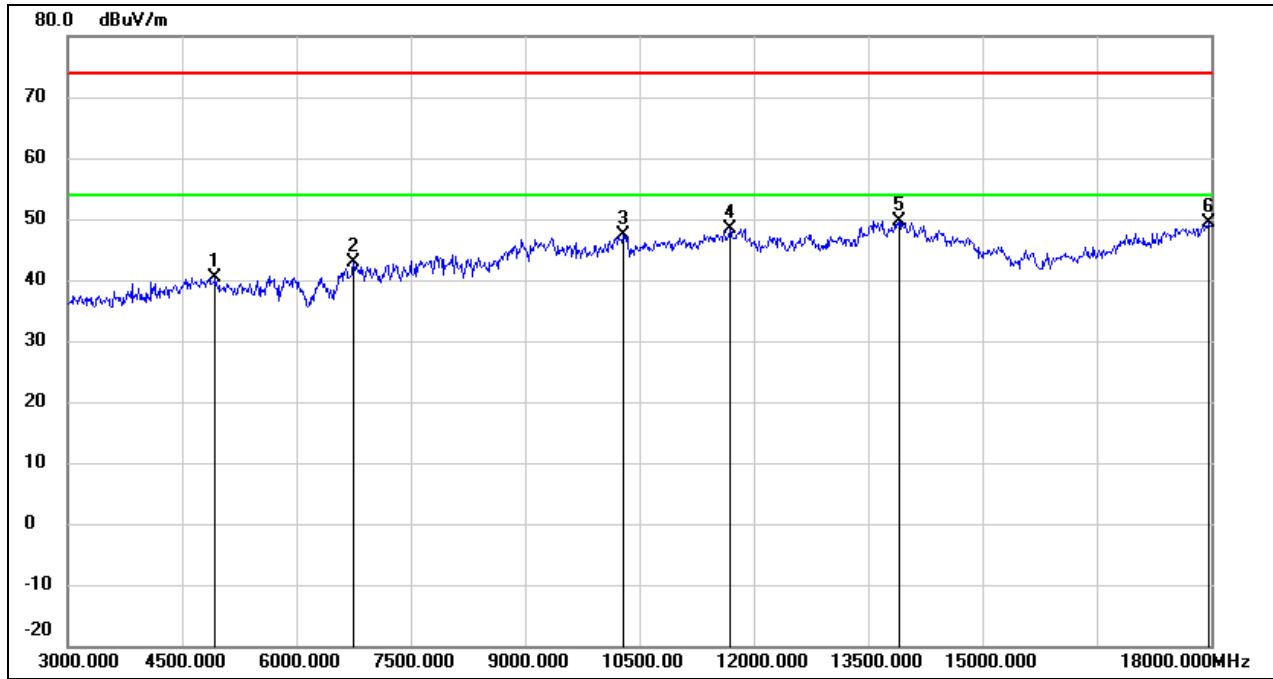

No.	Frequency (MHz)	Reading (dBuV)	Correct (dB/m)	Result (dBuV/m)	Limit (dBuV/m)	Margin (dB)	Remark
1	4935.000	40.20	0.20	40.40	74.00	-33.60	peak
2	6750.000	37.55	5.45	43.00	74.00	-31.00	peak
3	10290.000	34.75	12.59	47.34	74.00	-26.66	peak
4	11685.000	31.29	17.10	48.39	74.00	-25.61	peak
5	13905.000	27.94	21.76	49.70	74.00	-24.30	peak
6	17970.000	23.79	25.51	49.30	74.00	-24.70	peak



Test Mode:	802.11g	Channel:	2462
Polarity:	Vertical	Test Voltage:	DC 14.4 V

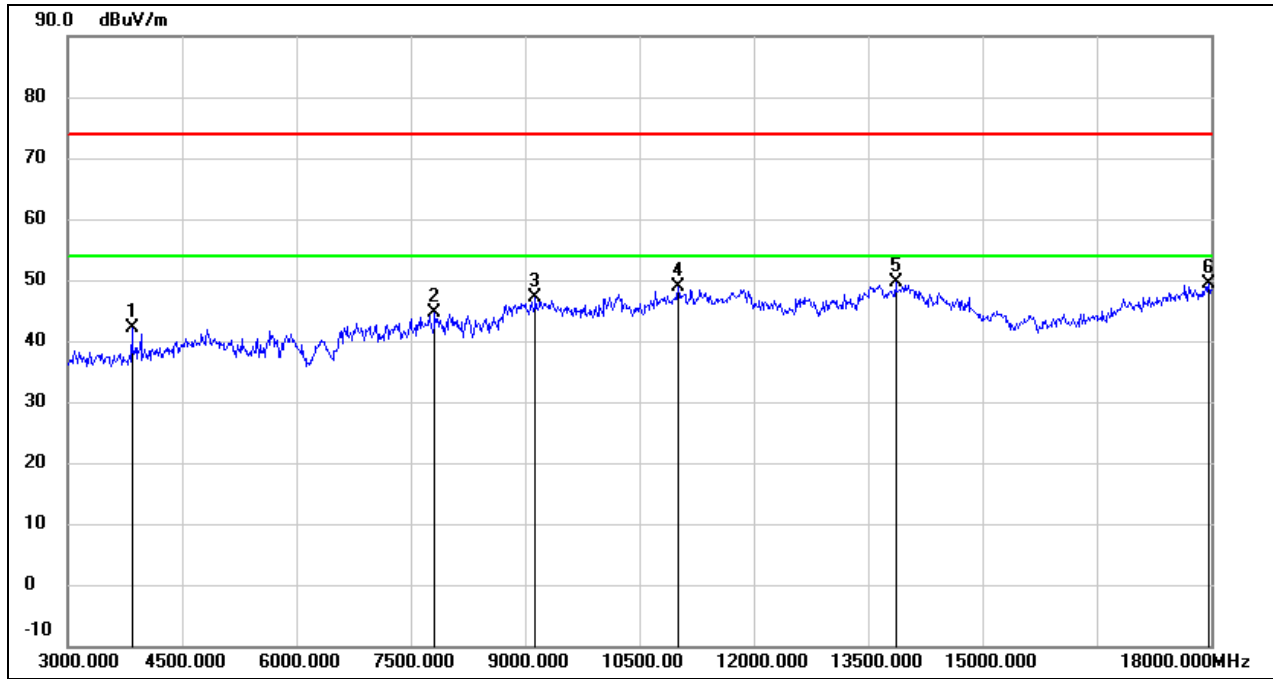

No.	Frequency (MHz)	Reading (dBuV)	Correct (dB/m)	Result (dBuV/m)	Limit (dBuV/m)	Margin (dB)	Remark
1	3840.000	46.24	-4.17	42.07	74.00	-31.93	peak
2	7815.000	38.22	6.32	44.54	74.00	-29.46	peak
3	9135.000	36.46	10.55	47.01	74.00	-26.99	peak
4	11010.000	33.99	14.81	48.80	74.00	-25.20	peak
5	13860.000	28.06	21.67	49.73	74.00	-24.27	peak
6	17970.000	23.84	25.51	49.35	74.00	-24.65	peak



Test Mode:	802.11n HT20	Channel:	2412
Polarity:	Horizontal	Test Voltage:	DC 14.4 V

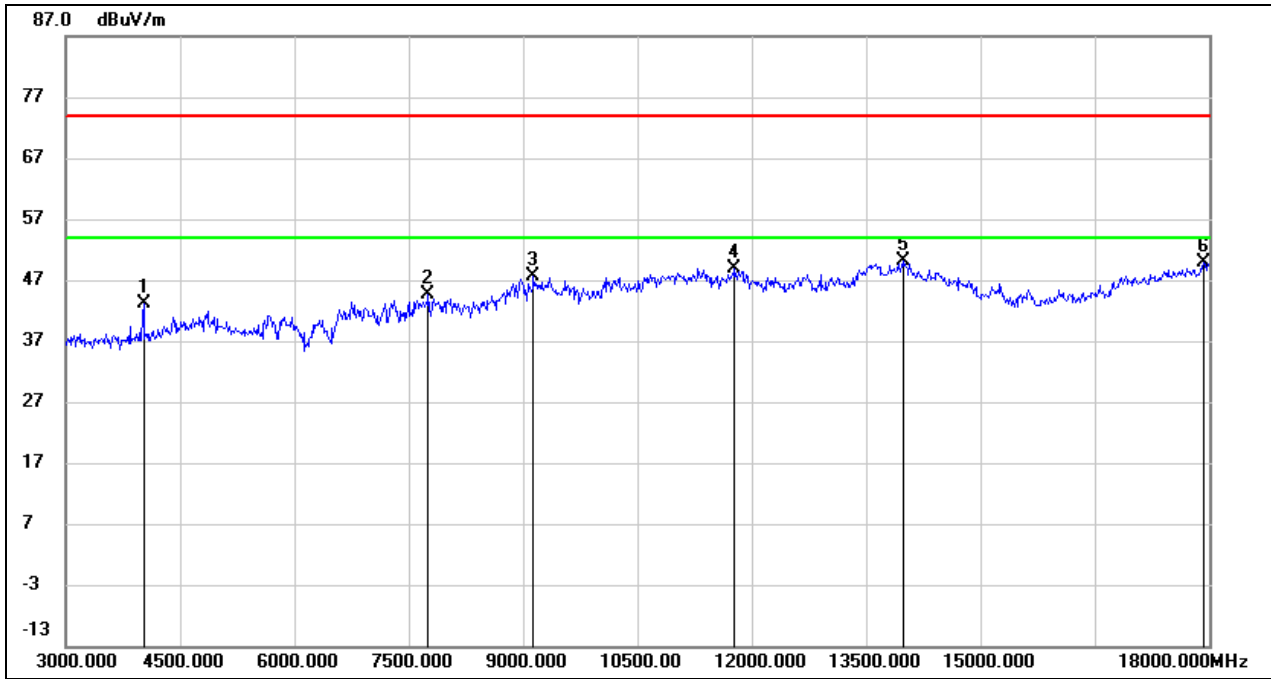

No.	Frequency (MHz)	Reading (dBuV)	Correct (dB/m)	Result (dBuV/m)	Limit (dBuV/m)	Margin (dB)	Remark
1	4020.000	46.89	-3.71	43.18	74.00	-30.82	peak
2	7755.000	38.42	6.31	44.73	74.00	-29.27	peak
3	9135.000	37.00	10.55	47.55	74.00	-26.45	peak
4	11775.000	31.56	17.35	48.91	74.00	-25.09	peak
5	13995.000	28.30	21.95	50.25	74.00	-23.75	peak
6	17925.000	24.62	25.25	49.87	74.00	-24.13	peak



Test Mode:	802.11n HT20	Channel:	2412
Polarity:	Vertical	Test Voltage:	DC 14.4 V

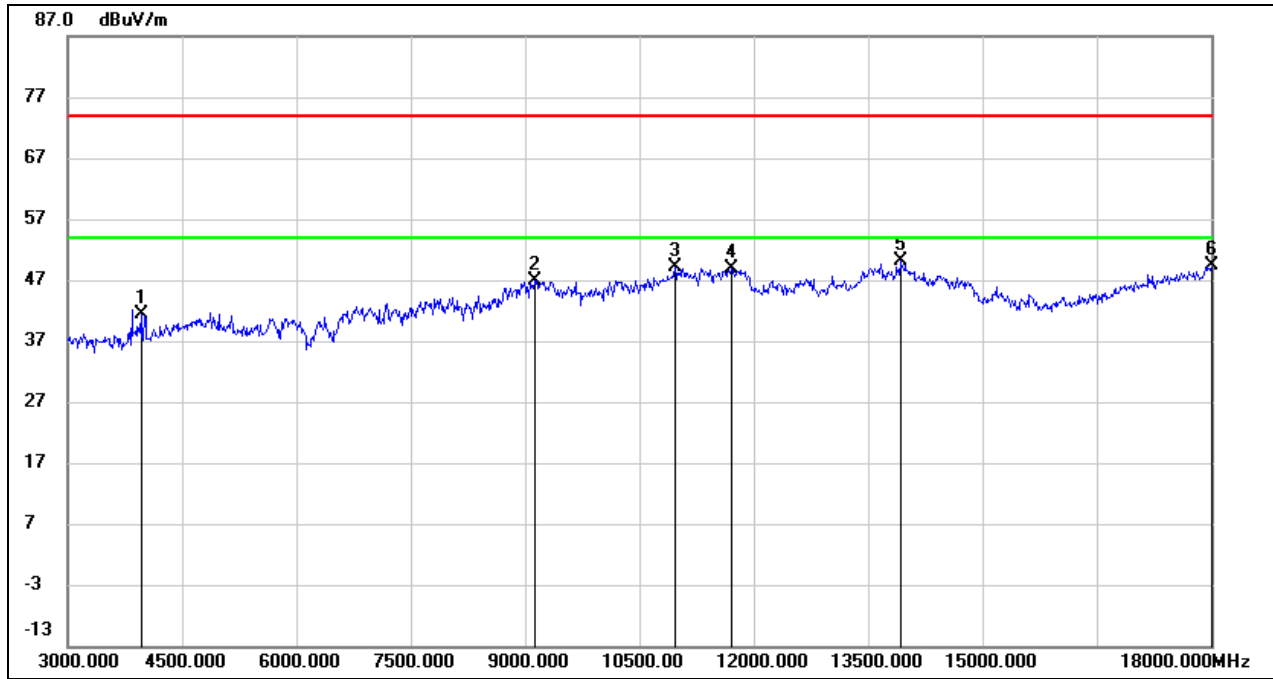

No.	Frequency (MHz)	Reading (dBuV)	Correct (dB/m)	Result (dBuV/m)	Limit (dBuV/m)	Margin (dB)	Remark
1	3960.000	45.24	-3.89	41.35	74.00	-32.65	peak
2	9135.000	36.37	10.55	46.92	74.00	-27.08	peak
3	10965.000	34.60	14.64	49.24	74.00	-24.76	peak
4	11700.000	31.63	17.14	48.77	74.00	-25.23	peak
5	13920.000	28.26	21.79	50.05	74.00	-23.95	peak
6	18000.000	23.65	25.69	49.34	74.00	-24.66	peak



Test Mode:	802.11n HT20	Channel:	2437
Polarity:	Horizontal	Test Voltage:	DC 14.4 V

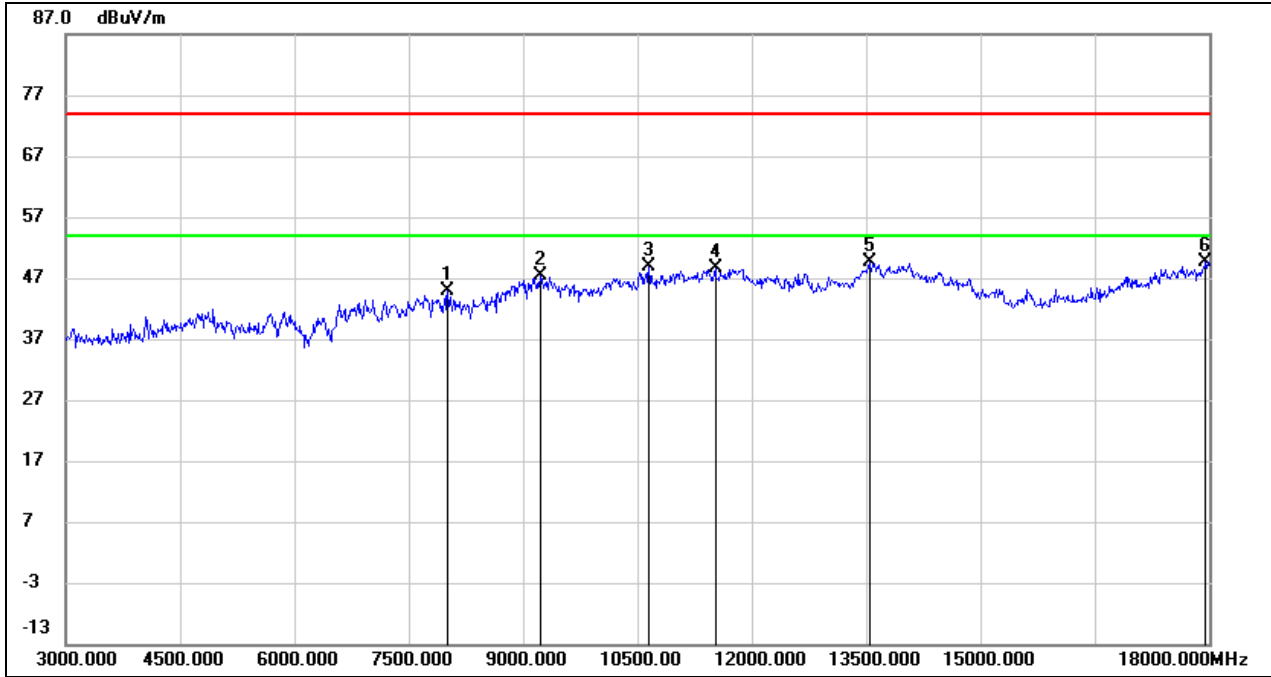

No.	Frequency (MHz)	Reading (dBuV)	Correct (dB/m)	Result (dBuV/m)	Limit (dBuV/m)	Margin (dB)	Remark
1	8010.000	38.49	6.32	44.81	74.00	-29.19	peak
2	9225.000	36.68	10.58	47.26	74.00	-26.74	peak
3	10650.000	35.27	13.53	48.80	74.00	-25.20	peak
4	11520.000	31.95	16.65	48.60	74.00	-25.40	peak
5	13545.000	28.54	20.99	49.53	74.00	-24.47	peak
6	17955.000	24.24	25.42	49.66	74.00	-24.34	peak



Test Mode:	802.11n HT20	Channel:	2437
Polarity:	Vertical	Test Voltage:	DC 14.4 V

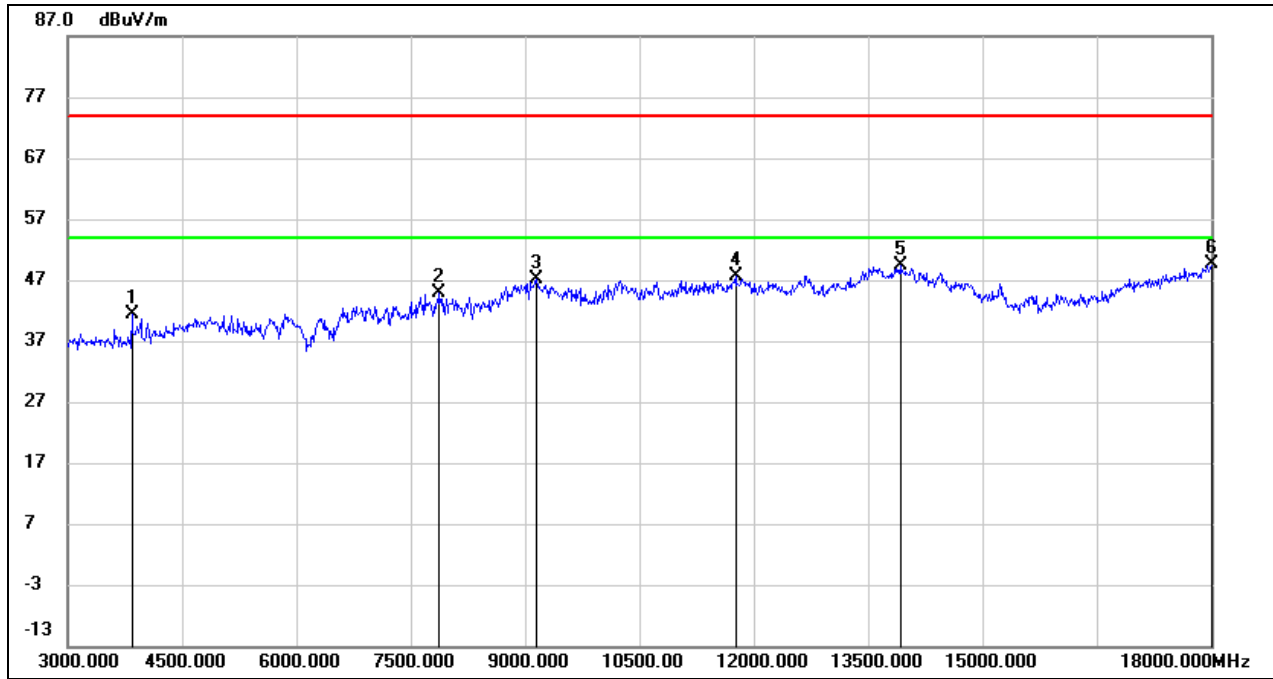

No.	Frequency (MHz)	Reading (dBuV)	Correct (dB/m)	Result (dBuV/m)	Limit (dBuV/m)	Margin (dB)	Remark
1	3840.000	45.59	-4.17	41.42	74.00	-32.58	peak
2	7875.000	38.53	6.31	44.84	74.00	-29.16	peak
3	9150.000	36.63	10.54	47.17	74.00	-26.83	peak
4	11760.000	30.43	17.31	47.74	74.00	-26.26	peak
5	13920.000	27.58	21.79	49.37	74.00	-24.63	peak
6	18000.000	23.85	25.69	49.54	74.00	-24.46	peak



Test Mode:	802.11n HT20	Channel:	2462
Polarity:	Horizontal	Test Voltage:	DC 14.4 V

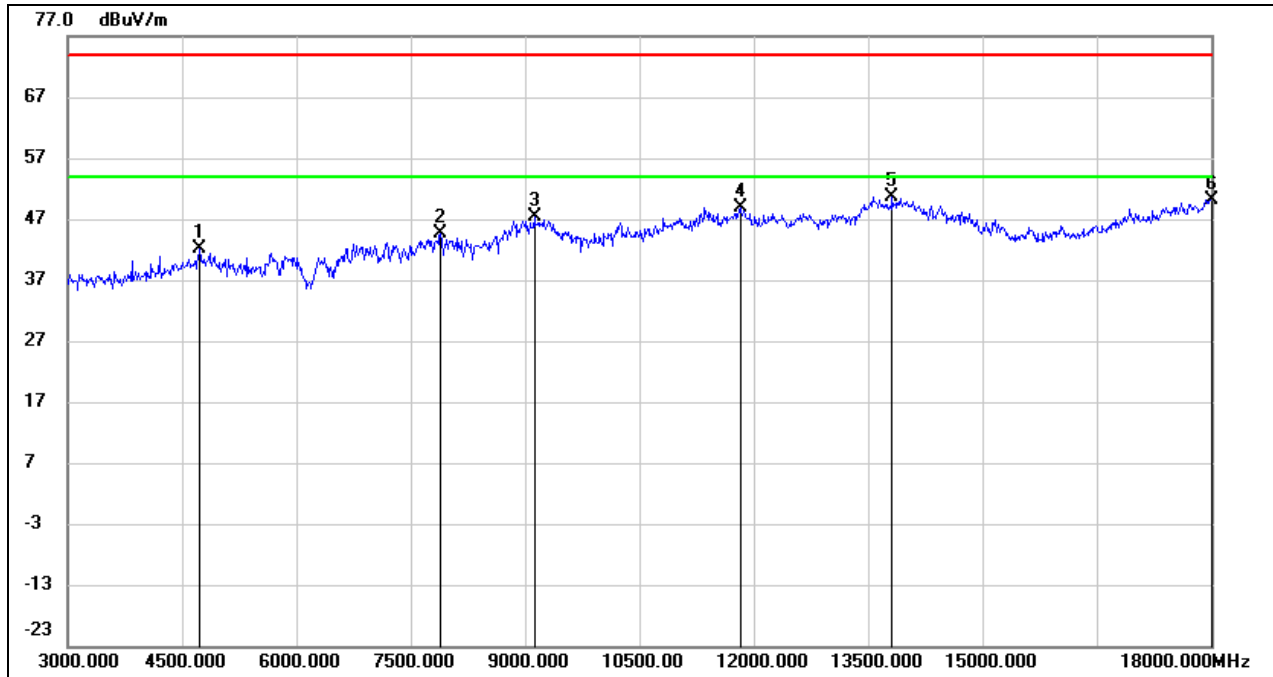

No.	Frequency (MHz)	Reading (dBuV)	Correct (dB/m)	Result (dBuV/m)	Limit (dBuV/m)	Margin (dB)	Remark
1	4725.000	42.62	-0.59	42.03	74.00	-31.97	peak
2	7890.000	38.39	6.31	44.70	74.00	-29.30	peak
3	9120.000	36.85	10.53	47.38	74.00	-26.62	peak
4	11820.000	31.50	17.47	48.97	74.00	-25.03	peak
5	13815.000	29.18	21.56	50.74	74.00	-23.26	peak
6	18000.000	24.55	25.69	50.24	74.00	-23.76	peak



Test Mode:	802.11n HT20	Channel:	2462
Polarity:	Vertical	Test Voltage:	DC 14.4 V

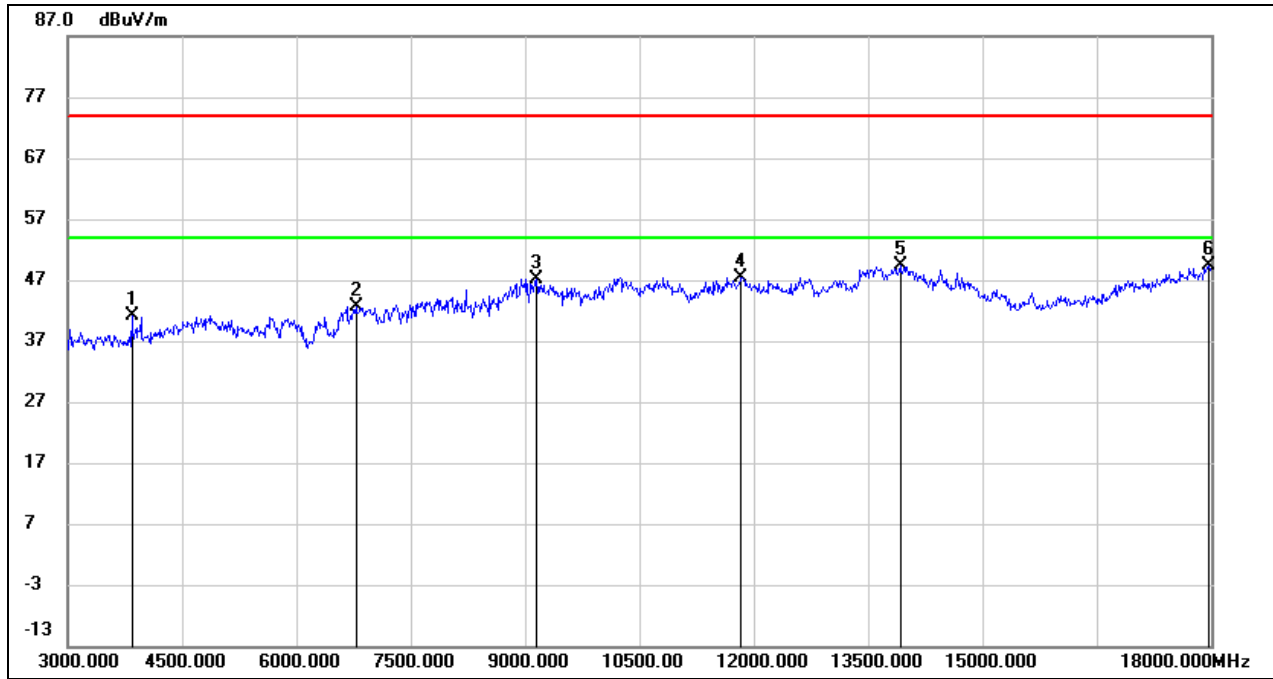

No.	Frequency (MHz)	Reading (dBuV)	Correct (dB/m)	Result (dBuV/m)	Limit (dBuV/m)	Margin (dB)	Remark
1	3840.000	45.39	-4.17	41.22	74.00	-32.78	peak
2	6780.000	37.11	5.60	42.71	74.00	-31.29	peak
3	9150.000	36.68	10.54	47.22	74.00	-26.78	peak
4	11835.000	29.93	17.51	47.44	74.00	-26.56	peak
5	13920.000	27.55	21.79	49.34	74.00	-24.66	peak
6	17970.000	23.87	25.51	49.38	74.00	-24.62	peak



Test Mode:	802.11n HT40	Channel:	2422
Polarity:	Horizontal	Test Voltage:	DC 14.4 V

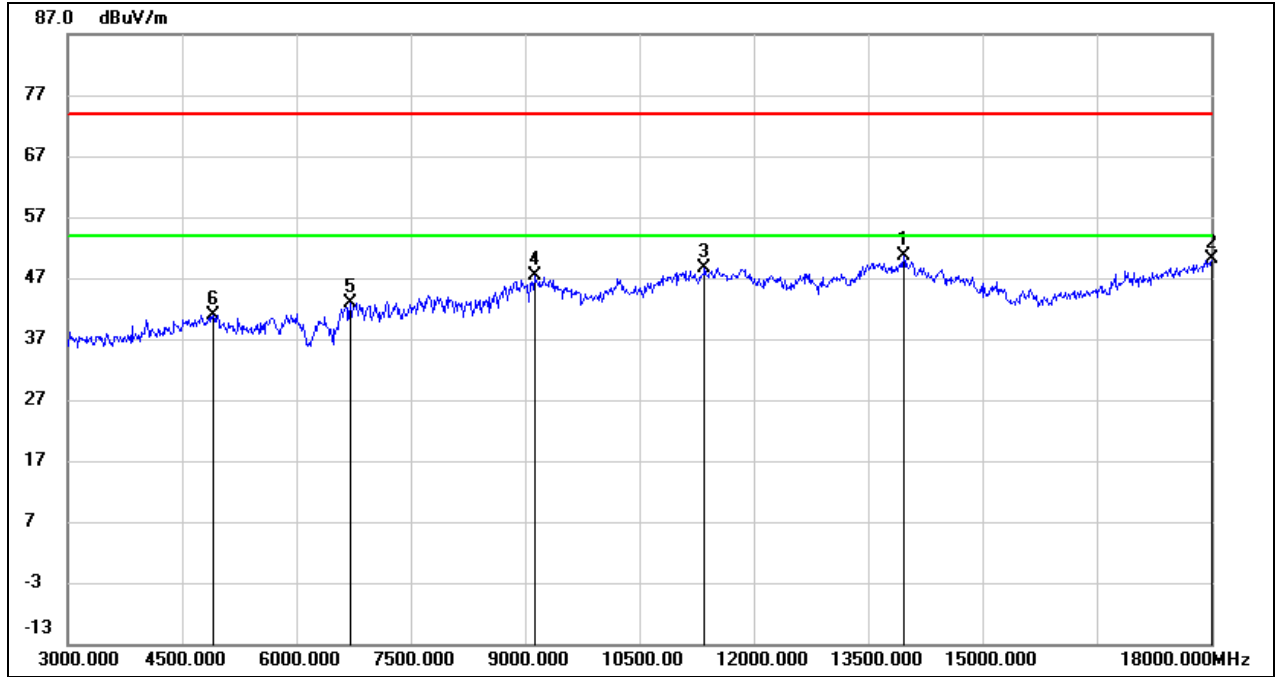

No.	Frequency (MHz)	Reading (dBuV)	Correct (dB/m)	Result (dBuV/m)	Limit (dBuV/m)	Margin (dB)	Remark
1	13965.000	28.65	21.89	50.54	74.00	-23.46	peak
2	18000.000	24.39	25.69	50.08	74.00	-23.92	peak
3	11355.000	32.67	16.06	48.73	74.00	-25.27	peak
4	9120.000	36.73	10.53	47.26	74.00	-26.74	peak
5	6705.000	37.58	5.23	42.81	74.00	-31.19	peak
6	4905.000	40.77	0.09	40.86	74.00	-33.14	peak



Test Mode:	802.11n HT40	Channel:	2422
Polarity:	Vertical	Test Voltage:	DC 14.4 V

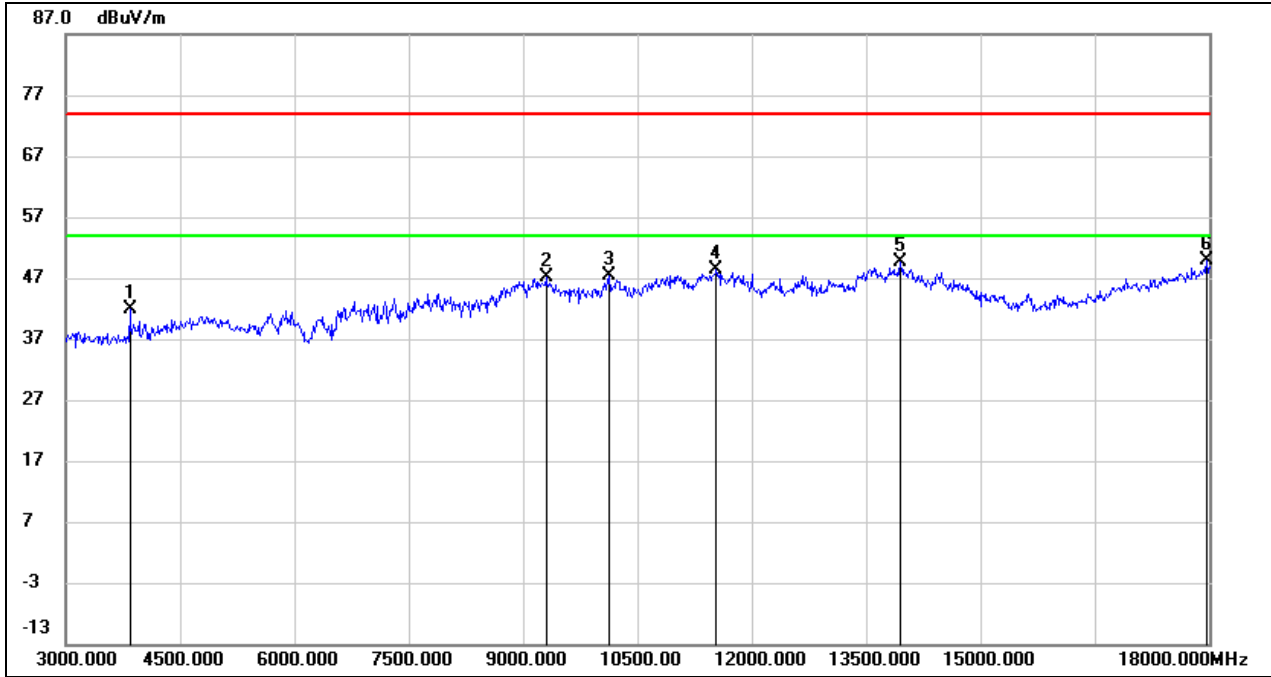

No.	Frequency (MHz)	Reading (dBuV)	Correct (dB/m)	Result (dBuV/m)	Limit (dBuV/m)	Margin (dB)	Remark
1	3840.000	45.95	-4.17	41.78	74.00	-32.22	peak
2	9300.000	36.60	10.61	47.21	74.00	-26.79	peak
3	10125.000	35.09	12.25	47.34	74.00	-26.66	peak
4	11535.000	31.72	16.70	48.42	74.00	-25.58	peak
5	13950.000	27.84	21.86	49.70	74.00	-24.30	peak
6	17970.000	24.27	25.51	49.78	74.00	-24.22	peak



Test Mode:	802.11n HT40	Channel:	2437
Polarity:	Horizontal	Test Voltage:	DC 14.4 V

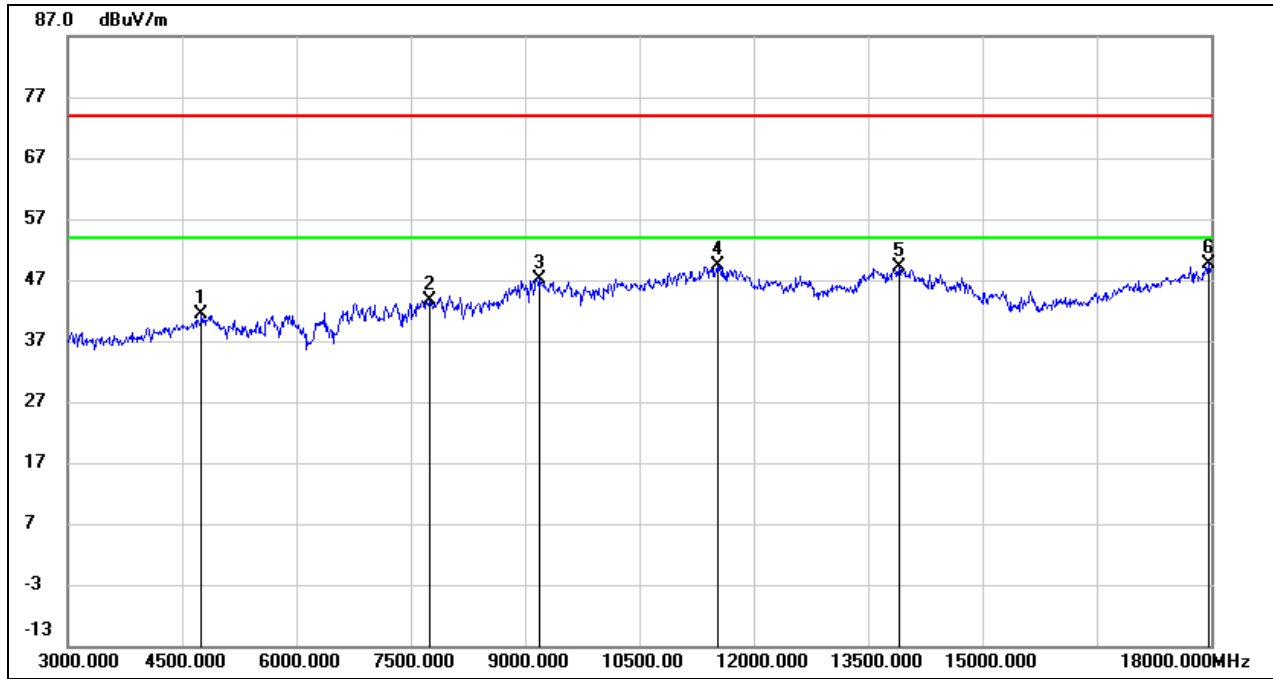

No.	Frequency (MHz)	Reading (dBuV)	Correct (dB/m)	Result (dBuV/m)	Limit (dBuV/m)	Margin (dB)	Remark
1	4755.000	41.85	-0.48	41.37	74.00	-32.63	peak
2	7755.000	37.40	6.31	43.71	74.00	-30.29	peak
3	9195.000	36.68	10.56	47.24	74.00	-26.76	peak
4	11520.000	32.68	16.65	49.33	74.00	-24.67	peak
5	13905.000	27.44	21.76	49.20	74.00	-24.80	peak
6	17970.000	24.16	25.51	49.67	74.00	-24.33	peak



Test Mode:	802.11n HT40	Channel:	2437
Polarity:	Vertical	Test Voltage:	DC 14.4 V

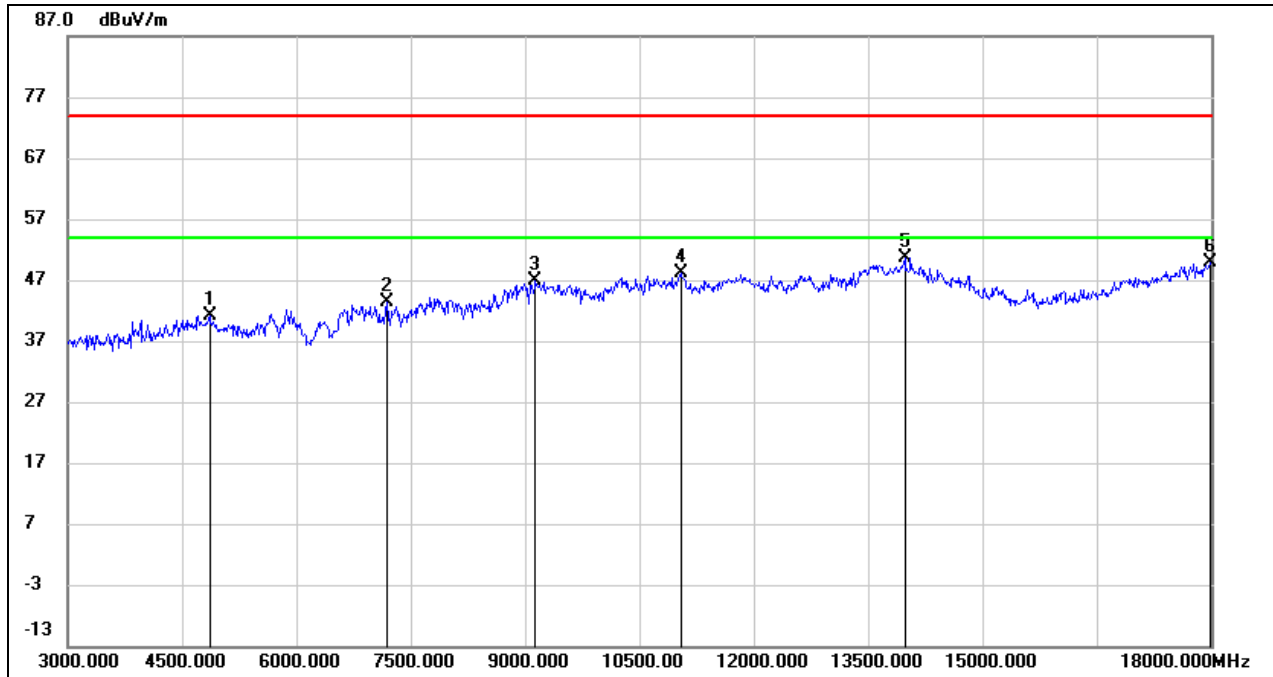

No.	Frequency (MHz)	Reading (dBuV)	Correct (dB/m)	Result (dBuV/m)	Limit (dBuV/m)	Margin (dB)	Remark
1	4860.000	41.30	-0.09	41.21	74.00	-32.79	peak
2	7185.000	36.71	6.55	43.26	74.00	-30.74	peak
3	9135.000	36.40	10.55	46.95	74.00	-27.05	peak
4	11040.000	33.29	14.91	48.20	74.00	-25.80	peak
5	13980.000	28.77	21.92	50.69	74.00	-23.31	peak
6	17985.000	24.26	25.60	49.86	74.00	-24.14	peak



Test Mode:	802.11n HT40	Channel:	2452
Polarity:	Horizontal	Test Voltage:	DC 14.4 V

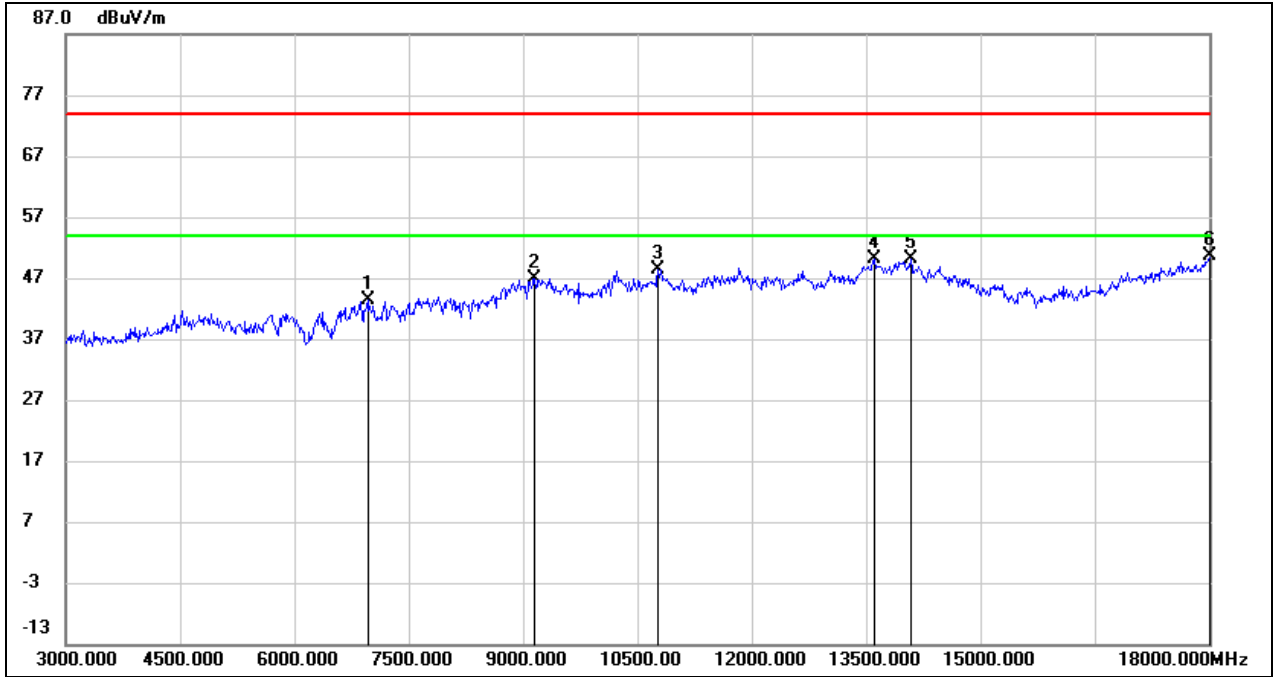

No.	Frequency (MHz)	Reading (dBuV)	Correct (dB/m)	Result (dBuV/m)	Limit (dBuV/m)	Margin (dB)	Remark
1	6960.000	36.95	6.50	43.45	74.00	-30.55	peak
2	9150.000	36.26	10.54	46.80	74.00	-27.20	peak
3	10770.000	34.41	13.95	48.36	74.00	-25.64	peak
4	13605.000	29.01	21.12	50.13	74.00	-23.87	peak
5	14085.000	28.63	21.61	50.24	74.00	-23.76	peak
6	18000.000	24.93	25.69	50.62	74.00	-23.38	peak



Test Mode:	802.11n HT40	Channel:	2452
Polarity:	Vertical	Test Voltage:	DC 14.4 V

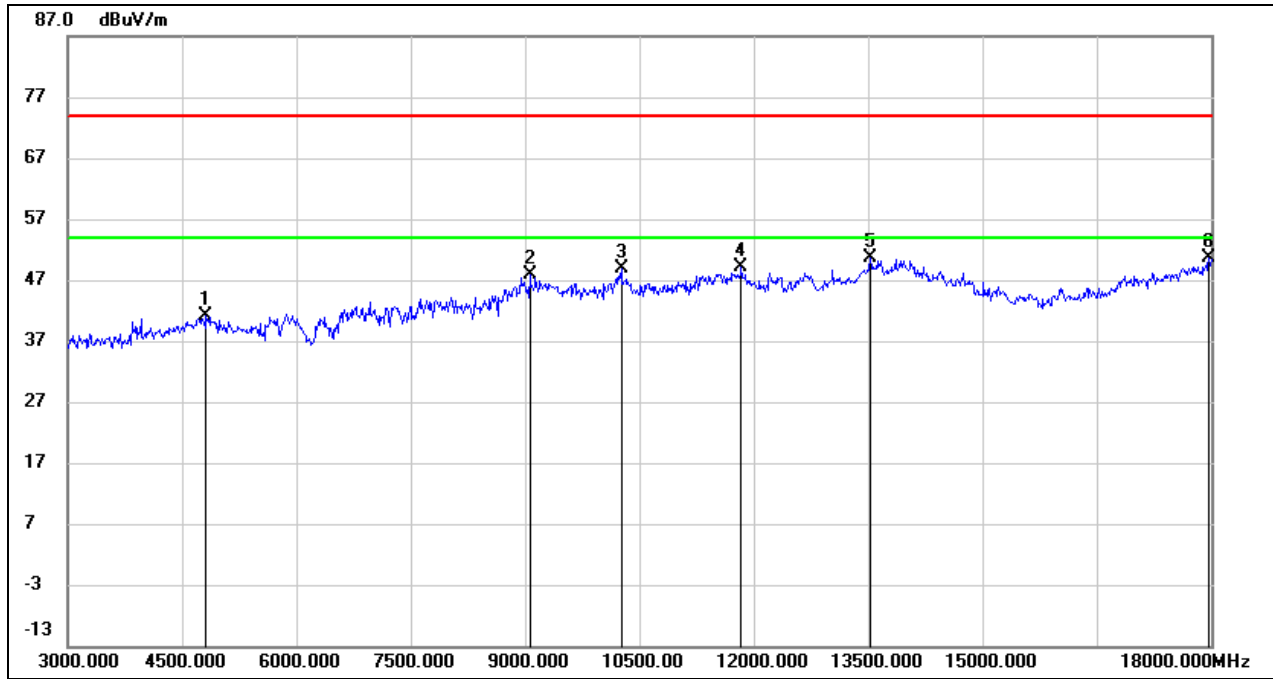

No.	Frequency (MHz)	Reading (dBuV)	Correct (dB/m)	Result (dBuV/m)	Limit (dBuV/m)	Margin (dB)	Remark
1	4815.000	41.44	-0.26	41.18	74.00	-32.82	peak
2	9060.000	37.39	10.51	47.90	74.00	-26.10	peak
3	10260.000	36.31	12.52	48.83	74.00	-25.17	peak
4	11835.000	31.50	17.51	49.01	74.00	-24.99	peak
5	13530.000	29.65	20.96	50.61	74.00	-23.39	peak
6	17970.000	25.17	25.51	50.68	74.00	-23.32	peak



8.4. SPURIOUS EMISSIONS(9 KHZ~30 MHZ)

Test Mode:	802.11b	Channel:	2412
Polarity:	Horizontal	Test Voltage:	DC 14.4 V

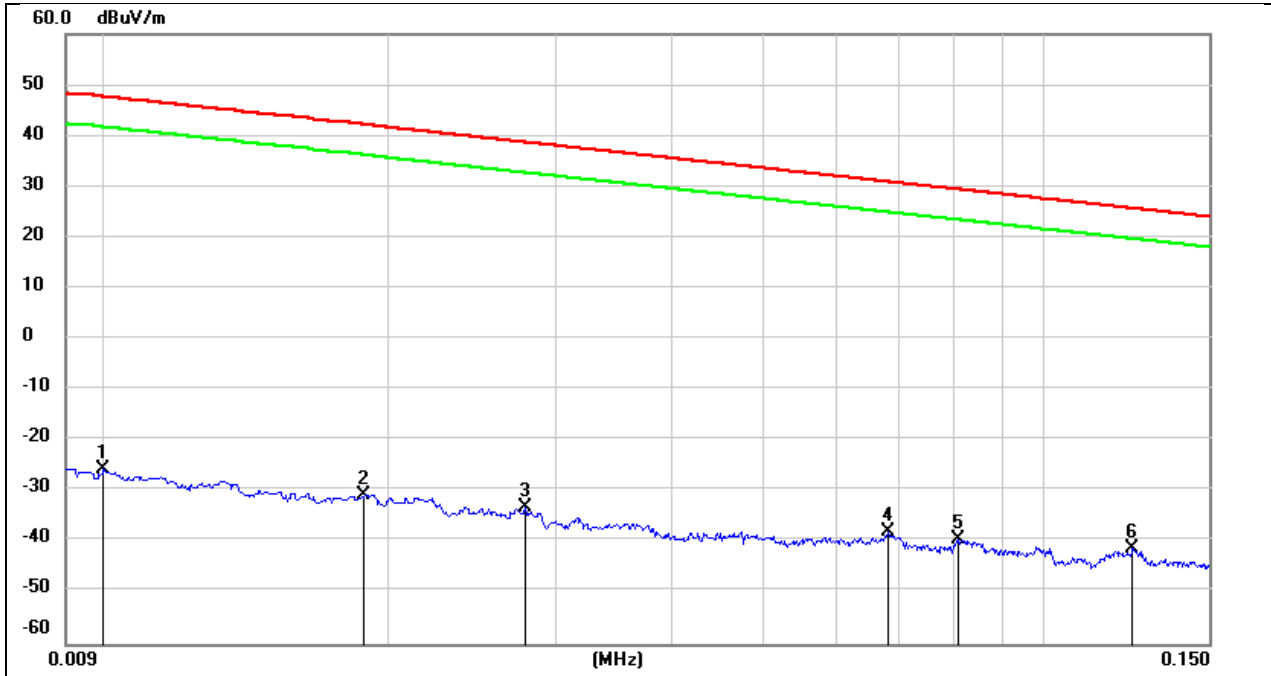

No.	Frequency (MHz)	Reading (dBuV)	Correct (dB/m)	FCC Result (dBuV/m)	FCC Limit (dBuV/m)	ISED Result (dBuA/m)	ISED Limit (dBuA/m)	Margin (dB)	Remark
1	0.0100	75.72	-101.40	-25.68	47.60	-77.18	-3.90	-73.28	peak
2	0.0188	70.64	-101.35	-30.71	42.12	-82.21	-9.38	-72.83	peak
3	0.0279	68.17	-101.38	-33.21	38.69	-84.71	-12.81	-71.90	peak
4	0.0680	63.54	-101.56	-38.02	30.95	-89.52	-20.55	-68.97	peak
5	0.0806	62.18	-101.63	-39.45	29.47	-90.95	-22.03	-68.92	peak
6	0.1242	60.51	-101.72	-41.21	25.72	-92.71	-25.78	-66.93	peak



Test Mode:	802.11b	Channel:	2412
Polarity:	Horizontal	Test Voltage:	DC 14.4 V

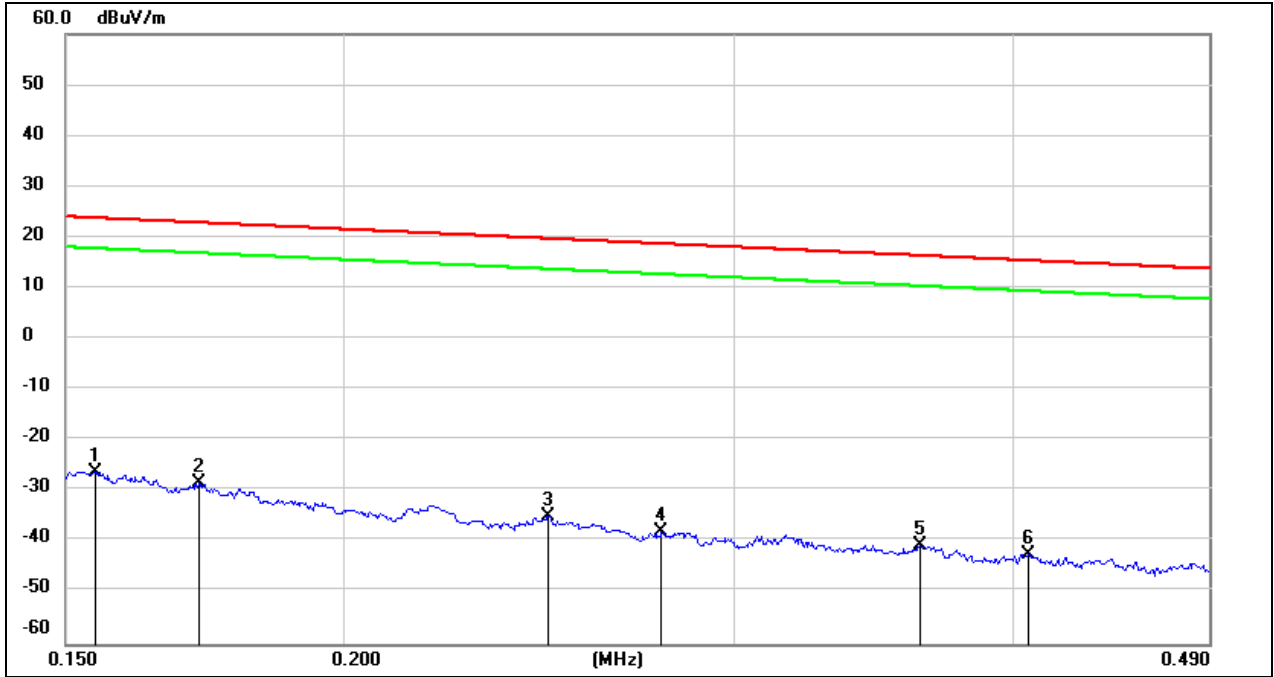

No.	Frequency (MHz)	Reading (dBuV)	Correct (dB/m)	FCC Result (dBuV/m)	FCC Limit (dBuV/m)	ISED Result (dBuA/m)	ISED Limit (dBuA/m)	Margin (dB)	Remark
1	0.1547	75.31	- 101.65	-26.34	23.81	-77.84	-27.69	-50.15	peak
2	0.1720	73.19	- 101.67	-28.48	22.90	-79.98	-28.60	-51.38	peak
3	0.2472	66.95	- 101.80	-34.85	19.74	-86.35	-31.76	-54.59	peak
4	0.2782	63.79	- 101.83	-38.04	18.71	-89.54	-32.79	-56.75	peak
5	0.3634	61.32	- 101.93	-40.61	16.39	-92.11	-35.11	-57.00	peak
6	0.4062	59.64	- 101.96	-42.32	15.43	-93.82	-36.07	-57.75	peak



Test Mode:	802.11b	Channel:	2412
Polarity:	Horizontal	Test Voltage:	DC 14.4 V

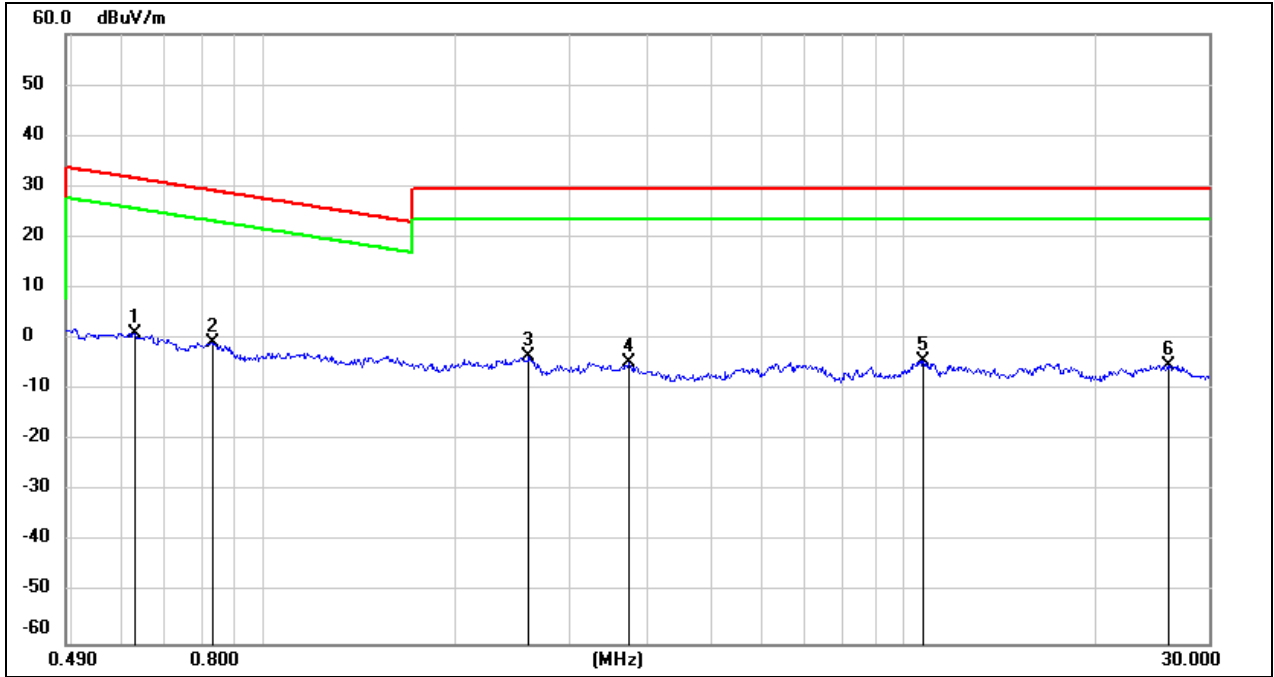

No.	Frequency (MHz)	Reading (dBuV)	Correct (dB/m)	FCC Result (dBuV/m)	FCC Limit (dBuV/m)	ISED Result (dBuA/m)	ISED Limit (dBuA/m)	Margin (dB)	Remark
1	0.6298	63.17	-62.09	1.08	31.62	-50.42	-19.88	-30.54	peak
2	0.8296	61.44	-62.17	-0.73	29.23	-52.23	-22.27	-29.96	peak
3	2.5935	58.11	-61.68	-3.57	29.54	-55.07	-21.96	-33.11	peak
4	3.7100	56.70	-61.41	-4.71	29.54	-56.21	-21.96	-34.25	peak
5	10.7299	56.48	-60.83	-4.35	29.54	-55.85	-21.96	-33.89	peak
6	25.8978	55.26	-60.36	-5.10	29.54	-56.60	-21.96	-34.64	peak



8.5. SPURIOUS EMISSIONS(18 GHZ~26 GHZ)

Test Mode:	802.11b	Channel:	2412
Polarity:	Horizontal	Test Voltage:	DC 14.4 V

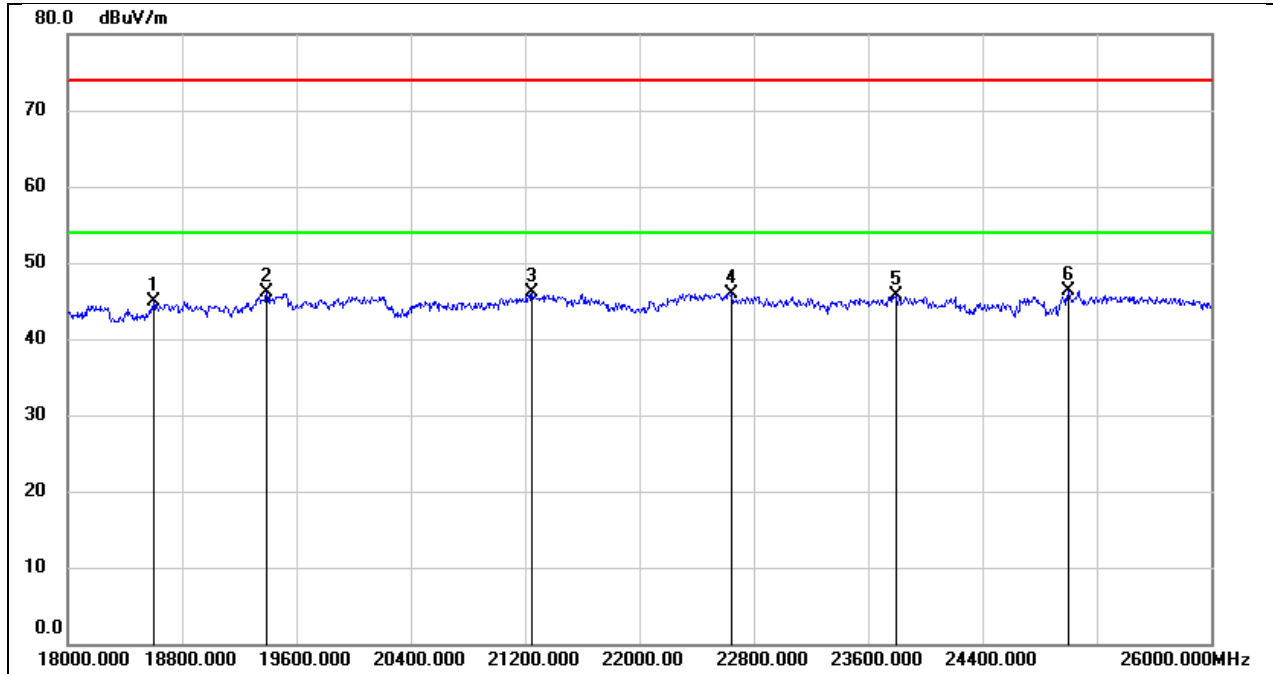

No.	Frequency (MHz)	Reading (dBuV)	Correct (dB/m)	Result (dBuV/m)	Limit (dBuV/m)	Margin (dB)	Remark
1	18600.000	50.26	-5.32	44.94	74.00	-29.06	peak
2	19392.000	51.62	-5.57	46.05	74.00	-27.95	peak
3	21248.000	50.79	-4.77	46.02	74.00	-27.98	peak
4	22648.000	49.76	-3.77	45.99	74.00	-28.01	peak
5	23800.000	48.91	-3.11	45.80	74.00	-28.20	peak
6	25000.000	48.36	-2.10	46.26	74.00	-27.74	peak



Test Mode:	802.11b	Channel:	2412
Polarity:	Vertical	Test Voltage:	DC 14.4 V

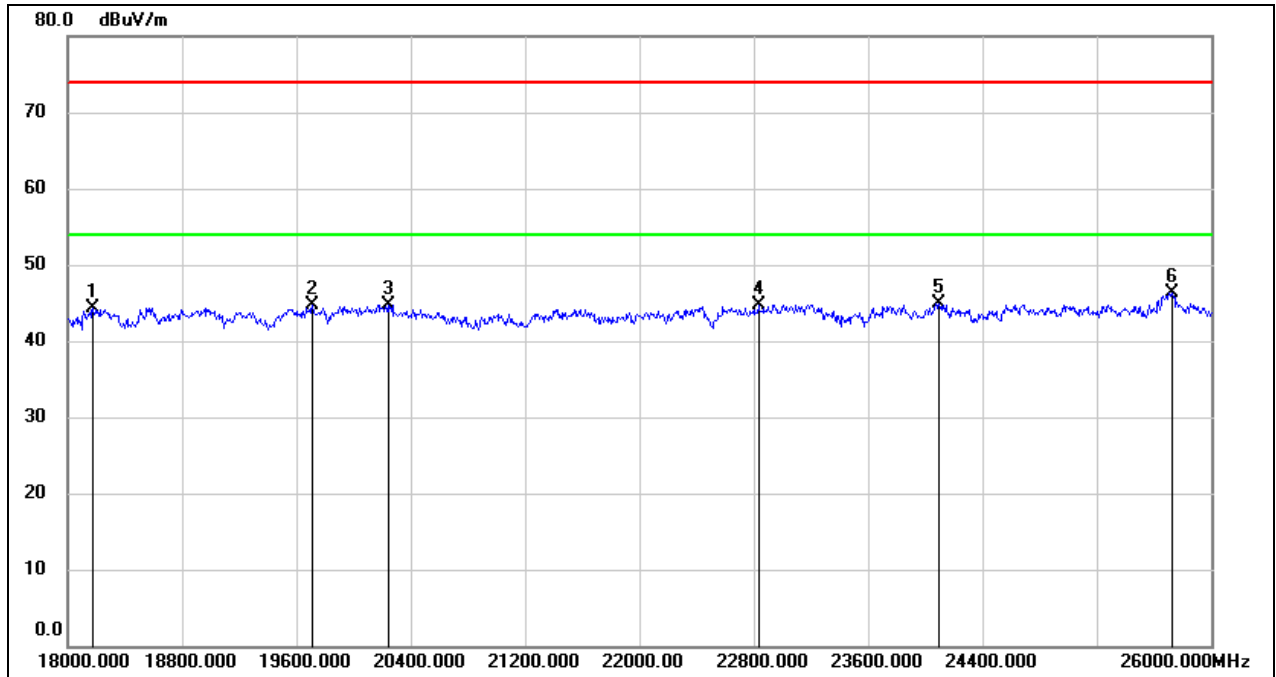

No.	Frequency (MHz)	Reading (dBuV)	Correct (dB/m)	Result (dBuV/m)	Limit (dBuV/m)	Margin (dB)	Remark
1	18176.000	49.90	-5.51	44.39	74.00	-29.61	peak
2	19712.000	50.01	-5.29	44.72	74.00	-29.28	peak
3	20240.000	50.32	-5.61	44.71	74.00	-29.29	peak
4	22832.000	48.22	-3.60	44.62	74.00	-29.38	peak
5	24096.000	47.61	-2.78	44.83	74.00	-29.17	peak
6	25728.000	47.11	-0.72	46.39	74.00	-27.61	peak

8.6. SPURIOUS EMISSIONS(30 MHZ~1 GHZ)

Test Mode:	802.11b	Channel:	2412
Polarity:	Horizontal	Test Voltage:	DC 14.4 V

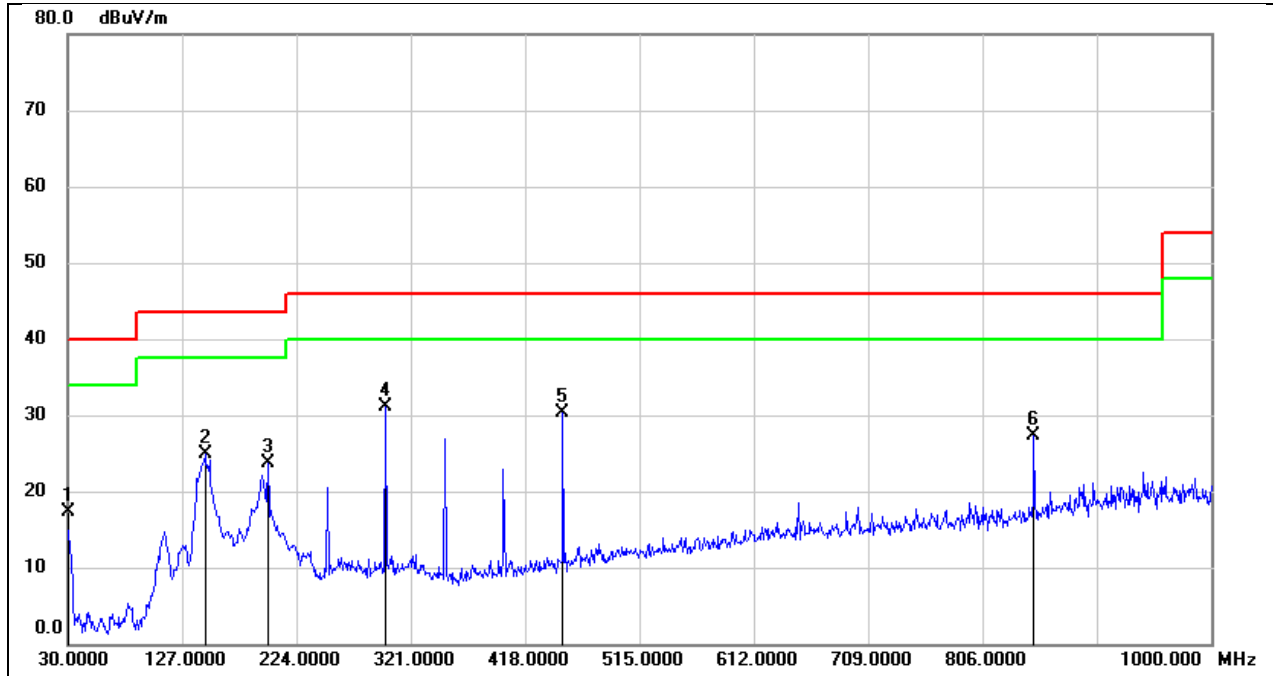

No.	Frequency (MHz)	Reading (dBuV)	Correct (dB/m)	Result (dBuV/m)	Limit (dBuV/m)	Margin (dB)	Remark
1	30.0000	36.27	-18.94	17.33	40.00	-22.67	QP
2	146.4000	43.44	-18.49	24.95	43.50	-18.55	QP
3	199.7500	40.14	-16.38	23.76	43.50	-19.74	QP
4	299.6600	46.44	-15.31	31.13	46.00	-14.87	QP
5	450.0100	42.75	-12.49	30.26	46.00	-15.74	QP
6	849.6500	33.63	-6.27	27.36	46.00	-18.64	QP



Test Mode:	802.11b	Channel:	2412
Polarity:	Vertical	Test Voltage:	DC 14.4 V

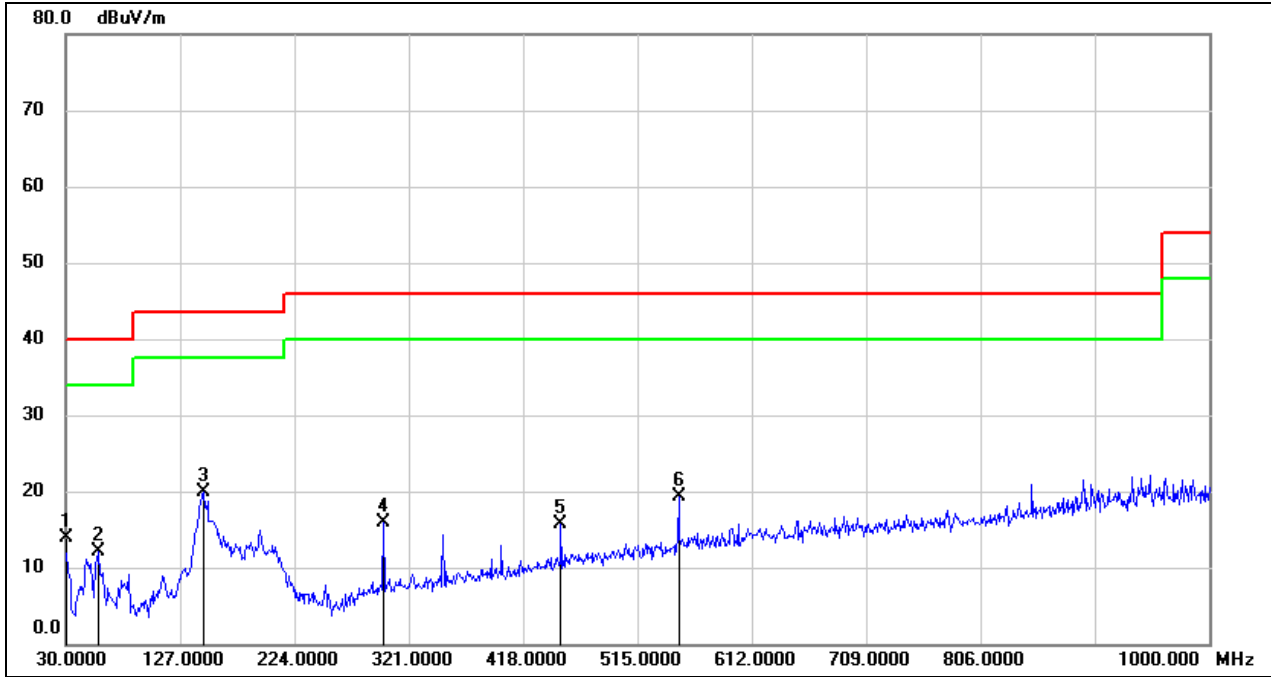

No.	Frequency (MHz)	Reading (dBuV)	Correct (dB/m)	Result (dBuV/m)	Limit (dBuV/m)	Margin (dB)	Remark
1	30.0000	32.89	-18.94	13.95	40.00	-26.05	QP
2	58.1300	32.61	-20.55	12.06	40.00	-27.94	QP
3	146.4000	38.40	-18.49	19.91	43.50	-23.59	QP
4	299.6600	31.13	-15.31	15.82	46.00	-30.18	QP
5	450.0100	28.22	-12.49	15.73	46.00	-30.27	QP
6	549.9200	29.74	-10.49	19.25	46.00	-26.75	QP



9. ANTENNA REQUIREMENT

REQUIREMENT

Please refer to FCC part 15.203

An intentional radiator shall be designed to ensure that no antenna other than that furnished by the responsible party shall be used with the device. The use of a permanently attached antenna or of an antenna that uses a unique coupling to the intentional radiator shall be considered sufficient to comply with the provisions of this section. The manufacturer may design the unit so that a broken antenna can be replaced by the user, but the use of a standard antenna jack or electrical connector is prohibited.

Please refer to FCC part 15.247(b)(4)

The conducted output power limit specified in paragraph (b) of this section is based on the use of antennas with directional gains that do not exceed 6 dBi. Except as shown in paragraph (c) of this section, if transmitting antennas of directional gain greater than 6 dBi are used, the conducted output power from the intentional radiator shall be reduced below the stated values in paragraphs (b)(1), (b)(2), and (b)(3) of this section, as appropriate, by the amount in dB that the directional gain of the antenna exceeds 6 dBi.

DESCRIPTION

Pass

10. AC POWER LINE CONDUCTED EMISSION

LIMITS

Please refer to CFR 47 FCC §15.207 (a) and ISED RSS-Gen Clause 8.8

FREQUENCY (MHz)	Quasi-peak	Average
0.15 -0.5	66 - 56 *	56 - 46 *
0.50 -5.0	56.00	46.00
5.0 -30.0	60.00	50.00

TEST SETUP AND PROCEDURE

Refer to ANSI C63.10-2013 clause 6.2.

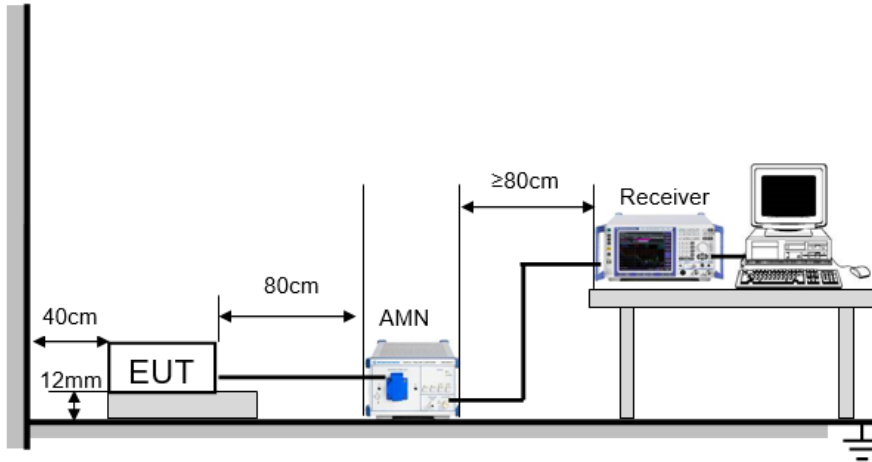

The EUT is put on a table of non-conducting material that is 12 mm high. The vertical conducting wall of shielding is located 40 cm to the rear of the EUT. The power line of the EUT is connected to the AC mains through a Artificial Mains Network (A.M.N.). A EMI Measurement Receiver (R&S Test Receiver ESR3) is used to test the emissions from both sides of AC line. According to the requirements in Section 6.2 of ANSI C63.10-2013. Conducted emissions from the EUT measured in the frequency range between 0.15 MHz and 30 MHz using CISPR Quasi-Peak and average detector mode. The bandwidth of EMI test receiver is set at 9 kHz.

The arrangement of the equipment is installed to meet the standards and operating in a manner, which tends to maximize its emission characteristics in a normal application.



TEST ENVIRONMENT

Temperature	23.5°C	Relative Humidity	58.2%
Atmosphere Pressure	101kPa	Test Voltage	AC 120 V, 60 Hz

TEST DATE / ENGINEER

Test Date	January 5, 2023	Test By	Wite Chen
-----------	-----------------	---------	-----------

TEST RESULTS

Test Mode:	802.11b	Channel:	2412
Line:	Line	Test Voltage:	AC 120 V, 60 Hz

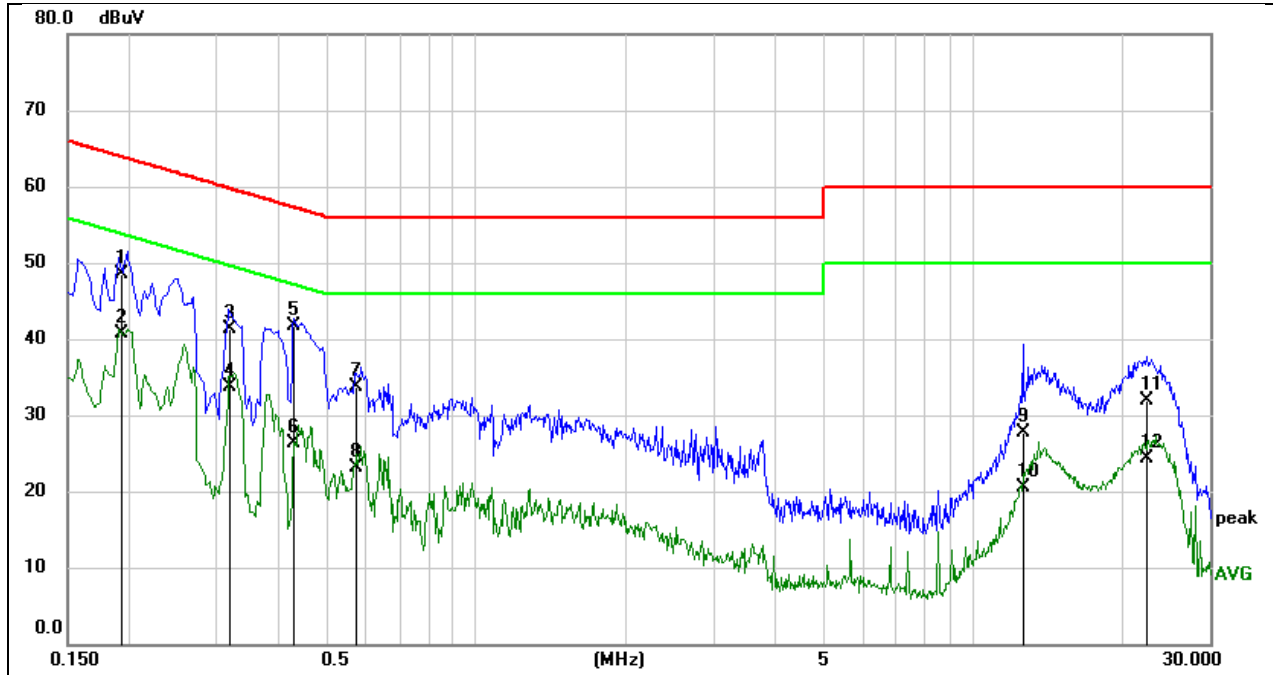

No.	Frequency (MHz)	Reading (dBuV)	Correct (dB)	Result (dBuV)	Limit (dBuV)	Margin (dB)	Remark
1	0.1939	39.00	9.59	48.59	63.87	-15.28	QP
2	0.1939	31.05	9.59	40.64	53.87	-13.23	AVG
3	0.3190	31.66	9.59	41.25	59.73	-18.48	QP
4	0.3190	24.15	9.59	33.74	49.73	-15.99	AVG
5	0.4286	32.08	9.60	41.68	57.28	-15.60	QP
6	0.4286	16.64	9.60	26.24	47.28	-21.04	AVG
7	0.5779	24.20	9.60	33.80	56.00	-22.20	QP
8	0.5779	13.58	9.60	23.18	46.00	-22.82	AVG
9	12.6737	17.90	9.76	27.66	60.00	-32.34	QP
10	12.6737	10.65	9.76	20.41	50.00	-29.59	AVG
11	22.5421	22.06	9.81	31.87	60.00	-28.13	QP
12	22.5421	14.59	9.81	24.40	50.00	-25.60	AVG

Note:

1. Result = Reading + Correct Factor.
2. If QP Result complies with AV limit, AV Result is deemed to comply with AV limit.
3. Test setup: RBW: 200 Hz (9 kHz ~ 150 kHz), 9 kHz (150 kHz ~ 30 MHz).
4. Step size: 80 Hz (0.009 MHz ~ 0.15 MHz), 4 kHz (0.15 MHz ~ 30 MHz), Scan time: auto.

Note: All the modes have been tested, only the worst data was recorded in the report.



Test Mode:	802.11b	Channel:	2412
Line:	Neutral	Test Voltage:	AC 120 V, 60 Hz

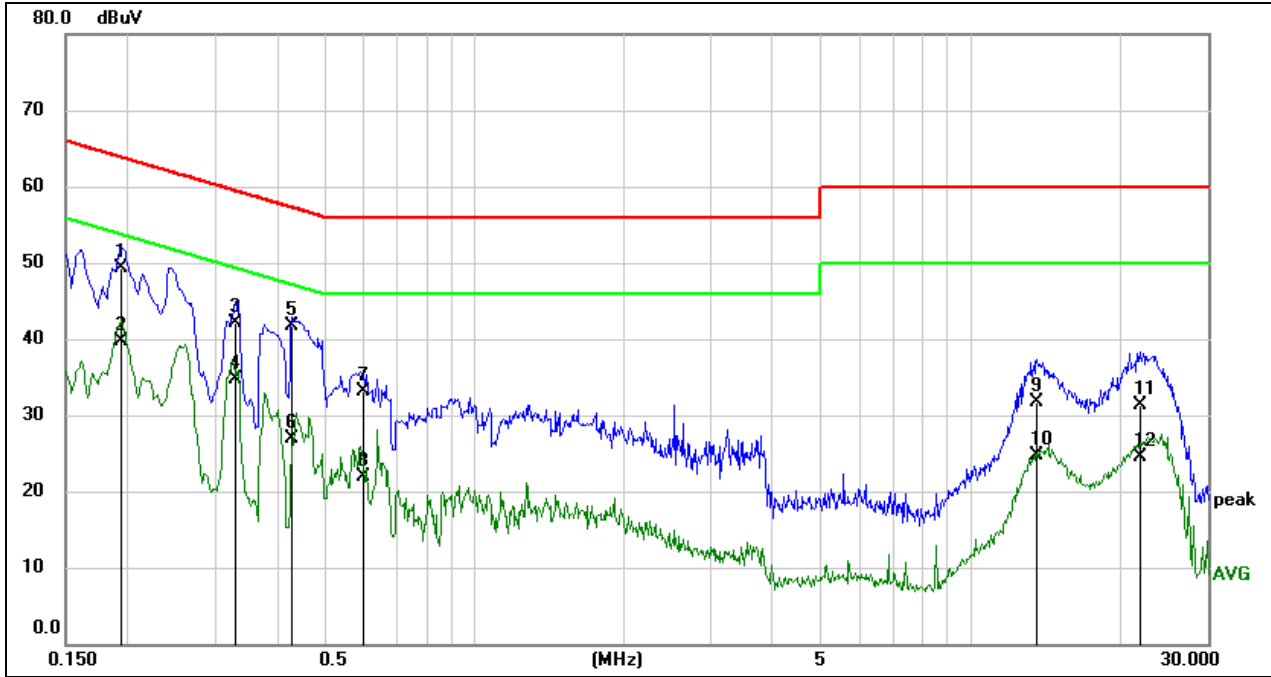

No.	Frequency (MHz)	Reading (dBuV)	Correct (dB)	Result (dBuV)	Limit (dBuV)	Margin (dB)	Remark
1	0.1928	39.64	9.59	49.23	63.92	-14.69	QP
2	0.1928	30.20	9.59	39.79	53.92	-14.13	AVG
3	0.3307	32.59	9.59	42.18	59.43	-17.25	QP
4	0.3307	25.03	9.59	34.62	49.43	-14.81	AVG
5	0.4300	32.19	9.60	41.79	57.25	-15.46	QP
6	0.4300	17.36	9.60	26.96	47.25	-20.29	AVG
7	0.5984	23.50	9.60	33.10	56.00	-22.90	QP
8	0.5984	12.33	9.60	21.93	46.00	-24.07	AVG
9	13.5599	21.85	9.76	31.61	60.00	-28.39	QP
10	13.5599	14.90	9.76	24.66	50.00	-25.34	AVG
11	21.9284	21.43	9.82	31.25	60.00	-28.75	QP
12	21.9284	14.69	9.82	24.51	50.00	-25.49	AVG

Note:

1. Result = Reading + Correct Factor.
2. If QP Result complies with AV limit, AV Result is deemed to comply with AV limit.
3. Test setup: RBW: 200 Hz (9 kHz ~ 150 kHz), 9 kHz (150 kHz ~ 30 MHz).
4. Step size: 80 Hz (0.009 MHz ~ 0.15 MHz), 4 kHz (0.15 MHz ~ 30 MHz), Scan time: auto.

Note: All the modes have been tested, only the worst data was recorded in the report.



11. TEST DATA

11.1. APPENDIX A: DTS BANDWIDTH

11.1.1. Test Result

Test Mode	Antenna	Channel	DTS BW [MHz]	FL[MHz]	FH[MHz]	Limit[MHz]	Verdict
11B	Ant1	2412	10.000	2407.040	2417.040	0.5	PASS
		2437	10.000	2432.040	2442.040	0.5	PASS
		2462	10.040	2457.000	2467.040	0.5	PASS
11G	Ant1	2412	16.320	2403.880	2420.200	0.5	PASS
		2437	16.360	2428.840	2445.200	0.5	PASS
		2462	16.320	2453.880	2470.200	0.5	PASS
11N20SISO	Ant1	2412	17.560	2403.240	2420.800	0.5	PASS
		2437	17.720	2428.160	2445.880	0.5	PASS
		2462	17.560	2453.240	2470.800	0.5	PASS
11N40SISO	Ant1	2422	35.680	2403.840	2439.520	0.5	PASS
		2437	35.040	2419.480	2454.520	0.5	PASS
		2452	35.600	2433.920	2469.520	0.5	PASS

11.1.2. Test Graphs





11G_Ant1_2412



11G_Ant1_2437



11G_Ant1_2462

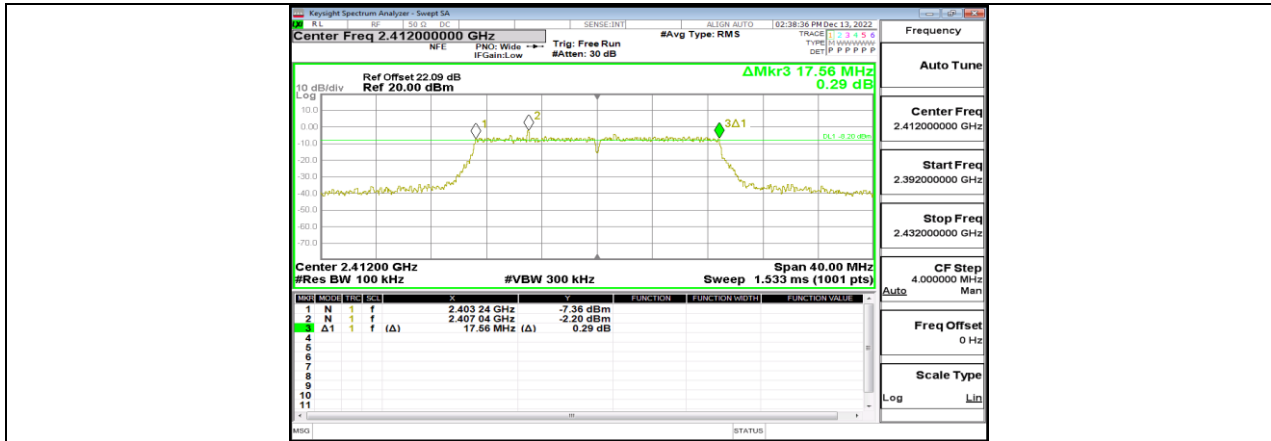

11N20SISO_Ant1_2412

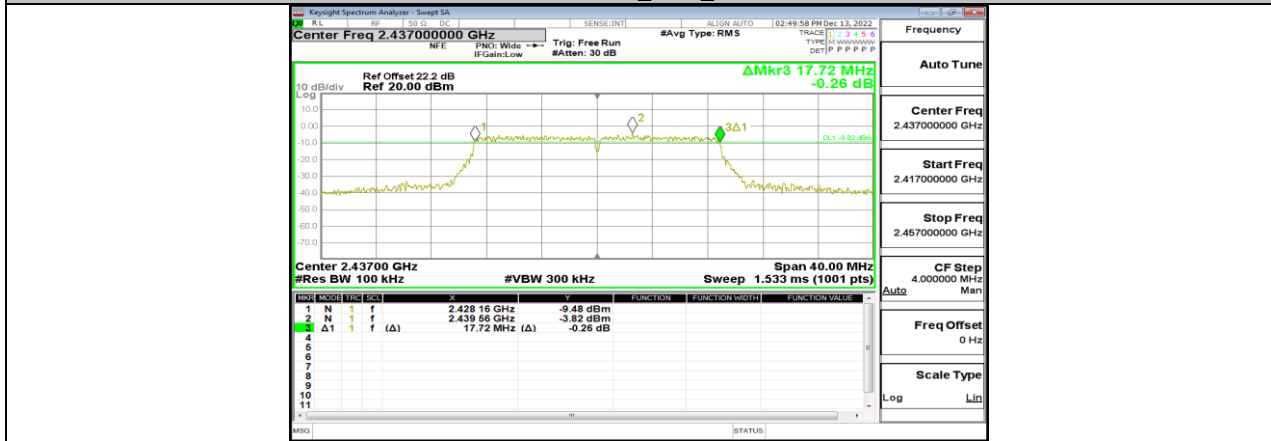

11N20SISO_Ant1_2437



11N20SISO_Ant1_2462

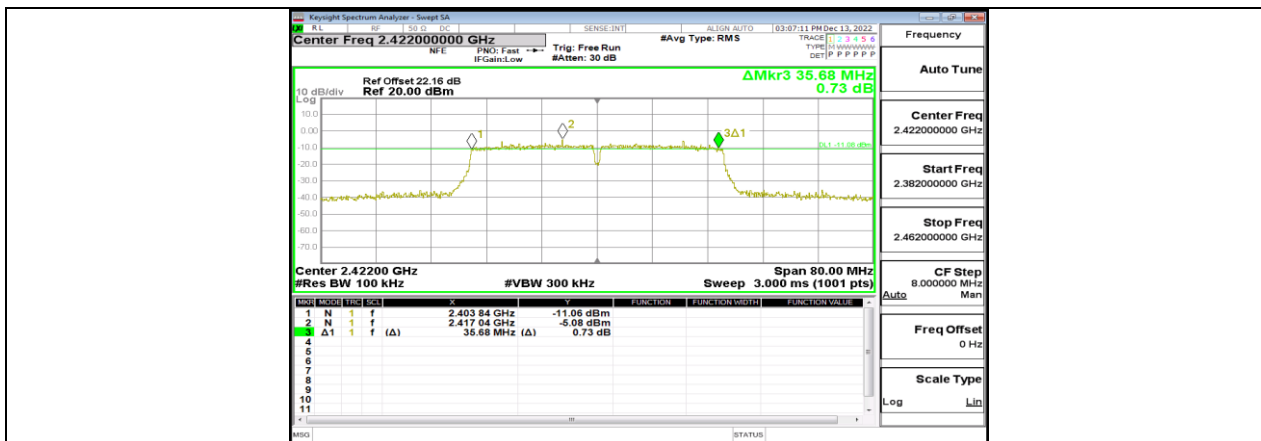

11N40SISO_Ant1_2422

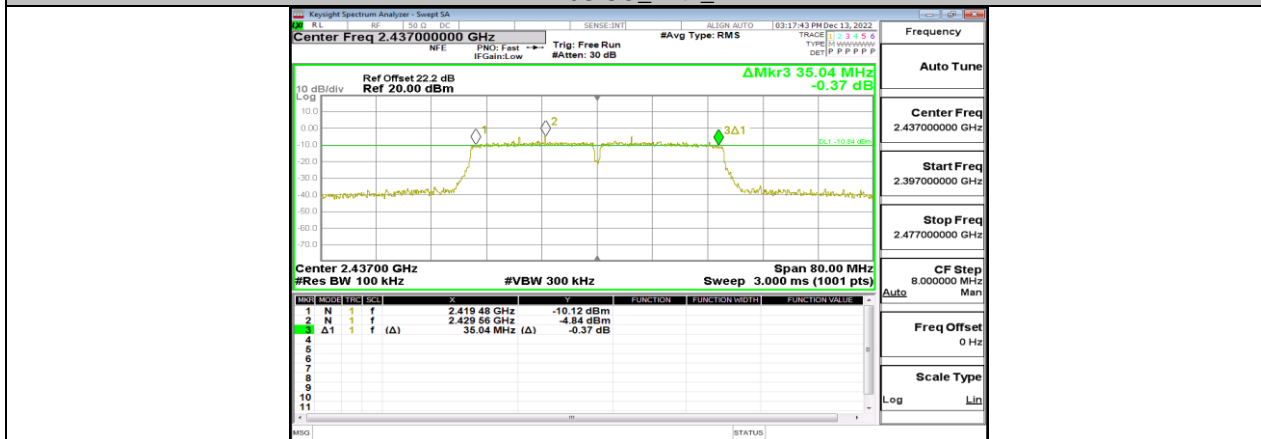

11N40SISO_Ant1_2437

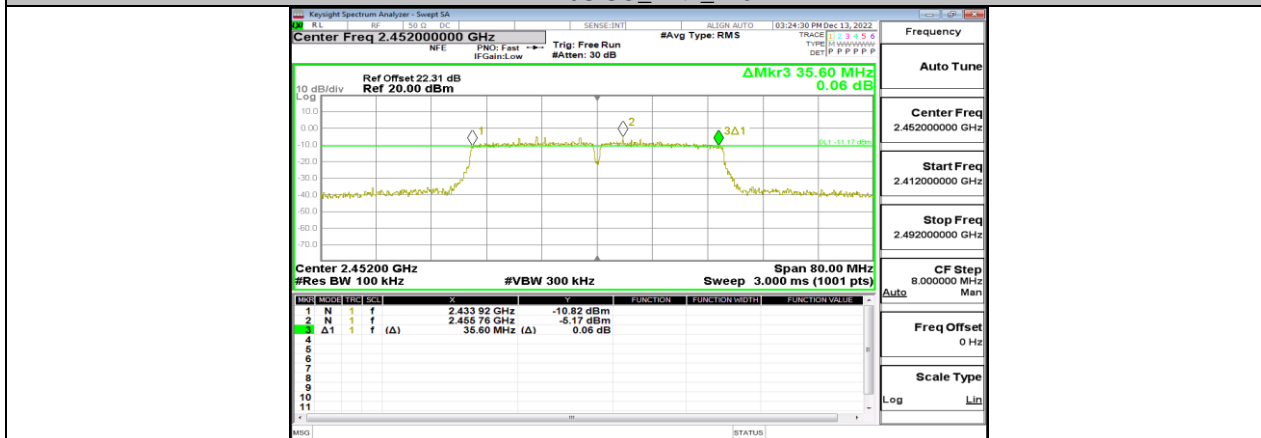

11N40SISO_Ant1_2452



11.2. APPENDIX B: OCCUPIED CHANNEL BANDWIDTH

11.2.1. Test Result

Test Mode	Antenna	Channel	OCB [MHz]	FL[MHz]	FH[MHz]	Verdict
11B	Ant1	2412	15.532	2404.2993	2419.8313	PASS
		2437	15.497	2429.2593	2444.7563	PASS
		2462	15.486	2454.2611	2469.7471	PASS
11G	Ant1	2412	17.323	2403.3425	2420.6655	PASS
		2437	17.451	2428.2789	2445.7299	PASS
		2462	17.302	2453.3971	2470.6991	PASS
11N20SISO	Ant1	2412	18.271	2402.9096	2421.1806	PASS
		2437	18.268	2427.8979	2446.1659	PASS
		2462	18.258	2452.9242	2471.1822	PASS
11N40SISO	Ant1	2422	36.429	2403.8695	2440.2985	PASS
		2437	36.510	2418.8021	2455.3121	PASS
		2452	36.563	2433.7337	2470.2967	PASS

11.2.2. Test Graphs



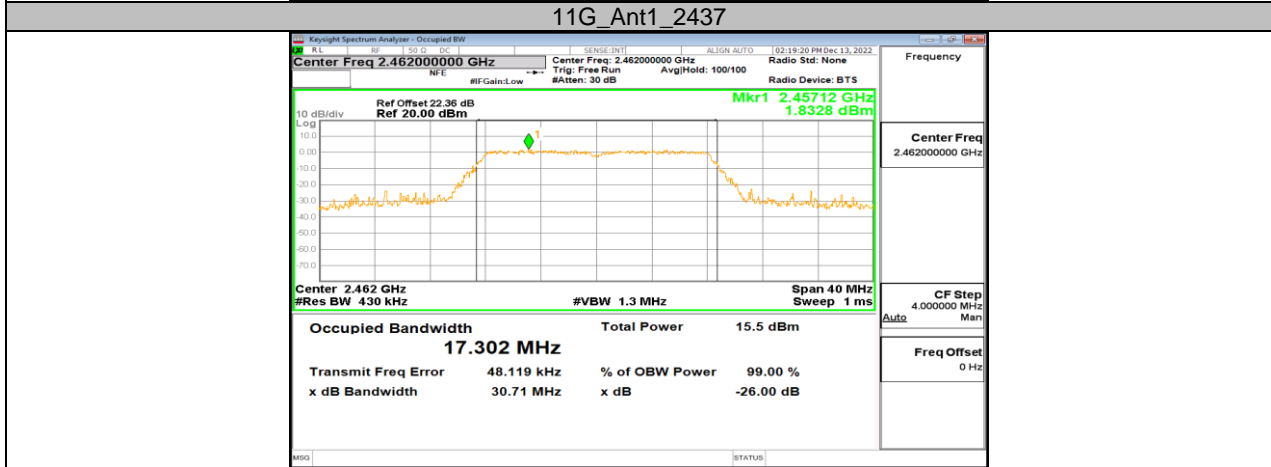
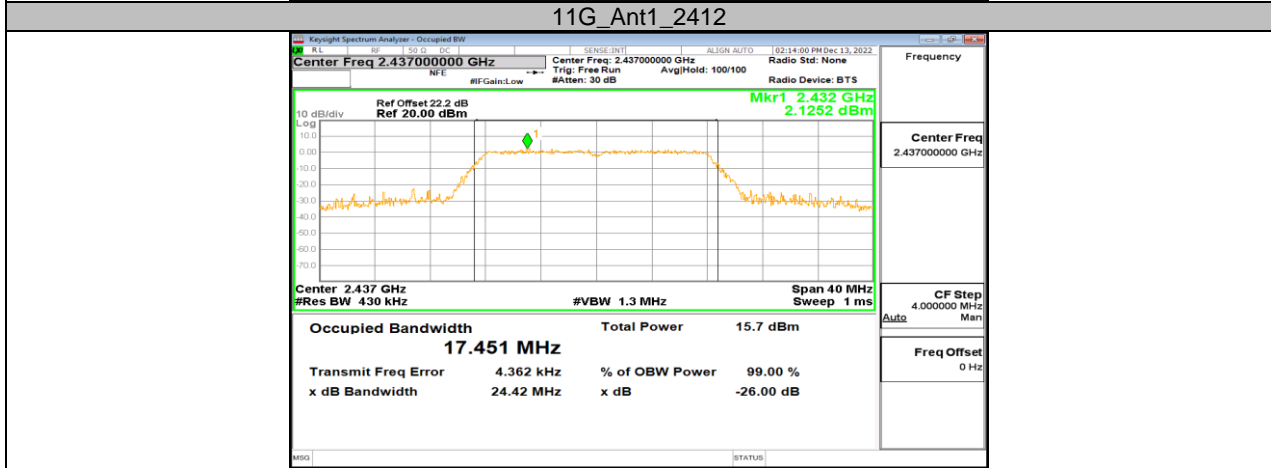
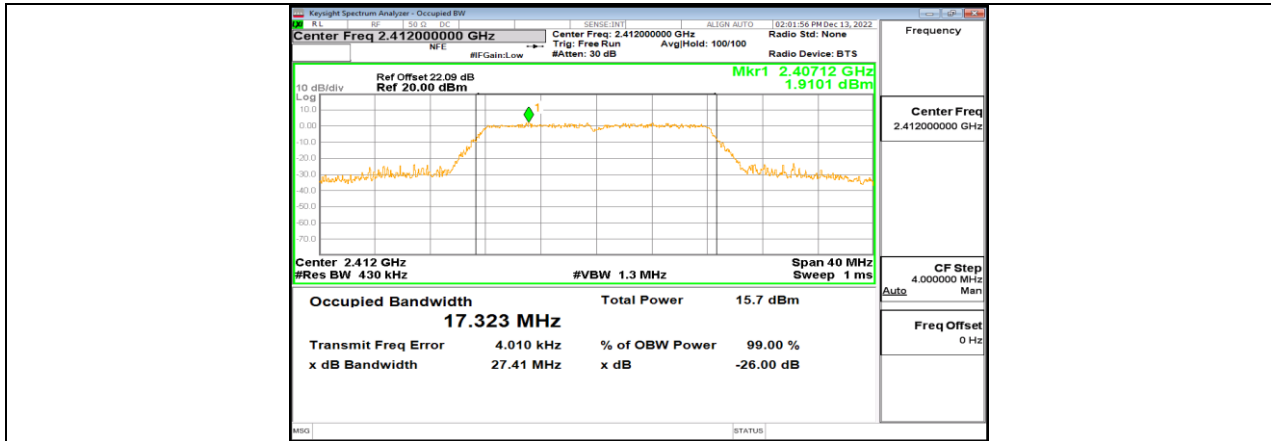

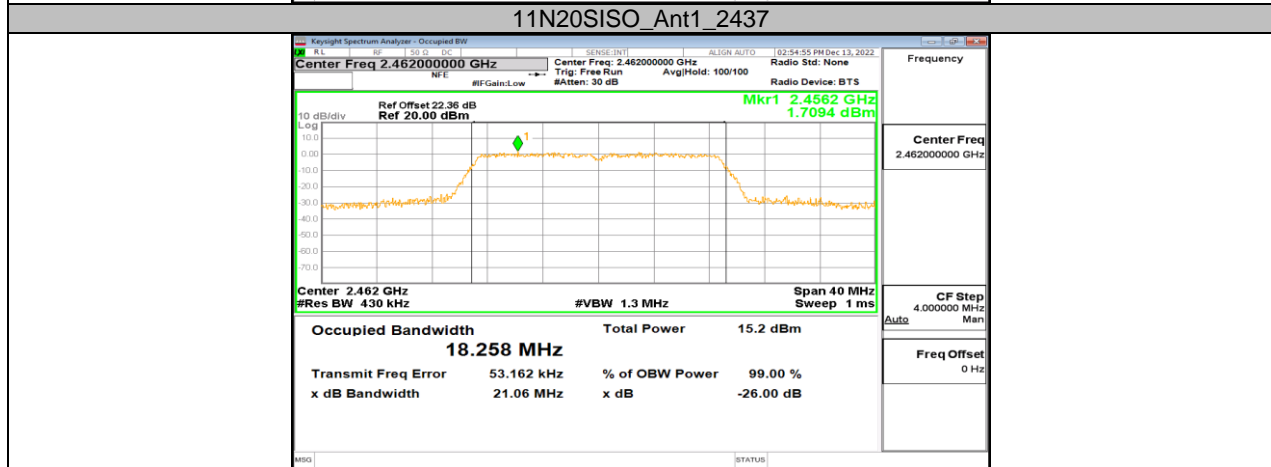
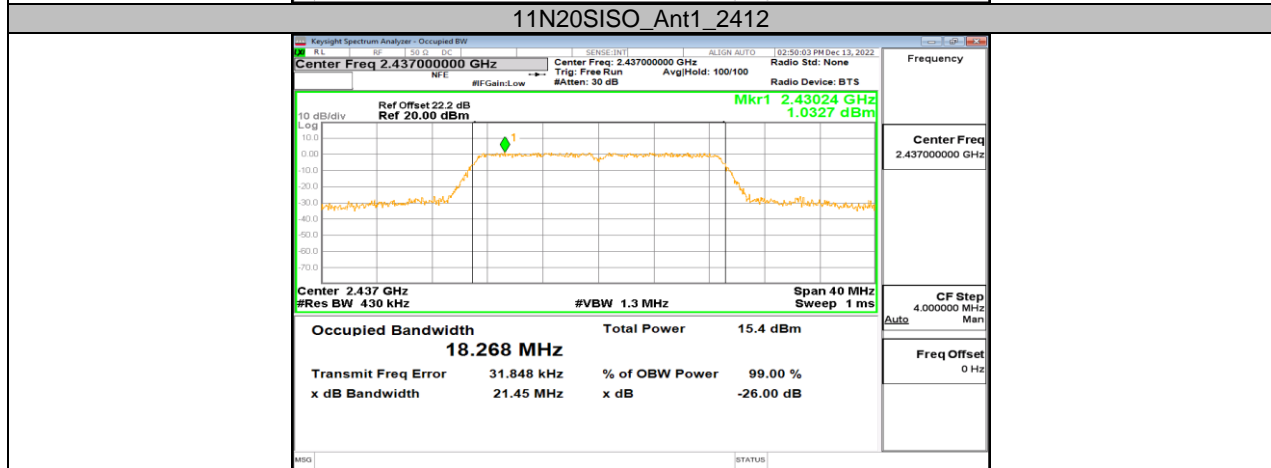
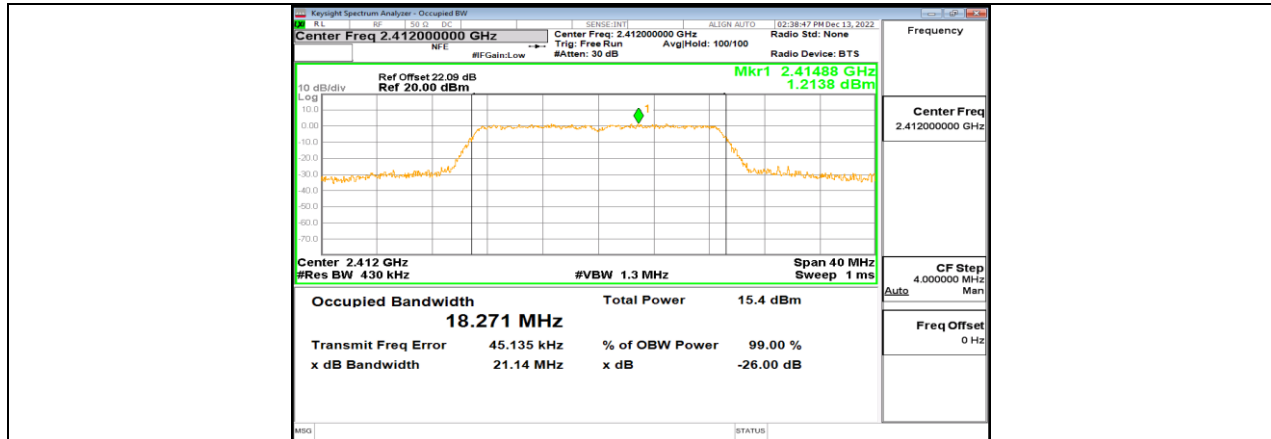

11N20SISO_Ant1_2462

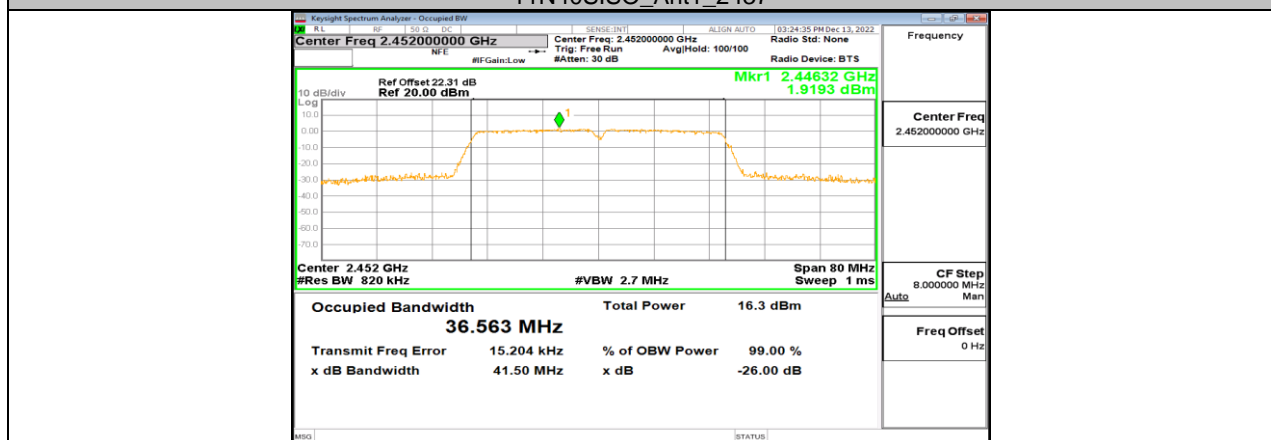
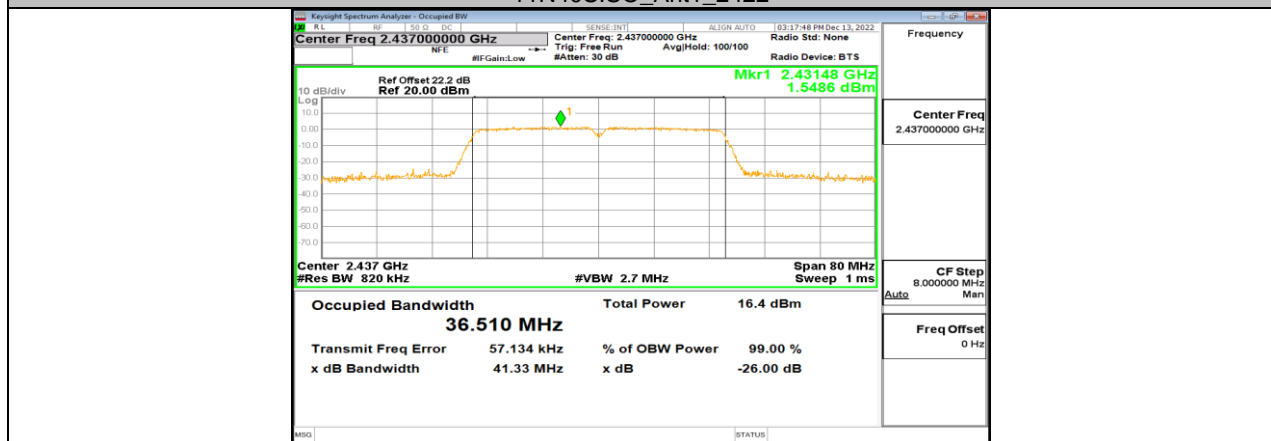
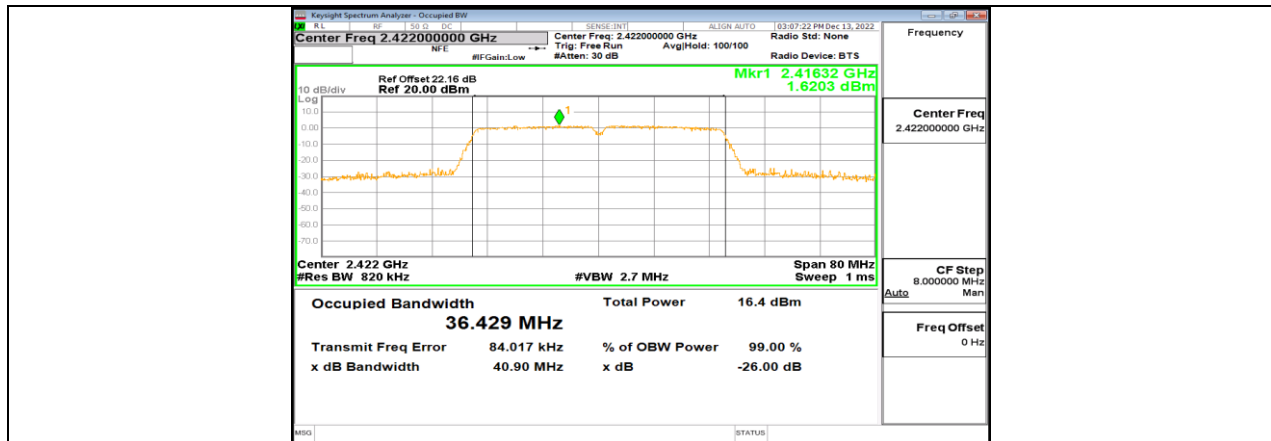



11.3. APPENDIX C: MAXIMUM CONDUCTED AVG OUTPUT POWER

11.3.1. Test Result

Test Mode	Antenna	Channel	Result[dBm]	Limit[dBm]	Verdict
11B	Ant1	2412	16.54	≤30.00	PASS
		2437	16.54	≤30.00	PASS
		2462	16.34	≤30.00	PASS
11G	Ant1	2412	9.67	≤30.00	PASS
		2437	9.76	≤30.00	PASS
		2462	9.58	≤30.00	PASS
11N20SISO	Ant1	2412	9.21	≤30.00	PASS
		2437	9.26	≤30.00	PASS
		2462	9.10	≤30.00	PASS
11N40SISO	Ant1	2422	9.55	≤30.00	PASS
		2437	9.55	≤30.00	PASS
		2452	9.50	≤30.00	PASS

Note: 1. Conducted Power=Meas. Level+ Correction Factor

2. The Duty Cycle Factor (refer to section 7.1) had already compensated to the test data.



11.4. APPENDIX D: MAXIMUM POWER SPECTRAL DENSITY

11.4.1. Test Result

Test Mode	Antenna	Channel	Result[dBm/3kHz]	Limit[dBm/3kHz]	Verdict
11B	Ant1	2412	-14.88	≤8.00	PASS
		2437	-15.11	≤8.00	PASS
		2462	-15.25	≤8.00	PASS
11G	Ant1	2412	-22.79	≤8.00	PASS
		2437	-22.85	≤8.00	PASS
		2462	-22.95	≤8.00	PASS
11N20SISO	Ant1	2412	-23.69	≤8.00	PASS
		2437	-24.03	≤8.00	PASS
		2462	-23.87	≤8.00	PASS
11N40SISO	Ant1	2422	-25.8	≤8.00	PASS
		2437	-25.7	≤8.00	PASS
		2452	-25.53	≤8.00	PASS

11.4.2. Test Graphs

