



**BOSCH**

Invented for life

# A complete kitchen for your everyday essentials.

Introducing the new generation  
of built-in appliances from Bosch.



 **BOSCH**



# Contents

**2** Introduction

## **Ovens**

**4** Features Unique to Bosch

**14** Buying Guide

**15** Range Information

## **Hobs**

**25** Electric Hobs

**26** Know your Hobs

**30** Features Unique to Bosch

**33** Range Information

**35** Gas Hobs

**36** Features Unique to Bosch

**37** Range Information

**41** Domino Hobs

**42** Range Information

## **Hoods**

**46** The Right Hood

**47** Recirculation VS Ducted Systems

**48** Features Unique to Bosch

**50** Range Information

# Bosch in every detail. German Engineered.

Every detail of every appliance has been carefully designed, produced and tested by our engineers to fully satisfy the highest standards in quality, performance and convenience. The result is cutting-edge technology, timeless design and remarkable ease of use, reducing the workload for you in the kitchen and consistently delivering perfect results.



# Why choose Bosch?

## Proven quality

Bosch appliances offer premium quality, advanced technology, ease of operation and outstanding German made and engineered technology. These attributes have earned us many national and international accolades, such as the reddot Design Award, the iF product design award and other endorsements, year after year.

## Top performance

What drives us every day is our desire to improve. We strive to make the best even better, by developing functional, durable and energy-efficient innovations that surpass all expectations.

## Maximum convenience

Bosch is dedicated to making your life easier. Our innovative built-in appliances are easy to use, while sophisticated features deliver the best results every time, saving you time and effort.



**reddot**  
International  
Design Award



**product  
design  
award**



The Intuitive Control Ring:  
Turn your dream dishes into  
reality, easily.

Cake



Small baked  
items



Biscuits



Cake  
Selected

Everything you need at hand: our new, intuitive control ring makes cooking easier than ever. With just a small turn of the stainless steel ring, you can adjust any of your oven's settings. The TFT-touch display, with its clear and straightforward design, guides you through the various menu options. This gives you full control over your dishes at all times and everything succeeds with ease.



e, bread  
ction



Bread &  
bread rolls

Savoury cakes,  
quiche

# Become a master chef, at the touch of a button.



## Bosch Assist

You could easily search through cookbooks and family recipes without ever finding the exact temperature or cooking time for that favourite dish. Thanks to Bosch Assist, you don't have to.

The advanced sensor technology found in PerfectRoast and PerfectBake™ – combined with the functionality of automatic programs as we know them today – offers an extensive menu of food categories that help create your perfect meal.



### PerfectBake™

#### No more guesswork needed while baking

Baking perfect bread and pastries typically involves careful setting of heating modes, temperatures baking times and constant monitoring. Baking enthusiasts can consider a Bosch oven with PerfectBake sensors that measure and regulate the baking process automatically.

Simply select Assist and the type of dish such as cake and press start, your oven will do the rest. The result: bread, cake and pastries baked to perfection.



### PerfectRoast

#### Get the perfect roast without monitoring closely

Whether it's poultry, meat or fish – with the PerfectRoast meat probe, you'll get perfect results every time. Through 3 highly sensitive measuring points, the probe determines the core temperature of your roast to the exact degree and second, guaranteeing perfect roasting results.

Simply insert the meat probe into your roast and select type of dish such as poultry and press start, your oven will do the rest. Another benefit: you can also use the meat probe in the microwave and steam oven mode.







# Steams so gently, even vitamins stay for dinner.

There is no healthier or tastier way to prepare food than in a Series 8 steamer or combination steam oven.

## Preserving vitamins and minerals

Dishes that are cooked in hot steam not only retain their vitamins and minerals, but also their full, natural flavour. So you can go easy on the extra seasoning, and use much less salt when cooking.

## No transfer of smell

With the Series 8 steamer, you can prepare an entire set menu using up to three levels at once. Salmon with asparagus and rosemary potatoes? Cook them all together and everything will turn out perfectly. Need to prepare dessert, too? Thanks to the moisture in the oven, there's no intermingling of flavours – each dish retains its own authentic flavour.



## Other steam functions



### Reheating

At 90 – 95°C, food is gradually reheated to taste as if it was freshly cooked.



### Added steam function

Enhance your cooking results by adding a little bit of moisture from time to time, thanks to the added steam function. Whether you're reheating dishes, proving dough, baking or roasting, you can set the oven to automatically add bursts of steam, or you can add steam manually to regulate the intensity. Added steam works with: 4D Hotair, Hot air grilling, Top and bottom heating and Keep warm feature.



### Drying Function

Drying option enables to dry the internal after steam usage.

## The versatility of all in 1 solution.

With the Bosch Series 8 combination oven(s), you can do various types of cooking such as baking, steaming or microwaving.

For a combination steam oven, it combines the benefits of pure steam cooking and functions of a conventional oven which give your roasts and home-made bread a crispy finish.









You can also add speed to your traditional cooking process without comprising on taste while using the combination microwave ovens.

Bosch Combination ovens provide convenience and help achieve improved food results.





# Perfect heating modes to meet your every cooking need.

Perfect baking and roasting not only requires the right temperature, but also the appropriate heating function, too. From 4D Hotair to Hotair Eco, Bosch ovens offer heating functions that deliver everything from haute cuisine to everyday feasts.

	What does it do?	Recommended for
 <b>4D Hotair<sup>^</sup></b>	<p>For baking and roasting on one or more levels.</p> <p>The fan distributes heat from the ring heating element in the back panel evenly around the cooking compartment. You can also bake and roast up to 4 different levels simultaneously.</p>	<p>Cakes and small baked items (Muffins, biscuits)</p> 
 <b>Hotair Eco</b>	<p>For energy-optimised cooking of selected dishes on one level without preheating.</p> <p>The fan distributes the energy-optimised heat from the ring heating element in the back wall evenly around the cooking compartment.</p>	<p>Cakes and small baked items (Muffins, biscuits)</p> 
 <b>Top and bottom heat Eco</b>	<p>This supports cooking on a single shelf for energy efficient cooking.</p>	<p>Cakes and bread</p> 
 <b>Intensive heat</b>	<p>Combines the top element with a more powerful bottom heating element that is perfect for crispy bases and baking in tins.</p>	<p>Tarts and savoury cakes</p> 

	What does it do?	Recommended for
 <b>Desiccation</b>	<p>For removing moisture from fruits, vegetables and herbs with maximum flavour retention.</p>	<p>Herbs, vegetables and fruits (Plums)</p> 

	What does it do?	Recommended for
 <b>Bottom heating</b>	For cooking in a bain-marie (slow cooking) and for the final baking stage. Suitable for bakes that require crispy base without the top drying.	Pizza and pies
 <b>Pizza setting</b>	For preparing pizza and dishes which require a lot of heat from underneath as well as providing moderate heat on the top of the dish.	Pizza and baguette



	What does it do?	Recommended for
 <b>Hot air grilling*</b>	For roasting. The grill element and fan switch on and off producing even and crisp roasting results.	Poultry, whole fish and larger pieces of meat
 <b>Full-width grill</b>	For grilling flat items.	Steak and sausage and making toast
 <b>Half-width grill</b>	For grilling small amounts of food where grilling a smaller surface area is required.	Small portion of steak, sausage and making toast
 <b>Slow Cooking</b>	For gentle and slow cooking of seared, tender pieces of meat in ovenware without a lid. The heat is emitted evenly from the top and bottom at low temperatures.	Poultry and other meats (Beef, pork, lamb)
 <b>Keeping warm*</b>	Keeps cooked food warm.	Any cooked food



	What does it do?
 <b>Rapid heating</b>	With rapid heating, you can shorten the heat-up time for selected heating functions, including 4D Hotair, Top and bottom heating and Intensive heat.

\* Possible to use added steam for this type of heating (operation only possible when the water tank is full). ^To cook on all four levels simultaneously, four wire racks are required for best results. For up to three levels, all accessories are suitable, ie. universal tray or baking tray. Features may vary depending on models. Please check individual product specifications.

# At last, someone in the house who enjoys cleaning up.

Anyone who has ever cleaned an oven by hand knows how exhausting and time-consuming it can be. However, this chore is a thing of the past, thanks to our EcoClean Direct cleaning aid and pyrolytic self-cleaning function. You won't waste a minute on cleaning, leaving you more time to enjoy cooking.



### Save time and energy with EcoClean Direct

While the oven bakes or roasts, the special direct coating of microfine ceramic particles on its interior walls absorbs grease and residue and breaks them down through oxidation. All you need to do is wipe the area without EcoClean Direct saving you time and energy.

The direct coating regenerates every time you heat the oven, and continues to do so for the entire service life of the appliance.



EcoClean Direct at sides of oven

Oil / Grease



The microfine ceramic lining

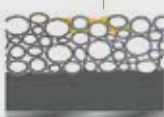

...soaks up the grease deposits

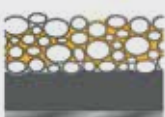

...breaks them down and...

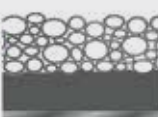

...regenerates when heated



### Remove stubborn stains effortlessly with Pyrolytic Cleaning

When you activate the pyrolytic cleaning function, the oven heats up to 465°C and burns off any burned-on grease and food residue. All that's left is a little ash that you can easily remove with a paper towel. And because the baking trays, racks and shelf rails are all pyrolytic-proof, you can leave them in the oven during cleaning.







Before



After Pyrolytic cleaning



# Ovens that suit your every need.

Types of Cooks		Suitable Oven Models			Key Oven Functions and Features
		60cm	45cm	38cm	
	<p>The Connoisseur: Cuisiniers on a Quest for Culinary Perfection</p>	HNG6764S1A			<ul style="list-style-type: none"> <li>• PerfectBake and PerfectRoast Sensor</li> <li>• Microwave</li> <li>• Added Steam</li> </ul>
	<p>The Health Junkie: Nourishing Your Inner Wellness Warrior</p>		CDG634BS1		<ul style="list-style-type: none"> <li>• Steamer</li> </ul>
			CSG656RS1		<ul style="list-style-type: none"> <li>• Steam Combination</li> <li>• PerfectBake and PerfectRoast Sensor</li> </ul>
	<p>The Avant-Garde: Innovation for the Progressive Experimentalis</p>	HBG656RS1B			<ul style="list-style-type: none"> <li>• PerfectBake and PerfectRoast Sensor</li> </ul>
		HSG636ES1			<ul style="list-style-type: none"> <li>• PerfectBake and PerfectRoast Sensor</li> <li>• Full Steam</li> </ul>
	<p>The Busy Gourmet: Food Preparation Made Quick and Fuss-Free</p>		CMG6633BS1B	BEL554MSOK	<ul style="list-style-type: none"> <li>• Microwave</li> </ul>
	<p>The DIY Chef: Autonomy for the Independent</p>	HBN331E1K			<ul style="list-style-type: none"> <li>• Conventional Oven</li> </ul>
		HBN331E4SG			
		HBA5780S0B			
		HBF114BR0K			
		HBG633BS1B			
		HBG635BB1J			
		HBG6753S1A			



### HBG633BS1B

60cm | Stainless Steel  
Built-in Single Oven

#### Performance

- 10 heating methods:
  - 4D Hotair
  - Hotair Eco
  - Top and bottom heat
  - Top and bottom heat Eco
  - Hot air grilling
  - Full-width grill
  - Half-width grill
  - Pizza setting
  - Bottom heat
  - Defrost
- Energy efficiency class: A+

#### Cleaning Functions

- EcoClean Direct: back panel

#### Features

- Cavity: 71L
- TFT color and text display with touch control buttons
- Rapid heating-up
- Temperature range: 30°C – 300°C
- Softmove: oven with soft closing & opening

#### Safety Functions

- Childproof lock
- Automatic switch off
- Maximum window temperature: 40°C
- 3 layered glass door
- Integral cooling fan
- Residual heat indicator

#### Technical Information

- Total connected load: 2.99kW
- Voltage: 220 – 230V
- Power frequency: 50 / 60Hz / 13A
- Cable length: 1.2m
- Appliance dimensions (H x W x D):  
595 x 595 x 548mm
- Min. cut out dimensions (H x W x D):  
585 x 560 x 550mm



### HBG635BB1J

60cm | Black Glass Design  
Built-in Single Oven

#### Performance

- 13 heating methods:
  - 4D Hotair
  - Hotair Eco
  - Top and bottom heat
  - Top and bottom heat Eco
  - Hot air grilling
  - Full-width grill
  - Half-width grill
  - Pizza setting
  - Bottom heat
  - Defrost
  - Slow cooking
  - Preheating
  - Keep warm
- Energy efficiency class: A+

#### Cleaning Functions

- EcoClean Direct: back panel

#### Features

- Cavity: 71L
- TFT color and text display with touch control buttons
- 10 automatic programs
- Rapid heating-up
- Temperature range: 30°C – 300°C
- Softmove: oven with soft closing & opening

#### Safety Functions

- Childproof lock
- Automatic switch off
- Maximum window temperature: 40°C
- 3 layered glass door
- Integral cooling fan
- Residual heat indicator

#### Technical Information

- Total connected load: 2.85kW
- Voltage: 220 – 230V
- Power frequency: 50 / 60Hz / 13A
- Cable length: 1.2m
- Appliance dimensions (H x W x D):  
595 x 595 x 548mm
- Min. cut out dimensions (H x W x D):  
585 x 560 x 550mm





**HBG6753S1A**  
60cm | Stainless Steel Built-in Single Oven

**Performance**

- 13 heating methods:
  - 4D Hotair
  - Hotair Eco
  - Top and bottom heat
  - Top and bottom heat Eco
  - Hot air grilling
  - Full-width grill
  - Half-width grill
  - Pizza setting
  - Bottom heat
  - Defrost
  - Slow cooking
  - Preheating
  - Keep warm
- Energy efficiency class: A

**Cleaning Functions**

- Pyrolytic self-cleaning function
- Pyrolytic proof tray holder and baking tray

**Features**

- Cavity: 71L
- TFT color and text display with touch control buttons
- 10 automatic programs
- Rapid heating-up
- Temperature range: 30°C – 300°C
- Softmove: oven with soft closing & opening

**Safety Functions**

- Childproof lock
- Door lock (when is off and during pyrolytic cleaning only)
- Automatic switch off
- Maximum window temperature: 30°C
- 4 layered glass door
- Integral cooling fan
- Residual heat indicator

**Technical Information**

- Total connected load: 3.60kW
- Voltage: 220 – 240V
- Power frequency: 50 / 60Hz / 16A
- Direct wiring
- Cable length: 1.2m
- Appliance dimensions (H x W x D): 595 x 595 x 548mm
- Min. cut out dimensions (H x W x D): 585 x 560 x 550mm



**HBG656RS1B**  
60cm | Stainless Steel Built-in Single Oven

**Performance**

- 13 heating methods:
  - 4D Hotair
  - Hotair Eco
  - Top and bottom heat
  - Top and bottom heat Eco
  - Hot air grilling
  - Full-width grill
  - Half-width grill
  - Pizza setting
  - Bottom heat
  - Defrost
  - Slow cooking
  - Preheating
  - Keep warm
- Energy efficiency class: A+

**Cleaning Functions**

- EcoClean Direct: top, side liners and back panels

**Features**

- Cavity: 71L
- Assist function (PerfectBake and PerfectRoast)
- TFT color and graphics display with direct touch function
- Rapid heating-up
- Temperature range: 30°C – 300°C
- Softmove: oven with soft closing & opening

**Safety Functions**

- Childproof lock
- Automatic switch off
- Maximum window temperature: 40°C
- 3 layered glass door
- Integral cooling fan
- Residual heat indicator

**Technical Information**

- Total connected load: 3.60kW
- Voltage: 220 – 240V
- Power frequency: 50 / 60Hz / 16A
- Direct wiring
- Cable length: 1.2m
- Appliance dimensions (H x W x D): 595 x 595 x 548mm
- Min. cut out dimensions (H x W x D): 585 x 560 x 550mm



### HSG636ES1

60cm | Stainless Steel  
Built-in Combination Steam Oven

#### Performance

- 12 heating methods:
  - 4D Hotair
  - Hotair Eco
  - Top and bottom heat
  - Top and bottom heat Eco
  - Hot air grilling
  - Full-width grill
  - Half-width grill
  - Pizza setting
  - Bottom heat
  - Slow cooking
  - Preheating
  - Keep warm
- Additional heating methods with steam: Steam 100%, Regeneration, Fermentation, Defrost
- Additional function: 10 mins drying
- Energy efficiency class: A+

#### Cleaning Functions

- EcoClean Direct: back panel

#### Features

- Cavity: 71L; Water tank capacity: 1L
- Assist function (PerfectBake and PerfectRoast)
- TFT color and graphics display with direct touch function
- Rapid heating-up
- Temperature range: 30°C – 250°C
- Softmove: oven with soft closing & opening

#### Safety Functions

- Childproof lock
- Automatic switch off
- Maximum window temperature: 40°C
- 3 layered glass door
- Integral cooling fan
- Residual heat indicator

#### Technical Information

- Total connected load: 3.65kW
- Voltage: 220 – 240V
- Power frequency: 50 / 60Hz / 16A
- Direct wiring
- Cable length: 1.2m
- Appliance dimensions (H x W x D): 595 x 595 x 548mm
- Min. cut out dimensions (H x W x D): 585 x 560 x 550mm



### HNG6764S1A

60cm | Stainless Steel Built-in Combination  
Microwave Oven with Added Steam

#### Performance

- 14 heating methods:
  - 4D Hotair
  - Hotair Eco
  - Top and bottom heat
  - Top and bottom heat Eco
  - Hot air grilling
  - Full-width grill
  - Half-width grill
  - Pizza setting
  - Bottom heat
  - Intensive heat
  - Slow cooking
  - Preheating
  - Keep warm
  - Desiccation
- Additional heating methods with steam: Regeneration, Fermentation
- Additional heating methods with microwave: Microwave, Combi microwave variable
- Additional function: 10 mins drying

#### Features

- Cavity: 71L; Water tank capacity: 1L
- Assist function (PerfectBake and PerfectRoast)
- TFT color and graphics display with direct touch function
- Rapid heating-up
- Temperature range: 30°C – 300°C
- Softmove: oven with soft closing & opening

#### Cleaning Functions

- Pyrolytic self-cleaning function
- Pyrolytic proof tray holder and baking tray

#### Safety Functions

- Childproof lock
- Door lock (when is off and during pyrolytic cleaning only)
- Automatic switch off
- Maximum window temperature: 30°C
- 4 layered glass door
- Integral cooling fan
- Residual heat indicator

#### Technical Information

- Total connected load: 3.60kW
- Voltage: 220 – 240V
- Power frequency: 50 / 60Hz / 16A
- Direct wiring
- Cable length: 1.2m
- Appliance dimensions (H x W x D): 595 x 595 x 548mm
- Min. cut out dimensions (H x W x D): 585 x 560 x 550mm



### CDG634BS1

45cm | Stainless Steel  
Built-in Steamer

#### Performance

- 4 heating methods:
  - Steam 100%
  - Regeneration
  - Fermentation
  - Defrost
- Additional function: 10 mins drying

#### Features

- Cavity: 38L; Water tank capacity: 1.3L
- 20 automatic programs
- TFT color and text display with touch control buttons
- Temperature range: 30°C – 100°C
- Softmove: oven with soft closing & opening

#### Safety Functions

- Childproof lock
- Automatic switch off
- Maximum window temperature: 40°C
- 3 layered glass door
- Integral cooling fan

#### Technical Information

- Total connected load: 1.9kW
- Voltage: 220 – 240V
- Power frequency: 50 / 60Hz / 10A
- Cable length: 1.2m
- Appliance dimensions (H x W x D): 455 x 595 x 548mm
- Min. cut out dimensions (H x W x D): 450 x 560 x 550mm



### CMG633BS1B

45cm | Stainless steel Built in Oven with  
Microwave function

#### Performance

- 6 heating methods:
  - 4D hot air
  - Hot Air-Eco
  - Hot air grilling
  - Full width grill
  - Half width grill
  - Preheating
- Additional heating methods with microwave: Microwave, Combi microwave constant

#### Cleaning Functions

- Easy clean

#### Features

- Cavity: 45L;
- 5 Microwave power settings (90W, 180W, 360W, 600W, 900W) with Inverter (MW)
- TFT color and graphics display with direct touch function
- Rapid heating-up
- Softmove: oven with soft closing & opening

#### Safety Functions

- Childproof lock
- Automatic switch off
- Maximum window temperature: 40°C
- 3 layered glass door
- Integral cooling fan
- Residual heat indicator

#### Technical Information

- Total connected load: 3.6kW
- Voltage: 220 – 240V
- Power frequency: 50 / 60Hz / 16A
- Direct wiring
- Cable length: 1.5m
- Appliance dimensions (H x W x D): 455 x 595 x 548mm
- Min. cut out dimensions (H x W x D): 450-455 x 560-568 x 550mm



### CSG656RS1

45cm | Stainless Steel  
Built-in Combination Steam Oven

#### Performance

- 14 heating methods:
  - 4D Hotair
  - Hotair Eco
  - Top and bottom heat
  - Top and bottom heat Eco
  - Hot air grilling
  - Full-width grill
  - Half-width grill
  - Pizza setting
  - Bottom heat
  - Intensive heat
  - Slow cooking
  - Preheating
  - Desiccation
  - Keep warm
- Additional heating methods with steam: Steam 100%, Regeneration, Fermentation, Defrost
- Additional function: 10 mins drying
- Energy efficiency class: A+

#### Cleaning Functions

- EcoClean Direct: top, side liners and back panel

#### Features

- Cavity: 47L; Water tank capacity: 1L
- Assist function (PerfectBake and PerfectRoast)
- TFT color and graphics display with direct touch function
- Rapid heating-up
- Temperature range: 30°C – 250°C
- Softmove: oven with soft closing & opening

#### Safety Functions

- Childproof lock
- Automatic switch off
- Maximum window temperature: 40°C
- 3 layered glass door
- Integral cooling fan
- Residual heat indicator

#### Technical Information

- Total connected load: 3.3kW
- Voltage: 220 – 240V
- Power frequency: 50 / 60Hz / 16A
- Direct wiring
- Cable length: 1.2m
- Appliance dimensions (H x W x D): 455 x 595 x 548mm
- Min. cut out dimensions (H x W x D): 450 x 560 x 550mm



### BIC630NS1B

14cm | Stainless Steel  
Warming Drawer

#### Performance

- Stepless temperature control for 40°C – 80°C
- Maximum loading espresso cups: 64 pieces
- Maximum loading plates: 12 pieces

#### Features

- Cavity: 20L
- Dough proving
- Thawing foods
- Keeping drinks and food warm
- Pre-heating utensils

#### Safety Functions

- Loading up to 25kg
- Telescopic pull-out drawer
- Cool door
- Operating indicator light

#### Technical Information

- Total connected load: 0.81kW
- Voltage: 220 – 240V
- Power frequency: 50 / 60Hz / 10A
- Cable length: 1.5m
- Appliance dimensions (H x W x D): 140 x 595 x 548mm
- Min. cut out dimensions (H x W x D): 140 x 560 x 550mm



## CTL636ES1

45cm | Stainless Steel Fully Automatic Espresso Maker / Fully Automatic Coffee Machine

### Beverages

- One-touch preparation: Ristretto, Espresso, Espresso Macchiato, Coffee, Cappuccino, Latte Macchiato, Caffè Latte
- MyCoffee feature: Save 8 favourite beverages with individual names and adjustable mixing ratio of milk and espresso
- Coffee outlet and milk frother height-adjustable: Up to 15 cm high Latte Macchiato glasses fit underneath
- IndividualCup Volume: Cup sizes adjustable individually
- OneTouch DoubleCup: Prepare two cups simultaneously for all coffee and milk specialties

### Features

- Water tank capacity: 2.4L
- Unique SensoFlow heating System guarantees highest espresso indulgence with every cup with its ideal, constant brewing temperature
- AromaDouble Shot prepares extra-strong coffee with less bitterness and full aroma
- CoffeeSensor Pro: The grinding unit automatically adjusts to bean variety
- One touch function for drinks with milk

### Convenience

- Intuitive control ring
- TFT display with interactive menu
- Early warning if water tank or bean container is almost empty
- Flexible milk solution: connects the provided milk container or using any other container, e.g. a milk carton

### Hygiene

- Removable brewing unit: Easy and hygienic cleaning under running water
- AutoMilk Clean: Fully-automatic steam cleaning of the milk system after every beverage
- Milk frother removable and dishwasher-proof
- SinglePortion Cleaning: Complete emptying of all pipes after each brewing process
- Automatic rinsing program when switching off, switching on
- Removable and dishwasher proof drip tray and coffee grounds container
- Automatic cleaning and descaling programme
- Reminds in time of water filter change, descaling, cleaning; including display of remaining cups

### Additional Features

- Concealed accessories storage
- Bean container with aroma protection lid (500g volume)
- Illuminated coffee outlet
- Grinding fineness adjustable (multi-level)
- Childproof lock

### Technical Information

- Connection Rating: 1.6kW
- Voltage: 220 – 240V
- Power frequency: 50 / 60Hz / 13A
- Cable length: 1.7m
- Appliance dimensions (H x W x D):  
455 x 594 x 375mm
- Min. cut out dimensions (H x W x D):  
449 x 558 x 356mm



### BEL554MS0K

38cm | Stainless Steel  
Built-in Microwave Oven with Grill

#### Performance

- 3 cooking methods:
  - Microwave
  - Grill
  - Combined operation
- 8 auto programs
- 1 memory function

#### Features

- Cavity: 25L
- 900W Microwave
- 5 settings: 90W, 180W, 360W, 600W, 900W
- Automatic switch off
- Door contact switch

#### Technical Information

- Total connected load: 1.45kW
- Voltage: 230 – 240V
- Power frequency: 50Hz / 10A
- Cable length: 1.5m
- Appliance dimensions (H x W x D):  
382 x 594 x 388mm
- Min. cut out dimensions (H x W x D):  
380–382 x 560–568 x 550mm



### HBN331E1K

60cm | Stainless Steel  
Built-in Single Oven

#### Performance

- 5 heating methods:
  - 3D Hotair
  - Bottom heat
  - Hotair grilling
  - Full-width variable grill
  - Top and bottom heat
- Energy efficiency class: A

#### Features

- Cavity: 66L
- Rapid heating-up: manual

#### Safety Functions

- Childproof lock
- Maximum window temperature: 50°C
- Integral cooling fan
- 3 layered glass door

#### Technical Information

- Total connected load: 2.9kW
- Voltage: 220 – 240V
- Power frequency: 50 / 60Hz / 13A
- Cable length: 2.0m
- Appliance dimensions (H x W x D):  
595 x 595 x 548mm
- Min. cut out dimensions (H x W x D):  
575 x 560 x 550mm

#### Accessories

- 1 x enamel baking tray
- 1 x combination grid
- 1 x universal pan



### HBN331E4SG

60cm | Stainless Steel  
Built-in Single Oven

#### Performance

- 5 heating methods:
  - 3D Hotair
  - Hotair grilling
  - Full-width variable grill
  - Bottom heat
  - Top and bottom heat
- Energy efficiency class: A

#### Features

- Cavity: 66L
- Rapid heating-up: manual

#### Safety Functions

- Childproof lock
- Maximum window temperature: 50°C
- 3 layered glass door
- Integral cooling fan

#### Technical Information

- Total connected load: 2.9kW
- Voltage: 220 – 240V
- Power frequency: 50 / 60Hz / 13A
- Cable length: 2.0m
- Appliance dimensions (H x W x D):  
595 x 595 x 548mm
- Min. cut out dimensions (H x W x D):  
575 x 560 x 550mm

#### Accessories

- 1 x combination grid
- 1 x universal pan



### HBF114BROK

60cm | Stainless Steel  
Built-in Single Oven

#### Performance

- 7 heating methods:
  - 3D Hotair
  - Top and bottom Heat
  - Bottom Heat
  - Gentle Hot Air
  - Full Width Variable Grill
  - Hot Air Grilling
  - Pizza Setting
- Energy efficiency class: A

#### Cleaning Functions

- GranitEnamel – easy to clean interior

#### Features

- Cavity: 66L
- Rapid Heating Up

#### Safety Functions

- Childproof Lock
- Maximum Window Temperature: 50 °C
- 3 Layered Glass Door
- Integral cooling fan

#### Technical Information

- Total Connected load: 2.95kW
- Voltage: 220-240W
- Power Frequency: 50 / 60Hz/ 13A
- Cable Length: 2.0m
- Appliance Dimensions ( H x W x D):  
595 x 594 x 548 mm
- Min. cut out dimensions ( H x W X D):  
575-597 x 560-568 x 550mm

#### Accessories

- 1 x combination grid
- 1 x universal pan



## HBA5780S0B

60cm | Stainless Steel  
Built-in Single Oven

### Performance

- 10 heating methods:
  - 3D Hot Air
  - Conventional Heat
  - Bottom Heat
  - Hot Air Gentle
  - Low Temperature Cooking
  - Full Width Grill
  - Hot Air Grilling
  - Pizza Setting
  - Defrost
  - Keep Warm

- Energy efficiency class: A

### Cleaning Functions

- Pyrolytic Self Cleaning Function

### Features

- Cavity: 71L
- Rapid Heating Up
- AutoPilot 30

### Safety Functions







- Childproof Lock
- Maximum Window Temperature: 30 °C
- 4 Layered Glass Door
- Integral Cooling Fan

### Technical Information

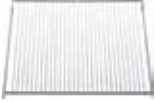
- Total Connected load: 2.99kW
- Voltage: 220-240W
- Power Frequency: 50 / 60Hz/ 13A
- Direct Wiring
- Cable Length: 1.2m
- Appliance Dimensions ( H x W x D):  
595 x 594 x 548 mm
- Min. cut out dimensions ( H x W x D):  
585 x 560 x 550 mm

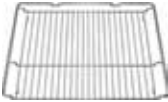

# Accessories

Description		
	<b>HEZ324000</b>	<p><b>Inlaid wire shelf for universal pan</b> Wire shelf fits into universal pan for grilling applications. Universal pan and wire shelf can be removed together.</p> <p>Suits all Bosch ovens except CDG634BS1.</p>
	<b>HEZ327000</b>	<p><b>Baking stone</b> Ceramic baking stone and wooden paddle. Ideal when baking bread, unleavened bread, pizza and frozen food dishes. Pyrolysis compatible with pyrolytic ovens.</p> <p>Suits all Bosch ovens except CDG634BS1.</p>
	<b>HEZ631070</b>	<p><b>Baking tray</b> Enamelled baking tray for cakes, biscuits, rolls and bread. Easy to clean. Pyrolysis compatible with pyrolytic ovens.</p> <p>Suits all Bosch ovens except CDG634BS1.</p>
	<b>HEZ633070</b>	<p><b>Professional pan, enamelled</b> Extra deep, large enamelled pan with wire shelf insert. Best suitable for large roasts and ideal for automatic programmes when used with the fitting lid. Pyrolysis compatible with pyrolytic ovens.</p> <p>Suits all Bosch ovens except CDG634BS1.</p>
	<b>HEZ634000</b>	<p><b>Baking and roasting grid (standard)</b> Wire rack to accommodate all dishes in forms like baking tins, ceramic and glass roasting dishes.</p> <p>Suits all Bosch ovens except HSG636ES1, HMG656RS1, HNG6764S1A, CDG634BS1, CSG656RS1, CNG6764S1B.</p>
	<b>HEZ36D663G*</b>	<p><b>Steam container, punched, size XL</b> For steaming vegetables, fish and meat. For larger amount of food.</p> <p>Suits all Bosch Ovens except for HBG633BS1J, HBG635BB1J, HBG635BW1J, HBG6753S1A, HBG656RS1B, HMG656RS1, HNG6764S1A, CDG634BS1, CNG6764S1B.</p>
	<b>HEZ632070*</b>	<p><b>Multipurpose pan, enamelled</b> Deep enamelled pan for juicy fruit cakes, pizza, large roasts, casseroles and bakes. Can be used to hold any residual fat during grilling. Easy to clean.</p> <p>Suits all Bosch Ovens except for CDG634BS1.</p>
	<b>HEZ864000*</b>	<p><b>Glass tray</b> Special glass dish for roasting and bakes. Easy to clean and hygienic.</p> <p>Suits all Bosch Ovens except for HBG635BB1J, HBG635BW1J, HMG656RS1, HNG6764S1A, CNG6764S1B.</p>
	<b>HEZ638200*</b>	<p><b>2 level telescopic shelf rails</b> Replacement for shelf support with two telescopic rails on two levels, fully extendable.</p> <p>Suits all Bosch Ovens except for HBG6753S1A, HBG656RS1B, HSG636ES1, HMG656RS1, HNG6764S1A, CDG634BS1, CSG656RS1, CNG6764S1B.</p>
	<b>HEZ638300*</b>	<p><b>3 level telescopic shelf rails</b> Replacement for shelf support with three telescopic rails on three levels, fully extendable.</p> <p>Suits all Bosch Ovens except for HBG6753S1A, HBG656RS1B, HSG636ES1, HMG656RS1, HNG6764S1A, CDG634BS1, CSG656RS1, CNG6764S1B.</p>

\* Accessories order will be on indent basis.

## The world of Bosch electric hobs.

There is a wide range of induction and radiant hobs to choose from. As you would expect from Bosch, all are made using high-quality materials, are easy to use and add versatility, style and elegance to any kitchen.



# Know your hobs.

3 main types of hobs to choose from based on heating methods.

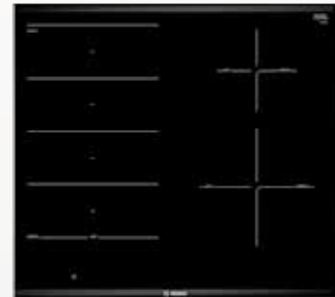

	Gas Hobs	Radiant Hobs	Induction Hobs
Cooks by	Direct flame	A heating element under ceramic glass	Heat is generated in the cooking vessel directly through induction
Ease of cleaning	✓	✓✓	✓✓✓
Intelligent features	✓	✓✓✓	✓✓✓
Safety features	✓	✓✓	✓✓✓
Best for	Wok-hei taste / General cooking	General cooking	Fast cooking with superior control and energy efficiency

# Why induction?

Bring 2 litres of water to a boil in just 4.7 minutes. Our PowerBoost function can increase the power output to a selected cooking zone by approximately 50%. Saving you precious time.



## Why is it so fast, so easy to clean and safe?

Induction Hobs are easier to clean than traditional hobs, because the ceramic glass doesn't get as hot. Any spillages can be quickly and easily wiped away.

With an Induction Hob, micro-currents are generated in the bottom of the pot. Consequently, heat is only created when the pan is connected to the hob – heating will stop as soon as it's removed, which means it's far safer than cooking with traditional hobs.

## DID YOU KNOW



Time (in minutes) for heating 2 litres of water from 15°C to 90°C



Radiant

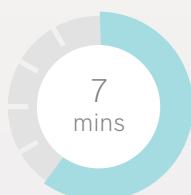

Gas



Induction

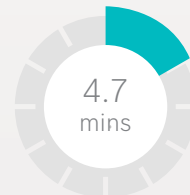

Induction with PowerBoost



# Multiple heating zones. 17 cooking levels. Endless possibilities.

Bosch FlexInduction is the result of decades of research and development. At last, practical, hi-tech appliances that escape the confines of traditional cooktops. Here is freedom in the kitchen.

## What is FlexInduction?

Ideal for small pots, large pots, multiple pans, frying pans or cassarole dishes, the system allows you to control pots and pans separately, offering increased flexibility.



## Combi Induction hobs

Consists of FlexInduction Zone and standard induction zones.

Our Combi Induction hobs feature one large rectangular cooking zone, ideal for any cooking needs. A flick of a switch, 2 induction zones become one large induction surface. You can also consider converting the FlexInduction zone to a Teppanyaki cooking area by adding a Teppanyaki plate.



## Additional feature for Combi Induction hobs – MoveMode\*

When your recipe requires you to switch from boil to simmer at just the right moment, MoveMode is there when you need it.

Switch from level 9 to level 1 by simply sliding your pot. MoveMode lets you move seamlessly from your first high-powered cooking task to the next, without a hiccup, and always in control.

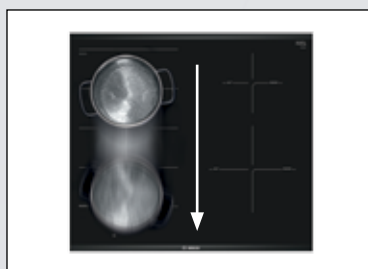

\*Applicable to selected models.  
Default setting is based on factory setting.

# Set to the perfect level. Cooked to the perfect consistency.

The right temperature is crucial for successful frying. The new PerfectFry sensor automatically monitors the frying temperature and adjusts it as required to ensure perfectly-fried dishes. Say goodbye to burnt food and hello to perfection.



Perfectly frying food starts with getting the temperature right for the oil. Different types of oil have different smoke points and without exact temperature management, food can be burnt easily. PerfectFry shows you when the ideal temperature for adding the oil to the pan has been reached.



Achieving perfect results with the 5 PerfectFry temperature levels:



# 1

**Very low**  
Ideal for boiling  
down sauces



# 2

**Low**  
Suitable for  
frying with virgin  
olive oil, or for  
frying omelettes



# 3

**Medium-low**  
Perfect for  
frying fish,  
meatballs  
or sausages



# 4

**Medium-high**  
Perfect for  
frying steak  
(medium or well  
done), ragout  
or vegetables



# 5

**High**  
Perfect for  
frying potatoes  
or rare steaks

# Electric hobs. Features and Benefits.

## Performance



### Quality ceramic top

High quality and durable ceramic top that can withstand heat up to 700°C.



### 17-stage power setting

Enjoy total control on every recipe with 17-stage power settings. This function allows cooking zones to be set in increments of 0.5 (eg. 0.5, 1, 1.5, 2...9).



### Automatic pan recognition

The automatic pan recognition function allows our induction hobs to identify the size of the pan and only heats up the base of the pan, not the entire zone, saving time and energy.



### PowerBoost

With PowerBoost, the power level of your induction hobs is increased to help you give that little extra boost when cooking. This means you can bring a pot filled with two litres of water to boil almost three times as quickly as on a conventional ceramic hob.

## Safety



### Childproof lock

Maximum protection for children's hands: the integrated lock function allows you to secure your cooking area and protect it against unwanted operation. This guarantees total safety – for both you and your loved ones.



### Overflow protection

A safety system protects the hob. If a metal object is placed on the hob or should there be any spillage, the hob may switch off and sound an alarm. An "E" naming message will appear on the display. This ensures safety for your loved ones.

h -  
Temperature  
is more than  
60°C

H -  
High  
temperature  
of more than  
120°C

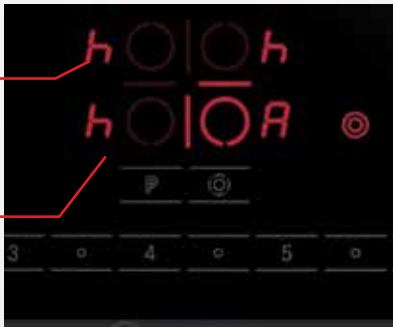

### 2-stage residual heat display

The 2-stage residual heat display provides clear indication on the heat of the zones after it is turned off, providing enhanced safety for the family.



### ReStart

If the hob is accidentally switched off, you can restore the last selected setting by just turning on the hob.



### QuickStart

The cooktop automatically detects where a pot has been placed after being switched on, and the zone is indicated on the display. You can get started immediately and select the desired cooking level for your pot.



## Convenience



### DirectSelect

With the DirectSelect function, all it takes is a finger select from the power level on offer, eliminating the needs to press +/- keys repeatedly.



### HighSpeed ceramic glass

HighSpeed cooking zones shorten initial heat-up times, allowing for rapid searing and frying.



### Wipe protection

Total control – even when you clean. With this function, you can lock the sensor buttons for 30 seconds to avoid making accidental changes to the cooking settings. This allows you to clean the surfaces without having to re-adjust settings.

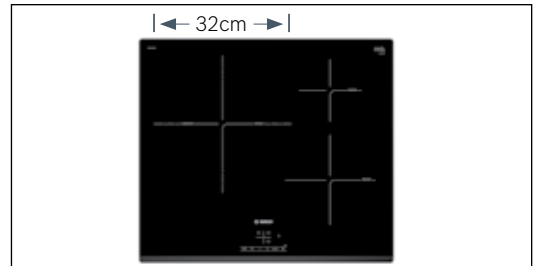

### Triple ring cook zone

The 32cm cooking zone for our induction hob is now the biggest in the market, allowing users to select a smaller or larger cook zone for different pan sizes.



### Count-up timer

If you want to know how long your spaghetti has been cooking and be alerted the moment it is al dente, you can simply use the new Count-up timer. It shows exactly how long you have been cooking. This is especially useful when you need to follow or test out recipes.

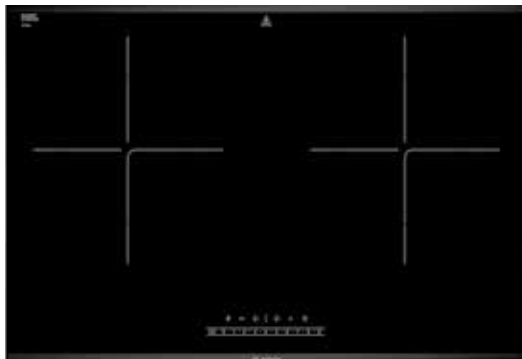

### PPI82560MS

76cm | Ceramic Induction Hob

#### Performance

- 2 Induction cooking zones
- Left and right zone: 1.8kW with booster 3.1kW (Ø180mm)

#### Features

- Automatic pan recognition sensor
- Power management function

#### Convenience

- Direct Select Touch Control: 9 Power Levels

#### Safety

- 2 stage residual heat indicator for each zone
- Timer with switch off function for each zone
- Safety time switch-off
- Childproof lock
- Wipe protection function

#### Technical Information

- Total connected load: 3.5kW
- Voltage: 220 - 240V
- Power frequency: 50 / 60Hz
- Cable length: 1.5m without plug
- Appliance dimensions (H x W x D): 59 x 780 x 450mm
- Cut out dimension (H x W x D): 59 x 700 x 400mm
- Direct wiring

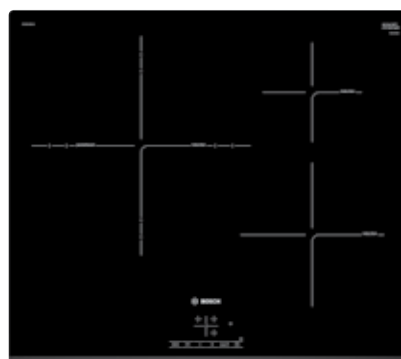

### PID631BB1E

60cm | Ceramic Induction Hob

#### Performance

- 3 induction cooking zones
  - Rear left: 3.3kW, 2.6kW, 2.2kW (with booster): 3.7kW, 4.4kW, 5.5kW (Ø: 210mm, 260mm, 320mm)
  - Rear right: 1.4kW with booster 2.2kW (Ø145mm)
  - Front right: 2.2kW with booster 3.7kW (Ø210mm)

#### Features

- Automatic pan recognition sensor
- Boost function for all zones
- Quick start and Restart
- Quality ceramic top

#### Convenience

- Touch Select Control: 17 power levels

#### Safety

- 2 stage residual heat indicator for each zone
- Timer with switch off function for each zone
- Safety time switch-off
- Childproof lock

#### Technical Information

- Total connected load: 7.4kW
- Voltage: 220 – 240V
- Power frequency: 50 / 60Hz
- Cable length: 1.1m without plug
- Appliance dimensions (H x W x D): 51 x 592 x 522mm
- Cut out dimensions (H x W x D): 51 x 560 x 490 – 500mm
- Direct wiring



### PXE675DC1E

60cm | Ceramic Induction Hob

#### Performance

- 4 induction cooking zones
  - Rear left / Front left: 2.2kW with booster 3.7kW (Ø240mm)
  - Full left area: 3.3kW with booster 3.7kW (Ø380mm)
  - Rear right: 1.4kW with booster 2.2kW (Ø145mm)
  - Front right: 2.2kW with booster 3.7kW (Ø210mm)

#### Features

- Automatic pan recognition sensor
- Boost function for all zones
- Perfectfry sensor
- PanBoost
- MoveMode
- Count-up timer / cooktop
- Quickstart and Restart
- Quality ceramic top
- Keep warm

#### Convenience

- Direct Select Premium: 17 power levels
- Energy consumption display

#### Safety

- 2 stage residual heat indicator for each zone
- Timer with switch off function for each zone
- Safety time switch-off
- Childproof lock
- Wipe protection function

#### Technical Information

- Total connected load: 7.4kW
- Voltage: 220 – 240V
- Power frequency: 50 / 60Hz
- Cable length: 1.1m without plug
- Appliance dimensions (H x W x D): 51 x 606 x 527mm
- Cut out dimensions (H x W x D): 51 x 560 x 490 – 500mm
- Direct wiring



### PKK651FP1E

60cm | Ceramic Radiant Hob

#### Performance

- 3 radiant cooking zones
  - Left and right zone: 1.8kW with booster 3.1kW (Ø180mm)
  - Left dual-circuit cooking zone: 2.7kW, 2.1kW with booster 3.4kW (Ø275mm, 210mm)
  - Rear right: 1.2kW (Ø145mm)
  - Front right: 1kW, 2kW with booster 2.3kW (Ø180mm, 120mm)

#### Features

- Quality Ceramic top

#### Convenience

- Direct Select Touch Control: 17 power levels
- PowerBoost function

#### Safety

- 2 stage residual heat indicator for each zone
- Timer with switch off function for each zone
- Safety time switch-off
- Childproof lock
- Power on indicator light
- Wipe protection function

#### Technical Information

- Total connected load: 5.75kW
- Voltage: 220 - 240V
- Power frequency: 50 / 60Hz
- Cable length: 1.0m without plug
- Appliance dimensions (H x W x D): 39 x 592 x 522mm
- Cut out dimension (H x W x D): 39 x 560 x 490 - 500mm
- Direct wiring

# The world of Bosch gas hobs.

Our German-designed gas hobs are available in a range of different styles and burner configurations for greater cooking flexibility.



## Performance



### Precise flame control

Ensure precise control of inner and outer flame.



### High-power wok-style burner

Selected gas cooktop models feature a powerful wok-style burner, which provides up to 6.0kW. Suitable for use with flat-based pans or with a wok using the wok ring provided.



### 3D flame wheel for evenly distributed heat

Our burners are designed to provide triple flame (for LPG gas) and double flame (for Towngas), to give powerful and even heat distribution.

## Safety



### Flame failure safety device

Safety valve system will cut off gas automatically when the flame goes out unexpectedly.

## Convenience



### Sealed top sheet

Prevention of spillage into the gas hob, ensuring safety and easy maintenance of appliance.



### One-hand electric ignition

The gas ignites automatically by pushing and turning the control knobs, offering convenience as there is no separate ignition button needed for cleaning. It also reduces the hassle of changing batteries.



### Flexible burners

With different burner combinations, enjoy greater cooking efficiency with the correct sized burner for the size of pan.



### PBD7251SG

76cm | Stainless Steel Gas Hob  
(Suitable for Town Gas and LPG)

#### Performance

- 2 gas burners
- 2 triple circuit burner (4.5kW)  
for each wok burner

#### Features

- Precise flame control

#### Convenience

- Safe and quick ignition

#### Safety

- Flame failure safety device

#### Technical Information

- Voltage: 220 – 240V
- Power frequency: 50Hz
- Cable length: 1.2m with plug
- Appliance dimensions (H x W x D):  
80 x 760 x 460mm
- Cut out dimensions (H x W x D):  
80 x 700 x 400mm



### PBD7231SG / PBD7232SG\*

78.5cm | Tempered Glass Gas Hob  
(Suitable for Town Gas / \*LPG)

#### Performance

- 2 gas burners
- 2 triple circuit burner (4.5kW)  
for each wok burner

#### Features

- Precise flame control

#### Convenience

- Safe and quick ignition

#### Safety

- Flame failure safety device

#### Technical Information

- Voltage: 220 – 240V
- Power frequency: 50Hz
- Cable length: 1.2m with plug
- Appliance dimensions (H x W x D):  
80 x 785 x 450mm
- Cut out dimensions (H x W x D):  
80 x 700 x 400mm



### PBD7351SG

76cm | Stainless Steel Gas Hob  
(Suitable for Town Gas and LPG)

#### Performance

- 3 gas burners
  - Left burner: 4.5kW
  - Center burner: 1.7kW
  - Right burner: 4.5kW

#### Features

- Precise flame control

#### Convenience

- Safe and quick ignition

#### Safety

- Flame failure safety device

#### Technical Information

- Voltage: 220 – 240V
- Power frequency: 50Hz
- Cable length: 1.2m with plug
- Appliance dimensions (H x W x D):  
80 x 760 x 460mm
- Cut out dimensions (H x W x D):  
80 x 700 x 400mm



### PBD7331SG / PBD7332SG\*

78.5cm | Tempered Glass Gas Hob  
(Suitable for Town Gas / \*LPG)

#### Performance

- 3 gas burners
  - Left burner: 4.5kW
  - Center burner: 1.7kW
  - Right burner: 4.5kW

#### Features

- Precise flame control

#### Convenience

- Safe and quick ignition

#### Safety

- Flame failure safety device

#### Technical Information

- Voltage: 220 – 240V
- Power frequency: 50Hz
- Cable length: 1.2m with plug
- Appliance dimensions (H x W x D):  
80 x 785 x 450mm
- Cut out dimensions (H x W x D):  
80 x 700 x 400mm



### PBD9351SG

90cm | Stainless Steel Gas Hob  
(Suitable for Town Gas and LPG)

#### Performance

- 3 gas burners
  - Left burner: 4.5kW
  - Center burner: 1.7kW
  - Right burner: 4.5kW

#### Features

- Precise flame control

#### Convenience

- Safe and quick ignition

#### Safety

- Flame failure safety device

#### Technical Information

- Voltage: 220 – 240V
- Power frequency: 50Hz
- Cable length: 1.2m with plug
- Appliance dimensions (H x W x D):  
80 x 900 x 480mm
- Cut out dimensions (H x W x D):  
80 x 880 x 455mm



### PBD9331SG

90cm | Tempered Glass Gas Hob  
(Suitable for Town Gas and LPG)

#### Performance

- 3 gas burners
  - Left burner: 4.5kW
  - Center burner: 1.7kW
  - Right burner: 4.5kW

#### Features

- Precise flame control

#### Convenience

- Safe and quick ignition

#### Safety

- Flame failure safety device

#### Technical Information

- Voltage: 220 – 240V
- Power Frequency: 50Hz
- Cable length: 1.2m with plug
- Appliance dimensions (H x W x D):  
80 x 920 x 480mm
- Cut out dimensions (H x W x D):  
80 x 880 x 455mm





## PCC6A5B90

60cm | Stainless Steel Gas Hob  
(Suitable for LPG)

### Performance

- 3 gas burners
  - Rear right: Rapid burner 3kW
  - Left: Wok burner 4kW
  - Right front: Economy burner 1kW

### Features

- FlameSelect
- Ergonomic sword control knobs

### Convenience

- Cast iron continuous pan supports

### Safety

- Flame failure safety device

### Technical Information

- Voltage: 220 – 240V
- Power frequency: 50 / 60Hz
- Cable length: 1m with plug
- Appliance dimensions (H x W x D):  
45 x 582 x 520mm
- Cut out dimensions (H x W x D):  
45 x 560 – 562 x 480 – 492mm

## Design with Flexibility

Domino hobs offer the ultimate in flexibility and consumer choice. With this nifty modular system, you have the freedom of designing your own cooking centre by mixing and matching a wide range of different hobs. Select any combination from our range of gas, induction, radiant or bbq grill.





### PRA3A6D70

30cm | Ceramic Domino Gas Hob  
(Suitable for LPG)

#### Performance

- 1 dual wok burner – 6.0kW

#### Features

- Flame select
- Quality ceramic top

#### Convenience

- Flexibility: can be combined with various types of hobs
- Cast iron and dishwasher proof pan support
- Ergonomic sword control knobs

#### Safety

- Flame failure safety device
- Residual heat indicator

#### Technical Information

- Gas connection rating 6.0kW
- Voltage: 220 – 240V
- Power frequency: 50 / 60Hz
- Cable length: 1m without plug
- Appliance dimensions (H x W x D): 45 x 306 x 527mm
- Cut out dimensions (H x W x D): 45 x 270 x 490 – 500mm

### PRA326B91X

30cm | Ceramic Domino Gas Hob  
(Suitable for Town Gas)

#### Performance

- 1 dual wok burner – 5.5kW

#### Features

- Precise flame control
- Quality ceramic top

#### Convenience

- Flexibility: can be combined with various types of hobs
- Cast iron and dishwasher proof pan support

#### Safety

- Flame failure safety device

#### Technical Information

- Gas connection rating 5.5kW
- Voltage: 220 – 240V
- Power frequency: 50Hz
- Cable length: 1m with plug
- Appliance dimensions (H x W x D): 87 x 306 x 527mm
- Cut out dimensions (H x W x D): 87 x 270 x 490 – 500mm

### PRB3A6D70

30cm | Ceramic Gas Hob  
(Suitable for LPG)

#### Performance

- Double burner
- Front: 1.9kW
- Rear: 2.8kW

#### Features

- Flame select
- Quality ceramic top

#### Convenience

- Flexibility: can be combined with various types of hobs
- Cast iron and dishwasher proof pan support
- Ergonomic sword control knobs

#### Safety

- Flame failure safety device
- Residual heat indicator

#### Technical Information

- Gas connection rating 4.7kW
- Voltage: 220 – 240V
- Power frequency: 50 / 60Hz
- Cable length: 1m without plug
- Appliance dimensions (H x W x D): 45 x 306 x 527mm
- Cut out dimensions (H x W x D): 45 x 270 x 490 – 500mm



### PRB326B90X

30cm | Ceramic Gas Hob  
(Suitable for Town Gas)

#### Performance

- Double burner
  - Front: 1.9kW
  - Rear: 2.8kW

#### Features

- Precise flame control
- Quality ceramic top

#### Convenience

- Flexibility: can be combined with various types of hobs
- Cast iron and dishwasher proof pan support

#### Safety

- Flame failure safety device

#### Technical Information

- Gas connection rating 4.7kW
- Voltage: 220 – 240V
- Power frequency: 50 / 60Hz
- Cable length: 1m without plug
- Appliance dimensions (H x W x D): 47 x 306 x 527mm
- Cut out dimensions (H x W x D): 45 x 270 x 490 – 500mm

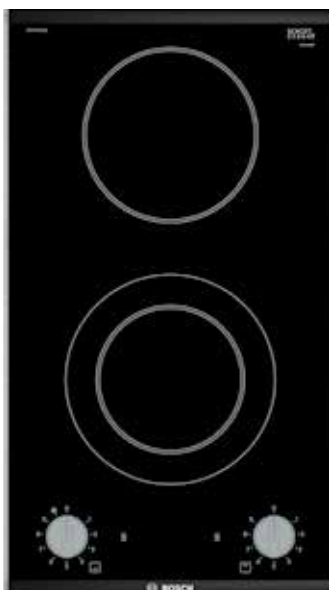

### PKF375CA1E

30cm | Ceramic Radiant Domino Hob

#### Performance

- 2 radiant cooking zones
  - Rear center: 1.2kW (ø145mm)
  - Front dual-circuit cooking zone: 2.0kW, 0.80kW (ø120mm, ø180mm)

#### Features

- Surface-mounted controls: 9 power levels
- Quality ceramic top

#### Convenience

- Flexibility: can be combined with various types of hobs

#### Safety

- 2 power on indicator lights
- 2-stage residual heat indicator for each zone

#### Technical Information

- Electrical connection rating 3.2kW
- Voltage: 220 – 240V
- Power frequency: 50 / 60Hz
- Cable length: 1m without plug
- Appliance dimensions (H x W x D): 48 x 306 x 527mm
- Cut out dimensions (H x W x D): 45 x 270 x 490 – 500mm
- Direct wiring

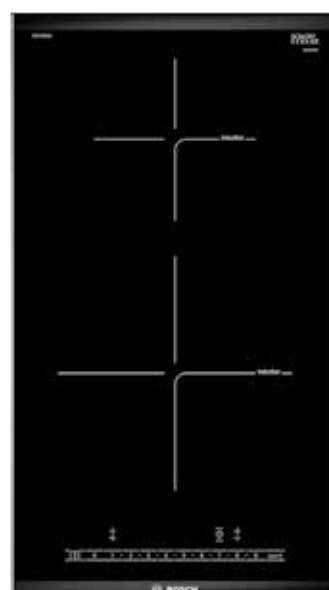

### PIB375FB1E

30cm | Induction Domino Hob

#### Performance

- 2 induction cooking zones
  - Rear center: 1.4kW with booster 2.2kW (ø145mm)
  - Front center: 2.2kW with booster 3.7kW (ø210mm)

#### Features

- Automatic pan recognition sensor
- DirectSelect touch control: 17 power levels
- Count-up timer
- Quickstart and Restart
- Quality ceramic top

#### Convenience

- Flexibility: can be combined with various types of hobs
- Electronic display
- Energy consumption display

#### Safety

- 2 power on indicator lights
- 2-stage residual heat indicator for each zone
- Childproof lock
- Safety time switch-off

#### Technical Information

- Electrical connection rating 3.7kW
- Voltage: 220 – 240V
- Power frequency: 50 / 60Hz
- Cable length: 1.1m without plug
- Appliance dimensions (H x W x D): 51 x 306 x 527mm
- Cut out dimensions (H x W x D): 51 x 270 x 490 – 500mm
- Direct wiring



## PKY475FB1E

40cm | Teppanyaki Domino Hob

### Performance

- Two separately controlled cooking zones: cook or heat using the entire or either half of the surface

### Features

- Automatic pan recognition sensor
- DirectSelect touch control: 17 power levels
- Quality ceramic top
- Count-up timer
- Keep warm
- Restart

### Convenience

- Flexibility: can be combined with various types of hobs
- Big stainless steel roast area
- Electronic display
- Energy consumption display

### Safety

- Power on indicator lights
- 2 stage residual heat indicator for each zone
- Safety time switch-off

### Technical Information

- Electrical connection rating 1.9kW
- Voltage: 220 – 240V
- Power frequency: 50 / 60Hz
- Cable length: 1m without plug
- Appliance dimensions (H x W x D):  
90 x 396 x 527mm
- Cut out dimensions (H x W x D):  
90 x 360 x 490 – 500mm

## The world of Bosch hoods.

With a wide variety of sizes, types and finishes to choose from, it's easy to find the right Bosch hood to perfectly suit your kitchen's design.



# The Right Hood.

Match your hood with your kitchen to keep your flat smelling clean and fresh. The right hood replaces air in your kitchen ideally 10 times an hour.



## What extraction rate do I need from my hood?

$$\begin{array}{c} \text{Volume of} \\ \text{Your Kitchen} \\ \text{(m}^3\text{)} \end{array} \times 10 = \begin{array}{c} \text{Minimum} \\ \text{Extraction} \\ \text{Rate Required} \end{array}$$

When choosing a hood, always match its air delivery power to the size of your kitchen. An effective extractor should be able to replace the air in your kitchen 10 times an hour.

## DID YOU KNOW ?

There are different types of air extraction measurements.

### Other Types of Air Extraction Measurement

Measurement of net fan power **at the air outlet above motor in appliance without connection to ducting system**

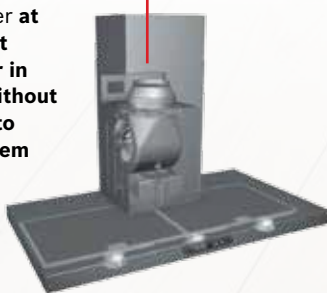

Measurement of net fan power **based on motor only**

### Bosch Stringent Measurement on Air Extraction: Testing according to EN 61591\*

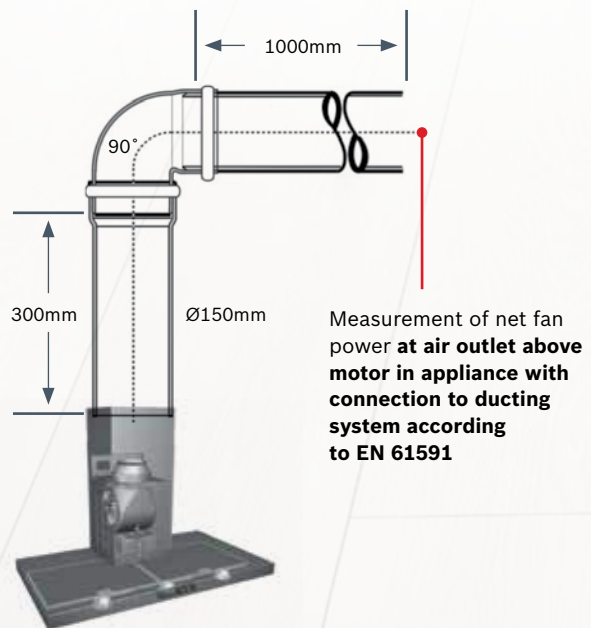

# At Bosch, ducted and recirculation systems smell the same. Of nothing.

Our hoods swiftly and reliably extract odours and grease particles from your kitchen. They create a consistently fresh feel good ambience before, during and after cooking. At the same time, they perfectly illuminate your worktop area and still look unbelievably attractive even after all that hard work.

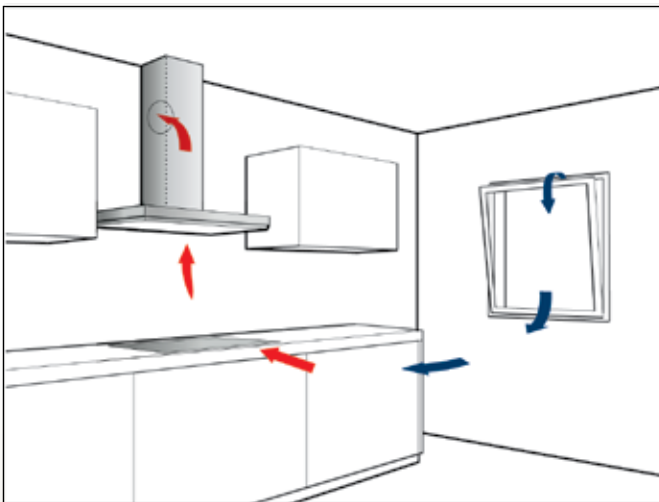

## Ducting

- Ducted hoods are powerful and effective.
- Odours, grease and steam are extracted, filtered and ducted to the outside.
- All that is required is sufficient fresh air, for instance from an open window.

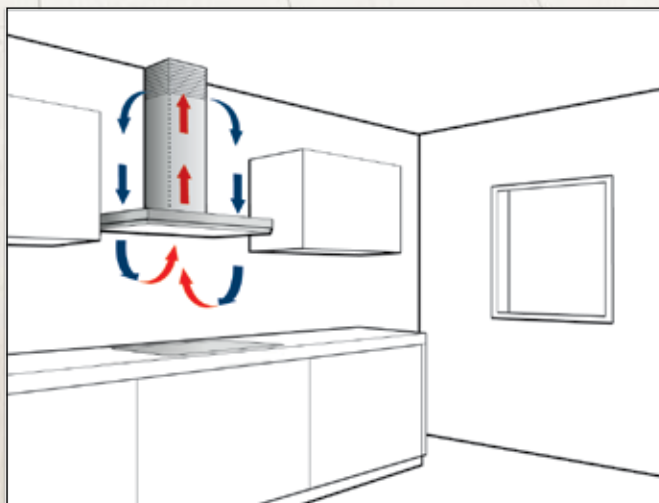

## Recirculation

- Hoods with recirculation are powerful and energy-efficient.
- Odours and grease are extracted and filtered. The purified air is returned to the room.
- As no ducting openings are necessary, no energy can escape (e.g. cold or heat).





# Relax in a quieter kitchen.



### **EcoSilence Drive®**

EcoSilence Drive® motor operates without carbon brushes, eliminating the disadvantages of conventional motors. Instead of energy loss, wear and noise, you get efficiency, durability, and smooth operation.

To reduce motor noise even further, we have optimised the airflow inside the hood. The result: low noise levels with high power.

## **Design**

### **Worktop Lighting**



#### **LED lighting**

LED lights offer a longer lifetime and use less energy than conventional halogen lighting. Additional convenience is offered with SoftLight which gently fades lighting in and out with dimmer function.



#### **Inner frame**

The patented Bosch inner frame is specially shaped to permit an optimum flow of air and leading stability to the hood. Without any edges, cleaning the frame is also easy.



#### **Halogen lighting**

Integrated halogen lighting ensures that the cooking area is clearly illuminated. They are more efficient than standard lights and are designed to last longer.

# Hoods. Features and Benefits.

## Performance



### Powerful extraction rate

With models offering up to 1000m<sup>3</sup>/h maximum extraction and ventilating capability, the Bosch line of efficient, high-performance hoods aids in removing steam, odours, grease and smoke quickly.

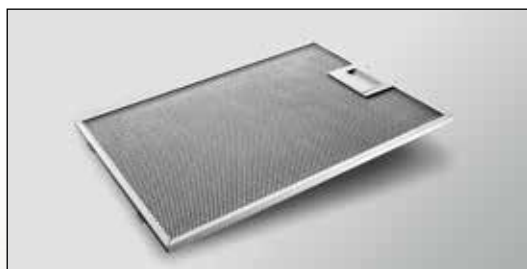

### Dishwasher-safe metal grease filters

All Bosch filters have up to 5 layers of filters and for easy cleaning it can be safely loaded into any Bosch dishwasher for sparkling results.



### Active carbon filter

A recirculating kit with active carbon filter eliminates unpleasant odours and is easy to install and replace.

## Convenience



### Variable power settings

Odours, smoke and moisture can be effectively removed with the variable power settings on Bosch hoods. An intensive extraction setting on selected hood models provides an extra boost to the performance of the hood when needed.

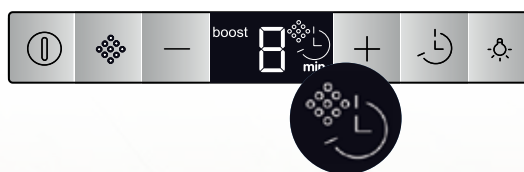

### Electronic 'clean-filter indicator'

A light is illuminated when the filter needs a cleaning, ensuring optimal efficiency of the hood.

### After running

Continuing operation of the hood for approx ten minutes after normal usage ensure vapours and odours are effectively removed.

### Automatic switch back

When the intensive setting is selected, it may be set to automatically revert back to a pre-defined normal level after a short period of time.



### DHI623GSG

60cm | Slimline Hood

#### Performance

- Max extraction rate: 380 m<sup>3</sup>/h, according to EN 61591
- Suitable for ducted or re-circulated operation
- Operating sound level: 70db

#### Features

- 3 speeds

#### Convenience

- Dishwasher safe metal grease filter
- Push buttons controls

#### Technical Information

- Voltage: 220 – 240V
- Power frequency: 50Hz
- Cable length: 2.0m
- Appliance dimensions
  - Exhaust and recirculate (H x W x D): 180 x 598 x 300mm
  - Cut out dimensions (H x W x D): 140 x 550 x 280mm

### DHI923GSG

90cm | Slimline Hood

#### Performance

- Max extraction rate: 380 m<sup>3</sup>/h, according to EN 61591
- Suitable for ducted or re-circulated operation
- Operating sound level: 70db

#### Features

- 3 speeds

#### Convenience

- Dishwasher safe metal grease filter
- Push buttons controls

#### Technical Information

- Voltage: 220 – 240V
- Power frequency: 50Hz
- Cable length: 2.0m
- Appliance dimensions
  - Exhaust and recirculate (H x W x D): 180 x 898 x 300mm
  - Cut out dimensions (H x W x D): 140 x 850 x 280mm

### DHL755B

70cm | Silver Metallic Canopy Hood

#### Performance

- Max extraction rate: 630 m<sup>3</sup>/h, according to EN 61591
- Suitable for ducted or re-circulated operation
- Operating sound level: 61db

#### Features

- Twin motor
- 2 x 20W halogen lighting
- 3 speeds plus intensive setting

#### Convenience

- Dishwasher safe metal grease filter
- Sliding switch control for extractor speeds and light

#### Technical Information

- Voltage: 220 – 240V
- Power frequency: 50Hz
- Cable length: 1.3m
- Appliance dimensions
  - Exhaust and recirculate (H x W x D): 255 x 730 x 380mm
  - Cut out dimensions (H x W x D): 255 x 700 x 350mm

**DFS097A50B**

90cm | Silver Metallic Slimline Hood

**Performance**

- Max extraction rate: 740m<sup>3</sup>/h, according to EN 61591
- Suitable for ducted or re-circulated operation
- Operating sound level: 55dB

**Features**

- EcoSilence™ Drive
- 3 speed settings plus intensive setting
- 2 x 3W LED lighting
- Automatic run on: 10 mins
- Intensive operation revert: 6 mins

**Convenience**

- Dishwasher safe metal grease filter
- Push button controls with electronic display

**Technical Information**

- Voltage: 220 – 240V
- Power frequency: 50 / 60Hz
- Cable length: 1.75m
- Appliance dimensions
  - Exhaust and recirculate (H x W x D): 426 x 898 x 290mm
  - Cut out dimensions (H x W x D): 385 x 524 x 290mm

**DFS098K53**

90cm | Stainless Steel Slimline Hood

**Performance**

- Max extraction rate: 840m<sup>3</sup>/h, according to EN 61591
- Suitable for ducted or re-circulated operation
- Operating sound level: 51dB

**Features**

- EcoSilence™ Drive
- 3 speed plus 2 intensive settings
- 2 x 3W LED lighting
- Automatic run on: 10 mins
- Intensive operation revert: 6 mins
- Air quality sensor

**Convenience**

- Dishwasher safe metal grease filter
- Electronic controls with TouchControl

**Technical Information**

- Voltage: 220 – 240V
- Power frequency: 50 / 60Hz / 13A
- Cable length: 1.75m
- Appliance dimensions
  - Exhaust and recirculate (H x W x D): 378 x 898 x 290mm
  - Cut out Dimensions (H x W x D): 337 x 524 x 290mm

**DWB097E50B**

90cm | Box Design Chimney Hood

**Performance**

- Max extraction rate: 730m<sup>3</sup>/h, according to EN 61591
- Suitable for ducted or re-circulated operation
- Operating sound level: 55dB

**Features**

- Twin channel high performance fan motor
- EcoSilence™ Drive
- 3 speed plus 2 intensive settings
- 3 x 3W LED lighting
- Soft light with dimmer function
- Automatic run on: 10 mins
- Intensive operation revert: 6 mins

**Convenience**

- Dishwasher safe metal grease filter
- Saturation indicator for metal & charcoal filter

**Technical Information**

- Voltage: 220 – 240V
- Power frequency: 50 / 60Hz
- Cable length: 1.3m
- Appliance dimensions
  - Exhaust (H x W x D): 642 – 954 x 900 x 500mm
  - Recirculate (H x W x D): 642 – 1064 x 900 x 500mm



### DWB091E50

90cm | Slimline Box Design  
Chimney Hood

#### Performance

- Max extraction rate: 980m<sup>3</sup>/h, according to EN 61591
- Suitable for ducted or re-circulated operation
- Operating sound level: 62dB

#### Features

- Twin channel high performance fan motor
- EcoSilence™ Drive
- 3 speed plus 2 intensive settings
- 3 x 3W LED lighting
- Soft light with dimmer function
- Automatic run on: 10 mins
- Intensive operation revert: 6 mins

#### Convenience

- Dishwasher safe metal grease filter
- Saturation indicator for metal & charcoal filter

#### Technical Information

- Voltage: 220 – 240V
- Power frequency: 50 / 60Hz
- Cable length: 1.3m
- Appliance dimensions
  - Exhaust (H x W x D): 628 – 954 x 900 x 500mm
  - Recirculate (H x W x D): 628 – 1064 x 900 x 500mm



### DEE928PSG

90cm | Slimline Pyramid Design  
Chimney Hood

#### Performance

- Max extraction rate: 1000m<sup>3</sup>/h
- Suitable for ducted or re-circulated operation
- Operating sound level: 69dB

#### Features

- 3 speeds
- 2 x 3W LED lighting

#### Convenience

- Dishwasher safe metal grease filter
- Easy to clean integrative chimney
- Push button controls

#### Technical Information

- Voltage: 220 – 240V
- Power frequency: 50 / 60Hz
- Cable length: 1.5m
- Appliance dimensions
  - Exhaust (H x W x D): 707 – 1075 x 895 x 530mm
  - Recirculate (H x W x D): 707 – 1195 x 895 x 530mm



### DEE928BSG

90cm | Box Design Chimney Hood

#### Performance

- Max extraction rate: 1000m<sup>3</sup>/h
- Suitable for ducted or re-circulated operation
- Operating sound level: 69dB

#### Features

- 3 speeds
- 2 x 3W LED lighting

#### Convenience

- Dishwasher safe metal grease filter
- Easy to clean integrative chimney
- Push button controls

#### Technical Information

- Voltage: 220 – 240V
- Power frequency: 50 / 60Hz
- Cable length: 1.5m
- Appliance dimensions
  - Exhaust (H x W x D): 678 – 1048 x 895 x 530mm
  - Recirculate (H x W x D): 678 – 1168 x 895 x 530mm



### DWP96BC50B

90cm | Pyramid Design Chimney Hood

#### Performance

- Max extraction rate: 600m<sup>3</sup>/h, according to EN 61591
- Suitable for ducted or re-circulated operation
- Operating sound level: 69dB

#### Features

- 2 x 1.5W LED
- Energy Efficient Capacitor Motor
- 3 Speeds via Push Buttons
- Metal Grease Filter

#### Convenience

- Dishwasher Safe Metal Grease Filter

#### Technical Information

- Voltage: 220 – 240V
- Power Frequency: 50/60Hz
- Cable Length: 1.3m
- Appliance Dimensions
  - Exhaust (H x W x D): 799–975 x 900 x 500 mm
  - Recirculate (H x W x D): 799–975 x 900 x 500 mm



### DIB091E51

90cm | Island Hood

#### Performance

- Max extraction rate: 1000m<sup>3</sup>/h, according to EN 61591
- Suitable for ducted or re-circulated operation
- Operating sound level: 60db

#### Features

- Twin channel high performance fan motor
- EcoSilence™ Drive
- 3 speed plus 2 intensive settings
- Softlight with dimmer function
- 4 x 3W LED lighting
- Automatic run on: 10 mins
- Intensive operation revert: 6 mins

#### Convenience

- Dishwasher safe metal grease filter

#### Technical Information

- Voltage: 220 – 240V
- Power frequency: 50 / 60Hz
- Cable length: 1.3m
- Appliance dimensions
  - Exhaust (H x W x D): 744 – 924 x 900 x 600mm
  - Recirculate (H x W x D): 744 – 1044 x 900 x 600mm



### DIB121U50

120cm | Island Hood

#### Performance

- Max extraction rate: 890m<sup>3</sup>/h, according to EN 61591
- Suitable for ducted or re-circulated operation
- Operating sound level: 62db

#### Features

- Twin channel high performance fan motor
- EcoSilence™ Drive
- 3 speed plus 2 intensive settings
- Softlight with dimmer function
- 4 x 3W LED lighting
- Automatic run on: 5 / 10 / 15 mins
- Intensive operation revert: 6 mins
- Rim ventilation
- Air quality sensor

#### Convenience

- Dishwasher safe metal grease filter
- Inner frame

#### Technical Information

- Voltage: 220 – 240V
- Power frequency: 50 / 60Hz
- Cable length: 1.3m
- Appliance dimensions
  - Exhaust (H x W x D): 744 – 924 x 1200 x 650mm
  - Recirculate (H x W x D): 744 – 1044 x 1200 x 650mm



### DWF97RU60

90cm | Flat design with glass canopy  
Hood (wall-mounted)

#### Performance

- Max extraction rate: 420m<sup>3</sup>/h, according to EN 61591
- Suitable for ducted or re-circulated operation
- Operating sound level: 57db

#### Features

- Twin channel high performance fan motor
- EcoSilence™ Drive
- 3 speed plus 2 intensive settings
- Softlight with dimmer function
- 4 x 3W LED lighting
- Automatic run on: 5 / 10 / 15 mins
- Intensive operation revert: 6 mins
- Rim ventilation
- Air quality sensor

#### Convenience

- Dishwasher safe metal grease filter
- Inner frame

#### Technical Information

- Voltage: 220 – 240V
- Power frequency: 50 / 60Hz
- Cable length: 1.3m
- Appliance dimensions
  - Exhaust (H x W x D): 744 – 924 x 1200 x 650mm
  - Recirculate (H x W x D): 744 – 1044 x 1200 x 650mm



### DDA097G59B

90cm | Downdraft Hood

#### Performance

- Max extraction rate: 710m<sup>3</sup>/h, according to EN 61591
- Suitable for ducted or re-circulated operation
- Operating sound level: 61db

#### Features

- Twin channel high performance fan motor
- 1 x 10W LED-module
- 4 speed plus intensive settings
- Automatic run on: 15 mins
- Intensive operation revert: 6 mins
- Rim ventilation

#### Convenience

- Dishwasher safe metal grease filter

#### Technical Information

- Voltage: 220 – 240V
- Power frequency: 50Hz
- Cable length: 1.5m
- Appliance dimensions
  - Exhaust and Recirculate (H x W x D): 651 – 1052 x 912 x 351mm



# Service you can depend on.

Expert, fast and reliable customer service from Bosch, before and after your purchase, Bosch is your partner for life.

## Reliability guaranteed. No compromises.

All Bosch home appliances are produced with maximum care, using high quality materials. We promise it in our 2-year manufacturer's warranty on all appliances.

## Speedy Response

Our customer's time is valuable and so we react quickly. We aim for a business response time of 2 business days from your call, offering on-site diagnosis and repairs.

## Quality service straight from the manufacturer. Original Bosch.

We are committed to quality - also when it comes to after sales service. No-one knows our appliances better than our highly trained service engineers. They are working with the latest equipment for measuring, diagnostics and repairs, and use only original Bosch spare parts.

## Lifetime service. It goes without saying at Bosch.

Once your warranty period is over, we are still there to assist you. You can rely on our expert care and first-rate service throughout your appliance's life cycle. From missing instruction manuals to appliance repair - we take care of everything. A promise is a promise!

## Original accessories. Effective care products.

Take a look at our extensive range of accessories for some inspiration: discover additional uses, replace old materials for optimum operation or simply give a trusty home appliance a good work-over. With the right care, you will be able to enjoy your high quality appliance for many years to come. To help you do so, we offer a wide range of Bosch-certified cleaning and care products.

## Tested and Approved Cleaning and Care Collection

Cleaning and caring for your appliances is crucial to maintaining optimum performance and keeps your appliances looking good. Our cleaning and care collection undergoes stringent test and quality checks. They are developed to complement your appliances, to tackle the toughest cleaning job and to keep your appliances in top shape.

## Bosch Online Store

Shop at your convenience with the Bosch Online Store. Browse the Cleaning and Care Collection and wide range of accessories from the comfort of your home. Visit us at [www.bosch-home.com.sg/store](http://www.bosch-home.com.sg/store).

## On-Call

Our friendly Bosch Customer Service team provides competent, reliable assistance for all of your needs; whether that is product advice, to arranging a visit from a service engineer, or ordering the right original accessories or spare parts.

For engineer visits, spare parts replacement and accessories or product advice, please contact:

**Customer Care Line:**  
(65) 6751 5000

**Operating Hours:**  
Monday to Friday, 8.30am to 5.30pm

**Customer Service Center:**  
4012 Ang Mo Kio Avenue 10  
#01-01 Techplace 1  
Singapore 569628

[www.bosch-home.com.sg](http://www.bosch-home.com.sg)



**BSH Home Appliances Pte. Ltd. (Reg. No: 199608497E)**

11 Bishan Street 21 Bosch Building #04-01

Singapore 573943

Toll Free: 1800-MY-BOSCH (1800-69-26724)

Fax: (65) 6507 3818

**[www.bosch-home.com.sg](http://www.bosch-home.com.sg)**