

User's Guide

3922 496 30541 August 2007 v5.0

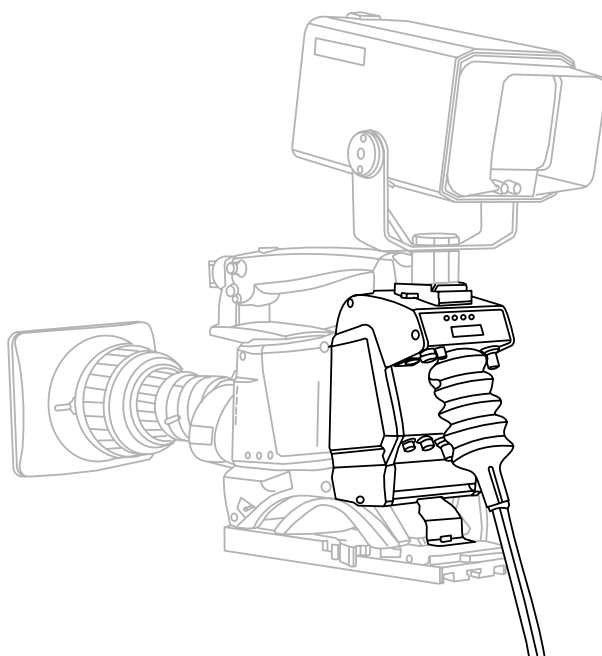

LDK 5481 + LDK 4700

SD DigiLink camera system

Declaration of Conformity

We, Grass Valley Nederland B.V., Kapittelweg 10, 4827 HG Breda, The Netherlands, declare under our sole responsibility that this product is in compliance with the following standards:

- EN60950-1 : Safety
- EN55103-1: EMC (Emission)
- EN55103-2: EMC (Immunity)

following the provisions of:

- a. the Safety Directives 73/23/EEC and 93/68/EEC
- b. the EMC Directives 89/336/EEC and 93/68/EEC

FCC Class A Statement

This product generates, uses, and can radiate radio frequency energy and if not installed and used in accordance with the instructions, may cause interference to radio communications.

It has been tested and found to comply with the limits for a class A digital device pursuant to part 15 of the FCC rules, which are designed to provide reasonable protection against such interference when operated in a commercial environment.

Operation of this product in a residential area is likely to cause interference in which case the user at his own expense will be required to take whatever measures may be required to correct the interference.

Copyright

Copyright Grass Valley Nederland B.V. 2007. Copying of this document and giving it to others, and the use or communication of the contents thereof, are forbidden without express authority. Offenders are liable to the payment of damages. All rights are reserved in the event of the grant of a patent or the registration of a utility model or design. Liable to technical alterations in the course of further development.

Trademarks

Grass Valley and Infinity are trademarks of Grass Valley, Inc. All other tradenames referenced are service marks, trademarks, or registered trademarks of their respective companies.

Website

Visit the Grass Valley public website to download the latest user's guide updates and additional information about your broadcast product:

www.thomsongrassvalley.com

Table of contents

Chapter 1 – DigiLink system

1.1	Introduction	1-1
1.2	Accessories	1-1
1.3	Compatibility	1-2
1.4	Configurations	1-2
1.4.1	Digilink system SDI coax configuration	1-2
1.4.2	DigiLink system multicore configuration	1-3
1.4.3	Stand alone SDI coax configuration	1-4
1.4.4	Stand alone multicore configuration	1-4
1.4.5	DigiLink system hybrid fiber configuration	1-5
1.4.6	DigiLink system dual fiber configuration	1-5
1.5	Intercom	1-6

Chapter 2 – DigiLink Adapter

2.1	Specifications	2-5
2.2	Dimensions	2-6
2.3	Compatibility	2-6
2.4	Controls	2-7
2.4.1	Powering the camera	2-7
2.5	Attaching the LDK 5481 adapter to a camera head	2-8
2.6	Mounting a script board	2-9
2.7	Adapter connectors	2-10
2.7.1	SDI video output connector	2-11
2.7.2	SDI video input connector	2-11
2.7.3	Multicore connector	2-12
2.7.4	Hybrid fiber connector	2-13
2.7.5	Video signal (VF) output connector	2-13
2.7.6	Video signal (CVBS) output connector	2-13
2.7.7	Intercom headset connector	2-14
2.7.8	LCP / Fiber power connector	2-14
2.7.9	DC power output socket	2-15
2.7.10	DC power input socket	2-15
2.7.11	Script light power supply socket	2-16
2.8	Install menu	2-17

Chapter 3 – Base unit

3.1	Specifications	3-8
3.2	Dimensions	3-9
3.3	Controls and indicators	3-10
3.3.1	Powering the base unit	3-10
3.3.2	Indicators	3-10
3.3.3	Set-up items	3-10
3.4	Connecting the studio signalling	3-12
3.4.1	Call and On-air signals	3-12

3.5	DigiLink base unit connectors.	3-14
3.5.1	Setup switches	3-15
3.5.2	Audio out connector.	3-15
3.5.3	External video input connector	3-16
3.5.4	Reference input connector	3-16
3.5.5	Teleprompter input connector	3-16
3.5.6	Y, Pr, Pb output connectors	3-17
3.5.7	SDI Camera connectors	3-17
3.5.8	CVBS output connector	3-17
3.5.9	SDI video output connectors	3-18
3.5.10	RS-232/RS-422 control connector	3-18
3.5.11	Mains power supply input socket	3-18
3.5.12	Auxiliary connector.	3-19
3.5.13	DC power output connector	3-19
3.5.14	Multicore connector.	3-20
3.5.15	Hybrid fiber connector	3-20

Chapter 1

DigiLink system

1.1 Introduction

The DigiLink system consists of an LDK 5481 camera adapter and an LDK 4700 base unit for use with Grass Valley standard definition (SDTV) camera heads. The system features digital signal processing and digital transmission of all signals between the camera head and base unit to ensure there is no loss of quality.

As well as delivering high-quality 10-bit SDI video and audio of CD quality, the bidirectional digital transmission system carries teleprompter, external video for viewfinder, intercom, control and tally signals, embedded genlock and private data signals. All these signals are embedded in the SDI signal streams.

The flexible system configuration makes DigiLink the ideal companion for Grass Valley cameras in many environments. Depending on the application and cable lengths needed, the system can utilize low-cost coax cables, existing multicore cables or hybrid or dual fiber connections.

Typical applications for DigiLink include educational use or small studios such as local TV stations, continuity or announcement studios. It is also ideal for use in conference and parliamentary systems or in high-end surveillance. The camera with DigiLink adapter can also operate as a stand-alone unit by using its VTR output.

1.2 Accessories

The following DigiLink accessories are available:

RS-232 powerline cable	LDK 8120/02, LDK 8120/10, LDK8120/25
RS-422 powerline cable	LDK 8121/02, LDK 8120/10, LDK8120/25
Headset dynamic XLR-5 with double muff	LDK 8111/37
DC power supply 100W (2-out)	LDK 5901/00
Local Control Panel LCP 100	LDK 5201
Operational Control Panel OCP 400	LDK 4640/10

1.3 Compatibility

If you wish to control your camera locally, you can connect an OCP 400 to the RS-232 connector of the camera. When an OCP 400 panel is used with the DigiLink system, C2IP functions (e.g. file management) are not supported by the system.



Note

The LDK 5481 adapter is backwards compatible with existing LDK 5480 breakout boxes and can be connected to them as described in the LDK 5480 User's Guide.

1.4 Configurations

1.4.1 DigiLink system SDI coax configuration

A camera head with an LDK 5481/00 adapter can be connected to the LDK 4700/00 base unit using two coax SDI cables. The maximum length of cable that can be used is 250m (820 ft). High quality coax cable should be used (for example, Belden 1694A). The DC power supply for the camera is supplied directly to the adapter by an optional local power supply or by the base unit (using a DC power cable).

Figure 1-1. DigiLink system SDI coax connection

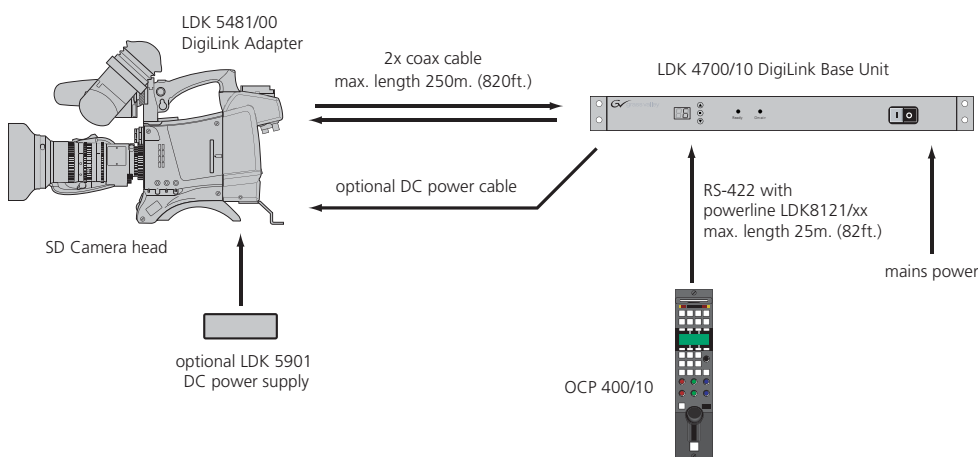

When a DC power cable is used to power the camera from the base unit, refer to section 3.5.13 for the pin layout of the DC connector. The maximum length of the cable depends on the type of cable and the power used by the camera. The table below is an indication of the cable lengths that can be used.

Table 1-2. cable length indication for DC power cable

listed cable type	cable cross section	max. length (3A/40W)	max. length (5A/60W)
AWG 20	0.75 mm ²	50 m	30 m
AWG 18	1.0 mm ²	75 m	45 m
AWG 16	1.3 mm ²	125 m	75 m



Note

Always use a power cable from the *portable power cables* category, type W, G, G-GC or PPE. The cable must be listed in accordance with NEC article 400 of ANSI/NFPA70.

1.4.2 DigiLink system multicore configuration

A camera head with an LDK 5481/00 adapter can be connected to the LDK 4700/10 base unit using multicore cable. The maximum length of cable that can be used is 75 m (250 ft). The base unit can supply power for the camera via the multicore cable. The power consumption of the camera may reduce the maximum length of cable that can be used, so alternatively, the power for the camera can be supplied directly to the adapter from the optional LDK 5901 power supply.

Figure 1-3. DigiLink system multicore connection

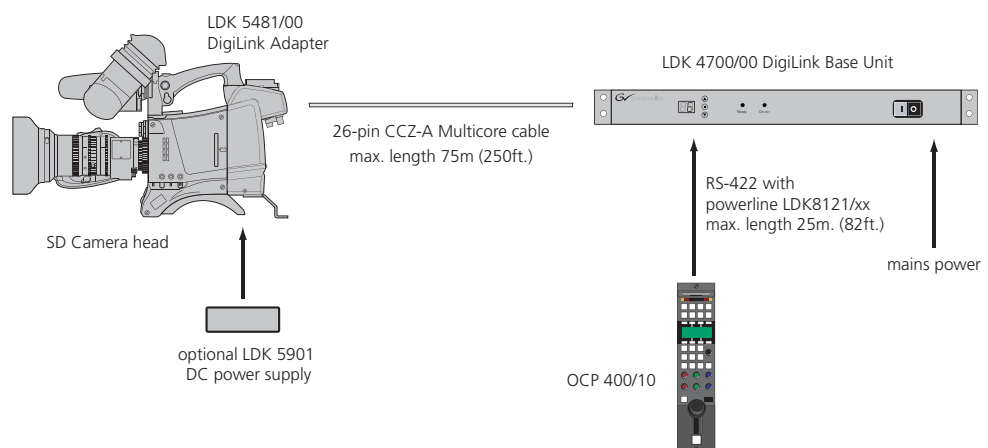

Note

Always use a listed 26-pin CCZ-A multicore cable compliant with EBU N21 (for example, Draka multicore camera cable type 755-2 PVC.)

1.4.3 Stand alone SDI coax configuration

A camera head with an LDK 5481/00 adapter can be connected to a recorder unit using an SDI coax cable. Only the SDI signal is passed via the coax cable. The maximum length of cable that can be used is 300 m (1000 ft). High quality coax cable should be used (for example, Belden 1694A). The DC power supply for the camera is supplied directly to the adapter.

Figure 1-4. Stand alone SDI coax configuration

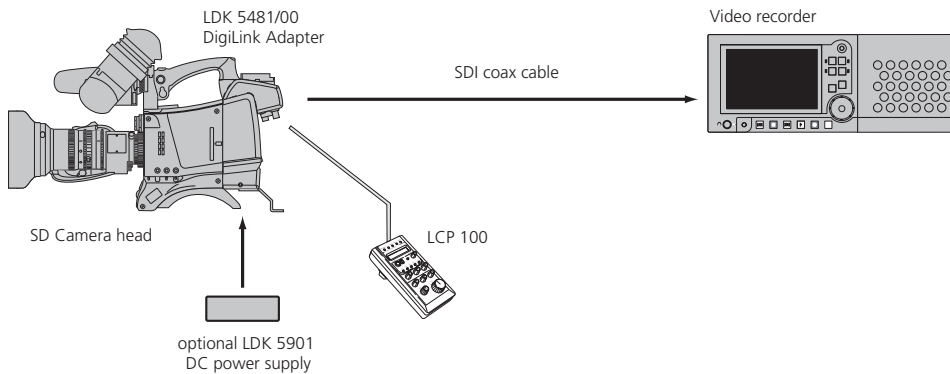

1.4.4 Stand alone multicore configuration

A camera head with an LDK 5481/00 adapter can be connected to a recorder using a multicore cable. Power can be supplied by the recorder via the multicore cable or directly to the adapter itself. To avoid degradation in the video signal, the maximum cable length is restricted to 5 m (17 ft) when the component outputs are used in the recorder.

If the recorder uses the SDI signals, then the maximum length of cable depends on the ability of the recorder unit to supply sufficient power to the camera. When the adapter is powered directly the maximum length is 100 m (330 ft). With minimum power supplied from the recorder unit the maximum length is 25 m (80 ft).

Figure 1-5. Stand alone multicore configuration

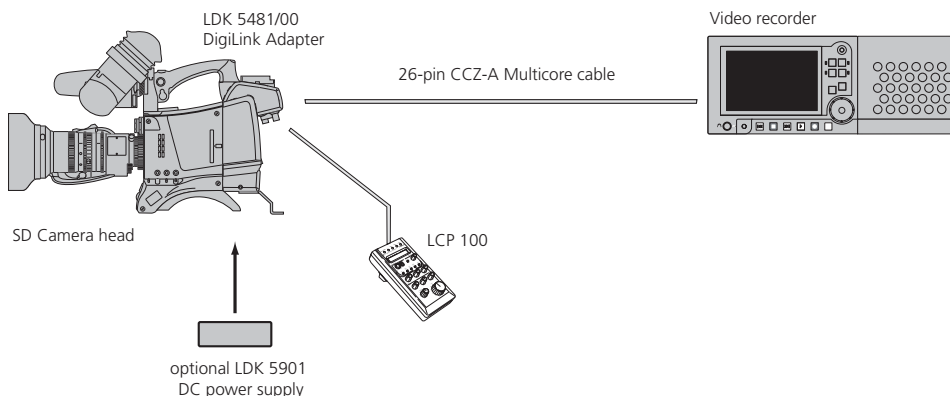

Note

Always use a listed 26-pin CCZ-A multicore cable compliant with EBU N21 (for example, Draka multicore camera cable type 755-2 PVC)

1.4.5 DigiLink system hybrid fiber configuration

A camera head with an LDK 5481/20 fiber adapter can be connected to the LDK 4700/20 base unit using a hybrid fiber cable that carries both signal and power. The maximum cable length that can be used is 100 m (330 ft). The power consumption of the camera may reduce the maximum length of cable that can be used, so alternatively, the power for the camera can be supplied directly to the adapter from the optional LDK 5901 power supply.

Figure 1-6. DigiLink system hybrid fiber connection

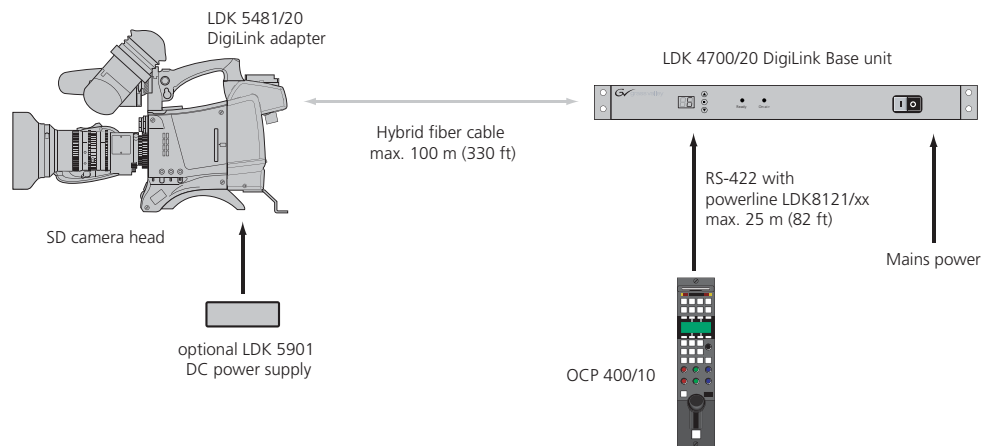

1.4.6 DigiLink system dual fiber configuration

A camera head with an LDK 5481/20 fiber adapter can be connected to the LDK 4700/20 base unit using a dual fiber cable. The maximum cable length that can be used is 5,000 m (16,400 ft). The camera adapter must be powered locally by the optional LDK 5901 DC power supply.

Figure 1-7. DigiLink system dual fiber connection

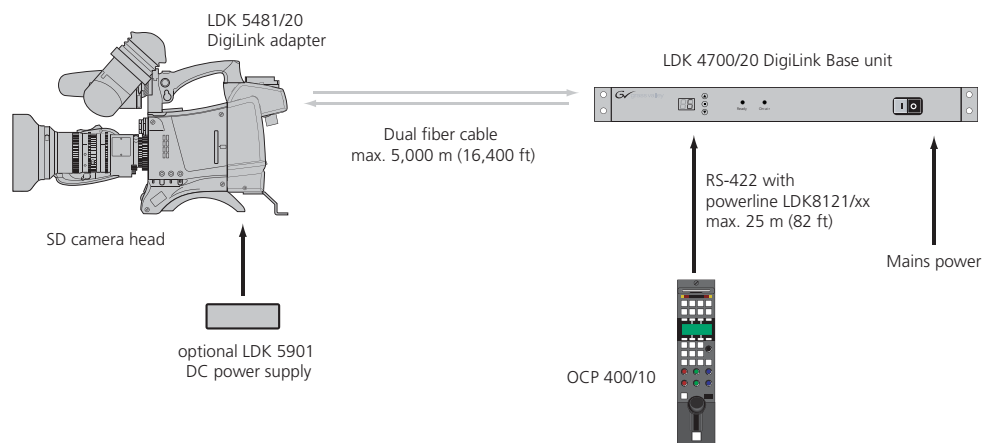

1.5 Intercom

An intercom channel connects the base unit to the camera operator's headset. The operator's intercom microphone signal is sent to the base unit. The headset can be connected to the 5 pin XLR headset connector at the back of the DigiLink adapter. For the connector and detailed pin descriptions refer to chapter 2.7.7.

A conversation is started when the camera operator presses the **VTR Start button** at the front of the camera or the **VTR button** on the lens. The function and behaviour of this button can be defined in the **INSTALL** menu of the camera. Refer to the camera's user's guide.

The volume of the headset earmuffs can be adjusted by turning the audio volume knob at the front (right side) of the camera.

Intercom configuration

The sidetone volume level (feedback signal from the microphone to the earmuffs) can be adjusted with the **INSTALL/INTERCOM/SIDETONE** function in the camera (available only when a 4-wire connection is used).

Depending on the type of microphone the following items can be set in the **INSTALL/INTERCOM** menu in the camera:

- Microphone gain level (0 or +40 dB) with the **CAM.MIC_GAIN** function;
- Microphone power can be switched on or off with the **CAM.MIC_POWER** function.

Both 2-wire and 4-wire intercom connections can be used. On the base unit, set the setup switch S1 in the Off-position when a 4-wire connection is used and set it in the On-position when a 2-wire connection is used. Refer to chapter 3.5.2 for the description of the setup switch.

The following figure shows an overview of the routing of the intercom system. For the connector and detailed pin descriptions refer to chapter 3.4.

Figure 1-8. Schematic overview of the intercom routing

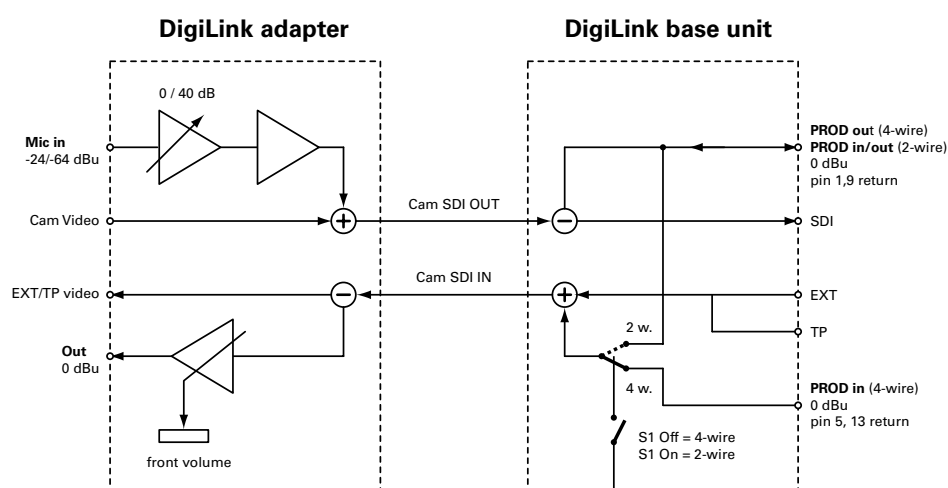

Chapter 2

DigiLink Adapter

Important information (English)

Read this information carefully before installing or servicing this equipment and retain them for future reference. Read and comply with the warning and caution notices that appear in the manual.

Any changes or modifications not expressly approved in this manual could void your authority to operate this equipment.

Safety Summary

This information is intended as a guide for trained and qualified personnel who are aware of the dangers involved in handling potentially hazardous electrical/electronic equipment. It is not intended to contain a complete list of all safety precautions which should be observed by personnel in using this or other electronic equipment.

The installation of this equipment involves risks both to personnel and equipment and must be performed only by qualified personnel exercising due care.

During installation and operation of this equipment, local building safety and fire protection standards must be observed.

Whenever it is likely that safe operation is impaired, the apparatus must be made inoperative and secured against any unintended operation. The appropriate servicing authority must then be informed. For example, safety is likely to be impaired if the apparatus fails to perform the intended function or shows visible damage.

Warnings

Warnings indicate danger that requires correct procedures or practices to prevent death or injury to personnel.

- Do not modify this equipment.
- Installation of this equipment must only be performed by qualified personnel.
- Do not use any accessories other than those recommended by the manufacturer.
- In case of an emergency ensure that the power is disconnected.

- There are no user servicable parts inside. Refer servicing to qualified personnel only or contact your local Grass Valley representative.

Cautions

Cautions indicate procedures or practices that should be followed to prevent damage or destruction to equipment or property.

- Always switch off the camera before changing the power supply.
- Be extremely careful with the connectors between the camera head and the adapter. Do not allow the guide pins to damage the pins of the connector. Follow these steps in the order given. Tightening the screws in the wrong order could result in mechanical damage to the camera. Loosening the screws in the wrong order could result in mechanical damage to the camera.
- To prevent risk of overheating, ventilate the units correctly.
- Do not subject the unit to severe shocks or vibration.
- Do not expose the unit to extremes of temperature.
- Do not leave the unit in direct sunlight or close to heating appliances for extended periods.
- Avoid very damp places. If the environment is wet or damp a rain cover must be used to protect the unit.

Wichtige Hinweise (Deutsch)

Lesen Sie bitte diese Hinweise genau bevor Sie diese Apparatur installieren und erhalten Sie Sie für künftiges Nachslagen. Beachten und Lesen Sie alle mit "Achtung" und "Vorsicht" gekennzeichneten Warnhinweise.

Änderungen haben zur Folge, dass die Garantie ungültig wird und der Benutzer für etwaige durch die veränderte Ausrüstung verursachte Störungen haftbar gemacht werden könnte.

Sicherheit (Zusammenfassung)

Diese Informationen sind als Leitfaden für qualifiziertes Fachpersonal gedacht, das die Gefahren beim Umgang mit potenziell gefährlicher elektrischer/elektronischer Ausrüstung kennt. Es handelt sich dabei nicht um eine vollständige Zusammenstellung aller Sicherheitsvorkehrungen, die beim Gebrauch dieser oder anderer elektronischer Geräte zu beachten sind.

Die Montage, Wartung und Instandsetzung dieser Ausrüstung ist mit Risiken für Personal und Ausrüstung verbunden und darf nur von qualifiziertem Personal vorgenommen werden, wobei mit der nötigen Sorgfalt vorzugehen ist.

Mit der Montage, Bedienung, Instandhaltung oder Instandsetzung dieser Ausrüstung betrauten Personen wird dringend geraten, sich mit der Theorie und Praxis der Ersten Hilfe vertraut zu machen.

Beim Einbau und Betrieb dieser Ausrüstung müssen die örtlichen Gebäudesicherheits- und Brandschutzvorschriften beachtet werden. Vor dem Anschluss der Ausrüstung an die Stromversorgung der Anlage muss überprüft werden, ob der Schutzleiter intakt ist.

Wenn eine Beeinträchtigung des sicheren Betriebs wahrscheinlich ist, muss das Gerät außer Betrieb gesetzt und gegen ungewollten Betrieb gesichert werden. Dann muss der zuständige Kundendienst benachrichtigt werden. Eine Beeinträchtigung der Sicherheit ist zum Beispiel dann wahrscheinlich, wenn das Gerät nicht wie vorgesehen funktioniert oder einen sichtbaren Schaden aufweist.

Vorsicht!

Mit "Vorsicht" wird auf eine Gefahr hingewiesen, die korrekte Arbeits- oder Verfahrensweisen erfordert, um Tod oder Verletzung zu verhindern.

- An dieser Ausrüstung dürfen keine Änderungen vorgenommen werden;
- Die Montage dieser Ausrüstung darf nur von Fachpersonal vorgenommen werden;
- Es sollen nur von den Hersteller empfohlene Zubehöre verwendet werden;
- Bei Eintreten eines Notfalls unbedingt die Stromzufuhr abschalten;
- Dieses Produkt enthält keine Anwenderteile. Reparatur und Wartung nur von qualifiziertem Fachpersonal vornehmen lassen oder nehmen Sie Kontakt auf mit Ihrem Grass Valley Vertretene;

Achtung!

Mit "Achtung" werden Arbeitsanweisungen gekennzeichnet, die zu befolgen sind, um eine Beschädigung oder Zerstörung der Ausrüstung bzw. von Eigentum zu verhindern.

- Die Kamera vor dem Wechsel der Stromversorgung immer ausschalten;
- Stecker zwischen Kamerakopf und Adapter mit äußerster Vorsicht handhaben. Darauf achten, dass die Steckerstifte nicht durch die Führungsstifte beschädigt werden.
- Um einer Überhitzungsgefahr vorzubeugen, ist das Produkt korrekt zu belüften;
- Dieses Produkt darf nicht an extremen stöße oder Zittern ausgesetzt werden;
- Dieses Produkt darf nicht an extremen Temperaturen ausgesetzt werden;
- Nicht langfristig in direktem Sonnenlicht oder in der Nähe von Heizgeräte zurücklassen.
- Vermeide feuchtigen Plätze. Wenn die Umgebung nass oder feucht ist, muss ein Regenüberzug verwendet werden um das Gerät zu schützen.

Fiber optic transmission units



A yellow coloured CLASS 1 LASER PRODUCT label is located on top of the fiber optic connector on the rear panel of the adapter.

Laser safety statement (Europe)

Fiber optic transmission units are classified as a "CLASS 1 Laser Product" according to EN 60825-1, Safety of Laser products. Class 1 laser products are considered safe and do not result in biological hazard if used according to the instructions.

Laser safety statement (US)

Fiber optic transmission units are classified as a "CLASS 1 Laser Product" according to 21CFR 1040.10 of the US Food and Drug Administration (FDA) Center for Devices and Radiological Health.



WARNING

Use of controls, adjustments or performance of procedures other than those specified herein may result in hazardous radiation exposure.

To ensure proper use of this product, please read this instruction manual carefully and retain for future reference. Should the unit ever require maintenance, contact an authorized service location.

Fiber optic cable precautions

Fiber optic cables and connectors are easily damaged; take the following precautions into account:

- Do not bend the cable beyond the minimum bend range specified for the cable.
- Avoid kinks or sharp bends in the cable.
- Avoid subjecting the cable to a high tension force.
- Do not twist the cable when connecting it to equipment.
- Insert connectors straight and fully into their corresponding sockets.
- In fiber optic cable systems always put the dust caps on cable and panel connectors immediately after disconnecting a cable. Keep the dust caps clean.

2.1 Specifications

The DigiLink camera adapter is available in two versions:

- The LDK 5481/00 version has a 26-pin multicore connector and two SDI coax connectors to connect to an LDK 4700/00 or LDK 4700/10 base unit;
- The LDK 5481/20 version has a hybrid fiber connector to connect to the LDK 4700/20 DigiLink fiber adapter.

When ordering, you specify the version you require.

Item	Value
Power requirements	12 VDC
Power consumption	typical 12 W
Operating temperatures	-20 to +45°C (-4 to +113°F)
Storage temperatures	-20 to +60°C (-4 to +140°F)
Weight (approx.)	1.5 kg (3.3 lbs)
Dimensions	105 mm (L) x 120 mm (W) x 225 mm (H) mm without handgrip
Power input	12 VDC XLR-4 male (or multicore cable)
Power output	12 VDC 1.5A; 4-pin Hirose
CVBS out (VF/EXT/TP)	1 Vpp; 75 Ohm; BNC
Viewfinder output (CVBS/EXT/TP)	1 Vpp; 75 Ohm; BNC
LCP connector	for connecting an LCP 100 local control panel; 12-pin Hirose
LDK 5481/00 version (multicore/coax)	
Multicore connection	26-pin EBU N21 multicore connector
SDI Video output	SMPTE 259M, 0.8 Vpp, 270Mb/s; 75 Ohm; BNC
SDI Video input	SMPTE 259M, 0.8 Vpp, 270Mb/s; 75 Ohm; BNC
LDK 5481/20 version (fiber version)	
DigiLink connection	Neutrik hybrid fiber optical connector

2.2 Dimensions

Figure 2-1. LDK 5481 DigiLink adapter dimension sketch

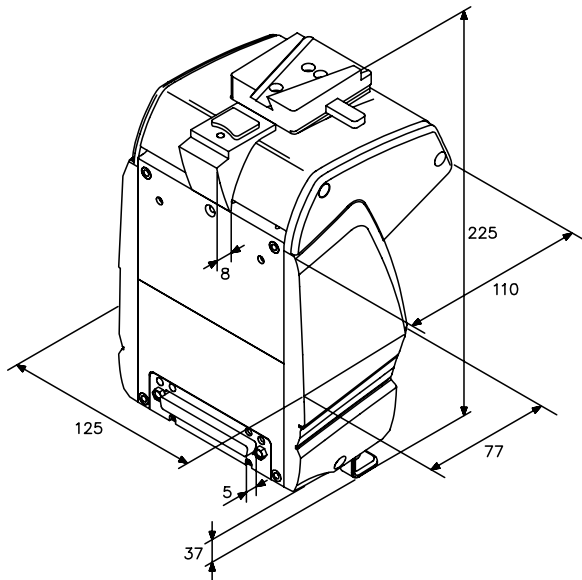

2.3 Compatibility

Before using the LDK 5481 DigiLink adapter you must ensure that it is compatible with your camera head. Camera heads with software version v13.0 and higher are fully compatible and do not need to be upgraded. Camera heads with software below this version must be updated.

Older camera heads with data board no. 3922 406 84271 or LDK 100 cameras built before 2001 need to be upgraded. For more information on upgrading your camera contact your Grass Valley service representative.

2.4 Controls

Figure 2-2. LDK 5481 adapter controls

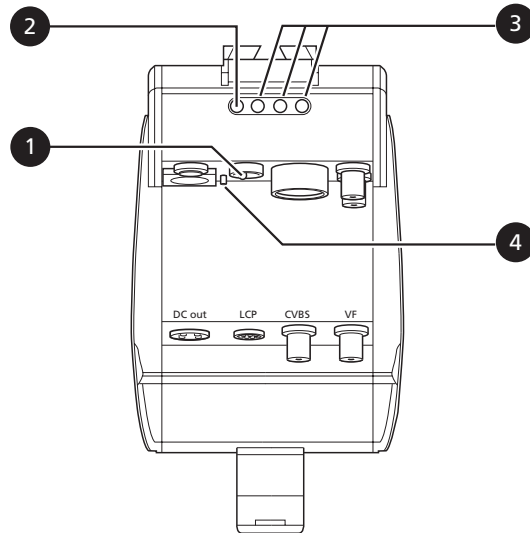

1. Power source selection switch
2. Power on indicator (green)
3. Tally indicators (red)
4. Circuit breaker button (fuse)

2.4.1 Powering the camera

The power supply for the camera and the adapter (+12 Vdc) is normally supplied either via the multicore connector or via the DC IN socket. Set the power source selection switch (1) to the position that corresponds to your chosen method:

- LOC: Powered via DC IN socket
- REM: Powered via multicore

The power on indicator (2) lights when power is supplied and the camera power switch is On.

If excessive current flows in the camera or adapter, the circuit breaker (4) trips and shuts off power to all the units. If this happens, check the units for faults and if necessary take corrective action before pressing the circuit breaker button to reset the power.

2.5 Attaching the LDK 5481 adapter to a camera head

The LDK 5481 adapter is shorter than a standard adapter. Before attaching the LDK 5481 adapter to a camera, the carrying handle must be re-positioned on the camera head using the mounting bracket supplied with the adapter.

To re-position the carrying handle for a short adapter, proceed as follows:

1. Remove the viewfinder and any other adapter attached to the camera.
2. Unscrew and remove the two screws that attach the front of the carrying handle to the camera. (For the LDK 500: tilt the carrying handle backwards and use your fingertips to gently unplug the flat cable that connects the zoom control to the connector inside the camera body.)

Note

The digital zoom control of the LDK 500 cannot be used in combination with the LDK 5481 adapter. An optional analogue zoom control LDK 6113 can be used.

3. Remove the carrying handle from the camera.
4. Use the supplied screws and washers to attach the mounting bracket to the top of the camera. (Use the screw holes where the handle was previously attached.)

Figure 2-1. Carrying handle replacement

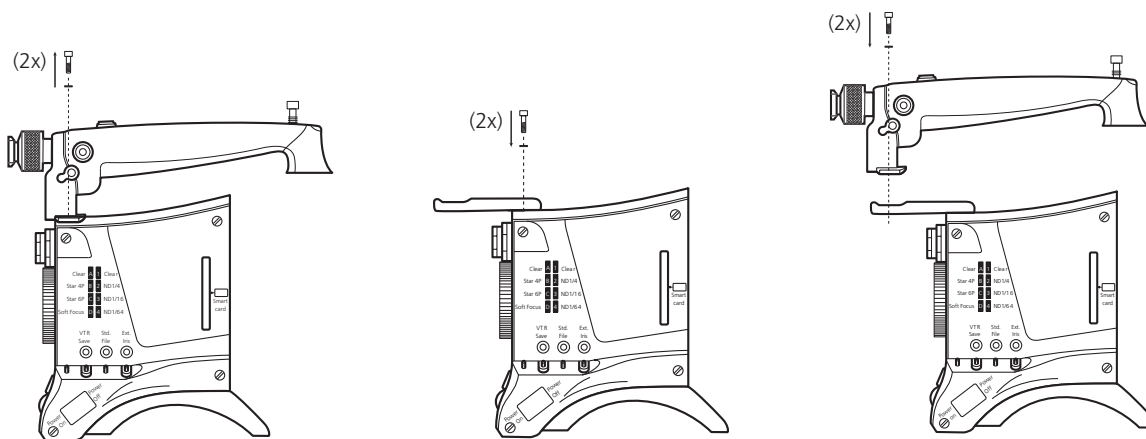

5. For LDK 500: fold the flat cable away into the hollow part of the carrying handle.
6. Place the carrying handle into the recess at the front of the mounting plate and use the two original screws to secure it in place.
7. Attach the LDK 5481 adapter to the camera (refer to section "Attaching an adapter" in the User's Guide of your camera for further instructions).

2.6 Mounting a script board

To attach the optional script board (LDK 6985/21) to the adapter use the special bracket and screws delivered with the script board. To attach the bracket to the adapter, proceed as follows:

1. Unscrew and remove the four screws attaching the viewfinder holder to the top of the adapter.
2. Place the viewfinder holder on top of the script board bracket and align the screw holes.
3. Using the four long screws provided, attach the holder and bracket to the top of the adapter.
4. The script board can now be mounted onto the bracket.

Figure 2-3. Script board accessory

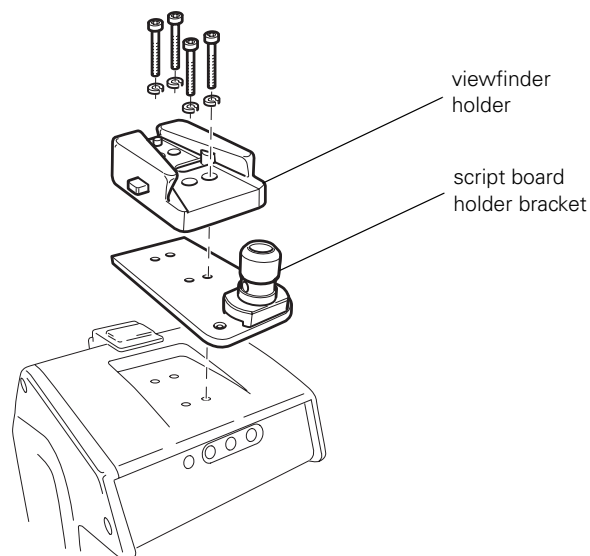

2.7 Adapter connectors

Figure 2-4. DigiLink adapter connector locations

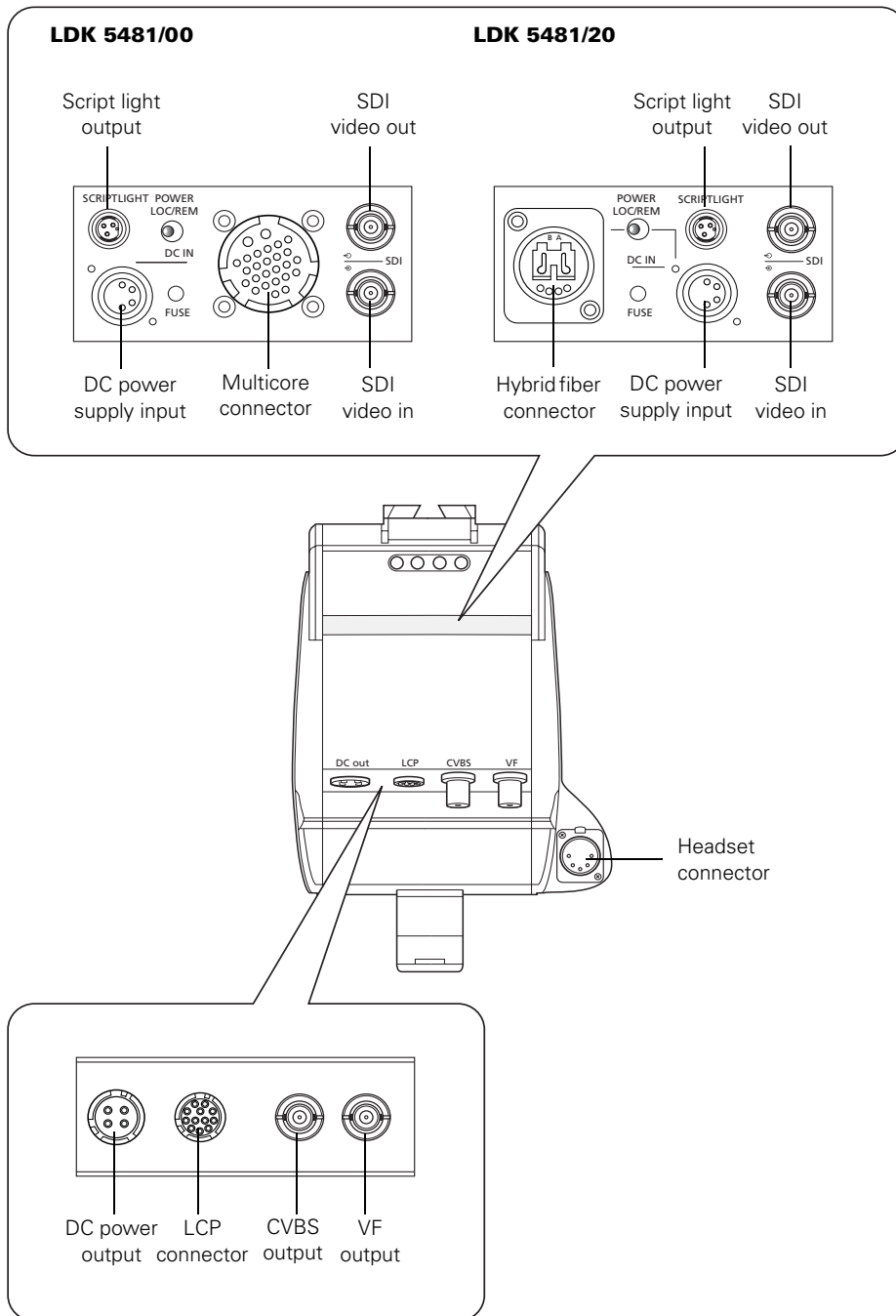

2.7.1 SDI video output connector

Figure 2-5. SDI video output connector

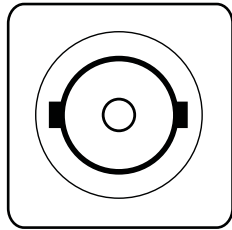

BNC connector: panel view (X8)

This BNC connector supplies an SDI video output signal (Y/Cr/Cb 4:2:2) that also includes embedded audio, intercom and private data signals.

2.7.2 SDI video input connector

Figure 2-6. SDI video input connector

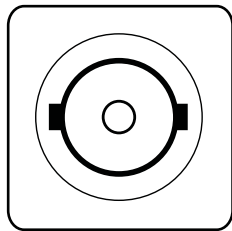

BNC connector: panel view (X9)

This BNC connector receives an SDI video input from the base unit.

Reference, teleprompter and external video signals are embedded in the stream together with intercom, control and private data signals.

2.7.3 Multicore connector

Figure 2-7. Multicore connector

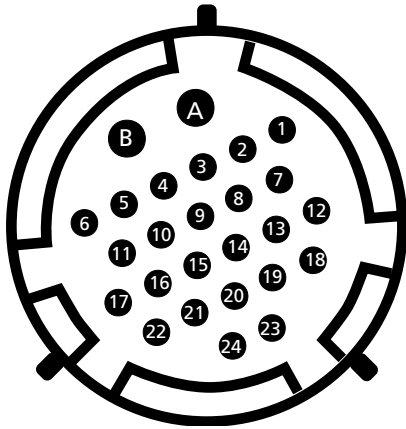

26-pin male; panel view
Panel part number: (X6) 3922 040 02571

This multicore connector can be used to connect either a recorder or a base unit (LDK 4700/10).

When connected to a recorder it provides the video outputs, control signals and the camera microphone signal. DC power can also be supplied to the camera via this connector.

The connector accepts a playback video signal for display in the viewfinder. The start/stop control signal for an external recorder is also passed via this connector.

A.+ Battery from VTR (+10.7 to +17V)

B.- Battery Ground

1. SDI
2. SDI Return
3. Y Return
4. Y
5. Pr: NTSC 700mV 75% saturated colour bar
Cr: PAL 525mV (EBU N10)
6. Pr/Cr Return
7. Pb: NTSC 700mV 75% saturated colour bar
Cb: PAL 525mV (EBU N10)
8. Pb/Cb Return
9. Cam. Mic. X
10. Cam. Mic. Y
11. Cam. Mic. shield
12. VTR start/stop: +5V = recording; 0V = stop
13. Batt. alarm
14. Power sense
15. Record/Tally
16. Genlock Video/BB return
17. Cable shield (Camera GND to VTR GND)
18. Playback video / Ext. VF
19. Playback video return / Ext. VF return
20. VTR Save
21. Genlock Video/BB
22. Spare
23. RXD, control
24. TXD, control

2.7.4 Hybrid fiber connector

Figure 2-8. Hybrid fiber connector

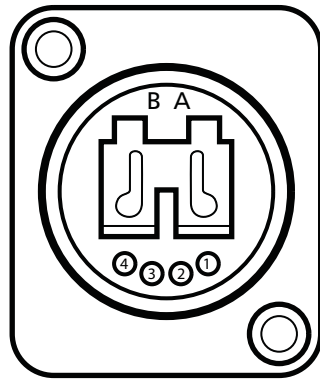

Neutrik OpticalCon® Hybrid Fiber connector
(NO2-4FD-1-R)

A Fiber IN

B Fiber OUT

1. Power GND
2. Power GND sense
3. Power + sense
4. Power +

2.7.5 Video signal (VF) output connector

Figure 2-9. Video signal (VF) output connector

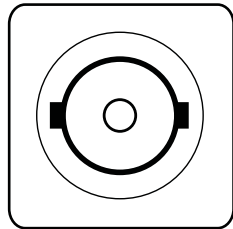

BNC connector: panel view

This BNC socket provides a 1.0 Vpp analog output video signal. This signal can be assigned in the **INSTALL** menu of the camera. Either the VF, CVBS, EXT. or TP signal can be selected.

By default the viewfinder signal is output. Markers and menus similar to those in the viewfinder can be superimposed on this signal.

2.7.6 Video signal (CVBS) output connector

Figure 2-10. Video signal (CVBS) output connector

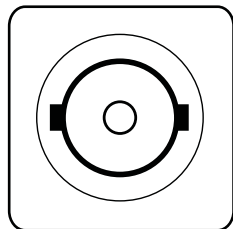

BNC connector: panel view

This BNC socket provides a 1.0 Vpp analog output video signal. This signal can be assigned in the **INSTALL** menu of the camera. Either the VF, CVBS, EXT. or TP signal can be selected.

By default the CVBS signal is output for viewing.

2.7.7 Intercom headset connector

Figure 2-11. XLR intercom headset connector

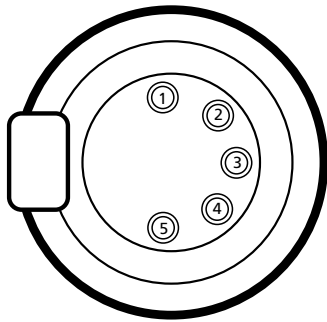

XLR 5-pin female; panel view (X11)

1. Microphone return
2. Microphone
3. Telephone return
4. Telephone left
5. Telephone right

Microphone level: -64 dBu / -24 dBu switchable
Microphone impedance: >600 Ohm

Telephone level: +6 dBu nominal
Telephone output impedance: <50 Ohm

2.7.8 LCP / Fiber power connector

Figure 2-12. LCP connector

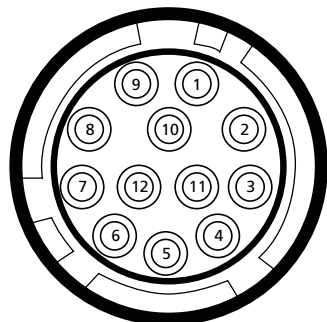

Hirose 12-pin female; panel view
Panel part number: (X5) 2422 026 04355

This connector is used to connect an LCP control panel (LDK 5201) to the camera.

1. -
2. RS-232 RXD
3. RS-232 TXD
4. Private data IN (Camera to base unit)
5. GND
6. -
7. Private data OUT (base unit to Camera)
8. -
9. +Batt
10. SDA
11. SCL
12. Housing

2.7.9 DC power output socket

Figure 2-13. DC power and tally output connector

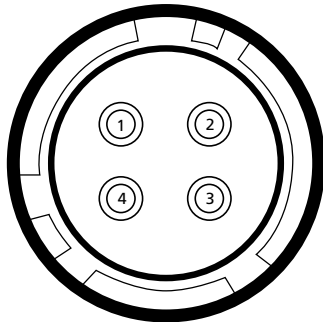

Hirose 4-pin female; panel view
Panel part number: (X3) 2422 026 04675

1. Power ground
2. On air (+5V, 100 Ohm)
3. Housing
4. +12 Vdc (max. 18W)

Shield of cable directly to the connector housing.

The socket provides access to an internal tally switch. When the camera is on-air, the contact of the internal relay is closed.

2.7.10 DC power input socket



Caution

The input voltage must not exceed +17 Vdc.

Figure 2-14. DC power input connector

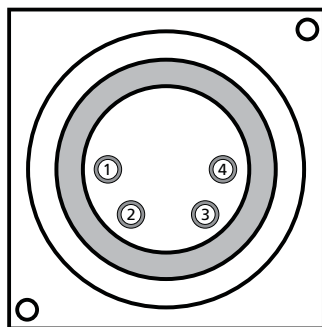

XLR 4-pin male: panel view (X7)

1. Power ground
2. -Batt sense
3. +Batt sense
4. +10.5 Vdc . . . +17 Vdc

This socket accepts a DC voltage of 12V nominal.
Maximum power consumption 60W.

2.7.11 Script light power supply socket

Figure 2-15. Script light power supply output connector

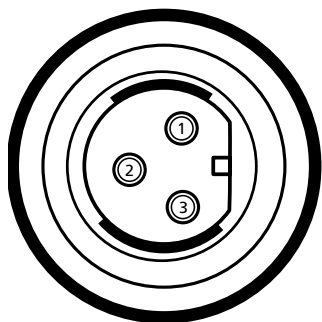

1. +12 Vdc (maximum dissipation 3W)
2. Power return
3. Shield

Fischer 3-pin female: panel view
Panel connector number: (X4) 3922 040 02881

2.8 Install menu

The functions shown in the table below appear in the `INSTALL` menu of the camera head when an LDK 5481 adapter is attached. Refer to the User's Guide of the camera head for more information on accessing this menu.

Main menu items	Purpose
Disable Camera	on/off
IR receiver	on/off
OnAir Lamp	on/off
Intercom	set intercom values
Audio	set gain and filter
Timing	set subcarrier and h-phase
Notch	on/off
Aspect ratio	select aspect ratio values
Exposure	set lighting and clear scan values
Gain preset	set gain preset values
Quick Smart Touch	on/off
Buttons	assign functions to buttons
Video output	assign YCrCb or RGB to VTR output
CVBS output	assign CVBS, EXT, TP or VF to CVBS output
VF output	assign CVBS, EXT, TP or VF to VF output

Chapter 3

Base unit

Important information (English)

Read this information carefully before installing this equipment and retain them for future reference. Read and comply with the warning and caution notices that appear in the manual.

Any changes or modifications not expressly approved in this manual could void your authority to operate this equipment.

Safety Summary

This information is intended as a guide for trained and qualified personnel who are aware of the dangers involved in handling potentially hazardous electrical/electronic equipment. It is not intended to contain a complete list of all safety precautions which should be observed by personnel in using this or other electronic equipment.

The installation of this equipment involves risks both to personnel and equipment and must be performed only by qualified personnel exercising due care.

During installation and operation of this equipment, local building safety and fire protection standards must be observed.

Before connecting the equipment to the power supply of the installation, the proper functioning of the protective earth lead of the installation needs to be verified.

Whenever it is likely that safe operation is impaired, the apparatus must be made inoperative and secured against any unintended operation. The appropriate servicing authority must then be informed. For example, safety is likely to be impaired if the apparatus fails to perform the intended function or shows visible damage.

Warnings

Warnings indicate danger that requires correct procedures or practices to prevent death or injury to personnel.

- Do not modify this equipment;
- Installation of this equipment must only be performed by qualified personnel;
- Do not use any accessories other than those recommended by the manufacturer;
- In case of an emergency ensure that the power is disconnected;

- Mount equipment so that power lead can be accessed to disconnect power;
- Any interruption of the protection conductor inside or outside the apparatus, or disconnection of the protective earth terminal, is likely to make the apparatus dangerous. Intentional interruption is prohibited;
- Use only fuses of the type and rating specified;
- To prevent fire or shock hazard, do not expose the unit to rain or moisture;
- There are no user servicable parts inside. Refer servicing to qualified personnel only or contact your local Grass Valley representative;
- Observe local building safety, fire protection and electrical installation standards during installation and operation of this equipment;
- Before connecting the equipment to the power supply of the installation, verify the proper functioning of the protective earth lead;
- Whenever it is likely that safe operation is impaired, the apparatus must be made inoperative and secured against any unintended operation.

Cautions

Cautions indicate procedures or practices that should be followed to prevent damage or destruction to equipment or property.

- Do not subject the unit to severe shocks or vibration;
- Do not expose the unit to extremes of temperature;
- To prevent risk of overheating, ventilate the product correctly;
- Connect the product only to a power source with the specified voltage rating.

Wichtige Hinweise (Deutsch)

Lesen Sie bitte diese Hinweise genau bevor Sie diese Apparatur installieren und erhalten Sie Sie für künftiges Nachslagen. Beachten und Lesen Sie alle mit "Achtung" und "Vorsicht" gekennzeichneten Warnhinweise

Änderungen haben zur Folge, dass die Garantie ungültig wird und der Benutzer für etwaige durch die veränderte Ausrüstung verursachte Störungen haftbar gemacht werden könnte.

Sicherheit (Zusammenfassung)

Diese Informationen sind als Leitfaden für qualifiziertes Fachpersonal gedacht, das die Gefahren beim Umgang mit potenziell gefährlicher elektrischer/elektronischer Ausrüstung kennt. Es handelt sich dabei nicht um eine vollständige Zusammenstellung aller Sicherheitsvorkehrungen, die beim Gebrauch dieser oder anderer elektronischer Geräte zu beachten sind.

Die Montage, Wartung und Instandsetzung dieser Ausrüstung ist mit Risiken für Personal und Ausrüstung verbunden und darf nur von qualifiziertem Personal vorgenommen werden, wobei mit der nötigen Sorgfalt vorzugehen ist.

Mit der Montage, Bedienung, Instandhaltung oder Instandsetzung dieser Ausrüstung betrauten Personen wird dringend geraten, sich mit der Theorie und Praxis der Ersten Hilfe vertraut zu machen.

Beim Einbau und Betrieb dieser Ausrüstung müssen die örtlichen Gebäudesicherheits- und Brandschutzvorschriften beachtet werden. Vor dem Anschluss der Ausrüstung an die Stromversorgung der Anlage muss überprüft werden, ob der Schutzleiter intakt ist.

Wenn eine Beeinträchtigung des sicheren Betriebs wahrscheinlich ist, muss das Gerät außer Betrieb gesetzt und gegen ungewollten Betrieb gesichert werden. Dann muss der zuständige Kundendienst benachrichtigt werden. Eine Beeinträchtigung der Sicherheit ist zum Beispiel dann wahrscheinlich, wenn das Gerät nicht wie vorgesehen funktioniert oder einen sichtbaren Schaden aufweist.

Vorsicht!

Mit "Vorsicht" wird auf eine Gefahr hingewiesen, die korrekte Arbeits- oder Verfahrensweisen erfordert, um Tod oder Verletzung zu verhindern.

- An dieser Ausrüstung dürfen keine Änderungen vorgenommen werden;
- Die Montage dieser Ausrüstung darf nur von Fachpersonal vorgenommen werden;
- Es sollen nur von den Hersteller empfohlene Zubehöre verwendet werden;
- Bei Eintreten eines Notfalls unbedingt die Stromzufuhr abschalten;
- Ausrüstung so montieren, daß das Netzkabel zum Abschalten der Stromzufuhr zugänglich ist;
- Jede Unterbrechung des Schutzleiters innerhalb oder ausserhalb des Geräts oder Trennung der Schutzleiteranschlussklemme Könnte das Gerät gefährlich machen. Eine absichtliche Unterbrechung ist untersagt;
- Es dürfen nur Sicherungen des vorgeschriebenen Typs und Nennwerts verwendet werden;
- Um Feuer oder Schlaggefahr vorzubeugen, soll das Produkt nie an Regen oder Feucht ausgesetzt werden;
- Dieses Produkt enthält keine Anwenderteile. Reparatur und Wartung nur von qualifiziertem Fachpersonal vornehmen lassen oder nehmen Sie Kontakt auf mit Ihrem Grass Valley Vertretene;
- Beim Einbau und Betrieb dieser Ausrüstung müssen die örtlichen Gebäudesicherheits- und Brandschutzvorschriften beachtet werden;
- Vor dem Anschluss der Ausrüstung an die Stromversorgung der Anlage muss überprüft werden, ob der Schutzleiter intakt ist;
- Wenn eine Beeinträchtigung des sicheren Betriebs wahrscheinlich ist, muss das Gerät außer Betrieb gesetzt und gegen ungewollten Betrieb gesichert werden.

Achtung!

Mit "Achtung" werden Arbeitsanweisungen gekennzeichnet, die zu befolgen sind, um eine Beschädigung oder Zerstörung der Ausrüstung bzw. von Eigentum zu verhindern.

- Dieses Produkt darf nicht an extremen stöße oder Zittern ausgesetzt werden;
- Dieses Produkt darf nicht an extremen Temperaturen ausgesetzt werden;

- Um einer Überhitzungsgefahr vorzubeugen, ist das Produkt korrekt zu belüften;
- Das Produkt darf nur an eine Stromquelle mit der vorgeschriebenen Nennspannung angeschlossen werden.

Fiber optic transmission units



A yellow coloured CLASS 1 LASER PRODUCT label is located at the back side of the unit, near the hybrid fiber connector which is at the right side of the back panel.

Laser safety statement (Europe)

Fiber optic transmission units are classified as a "CLASS 1 Laser Product" according to EN 60825-1, Safety of Laser products. Class 1 laser products are considered safe and do not result in biological hazard if used according to the instructions.

Laser safety statement (US)

Fiber optic transmission units are classified as a "CLASS 1 Laser Product" according to 21CFR 1040.10 of the US Food and Drug Administration (FDA) Center for Devices and Radiological Health.



WARNING

Use of controls, adjustments or performance of procedures other than those specified herein may result in hazardous radiation exposure.

To ensure proper use of this product, please read this instruction manual carefully and retain for future reference. Should the unit ever require maintenance, contact an authorized service location.

Fiber optic cable precautions

Fiber optic cables and connectors are easily damaged; take the following precautions into account:

- Do not bend the cable beyond the minimum bend range specified for the cable.
- Avoid kinks or sharp bends in the cable.
- Avoid subjecting the cable to a high tension force.

- Do not twist the cable when connecting it to equipment.
- Insert connectors straight and fully into their corresponding sockets.
- In fiber optic cable systems always put the dust caps on cable and panel connectors immediately after disconnecting a cable. Keep the dust caps clean.

Installation information

Ventilation

Cold air is taken in from the right side and expelled on the left side (see drawing).

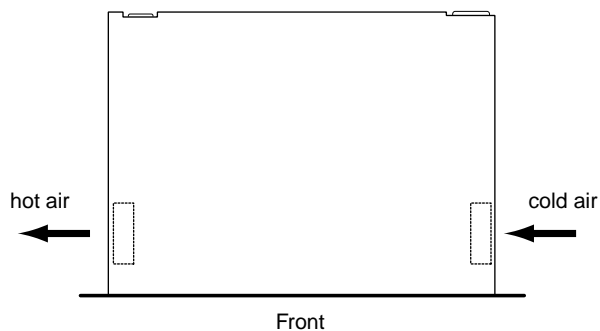

- Do not block the air inlet or outlet;
- Clean the air inlet grill at least once a year.

Rack mounting instructions

Note that rack mounting is not mandatory for the unit. When the unit is mounted in a 19" rack ensure that the following instructions are observed:

- The unit is supported at the rear;
- If installed in a closed or multi-rack assembly, the operating ambient temperature of the rack environment may be greater than room ambient. Therefore, consideration should be given to installing the equipment in an environment compatible with the maximum ambient temperature (T_{max}) specified;
- Installation of the equipment in a rack should be such that the amount of air flow required for safe operation of the equipment is not compromised;
- Mounting of the equipment in the rack should be such that a hazardous condition is not achieved due to uneven mechanical loading;
- Consideration should be given to the connection of the equipment to the supply circuit and the effect that overloading of the circuits might have on overcurrent protection and supply wiring. Appropriate consideration of equipment nameplate ratings should be used when addressing this concern;

- Reliable earthing of rack-mounted equipment should be maintained. Particular attention should be given to supply connections other than direct connections to the branch circuit (e.g. use of power strips).

Installation notices

For proper installation the following NEC articles should be noticed:

Regarding communication circuits:

- Installation of equipment (article 800.18).

Regarding radio and television equipment:

- Avoid contact with conductors of other systems (article 810.13);
- Provide extensive, separate clearance requirements for indoor and outdoor locations (article 810.18).

Mains power supply chord

General

By default, a mains power supply chord is not shipped with the device. To connect the LDK 4700 base unit to the mains the following power supply cord is advised: type H03 VV-F or H03 VVH2-F flexible wire: 1 mm², 250V / 10A minimum or 16 AWG.

When the device is installed in one of the following countries the power chord must be compliant to the indicated specifications and regulations indicated below:

For Denmark

Supply cord of single-phase equipment having a rated current not exceeding 10A shall be provided with a plug according to the Heavy Current Regulations section 107-2-D1. Class I equipment provided with socket-outlets with earth contact or which are intended to be used in locations where protection against indirect contact is required according to the wiring rules shall be provided with a plug in accordance with standard sheet DK 2-1a or DK 2-5a.

For Ireland

Apparatus which is fitted with a flexible cable or cord and is designed to be connected to a mains socket conforming to I.S. 411 by means of that flexible cable or cord and plug, shall be fitted with a 13A plug in accordance with Statutory Instrument 525:1997 - National Standards Authority of Ireland (section 28) (13A plugs and Conversion Adaptors for Domestic Use) Regulations, 1997.

For Spain

Supply cords of single-phase equipment having a rated current not exceeding:

- 10A shall be provided with a plug according to UNE 20315:1994

CLASS I EQUIPMENT provided with socket-outlets with earth contacts, or which are intended to be used in locations where protection against indirect contact is required

according to the wiring rules, shall be provided with a plug in accordance with UNE 20315:1994

For Switzerland

Supply cords of equipment having a rated current not exceeding 10A shall be provided with a plug complying with SEV 1011 or IEC 884-1 and the following dimension sheet:

- SEV 6534-2.1991 Plug Type 12: L+N+PE250V 10A

For the UK

Apparatus which is fitted with a flexible cable or a cord and is designed to be connected to a mains socket conforming to BS 1363 by means of that flexible cable or cord and plug, shall be fitted with a "standard plug" in accordance with Statutory Instrument 1786: 1994 - The Plugs and Sockets etc. (Safety) Regulations 1994, unless exempted by those regulations.

Note: "Standard plug" is defined in SI 1786:1994 and essentially means an approved plug conforming to BS 1363 or an approved conversion plug.

For the US

Listed, detachable, maximum 4.5 m (14.76 ft.) long; rated minimum 125V, 10A, type SJT or type SVT flexible cord; one end terminates in NEMA 5-15P or 5-20P grounding-type attachment plug, other end in appliance coupler.

Listed, detachable, maximum 4.5 m (14.76 ft.) long; rated minimum 250V, 10A, type SJT or type SVT flexible cord; one end terminates in NEMA 6-15P or NEMA 6-20P grounding-type attachment plug, other end in appliance coupler.

3.1 Specifications

The base unit is available in three versions:

- The LDK 4700/00 version has a 26-pin multicore connector for use with a multicore cable connection to the LDK 5481/10 DigiLink adapter;
- The LDK 4700/10 version has two SDI coax connectors and a DC power output to connect to the LDK 5481/10 DigiLink or LDK 5481/20 DigiLink fiber adapter using coaxial cables;
- The LDK 4700/20 version has a hybrid fiber connector to connect to the LDK 5481/20 DigiLink fiber adapter.

When ordering, you specify the version you require.

Item	Value
Power requirements	100 to 240 V _{AC} (-10% / +6%) 50 to 60 Hz
Power consumption	200 VA
Operating temperature	0 to +45°C (32 to +113°F)
Storage temperature	-20 to +60°C (-4 to +140°F)
Weight (approx.)	6 kg(13.2 lbs)
Dimensions	255 (L) x 483 (W) x 44 (H) mm (19-inch rack, 1 unit high)
Y, Pr, Pb output	1 Vpp; 75 Ohm; BNC
Audio output	XLR-3 male
CVBS output (x2)	1 Vpp; 75 Ohm; BNC
Teleprompter input	1 Vpp; 75 Ohm; BNC looped-through
Reference input	1 Vpp; 75 Ohm; BNC looped-through
External video signal input	1 Vpp; 75 Ohm; BNC looped-through
Control unit	D-sub 9-pin RS-422 connection for OCP 400
Intercom	2/4-wire via 15-pin male D-connector
Signalling	On-air, call via 15-pin male D-connector
Auxiliary data	Private data via 15-pin male D-connector
LDK 4700/00 version (multicore)	
DigiLink connection	26-pin multicore connector
LDK 4700/10 version (coax)	
Coaxial SDI connectors (x2)	SMPTE 259M, 0.8 Vpp, 270Mb/s; 75 Ohm; BNC
Auxiliary connection	12-pin Hirose connector
Power output	DC output; XLR-4 female
LDK 4700/20 version (fiber)	
DigiLink connection	Neutrik hybrid fiber optical connector

3.2 Dimensions

Figure 3-1. Digilink base unit dimension sketch

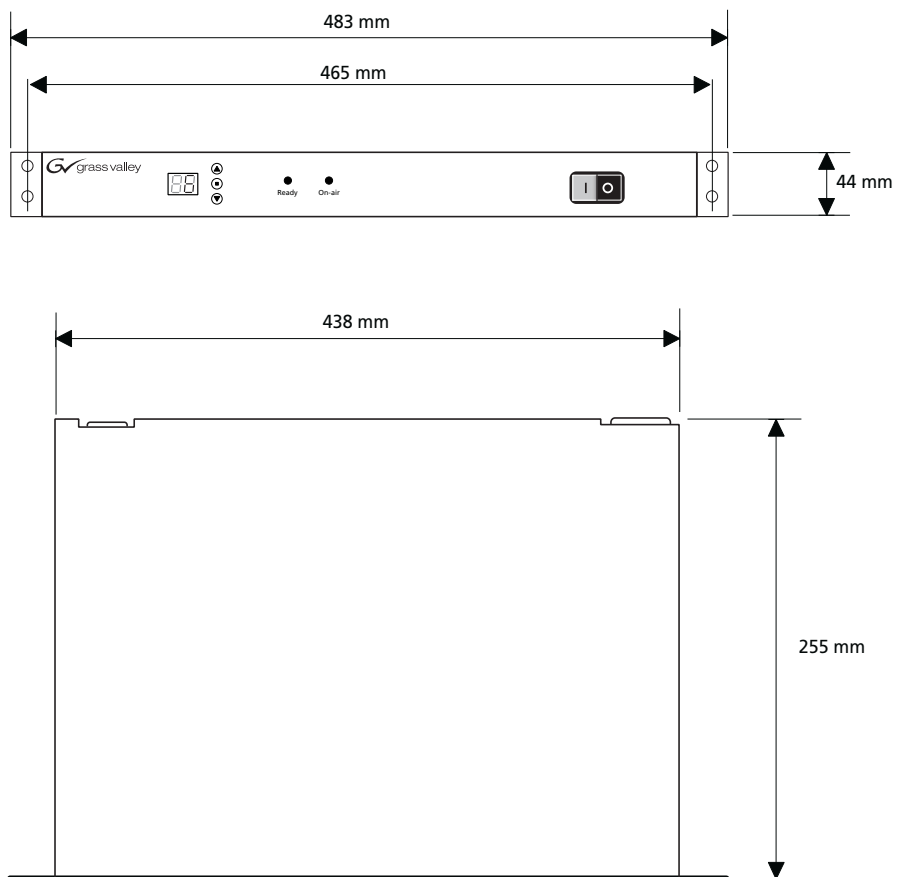

3.3 Controls and indicators

Figure 3-1. DigiLink base unit controls

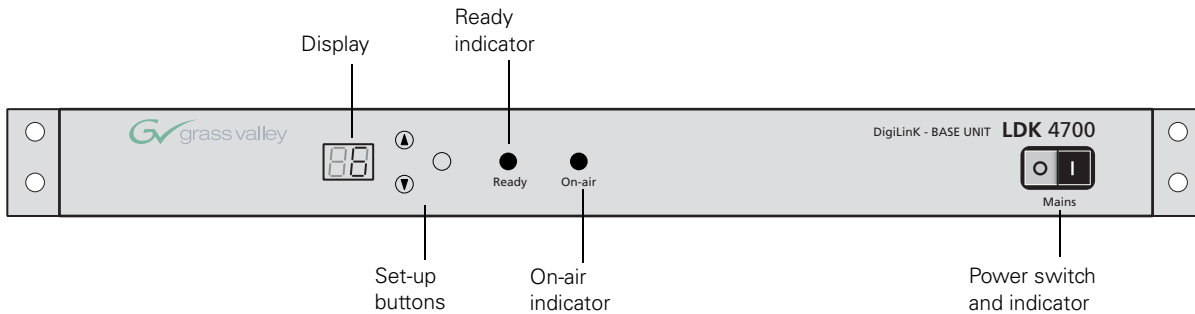

3.3.1 Powering the base unit

Set the power switch to the on position (I). The power on indicator in the switch lights when the unit is powered.

3.3.2 Indicators

Table 3-2. Ready indicator

indication	description
off	no camera video signal detected.
green (OK)	camera video signal detected.
flashing yellow	no camera video signal detected and power failure or fan failure.
flashing yellow/green	camera video signal detected and power failure or fan failure.



Table 3-3. On-Air indicator

indication	description
On	The camera is on air.
Off	The camera is not on air.

3.3.3 Set-up items

There are five items that can be accessed via the set-up buttons:

- Camera number (CA)
- Subcarrier adjustment (SC)
- H-phase (HP)
- Status (ST)
- Menu Off (OF)

Press the up  or down  button to display the required item. Press the select button  to select it. The display shows the abbreviation of the current item.

Camera Number (CA)

When CA is displayed, push the select button to enter the selection mode. Press the up or down button to select an available camera number. Push the select button to set the new camera number. The new camera number is shown in the display.

Subcarrier (SC)

When SC is displayed, push the select button to enter the Subcarrier adjustment mode. Press the up or down button to shift the Subcarrier phase. If you continue to press a button, the shift change occurs in bigger steps. Push the select button to leave the Subcarrier adjustment mode.

H-Phase (HP)

When HP is displayed, push the select button to enter the H-Phase adjustment mode. Press the up or down button to shift the H-Phase (this is the fine control and changes are not visible on the display). If you press the button continuously, the shift change occurs in bigger steps (this is the coarse control; changes are shown on the display). Push the select button to leave the H-Phase adjustment mode.

Status (ST)

When ST is displayed, push the select button to enter the status mode. Press the up or down button to select SO (the software status) or FI (the firmware status). Push the select button to view the status number. Push the select button to leave the status mode.

Menu Off (OF)

This is the inactivity state of the menu

OCP control

The set-up buttons can be used to set up the base unit, however, it is more convenient to use the OCP connected to the base unit. (Refer to the OCP user guide to find out how to do this.)

3.4 Connecting the studio signalling

Connect the studio signalling system to the rear of the base unit. The wiring of the panel connector is shown below. Refer to the next chapter for the location of this connector.

Figure 3-4. Signalling / Intercom / Auxiliary connector

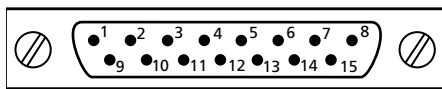

15-pin male D-connector; panel view

Panel part number: 2411 022 05292

A 4-wire (Off) or 2-wire (On) intercom system is selected with rocker switch number 1.

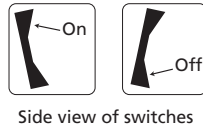
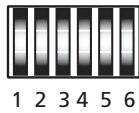

1. Intercom PROD Out (4-wire) or Intercom PROD In/Out (2-wire)
2. Call send (dry contact to pin 10)
3. n.c.
4. On Air send (dry contact to pin 12)
5. Intercom PROD In
6. Private data In
7. Private data Out
8. Housing
9. Camera microphone Out return
10. Call return
11. n.c.
12. On Air return
13. Intercom PROD In return (4-wire) or not connected (2-wire)
14. n.c.
15. Common ground

3.4.1 Call and On-air signals

There are two connection methods for the Call and On-air signalling functions:

1. Dry contact
2. Voltage level

The connection method for the signalling functions is set by a jumper on the main board of the base unit. Remove the upper lid of the base unit and locate jumper X317 at the bottom centre of the board. The settings of the jumper are shown below:

Figure 3-5. Jumper settings for signalling

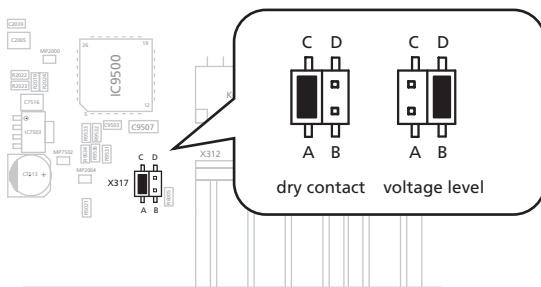

Dry contact signalling

Figure 3-6. Dry contact signalling

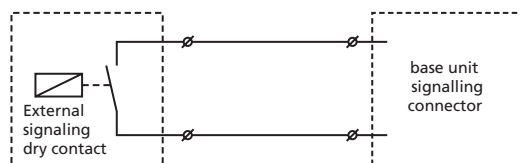

Voltage level signalling

Figure 3-7. Voltage level signalling

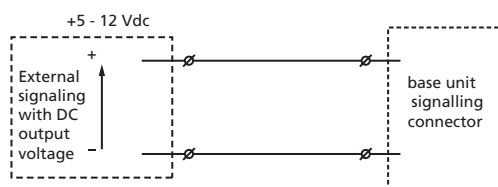

3.5 DigiLink base unit connectors

Figure 3-2. DigiLink base unit connector locations

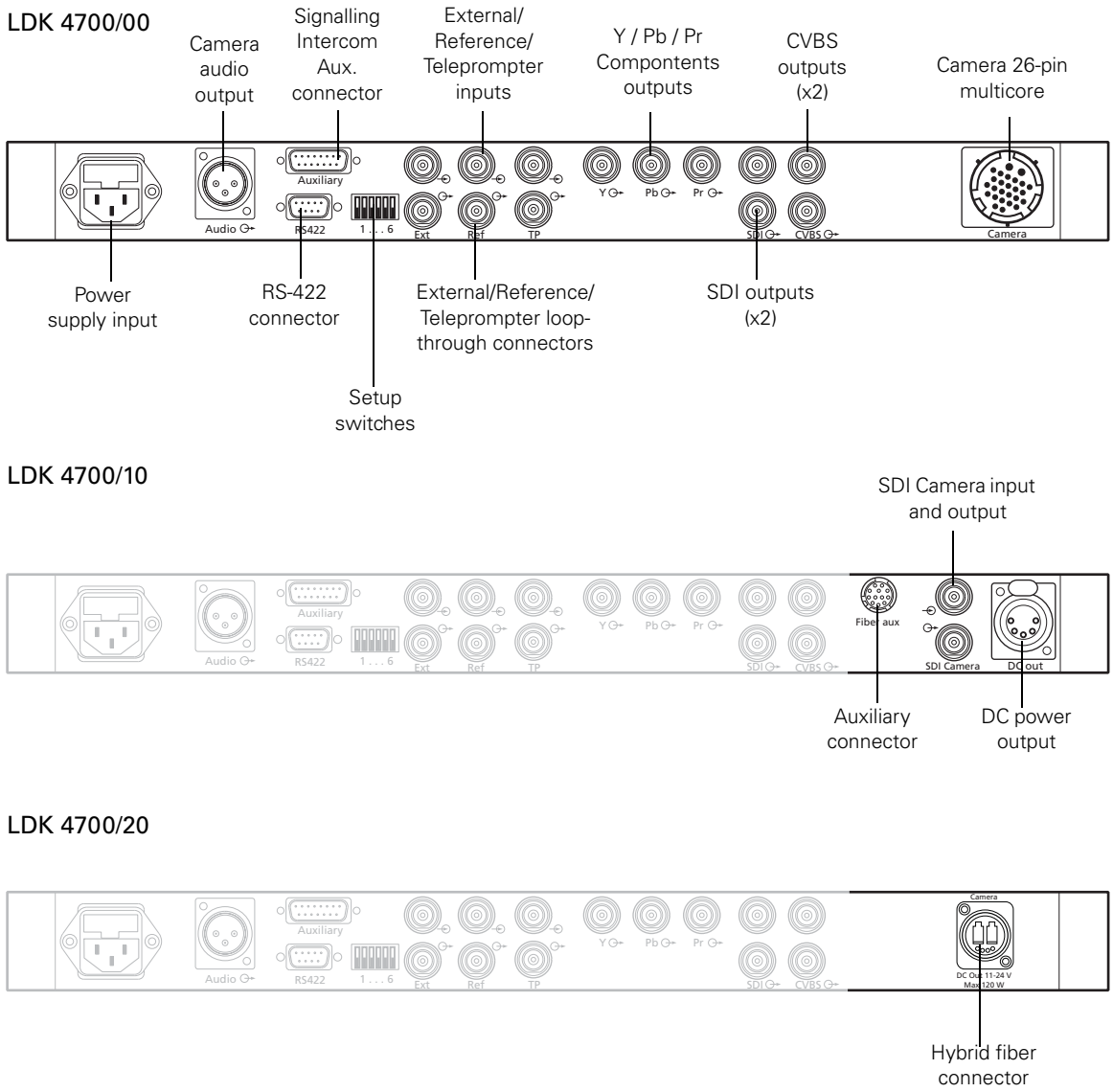

3.5.1 Setup switches

The rear of the base unit has six miniature rocker switches. The table below describes their function. Switch them On or Off as follows:

Figure 3-8. Dry contact signalling

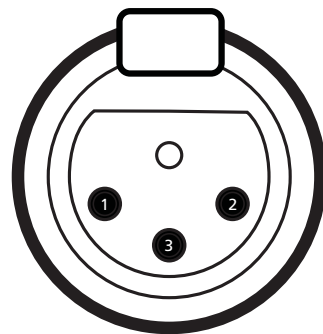

Table 3-9. Base unit setup switches

Switch	Function	On	Off (default)
1	Intercom system type	2-wire	4-wire
2	Video output	R, G, B	Y, Pr, Pb
3	(not used)		
4	(not used)		
5	(not used)		
6	Sub-D connector control	RS-232	RS-422

3.5.2 Audio out connector

Figure 3-10. Audio out connector



1. Audio Screen
2. Audio Out
3. Audio Return

Sensitivity range: -64 dBu to -22 dBu

Signal at pin 2 of audio output is in phase with signal at pin 2 of audio input.

XLR 3-pin male; panel view
Panel part number: 2422 026 02985

3.5.3 External video input connector

Figure 3-11. External video input connector

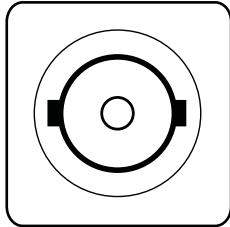

BNC connector: panel view

Apply a 1Vpp, 75 Ohm video signal to this BNC socket for viewing in the camera viewfinder (or via the VF/CVBS BNC output socket).

3.5.4 Reference input connector

Figure 3-12. Reference signal input connector

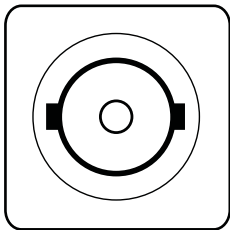

BNC connector: panel view

Apply a 1Vpp, 75 Ohm genlock signal- (CVBS or Black Burst) - to this BNC socket to synchronize the camera.

3.5.5 Teleprompter input connector

Figure 3-13. Teleprompter input connector

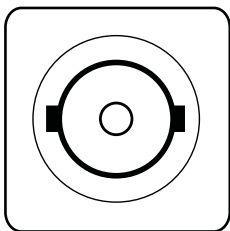

BNC connector: panel view

Apply a 1Vpp, 75 Ohm teleprompter video signal to this BNC socket for viewing on the camera VF output. (The signal output on the camera VF or CVBS output is selected in the camera menu system.)

3.5.6 Y, Pr, Pb output connectors

Figure 3-14. Y, Pr, Pb output connectors

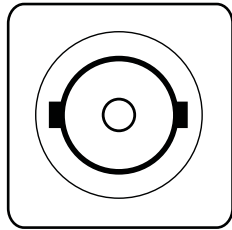

BNC connector: panel view

These BNC sockets provides 1 Vpp Y, Pr and Pb component video output signals from the camera.

These outputs can set to R, G and B with the rocker switch number 2 on the rear of the unit. Off is Y, Pr and Pb; On is R, G and B



1 2 3 4 5 6



Side view of switches

3.5.7 SDI Camera connectors

Figure 3-15. SDI Camera connectors

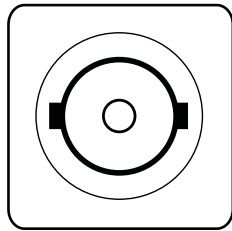

BNC connector: panel view

1. **SDI** (camera to base unit)
2. **SDI** (base unit to camera)

3.5.8 CVBS output connector

Figure 3-16. CVBS output connector

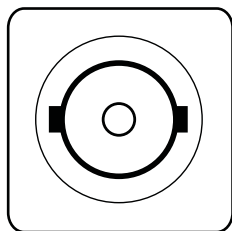

BNC connector: panel view

These two BNC sockets provide 1 Vpp CVBS analogue output video signals for viewing.

3.5.9 SDI video output connectors

Figure 3-17. SDI video output connectors

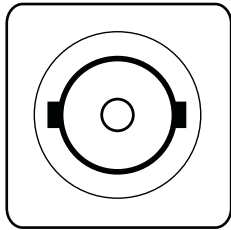

BNC connector: panel view

These two BNC connectors each supply an SDI video output (Y/Cr/Cb 4:2:2).

3.5.10 RS-232/RS-422 control connector

Figure 3-18. RS-232/RS-422 control connector

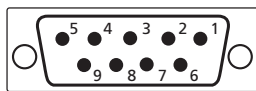

SubD 9-pin female; panel view (X369)

RS-232 (On) or RS-422 (Off) control protocol is selected with rocker switch number 6.

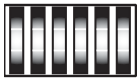

1 2 3 4 5 6



Side view of switches

RS-232 mode

1. nc
2. RXD
3. TXD
4. nDTR
5. DGND
6. nDSR
7. nRTS
8. nCTS
9. OCP Power

RS-422 mode

1. GND
2. nRX
3. TX
4. GND
5. GND
6. GND
7. RX
8. nTx
9. OCP Power

3.5.11 Mains power supply input socket

Figure 3-19. Mains power supply input socket

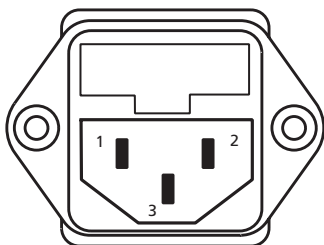

Euroconnector: panel view (X470)

1. Neutral
2. Phase
3. Earth

Mains input voltage: 100 - 240 V_{AC} (auto ranging)
Mains frequency: 50 to 60Hz

Fuses: T2.5 AH250V

Power consumption: 200W max.



WARNING

Use only 250V/10A power cables that conform to your local regulations.

3.5.12 Auxiliary connector

Figure 3-20. Auxiliary connector

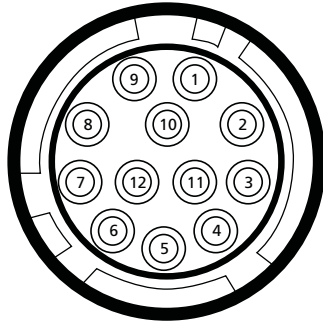

Hirose 12p type HR10A-10R-12SB
 service part: 2422 026 04355
 mating connector: Hirose HR10A-10P-12P

1. -
2. RS-232 RXD
3. RS-232 TXD
4. Private data (base unit to camera)
5. GND
6. -
7. Private data (camera to base unit)
8. -
9. + Batt
10. SDA
11. SCL
12. Housing

3.5.13 DC power output connector

Figure 3-21. DC power output connector

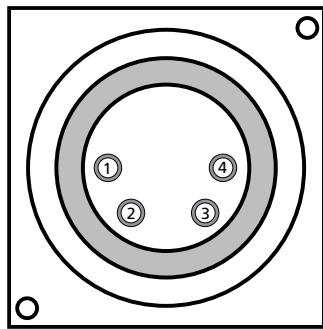

XLR 4-pin female: panel view

1. Power ground
2. -Batt sense
3. +Batt sense
4. +12 Vdc

Maximum power consumption 60W.

3.5.14 Multicore connector

Figure 3-22. Multicore connector

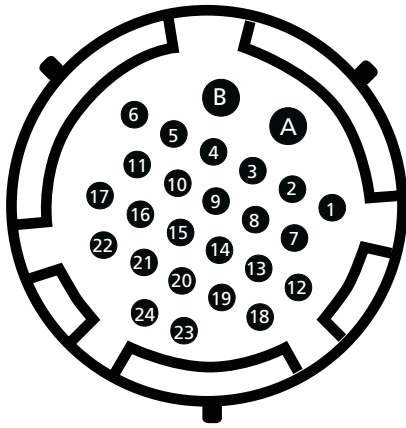

26-pin female; panel view
Panel part number: T1001017

A.+ Battery from VTR (+10.7 to +17V)

B.- Battery Ground

- 1. SDI
- 2. SDI Return
- 3. Y Return
- 4. Y signal

- 5. Pr: NTSC 700mV 75% saturated colour bar
Cr: PAL 525mV (EBU N10)
- 6. Pr/Cr Return
- 7. Pb: NTSC 700mV 75% saturated colour bar
Cb: PAL 525mV (EBU N10)
- 8. Pb/Cb Return
- 9. Cam. Mic. X
- 10. Cam. Mic. Y
- 11. Cam. Mic. shield
- 12. -
- 13. -
- 14. -
- 15. Record/Tally
- 16. Genlock Video/BB return
- 17. Cable shield (Camera GND to VTR GND)
- 18. Playback video / Ext. VF
- 19. Playback video return / Ext. VF return
- 20. -
- 21. Genlock Video/BB
- 22. -
- 23. RXD, control
- 24. TXD, control

3.5.15 Hybrid fiber connector

Figure 3-23. Hybrid fiber connector

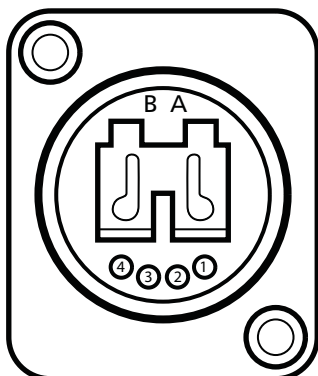

Neutrik OpticalCon® Hybrid Fiber
connector type: NO2-4FD-1-R

- A:** Fiber IN
- B:** Fiber OUT
- 1. Power GND
- 2. Power GND sense
- 3. Power + sense
- 4. Power +