

the Barista Touch™

Instruction Book - BES880



Breville®



Contents

- 2 Breville recommends safety first
- 8 Components
- 10 Features
- 11 Assembly
- 12 Functions
- 18 Tips
- 23 Care & Cleaning
- 27 Troubleshooting

BREVILLE RECOMMENDS SAFETY FIRST

At Breville we are very safety conscious. We design and manufacture consumer products with the safety of you, our valued customer, foremost in mind. In addition we ask that you exercise a degree of care when using any electrical appliance and adhere to the following precautions.

IMPORTANT SAFEGUARDS

READ ALL INSTRUCTIONS BEFORE USE AND SAVE FOR FUTURE REFERENCE

- Carefully read all instructions before operating and save for future reference.
- Remove any packaging material and promotional labels or stickers before using the Barista Touch™ for the first time.
- To eliminate a choking hazard for young children, remove and safely discard the protective cover fitted to the power plug of this appliance.
- Do not place the product near the edge of a bench or table during operation. Ensure the surface is level, clean and free of water and other substances.
- Do not use the product on a sink drain board.

- Do not let the cord hang over the edge of a bench or table, or become knotted. Keep away from hot gas or electric burner, or where it could touch a heated oven.
- This appliance can be used by children aged from 8 years and above if they have been given supervision or instruction concerning use of the appliance in a safe way and understand the hazards involved. Cleaning and user maintenance shall not be made by children unless they are aged from 8 years and above and supervised. Keep the appliance and its cord out of reach of children aged less than 8 years.
- Appliances can be used by persons with reduced physical, sensory or mental capabilities or lack of experience and knowledge if they have

- been given supervision or instruction concerning use of the appliance in a safe way and understand the hazards involved.
- Children shall not play with the appliance.
- Regularly inspect the supply cord, plug and actual appliance for any damage. If found damaged in any way, immediately cease use of the appliance and return the entire appliance to the nearest authorised Breville Service Centre for examination, replacement or repair.
- Keep the appliance and accessories clean. Follow the cleaning instructions provided in this book. Any procedure not listed in this instruction booklet should be performed at an authorised Breville Service Centre.

- The installation of a residual current device (safety switch) is recommended to provide additional safety protection when using electrical appliances. It is advisable that a safety switch with a rated residual operating current not exceeding 30mA be installed in the electrical circuit supplying the appliance. See your electrician for professional advice.
- Potential injury from misuse.
- Heating element surface is subject to residual heat after use.

SPECIFIC INSTRUCTIONS FOR BES880

- This appliance is recommended for household use only. Do not use this appliance for any purpose other than its intended use. Do not use in moving vehicles or boats. Do not use outdoors.
- If the appliance is to be:
 - left unattended
 - cleaned
 - moved
 - assembled; or
 - stored
- Always switch off the espresso machine by pressing the Power button to OFF, switch off at the power outlet and unplug.
- Ensure the product is properly assembled before first use.

- Do not use any other liquid apart from cold mains/town water. We do not recommend the use of highly filtered, de-mineralised or distilled water as this may affect the taste of the coffee and how the espresso machine is designed to function.
- Ensure the portafilter is firmly inserted and secured into the group head before starting an extraction. Never remove the portafilter during the extraction process.
- Do not touch hot surfaces. Allow the product to cool down before moving or cleaning any parts.
- Use caution after milk texturing as the 'Auto Purge' function may purge hot steam when the steam wand is lowered.
- Use caution when operating machine as metal surfaces are liable to get hot during use.
- Use caution when using the descale feature as hot steam may be released. Before descaling, ensure drip tray is empty and inserted. Refer to page 23 for further instructions.



WARNING

Do not immerse power cord, power plug or appliance in water or any other liquid.

SPECIFIC INSTRUCTIONS FOR WATER FILTER

- Filter cartridge should be kept out of reach of children.
- Store filter cartridges in a dry place in the original packaging.
- Protect cartridges from heat and direct sunlight.
- Do not use damaged filter cartridges.
- Do not open filter cartridges.
- If you are absent for a prolonged period of time, empty the water tank and replace the cartridge.

SAVE THESE INSTRUCTIONS



Components

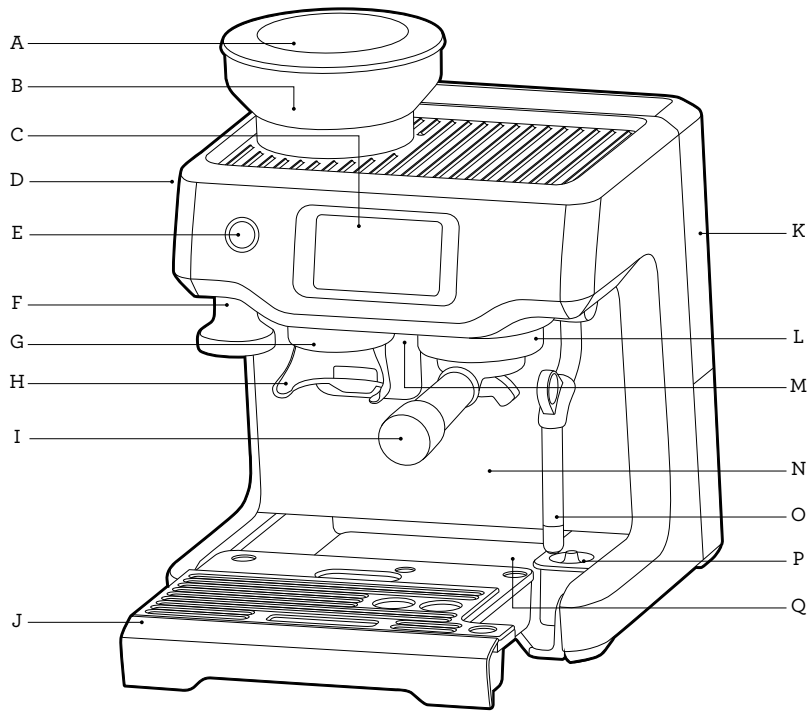

- A. 250g bean hopper
With locking system for easy removal, storage and transfer of coffee beans.
- B. Integrated conical burr grinder
- C. Touch screen control panel
Displays current settings and provides touch interface.
- D. GRIND SIZE selector
Espresso grind settings from fine to coarse.
- E. POWER button
- F. Integrated removable 54mm tamper
- G. Grind outlet
- H. Hands free grinding cradle
- I. 54mm stainless steel portafilter
With commercial style spouts.
- J. Removable wet & dry coffee separator drip tray
With Empty Me! tray full indicator.
- K. 2L removable water tank
With replaceable water filter to reduce impurities and scale.
- L. Group Head
- M. Dedicated hot water outlet
- N. Extra-tall cup clearance for tall mugs
- O. Easy clean steam wand
For automatic milk texturing.
- P. Milk temperature sensor
- Q. Storage tray (located behind drip tray)
Houses accessories when not in use.

All parts of the Barista Touch™ that come into contact with coffee, water and milk are BPA Free.

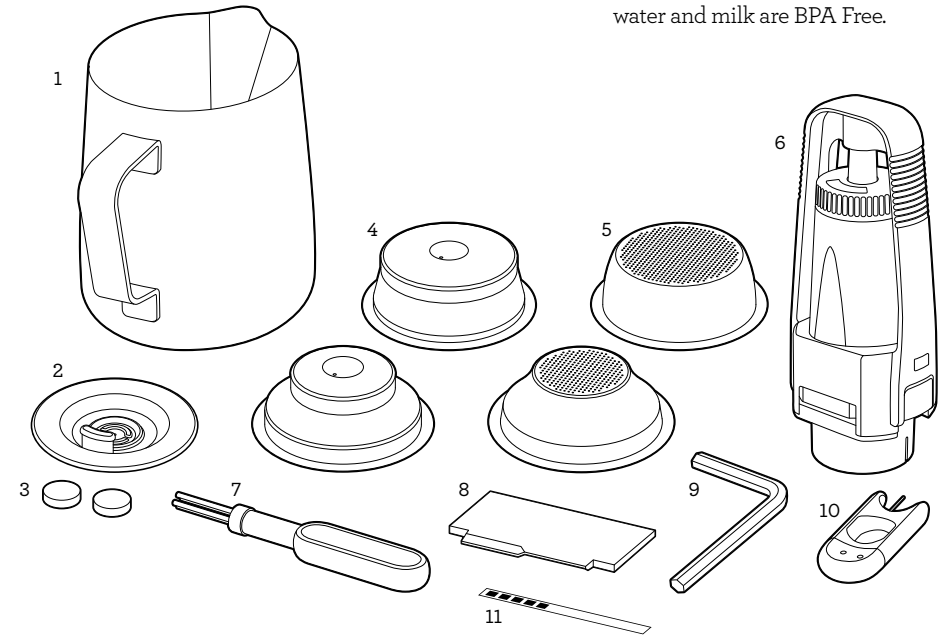

ACCESSORIES

- 1. Stainless steel milk jug
- 2. Cleaning disc
- 3. Cleaning tablets
- 4. Dual Wall filter baskets (1 cup & 2 cup)
Use with pre-ground coffee.
- 5. Single Wall filter baskets (1 cup & 2 cup)
Use when grinding fresh whole coffee beans.
- 6. Water filter and holder
- 7. Cleaning brush
- 8. The Razor™ precision dose trimming tool
- 9. Allen key
To disassemble shower screen (see page 26).
- 10. Steam wand cleaning tool
- 11. Water hardness test strip

Barista Touch Features

COLOUR TOUCH SCREEN CONTROL PANEL

Swipe & Select from the drinks menu. Adjust your shot volume, milk texture or milk temperature, then save it as your personal favourite.

AUTOMATIC HANDS FREE MILK TEXTURING

Automatically textures milk to the selected temperature and style from silky smooth latté to creamy cappuccino. Automatic purge removes residual milk from the steam wand when returned to the downward position.

RAPID HEAT UP

Innovative heating system achieves ideal extraction temperature in 3 seconds.

INTEGRATED CONICAL BURR GRINDER

Stainless steel conical burrs maximise ground coffee surface area for a full espresso flavour. Upper and lower burrs are removable for cleaning.

ADJUSTABLE GRIND SIZE

Espresso grind settings from fine to coarse for optimal extraction.

ADJUSTABLE GRIND AMOUNT

Adjust the amount of fresh ground coffee dosed into the filter basket to suit the fineness or coarseness of the grind.

AUTOMATIC DOSING

Use the FILTER SIZE button to tell the machine if you are using a 1 CUP or 2 CUP filter basket. The grinder will dispense the required amount of ground coffee for a single or double cup dose.

HANDS FREE GRINDING

Auto stop for hands free grinding directly into the portafilter.

THE RAZOR™ DOSE TRIMMING TOOL

Patented twist blade trims down the puck to the right level for precision dosing and a consistent extraction.

ADJUSTABLE TEMPERATURE CONTROL

For optimum coffee flavour.

PID TEMPERATURE CONTROL

Electronic PID temperature control for increased temperature stability.

INSTANT HOT WATER

Dedicated hot water outlet for making Long Blacks and pre-heating cups.

LOW PRESSURE PRE-INFUSION

Applies low water pressure at the start of the extraction to gently expand grinds for an even extraction.

VOLUMETRIC CONTROL

Preset 1 & 2 cup volumes, manual over-ride or programmable shot volumes.

DRY PUCK FEATURE

Removes excess water from the ground coffee in the filter basket after extraction for easy disposal of the coffee puck.

Assembly

BEFORE FIRST USE

Machine Preparation

Remove and discard all labels and packaging materials attached to your espresso machine. Ensure you have removed all parts and accessories before discarding the packaging.

Remove the packaging and the plastics bags containing the water filter and water filter holder. Clean parts and accessories (water tank, portafilter, filter basket, jug) using warm water and a gentle dish washing liquid. Rinse well then dry thoroughly.

INSTALLING THE WATER FILTER

- Remove the water filter and water filter holder from the plastic bag.
- Soak the filter in cold water for 5 minutes.
- Wash the filter holder with cold water.

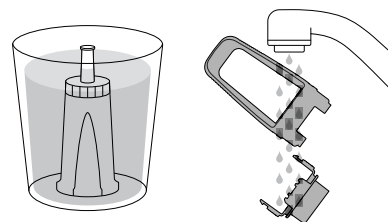

- Set the reminder for next month of replacement. We recommend to replace the filter after 3 months.

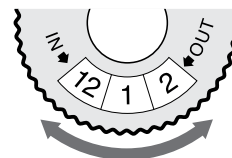

- Insert the filter into the two parts of the filter holder.
- To install the assembled filter holder into the water tank, align the base of the filter holder with the adapter inside the water tank. Push down to lock into place.

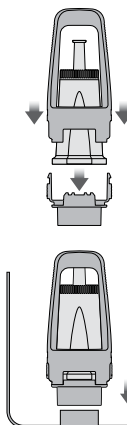

- Fill the water tank with cold water before sliding back into position at the back of the machine and locking into place.

NOTE

Replacing the water filter after three months or 40L will reduce the need to descale the machine. Filter can be purchased at Breville webpage.

NOTE

DO NOT use highly filtered, demineralised or distilled water in this machine. This may affect the taste of the coffee.

Functions

FIRST USE

1. Press POWER button to turn the machine on.
2. Follow the instructions on screen to guide you through first use setup.
3. After completing setup, the machine will tell that it is ready to use.

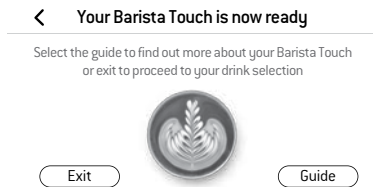

The machine is now in STANDBY mode.

4. Touch "Guide" and the machine will guide you step by step to make your first coffee. Touch the ✓ and go to the Drinks Menu or < to repeat the Setup. To repeat the Guide at any time, go to Settings Menu.

NOTE

If your water hardness is either 4 or 5 when tested, we strongly recommend you to change to an alternate water source.

Filtered, bottled spring or mineral water will extend both the life of your built-in filter and descale intervals as well as superior taste. Please ensure to test the water hardness of the alternative water source you've chosen and input into the machine accordingly. Avoid using overly filtered water, like RO water unless some mineral content is being added back to the final water. Never use distilled water, or water with no or low mineral content as this will affect both the taste.

GRINDING OPERATION

Insert bean hopper into position on-top of the machine. Turn dial to lock into place. Fill hopper with fresh beans.

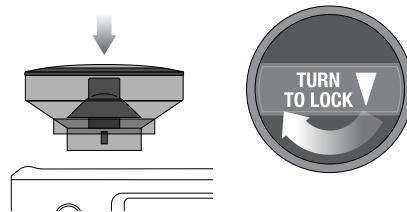

TIP

We recommend quality 100% Arabica beans with a 'Roasted On' date stamped on the bag, not a 'Best Before' or 'Use By' date. Coffee beans are best consumed between 5-20 days after the 'Roasted On' date. Stale coffee may pour too quickly from the portafilter spouts and taste bitter and watery.

DRINK SELECTION

To enter Drinks Menu screen, touch the Home icon . Swipe & select your drink. Touch the 'Help & Tip' icon to see Barista Touch™ Guide.



NOTE

Please keep the touch screen dry and clean to ensure that the machine functions properly.

DRINK SCREEN

In this screen, you can customise your drink by touching the oval shaped buttons. You cannot adjust the Grind Size by touching the button, use the dial on the side of the machine.

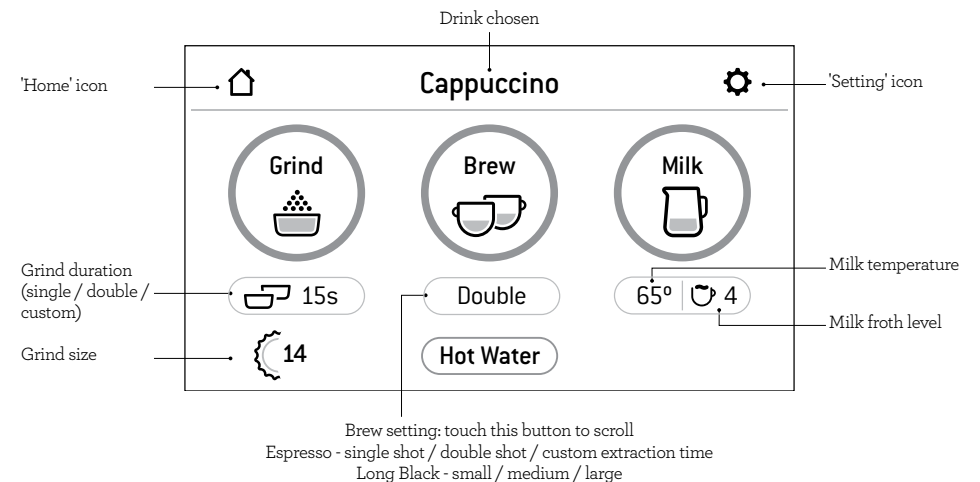

SETTING GRIND SIZE

Selecting Your Filter Basket

Choose and insert the Filter Basket into the Portafilter for the number of coffees or strength you are making. Use the Single Cup Filter Basket for making a single cup or a weaker tasting espresso. Use the Double Cup Filter Basket for making 2 cups or a stronger tasting espresso, usually for mugs or larger cups. See 'TIPS' for more detailed guide.

In the touchscreen, select the chosen filter basket by touching the toggle option under the 'Grind' button.

The grind size will affect the rate of water flow through the coffee in the filter basket and the flavour of the espresso. When setting the grind size, it should be fine but not too fine and powdery. When trying a new coffee, it may take 2 or 3 tries to identify the correct grind size for your coffee.

There are numbered settings on the touchscreen. The smaller the number, the finer the grind size. The larger the number, the coarser the grind size.

Automatic Dosing

- Ensure the hopper is locked into position and is filled with fresh coffee beans.
- Ensure the filter basket is completely dry before placing the portafilter into the grinding cradle.
- Touch the 'Grind' button once, or push and release the portafilter to engage the grinding activation switch. Then allow fresh ground coffee to fill the portafilter.
- Grinding will automatically stop, however if you wish to stop grinding before the cycle has finished, push and release the portafilter.

NOTE

It is normal for the portafilter to appear overfilled with ground coffee.

Manual Dosing

- If you prefer to manually dose, with the portafilter inserted in the grinding cradle, push and hold the portafilter to engage the grinding activation switch. Continue holding until the desired amount of ground coffee has been dosed.
- To stop grinding, release the portafilter. This will release the grinding activation switch and stop the grinding function.

Tamping the Ground Coffee

- Once grinding is complete, carefully withdraw the portafilter from the grinding cradle.
- Tap the portafilter several times to collapse and distribute the coffee evenly in the filter basket.
- Tamp down firmly using approx. 15–20kgs of pressure. The amount of pressure is not as important as consistent pressure every time.
- As a guide to dose, the top edge of the metal cap on the tamper should be level with the top of the filter basket AFTER the coffee has been tamped.

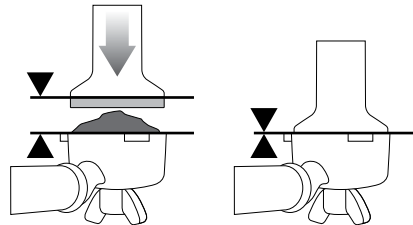

Trimming the Dose

The Razor™ precision dose trimming tool allows you to trim the puck to the right level for a consistent extraction.

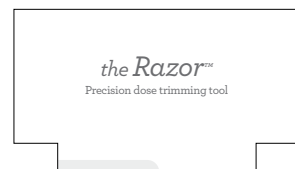

- Insert the Razor™ dose trimming tool into the filter basket until the shoulders of the tool rest on the rim of the basket. The blade of the dose trimming tool should penetrate the surface of the tamped coffee.
- Rotate the Razor™ dose trimming tool back and forth while holding the portafilter on an angle over a knock box to trim off excess coffee grinds. Your filter basket is now dosed with the correct amount of coffee.

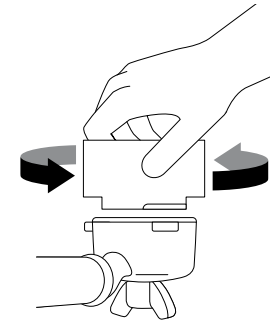

- Wipe excess coffee from the rim of the filter basket to ensure a proper seal is achieved in the group head.

Purging the Group Head

Before placing the portafilter into the group head, run a short flow of water through the group head by touching the 'Hot Water' button. This will stabilise the temperature prior to extraction.

Inserting the Portafilter

Place the portafilter underneath the group head so that the handle is aligned with the INSERT position. Insert the portafilter into the group head and rotate the handle towards the center until resistance is felt.

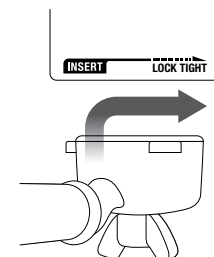

ESPRESSO EXTRACTION

Touch the 'Brew' button on the display to start extraction. You can switch between single shot, double shot or Custom by touching the 'Single', 'Double' or Custom button. The duration times are preset, but can be customised.

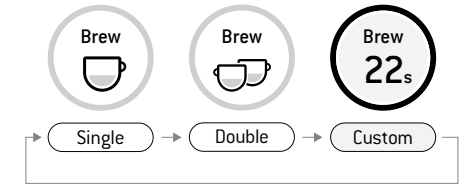

MANUAL OVERRIDE

Press and hold the 'Brew' button (approx 2secs) to enter manual extraction mode. Touch the Brew button to start the extraction, touch the Brew button to stop the extraction.

NOTE

- The amount of espresso extracted in the cup will vary depending on your grind size and grind amount settings.
- Touching the 'Brew' button during a preset shot volume will immediately stop the extraction.
- For optimal flavour when using a 1 CUP filter basket, you should extract approx. 30ml. When using a 2 CUP filter basket, you should extract approx. 60ml.

TEXTURING MILK

Different brands and types of milk and milk alternatives will texture differently. You may need to adjust the froth level accordingly. Start with fresh cold milk. Fill milk jug to below the spout position. Lift steam wand and insert into milk jug. Lower steam wand, ensuring it is fully down. The milk jug should rest on the milk temperature sensor located on the drip tray and milk should cover the ring around steam wand tip. The toggle button under the 'Milk' button will show you whether you placed the milk jug correctly.

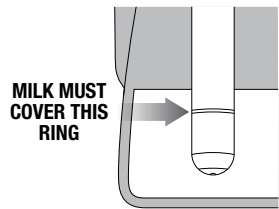
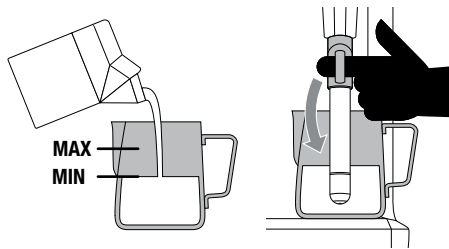

NOTE

Use the indicator on the screen for the correct milk jug position.

Under the 'Milk' button, temperature level and froth level are displayed. They are preset based on the drink you've chosen but you can customise by touching those options.

To start, touch the 'Milk' button. The screen will display the temperature of the milk as it heats. Milk texturing will stop automatically when the selected milk temperature is reached.

Lift steam wand to remove milk jug. Wipe the wand & tip with a clean damp cloth. Lower steam wand to the down position and the wand will automatically purge.

NOTE

Prior to texturing milk, it is recommended to momentarily purge the steam wand by first touching the 'Milk' button. Touching the button again will stop steam delivery.

MANUAL MILK TEXTURING

Auto milk texturing and auto shut-off are disabled during manual milk texturing mode. Lift the steam wand. Start frothing by touching the button. When frothing is done, touch the Milk button to stop.

Wipe the wand & tip with a clean damp cloth. Lower steam wand to the down position and the wand will automatically purge.

CAUTION: BURN HAZARD

Pressurised steam can still be released, even after machine has been switched off.

Children must always be supervised.

NOTE

- When the machine creates steam, a pumping noise can be heard. This is the normal operation of the Italian pump.
- After 90 seconds of continuous steaming, the machine will automatically disable the steam function.
- Use exclusively the stainless steel milk jug included in the pack to froth milk. The use of container made of glass or plastic material to froth milk may lead to dangerous conditions.

LONG BLACK

There are 3 preset Long Black settings – Small (180ml), Medium (240ml), and Large (360ml). Grind dose & tamp your portafilter & insert into the group head. Position your cup underneath the portafilter spouts & the hot water spout. The hot water is delivered first, and espresso will be extracted after that.

HOT WATER

The HOT WATER function can be used to pre-heat cups or add hot water manually.

To start & stop hot water, touch 'Hot Water' on the screen.

Hot water limit is approximately 90 seconds. Depending on the size of your cup, you may need to touch the 'Hot Water' button to stop pouring.

NOTE

You cannot run hot water and extract espresso at the same time.

ADDING NEW DRINK

Touch 'Add New' in the menu screen to create a customised drink. You can adjust parameters based on a standard style and save your own.



Add New

Alternatively, after manually adjusting parameters touch the small icon  to save the current setting.

TIPS

Ensure the drip tray is firmly pushed in place and emptied whenever the Empty Me! indicator is displayed.

AUTO OFF MODE

The machine automatically switches to AUTO OFF mode after 30 minutes.

SETTINGS

To enter settings menu, touch the icon  on the upper right of the screen.

Quick Start Guide

Machine will guide you on screen, step by step to make an actual coffee.

Clean Cycle

The Cleaning Cycle cleans the shower screen and back-flushes the group head.

Cleaning Steam Wand

This will show how to clean the steam wand to remove any blockage for better steaming performance.

Descale Cycle

Descaling prevents excess mineral and scale build-up. A pop-up message will let you know when it is time for descaling.

Brew Temperature

It allows you to adjust the recommended extraction temperature.

Default Milk Temperature

It allows you to adjust default temperature level on all milk base drinks.

Water Hardness

It is to test water to set how often you need to descale the machine.

Screen Brightness

You can adjust brightness of your touch screen.

Sound Volume

You can adjust volume for alerts and reminders.

Demo Mode

It is for on-screen Barista Touch™ demonstration sequence.

Factory Reset

Use this function to reset all programmable values back to the factory settings and delete all custom drinks.



Tips

PRE-HEATING

Heating your cup or glass

A warm cup will help maintain the coffee's optimal temperature. Pre-heat your cup by rinsing with hot water from the hot water outlet and place on the cup warming tray.

Heating the portafilter and filter basket

A cold portafilter and filter basket can reduce the extraction temperature enough to significantly affect the quality of your espresso. Always ensure the portafilter and filter basket are pre-heated with hot water from the hot water outlet before initial use.



NOTE

Always wipe the portafilter and filter basket dry before dosing with ground coffee as moisture can encourage 'channeling' where water by-passes the ground coffee during extraction.

SELECTING A FILTER BASKET

Single Wall Filter Baskets

Use Single Wall filter baskets if grinding fresh whole coffee beans.

Single Wall filter baskets allow you to experiment with grind, dose and tamp to create a more balanced espresso.

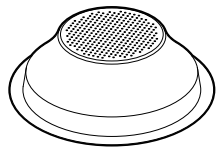

1 CUP

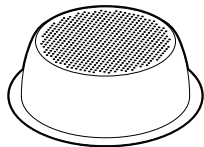

2 CUP

Dual Wall Filter Baskets

Use Dual Wall filter baskets if using pre-ground coffee.

Dual Wall filter baskets regulate the pressure and help to optimise the extraction regardless of the grind, dose, tamp pressure or freshness.

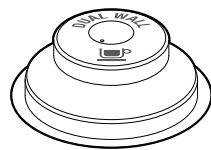

1 CUP



2 CUP



NOTE

- Regardless of whether you use Single Wall or Dual Wall filter baskets, use the 1 CUP basket when brewing a single cup and the 2 CUP basket when brewing two cups or a stronger single cup or mug.
- You will need to adjust the grind amount and size if switching from a single basket to a double basket, or vice versa.

The provided filter baskets are designed for:

1 CUP basket = approx. 8-10g.

2 CUP basket = approx. 15-18g.



NOTE

You may need to experiment with how much coffee is dosed into the filter basket or how long the grinder needs to run to achieve the correct dose. For example, when using a finer espresso grind with the Single Wall filter baskets, you may need to increase the grind amount to ensure the filter basket is correctly dosed.

THE GRIND

If grinding coffee beans, the grind size should be fine but not too fine. The grind size will affect the rate at which the water flows through the ground coffee in the filter basket and the taste of the espresso.

If the grind is too fine (looks like powder and feels like flour when rubbed between fingers), the water will not flow through the coffee even when under pressure. The resulting espresso will be **OVER EXTRACTED**, dark in color and bitter in flavour.

If the grind is too coarse the water will flow through the ground coffee in the filter basket too quickly. The resulting espresso will be **UNDER EXTRACTED** and lacking in colour and flavour.







EXTRACTING ESPRESSO

- Place pre-warmed cup(s) beneath the portafilter and touch the 'Brew' button for the desired volume.
- Due to pre-infusion time, the espresso will not start to flow immediately.

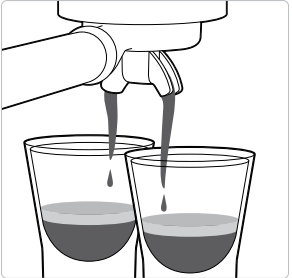
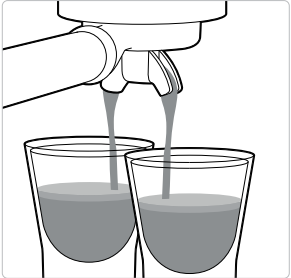
A great espresso is about achieving the perfect balance between sweetness, acidity and bitterness. The flavour of your coffee will depend on many factors, such as the type of coffee beans, degree of roast, freshness, coarseness or fineness of the grind, dose of ground coffee, and tamping pressure.

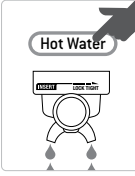
Experiment by adjusting these factors just one at a time to achieve the taste of your preference.

EXTRACTION GUIDE

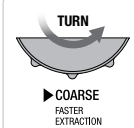
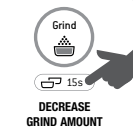
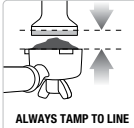
CORRECT EXTRACTION	UNDER EXTRACTION	OVER EXTRACTION
 <ul style="list-style-type: none"> Flow starts after 8-12 secs Flow slow like warm honey Crema is golden brown with a fine mousse texture Espresso is dark brown 	 <ul style="list-style-type: none"> Flow starts after 1-7 secs Flow fast like water Crema is thin and pale Espresso is pale brown Tastes bitter/sharp, weak and watery 	 <ul style="list-style-type: none"> Flow starts after 13 secs Flow drips or not at all Crema is dark and spotty Espresso is very dark brown Tastes bitter and burnt
<p>AFTER EXTRACTION</p> <p>REMOVE USED GRINDS Used grinds will form a coffee 'puck'. If the puck is wet, refer to the 'Under Extraction' section.</p>  <p>RINSE FILTER BASKET Keep the filter basket clean to prevent blockages. Without ground coffee in the filter basket, lock the portafilter into the machine and run hot water through.</p> 	<p>SOLUTIONS</p> <div style="display: flex; justify-content: space-around;"> <div style="text-align: center;">  <p>FINE SLOWER EXTRACTION</p> <p>Adjust & re-test</p> </div> <div style="text-align: center;">  <p>INCREASE GRIND AMOUNT</p> <p>Adjust & re-test</p> </div> </div> <div style="text-align: center;">  <p>ALWAYS TAMP TO LINE</p> <p>Adjust & re-test</p> </div> <p>Tamp using 15-20kgs of pressure. The top edge of metal cap on the tamper should be level with the top of the filter basket AFTER tamping. Trim the puck to the right level using the Razor™ precision dose trimming tool.</p>	<p>SOLUTIONS</p> <div style="display: flex; justify-content: space-around;"> <div style="text-align: center;">  <p>COARSE FASTER EXTRACTION</p> <p>Adjust & re-test</p> </div> <div style="text-align: center;">  <p>DECREASE GRIND AMOUNT</p> <p>Adjust & re-test</p> </div> </div> <div style="text-align: center;">  <p>ALWAYS TAMP TO LINE</p> <p>Adjust & re-test</p> </div> <p>Tamp using 15-20kgs of pressure. The top edge of metal cap on the tamper should be level with the top of the filter basket AFTER tamping. Trim the puck to the right level using the Razor™ precision dose trimming tool.</p>

	GRIND	GRIND DOSE	TAMP
OVER EXTRATED BITTER • ASTRINGENT	Too fine	Too much Use razor to trim	Too heavy
BALANCED	Optimum	8-10g (1 cup) 15-18g (2 cup)	15-20kg
UNDER EXTRACTED UNDERDEVELOPED • SOUR	Too coarse	Too little Increase dose & use razor to trim	Too light

HINTS & TIPS

- Fresh, quality coffee beans will give you the best possible extraction.
- We recommend quality 100% Arabica beans with a 'Roasted On' date stamped on the bag, not a 'Best Before' or 'Use By' date.
- Coffee beans are best consumed between 5-20 days after the 'Roasted On' date. Ideally only grind directly before the extraction to maximise flavour.
- Buy coffee beans in small batches to reduce the storage time.
- Store coffee beans in a cool, dark and dry container. Vacuum seal if possible.

TEXTURING MILK

There are two phases to texturing milk. The first is stretching the milk to aerate it and the second is swirling the milk to make it silky smooth. These two operations should blend into one.

- Always start with fresh cold milk.
- Fill milk jug to below the spout position. At a minimum, there should be enough milk to cover the ring around steam wand.
- To remove any condensed water from the system, ensure the steam wand is in the down position over the drip tray then touch the Milk button, allow steam to flow for a few seconds, then touch the Milk button to stop.
- When texturing milk automatically, ensure the steam wand is fully down.

HINTS & TIPS

For optimum milk texturing performance it is critical that the holes around the steam tip are clear. Even partially blocked holes may affect the ability of the steam wand to produce sufficient foam.

Always wipe the wand and tip with a damp cloth BEFORE returning the wand to the down position. Wiping the wand will remove the majority of milk and allow the automatic purge feature to more effectively remove any residual milk.

After texturing is complete

- Tap the jug on the counter-top to collapse any bubbles.
- Swirl the jug to polish and re-integrate the texture.
- Pour milk directly into the espresso.
- The key is to work quickly, before the milk begins to separate.

For manual texturing

- Lift the steam wand and insert the steam tip 1-2 cm below the surface of the milk close to the right hand side of the jug at the 3 o'clock position. Then start frothing by touching the button once again.
- Keep the tip just under the surface of the milk until the milk is spinning clockwise, producing a vortex (whirlpool effect).
- With the milk spinning, slowly lower the jug. This will bring the steam tip to the surface of the milk & start to introduce air into the milk. You may have to gently break the surface of the milk with the tip to get the milk spinning fast enough.
- Keep the tip at or slightly below the surface, continuing to maintain the vortex. Texture the milk until sufficient volume is obtained.
- Lift the handle of the jug to lower the tip beneath the surface, but keep the vortex of milk spinning. Use the touch screen to monitor the milk temperature. We recommend 55°C-65°C.
- Touch the Milk button to stop steaming BEFORE lowering the jug and taking the tip out of the milk.

ADJUSTING CONICAL BURRS

Some types of coffee may require a wider grind range to achieve an ideal extraction or brew. A feature of your Barista Touch™ is the ability to extend this range with an adjustable upper burr. We recommend making only one adjustment at a time.

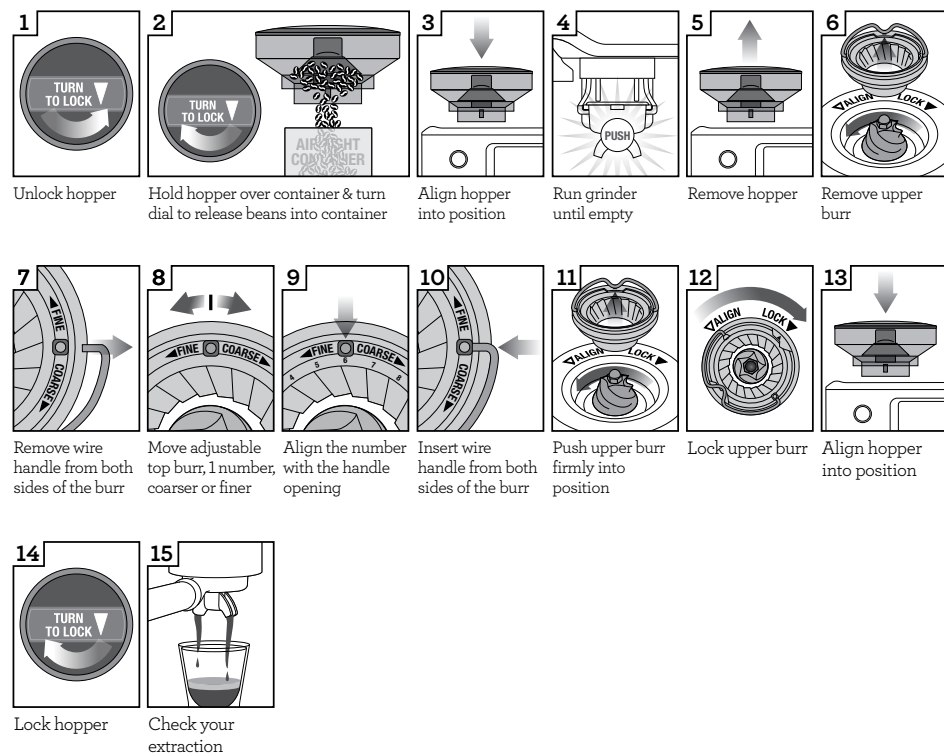

Care & Cleaning

COLOUR TOUCH SCREEN DISPLAY

Please keep the touch screen dry and clean to ensure that the machine functions properly.

REPLACING THE WATER FILTER

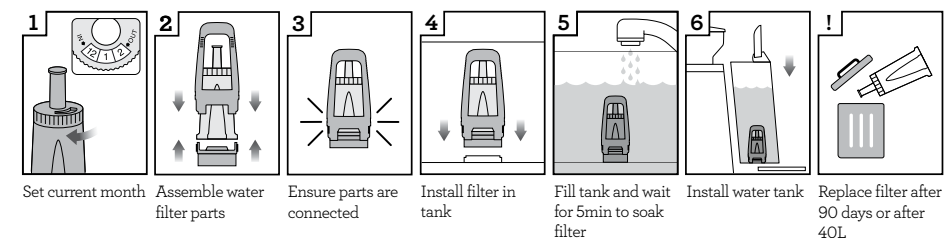

The provided water filter helps prevent scale build-up in and on many of the inner functioning components. Replacing the water filter after three months or 40L will reduce the need to descale the machine.

The limitation of 40L is based on water hardness level 4. If you are in level 2 area, you can increase this to 60L.



NOTE

To purchase water filters visit Breville webpage.

CLEANING CYCLE

There will be a message prompt when a cleaning cycle is required. This is a back-flushing cycle and is separate from descaling. Follow the instruction on the screen.

DESCALING

After regular use, hard water can cause mineral build up in and on many of the inner functioning components, reducing the brewing flow, brewing temperature, power of the machine, and taste of the espresso. Even if you used the provided water filter, we recommend you to descale if there is scale build-up in the water tank.

Go to 'Settings' and select 'Descal cycle'. Follow the instructions on the screen.



WARNING

Do not immerse power cord, power plug or appliance in water or any other liquid. The water tank should never be removed or completely emptied during descaling.

CLEANING THE CONICAL BURR GRINDER

This grinder cleaning cycle removes oil build-up on the burrs which can impede performance.

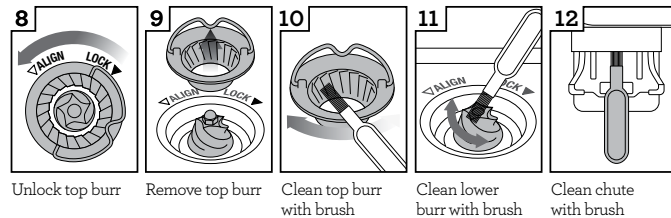
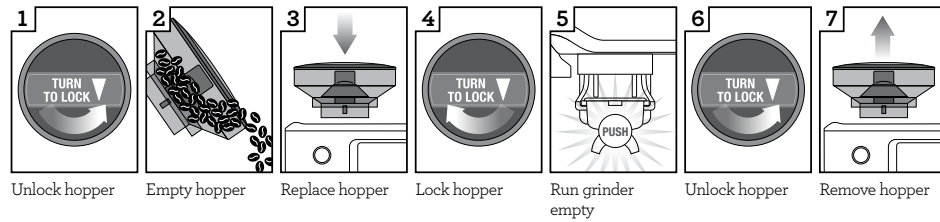

ADVANCED CLEANING FOR THE CONICAL BURR GRINDER

This step is only required if there is a blockage between the grinding burrs and the grinder outlet.

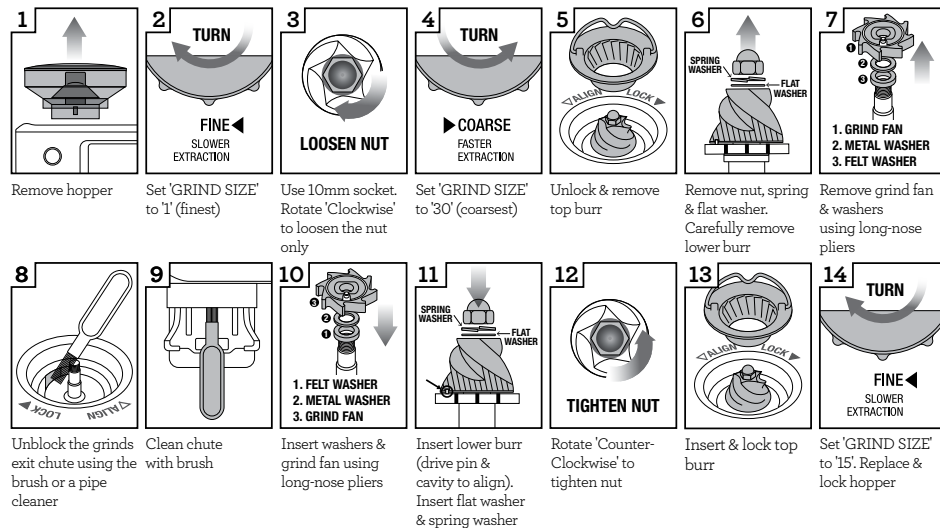

WARNING

Care should be taken as the grinder burrs are extremely sharp.

CLEANING THE STEAM WAND

- The steam wand should always be cleaned after texturing milk. Wipe the steam wand with a damp cloth.
- If any of the holes in the tip of the steam wand become blocked, it may reduce frothing performance.
- Go to 'Settings' > 'Steam wand cleaning' and follow the guide on the screen.

CLEANING THE FILTER BASKETS AND PORTAFILTER

- The filter baskets and portafilter should be rinsed under hot water immediately after use to remove all residual coffee oils.
- If any of the holes in the filter basket become blocked, use the pin on the end of the provided cleaning tool to unblock the hole(s).
- If the hole(s) remain blocked, dissolve a cleaning tablet in hot water and soak filter basket and portafilter in solution for approx. 20 minutes. Rinse thoroughly.

CLEANING THE SHOWER SCREEN

- The group head interior and shower screen should be wiped with a damp cloth to remove any ground coffee particles.
- Periodically purge the machine. Place an empty filter basket and portfilter into the group head. Touch the 'Hot Water' button and run a short flow of water to rinse out any residual coffee.

CLEANING THE DRIP & STORAGE TRAY

- The drip tray should be removed, emptied and cleaned at regular intervals, particularly when the drip tray full indicator is showing EMPTY ME!
- Remove the grill from the drip tray. Lift the coffee grind separator and dispose of any coffee grounds. The EMPTY ME! indicator can also be removed from the drip tray by pulling upwards to release the side latches. Wash all parts in warm soapy water with a soft cloth. Rinse and dry thoroughly.
- The storage tray (located behind the drip tray) can be removed and cleaned with a soft, damp cloth. Do not use abrasive cleansers, pads or cloths which can scratch the surface.



NOTE

All parts should be cleaned by hand using warm water and a gentle dish washing liquid. Do not use abrasive cleansers, pads or cloths which can scratch the surface. Do not clean any of the parts or accessories in the dishwasher.

CLEANING THE OUTER HOUSING & CUP WARMING TRAY

The outer housing and cup warming tray can be cleaned with a soft, damp cloth. Polish with a soft, dry cloth. Do not use abrasive cleansers, pads or cloths which can scratch the surface.

STORING YOUR MACHINE

Before storing, press the POWER button to switch the machine off and remove the plug from the power outlet. Remove unused beans from the hopper, clean the grinder (see page 24), empty the water tank and the drip tray. Ensure the machine is cool, clean and dry. Insert all accessories into the storage tray. Store upright. Do not place anything on top.



WARNING

Do not immerse power cord, power plug or appliance in water or any other liquid.

USING THE ALLEN KEY

Over time, the silicone seal surrounding the shower screen will need to be replaced to ensure optimum brewing performance.

1. Press the POWER button to switch the machine off and unplug the cord from the power outlet.
2. Carefully remove the water tank and drip tray, taking particular care if they are full.
3. Using a skewer or similar, clean the center of the screw of any residual coffee.
4. Insert the shorter end of the Allen Key into the center of the screw. Turn counter-clockwise to loosen the screw.

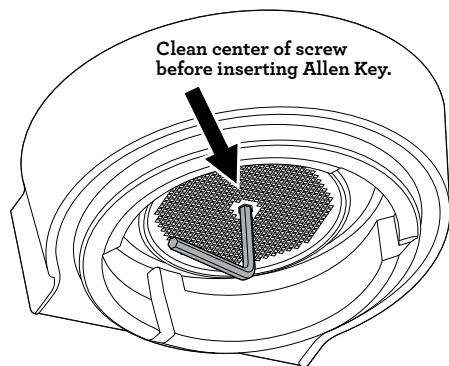

5. Once loosened, carefully remove and retain the screw and the stainless steel shower screen. Make note of the side of the shower screen that is downwards. This will make re-assembly easier. Wash the shower screen in warm soapy water, then dry thoroughly.

6. Remove the silicone seal with your fingers or a pair of long-nose pliers. Insert the new seal, flat side first, so the ribbed side is facing you.

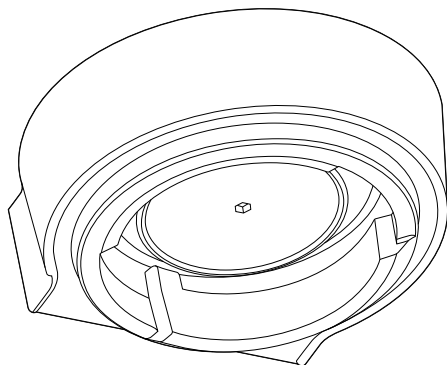

7. Re-insert the shower screen, then the screw. With your fingers, turn the screw clockwise for 2-3 revolutions then insert the Allen Key to tighten until the screw is flush with the shower screen. Do not overtighten screw.
8. Re-insert the drip tray and water tank.

Contact Breville Consumer Support or visit the Breville webpage for replacement silicone seals or for advice.

TRANSPORTING AND STORING

Press the POWER button to switch the machine off and remove the plug from the power outlet. Remove unused beans from the hopper, clean the grinder, empty the water tank and the drip tray. Ensure the machine is cool, clean and dry. Insert all accessories into the storage tray. Store upright. Do not place anything on top.



Troubleshooting

PROBLEM	POSSIBLE CAUSES	EASY SOLUTION
Water does not flow from the group head. No hot water.	Water tank is empty.	Fill tank.
	Water tank is not fully inserted and locked into position.	Push water tank down completely to lock into place.
	Machine needs to be descaled.	Perform descale cycle.
	Coffee is ground too finely and/or too much coffee in filter basket and/or over tamping and/or filter basket is blocked.	See below, 'Espresso only drips from the portafilter spouts or not at all'.
Espresso only drips from the portafilter spouts or not at all.	Coffee is ground too finely.	Use slightly coarser grind. Refer to 'Setting the Grind Size', page 14 and 'Over Extraction', page 20.
	Too much coffee in the filter basket.	Lower dose of coffee. Refer to 'Dosing', page 14 and 'Over Extraction', page 20. After tamping, trim the coffee dose using the Razor™ dose trimming tool.
	Coffee tamped too firmly.	Tamp between or 15–20kg of pressure.
	Water tank is empty.	Fill tank.
	Water tank is not fully inserted and locked into position.	Push water tank down completely to lock into place.
	The filter basket may be blocked.	Use the pin on the end of the provided cleaning tool to unblock the hole(s). If the hole(s) remain blocked, dissolve a cleaning tablet in hot water and soak filter basket and portafilter in solution for approx. 20 minutes. Rinse thoroughly.
	Machine needs to be descaled.	Perform descale cycle.
	Water doesn't come through (the machine makes loud noise).	Water tank is empty or water level is below MIN.
	There is an error on purging setting.	Perform factory reset ('Settings' > 'Factory Reset').

PROBLEM	POSSIBLE CAUSES	EASY SOLUTION
Espresso runs out too quickly.	Coffee is ground too coarsely.	Use slightly finer grind. Refer to 'Setting the Grind Size', page 14 and 'Under Extraction', page 20.
	Not enough coffee in the filter basket.	Increase dose of coffee. Refer to 'Dosing', page 14 and 'Under Extraction', page 20. Tamp then use the Razor™ dose trimming tool to trim off excess coffee.
	Coffee tamped too lightly.	Tamp between or 15-20kg of pressure.
Espresso runs out around the edge of the portafilter.	Portafilter not inserted in the group head correctly.	Ensure portafilter is completely inserted and rotated until resistance is felt.
	There are coffee grounds around the filter basket rim.	Clean excess coffee from the rim of the filter basket to ensure a proper seal in group head.
	Too much coffee in the filter basket.	Lower dose of coffee. Refer to 'Dosing', page 14. After tamping, trim the coffee dose using the Razor™ dose trimming tool.
	The silicone seal surrounding the shower screen needs to be replaced to ensure the portafilter is properly secured into the group head.	Refer to 'Using the Allen Key', page 26.
No steam.	Machine has not reached operating temperature.	Allow time for the machine to reach operating temperature.
	Water tank is empty.	Fill tank.
	Water tank is not fully inserted and locked into position.	Push water tank down completely to lock into place.
	Machine needs to be decalcified.	Perform descale cycle.
	Steam wand is blocked.	Refer to 'Cleaning the Steam Wand', page 25.
Pulsing/pumping sound while extracting espresso or steaming milk.	The machine is carrying out the normal operation of the pump.	No action required as this is the normal operation of the machine.
	Water tank is empty.	Fill tank.
	Water tank is not fully inserted and locked into position.	Push water tank down completely to lock into place.

PROBLEM	POSSIBLE CAUSES	EASY SOLUTION
Coffee not hot enough.	Cups not pre-heated.	Rinse cups under hot water outlet and place on cup warming tray.
	Portafilter not pre-heated.	Rinse portafilter under hot water outlet. Dry thoroughly.
	Milk not hot enough (if making a cappuccino or latté etc).	Make sure sensor is in contact. Adjust milk temperature setting on screen..
	Water temperature needs to be adjusted.	Increase the brew temperature in 'Settings' menu.
No crema.	Coffee tamped too lightly.	Tamp between or 15-20kg of pressure.
	Coffee is ground too coarsely.	Use slightly finer grind. Refer to 'Setting the Grind Size', page 142 and 'Under Extraction', page 20.
	Coffee beans or pre-ground coffee are not fresh.	If grinding fresh whole coffee beans, use freshly roasted coffee beans with a 'Roasted On' date and consume between 5-20 days after that date. If using pre-ground coffee, use within a week of grinding.
	The filter basket may be blocked.	Use the pin on the end of the provided cleaning tool to unblock the hole(s). If the hole(s) remain blocked, dissolve a cleaning tablet in hot water and soak filter basket and portafilter in solution for approx. 20 minutes. Rinse thoroughly.
	Single Wall filter baskets are being used with pre-ground coffee.	Ensure you use Dual Wall filter baskets with pre-ground coffee.
Water leaking.	Auto purge feature. Immediately after the espresso, hot water and steam functions, the machine will purge water into the drip tray. This ensures the thermocoil is at the optimal temperature.	Ensure the drip tray is firmly pushed in place and emptied whenever the Empty Me! indicator is displayed.
	Water tank is not fully inserted and locked into position.	Push water tank down completely to lock into place.
	The silicone seal surrounding the shower screen needs to be replaced to ensure the portafilter is properly secured into the group head.	Refer to 'Using the Allen Key', page 26.

PROBLEM	POSSIBLE CAUSES	EASY SOLUTION
Machine is on but ceases to operate.	The safety thermal-cut out may have activated due to the pump or grinder overheating.	Press the POWER button to switch the machine off and unplug from the power outlet. Allow to cool for about 30-60 minutes. If problem persists, call Breville Support.
No ground coffee coming from grinder.	No coffee beans in hopper.	Filler hopper with fresh coffee beans.
	Blocked grinder chamber or chute.	Clean and clear grinder chamber and chute. Refer to 'Advanced Cleaning for the Conical Burr Grinder', page 24.
	Water / moisture in grinder chamber and chute.	Clean and clear grinder chamber and chute. Refer to 'Advanced Cleaning for the Conical Burr Grinder', page 24. Ensure burrs are thoroughly dry before re-assembling. It is possible to use a hair dryer to blow air into the grinder chamber.
Too much/too little ground coffee is being delivered to the filter basket.	Grind amount settings are incorrect for particular grind size.	Use the grind duration button to increase or decrease the grind amount. Refer to 'Dosing', page 12 and 'Extraction Guide', page 18.
Too much/too little espresso is being delivered to the cup.	Grind amount and/or grind size settings and/or shot volumes require adjustment.	Adjust the grind amount and/or grind size settings. Refer to 'Setting the Grind Size', page 12, 'Dosing', page 14 and 'Extraction Guide', page 20.
Grinder is making a loud noise.	Blockage or foreign object in grinder.	Remove hopper, check for debris or blockage. If necessary, clean and clear grinder chamber and chute. Refer to 'Cleaning the Conical Burr Grinder', page 24.

Breville Customer Service Centre

Australian Customers

Mail: Locked Bag 2000
Botany NSW 1455
AUSTRALIA

Phone: 1300 139 798

Fax: (02) 9700 1342

Web: www.breville.com.au

New Zealand Customers

Mail: Private Bag 94411
Botany Manukau 2163
Auckland NEW ZEALAND

Phone: 0800 273 845

Fax: 0800 288 513

Web: www.breville.co.nz

Breville®
Thought for food

Breville is a registered trademark of Breville Pty. Ltd. A.B.N. 98 000 092 928.
Copyright Breville Pty. Ltd. 2017.

Due to continued product improvement, the products illustrated/photographed
in this brochure may vary slightly from the actual product.