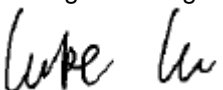

# FCC SAR Test Report

**Report No.** : SA181120W002  
**Applicant** : TCL Communication Ltd.  
**Address** : 7/F, Block F4, TCL Communication Technology Building, TCL International E  
City, Zhong Shan Yuan Road, Nanshan District, Shenzhen, Guangdong, P.R.  
China 518052  
**Product** : UMTS/GSM Smartphone  
**FCC ID** : 2ACCJB105  
**Brand** : Alcatel  
**Model No.** : 5003G  
**Standards** : FCC 47 CFR Part 2 (2.1093) / IEEE C95.1:1992 / IEEE 1528:2013  
KDB 865664 D01 v01r04 / KDB 865664 D02 v01r02  
KDB 248227 D01 v02r02 / KDB 447498 D01 v06 / KDB 648474 D04 v01r03  
/ KDB 941225 D01 v03r01 / KDB 941225 D06 v02r01  
**Sample Received Date** : Nov. 21, 2018  
**Date of Testing** : Nov. 22, 2018 ~ Dec. 08, 2018

**CERTIFICATION:** The above equipment have been tested by **BV 7LAYERS COMMUNICATIONS TECHNOLOGY (SHENZHEN) CO. LTD.**, and found compliance with the requirement of the above standards. The test record, data evaluation & Equipment Under Test (EUT) configurations represented herein are true and accurate accounts of the measurements of the sample's SAR characteristics under the conditions specified in this report. It should not be reproduced except in full, without the written approval of our laboratory. The client should not use it to claim product certification, approval, or endorsement by A2LA or any government agencies.

**Prepared By :**   
Xianxiong Qin / Engineer

**Approved By :**   
Luke Lu / Manager



This report is governed by, and incorporates by reference, CPS Conditions of Service as posted at the date of issuance of this report at <http://www.bureauveritas.com/home/about-us/our-business/cps/about-us/terms-conditions> and is intended for your exclusive use. Any copying or replication of this report to or for any other person or entity, or use of our name or trademark, is permitted only with our prior written permission. This report sets forth our findings solely with respect to the test samples identified herein. The results set forth in this report are not indicative or representative of the quality or characteristics of the lot from which a test sample was taken or any similar or identical product unless specifically and expressly noted. Our report includes all of the tests requested by you and the results thereof based upon the information that you provided to us. Measurement uncertainty is only provided upon request for accredited tests. You have 60 days from date of issuance of this report to notify us of any material error or omission caused by our negligence or if you require measurement uncertainty; provided, however, that such notice shall be in writing and shall specifically address the issue you wish to raise. A failure to raise such issue within the prescribed time shall constitute your unqualified acceptance of the completeness of this report, the tests conducted and the correctness of the report contents.

## Table of Contents

Release Control Record .....	3
<b>1. Summary of Maximum SAR Value .....</b>	<b>4</b>
<b>2. Description of Equipment Under Test .....</b>	<b>5</b>
<b>3. SAR Measurement System .....</b>	<b>6</b>
3.1 Definition of Specific Absorption Rate (SAR).....	6
3.2 SPEAG DASY System .....	6
3.2.1 Robot.....	7
3.2.2 Probes.....	8
3.2.3 Data Acquisition Electronics (DAE) .....	8
3.2.4 Phantoms .....	9
3.2.5 Device Holder.....	10
3.2.6 System Validation Dipoles.....	10
3.2.7 Tissue Simulating Liquids.....	11
3.3 SAR System Verification .....	14
3.4 SAR Measurement Procedure .....	15
3.4.1 Area & Zoom Scan Procedure .....	15
3.4.2 Volume Scan Procedure.....	15
3.4.3 Power Drift Monitoring.....	16
3.4.4 Spatial Peak SAR Evaluation .....	16
3.4.5 SAR Averaged Methods.....	16
<b>4. SAR Measurement Evaluation .....</b>	<b>17</b>
4.1 EUT Configuration and Setting.....	17
4.2 EUT Testing Position .....	22
4.2.1 Head Exposure Conditions.....	22
4.2.2 Body-worn Accessory Exposure Conditions.....	24
4.2.3 Hotspot Mode Exposure Conditions .....	25
4.2.4 SAR Test Exclusion Evaluations .....	26
4.2.5 Simultaneous Transmission Possibilities.....	26
4.3 Tissue Verification .....	27
4.4 System Validation.....	27
4.5 System Verification.....	28
4.6 Maximum Output Power.....	29
4.6.1 Maximum Conducted Power .....	29
4.6.2 Measured Conducted Power Result.....	30
4.7 SAR Testing Results.....	32
4.7.1 SAR Test Reduction Considerations .....	32
4.7.2 SAR Results for Head Exposure Condition .....	33
4.7.3 SAR Results for Body-worn Exposure Condition (Separation Distance is 1.0 cm Gap) .....	34
4.7.4 SAR Results for Hotspot Exposure Condition (Separation Distance is 1.0 cm Gap).....	35
4.7.5 SAR Measurement Variability.....	37
4.7.6 Simultaneous Multi-band Transmission Evaluation .....	38
<b>5. Calibration of Test Equipment.....</b>	<b>42</b>
<b>6. Measurement Uncertainty.....</b>	<b>43</b>
<b>7. Information on the Testing Laboratories.....</b>	<b>45</b>
<b>Appendix A. SAR Plots of System Verification</b>	
<b>Appendix B. SAR Plots of SAR Measurement</b>	
<b>Appendix C. Calibration Certificate for Probe and Dipole</b>	
<b>Appendix D. Photographs of EUT and Setup</b>	



## Release Control Record

Report No.	Reason for Change	Date Issued
SA181120W002	Initial release	Dec. 20, 2018

## 1. Summary of Maximum SAR Value

Equipment Class	Mode	Highest Reported Head SAR <sub>1g</sub> (W/kg)	Highest Reported Body-worn SAR <sub>1g</sub> (1.0 cm Gap) (W/kg)	Highest Reported Hotspot SAR <sub>1g</sub> (1.0 cm Gap) (W/kg)
PCE	GSM850	0.48	1.08	1.08
	GSM1900	0.43	0.95	1.26
	WCDMA II	0.43	0.89	1.29
	WCDMA IV	0.26	0.78	0.80
	WCDMA V	0.29	0.53	0.53
DTS	2.4G WLAN	0.60	0.14	0.14
DSS	Bluetooth	N/A	N/A	N/A
Highest Simultaneous Transmission SAR		Head (W/kg)	Body-worn (W/kg)	Hotspot (W/kg)
PCE + DTS		1.03	1.22	1.29
PCE + DSS		N/A	1.15	N/A

**Note:**

- The SAR limit (**Head & Body: SAR<sub>1g</sub> 1.6 W/kg**) for general population / uncontrolled exposure is specified in FCC 47 CFR part 2 (2.1093) and ANSI/IEEE C95.1-1992.

## 2. Description of Equipment Under Test

<b>EUT Type</b>	UMTS/GSM Smartphone
<b>FCC ID</b>	2ACCJB105
<b>Brand Name</b>	Alcatel
<b>Model Name</b>	5003G
<b>IMEI Code</b>	352220100200086
<b>HW Version</b>	PIO
<b>SW Version</b>	V1.0
<b>Tx Frequency Bands (Unit: MHz)</b>	GSM850 : 824.2 ~ 848.8 GSM1900 : 1850.2 ~ 1909.8 WCDMA Band II : 1852.4 ~ 1907.6 WCDMA Band IV : 1712.4 ~ 1752.6 WCDMA Band V : 826.4 ~ 846.6 WLAN : 2412 ~ 2462 Bluetooth : 2402 ~ 2480
<b>Uplink Modulations</b>	GSM & GPRS : GMSK WCDMA : QPSK 802.11b : DSSS 802.11g/n : OFDM Bluetooth : GFSK, $\pi/4$ -DQPSK, 8-DPSK, LE
<b>Maximum Tune-up Conducted Power (Unit: dBm)</b>	Please refer to section 4.6.1 of this report.
<b>Antenna Type</b>	IFIA Antenna
<b>EUT Stage</b>	Production Unit

**Note:**

- The above EUT information is declared by manufacturer and for more detailed features description please refers to the manufacturer's specifications or User's Manual.

**List of Accessory:**

<b>Battery 1</b>	<b>Brand Name</b>	alcatel
	<b>Model Name</b>	CAB2000080C7(TLi020F7)
	<b>Power Rating</b>	3.8Vdc, 2050mAh
	<b>Manufacturer</b>	VEKEN
<b>Battery 2</b>	<b>Type</b>	Li-ion
	<b>Brand Name</b>	alcatel
	<b>Model Name</b>	CAB2000070C1(TLi020F1)
	<b>Power Rating</b>	3.8Vdc, 2050mAh
<b>Battery 3</b>	<b>Manufacturer</b>	BYD
	<b>Type</b>	Li-ion
	<b>Brand Name</b>	alcatel
	<b>Model Name</b>	CAB2000095CA (TLi020FA)
<b>Battery 3</b>	<b>Power Rating</b>	3.8Vdc, 2050mAh
	<b>Manufacturer</b>	Tianmao
	<b>Type</b>	Li-ion

### **3. SAR Measurement System**

#### **3.1 Definition of Specific Absorption Rate (SAR)**

SAR is related to the rate at which energy is absorbed per unit mass in an object exposed to a radio field. The SAR distribution in a biological body is complicated and is usually carried out by experimental techniques or numerical modeling. The standard recommends limits for two tiers of groups, occupational/controlled and general population/uncontrolled, based on a person's awareness and ability to exercise control over his or her exposure. In general, occupational/controlled exposure limits are higher than the limits for general population/uncontrolled.

The SAR definition is the time derivative (rate) of the incremental energy (dW) absorbed by (dissipated in) an incremental mass (dm) contained in a volume element (dv) of a given density ( $\rho$ ). The equation description is as below:

$$\text{SAR} = \frac{d}{dt} \left( \frac{dW}{dm} \right) = \frac{d}{dt} \left( \frac{dW}{\rho dv} \right)$$

SAR is expressed in units of Watts per kilogram (W/kg)

SAR measurement can be related to the electrical field in the tissue by

$$\text{SAR} = \frac{\sigma |E|^2}{\rho}$$

Where:  $\sigma$  is the conductivity of the tissue,  $\rho$  is the mass density of the tissue and E is the RMS electrical field strength.

#### **3.2 SPEAG DASY System**

DASY system consists of high precision robot, probe alignment sensor, phantom, robot controller, controlled measurement server and near-field probe. The robot includes six axes that can move to the precision position of the DASY5 software defined. The DASY software can define the area that is detected by the probe. The robot is connected to controlled box. Controlled measurement server is connected to the controlled robot box. The DAE includes amplifier, signal multiplexing, AD converter, offset measurement and surface detection. It is connected to the Electro-optical coupler (ECO). The ECO performs the conversion from the optical into digital electric signal of the DAE and transfers data to the PC.

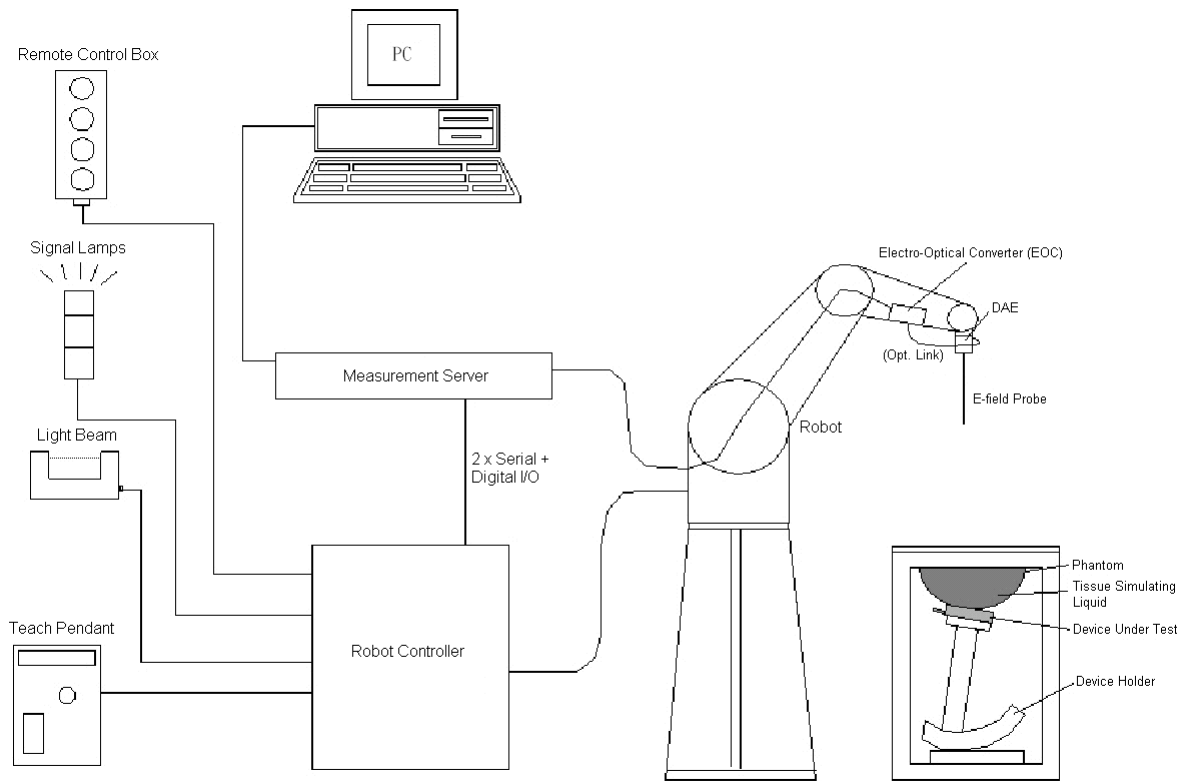

**Fig-3.1 DASY System Setup**

**3.2.1 Robot**

The DASY system uses the high precision robots from Stäubli SA (France). For the 6-axis controller system, the robot controller version (DASY5: CS8c) from Stäubli is used. The Stäubli robot series have many features that are important for our application:

- High precision (repeatability  $\pm 0.035$  mm)
- High reliability (industrial design)
- Jerk-free straight movements
- Low ELF interference (the closed metallic construction shields against motor control fields)





**Fig-3.2 DASY5**

## FCC SAR Test Report

### 3.2.2 Probes

The SAR measurement is conducted with the dosimetric probe. The probe is specially designed and calibrated for use in liquid with high permittivity. The dosimetric probe has special calibration in liquid at different frequency.

<b>Model</b>	EX3DV4	
<b>Construction</b>	Symmetrical design with triangular core. Built-in shielding against static charges. PEEK enclosure material (resistant to organic solvents, e.g., DGBE).	
<b>Frequency</b>	10 MHz to 6 GHz Linearity: $\pm 0.2$ dB	
<b>Directivity</b>	$\pm 0.3$ dB in HSL (rotation around probe axis) $\pm 0.5$ dB in tissue material (rotation normal to probe axis)	
<b>Dynamic Range</b>	10 $\mu$ W/g to 100 mW/g Linearity: $\pm 0.2$ dB (noise: typically $< 1$ $\mu$ W/g)	
<b>Dimensions</b>	Overall length: 337 mm (Tip: 20 mm) Tip diameter: 2.5 mm (Body: 12 mm) Typical distance from probe tip to dipole centers: 1 mm	

<b>Model</b>	ES3DV3	
<b>Construction</b>	Symmetrical design with triangular core. Interleaved sensors. Built-in shielding against static charges. PEEK enclosure material (resistant to organic solvents, e.g., DGBE).	
<b>Frequency</b>	10 MHz to 4 GHz Linearity: $\pm 0.2$ dB	
<b>Directivity</b>	$\pm 0.2$ dB in HSL (rotation around probe axis) $\pm 0.3$ dB in tissue material (rotation normal to probe axis)	
<b>Dynamic Range</b>	5 $\mu$ W/g to 100 mW/g Linearity: $\pm 0.2$ dB	
<b>Dimensions</b>	Overall length: 337 mm (Tip: 20 mm) Tip diameter: 3.9 mm (Body: 12 mm) Distance from probe tip to dipole centers: 2.0 mm	

### 3.2.3 Data Acquisition Electronics (DAE)

<b>Model</b>	DAE3, DAE4	
<b>Construction</b>	Signal amplifier, multiplexer, A/D converter and control logic. Serial optical link for communication with DASY embedded system (fully remote controlled). Two step probe touch detector for mechanical surface detection and emergency robot stop.	
<b>Measurement Range</b>	-100 to +300 mV (16 bit resolution and two range settings: 4mV, 400mV)	
<b>Input Offset Voltage</b>	$< 5$ $\mu$ V (with auto zero)	
<b>Input Bias Current</b>	$< 50$ fA	
<b>Dimensions</b>	60 x 60 x 68 mm	



## 3.2.4 Phantoms

<b>Model</b>	Twin SAM	
<b>Construction</b>	The shell corresponds to the specifications of the Specific Anthropomorphic Mannequin (SAM) phantom defined in IEEE 1528 and IEC 62209-1. It enables the dosimetric evaluation of left and right hand phone usage as well as body mounted usage at the flat phantom region. A cover prevents evaporation of the liquid. Reference markings on the phantom allow the complete setup of all predefined phantom positions and measurement grids by teaching three points with the robot.	
<b>Material</b>	Vinylester, glass fiber reinforced (VE-GF)	
<b>Shell Thickness</b>	$2 \pm 0.2$ mm ( $6 \pm 0.2$ mm at ear point)	
<b>Dimensions</b>	Length: 1000 mm Width: 500 mm Height: adjustable feet	
<b>Filling Volume</b>	approx. 25 liters	

<b>Model</b>	ELI	
<b>Construction</b>	Phantom for compliance testing of handheld and body-mounted wireless devices in the frequency range of 30 MHz to 6 GHz. ELI is fully compatible with the IEC 62209-2 standard and all known tissue simulating liquids. ELI has been optimized regarding its performance and can be integrated into our standard phantom tables. A cover prevents evaporation of the liquid. Reference markings on the phantom allow installation of the complete setup, including all predefined phantom positions and measurement grids, by teaching three points. The phantom is compatible with all SPEAG dosimetric probes and dipoles.	
<b>Material</b>	Vinylester, glass fiber reinforced (VE-GF)	
<b>Shell Thickness</b>	$2.0 \pm 0.2$ mm (bottom plate)	
<b>Dimensions</b>	Major axis: 600 mm Minor axis: 400 mm	
<b>Filling Volume</b>	approx. 30 liters	

# FCC SAR Test Report

## 3.2.5 Device Holder

<b>Model</b>	Mounting Device	
<b>Construction</b>	In combination with the Twin SAM Phantom or ELI4, the Mounting Device enables the rotation of the mounted transmitter device in spherical coordinates. Rotation point is the ear opening point. Transmitter devices can be easily and accurately positioned according to IEC, IEEE, FCC or other specifications. The device holder can be locked for positioning at different phantom sections (left head, right head, flat).	
<b>Material</b>	POM	

<b>Model</b>	Laptop Extensions Kit	
<b>Construction</b>	Simple but effective and easy-to-use extension for Mounting Device that facilitates the testing of larger devices according to IEC 62209-2 (e.g., laptops, cameras, etc.). It is lightweight and fits easily on the upper part of the Mounting Device in place of the phone positioner.	
<b>Material</b>	POM, Acrylic glass, Foam	

## 3.2.6 System Validation Dipoles

<b>Model</b>	D-Serial	
<b>Construction</b>	Symmetrical dipole with 1/4 balun. Enables measurement of feed point impedance with NWA. Matched for use near flat phantoms filled with tissue simulating solutions.	
<b>Frequency</b>	750 MHz to 5800 MHz	
<b>Return Loss</b>	> 20 dB	
<b>Power Capability</b>	> 100 W (f < 1GHz), > 40 W (f > 1GHz)	

### 3.2.7 Tissue Simulating Liquids

For SAR measurement of the field distribution inside the phantom, the phantom must be filled with homogeneous tissue simulating liquid to a depth of at least 15 cm. For head SAR testing, the liquid height from the ear reference point (ERP) of the phantom to the liquid top surface is larger than 15 cm. For body SAR testing, the liquid height from the center of the flat phantom to the liquid top surface is larger than 15 cm. The nominal dielectric values of the tissue simulating liquids in the phantom and the tolerance of 5% are listed in Table-3.1.

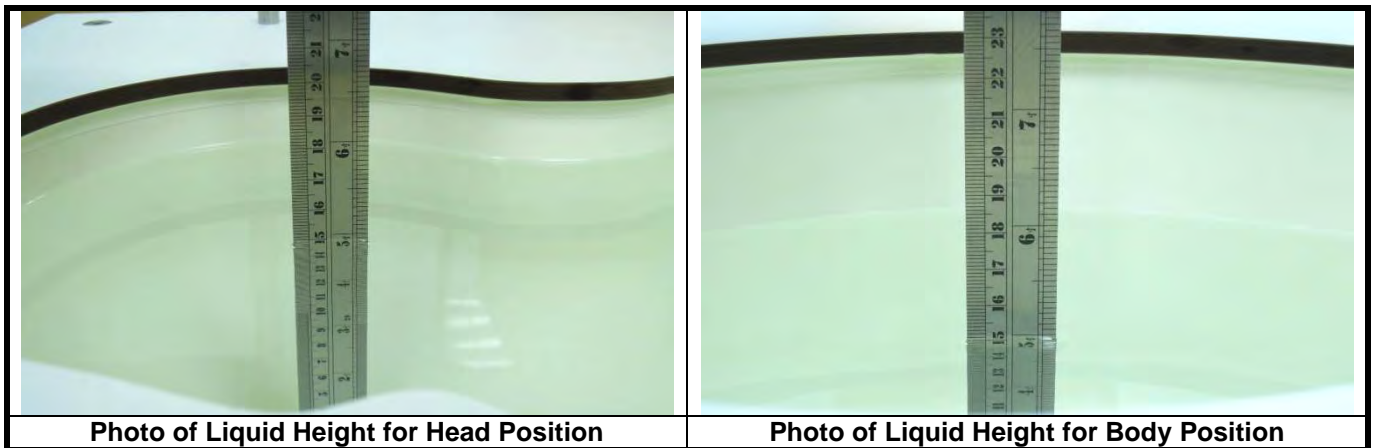

The dielectric properties of the head tissue simulating liquids are defined in IEEE 1528, and KDB 865664 D01 Appendix A. For the body tissue simulating liquids, the dielectric properties are defined in KDB 865664 D01 Appendix A. The dielectric properties of the tissue simulating liquids were verified prior to the SAR evaluation using a dielectric assessment kit and a network analyzer.

**Table-3.1 Targets of Tissue Simulating Liquid**

Frequency (MHz)	Target Permittivity	Range of $\pm 5\%$	Target Conductivity	Range of $\pm 5\%$
<b>For Head</b>				
750	41.9	39.8 ~ 44.0	0.89	0.85 ~ 0.93
835	41.5	39.4 ~ 43.6	0.90	0.86 ~ 0.95
900	41.5	39.4 ~ 43.6	0.97	0.92 ~ 1.02
1450	40.5	38.5 ~ 42.5	1.20	1.14 ~ 1.26
1640	40.3	38.3 ~ 42.3	1.29	1.23 ~ 1.35
1750	40.1	38.1 ~ 42.1	1.37	1.30 ~ 1.44
1800	40.0	38.0 ~ 42.0	1.40	1.33 ~ 1.47
1900	40.0	38.0 ~ 42.0	1.40	1.33 ~ 1.47
2000	40.0	38.0 ~ 42.0	1.40	1.33 ~ 1.47
2300	39.5	37.5 ~ 41.5	1.67	1.59 ~ 1.75
2450	39.2	37.2 ~ 41.2	1.80	1.71 ~ 1.89
2600	39.0	37.1 ~ 41.0	1.96	1.86 ~ 2.06
3500	37.9	36.0 ~ 39.8	2.91	2.76 ~ 3.06
5200	36.0	34.2 ~ 37.8	4.66	4.43 ~ 4.89
5300	35.9	34.1 ~ 37.7	4.76	4.52 ~ 5.00
5500	35.6	33.8 ~ 37.4	4.96	4.71 ~ 5.21
5600	35.5	33.7 ~ 37.3	5.07	4.82 ~ 5.32
5800	35.3	33.5 ~ 37.1	5.27	5.01 ~ 5.53
<b>For Body</b>				
750	55.5	52.7 ~ 58.3	0.96	0.91 ~ 1.01
835	55.2	52.4 ~ 58.0	0.97	0.92 ~ 1.02
900	55.0	52.3 ~ 57.8	1.05	1.00 ~ 1.10
1450	54.0	51.3 ~ 56.7	1.30	1.24 ~ 1.37
1640	53.8	51.1 ~ 56.5	1.40	1.33 ~ 1.47
1750	53.4	50.7 ~ 56.1	1.49	1.42 ~ 1.56
1800	53.3	50.6 ~ 56.0	1.52	1.44 ~ 1.60
1900	53.3	50.6 ~ 56.0	1.52	1.44 ~ 1.60
2000	53.3	50.6 ~ 56.0	1.52	1.44 ~ 1.60
2300	52.9	50.3 ~ 55.5	1.81	1.72 ~ 1.90
2450	52.7	50.1 ~ 55.3	1.95	1.85 ~ 2.05
2600	52.5	49.9 ~ 55.1	2.16	2.05 ~ 2.27
3500	51.3	48.7 ~ 53.9	3.31	3.14 ~ 3.48
5200	49.0	46.6 ~ 51.5	5.30	5.04 ~ 5.57
5300	48.9	46.5 ~ 51.3	5.42	5.15 ~ 5.69
5500	48.6	46.2 ~ 51.0	5.65	5.37 ~ 5.93
5600	48.5	46.1 ~ 50.9	5.77	5.48 ~ 6.06
5800	48.2	45.8 ~ 50.6	6.00	5.70 ~ 6.30

The following table gives the recipes for tissue simulating liquids.

**Table-3.2 Recipes of Tissue Simulating Liquid**

Tissue Type	Bactericide	DGBE	HEC	NaCl	Sucrose	Triton X-100	Water	Diethylene Glycol Mono-hexylether
H750	0.2	-	0.2	1.5	56.0	-	42.1	-
H835	0.2	-	0.2	1.5	57.0	-	41.1	-
H900	0.2	-	0.2	1.4	58.0	-	40.2	-
H1450	-	43.3	-	0.6	-	-	56.1	-
H1640	-	45.8	-	0.5	-	-	53.7	-
H1750	-	47.0	-	0.4	-	-	52.6	-
H1800	-	44.5	-	0.3	-	-	55.2	-
H1900	-	44.5	-	0.2	-	-	55.3	-
H2000	-	44.5	-	0.1	-	-	55.4	-
H2300	-	44.9	-	0.1	-	-	55.0	-
H2450	-	45.0	-	0.1	-	-	54.9	-
H2600	-	45.1	-	0.1	-	-	54.8	-
H3500	-	28.0	-	0.2	-	20.0	71.8	-
H5G	-	-	-	-	-	17.2	65.5	17.3
B750	0.2	-	0.2	0.8	48.8	-	50.0	-
B835	0.2	-	0.2	0.9	48.5	-	50.2	-
B900	0.2	-	0.2	0.9	48.2	-	50.5	-
B1450	-	34.0	-	0.3	-	-	65.7	-
B1640	-	32.5	-	0.3	-	-	67.2	-
B1750	-	31.0	-	0.2	-	-	68.8	-
B1800	-	29.5	-	0.4	-	-	70.1	-
B1900	-	29.5	-	0.3	-	-	70.2	-
B2000	-	30.0	-	0.2	-	-	69.8	-
B2300	-	31.0	-	0.1	-	-	68.9	-
B2450	-	31.4	-	0.1	-	-	68.5	-
B2600	-	31.8	-	0.1	-	-	68.1	-
B3500	-	28.8	-	0.1	-	-	71.1	-
B5G	-	-	-	-	-	10.7	78.6	10.7

**3.3 SAR System Verification**

The system check verifies that the system operates within its specifications. It is performed daily or before every SAR measurement. The system check uses normal SAR measurements in the flat section of the phantom with a matched dipole at a specified distance. The system verification setup is shown as below.

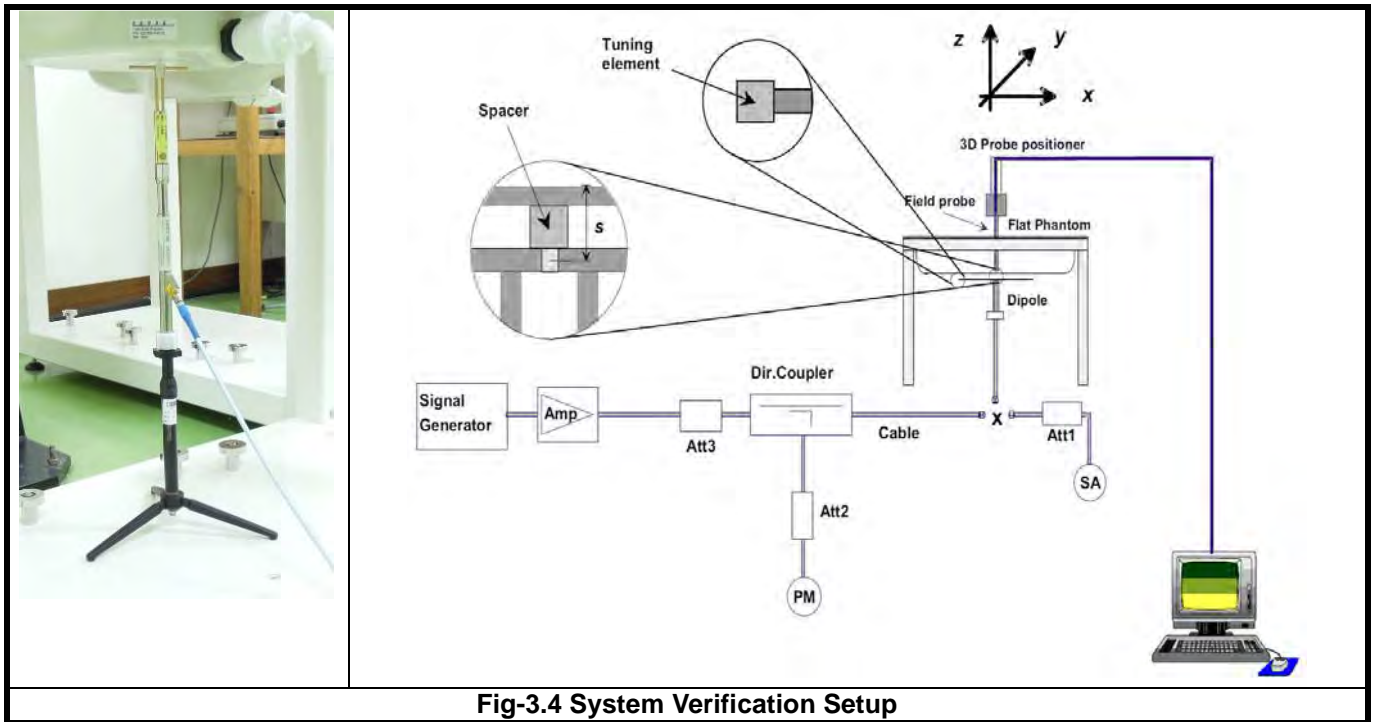

**Fig-3.4 System Verification Setup**

The validation dipole is placed beneath the flat phantom with the specific spacer in place. The distance spacer is touch the phantom surface with a light pressure at the reference marking and be oriented parallel to the long side of the phantom. The spectrum analyzer measures the forward power at the location of the system check dipole connector. The signal generator is adjusted for the desired forward power (250 mW is used for 700 MHz to 3 GHz, 100 mW is used for 3.5 GHz to 6 GHz) at the dipole connector and the power meter is read at that level. After connecting the cable to the dipole, the signal generator is readjusted for the same reading at power meter.

After system check testing, the SAR result will be normalized to 1W forward input power and compared with the reference SAR value derived from validation dipole certificate report. The deviation of system check should be within 10 %.

### 3.4 SAR Measurement Procedure

According to the SAR test standard, the recommended procedure for assessing the peak spatial-average SAR value consists of the following steps:

- (a) Power reference measurement
- (b) Area scan
- (c) Zoom scan
- (d) Power drift measurement

The SAR measurement procedures for each of test conditions are as follows:

- (a) Make EUT to transmit maximum output power
- (b) Measure conducted output power through RF cable
- (c) Place the EUT in the specific position of phantom
- (d) Perform SAR testing steps on the DASY system
- (e) Record the SAR value

#### 3.4.1 Area & Zoom Scan Procedure

First Area Scan is used to locate the approximate location(s) of the local peak SAR value(s). The measurement grid within an Area Scan is defined by the grid extent, grid step size and grid offset. Next, in order to determine the EM field distribution in a three-dimensional spatial extension, Zoom Scan is required. The Zoom Scan is performed around the highest E-field value to determine the averaged SAR-distribution over 10 g. According to KDB 865664 D01, the resolution for Area and Zoom scan is specified in the table below.

Items	<= 2 GHz	2-3 GHz	3-4 GHz	4-5 GHz	5-6 GHz
Area Scan ( $\Delta x, \Delta y$ )	<= 15 mm	<= 12 mm	<= 12 mm	<= 10 mm	<= 10 mm
Zoom Scan ( $\Delta x, \Delta y$ )	<= 8 mm	<= 5 mm	<= 5 mm	<= 4 mm	<= 4 mm
Zoom Scan ( $\Delta z$ )	<= 5 mm	<= 5 mm	<= 4 mm	<= 3 mm	<= 2 mm
Zoom Scan Volume	>= 30 mm	>= 30 mm	>= 28 mm	>= 25 mm	>= 22 mm

**Note:**

When zoom scan is required and report SAR is <= 1.4 W/kg, the zoom scan resolution of  $\Delta x / \Delta y$  (2-3GHz: <= 8 mm, 3-4GHz: <= 7 mm, 4-6GHz: <= 5 mm) may be applied.

#### 3.4.2 Volume Scan Procedure

The volume scan is used for assess overlapping SAR distributions for antennas transmitting in different frequency bands. It is equivalent to an oversized zoom scan used in standalone measurements. The measurement volume will be used to enclose all the simultaneous transmitting antennas. For antennas transmitting simultaneously in different frequency bands, the volume scan is measured separately in each frequency band. In order to sum correctly to compute the 1g aggregate SAR, the EUT remain in the same test position for all measurements and all volume scan use the same spatial resolution and grid spacing. When all volume scan were completed, the software, SEMCAD postprocessor can combine and subsequently superpose these measurement data to calculating the multiband SAR.

### 3.4.3 Power Drift Monitoring

All SAR testing is under the EUT install full charged battery and transmit maximum output power. In DASY measurement software, the power reference measurement and power drift measurement procedures are used for monitoring the power drift of EUT during SAR test. Both these procedures measure the field at a specified reference position before and after the SAR testing. The software will calculate the field difference in dB. If the power drift more than 5%, the SAR will be retested.

### 3.4.4 Spatial Peak SAR Evaluation

The procedure for spatial peak SAR evaluation has been implemented according to the test standard. It can be conducted for 1g and 10g, as well as for user-specific masses. The DASY software includes all numerical procedures necessary to evaluate the spatial peak SAR value.

The base for the evaluation is a "cube" measurement. The measured volume must include the 1g and 10g cubes with the highest averaged SAR values. For that purpose, the center of the measured volume is aligned to the interpolated peak SAR value of a previously performed area scan.

The entire evaluation of the spatial peak values is performed within the post-processing engine (SEMCAD). The system always gives the maximum values for the 1g and 10g cubes. The algorithm to find the cube with highest averaged SAR is divided into the following stages:

- (a) Extraction of the measured data (grid and values) from the Zoom Scan
- (b) Calculation of the SAR value at every measurement point based on all stored data (A/D values and measurement parameters)
- (c) Generation of a high-resolution mesh within the measured volume
- (d) Interpolation of all measured values from the measurement grid to the high-resolution grid
- (e) Extrapolation of the entire 3-D field distribution to the phantom surface over the distance from sensor to surface
- (f) Calculation of the averaged SAR within masses of 1g and 10g

### 3.4.5 SAR Averaged Methods

In DASY, the interpolation and extrapolation are both based on the modified Quadratic Shepard's method. The interpolation scheme combines a least-square fitted function method and a weighted average method which are the two basic types of computational interpolation and approximation.

Extrapolation routines are used to obtain SAR values between the lowest measurement points and the inner phantom surface. The extrapolation distance is determined by the surface detection distance and the probe sensor offset. The uncertainty increases with the extrapolation distance. To keep the uncertainty within 1% for the 1 g and 10 g cubes, the extrapolation distance should not be larger than 5 mm.



## 4. SAR Measurement Evaluation

### 4.1 EUT Configuration and Setting

#### <Connections between EUT and System Simulator>

For WWAN SAR testing, the EUT was linked and controlled by base station emulator (Agilent E5515C is used for GSM/WCDMA). Communication between the EUT and the emulator was established by air link. The distance between the EUT and the communicating antenna of the emulator is larger than 50 cm and the output power radiated from the emulator antenna is at least 30 dB smaller than the output power of EUT. The EUT was set from the emulator to radiate maximum output power during SAR testing.

#### <Considerations Related to GSM / GPRS for Setup and Testing>

The maximum multi-slot capability supported by this device is as below.

1. This EUT is class B device
2. This EUT supports GPRS multi-slot class 12 (max. uplink: 4, max. downlink: 4, total timeslots: 5)

For GSM850 frequency band, the power control level is set to 5 for GSM mode and GPRS (GMSK: CS1). For GSM1900 frequency band, the power control level is set to 0 for GSM mode and GPRS (GMSK: CS1).

SAR test reduction for GPRS modes is determined by the source-based time-averaged output power specified for production units, including tune-up tolerance. The data mode with highest specified time-averaged output power should be tested for SAR compliance in the applicable exposure conditions. For modes with the same specified maximum output power and tolerance, the higher number time-slot configuration should be tested.

#### <Considerations Related to WCDMA for Setup and Testing>

##### WCDMA Handsets Head SAR

SAR for next to the ear head exposure is measured using a 12.2 kbps RMC with TPC bits configured to all "1's". The 3G SAR test reduction procedure is applied to AMR configurations with 12.2 kbps RMC as the primary mode.

##### WCDMA Handsets Body-worn SAR

SAR for body-worn configurations is measured using a 12.2 kbps RMC with TPC bits configured to all "1's". The 3G SAR test reduction procedure is applied to other spreading codes and multiple DPDCH<sub>n</sub> configurations supported by the handset with 12.2 kbps RMC as the primary mode.

##### Handsets with Release 5 HSDPA

The 3G SAR test reduction procedure is applied to HSDPA body-worn configurations with 12.2 kbps RMC as the primary mode. Otherwise, SAR is measured for HSDPA using the HSDPA body SAR procedures in the "Release 5 HSDPA Data Devices", for the highest reported SAR body-worn exposure configuration in 12.2 kbps RMC. Handsets with both HSDPA and HSUPA are tested according to Release 6 HSPA test procedures.

##### Handsets with Release 6 HSUPA

The 3G SAR test reduction procedure is applied to HSPA (HSUPA/HSDPA with RMC) body-worn configurations with 12.2 kbps RMC as the primary mode. Otherwise, SAR is measured for HSPA using the HSPA body SAR procedures in the "Release 6 HSPA Data Devices", for the highest reported body-worn exposure SAR configuration in 12.2 kbps

## FCC SAR Test Report

---

RMC. When VOIP is applicable for next to the ear head exposure in HSPA, the 3G SAR test reduction procedure is applied to HSPA with 12.2 kbps RMC as the primary mode; otherwise, the same HSPA configuration used for body-worn measurements is tested for next to the ear head exposure.

### Release 5 HSDPA Data Devices

The 3G SAR test reduction procedure is applied to body SAR with 12.2 kbps RMC as the primary mode. Otherwise, body SAR for HSDPA is measured using an FRC with H-Set 1 in Sub-test 1 and a 12.2 kbps RMC configured in Test Loop Mode 1, for the highest reported SAR configuration in 12.2 kbps RMC without HSDPA. HSDPA is configured according to the applicable UE category of a test device. The number of HS-DSCH / HS-PDSCHs, HARQ processes, minimum inter-TTI interval, transport block sizes and RV coding sequence are defined by the H-set. To maintain a consistent test configuration and stable transmission conditions, QPSK is used in the H-set for SAR testing. HS-DPCCH should be configured with a CQI feedback cycle of 4 ms and a CQI repetition factor of 2 to maintain a constant rate of active CQI slots. DPCCH and DPDCH gain factors ( $\beta_c$ ,  $\beta_d$ ), and HS-DPCCH power offset parameters ( $\Delta_{ACK}$ ,  $\Delta_{NACK}$ ,  $\Delta_{CQI}$ ) are set according to values indicated in below. The CQI value is determined by the UE category, transport block size, number of HS-PDSCHs and modulation used in the H-set.

Sub-test	$\beta_c$	$\beta_d$	$\beta_d$ (SF)	$\beta_c / \beta_d$	$\beta_{hs}^{(1)}$	CM (dB) <sup>(2)</sup>	MPR
1	2 / 15	15 / 15	64	2 / 15	4 / 15	0.0	0
2	12 / 15 <sup>(3)</sup>	15 / 15 <sup>(3)</sup>	64	12 / 15 <sup>(3)</sup>	24 / 15	1.0	0
3	15 / 15	8 / 15	64	15 / 8	30 / 15	1.5	0.5
4	15 / 15	4 / 15	64	15 / 4	30 / 15	1.5	0.5

Note 1:  $\Delta_{ACK}$ ,  $\Delta_{NACK}$  and  $\Delta_{CQI} = 8 \Leftrightarrow A_{hs} = \beta_{hs} / \beta_c = 30 / 15 \Leftrightarrow \beta_{hs} = 30 / 15 * \beta_c$ .

Note 2: CM = 1 for  $\beta_c / \beta_d = 12 / 15$ ,  $\beta_{hs} / \beta_c = 24 / 15$ .

Note 3: For subtest 2 the  $\beta_c / \beta_d$  ratio of 12 / 15 for the TFC during the measurement period (TF1, TF0) is achieved by setting the signaled gain factors for the reference TFC (TF1, TF1) to  $\beta_c = 11 / 15$  and  $\beta_d = 15 / 15$ .

## Release 6 HSUPA Data Devices

The 3G SAR test reduction procedure is applied to body SAR with 12.2 kbps RMC as the primary mode. Otherwise, body SAR for HSPA is measured with E-DCH Sub-test 5, using H-Set 1 and QPSK for FRC and a 12.2 kbps RMC configured in Test Loop Mode 1 and power control algorithm 2, according to the highest reported body SAR configuration in 12.2 kbps RMC without HSPA. When VOIP applies to head exposure, the 3G SAR test reduction procedure is applied with 12.2 kbps RMC as the primary mode. Otherwise, the same HSPA configuration used for body SAR measurements are applied to head exposure testing. Due to inner loop power control requirements in HSPA, a communication test set is required for output power and SAR tests. The 12.2 kbps RMC, FRC H-set 1 and E-DCH configurations for HSPA are configured according to the  $\beta$  values indicated in below.

Sub-test	$\beta_c$	$\beta_d$	$\beta_d$ (SF)	$\beta_c / \beta_d$	$\beta_{hs}^{(1)}$	$\beta_{ec}$	$\beta_{ed}$	$\beta_{ed}$ (SF)	$\beta_{ed}$ (codes)	CM <sup>(2)</sup> (dB)	MPR (dB)	AG <sup>(4)</sup> Index	E-TFCI
1	11 / 15 <sup>(3)</sup>	15 / 15 <sup>(3)</sup>	64	11 / 15 <sup>(3)</sup>	22 / 15	209 / 225	1039 / 225	4	1	1.0	0.0	20	75
2	6 / 15	15 / 15	64	6 / 15	12 / 15	12 / 15	94 / 75	4	1	3.0	2.0	12	67
3	15 / 15	9 / 15	64	15 / 9	30 / 15	30 / 15	$\beta_{ed1}: 47/15$ $\beta_{ed2}: 47/15$	4	2	2.0	1.0	15	92
4	2 / 15	15 / 15	64	2 / 15	4 / 15	2 / 15	56 / 75	4	1	3.0	2.0	17	71
5	15 / 15 <sup>(4)</sup>	15 / 15 <sup>(4)</sup>	64	15 / 15 <sup>(4)</sup>	30 / 15	24 / 15	134 / 15	4	1	1.0	0.0	21	81

Note 1:  $\Delta_{ACK}$ ,  $\Delta_{NACK}$  and  $\Delta_{CQI} = 8 \Leftrightarrow A_{hs} = \beta_{hs} / \beta_c = 30 / 15 \Leftrightarrow \beta_{hs} = 30 / 15 * \beta_c$ .

Note 2: CM = 1 for  $\beta_c / \beta_d = 12 / 15$ ,  $\beta_{hs} / \beta_c = 24 / 15$ . For all other combinations of DPDCH, DPCCH, HS-DPCCH, E-DPDCH and E-DPCCH the MPR is based on the relative CM difference.

Note 3: For subtest 1 the  $\beta_c / \beta_d$  ratio of 11 / 15 for the TFC during the measurement period (TF1, TF0) is achieved by setting the signaled gain factors for the reference TFC (TF1, TF1) to  $\beta_c = 10 / 15$  and  $\beta_d = 15 / 15$ .

Note 4: For subtest 5 the  $\beta_c / \beta_d$  ratio of 15 / 15 for the TFC during the measurement period (TF1, TF0) is achieved by setting the signaled gain factors for the reference TFC (TF1, TF1) to  $\beta_c = 14 / 15$  and  $\beta_d = 15 / 15$ .

Note 5: Testing UE using E-DPDCH Physical Layer category 1 Sub-test 3 is not required according to TS 25.306 Table 5.1g.

Note 6:  $\beta_{ed}$  cannot be set directly; it is set by Absolute Grant Value.

## <Considerations Related to WLAN for Setup and Testing>

In general, various vendor specific external test software and chipset based internal test modes are typically used for SAR measurement. These chipset based test mode utilities are generally hardware and manufacturer dependent, and often include substantial flexibility to reconfigure or reprogram a device. A Wi-Fi device must be configured to transmit continuously at the required data rate, channel bandwidth and signal modulation, using the highest transmission duty factor supported by the test mode tools for SAR measurement. The test frequencies established using test mode must correspond to the actual channel frequencies. When 802.11 frame gaps are accounted for in the transmission, a maximum transmission duty factor of 92 - 96% is typically achievable in most test mode configurations. A minimum transmission duty factor of 85% is required to avoid certain hardware and device implementation issues related to wide range SAR scaling. In addition, a periodic transmission duty factor is required for current generation SAR systems to measure SAR correctly. The reported SAR must be scaled to 100% transmission duty factor to determine compliance at the maximum tune-up tolerance limit.

According to KDB 248227 D01, this device has installed WLAN engineering testing software which can provide continuous transmitting RF signal. During WLAN SAR testing, this device was operated to transmit continuously at the maximum transmission duty with specified transmission mode, operating frequency, lowest data rate, and maximum output power.

## Initial Test Configuration

An initial test configuration is determined for OFDM transmission modes in 2.4 GHz and 5 GHz bands according to the channel bandwidth, modulation and data rate combination(s) with the highest maximum output power specified for production units in each standalone and aggregated frequency band. When the same maximum power is specified for multiple transmission modes in a frequency band, the largest channel bandwidth, lowest order modulation, lowest data rate and lowest order 802.11a/g/n/ac mode is used for SAR measurement, on the highest measured output power channel in the initial test configuration, for each frequency band.

## Subsequent Test Configuration

SAR measurement requirements for the remaining 802.11 transmission mode configurations that have not been tested in the initial test configuration are determined separately for each standalone and aggregated frequency band, in each exposure condition, according to the maximum output power specified for production units. Additional power measurements may be required to determine if SAR measurements are required for subsequent highest output power channels in a subsequent test configuration. When the highest reported SAR for the initial test configuration according to the initial test position or fixed exposure position requirements, is adjusted by the ratio of the subsequent test configuration to initial test configuration specified maximum output power and the adjusted SAR is  $\leq 1.2$  W/kg, SAR is not required for that subsequent test configuration.

## SAR Test Configuration and Channel Selection

When multiple channel bandwidth configurations in a frequency band have the same specified maximum output power, the initial test configuration is using largest channel bandwidth, lowest order modulation, lowest data rate, and lowest order 802.11 mode (i.e., 802.11a is chosen over 802.11n then 802.11ac or 802.11g is chosen over 802.11n). After an initial test configuration is determined, if multiple test channels have the same measured maximum output power, the channel chosen for SAR measurement is determined according to the following.

## FCC SAR Test Report

---

- 1) The channel closest to mid-band frequency is selected for SAR measurement.
- 2) For channels with equal separation from mid-band frequency; for example, high and low channels or two mid-band channels, the higher frequency (number) channel is selected for SAR measurement.

## 4.2 EUT Testing Position

According to KDB 648474 D04, handsets are tested for SAR compliance in head, body-worn accessory and other use configurations described in the following subsections.

### 4.2.1 Head Exposure Conditions

Head exposure is limited to next to the ear voice mode operations. Head SAR compliance is tested according to the test positions defined in IEEE Std 1528-2013 using the SAM phantom illustrated as below.

1. Define two imaginary lines on the handset
  - (a) The vertical centerline passes through two points on the front side of the handset - the midpoint of the width  $w_t$  of the handset at the level of the acoustic output, and the midpoint of the width  $w_b$  of the bottom of the handset.
  - (b) The horizontal line is perpendicular to the vertical centerline and passes through the center of the acoustic output. The horizontal line is also tangential to the face of the handset at point A.
  - (c) The two lines intersect at point A. Note that for many handsets, point A coincides with the center of the acoustic output; however, the acoustic output may be located elsewhere on the horizontal line. Also note that the vertical centerline is not necessarily parallel to the front face of the handset, especially for clamshell handsets, handsets with flip covers, and other irregularly shaped handsets.

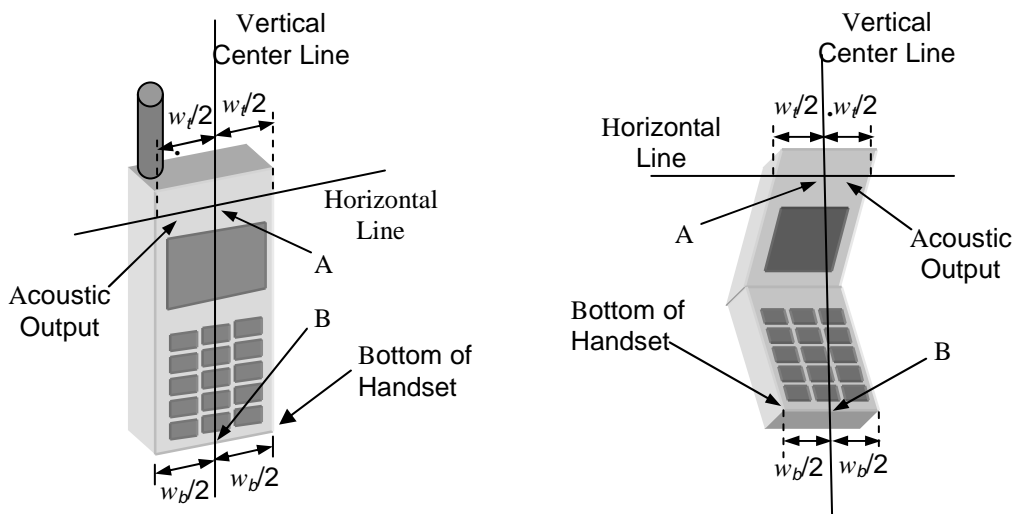

**Fig-4.1 Illustration for Handset Vertical and Horizontal Reference Lines**

### 2. Cheek Position

- (a) To position the device with the vertical center line of the body of the device and the horizontal line crossing the center piece in a plane parallel to the sagittal plane of the phantom. While maintaining the device in this plane, align the vertical center line with the reference plane containing the three ear and mouth reference point (M: Mouth, RE: Right Ear, and LE: Left Ear) and align the center of the ear piece with the line RE-LE.
- (b) To move the device towards the phantom with the ear piece aligned with the line LE-RE until the phone touched the ear. While maintaining the device in the reference plane and maintaining the phone contact with the ear,

move the bottom of the phone until any point on the front side is in contact with the cheek of the phantom or until contact with the ear is lost (see Fig-4.2).

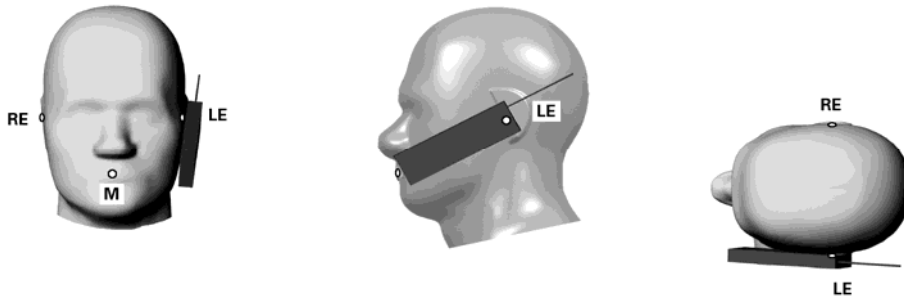

Fig-4.2 Illustration for Cheek Position

3. Tilted Position

- (a) To position the device in the “cheek” position described above.
- (b) While maintaining the device the reference plane described above and pivoting against the ear, moves it outward away from the mouth by an angle of 15 degrees or until contact with the ear is lost (see Fig-4.3).

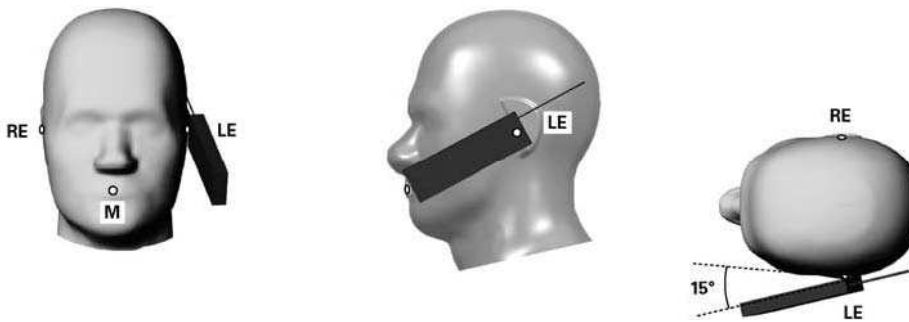

Fig-4.3 Illustration for Tilted Position

**4.2.2 Body-worn Accessory Exposure Conditions**

Body-worn accessory exposure is typically related to voice mode operations when handsets are carried in body-worn accessories. The body-worn accessory procedures in KDB 447498 D01 are used to test for body-worn accessory SAR compliance, without a headset connected to it. This enables the test results for such configuration to be compatible with that required for hotspot mode when the body-worn accessory test separation distance is greater than or equal to that required for hotspot mode. When the reported SAR for a body-worn accessory, measured without a headset connected to the handset, is  $> 1.2 \text{ W/kg}$ , the highest reported SAR configuration for that wireless mode and frequency band should be repeated for that body-worn accessory with a headset attached to the handset.

Body-worn accessories that do not contain metallic or conductive components may be tested according to worst-case exposure configurations, typically according to the smallest test separation distance required for the group of body-worn accessories with similar operating and exposure characteristics. All body-worn accessories containing metallic components are tested in conjunction with the host device.

Body-worn accessory SAR compliance is based on a single minimum test separation distance for all wireless and operating modes applicable to each body-worn accessory used by the host, and according to the relevant voice and/or data mode transmissions and operations. If a body-worn accessory supports voice only operations in its normal and expected use conditions, testing of data mode for body-worn compliance is not required.

A conservative minimum test separation distance for supporting off-the-shelf body-worn accessories that may be acquired by users of consumer handsets is used to test for body-worn accessory SAR compliance. This distance is determined by the handset manufacturer, according to the requirements of Supplement C 01-01. Devices that are designed to operate on the body of users using lanyards and straps, or without requiring additional body-worn accessories, will be tested using a conservative minimum test separation distance  $\leq 5 \text{ mm}$  to support compliance.

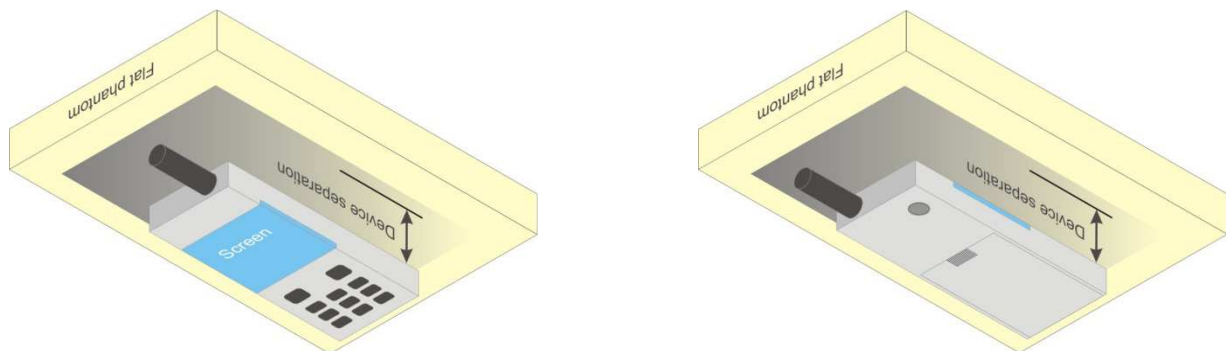
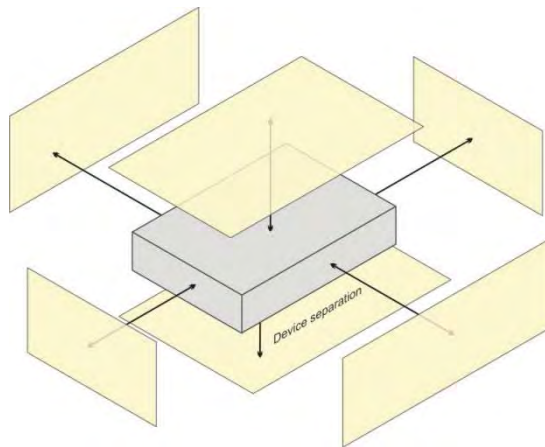

**Fig-4.4 Illustration for Body Worn Position**



**4.2.3 Hotspot Mode Exposure Conditions**

For handsets that support hotspot mode operations, with wireless router capabilities and various web browsing functions, the relevant hand and body exposure conditions are tested according to the hotspot SAR procedures in KDB 941225 D06. A test separation distance of 10 mm is required between the phantom and all surfaces and edges with a transmitting antenna located within 25 mm from that surface or edge. When the form factor of a handset is smaller than 9 cm x 5 cm, a test separation distance of 5 mm (instead of 10 mm) is required for testing hotspot mode. When the separation distance required for body-worn accessory testing is larger than or equal to that tested for hotspot mode, in the same wireless mode and for the same surface of the phone, the hotspot mode SAR data may be used to support body-worn accessory SAR compliance for that particular configuration (surface).



Based on the antenna location shown on appendix D of this report, the SAR testing required for hotspot mode is listed as below.

Antenna	Front Face	Rear Face	Left Side	Right Side	Top Side	Bottom Side
WWAN	V	V	V	V		V
WLAN / BT	V	V		V	V	

## 4.2.4 SAR Test Exclusion Evaluations

According to KDB 447498 D01, the SAR test exclusion condition is based on source-based time-averaged maximum conducted output power, adjusted for tune-up tolerance, and the minimum test separation distance required for the exposure conditions. The SAR exclusion threshold is determined by the following formula.

$$\frac{\text{Max. Tune up Power}_{(mW)}}{\text{Min. Test Separation Distance}_{(mm)}} \times \sqrt{f_{(GHz)}} \leq 3.0 \text{ for SAR-1g, } \leq 7.5 \text{ for SAR-10g}$$

When the minimum test separation distance is < 5 mm, a distance of 5 mm is applied to determine SAR test exclusion.

Mode	Max. Tune-up Power (dBm)	Max. Tune-up Power (mW)	Body-Worn		
			Ant. to Surface (mm)	Calculated Result	Require SAR Testing?
BT (2.48GHz)	5.0	3.16	10	0.5	No

### Note:

1. When separation distance <= 50 mm and the calculated result shown in above table is <= 3.0 for SAR-1g exposure condition, or <= 7.5 for SAR-10g exposure condition, the SAR testing exclusion is applied.

## 4.2.5 Simultaneous Transmission Possibilities

The simultaneous transmission possibilities for this device are listed as below.

Simultaneous TX Combination	Capable Transmit Configurations	Head (Voice / VoIP)	Body-worn (Voice / VoIP)	Hotspot (Data)
1	GSM850 (Voice / Data) + WLAN (Data)	Yes	Yes	Yes
2	GSM1900 (Voice / Data) + WLAN (Data)	Yes	Yes	Yes
3	WCDMA II (Voice / Data) + WLAN (Data)	Yes	Yes	Yes
4	WCDMA IV (Voice / Data) + WLAN (Data)	Yes	Yes	Yes
5	WCDMA V (Voice / Data) + WLAN (Data)	Yes	Yes	Yes
6	GSM850 (Voice / Data) + BT (Data)	No	Yes	No
7	GSM1900 (Voice / Data) + BT (Data)	No	Yes	No
8	WCDMA II (Voice / Data) + BT (Data)	No	Yes	No
9	WCDMA IV (Voice / Data) + BT (Data)	No	Yes	No
10	WCDMA V (Voice / Data) + BT (Data)	No	Yes	No

**Note :** The WLAN and Bluetooth cannot transmit simultaneously, so there is no co-location test requirement for WLAN and Bluetooth.

### 4.3 Tissue Verification

The measuring results for tissue simulating liquid are shown as below.

Test Date	Tissue Type	Frequency (MHz)	Liquid Temp. (°C)	Measured Conductivity (σ)	Measured Permittivity (ε <sub>r</sub> )	Target Conductivity (σ)	Target Permittivity (ε <sub>r</sub> )	Conductivity Deviation (%)	Permittivity Deviation (%)
Nov. 26, 2018	H835	835	22.1	0.896	41.630	0.90	41.50	-0.44	0.31
Nov. 25, 2018	H1750	1750	22.3	1.325	40.767	1.37	40.10	-3.28	1.66
Nov. 25, 2018	H1900	1900	22.3	1.374	39.600	1.40	40.00	-1.86	-1.00
Dec. 07, 2018	H2450	2450	22.1	1.845	39.398	1.80	39.20	2.50	0.51
Nov. 24, 2018	B835	835	22.2	0.957	56.355	0.97	55.20	-1.34	2.09
Nov. 22, 2018	B1750	1750	22.1	1.544	53.577	1.49	53.40	3.62	0.33
Nov. 22, 2018	B1900	1900	22.1	1.567	53.538	1.52	53.30	3.09	0.45
Dec. 08, 2018	B2450	2450	22.1	1.898	51.712	1.95	52.70	-2.67	-1.87

**Note:**

The dielectric properties of the tissue simulating liquid must be measured within 24 hours before the SAR testing and within ±5% of the target values. Liquid temperature during the SAR testing must be within ±2 °C.

### 4.4 System Validation

The SAR measurement system was validated according to procedures in KDB 865664 D01. The validation status in tabulated summary is as below.

Test Date	Probe S/N	Calibration Point		Measured Conductivity (σ)	Measured Permittivity (ε <sub>r</sub> )	Validation for CW			Validation for Modulation		
						Sensitivity Range	Probe Linearity	Probe Isotropy	Modulation Type	Duty Factor	PAR
Nov. 26, 2018	3873	Head	835	0.966	55.259	Pass	Pass	Pass	GMSK	Pass	N/A
Nov. 25, 2018	3873	Head	1750	0.993	56.738	Pass	Pass	Pass	N/A	N/A	N/A
Nov. 25, 2018	3873	Head	1900	0.968	55.273	Pass	Pass	Pass	N/A	N/A	N/A
Dec. 07, 2018	3873	Head	2450	1.447	53.388	Pass	Pass	Pass	OFDM	N/A	Pass
Nov. 24, 2018	3873	Body	835	1.535	51.016	Pass	Pass	Pass	GMSK	Pass	N/A
Nov. 22, 2018	3873	Body	1750	1.544	53.431	Pass	Pass	Pass	N/A	N/A	N/A
Nov. 22, 2018	3873	Body	1900	1.958	50.929	Pass	Pass	Pass	N/A	N/A	N/A
Dec. 08, 2018	3873	Body	2450	5.278	48.936	Pass	Pass	Pass	OFDM	N/A	Pass

**4.5 System Verification**

The measuring result for system verification is tabulated as below.

Test Date	Mode	Frequency (MHz)	1W Target SAR-1g (W/kg)	Measured SAR-1g (W/kg)	Normalized to 1W SAR-1g (W/kg)	Deviation (%)	Dipole S/N	Probe S/N	DAE S/N
Nov. 26, 2018	Head	835	9.51	2.41	9.64	1.37	4d139	3873	1341
Nov. 25, 2018	Head	1750	36.80	9.61	38.44	4.46	1071	3873	1341
Nov. 25, 2018	Head	1900	39.80	10.40	41.60	4.52	5d159	3873	1341
Dec. 07, 2018	Head	2450	53.10	14.00	56.00	5.46	893	3873	1341
Nov. 24, 2018	Body	835	9.70	2.47	9.88	1.86	4d139	3873	1341
Nov. 22, 2018	Body	1750	38.00	8.85	35.40	-6.84	1071	3873	1341
Nov. 22, 2018	Body	1900	40.20	10.40	41.60	3.48	5d159	3873	1341
Dec. 08, 2018	Body	2450	51.50	12.60	50.40	-2.14	893	3873	1341

**Note:**

Comparing to the reference SAR value provided by SPEAG, the validation data should be within its specification of 10 %. The result indicates the system check can meet the variation criterion and the plots can be referred to Appendix A of this report.

**4.6 Maximum Output Power**

**4.6.1 Maximum Conducted Power**

The maximum conducted average power (Unit: dBm) including tune-up tolerance is shown as below.

Mode	GSM850	GSM1900
GSM (GMSK, 1Tx-slot)	33.5	30.5
GPRS (GMSK, 1Tx-slot)	33.5	30.5
GPRS (GMSK, 2Tx-slot)	32.0	28.5
GPRS (GMSK, 3Tx-slot)	30.5	27.0
GPRS (GMSK, 4Tx-slot)	29.0	25.0

Mode	WCDMA Band II	WCDMA Band IV	WCDMA Band V
RMC 12.2K	23.5	23.5	23.5
HSDPA	22.5	22.0	22.5
HSUPA	23.0	22.5	22.5

Mode	2.4G WLAN
802.11b	17.0
802.11g	16.0
802.11n HT20	15.0

Mode	2.4G Bluetooth
GFSK	5.0
$\pi/4$ -DQPSK	4.0
8DPSK	4.0
LE	-7.5

# FCC SAR Test Report

## 4.6.2 Measured Conducted Power Result

The measuring conducted average power (Unit: dBm) is shown as below.

Band	GSM850			GSM1900		
Channel	128	189	251	512	661	810
Frequency (MHz)	824.2	836.4	848.8	1850.2	1880.0	1909.8
<b>Maximum Burst-Averaged Output Power</b>						
GSM (GMSK, 1Tx-slot)	33.11	33.15	<b>33.16</b>	29.42	29.42	<b>29.61</b>
GPRS (GMSK, 1Tx-slot)	33.12	33.15	33.15	29.39	29.37	29.57
GPRS (GMSK, 2Tx-slot)	31.43	31.48	31.49	27.59	27.55	27.74
GPRS (GMSK, 3Tx-slot)	29.83	29.92	29.99	26.24	26.20	26.40
GPRS (GMSK, 4Tx-slot)	28.10	28.20	28.31	24.45	24.41	24.59
<b>Maximum Frame-Averaged Output Power</b>						
GSM (GMSK, 1Tx-slot)	24.11	24.15	24.16	20.42	20.42	20.61
GPRS (GMSK, 1Tx-slot)	24.12	24.15	24.15	20.39	20.37	20.57
GPRS (GMSK, 2Tx-slot)	25.43	25.48	25.49	21.59	21.55	21.74
GPRS (GMSK, 3Tx-slot)	25.57	25.66	<b>25.73</b>	21.98	21.94	<b>22.14</b>
GPRS (GMSK, 4Tx-slot)	25.10	25.20	25.31	21.45	21.41	21.59

**Note:**

- SAR testing was performed on the maximum frame-averaged power mode.
- The frame-averaged power is linearly proportion to the slot number configured and it is linearly scaled the maximum burst-averaged power based on time slots. The calculated method is shown as below:

$$\text{Frame-averaged power} = 10 \times \log (\text{Burst-averaged power mW} \times \text{Slot used} / 8)$$

Band	WCDMA Band II			WCDMA Band IV			WCDMA Band V			3GPP MPR (dB)
Channel	9262	9400	9538	1312	1413	1513	4132	4182	4233	
Frequency (MHz)	1852.4	1880.0	1907.6	1712.4	1732.6	1752.6	826.4	836.4	846.6	
RMC 12.2K	22.74	<b>23.30</b>	22.98	<b>22.62</b>	22.14	22.29	22.70	<b>22.81</b>	22.69	-
HSDPA Subtest-1	21.89	22.45	22.13	21.77	21.29	21.44	21.85	21.96	21.84	0
HSDPA Subtest-2	21.82	22.38	22.06	21.70	21.22	21.37	21.78	21.89	21.77	0
HSDPA Subtest-3	21.38	21.94	21.62	21.26	20.78	20.93	21.34	21.45	21.33	0.5
HSDPA Subtest-4	21.33	21.89	21.57	21.21	20.73	20.88	21.29	21.40	21.28	0.5
HSUPA Subtest-1	22.25	22.81	22.49	22.13	21.65	21.80	22.21	22.32	22.20	0
HSUPA Subtest-2	20.21	20.77	20.45	20.09	19.61	19.76	20.17	20.28	20.16	2
HSUPA Subtest-3	21.18	21.74	21.42	21.06	20.58	20.73	21.14	21.25	21.13	1
HSUPA Subtest-4	20.29	20.85	20.53	20.17	19.69	19.84	20.25	20.36	20.24	2
HSUPA Subtest-5	22.31	22.87	22.55	22.19	21.71	21.86	22.27	22.38	22.26	0

# FCC SAR Test Report

## <WLAN 2.4G>

Mode	802.11b 1Mbps		
Channel / Frequency (MHz)	1 (2412)	6 (2437)	11 (2462)
Average Power	15.23	15.17	15.31
Mode	802.11g 6Mbps		
Channel / Frequency (MHz)	1 (2412)	6 (2437)	11 (2462)
Average Power	14.31	13.89	14.03
Mode	802.11n (HT20) MCS0 6.5Mbps		
Channel / Frequency (MHz)	1 (2412)	6 (2437)	11 (2462)
Average Power	12.80	13.28	12.53

## <Bluetooth>

Mode	Bluetooth GFSK		
Channel / Frequency (MHz)	0 (2402)	39 (2441)	78 (2480)
Average Power	3.28	4.12	4.18
Mode	Bluetooth $\pi/4$ -DQPSK		
Channel / Frequency (MHz)	0 (2402)	39 (2441)	78 (2480)
Average Power	2.76	2.70	3.13
Mode	Bluetooth 8DPSK		
Channel / Frequency (MHz)	0 (2402)	39 (2441)	78 (2480)
Average Power	2.71	2.72	3.13
Mode	Bluetooth LE		
Channel / Frequency (MHz)	0 (2402)	19 (2440)	39 (2480)
Average Power	-8.72	-9.00	-8.28

## **4.7 SAR Testing Results**

### **4.7.1 SAR Test Reduction Considerations**

#### **<KDB 447498 D01, General RF Exposure Guidance>**

Testing of other required channels within the operating mode of a frequency band is not required when the reported SAR for the mid-band or highest output power channel is:

- (1)  $\leq 0.8$  W/kg or 2.0 W/kg, for 1-g or 10-g respectively, when the transmission band is  $\leq 100$  MHz
- (2)  $\leq 0.6$  W/kg or 1.5 W/kg, for 1-g or 10-g respectively, when the transmission band is between 100 MHz and 200 MHz
- (3)  $\leq 0.4$  W/kg or 1.0 W/kg, for 1-g or 10-g respectively, when the transmission band is  $\geq 200$  MHz

#### **<KDB 941225 D01, 3G SAR Measurement Procedures>**

The mode tested for SAR is referred to as the primary mode. The equivalent modes considered for SAR test reduction are denoted as secondary modes. Both primary and secondary modes must be in the same frequency band. When the maximum output power and tune-up tolerance specified for production units in a secondary mode is  $\leq 1/4$  dB higher than the primary mode or when the highest reported SAR of the primary mode is scaled by the ratio of specified maximum output power and tune-up tolerance of secondary to primary mode and the adjusted SAR is  $\leq 1.2$  W/kg, SAR measurement is not required for the secondary mode.

#### **<KDB 248227 D01, SAR Guidance for Wi-Fi Transmitters>**

- (1) For handsets operating next to ear, hotspot mode or mini-tablet configurations, the initial test position procedures were applied. The test position with the highest extrapolated peak SAR will be used as the initial test position. When the reported SAR of initial test position is  $\leq 0.4$  W/kg, SAR testing for remaining test positions is not required. Otherwise, SAR is evaluated at the subsequent highest peak SAR positions until the reported SAR result is  $\leq 0.8$  W/kg or all test positions are measured.
- (2) For WLAN 2.4 GHz, the highest measured maximum output power channel for DSSS was selected for SAR measurement. When the reported SAR is  $\leq 0.8$  W/kg, no further SAR testing is required. Otherwise, SAR is evaluated at the next highest measured output power channel. When any reported SAR is  $> 1.2$  W/kg, SAR is required for the third channel. For OFDM modes (802.11g/n), SAR is not required when the highest reported SAR for DSSS is adjusted by the ratio of OFDM to DSSS specified maximum output power and it is  $\leq 1.2$  W/kg.



# FCC SAR Test Report

## 4.7.2 SAR Results for Head Exposure Condition

Plot No.	Band	Mode	Test Position	Ch.	Battery	Max. Tune-up Power (dBm)	Measured Conducted Power (dBm)	Power Drift	Measured SAR-1g (W/kg)	Scaling Factor	Scaled SAR-1g (W/kg)
1	GSM850	GPRS11	Right Cheek	251	1	30.5	29.99	0.17	0.423	1.12	<b>0.48</b>
	GSM850	GPRS11	Right Tilted	251	1	30.5	29.99	0.09	0.245	1.12	0.28
	GSM850	GPRS11	Left Cheek	251	1	30.5	29.99	0.06	0.356	1.12	0.40
	GSM850	GPRS11	Left Tilted	251	1	30.5	29.99	0.03	0.231	1.12	0.26
	GSM850	GPRS11	Right Cheek	251	2	30.5	29.99	0.19	0.394	1.12	0.44
	GSM850	GPRS11	Right Cheek	251	3	30.5	29.99	0.03	0.412	1.12	0.46
2	GSM1900	GPRS11	Right Cheek	810	1	27.0	26.40	0.09	0.352	1.15	0.40
	GSM1900	GPRS11	Right Tilted	810	1	27.0	26.40	0.10	0.118	1.15	0.14
	GSM1900	GPRS11	Left Cheek	810	1	27.0	26.40	0.14	0.371	1.15	<b>0.43</b>
	GSM1900	GPRS11	Left Tilted	810	1	27.0	26.40	0.04	0.151	1.15	0.17
	GSM1900	GPRS11	Left Cheek	810	2	27.0	26.40	-0.07	0.31	1.15	0.36
	GSM1900	GPRS11	Left Cheek	810	3	27.0	26.40	-0.06	0.362	1.15	0.42
3	WCDMA II	RMC12.2K	Right Cheek	9400	1	23.5	23.30	0.06	0.406	1.05	<b>0.43</b>
	WCDMA II	RMC12.2K	Right Tilted	9400	1	23.5	23.30	0.05	0.125	1.05	0.13
	WCDMA II	RMC12.2K	Left Cheek	9400	1	23.5	23.30	0.02	0.343	1.05	0.36
	WCDMA II	RMC12.2K	Left Tilted	9400	1	23.5	23.30	0.05	0.16	1.05	0.17
	WCDMA II	RMC12.2K	Right Cheek	9400	2	23.5	23.30	0.09	0.376	1.05	0.39
	WCDMA II	RMC12.2K	Right Cheek	9400	3	23.5	23.30	-0.05	0.391	1.05	0.41
4	WCDMA IV	RMC12.2K	Right Cheek	1312	1	23.5	22.62	0.01	0.209	1.22	<b>0.26</b>
	WCDMA IV	RMC12.2K	Right Tilted	1312	1	23.5	22.62	0.01	0.064	1.22	0.08
	WCDMA IV	RMC12.2K	Left Cheek	1312	1	23.5	22.62	0.07	0.201	1.22	0.25
	WCDMA IV	RMC12.2K	Left Tilted	1312	1	23.5	22.62	0.01	0.095	1.22	0.12
	WCDMA IV	RMC12.2K	Right Cheek	1312	2	23.5	22.62	0.04	0.19	1.22	0.23
	WCDMA IV	RMC12.2K	Right Cheek	1312	3	23.5	22.62	0.09	0.205	1.22	0.25
5	WCDMA V	RMC12.2K	Right Cheek	4182	1	23.5	22.81	-0.01	0.247	1.17	<b>0.29</b>
	WCDMA V	RMC12.2K	Right Tilted	4182	1	23.5	22.81	0.00	0.132	1.17	0.15
	WCDMA V	RMC12.2K	Left Cheek	4182	1	23.5	22.81	0.02	0.215	1.17	0.25
	WCDMA V	RMC12.2K	Left Tilted	4182	1	23.5	22.81	-0.11	0.143	1.17	0.17
	WCDMA V	RMC12.2K	Right Cheek	4182	2	23.5	22.81	0.09	0.237	1.17	0.28
	WCDMA V	RMC12.2K	Right Cheek	4182	3	23.5	22.81	0.03	0.246	1.17	0.29

Plot No.	Band	Mode	Test Position	Ch.	Battery	Duty Cycle	Max. Tune-up Power (dBm)	Measured Conducted Power (dBm)	Power Drift	Measured SAR-1g (W/kg)	Scaling Factor	Scaled SAR-1g (W/kg)
6	802.11b	-	Right Cheek	11	1	1	17.0	15.31	0.05	0.254	1.48	0.37
	802.11b	-	Right Tilted	11	1	1	17.0	15.31	0.02	0.269	1.48	0.40
	802.11b	-	Left Cheek	11	1	1	17.0	15.31	0.06	0.408	1.48	<b>0.60</b>
	802.11b	-	Left Tilted	11	1	1	17.0	15.31	0.06	0.175	1.48	0.26
	802.11b	-	Left Cheek	11	2	1	17.0	15.31	-0.03	0.4	1.48	0.59
	802.11b	-	Left Cheek	11	3	1	17.0	15.31	-0.01	0.395	1.48	0.58

# FCC SAR Test Report

## 4.7.3 SAR Results for Body-worn Exposure Condition (Separation Distance is 1.0 cm Gap)

Plot No.	Band	Mode	Test Position	Ch.	Battery	Max. Tune-up Power (dBm)	Measured Conducted Power (dBm)	Power Drift	Measured SAR-1g (W/kg)	Scaling Factor	Scaled SAR-1g (W/kg)
	GSM850	GPRS11	Front Face	251	1	30.5	29.99	-0.04	0.557	1.12	0.63
	GSM850	GPRS11	Rear Face	251	1	30.5	29.99	0.02	0.769	1.12	0.86
10	GSM850	GPRS11	Rear Face	128	1	30.5	29.83	-0.02	0.926	1.17	1.08
	GSM850	GPRS11	Rear Face	189	1	30.5	29.92	-0.02	0.866	1.14	0.99
	GSM850	GPRS11	Rear Face	128	2	30.5	29.83	-0.04	0.913	1.17	1.07
	GSM850	GPRS11	Rear Face	128	3	30.5	29.83	0.03	0.905	1.17	1.06
	GSM850	GPRS11	Rear Face	128	1	30.5	29.83	-0.10	0.921	1.17	1.07
	GSM1900	GPRS11	Front Face	810	1	27.0	26.40	-0.06	0.759	1.15	0.87
	GSM1900	GPRS11	Rear Face	810	1	27.0	26.40	-0.06	0.77	1.15	0.88
	GSM1900	GPRS11	Front Face	512	1	27.0	26.24	0.01	0.714	1.19	0.85
	GSM1900	GPRS11	Front Face	661	1	27.0	26.20	-0.04	0.779	1.20	0.94
	GSM1900	GPRS11	Rear Face	512	1	27.0	26.24	-0.12	0.759	1.19	0.90
7	GSM1900	GPRS11	Rear Face	661	1	27.0	26.20	-0.04	0.79	1.20	0.95
	GSM1900	GPRS11	Rear Face	661	2	27.0	26.20	0.03	0.789	1.20	0.95
	GSM1900	GPRS11	Rear Face	661	3	27.0	26.20	-0.01	0.786	1.20	0.94
	GSM1900	GPRS11	Rear Face	661	1	27.0	26.20	-0.06	0.777	1.20	0.93
	WCDMA II	RMC12.2K	Front Face	9400	1	23.5	23.30	-0.07	0.735	1.05	0.77
	WCDMA II	RMC12.2K	Rear Face	9400	1	23.5	23.30	-0.03	0.828	1.05	0.87
8	WCDMA II	RMC12.2K	Rear Face	9262	1	23.5	22.74	-0.04	0.746	1.19	0.89
	WCDMA II	RMC12.2K	Rear Face	9538	1	23.5	22.98	-0.02	0.704	1.13	0.79
	WCDMA II	RMC12.2K	Rear Face	9262	2	23.5	22.74	-0.11	0.741	1.19	0.89
	WCDMA II	RMC12.2K	Rear Face	9262	3	23.5	22.74	-0.07	0.738	1.19	0.89
	WCDMA II	RMC12.2K	Rear Face	9262	1	23.5	22.74	-0.01	0.742	1.19	0.89
	WCDMA IV	RMC12.2K	Front Face	1312	1	23.5	22.62	-0.07	0.594	1.22	0.73
9	WCDMA IV	RMC12.2K	Rear Face	1312	1	23.5	22.62	-0.07	0.638	1.22	0.78
	WCDMA IV	RMC12.2K	Rear Face	1312	2	23.5	22.62	-0.06	0.629	1.22	0.77
	WCDMA IV	RMC12.2K	Rear Face	1312	3	23.5	22.62	0.10	0.632	1.22	0.77
	WCDMA V	RMC12.2K	Front Face	4182	1	23.5	22.81	-0.02	0.339	1.17	0.40
14	WCDMA V	RMC12.2K	Rear Face	4182	1	23.5	22.81	0.03	0.45	1.17	0.53
	WCDMA V	RMC12.2K	Rear Face	4182	2	23.5	22.81	0.02	0.416	1.17	0.49
	WCDMA V	RMC12.2K	Rear Face	4182	3	23.5	22.81	0.07	0.448	1.17	0.53

Plot No.	Band	Mode	Test Position	Ch.	Battery	Max. Tune-up Power (dBm)	Measured Conducted Power (dBm)	Power Drift	Measured SAR-1g (W/kg)	Scaling Factor	Scaled SAR-1g (W/kg)
	802.11b	-	Front Face	11	1	17.0	15.31	0.05	0.059	1.48	0.09
15	802.11b	-	Rear Face	11	1	17.0	15.31	0.07	0.098	1.48	0.14
	802.11b	-	Rear Face	11	2	17.0	15.31	0.01	0.091	1.48	0.13
	802.11b	-	Rear Face	11	3	17.0	15.31	-0.05	0.095	1.48	0.14

# FCC SAR Test Report

## 4.7.4 SAR Results for Hotspot Exposure Condition (Separation Distance is 1.0 cm Gap)

Plot No.	Band	Mode	Test Position	Ch.	Battery	Max. Tune-up Power (dBm)	Measured Conducted Power (dBm)	Power Drift	Measured SAR-1g (W/kg)	Scaling Factor	Scaled SAR-1g (W/kg)
	GSM850	GPRS11	Front Face	251	1	30.5	29.99	-0.04	0.557	1.12	0.63
	GSM850	GPRS11	Rear Face	251	1	30.5	29.99	0.02	0.769	1.12	0.86
	GSM850	GPRS11	Left Side	251	1	30.5	29.99	0.01	0.481	1.12	0.54
	GSM850	GPRS11	Right Side	251	1	30.5	29.99	-0.03	0.758	1.12	0.85
	GSM850	GPRS11	Bottom Side	251	1	30.5	29.99	0.00	0.203	1.12	0.23
10	GSM850	GPRS11	Rear Face	128	1	30.5	29.83	-0.02	0.926	1.17	1.08
	GSM850	GPRS11	Rear Face	189	1	30.5	29.92	-0.02	0.866	1.14	0.99
	GSM850	GPRS11	Right Side	128	1	30.5	29.83	-0.01	0.864	1.17	1.01
	GSM850	GPRS11	Right Side	189	1	30.5	29.92	-0.02	0.844	1.14	0.96
	GSM850	GPRS11	Rear Face	128	2	30.5	29.83	-0.04	0.913	1.17	1.07
	GSM850	GPRS11	Rear Face	128	3	30.5	29.83	0.03	0.905	1.17	1.06
	GSM850	GPRS11	Rear Face	128	1	30.5	29.83	-0.10	0.921	1.17	1.07
	GSM1900	GPRS11	Front Face	810	1	27.0	26.40	-0.06	0.759	1.15	0.87
	GSM1900	GPRS11	Rear Face	810	1	27.0	26.40	-0.06	0.77	1.15	0.88
	GSM1900	GPRS11	Left Side	810	1	27.0	26.40	0.05	0.332	1.15	0.38
	GSM1900	GPRS11	Right Side	810	1	27.0	26.40	0.11	0.181	1.15	0.21
	GSM1900	GPRS11	Bottom Side	810	1	27.0	26.40	0.09	1.02	1.15	1.17
	GSM1900	GPRS11	Front Face	512	1	27.0	26.24	0.01	0.714	1.19	0.85
	GSM1900	GPRS11	Front Face	661	1	27.0	26.20	-0.04	0.779	1.20	0.94
	GSM1900	GPRS11	Rear Face	512	1	27.0	26.24	-0.12	0.759	1.19	0.90
	GSM1900	GPRS11	Rear Face	661	1	27.0	26.20	-0.01	0.79	1.20	0.95
	GSM1900	GPRS11	Bottom Side	512	1	27.0	26.24	-0.06	1.02	1.19	1.22
11	GSM1900	GPRS11	Bottom Side	661	1	27.0	26.20	-0.03	1.05	1.20	1.26
	GSM1900	GPRS11	Bottom Side	661	2	27.0	26.20	-0.06	1.05	1.20	1.26
	GSM1900	GPRS11	Bottom Side	661	3	27.0	26.20	-0.06	1.05	1.20	1.26
	GSM1900	GPRS11	Bottom Side	661	1	27.0	26.20	-0.12	1.04	1.20	1.25
	WCDMA II	RMC12.2K	Front Face	9400	1	23.5	23.30	-0.07	0.735	1.05	0.77
	WCDMA II	RMC12.2K	Rear Face	9400	1	23.5	23.30	-0.03	0.828	1.05	0.87
	WCDMA II	RMC12.2K	Left Side	9400	1	23.5	23.30	0.11	0.315	1.05	0.33
	WCDMA II	RMC12.2K	Right Side	9400	1	23.5	23.30	-0.01	0.162	1.05	0.17
12	WCDMA II	RMC12.2K	Bottom Side	9400	1	23.5	23.30	-0.03	1.23	1.05	1.29
	WCDMA II	RMC12.2K	Rear Face	9262	1	23.5	22.74	-0.04	0.746	1.19	0.89
	WCDMA II	RMC12.2K	Rear Face	9538	1	23.5	22.98	-0.02	0.704	1.13	0.79
	WCDMA II	RMC12.2K	Bottom Side	9262	1	23.5	22.74	0.00	1	1.19	1.19
	WCDMA II	RMC12.2K	Bottom Side	9538	1	23.5	22.98	0.00	0.894	1.13	1.01
	WCDMA II	RMC12.2K	Bottom Side	9400	2	23.5	23.30	-0.11	1.19	1.05	1.25
	WCDMA II	RMC12.2K	Bottom Side	9400	3	23.5	23.30	0.01	1.15	1.05	1.20
	WCDMA II	RMC12.2K	Bottom Side	9400	1	23.5	23.30	-0.03	1.21	1.05	1.27
	WCDMA IV	RMC12.2K	Front Face	1312	1	23.5	22.62	-0.07	0.594	1.22	0.73
	WCDMA IV	RMC12.2K	Rear Face	1312	1	23.5	22.62	-0.07	0.638	1.22	0.78
	WCDMA IV	RMC12.2K	Left Side	1312	1	23.5	22.62	0.02	0.229	1.22	0.28
	WCDMA IV	RMC12.2K	Right Side	1312	1	23.5	22.62	-0.02	0.081	1.22	0.10
13	WCDMA IV	RMC12.2K	Bottom Side	1312	1	23.5	22.62	-0.05	0.656	1.22	0.80
	WCDMA IV	RMC12.2K	Bottom Side	1413	1	23.5	22.14	0.02	0.556	1.37	0.76
	WCDMA IV	RMC12.2K	Bottom Side	1513	1	23.5	22.29	0.03	0.568	1.32	0.75
	WCDMA IV	RMC12.2K	Bottom Side	1312	2	23.5	22.62	-0.11	0.654	1.22	0.80
	WCDMA IV	RMC12.2K	Bottom Side	1312	3	23.5	22.62	-0.11	0.655	1.22	0.80
	WCDMA IV	RMC12.2K	Bottom Side	1312	1	23.5	22.62	-0.01	0.648	1.22	0.79

# FCC SAR Test Report

Plot No.	Band	Mode	Test Position	Ch.	Battery	Max. Tune-up Power (dBm)	Measured Conducted Power (dBm)	Power Drift	Measured SAR-1g (W/kg)	Scaling Factor	Scaled SAR-1g (W/kg)
	WCDMA V	RMC12.2K	Front Face	4182	1	23.5	22.81	-0.02	0.339	1.17	0.40
14	WCDMA V	RMC12.2K	Rear Face	4182	1	23.5	22.81	0.03	0.45	1.17	<b>0.53</b>
	WCDMA V	RMC12.2K	Left Side	4182	1	23.5	22.81	0.05	0.194	1.17	0.23
	WCDMA V	RMC12.2K	Right Side	4182	1	23.5	22.81	0.05	0.41	1.17	0.48
	WCDMA V	RMC12.2K	Bottom Side	4182	1	23.5	22.81	0.08	0.239	1.17	0.28
	WCDMA V	RMC12.2K	Rear Face	4182	2	23.5	22.81	0.02	0.416	1.17	0.49
	WCDMA V	RMC12.2K	Rear Face	4182	3	23.5	22.81	0.07	0.448	1.17	0.53

Plot No.	Band	Mode	Test Position	Ch.	Battery	Max. Tune-up Power (dBm)	Measured Conducted Power (dBm)	Power Drift	Measured SAR-1g (W/kg)	Scaling Factor	Scaled SAR-1g (W/kg)
	802.11b	-	Front Face	11	1	17.0	15.31	0.05	0.059	1.48	0.09
15	802.11b	-	Rear Face	11	1	17.0	15.31	0.07	0.098	1.48	<b>0.14</b>
	802.11b	-	Right Side	11	1	17.0	15.31	0.10	0.052	1.48	0.08
	802.11b	-	Top Side	11	1	17.0	15.31	0.12	0.066	1.48	0.10
	802.11b	-	Rear Face	11	2	17.0	15.31	0.01	0.091	1.48	0.13
	802.11b	-	Rear Face	11	3	17.0	15.31	-0.05	0.095	1.48	0.14

## 4.7.5 SAR Measurement Variability

According to KDB 865664 D01, SAR measurement variability was assessed for each frequency band, which is determined by the SAR probe calibration point and tissue-equivalent medium used for the device measurements. When both head and body tissue-equivalent media are required for SAR measurements in a frequency band, the variability measurement procedures should be applied to the tissue medium with the highest measured SAR, using the highest measured SAR configuration for that tissue-equivalent medium. Alternatively, if the highest measured SAR for both head and body tissue-equivalent media are  $\leq 1.45$  W/kg and the ratio of these highest SAR values, i.e., largest divided by smallest value, is  $\leq 1.10$ , the highest SAR configuration for either head or body tissue-equivalent medium may be used to perform the repeated measurement. These additional measurements are repeated after the completion of all measurements requiring the same head or body tissue-equivalent medium in a frequency band. The test device should be returned to ambient conditions (normal room temperature) with the battery fully charged before it is re-mounted on the device holder for the repeated measurement(s) to minimize any unexpected variations in the repeated results.

SAR repeated measurement procedure:

1. When the highest measured SAR is  $< 0.80$  W/kg, repeated measurement is not required.
2. When the highest measured SAR is  $\geq 0.80$  W/kg, repeat that measurement once.
3. If the ratio of largest to smallest SAR for the original and first repeated measurements is  $> 1.20$ , or when the original or repeated measurement is  $\geq 1.45$  W/kg, perform a second repeated measurement.
4. If the ratio of largest to smallest SAR for the original, first and second repeated measurements is  $> 1.20$ , and the original, first or second repeated measurement is  $\geq 1.5$  W/kg, perform a third repeated measurement.

Band	Mode	Test Position	Ch.	Original Measured SAR-1g (W/kg)	1st Repeated SAR-1g (W/kg)	L/S Ratio	2nd Repeated SAR-1g (W/kg)	L/S Ratio	3rd Repeated SAR-1g (W/kg)	L/S Ratio
GSM850	GPRS11	Rear Face	128	0.926	0.921	1.01	N/A	N/A	N/A	N/A
GSM1900	GPRS11	Rear Face	661	0.79	0.777	1.02	N/A	N/A	N/A	N/A
WCDMA II	RMC12.2K	Rear Face	9262	0.746	0.742	1.01	N/A	N/A	N/A	N/A
WCDMA II	RMC12.2K	Bottom Side	9400	1.23	1.21	1.02	N/A	N/A	N/A	N/A
WCDMA IV	RMC12.2K	Bottom Side	1312	0.656	0.648	1.01	N/A	N/A	N/A	N/A

**4.7.6 Simultaneous Multi-band Transmission Evaluation**

**<Estimated SAR Calculation>**

According to KDB 447498 D01, when standalone SAR test exclusion applies to an antenna that transmits simultaneously with other antennas, the standalone SAR was estimated according to following formula to result in substantially conservative SAR values of <= 0.4 W/kg to determine simultaneous transmission SAR test exclusion.

$$\text{Estimated SAR} = \frac{\text{Max. Tune up Power}_{(mW)}}{\text{Min. Test Separation Distance}_{(mm)}} \times \frac{\sqrt{f_{(GHz)}}}{7.5}$$

If the minimum test separation distance is < 5 mm, a distance of 5 mm is used for estimated SAR calculation. When the test separation distance is > 50 mm, the 0.4 W/kg is used for SAR-1g.

Mode / Band	Frequency (GHz)	Max. Tune-up Power (dBm)	Test Position	Separation Distance (mm)	Estimated SAR (W/kg)
BT (DSS)	2.48	5.0	Body-worn	10	0.07

**Note:**

1. The separation distance is determined from the outer housing of the EUT to the user.
2. When standalone SAR testing is not required, an estimated SAR can be applied to determine simultaneous transmission SAR test exclusion.

<SAR Summation Analysis>

Simultaneous transmission SAR test exclusion is determined for each operating configuration and exposure condition according to the reported standalone SAR of each applicable simultaneous transmitting antenna. When the sum of SAR<sub>1g</sub> of all simultaneously transmitting antennas in an operating mode and exposure condition combination is within the SAR limit (SAR<sub>1g</sub> 1.6 W/kg), the simultaneous transmission SAR is not required. When the sum of SAR<sub>1g</sub> is greater than the SAR limit (SAR<sub>1g</sub> 1.6 W/kg), SAR test exclusion is determined by the SPLSR.

No.	Conditions (SAR1 + SAR2)	Exposure Condition	Test Position	Max. SAR1	Max. SAR2	SAR Summation	SPLSR Analysis
1	GSM850 + WLAN (DTS)	Head	Right Cheek	0.48	0.37	<b>0.85</b>	Σ SAR < 1.6, Not required
			Right Tilted	0.28	0.40	<b>0.68</b>	Σ SAR < 1.6, Not required
			Left Cheek	0.40	0.60	<b>1.00</b>	Σ SAR < 1.6, Not required
			Left Tilted	0.26	0.26	<b>0.52</b>	Σ SAR < 1.6, Not required
		Body-Worn	Front Face	0.63	0.09	<b>0.72</b>	Σ SAR < 1.6, Not required
			Rear Face	1.08	0.14	<b>1.22</b>	Σ SAR < 1.6, Not required
		Hotspot	Front Face	0.63	0.09	<b>0.72</b>	Σ SAR < 1.6, Not required
			Rear Face	1.08	0.14	<b>1.22</b>	Σ SAR < 1.6, Not required
			Left Side	0.54	0.00	<b>0.54</b>	Σ SAR < 1.6, Not required
			Right Side	1.01	0.08	<b>1.09</b>	Σ SAR < 1.6, Not required
			Top Side	0.00	0.10	<b>0.10</b>	Σ SAR < 1.6, Not required
		Bottom Side	0.23	0.00	<b>0.23</b>	Σ SAR < 1.6, Not required	
2	GSM850 + BT (DSS)	Body-Worn	Front Face	0.63	0.07	<b>0.70</b>	Σ SAR < 1.6, Not required
			Rear Face	1.08	0.07	<b>1.15</b>	Σ SAR < 1.6, Not required

# FCC SAR Test Report

No.	Conditions (SAR1 + SAR2)	Exposure Condition	Test Position	Max. SAR1	Max. SAR2	SAR Summation	SPLSR Analysis
3	GSM1900 + WLAN (DTS)	Head	Right Cheek	0.40	0.37	<b>0.77</b>	$\Sigma$ SAR < 1.6, Not required
			Right Tilted	0.14	0.40	<b>0.54</b>	$\Sigma$ SAR < 1.6, Not required
			Left Cheek	0.43	0.60	<b>1.03</b>	$\Sigma$ SAR < 1.6, Not required
			Left Tilted	0.17	0.26	<b>0.43</b>	$\Sigma$ SAR < 1.6, Not required
		Body-Worn	Front Face	0.87	0.09	<b>0.96</b>	$\Sigma$ SAR < 1.6, Not required
			Rear Face	0.88	0.14	<b>1.02</b>	$\Sigma$ SAR < 1.6, Not required
		Hotspot	Front Face	0.94	0.09	<b>1.03</b>	$\Sigma$ SAR < 1.6, Not required
			Rear Face	0.95	0.14	<b>1.09</b>	$\Sigma$ SAR < 1.6, Not required
			Left Side	0.38	0.00	<b>0.38</b>	$\Sigma$ SAR < 1.6, Not required
			Right Side	0.21	0.08	<b>0.29</b>	$\Sigma$ SAR < 1.6, Not required
			Top Side	0.00	0.10	<b>0.10</b>	$\Sigma$ SAR < 1.6, Not required
		Bottom Side	1.26	0.00	<b>1.26</b>	$\Sigma$ SAR < 1.6, Not required	
4	GSM1900 + BT (DSS)	Body-Worn	Front Face	0.87	0.07	<b>0.94</b>	$\Sigma$ SAR < 1.6, Not required
			Rear Face	0.88	0.07	<b>0.95</b>	$\Sigma$ SAR < 1.6, Not required

No.	Conditions (SAR1 + SAR2)	Exposure Condition	Test Position	Max. SAR1	Max. SAR2	SAR Summation	SPLSR Analysis
5	WCDMA B2 + WLAN (DTS)	Head	Right Cheek	0.43	0.37	<b>0.80</b>	$\Sigma$ SAR < 1.6, Not required
			Right Tilted	0.13	0.40	<b>0.53</b>	$\Sigma$ SAR < 1.6, Not required
			Left Cheek	0.36	0.60	<b>0.96</b>	$\Sigma$ SAR < 1.6, Not required
			Left Tilted	0.17	0.26	<b>0.43</b>	$\Sigma$ SAR < 1.6, Not required
		Body-Worn	Front Face	0.77	0.09	<b>0.86</b>	$\Sigma$ SAR < 1.6, Not required
			Rear Face	0.89	0.14	<b>1.03</b>	$\Sigma$ SAR < 1.6, Not required
		Hotspot	Front Face	0.77	0.09	<b>0.86</b>	$\Sigma$ SAR < 1.6, Not required
			Rear Face	0.88	0.14	<b>1.02</b>	$\Sigma$ SAR < 1.6, Not required
			Left Side	0.33	0.00	<b>0.33</b>	$\Sigma$ SAR < 1.6, Not required
			Right Side	0.17	0.08	<b>0.25</b>	$\Sigma$ SAR < 1.6, Not required
			Top Side	0.00	0.10	<b>0.10</b>	$\Sigma$ SAR < 1.6, Not required
		Bottom Side	1.29	0.00	<b>1.29</b>	$\Sigma$ SAR < 1.6, Not required	
6	WCDMA B2 + BT (DSS)	Body-Worn	Front Face	0.77	0.07	<b>0.84</b>	$\Sigma$ SAR < 1.6, Not required
			Rear Face	0.89	0.07	<b>0.96</b>	$\Sigma$ SAR < 1.6, Not required



# FCC SAR Test Report

No.	Conditions (SAR1 + SAR2)	Exposure Condition	Test Position	Max. SAR1	Max. SAR2	SAR Summation	SPLSR Analysis
7	WCDMA B4 + WLAN (DTS)	Head	Right Cheek	0.26	0.37	<b>0.63</b>	$\Sigma$ SAR < 1.6, Not required
			Right Tilted	0.08	0.40	<b>0.48</b>	$\Sigma$ SAR < 1.6, Not required
			Left Cheek	0.25	0.60	<b>0.85</b>	$\Sigma$ SAR < 1.6, Not required
			Left Tilted	0.12	0.26	<b>0.38</b>	$\Sigma$ SAR < 1.6, Not required
		Body-Worn	Front Face	0.73	0.09	<b>0.82</b>	$\Sigma$ SAR < 1.6, Not required
			Rear Face	0.78	0.14	<b>0.92</b>	$\Sigma$ SAR < 1.6, Not required
		Hotspot	Front Face	0.73	0.09	<b>0.82</b>	$\Sigma$ SAR < 1.6, Not required
			Rear Face	0.78	0.14	<b>0.92</b>	$\Sigma$ SAR < 1.6, Not required
			Left Side	0.28	0.00	<b>0.28</b>	$\Sigma$ SAR < 1.6, Not required
			Right Side	0.10	0.08	<b>0.18</b>	$\Sigma$ SAR < 1.6, Not required
			Top Side	0.00	0.10	<b>0.10</b>	$\Sigma$ SAR < 1.6, Not required
		Bottom Side	0.80	0.00	<b>0.80</b>	$\Sigma$ SAR < 1.6, Not required	
8	WCDMA B4 + BT (DSS)	Body-Worn	Front Face	0.73	0.07	<b>0.80</b>	$\Sigma$ SAR < 1.6, Not required
			Rear Face	0.78	0.07	<b>0.85</b>	$\Sigma$ SAR < 1.6, Not required

No.	Conditions (SAR1 + SAR2)	Exposure Condition	Test Position	Max. SAR1	Max. SAR2	SAR Summation	SPLSR Analysis
9	WCDMA B5 + WLAN (DTS)	Head	Right Cheek	0.29	0.37	<b>0.66</b>	$\Sigma$ SAR < 1.6, Not required
			Right Tilted	0.15	0.40	<b>0.55</b>	$\Sigma$ SAR < 1.6, Not required
			Left Cheek	0.25	0.60	<b>0.85</b>	$\Sigma$ SAR < 1.6, Not required
			Left Tilted	0.17	0.26	<b>0.43</b>	$\Sigma$ SAR < 1.6, Not required
		Body-Worn	Front Face	0.40	0.09	<b>0.49</b>	$\Sigma$ SAR < 1.6, Not required
			Rear Face	0.53	0.14	<b>0.67</b>	$\Sigma$ SAR < 1.6, Not required
		Hotspot	Front Face	0.40	0.09	<b>0.49</b>	$\Sigma$ SAR < 1.6, Not required
			Rear Face	0.53	0.14	<b>0.67</b>	$\Sigma$ SAR < 1.6, Not required
			Left Side	0.23	0.00	<b>0.23</b>	$\Sigma$ SAR < 1.6, Not required
			Right Side	0.48	0.08	<b>0.56</b>	$\Sigma$ SAR < 1.6, Not required
			Top Side	0.00	0.10	<b>0.10</b>	$\Sigma$ SAR < 1.6, Not required
		Bottom Side	0.28	0.00	<b>0.28</b>	$\Sigma$ SAR < 1.6, Not required	
10	WCDMA B5 + BT (DSS)	Body-Worn	Front Face	0.40	0.07	<b>0.47</b>	$\Sigma$ SAR < 1.6, Not required
			Rear Face	0.53	0.07	<b>0.60</b>	$\Sigma$ SAR < 1.6, Not required

Test Engineer : Xianxiong Qin

## 5. Calibration of Test Equipment

Equipment	Manufacturer	Model	SN	Cal. Date	Cal. Interval
System Validation Dipole	SPEAG	D835V2	4d139	Sep. 06, 2018	1 Year
System Validation Dipole	SPEAG	D1750V2	1071	Sep. 13, 2018	1 Year
System Validation Dipole	SPEAG	D1900V2	5d159	Sep. 11, 2018	1 Year
System Validation Dipole	SPEAG	D2450V2	893	Aug. 31, 2018	1 Year
System Validation Dipole	SPEAG	D2600V2	1110	Aug. 31, 2018	1 Year
Dosimetric E-Field Probe	SPEAG	EX3DV4	3873	Aug. 31, 2018	1 Year
Data Acquisition Electronics	SPEAG	DAE4	1341	Aug. 28, 2018	1 Year
Wireless Communication Test Set	Agilent	E5515C	MY50260600	May. 14, 2018	1 Year
ENA Series Network Analyzer	Agilent	E5071C	MY46214638	Jul. 09, 2018	1 Year
Spectrum Analyzer	KEYSIGHT	N9010A	MY54510355	Jul. 09, 2018	1 Year
MXG Analog Signal Generator	KEYSIGHT	N5183A	MY50143024	Mar. 14, 2018	1 Year
Power Meter	Agilent	N1914A	MY52180044	Aug. 12, 2018	2 Years
Power Sensor	Agilent	E9304A H18	MY52050011	Jan. 04, 2018	1 Year
Power Meter	ANRITSU	ML2495A	1506002	Mar. 02, 2018	1 Year
Power Sensor	ANRITSU	MA2411B	1339353	Mar. 02, 2018	1 Year
Temp. & Humi. Recorder	CLOCK	HTC-1	157248	Jul. 11, 2018	1 Year
Electronic Thermometer	YONGFA	YF-160A	120100323	Sep. 14, 2018	1 Year
Coupler	Woken	0110A056020-10	COM27RW1A3	Sep. 14, 2018	1 Year

## 6. Measurement Uncertainty

Source of Uncertainty	Tolerance (± %)	Probability Distribution	Divisor	Ci (1g)	Ci (10g)	Standard Uncertainty (± %, 1g)	Standard Uncertainty (± %, 10g)	Vi
<b>Measurement System</b>								
Probe Calibration	6.0	Normal	1	1	1	6.0	6.0	∞
Axial Isotropy	4.7	Rectangular	√3	0.707	0.707	1.9	1.9	∞
Hemispherical Isotropy	9.6	Rectangular	√3	0.707	0.707	3.9	3.9	∞
Boundary Effect	1.0	Rectangular	√3	1	1	0.6	0.6	∞
Linearity	4.7	Rectangular	√3	1	1	2.7	2.7	∞
System Detection Limits	0.25	Rectangular	√3	1	1	0.14	0.14	∞
Readout Electronics	0.3	Normal	1	1	1	0.3	0.3	∞
Response Time	0.0	Rectangular	√3	1	1	0.0	0.0	∞
Integration Time	1.7	Rectangular	√3	1	1	1.0	1.0	∞
RF Ambient Conditions - Noise	3.0	Rectangular	√3	1	1	1.7	1.7	∞
RF Ambient Conditions - Reflections	3.0	Rectangular	√3	1	1	1.7	1.7	∞
Probe Positioner Mechanical Tolerance	0.4	Rectangular	√3	1	1	0.2	0.2	∞
Probe Positioning with Respect to Phantom Shell	2.9	Rectangular	√3	1	1	1.7	1.7	∞
Extrapolation, interpolation, and integration algorithms for max. SAR evaluation	2.0	Rectangular	√3	1	1	1.2	1.2	∞
<b>Test Sample Related</b>								
Test Sample Positioning	1.5 / 0.7	Normal	1	1	1	1.5	0.7	32
Device Holder Uncertainty	4.2 / 1.8	Normal	1	1	1	4.2	1.8	32
Output Power Variation - SAR Drift Measurement	5.0	Rectangular	√3	1	1	2.9	2.9	∞
<b>Phantom and Tissue Parameters</b>								
Phantom Uncertainty (Shape and Thickness Tolerances)	7.2	Rectangular	√3	1	1	4.2	4.2	∞
Liquid Conductivity - Deviation from Target Values	5.0	Rectangular	√3	0.64	0.43	1.8	1.2	∞
Liquid Conductivity - Measurement Uncertainty	1.0	Normal	1	0.64	0.43	0.6	0.4	25
Liquid Permittivity - Deviation from Target Values	5.0	Rectangular	√3	0.60	0.49	1.7	1.4	∞
Liquid Permittivity - Measurement Uncertainty	0.5	Normal	1	0.60	0.49	0.3	0.2	25
<b>Combined Standard Uncertainty</b>						± 11.2 %	± 10.4 %	
<b>Expanded Uncertainty (K=2)</b>						± 22.4 %	± 20.8 %	

Uncertainty budget for frequency range 300 MHz to 3 GHz

# FCC SAR Test Report



Source of Uncertainty	Tolerance (± %)	Probability Distribution	Divisor	Ci (1g)	Ci (10g)	Standard Uncertainty (± %, 1g)	Standard Uncertainty (± %, 10g)	Vi
<b>Measurement System</b>								
Probe Calibration	6.55	Normal	1	1	1	6.55	6.55	∞
Axial Isotropy	4.7	Rectangular	√3	0.707	0.707	1.9	1.9	∞
Hemispherical Isotropy	9.6	Rectangular	√3	0.707	0.707	3.9	3.9	∞
Boundary Effect	2.0	Rectangular	√3	1	1	1.2	1.2	∞
Linearity	4.7	Rectangular	√3	1	1	2.7	2.7	∞
System Detection Limits	0.25	Rectangular	√3	1	1	0.14	0.14	∞
Readout Electronics	0.3	Normal	1	1	1	0.3	0.3	∞
Response Time	0.0	Rectangular	√3	1	1	0.0	0.0	∞
Integration Time	1.7	Rectangular	√3	1	1	1.0	1.0	∞
RF Ambient Conditions - Noise	3.0	Rectangular	√3	1	1	1.7	1.7	∞
RF Ambient Conditions - Reflections	3.0	Rectangular	√3	1	1	1.7	1.7	∞
Probe Positioner Mechanical Tolerance	0.4	Rectangular	√3	1	1	0.2	0.2	∞
Probe Positioning with Respect to Phantom Shell	6.7	Rectangular	√3	1	1	3.9	3.9	∞
Extrapolation, interpolation, and integration algorithms for max. SAR evaluation	4.0	Rectangular	√3	1	1	2.3	2.3	∞
<b>Test Sample Related</b>								
Test Sample Positioning	1.5 / 0.7	Normal	1	1	1	1.5	0.7	32
Device Holder Uncertainty	4.2 / 1.8	Normal	1	1	1	4.2	1.8	32
Output Power Variation - SAR Drift Measurement	5.0	Rectangular	√3	1	1	2.9	2.9	∞
<b>Phantom and Tissue Parameters</b>								
Phantom Uncertainty (Shape and Thickness Tolerances)	7.6	Rectangular	√3	1	1	4.4	4.4	∞
Liquid Conductivity - Deviation from Target Values	5.0	Rectangular	√3	0.64	0.43	1.8	1.2	∞
Liquid Conductivity - Measurement Uncertainty	1.0	Normal	1	0.64	0.43	0.6	0.4	25
Liquid Permittivity - Deviation from Target Values	5.0	Rectangular	√3	0.60	0.49	1.7	1.4	∞
Liquid Permittivity - Measurement Uncertainty	0.5	Normal	1	0.60	0.49	0.3	0.2	25
<b>Combined Standard Uncertainty</b>						± 12.3 %	± 11.5 %	
<b>Expanded Uncertainty (K=2)</b>						± 24.6 %	± 23.0 %	

**Uncertainty budget for frequency range 3 GHz to 6 GHz**

## **7. Information on the Testing Laboratories**

We, BV 7LAYERS COMMUNICATIONS TECHNOLOGY (SHENZHEN) CO. LTD., were founded in 2015 to provide our best service in EMC, Radio, Telecom and Safety consultation. Our laboratories are accredited and approved according to ISO/IEC 17025.

If you have any comments, please feel free to contact us at the following:

Add: No. B102, Dazu Chuangxin Mansion, North of Beihuan Avenue, North Area, Hi-Tech Industry Park, Nanshan District, Shenzhen, Guangdong, China

Tel: 86-755-8869-6566

Fax: 86-755-8869-6577

**Email:** [customerservice.dg@cn.bureauveritas.com](mailto:customerservice.dg@cn.bureauveritas.com)

**Web Site:** [www.bureauveritas.com](http://www.bureauveritas.com)

The road map of all our labs can be found in our web site also.

**---END---**



## **Appendix A. SAR Plots of System Verification**

The plots for system verification with largest deviation for each SAR system combination are shown as follows.

## System Check\_H835\_181126

**DUT: Dipole:835 MHz;Type:D835V2; SN:4d139**

Communication System: CW; Frequency: 835 MHz;Duty Cycle: 1:1

Medium: HSL835\_1126 Medium parameters used:  $f = 835 \text{ MHz}$ ;  $\sigma = 0.896 \text{ S/m}$ ;  $\epsilon_r = 41.63$ ;  $\rho = 1000 \text{ kg/m}^3$

Ambient Temperature :  $23.3 \text{ }^\circ\text{C}$  ; Liquid Temperature :  $22.1 \text{ }^\circ\text{C}$

DASY5 Configuration:

- Probe: EX3DV4 - SN3873; ConvF(9.69, 9.69, 9.69); Calibrated: 2018/08/31;
- Sensor-Surface: 1.4mm (Mechanical Surface Detection)
- Electronics: DAE4 Sn1341; Calibrated: 2018/08/28
- Phantom: Left Phantom with CRP v5.0; Type: QD000P40CD; Serial: TP:1722
- Measurement SW: DASY52, Version 52.8 (8); SEMCAD X Version 14.6.10 (7331)

**Pin=250mW/Area Scan (71x121x1):** Interpolated grid:  $dx=1.500 \text{ mm}$ ,  $dy=1.500 \text{ mm}$   
Maximum value of SAR (interpolated) =  $3.17 \text{ W/kg}$

**Pin=250mW/Zoom Scan (5x5x7)/Cube 0:** Measurement grid:  $dx=8\text{mm}$ ,  $dy=8\text{mm}$ ,  $dz=5\text{mm}$   
Reference Value =  $58.79 \text{ V/m}$ ; Power Drift =  $0.05 \text{ dB}$   
Peak SAR (extrapolated) =  $3.59 \text{ W/kg}$   
**SAR(1 g) =  $2.41 \text{ W/kg}$ ; SAR(10 g) =  $1.58 \text{ W/kg}$**   
Maximum value of SAR (measured) =  $3.22 \text{ W/kg}$

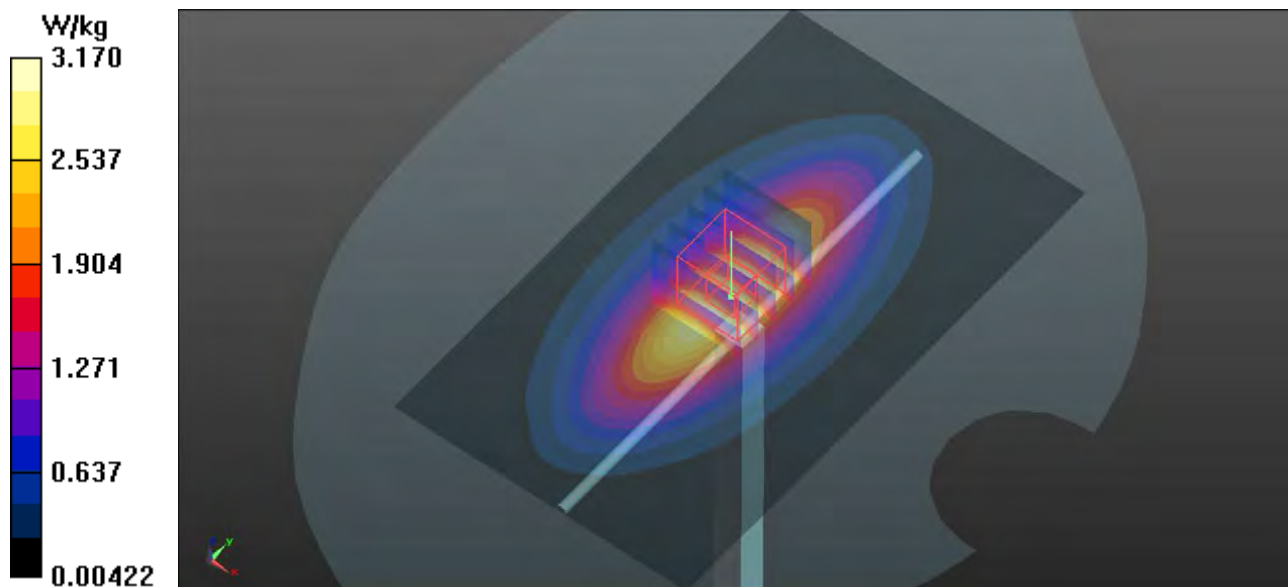

## System Check\_H1750\_181125

**DUT: Dipole:1750 MHz;Type:D1750V2; SN:1071**

Communication System: CW; Frequency: 1750 MHz;Duty Cycle: 1:1

Medium: HSL1750\_1125 Medium parameters used:  $f = 1750$  MHz;  $\sigma = 1.325$  S/m;  $\epsilon_r = 40.767$ ;  $\rho = 1000$  kg/m<sup>3</sup>

Ambient Temperature : 23.2 °C ; Liquid Temperature : 22.3 °C

DASY5 Configuration:

- Probe: EX3DV4 - SN3873; ConvF(8.39, 8.39, 8.39); Calibrated: 2018/08/31;
- Sensor-Surface: 1.4mm (Mechanical Surface Detection)
- Electronics: DAE4 Sn1341; Calibrated: 2018/08/28
- Phantom: Front Phantom with CRP v5.0; Type: QD000P40CD; Serial: TP:1695
- Measurement SW: DASY52, Version 52.8 (8); SEMCAD X Version 14.6.10 (7331)

**Pin=250mW/Area Scan (71x81x1):** Interpolated grid: dx=1.500 mm, dy=1.500 mm  
Maximum value of SAR (interpolated) = 14.6 W/kg

**Pin=250mW/Zoom Scan (5x5x7)/Cube 0:** Measurement grid: dx=8mm, dy=8mm, dz=5mm  
Reference Value = 104.8 V/m; Power Drift = 0.14 dB  
Peak SAR (extrapolated) = 17.2 W/kg  
**SAR(1 g) = 9.61 W/kg; SAR(10 g) = 5.19 W/kg**  
Maximum value of SAR (measured) = 14.5 W/kg

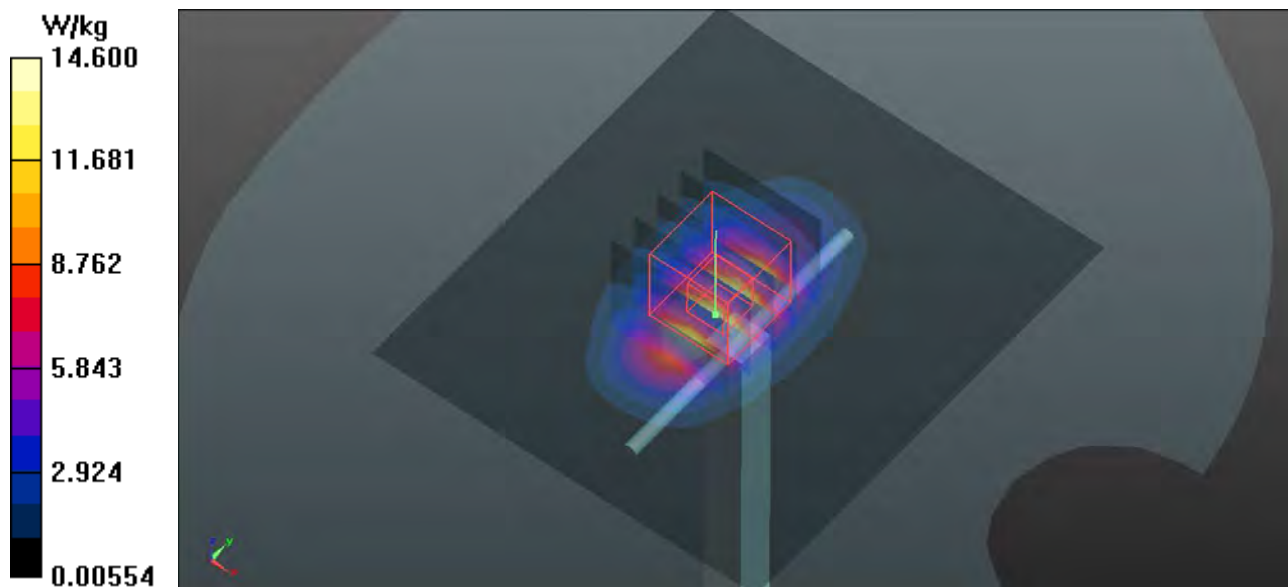



## System Check\_H1900\_181125

**DUT: Dipole:1900MHz;Type:D1900V2; SN:5d159**

Communication System: CW; Frequency: 1900 MHz;Duty Cycle: 1:1

Medium: HSL1900\_1125 Medium parameters used:  $f = 1900$  MHz;  $\sigma = 1.374$  S/m;  $\epsilon_r = 39.6$ ;  $\rho = 1000$  kg/m<sup>3</sup>

Ambient Temperature : 23.2 °C ; Liquid Temperature : 22.3 °C

DASY5 Configuration:

- Probe: EX3DV4 - SN3873; ConvF(8.12, 8.12, 8.12); Calibrated: 2018/08/31;
- Sensor-Surface: 1.4mm (Mechanical Surface Detection)
- Electronics: DAE4 Sn1341; Calibrated: 2018/08/28
- Phantom: Front Phantom with CRP v5.0; Type: QD000P40CD; Serial: TP:1695
- Measurement SW: DASY52, Version 52.8 (8); SEMCAD X Version 14.6.10 (7331)

**Pin=250mW/Area Scan (71x81x1):** Interpolated grid: dx=1.500 mm, dy=1.500 mm  
Maximum value of SAR (interpolated) = 15.9 W/kg

**Pin=250mW/Zoom Scan (5x5x7)/Cube 0:** Measurement grid: dx=8mm, dy=8mm, dz=5mm  
Reference Value = 103.0 V/m; Power Drift = 0.13 dB  
Peak SAR (extrapolated) = 19.0 W/kg  
**SAR(1 g) = 10.4 W/kg; SAR(10 g) = 5.43 W/kg**  
Maximum value of SAR (measured) = 15.9 W/kg

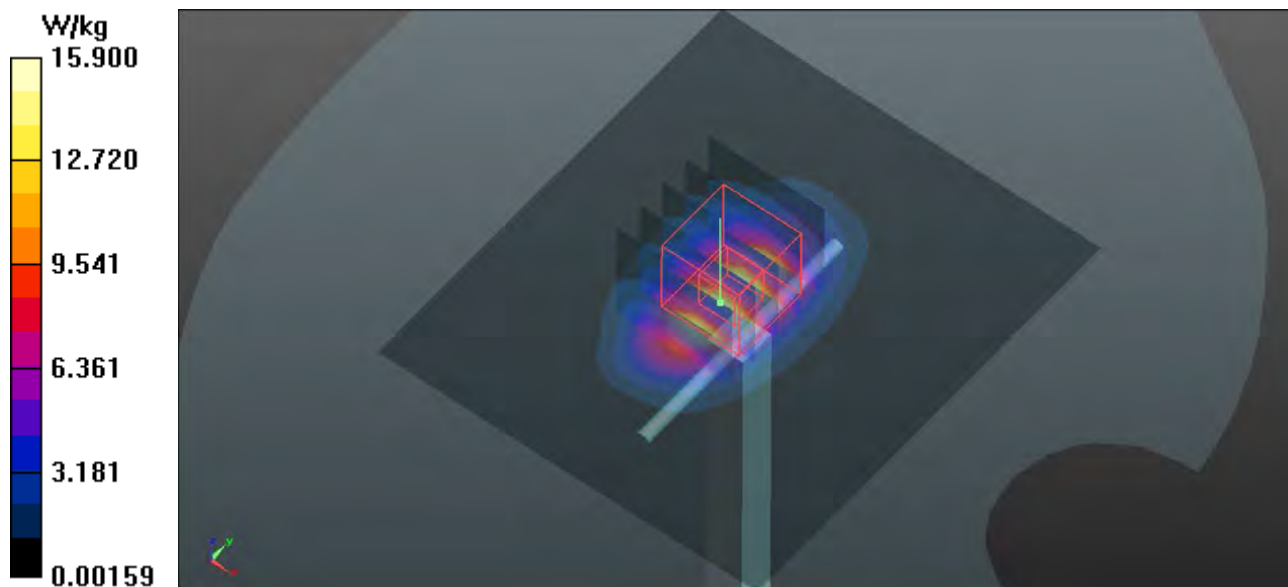

## System Check\_H2450\_181207

**DUT: Dipole:2450 MHz;Type:D2450V2; SN:893**

Communication System: CW; Frequency: 2450 MHz;Duty Cycle: 1:1

Medium: HSL2450\_1207 Medium parameters used:  $f = 2450$  MHz;  $\sigma = 1.845$  S/m;  $\epsilon_r = 39.398$ ;  $\rho = 1000$  kg/m<sup>3</sup>

Ambient Temperature : 23.1 °C ; Liquid Temperature : 22.1 °C

DASY5 Configuration:

- Probe: EX3DV4 - SN3873; ConvF(7.19, 7.19, 7.19); Calibrated: 2018/08/31;
- Sensor-Surface: 1.4mm (Mechanical Surface Detection)
- Electronics: DAE4 Sn1341; Calibrated: 2018/08/28
- Phantom: Front Phantom with CRP v5.0; Type: QD000P40CD; Serial: TP:1695
- Measurement SW: DASY52, Version 52.8 (8); SEMCAD X Version 14.6.10 (7331)

**Pin=250mW/Area Scan (71x81x1):** Interpolated grid: dx=1.200 mm, dy=1.200 mm  
Maximum value of SAR (interpolated) = 23.8 W/kg

**Pin=250mW/Zoom Scan (7x7x7)/Cube 0:** Measurement grid: dx=5mm, dy=5mm, dz=5mm  
Reference Value = 108.1 V/m; Power Drift = 0.10 dB  
Peak SAR (extrapolated) = 29.2 W/kg  
**SAR(1 g) = 14 W/kg; SAR(10 g) = 6.41 W/kg**  
Maximum value of SAR (measured) = 23.5 W/kg

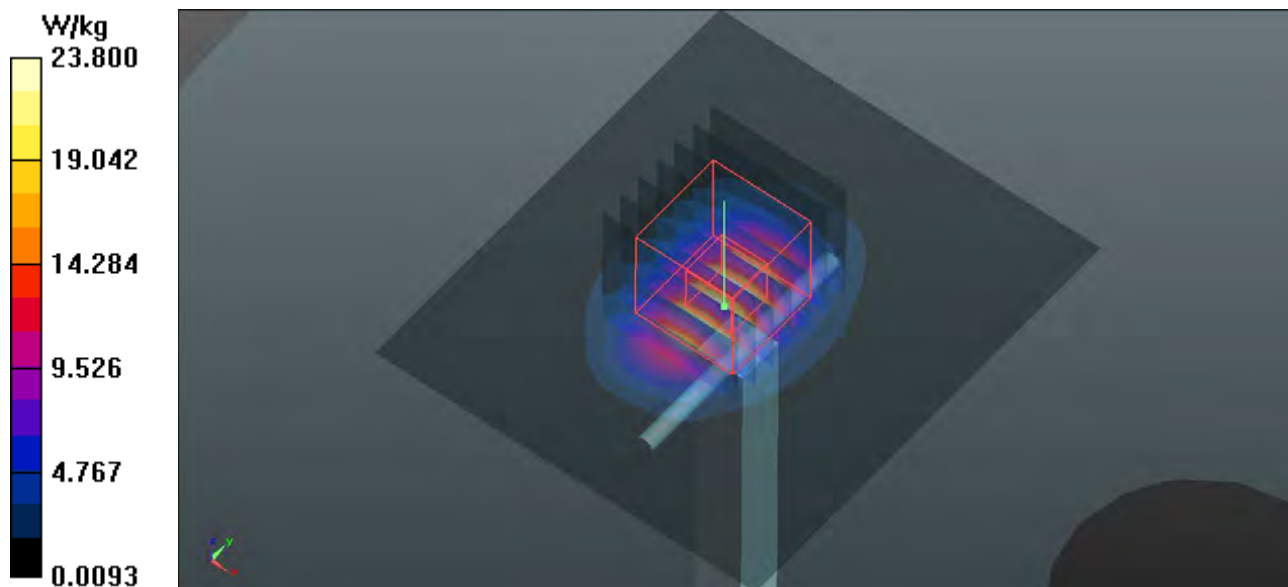

### System Check\_B835\_181124

**DUT: Dipole:835 MHz;Type:D835V2; SN:4d139**

Communication System: CW; Frequency: 835 MHz;Duty Cycle: 1:1

Medium: MSL835\_1124 Medium parameters used:  $f = 835 \text{ MHz}$ ;  $\sigma = 0.957 \text{ S/m}$ ;  $\epsilon_r = 56.355$ ;  $\rho = 1000 \text{ kg/m}^3$

Ambient Temperature : 23.2 °C ; Liquid Temperature : 22.2 °C

DASY5 Configuration:

- Probe: EX3DV4 - SN3873; ConvF(9.49, 9.49, 9.49); Calibrated: 2018/08/31;
- Sensor-Surface: 1.4mm (Mechanical Surface Detection)
- Electronics: DAE4 Sn1341; Calibrated: 2018/08/28
- Phantom: Left Phantom with CRP v5.0; Type: QD000P40CD; Serial: TP:1722
- Measurement SW: DASY52, Version 52.8 (8); SEMCAD X Version 14.6.10 (7331)

**Pin=250mW/Area Scan (71x121x1):** Interpolated grid:  $dx=1.500 \text{ mm}$ ,  $dy=1.500 \text{ mm}$   
Maximum value of SAR (interpolated) = 3.44 W/kg

**Pin=250mW/Zoom Scan (5x5x7)/Cube 0:** Measurement grid:  $dx=8\text{mm}$ ,  $dy=8\text{mm}$ ,  $dz=5\text{mm}$   
Reference Value = 59.66 V/m; Power Drift = -0.04 dB  
Peak SAR (extrapolated) = 3.92 W/kg  
**SAR(1 g) = 2.47 W/kg; SAR(10 g) = 1.68 W/kg**  
Maximum value of SAR (measured) = 3.51 W/kg

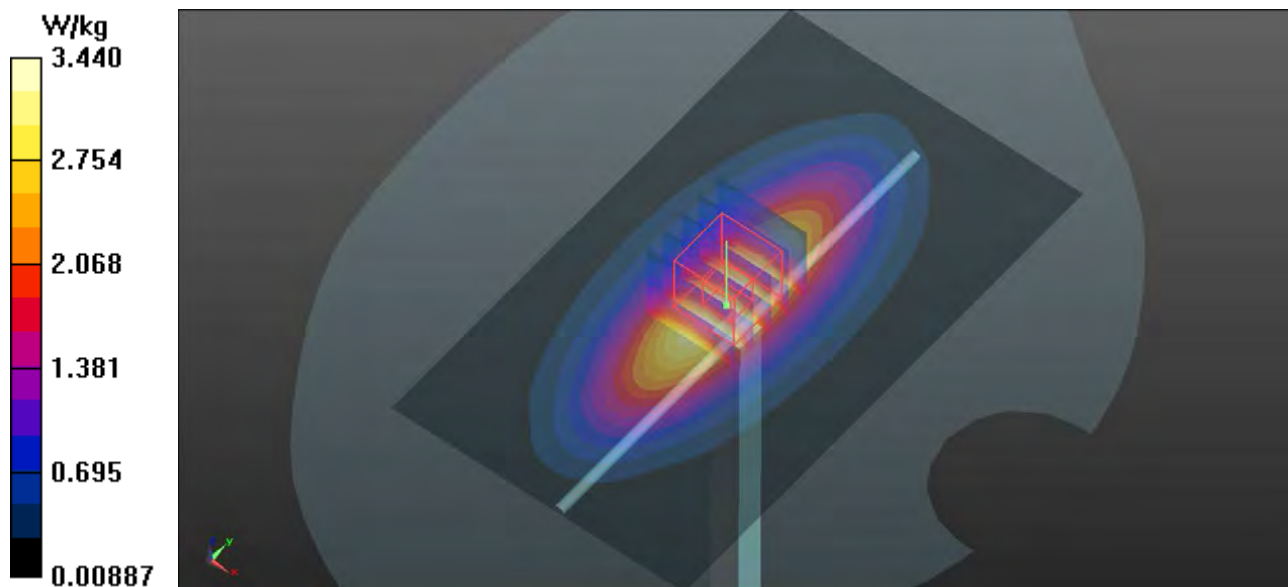

## System Check\_B1750\_181122

**DUT: Dipole:1750 MHz;Type:D1750V2; SN:1071**

Communication System: CW; Frequency: 1750 MHz;Duty Cycle: 1:1

Medium: MSL1750\_1122 Medium parameters used:  $f = 1750$  MHz;  $\sigma = 1.544$  S/m;  $\epsilon_r = 53.577$ ;  $\rho = 1000$  kg/m<sup>3</sup>

Ambient Temperature : 23.1 °C ; Liquid Temperature : 22.1 °C

DASY5 Configuration:

- Probe: EX3DV4 - SN3873; ConvF(7.8, 7.8, 7.8); Calibrated: 2018/08/31;
- Sensor-Surface: 1.4mm (Mechanical Surface Detection)
- Electronics: DAE4 Sn1341; Calibrated: 2018/08/28
- Phantom: Front Phantom with CRP v5.0; Type: QD000P40CD; Serial: TP:1695
- Measurement SW: DASY52, Version 52.8 (8); SEMCAD X Version 14.6.10 (7331)

**Pin=250mW/Area Scan (71x81x1):** Interpolated grid: dx=1.500 mm, dy=1.500 mm  
Maximum value of SAR (interpolated) = 13.1 W/kg

**Pin=250mW/Zoom Scan (5x5x7)/Cube 0:** Measurement grid: dx=8mm, dy=8mm, dz=5mm  
Reference Value = 93.38 V/m; Power Drift = 0.15 dB  
Peak SAR (extrapolated) = 15.4 W/kg  
**SAR(1 g) = 8.85 W/kg; SAR(10 g) = 4.76 W/kg**  
Maximum value of SAR (measured) = 13.3 W/kg

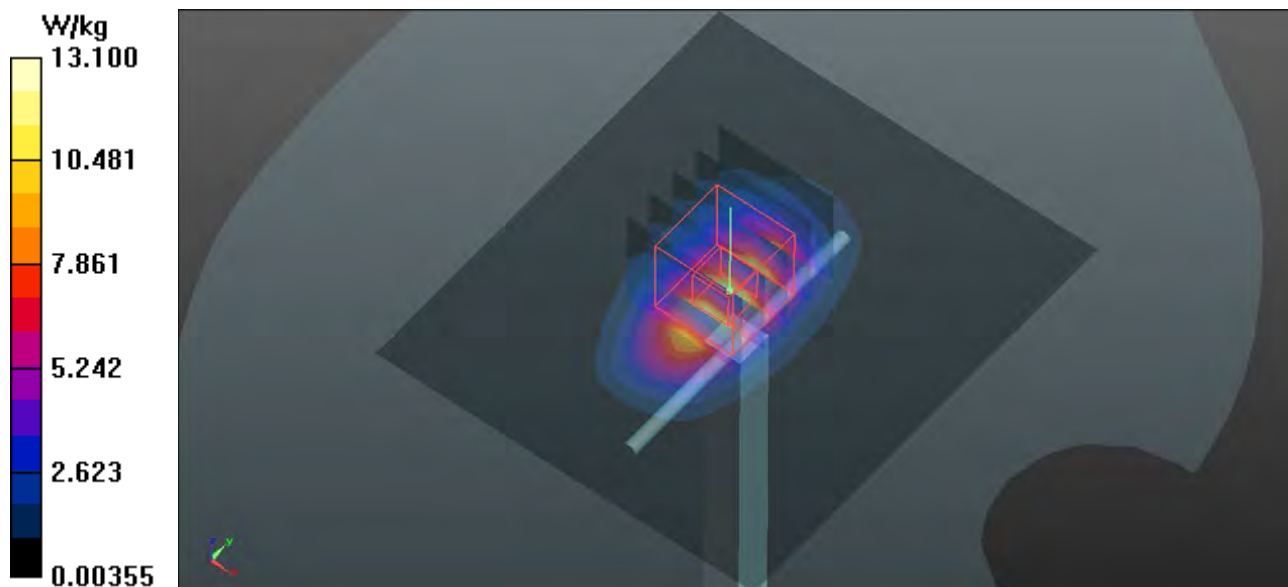

## System Check\_B1900\_181122

**DUT: Dipole:1900MHz;Type:D1900V2; SN:5d159**

Communication System: CW; Frequency: 1900 MHz;Duty Cycle: 1:1

Medium: MSL1900\_1122 Medium parameters used:  $f = 1900$  MHz;  $\sigma = 1.567$  S/m;  $\epsilon_r = 53.538$ ;  $\rho = 1000$  kg/m<sup>3</sup>

Ambient Temperature : 23.1 °C ; Liquid Temperature : 22.1 °C

DASY5 Configuration:

- Probe: EX3DV4 - SN3873; ConvF(7.61, 7.61, 7.61); Calibrated: 2018/08/31;
- Sensor-Surface: 1.4mm (Mechanical Surface Detection)
- Electronics: DAE4 Sn1341; Calibrated: 2018/08/28
- Phantom: Front Phantom with CRP v5.0; Type: QD000P40CD; Serial: TP:1695
- Measurement SW: DASY52, Version 52.8 (8); SEMCAD X Version 14.6.10 (7331)

**Pin=250mW/Area Scan (71x81x1):** Interpolated grid: dx=1.500 mm, dy=1.500 mm  
Maximum value of SAR (interpolated) = 16.0 W/kg

**Pin=250mW/Zoom Scan (5x5x7)/Cube 0:** Measurement grid: dx=8mm, dy=8mm, dz=5mm  
Reference Value = 97.69 V/m; Power Drift = 0.05 dB  
Peak SAR (extrapolated) = 18.7 W/kg  
**SAR(1 g) = 10.4 W/kg; SAR(10 g) = 5.44 W/kg**  
Maximum value of SAR (measured) = 15.7 W/kg

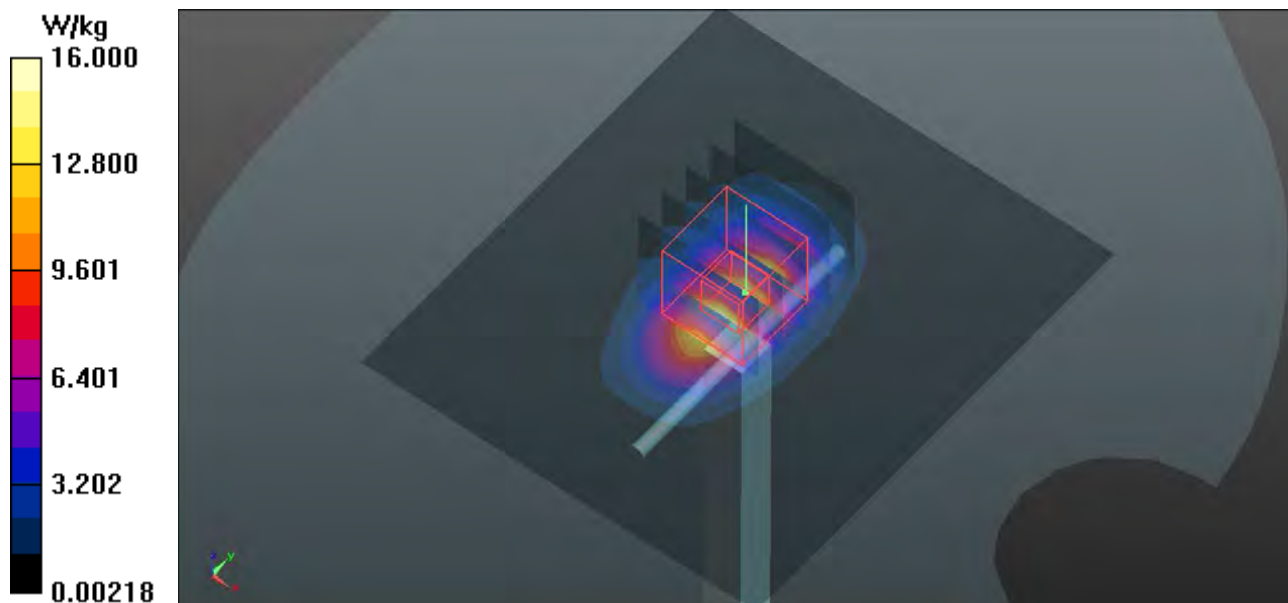

### System Check\_B2450\_181207

**DUT: Dipole:2450 MHz;Type:D2450V2; SN:893**

Communication System: CW; Frequency: 2450 MHz;Duty Cycle: 1:1

Medium: MSL2450\_1208 Medium parameters used:  $f = 2450$  MHz;  $\sigma = 1.898$  S/m;  $\epsilon_r = 51.712$ ;  $\rho = 1000$  kg/m<sup>3</sup>

Ambient Temperature : 23.1 °C ; Liquid Temperature : 22.1 °C

DASY5 Configuration:

- Probe: EX3DV4 - SN3873; ConvF(7.39, 7.39, 7.39); Calibrated: 2018/08/31;
- Sensor-Surface: 1.4mm (Mechanical Surface Detection)
- Electronics: DAE4 Sn1341; Calibrated: 2018/08/28
- Phantom: ELI v5.0; Type: QDOVA002AA; Serial: TP:1205
- Measurement SW: DASY52, Version 52.8 (8); SEMCAD X Version 14.6.10 (7331)

**Pin=250mW/Area Scan (91x101x1):** Interpolated grid: dx=1.200 mm, dy=1.200 mm  
Maximum value of SAR (interpolated) = 21.9 W/kg

**Pin=250mW/Zoom Scan (7x7x7)/Cube 0:** Measurement grid: dx=5mm, dy=5mm, dz=5mm  
Reference Value = 110.4 V/m; Power Drift = -0.09 dB  
Peak SAR (extrapolated) = 26.2 W/kg  
**SAR(1 g) = 12.6 W/kg; SAR(10 g) = 5.8 W/kg**  
Maximum value of SAR (measured) = 21.0 W/kg

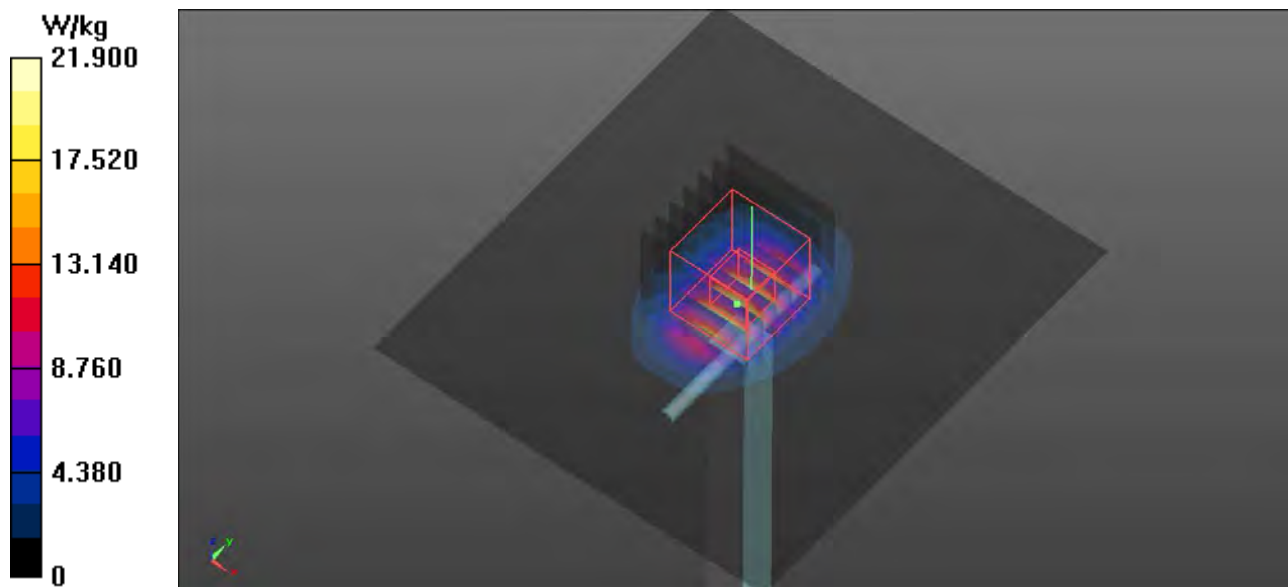



## **Appendix B. SAR Plots of SAR Measurement**

The SAR plots for highest measured SAR in each exposure configuration, wireless mode and frequency band combination, and measured SAR > 1.5 W/kg are shown as follows.

## P01 GSM 850\_GPRS11\_Right Cheek\_Ch251

### DUT: 181120W002

Communication System: GPRS11; Frequency: 848.8 MHz; Duty Cycle: 1:2.67

Medium: HSL835\_1126 Medium parameters used:  $f = 849$  MHz;  $\sigma = 0.905$  S/m;  $\epsilon_r = 41.551$ ;  $\rho =$

$1000$  kg/m<sup>3</sup>

Ambient Temperature : 23.3 °C; Liquid Temperature : 22.1 °C

#### DASY5 Configuration:

- Probe: EX3DV4 - SN3873; ConvF(9.69, 9.69, 9.69); Calibrated: 2018/08/31;
- Sensor-Surface: 1.4mm (Mechanical Surface Detection)
- Electronics: DAE4 Sn1341; Calibrated: 2018/08/28
- Phantom: Left Phantom with CRP v5.0; Type: QD000P40CD; Serial: TP:1722
- Measurement SW: DASY52, Version 52.8 (8); SEMCAD X Version 14.6.10 (7331)

- **Area Scan (71x121x1):** Interpolated grid: dx=1.500 mm, dy=1.500 mm

Maximum value of SAR (interpolated) = 0.484 W/kg

- **Zoom Scan (5x5x7)/Cube 0:** Measurement grid: dx=8mm, dy=8mm, dz=5mm

Reference Value = 7.078 V/m; Power Drift = 0.17 dB

Peak SAR (extrapolated) = 0.519 W/kg

**SAR(1 g) = 0.423 W/kg; SAR(10 g) = 0.325 W/kg**

Maximum value of SAR (measured) = 0.488 W/kg

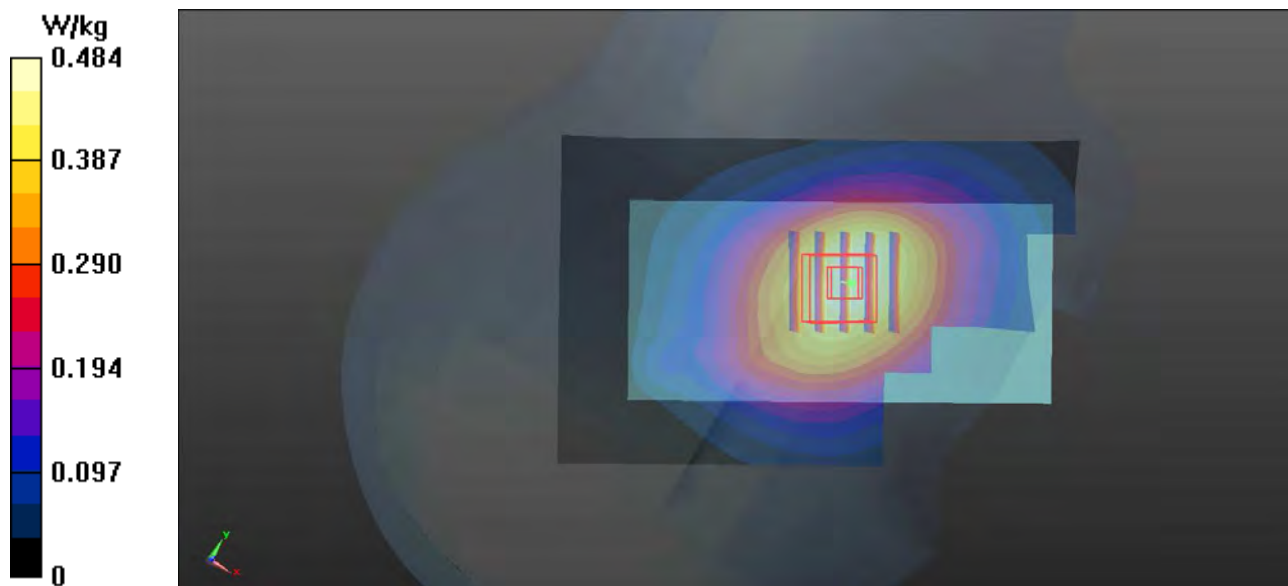



## P02 GSM1900\_GPRS11\_Left Cheek\_Ch810

### DUT: 181120W002

Communication System: GPRS11 ; Frequency: 1909.8 MHz;Duty Cycle: 1:2.67

Medium: HSL1900\_1125 Medium parameters used:  $f = 1910$  MHz;  $\sigma = 1.379$  S/m;  $\epsilon_r = 39.504$ ;  $\rho = 1000$  kg/m<sup>3</sup>

Ambient Temperature : 23.2 °C ; Liquid Temperature : 22.3 °C

#### DASY5 Configuration:

- Probe: EX3DV4 - SN3873; ConvF(8.12, 8.12, 8.12); Calibrated: 2018/08/31;
- Sensor-Surface: 1.4mm (Mechanical Surface Detection)
- Electronics: DAE4 Sn1341; Calibrated: 2018/08/28
- Phantom: Front Phantom with CRP v5.0; Type: QD000P40CD; Serial: TP:1695
- Measurement SW: DASY52, Version 52.8 (8); SEMCAD X Version 14.6.10 (7331)

- **Area Scan (71x121x1):** Interpolated grid: dx=1.500 mm, dy=1.500 mm

Maximum value of SAR (interpolated) = 0.566 W/kg

- **Zoom Scan (5x5x7)/Cube 0:** Measurement grid: dx=8mm, dy=8mm, dz=5mm

Reference Value = 5.738 V/m; Power Drift = 0.14 dB

Peak SAR (extrapolated) = 0.617 W/kg

**SAR(1 g) = 0.371 W/kg; SAR(10 g) = 0.220 W/kg**

Maximum value of SAR (measured) = 0.528 W/kg

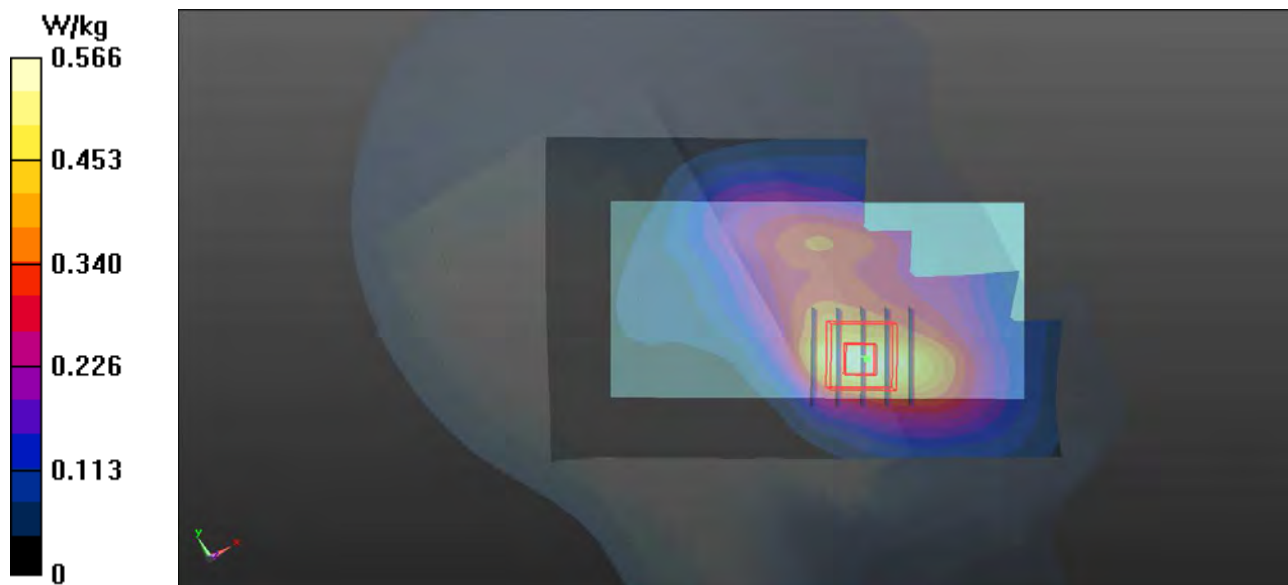

### P03 WCDMA II\_RMC12.2K\_Right Cheek\_Ch9400

**DUT: 181120W002**

Communication System: WCDMA; Frequency: 1880 MHz; Duty Cycle: 1:1

Medium: HSL1900\_1125 Medium parameters used:  $f = 1880$  MHz;  $\sigma = 1.387$  S/m;  $\epsilon_r = 39.606$ ;  $\rho = 1000$  kg/m<sup>3</sup>

Ambient Temperature : 23.2 °C ; Liquid Temperature : 22.3 °C

DASY5 Configuration:

- Probe: EX3DV4 - SN3873; ConvF(8.12, 8.12, 8.12); Calibrated: 2018/08/31;
- Sensor-Surface: 1.4mm (Mechanical Surface Detection)
- Electronics: DAE4 Sn1341; Calibrated: 2018/08/28
- Phantom: Front Phantom with CRP v5.0; Type: QD000P40CD; Serial: TP:1695
- Measurement SW: DASY52, Version 52.8 (8); SEMCAD X Version 14.6.10 (7331)

- **Area Scan (71x121x1):** Interpolated grid: dx=1.500 mm, dy=1.500 mm

Maximum value of SAR (interpolated) = 0.531 W/kg

- **Zoom Scan (5x5x7)/Cube 0:** Measurement grid: dx=8mm, dy=8mm, dz=5mm

Reference Value = 6.745 V/m; Power Drift = 0.06 dB

Peak SAR (extrapolated) = 0.612 W/kg

**SAR(1 g) = 0.406 W/kg; SAR(10 g) = 0.255 W/kg**

Maximum value of SAR (measured) = 0.524 W/kg

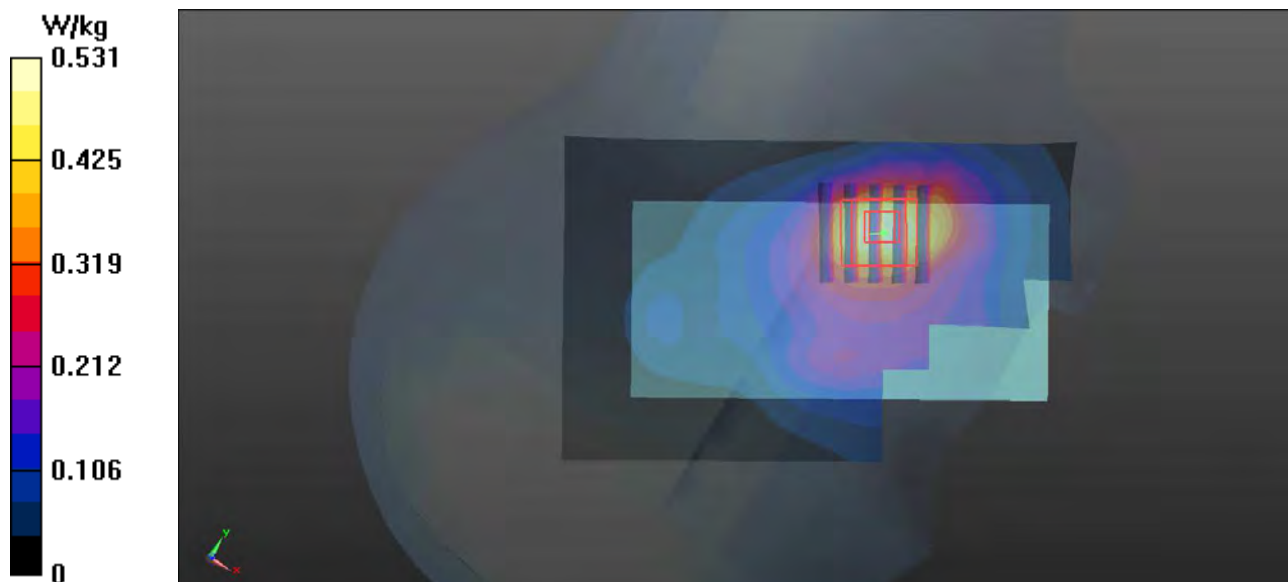

## P04 WCDMA IV\_RMC12.2K\_Right Cheek\_Ch1312

### DUT: 181120W002

Communication System: WCDMA; Frequency: 1712.4 MHz; Duty Cycle: 1:1

Medium: HSL1750\_1125 Medium parameters used:  $f = 1712.4$  MHz;  $\sigma = 1.315$  S/m;  $\epsilon_r = 40.824$ ;  $\rho = 1000$  kg/m<sup>3</sup>

Ambient Temperature : 23.2 °C ; Liquid Temperature : 22.3 °C

#### DASY5 Configuration:

- Probe: EX3DV4 - SN3873; ConvF(8.39, 8.39, 8.39); Calibrated: 2018/08/31;
- Sensor-Surface: 1.4mm (Mechanical Surface Detection)
- Electronics: DAE4 Sn1341; Calibrated: 2018/08/28
- Phantom: Front Phantom with CRP v5.0; Type: QD000P40CD; Serial: TP:1695
- Measurement SW: DASY52, Version 52.8 (8); SEMCAD X Version 14.6.10 (7331)

- **Area Scan (71x121x1):** Interpolated grid: dx=1.500 mm, dy=1.500 mm

Maximum value of SAR (interpolated) = 0.261 W/kg

- **Zoom Scan (5x5x7)/Cube 0:** Measurement grid: dx=8mm, dy=8mm, dz=5mm

Reference Value = 3.769 V/m; Power Drift = 0.01 dB

Peak SAR (extrapolated) = 0.306 W/kg

**SAR(1 g) = 0.209 W/kg; SAR(10 g) = 0.138 W/kg**

Maximum value of SAR (measured) = 0.273 W/kg

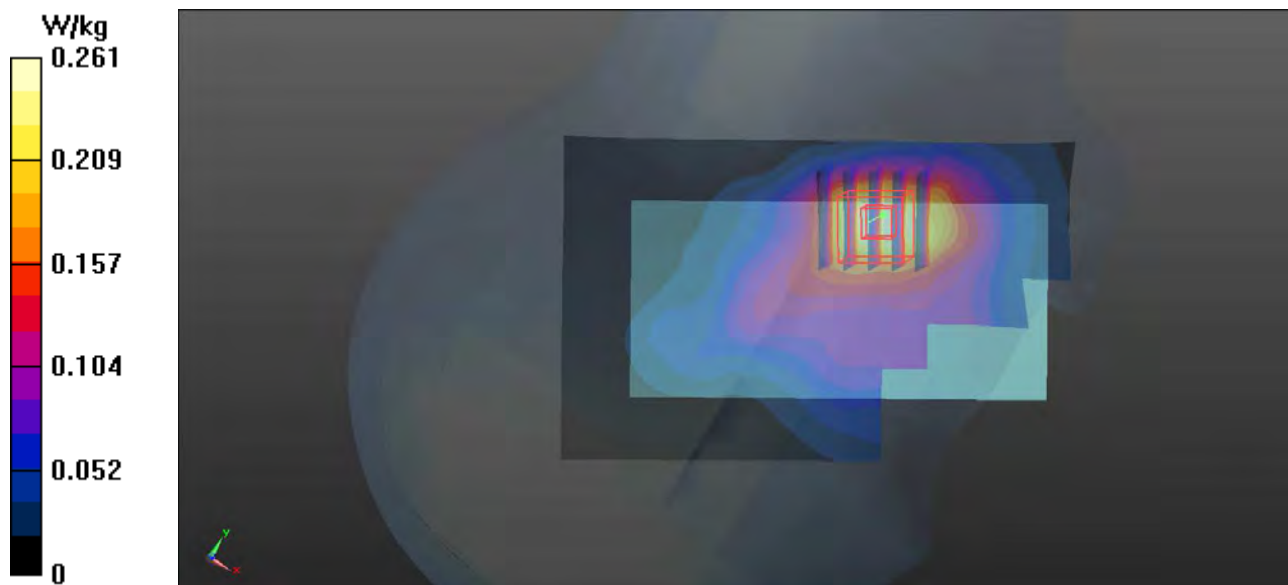

## P05 WCDMA V\_RMC12.2K\_Right Cheek\_Ch4182

**DUT: 181120W002**

Communication System: WCDMA ; Frequency: 836.4 MHz; Duty Cycle: 1:1

Medium: HSL835\_1126 Medium parameters used:  $f = 836.4$  MHz;  $\sigma = 0.897$  S/m;  $\epsilon_r = 41.623$ ;  $\rho = 1000$  kg/m<sup>3</sup>

Ambient Temperature : 23.3 °C ; Liquid Temperature : 22.1 °C

DASY5 Configuration:

- Probe: EX3DV4 - SN3873; ConvF(9.69, 9.69, 9.69); Calibrated: 2018/08/31;
- Sensor-Surface: 1.4mm (Mechanical Surface Detection)
- Electronics: DAE4 Sn1341; Calibrated: 2018/08/28
- Phantom: Left Phantom with CRP v5.0; Type: QD000P40CD; Serial: TP:1722
- Measurement SW: DASY52, Version 52.8 (8); SEMCAD X Version 14.6.10 (7331)

- **Area Scan (71x121x1):** Interpolated grid: dx=1.500 mm, dy=1.500 mm

Maximum value of SAR (interpolated) = 0.285 W/kg

- **Zoom Scan (5x5x7)/Cube 0:** Measurement grid: dx=8mm, dy=8mm, dz=5mm

Reference Value = 5.741 V/m; Power Drift = -0.01 dB

Peak SAR (extrapolated) = 0.300 W/kg

**SAR(1 g) = 0.247 W/kg; SAR(10 g) = 0.190 W/kg**

Maximum value of SAR (measured) = 0.284 W/kg

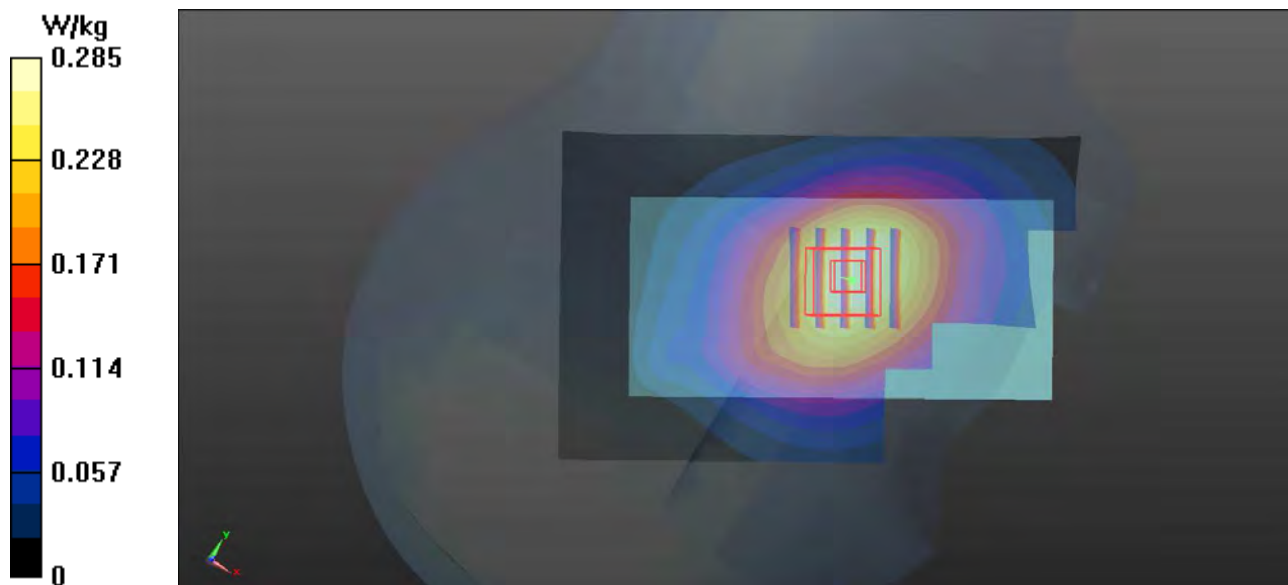

## P06 802.11b\_Left Cheek\_Ch11

### DUT: 181030W001

Communication System: 802.11b; Frequency: 2462 MHz; Duty Cycle: 1:1

Medium: HSL2450\_1207 Medium parameters used:  $f = 2462$  MHz;  $\sigma = 1.858$  S/m;  $\epsilon_r = 39.35$ ;  $\rho = 1000$  kg/m<sup>3</sup>

Ambient Temperature : 23.1 °C; Liquid Temperature : 22.1 °C

#### DASY5 Configuration:

- Probe: EX3DV4 - SN3873; ConvF(7.19, 7.19, 7.19); Calibrated: 2018/08/31;
- Sensor-Surface: 1.4mm (Mechanical Surface Detection)
- Electronics: DAE4 Sn1341; Calibrated: 2018/08/28
- Phantom: Front Phantom with CRP v5.0; Type: QD000P40CD; Serial: TP:1695
- Measurement SW: DASY52, Version 52.8 (8); SEMCAD X Version 14.6.10 (7331)

- **Area Scan (91x151x1):** Interpolated grid: dx=1.200 mm, dy=1.200 mm

Maximum value of SAR (interpolated) = 0.784 W/kg

- **Zoom Scan (7x7x7)/Cube 0:** Measurement grid: dx=5mm, dy=5mm, dz=5mm

Reference Value = 10.60 V/m; Power Drift = 0.06 dB

Peak SAR (extrapolated) = 1.04 W/kg

**SAR(1 g) = 0.408 W/kg; SAR(10 g) = 0.186 W/kg**

Maximum value of SAR (measured) = 0.744 W/kg

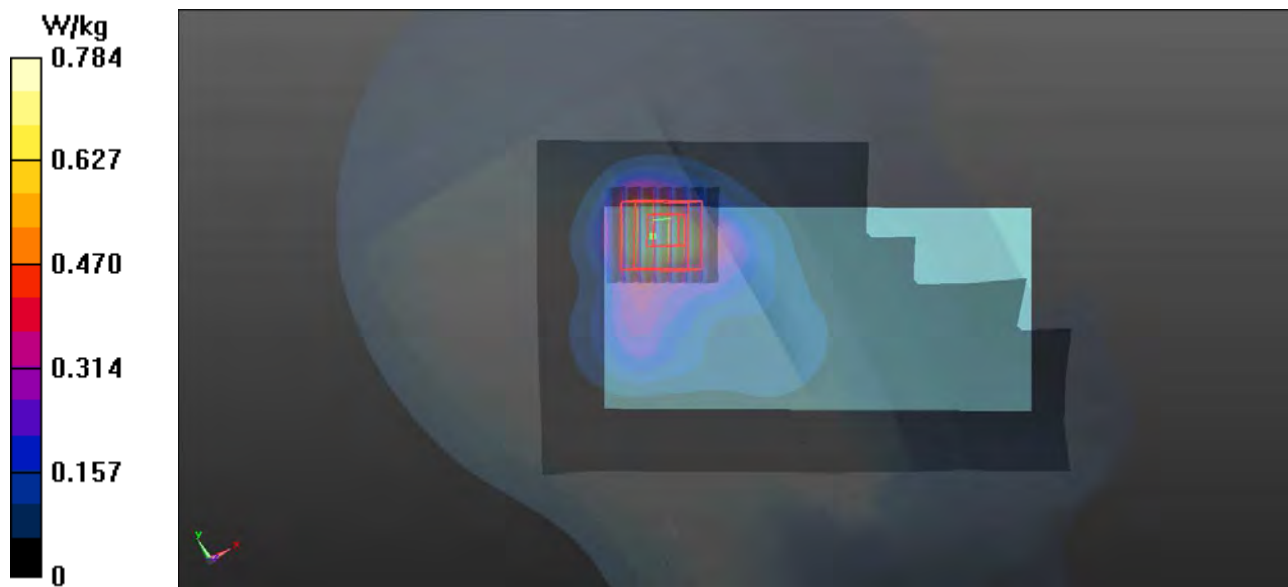

### P07 GSM1900\_GPRS11\_Rear Face\_1cm\_Ch661

**DUT: 181120W002**

Communication System: GPRS11; Frequency: 1880 MHz; Duty Cycle: 1:2.67

Medium: MSL1900\_1122 Medium parameters used:  $f = 1880$  MHz;  $\sigma = 1.544$  S/m;  $\epsilon_r = 53.601$ ;  $\rho = 1000$  kg/m<sup>3</sup>

Ambient Temperature : 23.1 °C ; Liquid Temperature : 22.1 °C

DASY5 Configuration:

- Probe: EX3DV4 - SN3873; ConvF(7.61, 7.61, 7.61); Calibrated: 2018/08/31;
- Sensor-Surface: 1.4mm (Mechanical Surface Detection)
- Electronics: DAE4 Sn1341; Calibrated: 2018/08/28
- Phantom: Front Phantom with CRP v5.0; Type: QD000P40CD; Serial: TP:1695
- Measurement SW: DASY52, Version 52.8 (8); SEMCAD X Version 14.6.10 (7331)

- **Area Scan (81x131x1):** Interpolated grid: dx=1.500 mm, dy=1.500 mm

Maximum value of SAR (interpolated) = 1.24 W/kg

- **Zoom Scan (5x5x7)/Cube 0:** Measurement grid: dx=8mm, dy=8mm, dz=5mm

Reference Value = 10.79 V/m; Power Drift = -0.04 dB

Peak SAR (extrapolated) = 1.37 W/kg

**SAR(1 g) = 0.79 W/kg; SAR(10 g) = 0.493 W/kg**

Maximum value of SAR (measured) = 1.09 W/kg

- **Zoom Scan (5x5x7)/Cube 1:** Measurement grid: dx=8mm, dy=8mm, dz=5mm

Reference Value = 10.79 V/m; Power Drift = -0.04 dB

Peak SAR (extrapolated) = 1.17 W/kg

**SAR(1 g) = 0.755 W/kg; SAR(10 g) = 0.490 W/kg**

Maximum value of SAR (measured) = 1.02 W/kg

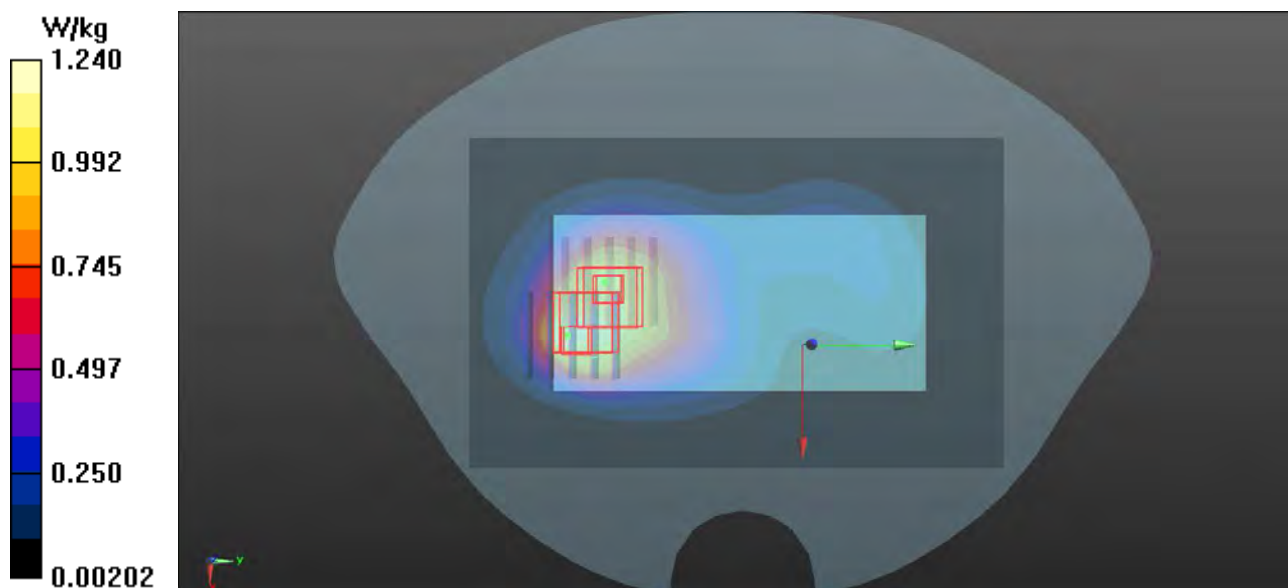

## P08 WCDMA II\_RMC12.2K\_Rear Face\_1cm\_Ch9262

**DUT: 181120W002**

Communication System: WCDMA; Frequency: 1852.4 MHz; Duty Cycle: 1:1

Medium: MSL1900\_1122 Medium parameters used:  $f = 1852.4$  MHz;  $\sigma = 1.519$  S/m;  $\epsilon_r = 53.671$ ;  $\rho = 1000$  kg/m<sup>3</sup>

Ambient Temperature : 23.1 °C; Liquid Temperature : 22.1 °C

DASY5 Configuration:

- Probe: EX3DV4 - SN3873; ConvF(7.61, 7.61, 7.61); Calibrated: 2018/08/31;
- Sensor-Surface: 1.4mm (Mechanical Surface Detection)
- Electronics: DAE4 Sn1341; Calibrated: 2018/08/28
- Phantom: Front Phantom with CRP v5.0; Type: QD000P40CD; Serial: TP:1695
- Measurement SW: DASY52, Version 52.8 (8); SEMCAD X Version 14.6.10 (7331)

- **Area Scan (61x121x1):** Interpolated grid: dx=1.500 mm, dy=1.500 mm

Maximum value of SAR (interpolated) = 1.20 W/kg

- **Zoom Scan (5x5x7)/Cube 0:** Measurement grid: dx=8mm, dy=8mm, dz=5mm

Reference Value = 10.83 V/m; Power Drift = -0.04 dB

Peak SAR (extrapolated) = 1.24 W/kg

**SAR(1 g) = 0.746 W/kg; SAR(10 g) = 0.472 W/kg**

Maximum value of SAR (measured) = 1.04 W/kg

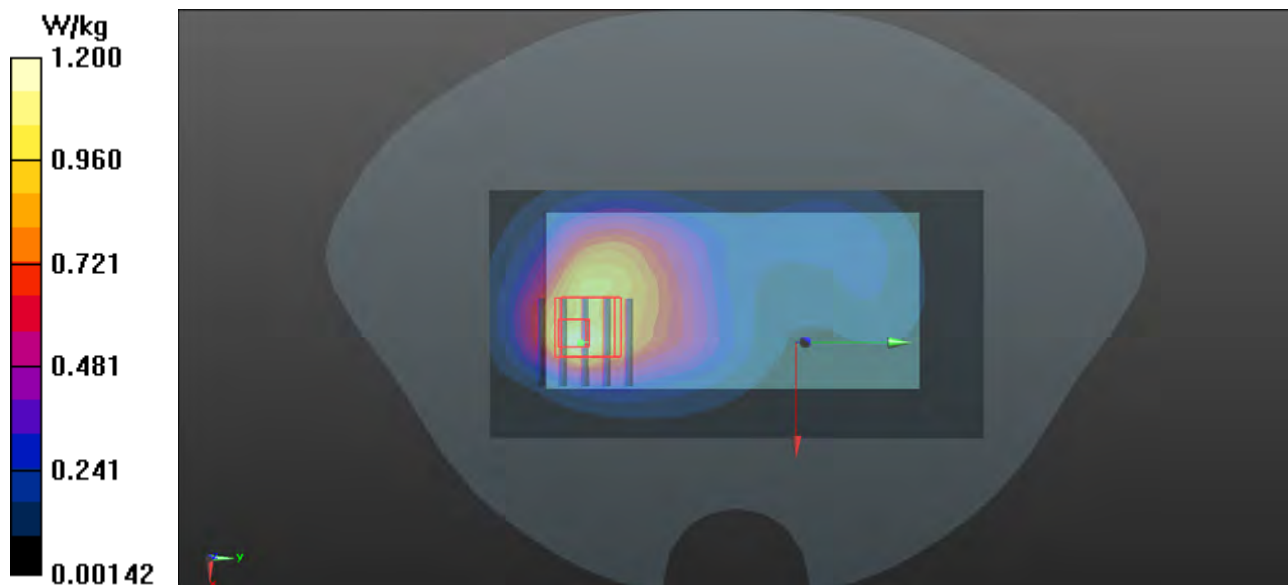

## P09 WCDMA IV\_RMC12.2K\_Rear Face\_1cm\_Ch1312

**DUT: 181120W002**

Communication System: WCDMA; Frequency: 1712.4 MHz; Duty Cycle: 1:1

Medium: MSL1750\_1122 Medium parameters used:  $f = 1712.4$  MHz;  $\sigma = 1.5$  S/m;  $\epsilon_r = 53.685$ ;  $\rho = 1000$  kg/m<sup>3</sup>

Ambient Temperature : 23.1 °C ; Liquid Temperature : 22.1 °C

DASY5 Configuration:

- Probe: EX3DV4 - SN3873; ConvF(7.8, 7.8, 7.8); Calibrated: 2018/08/31;
- Sensor-Surface: 1.4mm (Mechanical Surface Detection)
- Electronics: DAE4 Sn1341; Calibrated: 2018/08/28
- Phantom: Front Phantom with CRP v5.0; Type: QD000P40CD; Serial: TP:1695
- Measurement SW: DASY52, Version 52.8 (8); SEMCAD X Version 14.6.10 (7331)

- **Area Scan (71x121x1):** Interpolated grid: dx=1.500 mm, dy=1.500 mm

Maximum value of SAR (interpolated) = 0.940 W/kg

- **Zoom Scan (5x5x7)/Cube 0:** Measurement grid: dx=8mm, dy=8mm, dz=5mm

Reference Value = 10.52 V/m; Power Drift = -0.07 dB

Peak SAR (extrapolated) = 1.06 W/kg

**SAR(1 g) = 0.638 W/kg; SAR(10 g) = 0.380 W/kg**

Maximum value of SAR (measured) = 0.899 W/kg

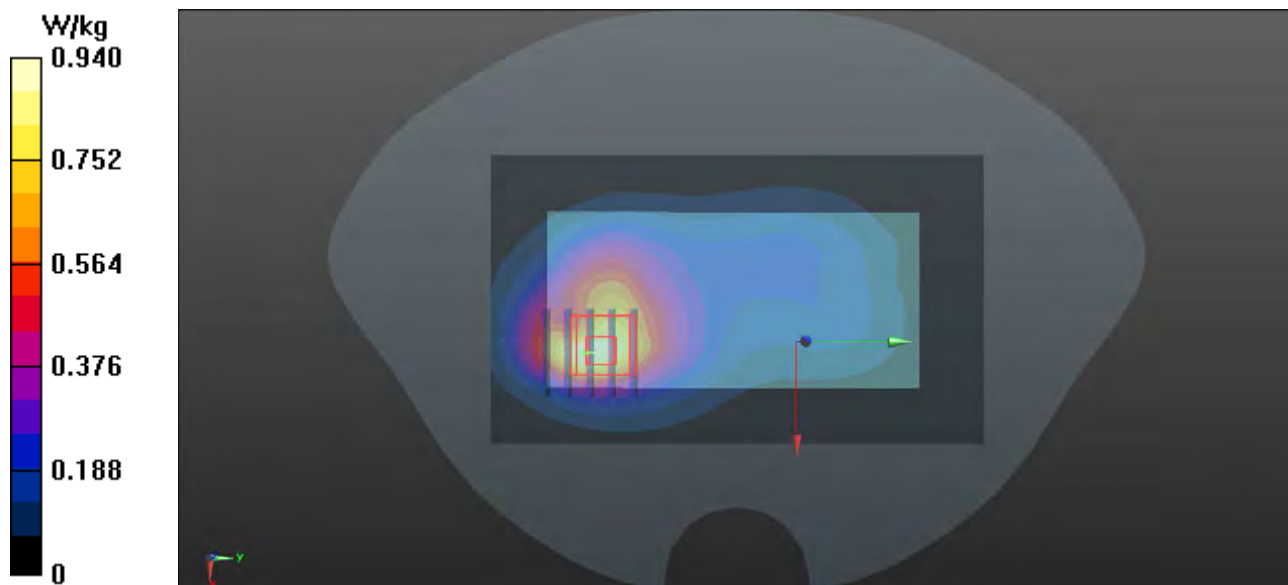



## P10 GSM850\_GPRS11\_Rear Face\_1cm\_Ch128

**DUT: 181120W002**

Communication System: GPRS11; Frequency: 824.2 MHz; Duty Cycle: 1:2.67

Medium: MSL835\_1124 Medium parameters used:  $f = 824.2$  MHz;  $\sigma = 0.946$  S/m;  $\epsilon_r = 56.456$ ;  $\rho = 1000$  kg/m<sup>3</sup>

Ambient Temperature : 23.2 °C ; Liquid Temperature : 22.2 °C

DASY5 Configuration:

- Probe: EX3DV4 - SN3873; ConvF(9.49, 9.49, 9.49); Calibrated: 2018/08/31;
- Sensor-Surface: 1.4mm (Mechanical Surface Detection)
- Electronics: DAE4 Sn1341; Calibrated: 2018/08/28
- Phantom: Left Phantom with CRP v5.0; Type: QD000P40CD; Serial: TP:1722
- Measurement SW: DASY52, Version 52.8 (8); SEMCAD X Version 14.6.10 (7331)

- **Area Scan (81x121x1):** Interpolated grid: dx=1.500 mm, dy=1.500 mm

Maximum value of SAR (interpolated) = 1.09 W/kg

- **Zoom Scan (5x5x7)/Cube 0:** Measurement grid: dx=8mm, dy=8mm, dz=5mm

Reference Value = 31.73 V/m; Power Drift = -0.02 dB

Peak SAR (extrapolated) = 1.18 W/kg

**SAR(1 g) = 0.926 W/kg; SAR(10 g) = 0.714 W/kg**

Maximum value of SAR (measured) = 1.09 W/kg

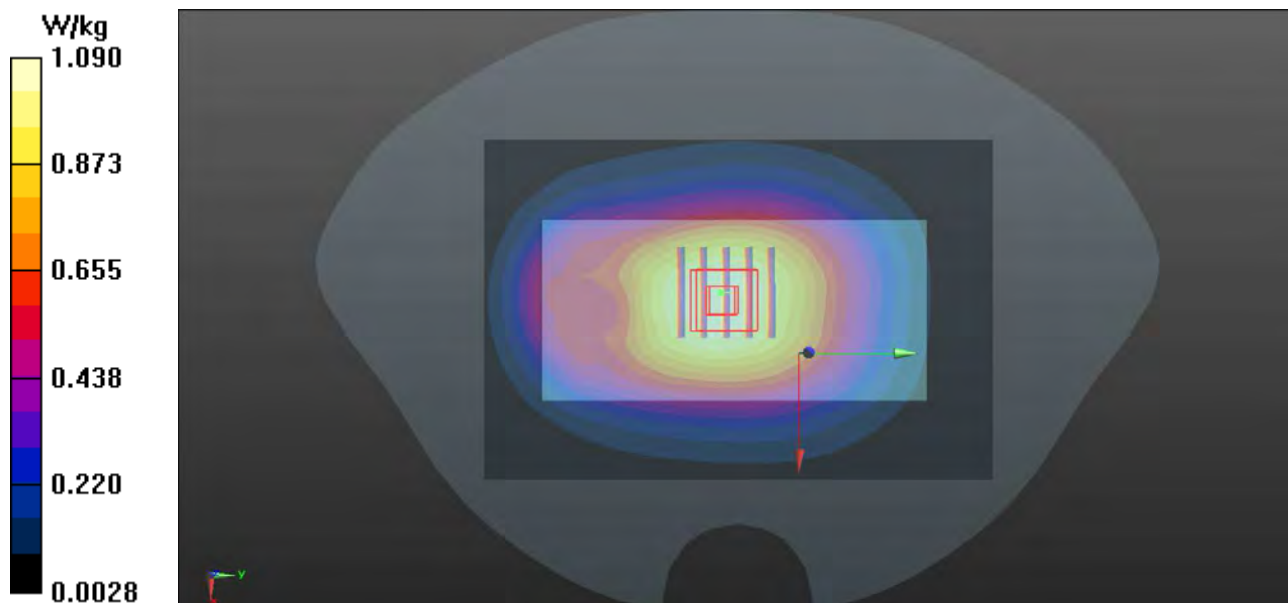

## P11 GSM1900\_GPRS11\_Bottom Side\_1cm\_Ch661

**DUT: 181120W002**

Communication System: GPRS11; Frequency: 1880 MHz; Duty Cycle: 1:2.67

Medium: MSL1900\_1122 Medium parameters used:  $f = 1880$  MHz;  $\sigma = 1.544$  S/m;  $\epsilon_r = 53.601$ ;  $\rho = 1000$  kg/m<sup>3</sup>

Ambient Temperature : 23.1 °C ; Liquid Temperature : 22.1 °C

DASY5 Configuration:

- Probe: EX3DV4 - SN3873; ConvF(7.61, 7.61, 7.61); Calibrated: 2018/08/31;
- Sensor-Surface: 1.4mm (Mechanical Surface Detection)
- Electronics: DAE4 Sn1341; Calibrated: 2018/08/28
- Phantom: Front Phantom with CRP v5.0; Type: QD000P40CD; Serial: TP:1695
- Measurement SW: DASY52, Version 52.8 (8); SEMCAD X Version 14.6.10 (7331)

- **Area Scan (41x81x1):** Interpolated grid: dx=1.500 mm, dy=1.500 mm

Maximum value of SAR (interpolated) = 1.66 W/kg

- **Zoom Scan (5x5x7)/Cube 0:** Measurement grid: dx=8mm, dy=8mm, dz=5mm

Reference Value = 25.04 V/m; Power Drift = -0.03 dB

Peak SAR (extrapolated) = 1.90 W/kg

**SAR(1 g) = 1.05 W/kg; SAR(10 g) = 0.554 W/kg**

Maximum value of SAR (measured) = 1.60 W/kg

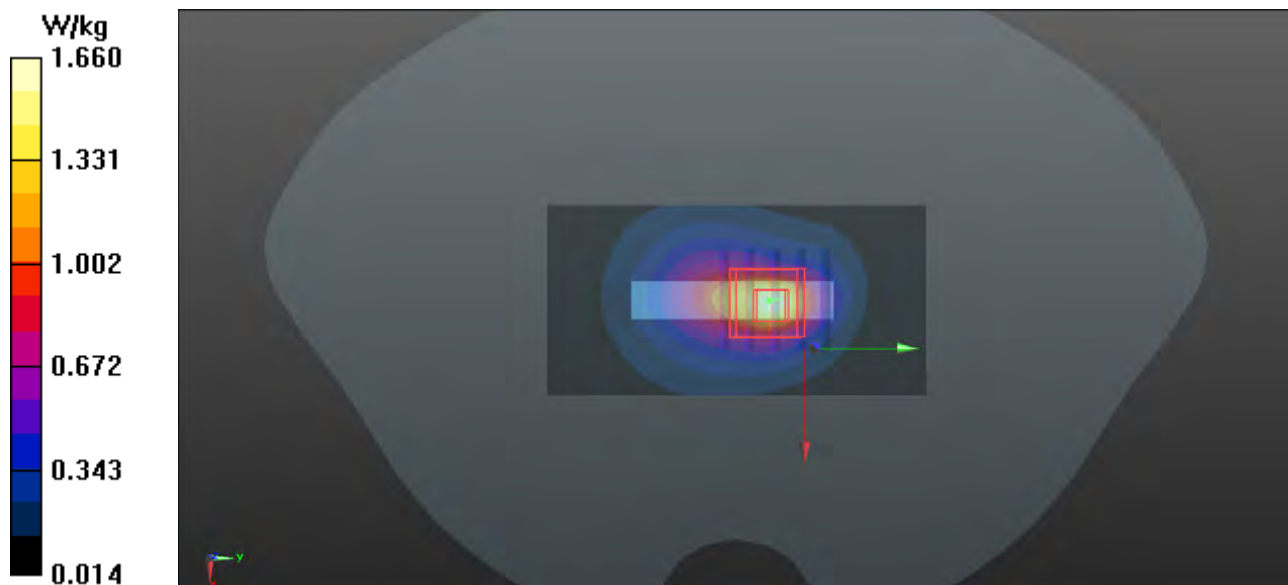

## P12 WCDMA II\_RMC12.2K\_Bottom Side\_1cm\_Ch9400

**DUT: 181120W002**

Communication System: WCDMA; Frequency: 1880 MHz; Duty Cycle: 1:1

Medium: MSL1900\_1122 Medium parameters used:  $f = 1880$  MHz;  $\sigma = 1.544$  S/m;  $\epsilon_r = 53.601$ ;  $\rho = 1000$  kg/m<sup>3</sup>

Ambient Temperature : 23.1 °C; Liquid Temperature : 22.1 °C

DASY5 Configuration:

- Probe: EX3DV4 - SN3873; ConvF(7.61, 7.61, 7.61); Calibrated: 2018/08/31;
- Sensor-Surface: 1.4mm (Mechanical Surface Detection)
- Electronics: DAE4 Sn1341; Calibrated: 2018/08/28
- Phantom: Front Phantom with CRP v5.0; Type: QD000P40CD; Serial: TP:1695
- Measurement SW: DASY52, Version 52.8 (8); SEMCAD X Version 14.6.10 (7331)

- **Area Scan (51x81x1):** Interpolated grid: dx=1.500 mm, dy=1.500 mm

Maximum value of SAR (interpolated) = 1.78 W/kg

- **Zoom Scan (5x5x7)/Cube 0:** Measurement grid: dx=8mm, dy=8mm, dz=5mm

Reference Value = 27.24 V/m; Power Drift = -0.03 dB

Peak SAR (extrapolated) = 2.24 W/kg

**SAR(1 g) = 1.23 W/kg; SAR(10 g) = 0.646 W/kg**

Maximum value of SAR (measured) = 1.92 W/kg

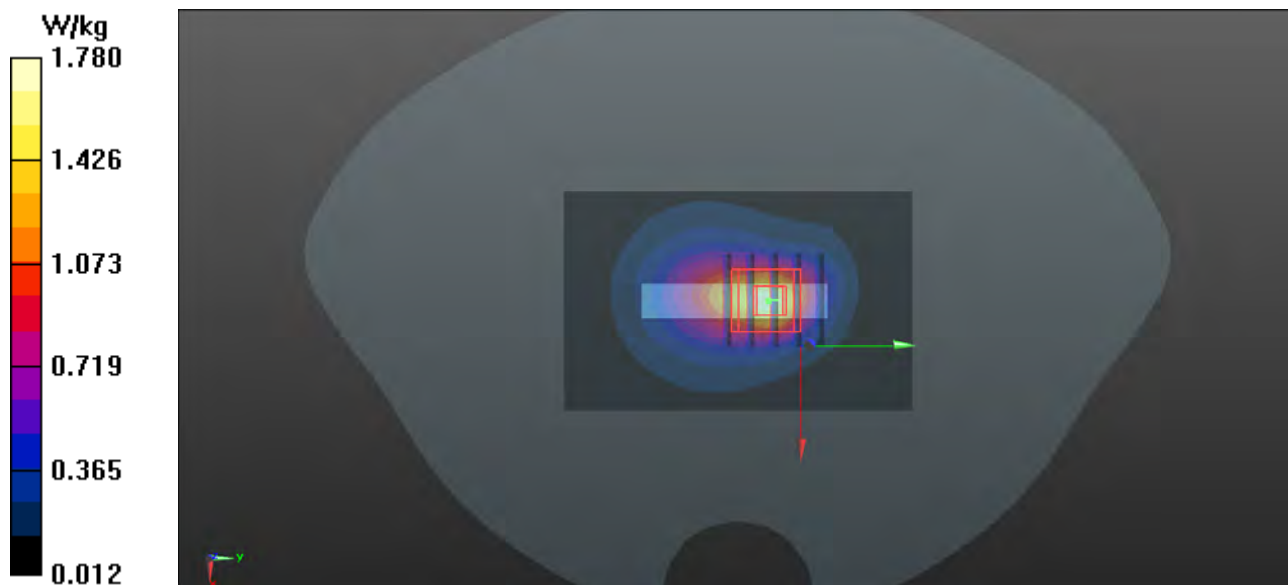

### P13 WCDMA IV\_RMC12.2K\_Bottom Side\_1cm\_Ch1312

**DUT: 181120W002**

Communication System: WCDMA; Frequency: 1712.4 MHz; Duty Cycle: 1:1

Medium: MSL1750\_1122 Medium parameters used:  $f = 1712.4$  MHz;  $\sigma = 1.5$  S/m;  $\epsilon_r = 53.685$ ;  $\rho = 1000$  kg/m<sup>3</sup>

Ambient Temperature : 23.1 °C ; Liquid Temperature : 22.1 °C

DASY5 Configuration:

- Probe: EX3DV4 - SN3873; ConvF(7.8, 7.8, 7.8); Calibrated: 2018/08/31;
- Sensor-Surface: 1.4mm (Mechanical Surface Detection)
- Electronics: DAE4 Sn1341; Calibrated: 2018/08/28
- Phantom: Front Phantom with CRP v5.0; Type: QD000P40CD; Serial: TP:1695
- Measurement SW: DASY52, Version 52.8 (8); SEMCAD X Version 14.6.10 (7331)

- **Area Scan (41x81x1):** Interpolated grid: dx=1.500 mm, dy=1.500 mm

Maximum value of SAR (interpolated) = 1.05 W/kg

- **Zoom Scan (5x5x7)/Cube 0:** Measurement grid: dx=8mm, dy=8mm, dz=5mm

Reference Value = 19.12 V/m; Power Drift = -0.05 dB

Peak SAR (extrapolated) = 1.18 W/kg

**SAR(1 g) = 0.656 W/kg; SAR(10 g) = 0.339 W/kg**

Maximum value of SAR (measured) = 1.02 W/kg

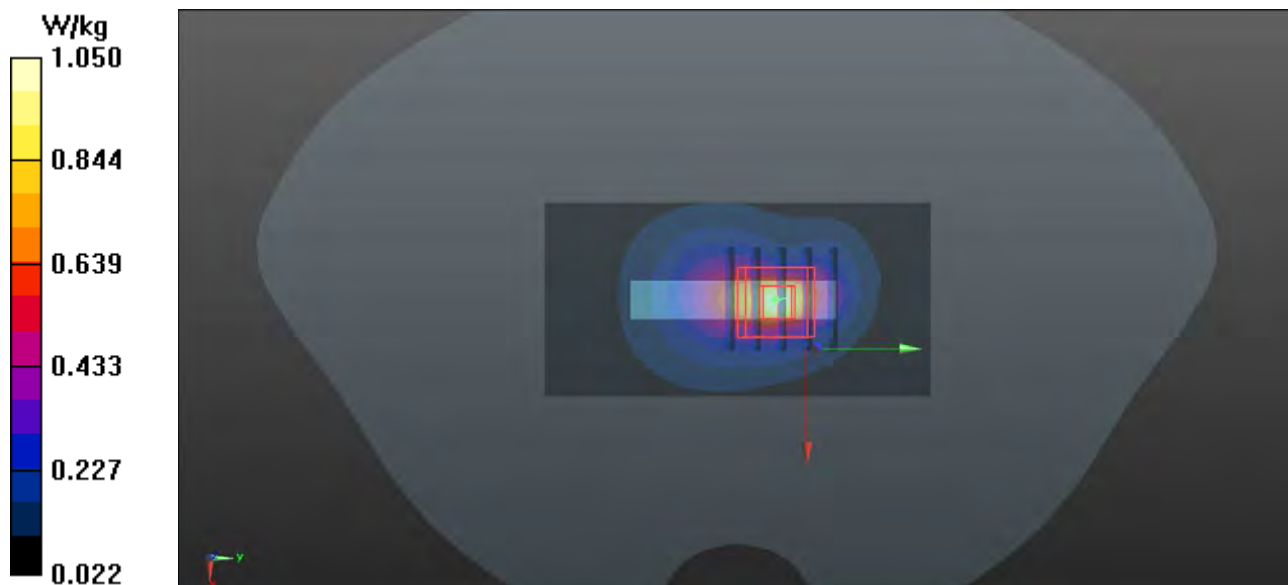

## P14 WCDMA V\_RMC12.2K\_Rear Face\_1cm\_Ch4182

### DUT: 181120W002

Communication System: WCDMA; Frequency: 836.4 MHz; Duty Cycle: 1:1

Medium: MSL835\_1124 Medium parameters used:  $f = 836.4$  MHz;  $\sigma = 0.958$  S/m;  $\epsilon_r = 56.343$ ;  $\rho = 1000$  kg/m<sup>3</sup>

Ambient Temperature : 23.2 °C; Liquid Temperature : 22.2 °C

#### DASY5 Configuration:

- Probe: EX3DV4 - SN3873; ConvF(9.49, 9.49, 9.49); Calibrated: 2018/08/31;
- Sensor-Surface: 1.4mm (Mechanical Surface Detection)
- Electronics: DAE4 Sn1341; Calibrated: 2018/08/28
- Phantom: Left Phantom with CRP v5.0; Type: QD000P40CD; Serial: TP:1722
- Measurement SW: DASY52, Version 52.8 (8); SEMCAD X Version 14.6.10 (7331)

- **Area Scan (61x121x1):** Interpolated grid: dx=1.500 mm, dy=1.500 mm

Maximum value of SAR (interpolated) = 0.576 W/kg

- **Zoom Scan (5x5x7)/Cube 0:** Measurement grid: dx=8mm, dy=8mm, dz=5mm

Reference Value = 20.03 V/m; Power Drift = 0.03 dB

Peak SAR (extrapolated) = 0.806 W/kg

**SAR(1 g) = 0.450 W/kg; SAR(10 g) = 0.246 W/kg**

Maximum value of SAR (measured) = 0.688 W/kg

- **Zoom Scan (5x5x7)/Cube 1:** Measurement grid: dx=8mm, dy=8mm, dz=5mm

Reference Value = 20.03 V/m; Power Drift = 0.03 dB

Peak SAR (extrapolated) = 0.513 W/kg

**SAR(1 g) = 0.396 W/kg; SAR(10 g) = 0.303 W/kg**

Maximum value of SAR (measured) = 0.474 W/kg

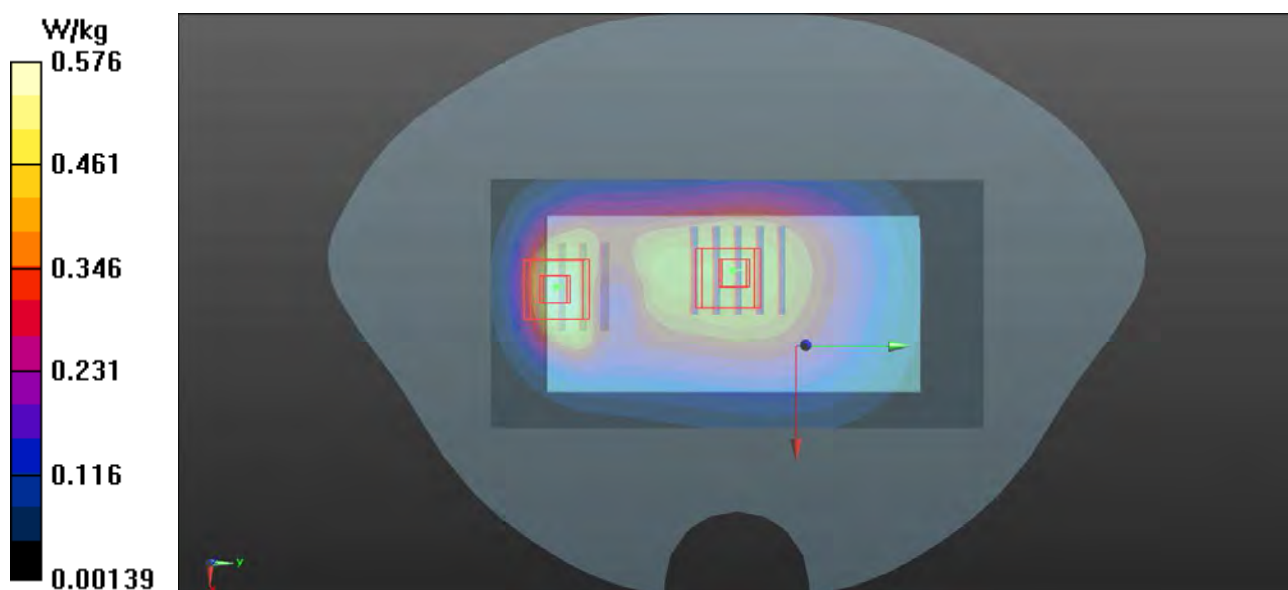

### P15 802.11b\_Rear Face\_1cm\_Ch11

**DUT: 181120W002**

Communication System: 802.11b; Frequency: 2462 MHz; Duty Cycle: 1:1

Medium: MSL2450\_1208 Medium parameters used:  $f = 2462$  MHz;  $\sigma = 1.911$  S/m;  $\epsilon_r = 51.679$ ;  $\rho = 1000$  kg/m<sup>3</sup>

Ambient Temperature : 23.1 °C ; Liquid Temperature : 22.1 °C

DASY5 Configuration:

- Probe: EX3DV4 - SN3873; ConvF(7.39, 7.39, 7.39); Calibrated: 2018/08/31;
- Sensor-Surface: 1.4mm (Mechanical Surface Detection)
- Electronics: DAE4 Sn1341; Calibrated: 2018/08/28
- Phantom: ELI v5.0; Type: QDOVA002AA; Serial: TP:1205
- Measurement SW: DASY52, Version 52.8 (8); SEMCAD X Version 14.6.10 (7331)

- **Area Scan (101x151x1):** Interpolated grid: dx=1.200 mm, dy=1.200 mm  
Maximum value of SAR (interpolated) = 0.148 W/kg

- **Zoom Scan (7x7x7)/Cube 0:** Measurement grid: dx=5mm, dy=5mm, dz=5mm  
Reference Value = 4.404 V/m; Power Drift = 0.07 dB  
Peak SAR (extrapolated) = 0.201 W/kg  
**SAR(1 g) = 0.098 W/kg; SAR(10 g) = 0.048 W/kg**  
Maximum value of SAR (measured) = 0.160 W/kg

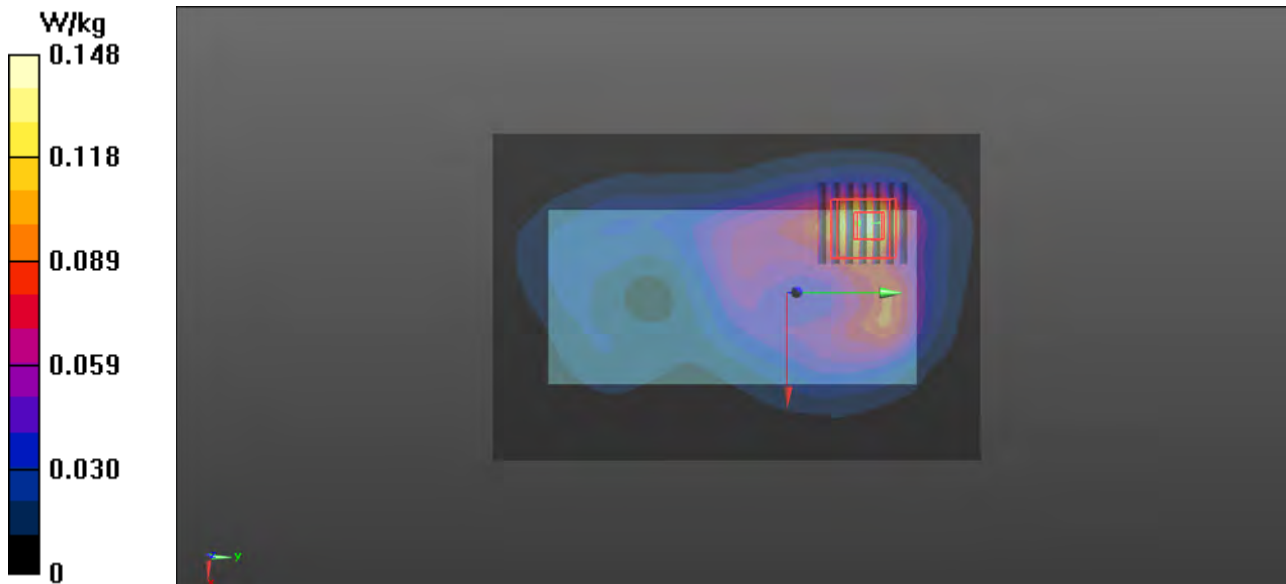



## **Appendix C. Calibration Certificate for Probe and Dipole**

The SPEAG calibration certificates are shown as follows.



In Collaboration with  
**s p e a g**  
CALIBRATION LABORATORY



中国认可  
国际互认  
校准  
CALIBRATION  
CNAS L0570

Add: No.51 Xueyuan Road, Haidian District, Beijing, 100191, China  
Tel: +86-10-62304633-2079 Fax: +86-10-62304633-2504  
E-mail: cttl@chinattl.com http://www.chinattl.cn

Client **ADT\_CN**

Certificate No: **Z18-60311**

## CALIBRATION CERTIFICATE

Object **D835V2 - SN: 4d139**

Calibration Procedure(s) **FF-Z11-003-01**  
**Calibration Procedures for dipole validation kits**

Calibration date: **September 6, 2018**

This calibration Certificate documents the traceability to national standards, which realize the physical units of measurements(SI). The measurements and the uncertainties with confidence probability are given on the following pages and are part of the certificate.

All calibrations have been conducted in the closed laboratory facility: environment temperature(22±3)°C and humidity<70%.

Calibration Equipment used (M&TE critical for calibration)

Primary Standards	ID #	Cal Date(Calibrated by, Certificate No.)	Scheduled Calibration
Power Meter NRVD	102083	01-Nov-17 (CTTL, No.J17X08756)	Oct-18
Power sensor NRV-Z5	100542	01-Nov-17 (CTTL, No.J17X08756)	Oct-18
Reference Probe EX3DV4	SN 7464	12-Sep-17(SPEAG,No.EX3-7464_Sep17)	Sep-18
DAE4	SN 1524	13-Sep-17(SPEAG,No.DAE4-1524_Sep17)	Sep-18
Secondary Standards	ID #	Cal Date(Calibrated by, Certificate No.)	Scheduled Calibration
Signal Generator E4438C	MY49071430	23-Jan-18 (CTTL, No.J18X00560)	Jan-19
NetworkAnalyzer E5071C	MY46110673	24-Jan-18 (CTTL, No.J18X00561)	Jan-19

	Name	Function	Signature
Calibrated by:	Zhao Jing	SAR Test Engineer	
Reviewed by:	Lin Hao	SAR Test Engineer	
Approved by:	Qi Dianyuan	SAR Project Leader	

Issued: September 9, 2018

This calibration certificate shall not be reproduced except in full without written approval of the laboratory.





In Collaboration with

**s p e a g**  
CALIBRATION LABORATORY

Add: No.51 Xueyuan Road, Haidian District, Beijing, 100191, China  
Tel: +86-10-62304633-2079 Fax: +86-10-62304633-2504  
E-mail: cttl@chinattl.com http://www.chinattl.cn

#### Glossary:

TSL	tissue simulating liquid
ConvF	sensitivity in TSL / NORM <sub>x,y,z</sub>
N/A	not applicable or not measured

#### Calibration is Performed According to the Following Standards:

- IEEE Std 1528-2013, "IEEE Recommended Practice for Determining the Peak Spatial-Averaged Specific Absorption Rate (SAR) in the Human Head from Wireless Communications Devices: Measurement Techniques", June 2013
- IEC 62209-1, "Measurement procedure for assessment of specific absorption rate of human exposure to radio frequency fields from hand-held and body-mounted wireless communication devices- Part 1: Device used next to the ear (Frequency range of 300MHz to 6GHz)", July 2016
- IEC 62209-2, "Procedure to measure the Specific Absorption Rate (SAR) For wireless communication devices used in close proximity to the human body (frequency range of 30MHz to 6GHz)", March 2010
- KDB865664, SAR Measurement Requirements for 100 MHz to 6 GHz

#### Additional Documentation:

- DASY4/5 System Handbook

#### Methods Applied and Interpretation of Parameters:

- Measurement Conditions:* Further details are available from the Validation Report at the end of the certificate. All figures stated in the certificate are valid at the frequency indicated.
- Antenna Parameters with TSL:* The dipole is mounted with the spacer to position its feed point exactly below the center marking of the flat phantom section, with the arms oriented parallel to the body axis.
- Feed Point Impedance and Return Loss:* These parameters are measured with the dipole positioned under the liquid filled phantom. The impedance stated is transformed from the measurement at the SMA connector to the feed point. The Return Loss ensures low reflected power. No uncertainty required.
- Electrical Delay:* One-way delay between the SMA connector and the antenna feed point. No uncertainty required.
- SAR measured:* SAR measured at the stated antenna input power.
- SAR normalized:* SAR as measured, normalized to an input power of 1 W at the antenna connector.
- SAR for nominal TSL parameters:* The measured TSL parameters are used to calculate the nominal SAR result.

The reported uncertainty of measurement is stated as the standard uncertainty of Measurement multiplied by the coverage factor  $k=2$ , which for a normal distribution Corresponds to a coverage probability of approximately 95%.



Add: No.51 Xueyuan Road, Haidian District, Beijing, 100191, China  
 Tel: +86-10-62304633-2079 Fax: +86-10-62304633-2504  
 E-mail: cttl@chinattl.com http://www.chinattl.cn

### Measurement Conditions

DASY system configuration, as far as not given on page 1.

<b>DASY Version</b>	DASY52	52.10.1.1476
<b>Extrapolation</b>	Advanced Extrapolation	
<b>Phantom</b>	Triple Flat Phantom 5.1C	
<b>Distance Dipole Center - TSL</b>	15 mm	with Spacer
<b>Zoom Scan Resolution</b>	dx, dy, dz = 5 mm	
<b>Frequency</b>	835 MHz ± 1 MHz	

### Head TSL parameters

The following parameters and calculations were applied.

	Temperature	Permittivity	Conductivity
<b>Nominal Head TSL parameters</b>	22.0 °C	41.5	0.90 mho/m
<b>Measured Head TSL parameters</b>	(22.0 ± 0.2) °C	42.7 ± 6 %	0.90 mho/m ± 6 %
<b>Head TSL temperature change during test</b>	<1.0 °C	----	----

### SAR result with Head TSL

<b>SAR averaged over 1 cm<sup>3</sup> (1 g) of Head TSL</b>	Condition	
SAR measured	250 mW input power	2.37 mW / g
SAR for nominal Head TSL parameters	normalized to 1W	<b>9.51 mW / g ± 18.8 % (k=2)</b>
<b>SAR averaged over 10 cm<sup>3</sup> (10 g) of Head TSL</b>	Condition	
SAR measured	250 mW input power	1.56 mW / g
SAR for nominal Head TSL parameters	normalized to 1W	<b>6.25 mW / g ± 18.7 % (k=2)</b>

### Body TSL parameters

The following parameters and calculations were applied.

	Temperature	Permittivity	Conductivity
<b>Nominal Body TSL parameters</b>	22.0 °C	55.2	0.97 mho/m
<b>Measured Body TSL parameters</b>	(22.0 ± 0.2) °C	56.0 ± 6 %	1.00 mho/m ± 6 %
<b>Body TSL temperature change during test</b>	<1.0 °C	----	----

### SAR result with Body TSL

<b>SAR averaged over 1 cm<sup>3</sup> (1 g) of Body TSL</b>	Condition	
SAR measured	250 mW input power	2.47 mW / g
SAR for nominal Body TSL parameters	normalized to 1W	<b>9.70 mW / g ± 18.8 % (k=2)</b>
<b>SAR averaged over 10 cm<sup>3</sup> (10 g) of Body TSL</b>	Condition	
SAR measured	250 mW input power	1.65 mW / g
SAR for nominal Body TSL parameters	normalized to 1W	<b>6.50 mW / g ± 18.7 % (k=2)</b>



Add: No.51 Xueyuan Road, Haidian District, Beijing, 100191, China  
Tel: +86-10-62304633-2079 Fax: +86-10-62304633-2504  
E-mail: cttl@chinattl.com http://www.chinattl.cn

## Appendix (Additional assessments outside the scope of CNAS L0570)

### Antenna Parameters with Head TSL

Impedance, transformed to feed point	51.5Ω- 3.46jΩ
Return Loss	- 28.6dB

### Antenna Parameters with Body TSL

Impedance, transformed to feed point	48.3Ω- 4.75jΩ
Return Loss	- 25.8dB

### General Antenna Parameters and Design

Electrical Delay (one direction)	1.256 ns
----------------------------------	----------

After long term use with 100W radiated power, only a slight warming of the dipole near the feedpoint can be measured.

The dipole is made of standard semirigid coaxial cable. The center conductor of the feeding line is directly connected to the second arm of the dipole. The antenna is therefore short-circuited for DC-signals. On some of the dipoles, small end caps are added to the dipole arms in order to improve matching when loaded according to the position as explained in the "Measurement Conditions" paragraph. The SAR data are not affected by this change. The overall dipole length is still according to the Standard.

No excessive force must be applied to the dipole arms, because they might bend or the soldered connections near the feedpoint may be damaged.

### Additional EUT Data

Manufactured by	SPEAG
-----------------	-------



Add: No.51 Xueyuan Road, Haidian District, Beijing, 100191, China  
Tel: +86-10-62304633-2079 Fax: +86-10-62304633-2504  
E-mail: cttl@chinattl.com http://www.chinattl.cn

**DASY5 Validation Report for Head TSL**

Date: 09.04.2018

Test Laboratory: CTTL, Beijing, China

**DUT: Dipole 835 MHz; Type: D835V2; Serial: D835V2 - SN: 4d139**

Communication System: UID 0, CW; Frequency: 835 MHz; Duty Cycle: 1:1

Medium parameters used:  $f = 835$  MHz;  $\sigma = 0.904$  S/m;  $\epsilon_r = 42.71$ ;  $\rho = 1000$  kg/m<sup>3</sup>

Phantom section: Right Section

DASY5 Configuration:

- Probe: EX3DV4 - SN7464; ConvF(10.28, 10.28, 10.28) @ 835 MHz; Calibrated: 9/12/2017
- Sensor-Surface: 1.4mm (Mechanical Surface Detection)
- Electronics: DAE4 Sn1524; Calibrated: 9/13/2017
- Phantom: MFP\_V5.1C ; Type: QD 000 P51CA; Serial: 1062
- Measurement SW: DASY52, Version 52.10 (1); SEMCAD X Version 14.6.11 (7439)

**Dipole Calibration/Zoom Scan (7x7x7) (7x7x7)/Cube 0:** Measurement grid: dx=5mm, dy=5mm, dz=5mm

Reference Value = 58.15 V/m; Power Drift = 0.06 dB

Peak SAR (extrapolated) = 3.58 W/kg

**SAR(1 g) = 2.37 W/kg; SAR(10 g) = 1.56 W/kg**

Maximum value of SAR (measured) = 3.18 W/kg

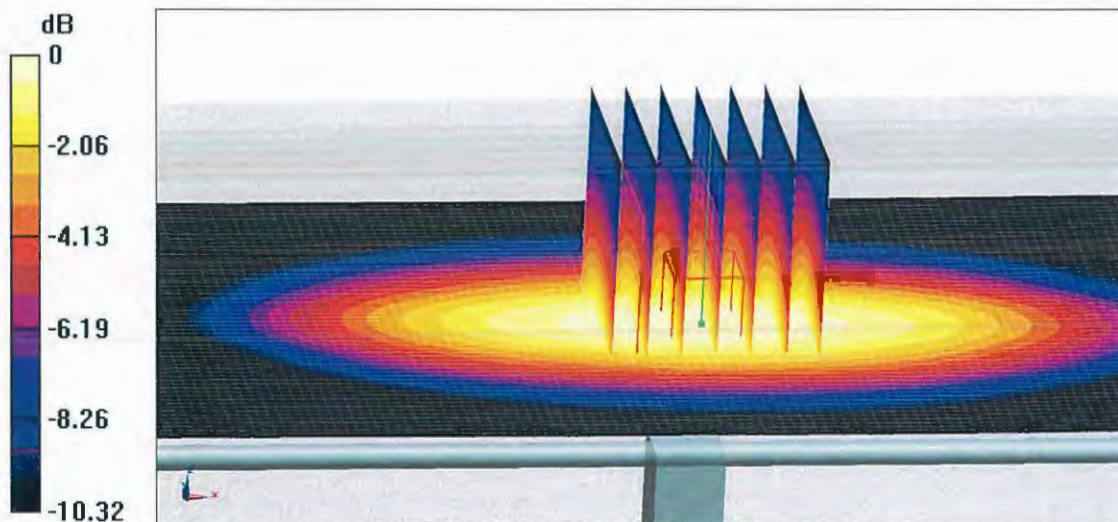

0 dB = 3.18 W/kg = 5.02 dBW/kg



Add: No.51 Xueyuan Road, Haidian District, Beijing, 100191, China  
Tel: +86-10-62304633-2079 Fax: +86-10-62304633-2504  
E-mail: cttl@chinattl.com http://www.chinattl.cn

### Impedance Measurement Plot for Head TSL

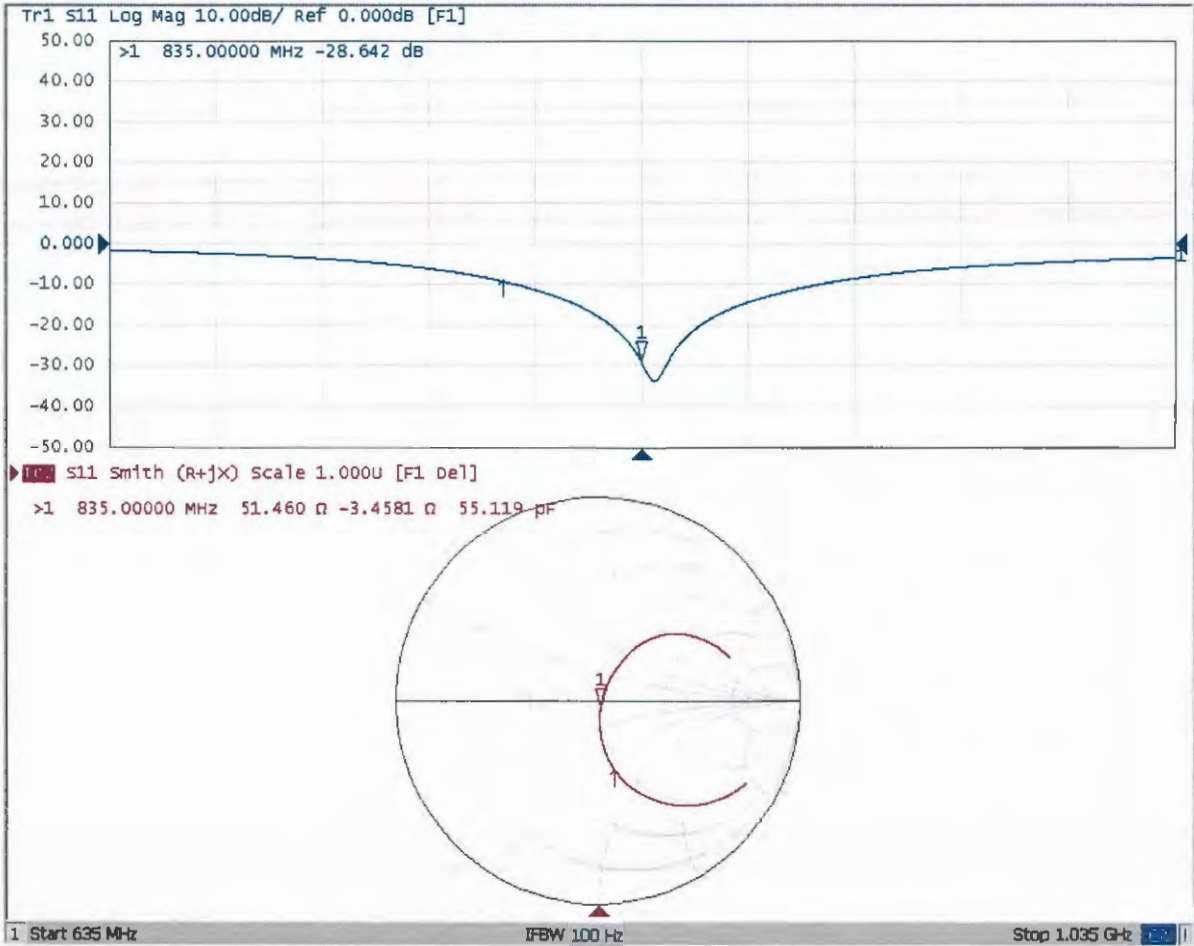



Add: No.51 Xueyuan Road, Haidian District, Beijing, 100191, China  
Tel: +86-10-62304633-2079 Fax: +86-10-62304633-2504  
E-mail: cttl@chinattl.com http://www.chinattl.cn

### DASY5 Validation Report for Body TSL

Date: 09.06.2018

Test Laboratory: CTTL, Beijing, China

**DUT: Dipole 835 MHz; Type: D835V2; Serial: D835V2 - SN: 4d139**

Communication System: UID 0, CW; Frequency: 835 MHz; Duty Cycle: 1:1

Medium parameters used:  $f = 835$  MHz;  $\sigma = 0.998$  S/m;  $\epsilon_r = 56.04$ ;  $\rho = 1000$  kg/m<sup>3</sup>

Phantom section: Center Section

DASY5 Configuration:

- Probe: EX3DV4 - SN7464; ConvF(10.21, 10.21, 10.21) @ 835 MHz; Calibrated: 9/12/2017
- Sensor-Surface: 1.4mm (Mechanical Surface Detection)
- Electronics: DAE4 Sn1524; Calibrated: 9/13/2017
- Phantom: MFP\_V5.1C ; Type: QD 000 P51CA; Serial: 1062
- Measurement SW: DASY52, Version 52.10 (1); SEMCAD X Version 14.6.11 (7439)

**Dipole Calibration/Zoom Scan (7x7x7) (7x7x7)/Cube 0:** Measurement grid: dx=5mm, dy=5mm, dz=5mm

Reference Value = 55.97 V/m; Power Drift = -0.05 dB

Peak SAR (extrapolated) = 3.69 W/kg

**SAR(1 g) = 2.47 W/kg; SAR(10 g) = 1.65 W/kg**

Maximum value of SAR (measured) = 3.26 W/kg

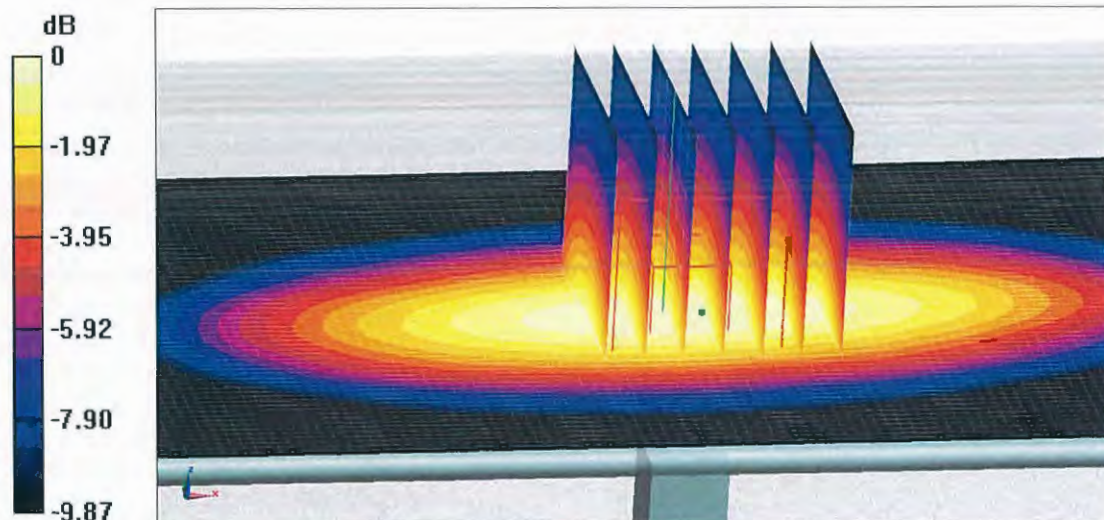

**0 dB = 3.26 W/kg = 5.13 dBW/kg**



Add: No.51 Xueyuan Road, Haidian District, Beijing, 100191, China  
Tel: +86-10-62304633-2079 Fax: +86-10-62304633-2504  
E-mail: cttl@chinattl.com http://www.chinattl.cn

### Impedance Measurement Plot for Body TSL

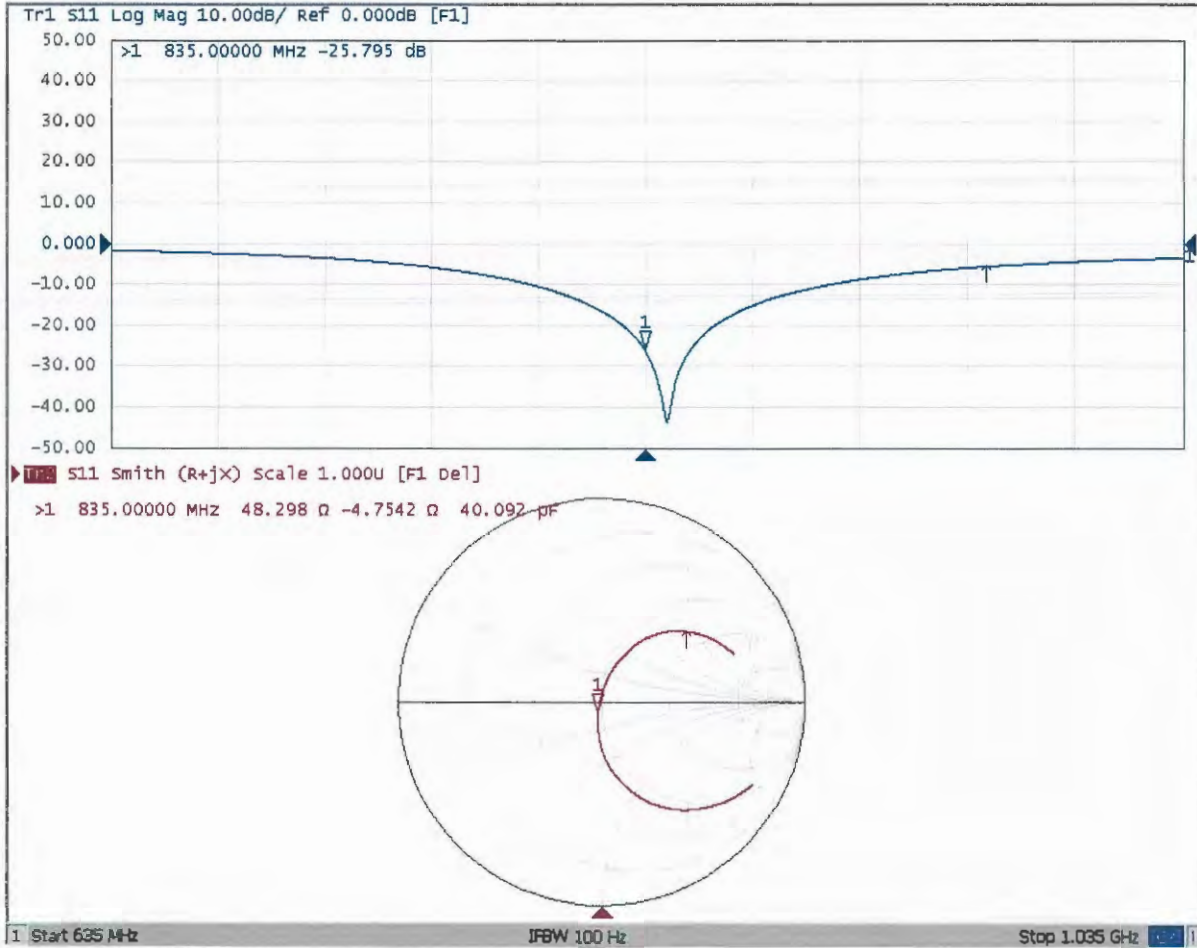



In Collaboration with  
**s p e a g**  
 CALIBRATION LABORATORY



中国认可  
 国际互认  
 校准  
 CALIBRATION  
 CNAS L0570

Add: No.51 Xueyuan Road, Haidian District, Beijing, 100191, China  
 Tel: +86-10-62304633-2079 Fax: +86-10-62304633-2504  
 E-mail: cttl@chinattl.com http://www.chinattl.cn

Client **ADT\_CN**

Certificate No: **Z18-60313**

## CALIBRATION CERTIFICATE

Object **D1750V2 - SN: 1071**

Calibration Procedure(s) **FF-Z11-003-01**  
**Calibration Procedures for dipole validation kits**

Calibration date: **September 13, 2018**

This calibration Certificate documents the traceability to national standards, which realize the physical units of measurements(SI). The measurements and the uncertainties with confidence probability are given on the following pages and are part of the certificate.

All calibrations have been conducted in the closed laboratory facility: environment temperature(22±3)°C and humidity<70%.

Calibration Equipment used (M&TE critical for calibration)

Primary Standards	ID #	Cal Date(Calibrated by, Certificate No.)	Scheduled Calibration
Power Meter NRVD	102083	01-Nov-17 (CTTL, No.J17X08756)	Oct-18
Power sensor NRV-Z5	100542	01-Nov-17 (CTTL, No.J17X08756)	Oct-18
Reference Probe EX3DV4	SN 3846	25-Jan-18(SPEAG,No.EX3-3846_Jan18)	Jan-19
DAE4	SN 777	15-Dec-17(SPEAG,No.DAE4-777_Dec17)	Dec-18
Secondary Standards	ID #	Cal Date(Calibrated by, Certificate No.)	Scheduled Calibration
Signal Generator E4438C	MY49071430	23-Jan-18 (CTTL, No.J18X00560)	Jan-19
NetworkAnalyzer E5071C	MY46110673	24-Jan-18 (CTTL, No.J18X00561)	Jan-19

	Name	Function	Signature
Calibrated by:	Zhao Jing	SAR Test Engineer	
Reviewed by:	Lin Jun	SAR Test Engineer	
Approved by:	Qi Dianyuan	SAR Project Leader	

Issued: September 16, 2018

This calibration certificate shall not be reproduced except in full without written approval of the laboratory.





**Glossary:**

TSL	tissue simulating liquid
ConvF	sensitivity in TSL / NORM <sub>x,y,z</sub>
N/A	not applicable or not measured

**Calibration is Performed According to the Following Standards:**

- a) IEEE Std 1528-2013, "IEEE Recommended Practice for Determining the Peak Spatial-Averaged Specific Absorption Rate (SAR) in the Human Head from Wireless Communications Devices: Measurement Techniques", June 2013
- b) IEC 62209-1, "Measurement procedure for assessment of specific absorption rate of human exposure to radio frequency fields from hand-held and body-mounted wireless communication devices- Part 1: Device used next to the ear (Frequency range of 300MHz to 6GHz)", July 2016
- c) IEC 62209-2, "Procedure to measure the Specific Absorption Rate (SAR) For wireless communication devices used in close proximity to the human body (frequency range of 30MHz to 6GHz)", March 2010
- d) KDB865664, SAR Measurement Requirements for 100 MHz to 6 GHz

**Additional Documentation:**

- e) DASY4/5 System Handbook

**Methods Applied and Interpretation of Parameters:**

- *Measurement Conditions:* Further details are available from the Validation Report at the end of the certificate. All figures stated in the certificate are valid at the frequency indicated.
- *Antenna Parameters with TSL:* The dipole is mounted with the spacer to position its feed point exactly below the center marking of the flat phantom section, with the arms oriented parallel to the body axis.
- *Feed Point Impedance and Return Loss:* These parameters are measured with the dipole positioned under the liquid filled phantom. The impedance stated is transformed from the measurement at the SMA connector to the feed point. The Return Loss ensures low reflected power. No uncertainty required.
- *Electrical Delay:* One-way delay between the SMA connector and the antenna feed point. No uncertainty required.
- *SAR measured:* SAR measured at the stated antenna input power.
- *SAR normalized:* SAR as measured, normalized to an input power of 1 W at the antenna connector.
- *SAR for nominal TSL parameters:* The measured TSL parameters are used to calculate the nominal SAR result.

The reported uncertainty of measurement is stated as the standard uncertainty of Measurement multiplied by the coverage factor  $k=2$ , which for a normal distribution Corresponds to a coverage probability of approximately 95%.



Add: No.51 Xueyuan Road, Haidian District, Beijing, 100191, China  
Tel: +86-10-62304633-2079 Fax: +86-10-62304633-2504  
E-mail: cttl@chinattl.com http://www.chinattl.cn

### Measurement Conditions

DASY system configuration, as far as not given on page 1.

DASY Version	DASY52	52.10.1.1476
Extrapolation	Advanced Extrapolation	
Phantom	Triple Flat Phantom 5.1C	
Distance Dipole Center - TSL	10 mm	with Spacer
Zoom Scan Resolution	dx, dy, dz = 5 mm	
Frequency	1750 MHz ± 1 MHz	

### Head TSL parameters

The following parameters and calculations were applied.

	Temperature	Permittivity	Conductivity
Nominal Head TSL parameters	22.0 °C	40.1	1.37 mho/m
Measured Head TSL parameters	(22.0 ± 0.2) °C	40.9 ± 6 %	1.36 mho/m ± 6 %
Head TSL temperature change during test	<1.0 °C	---	---

### SAR result with Head TSL

SAR averaged over 1 cm <sup>3</sup> (1 g) of Head TSL	Condition	
SAR measured	250 mW input power	9.12 mW / g
SAR for nominal Head TSL parameters	normalized to 1W	<b>36.8 mW / g ± 18.8 % (k=2)</b>
SAR averaged over 10 cm <sup>3</sup> (10 g) of Head TSL	Condition	
SAR measured	250 mW input power	4.92 mW / g
SAR for nominal Head TSL parameters	normalized to 1W	<b>19.8 mW / g ± 18.7 % (k=2)</b>

### Body TSL parameters

The following parameters and calculations were applied.

	Temperature	Permittivity	Conductivity
Nominal Body TSL parameters	22.0 °C	53.4	1.49 mho/m
Measured Body TSL parameters	(22.0 ± 0.2) °C	53.4 ± 6 %	1.52 mho/m ± 6 %
Body TSL temperature change during test	<1.0 °C	---	---

### SAR result with Body TSL

SAR averaged over 1 cm <sup>3</sup> (1 g) of Body TSL	Condition	
SAR measured	250 mW input power	9.62 mW / g
SAR for nominal Body TSL parameters	normalized to 1W	<b>38.0 mW / g ± 18.8 % (k=2)</b>
SAR averaged over 10 cm <sup>3</sup> (10 g) of Body TSL	Condition	
SAR measured	250 mW input power	5.20 mW / g
SAR for nominal Body TSL parameters	normalized to 1W	<b>20.6 mW / g ± 18.7 % (k=2)</b>



Add: No.51 Xueyuan Road, Haidian District, Beijing, 100191, China  
Tel: +86-10-62304633-2079 Fax: +86-10-62304633-2504  
E-mail: cttl@chinattl.com http://www.chinattl.cn

## Appendix (Additional assessments outside the scope of CNAS L0570)

### Antenna Parameters with Head TSL

Impedance, transformed to feed point	50.2- 2.39 jΩ
Return Loss	- 32.4 dB

### Antenna Parameters with Body TSL

Impedance, transformed to feed point	45.2Ω- 2.61 jΩ
Return Loss	- 24.8 dB

### General Antenna Parameters and Design

Electrical Delay (one direction)	1.083 ns
----------------------------------	----------

After long term use with 100W radiated power, only a slight warming of the dipole near the feedpoint can be measured.

The dipole is made of standard semirigid coaxial cable. The center conductor of the feeding line is directly connected to the second arm of the dipole. The antenna is therefore short-circuited for DC-signals. On some of the dipoles, small end caps are added to the dipole arms in order to improve matching when loaded according to the position as explained in the "Measurement Conditions" paragraph. The SAR data are not affected by this change. The overall dipole length is still according to the Standard.

No excessive force must be applied to the dipole arms, because they might bend or the soldered connections near the feedpoint may be damaged.

### Additional EUT Data

Manufactured by	SPEAG
-----------------	-------

**DASY5 Validation Report for Head TSL**

Date: 09.13.2018

Test Laboratory: CTTL, Beijing, China

**DUT: Dipole 1750 MHz; Type: D1750V2; Serial: D1750V2 - SN: 1071**

Communication System: UID 0, CW; Frequency: 1750 MHz; Duty Cycle: 1:1

Medium parameters used:  $f = 1750$  MHz;  $\sigma = 1.361$  S/m;  $\epsilon_r = 40.85$ ;  $\rho = 1000$  kg/m<sup>3</sup>

Phantom section: Center Section

DASY5 Configuration:

- Probe: EX3DV4 - SN3846; ConvF(8.41, 8.41, 8.41) @ 1750 MHz; Calibrated: 1/25/2018
- Sensor-Surface: 1.4mm (Mechanical Surface Detection)
- Electronics: DAE4 Sn777; Calibrated: 12/15/2017
- Phantom: MFP\_V5.1C ; Type: QD 000 P51CA; Serial: 1062
- Measurement SW: DASY52, Version 52.10 (1); SEMCAD X Version 14.6.11 (7439)

**System Performance Check/Zoom Scan (7x7x7) (7x7x7)/Cube 0: Measurement grid:**

$dx=5$ mm,  $dy=5$ mm,  $dz=5$ mm

Reference Value = 96.29 V/m; Power Drift = -0.03 dB

Peak SAR (extrapolated) = 16.7 W/kg

**SAR(1 g) = 9.12 W/kg; SAR(10 g) = 4.92 W/kg**

Maximum value of SAR (measured) = 14.0 W/kg

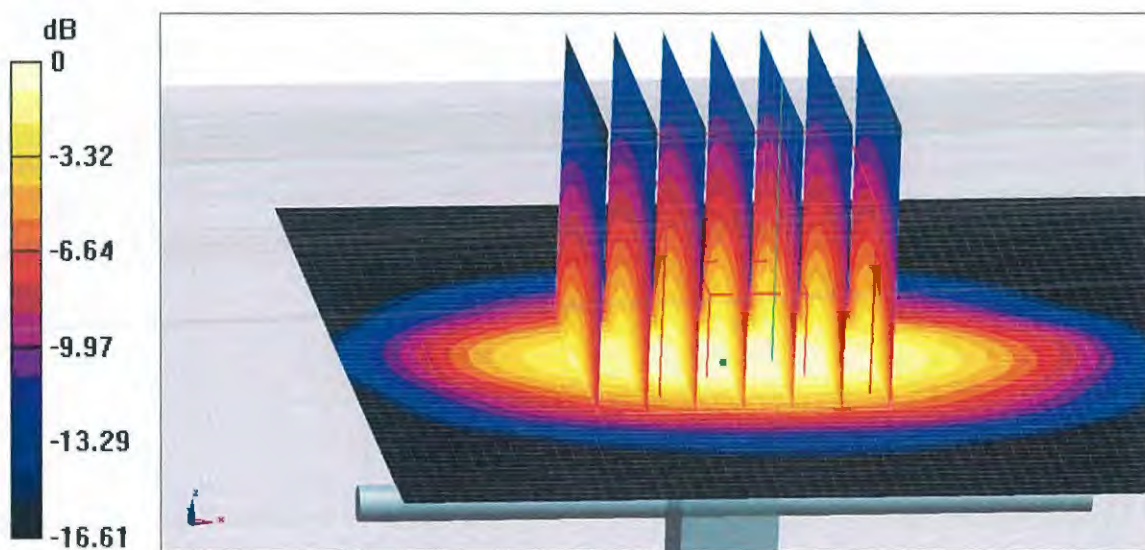

**0 dB = 14.0 W/kg = 11.46 dBW/kg**



Add: No.51 Xueyuan Road, Haidian District, Beijing, 100191, China  
Tel: +86-10-62304633-2079 Fax: +86-10-62304633-2504  
E-mail: cttl@chinattl.com http://www.chinattl.cn

### Impedance Measurement Plot for Head TSL

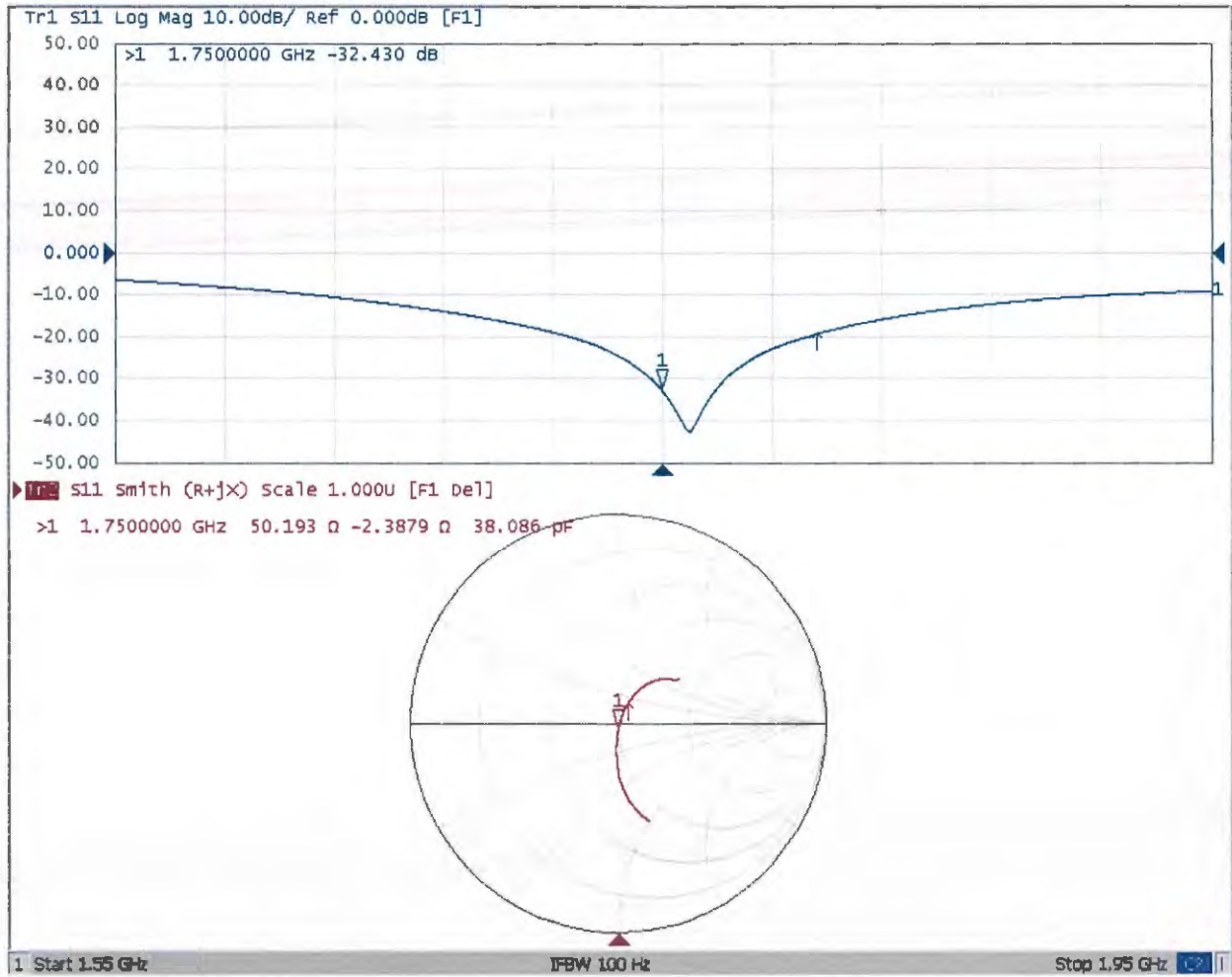

### DASY5 Validation Report for Body TSL

Date: 09.13.2018

Test Laboratory: CTTL, Beijing, China

**DUT: Dipole 1750 MHz; Type: D1750V2; Serial: D1750V2 - SN: 1071**

Communication System: UID 0, CW; Frequency: 1750 MHz; Duty Cycle: 1:1

Medium parameters used:  $f = 1750$  MHz;  $\sigma = 1.519$  S/m;  $\epsilon_r = 53.44$ ;  $\rho = 1000$  kg/m<sup>3</sup>

Phantom section: Left Section

DASY5 Configuration:

- Probe: EX3DV4 - SN3846; ConvF(7.84, 7.84, 7.84) @ 1750 MHz; Calibrated: 1/25/2018
- Sensor-Surface: 1.4mm (Mechanical Surface Detection)
- Electronics: DAE4 Sn777; Calibrated: 12/15/2017
- Phantom: MFP\_V5.1C ; Type: QD 000 P51CA; Serial: 1062
- Measurement SW: DASY52, Version 52.10 (1); SEMCAD X Version 14.6.11 (7439)

**System Performance Check/Zoom Scan (7x7x7) (7x7x7)/Cube 0:** Measurement grid:  
dx=5mm, dy=5mm, dz=5mm

Reference Value = 93.15 V/m; Power Drift = -0.00 dB

Peak SAR (extrapolated) = 17.3 W/kg

**SAR(1 g) = 9.62 W/kg; SAR(10 g) = 5.2 W/kg**

Maximum value of SAR (measured) = 14.7 W/kg

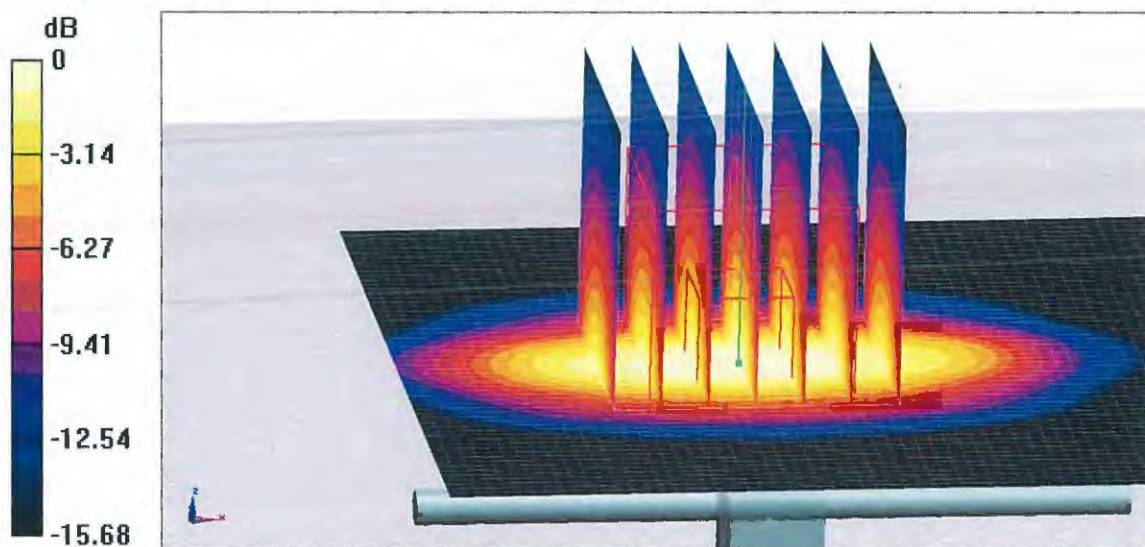

0 dB = 14.7 W/kg = 11.67 dBW/kg



Add: No.51 Xueyuan Road, Haidian District, Beijing, 100191, China  
Tel: +86-10-62304633-2079 Fax: +86-10-62304633-2504  
E-mail: cttl@chinattl.com http://www.chinattl.cn

### Impedance Measurement Plot for Body TSL

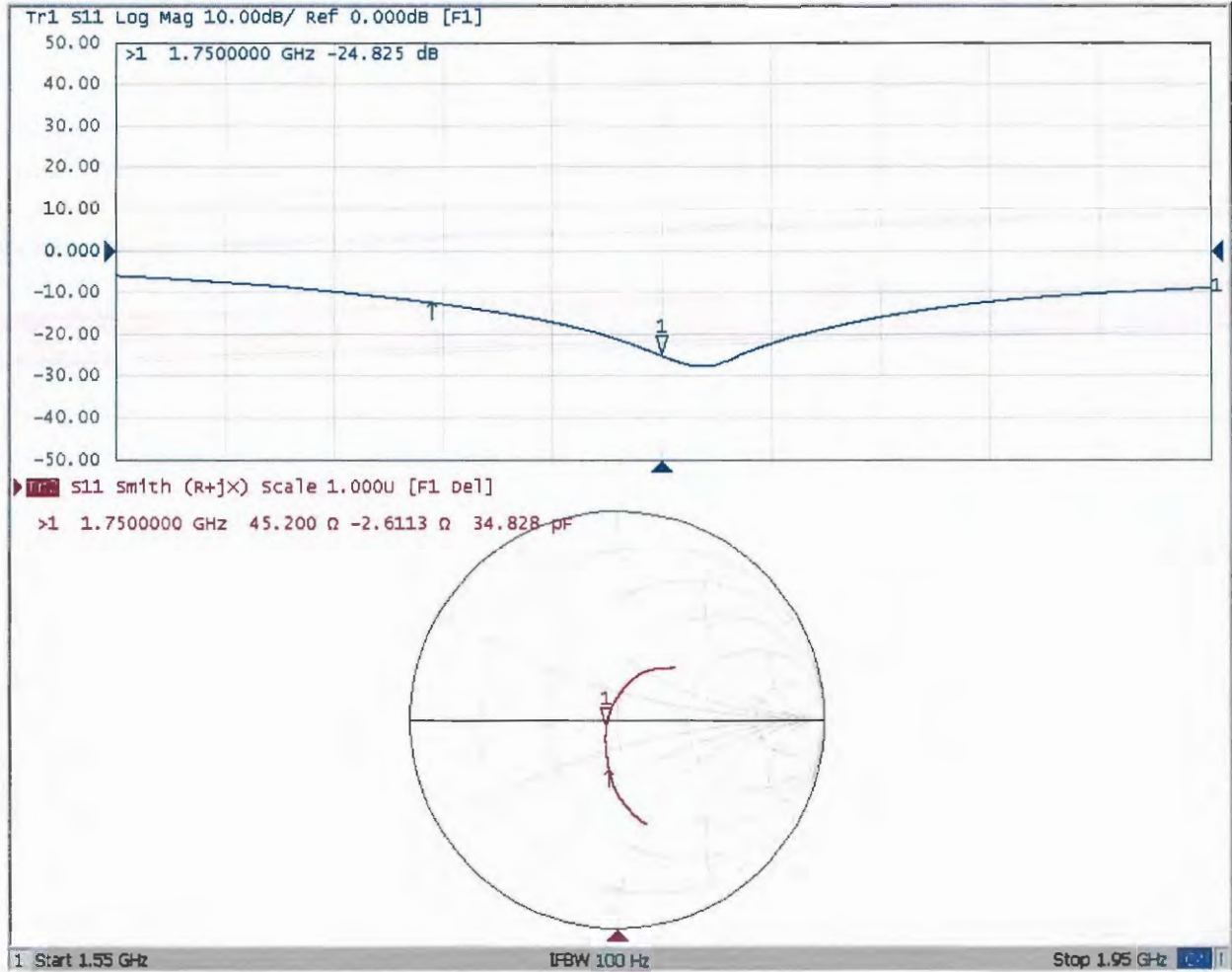



In Collaboration with  
**s p e a g**  
CALIBRATION LABORATORY



中国认可  
国际互认  
校准  
CALIBRATION  
CNAS L0570

Add: No.51 Xueyuan Road, Haidian District, Beijing, 100191, China  
Tel: +86-10-62304633-2079 Fax: +86-10-62304633-2504  
E-mail: cttl@chinattl.com http://www.chinattl.cn

Client **ADT\_CN**

Certificate No: **Z18-60314**

## CALIBRATION CERTIFICATE

Object **D1900V2 - SN: 5d159**

Calibration Procedure(s) **FF-Z11-003-01**  
**Calibration Procedures for dipole validation kits**

Calibration date: **September 11, 2018**

This calibration Certificate documents the traceability to national standards, which realize the physical units of measurements(SI). The measurements and the uncertainties with confidence probability are given on the following pages and are part of the certificate.

All calibrations have been conducted in the closed laboratory facility: environment temperature(22±3)°C and humidity<70%.

Calibration Equipment used (M&TE critical for calibration)

Primary Standards	ID #	Cal Date(Calibrated by, Certificate No.)	Scheduled Calibration
Power Meter NRVD	102083	01-Nov-17 (CTTL, No.J17X08756)	Oct-18
Power sensor NRV-Z5	100542	01-Nov-17 (CTTL, No.J17X08756)	Oct-18
Reference Probe EX3DV4	SN 7464	12-Sep-17(SPEAG,No.EX3-7464_Sep17)	Sep-18
DAE4	SN 1524	13-Sep-17(SPEAG,No.DAE4-1524_Sep17)	Sep-18
Secondary Standards	ID #	Cal Date(Calibrated by, Certificate No.)	Scheduled Calibration
Signal Generator E4438C	MY49071430	23-Jan-18 (CTTL, No.J18X00560)	Jan-19
NetworkAnalyzer E5071C	MY46110673	24-Jan-18 (CTTL, No.J18X00561)	Jan-19

	Name	Function	Signature
Calibrated by:	Zhao Jing	SAR Test Engineer	
Reviewed by:	Lin Jun	SAR Test Engineer	
Approved by:	Qi Dianyuan	SAR Project Leader	

Issued: September 15, 2018

This calibration certificate shall not be reproduced except in full without written approval of the laboratory.





**Glossary:**

TSL	tissue simulating liquid
ConvF	sensitivity in TSL / NORM <sub>x,y,z</sub>
N/A	not applicable or not measured

**Calibration is Performed According to the Following Standards:**

- a) IEEE Std 1528-2013, "IEEE Recommended Practice for Determining the Peak Spatial-Averaged Specific Absorption Rate (SAR) in the Human Head from Wireless Communications Devices: Measurement Techniques", June 2013
- b) IEC 62209-1, "Measurement procedure for assessment of specific absorption rate of human exposure to radio frequency fields from hand-held and body-mounted wireless communication devices- Part 1: Device used next to the ear (Frequency range of 300MHz to 6GHz)", July 2016
- c) IEC 62209-2, "Procedure to measure the Specific Absorption Rate (SAR) For wireless communication devices used in close proximity to the human body (frequency range of 30MHz to 6GHz)", March 2010
- d) KDB865664, SAR Measurement Requirements for 100 MHz to 6 GHz

**Additional Documentation:**

- e) DASY4/5 System Handbook

**Methods Applied and Interpretation of Parameters:**

- *Measurement Conditions:* Further details are available from the Validation Report at the end of the certificate. All figures stated in the certificate are valid at the frequency indicated.
- *Antenna Parameters with TSL:* The dipole is mounted with the spacer to position its feed point exactly below the center marking of the flat phantom section, with the arms oriented parallel to the body axis.
- *Feed Point Impedance and Return Loss:* These parameters are measured with the dipole positioned under the liquid filled phantom. The impedance stated is transformed from the measurement at the SMA connector to the feed point. The Return Loss ensures low reflected power. No uncertainty required.
- *Electrical Delay:* One-way delay between the SMA connector and the antenna feed point. No uncertainty required.
- *SAR measured:* SAR measured at the stated antenna input power.
- *SAR normalized:* SAR as measured, normalized to an input power of 1 W at the antenna connector.
- *SAR for nominal TSL parameters:* The measured TSL parameters are used to calculate the nominal SAR result.

The reported uncertainty of measurement is stated as the standard uncertainty of Measurement multiplied by the coverage factor  $k=2$ , which for a normal distribution Corresponds to a coverage probability of approximately 95%.



Add: No.51 Xueyuan Road, Haidian District, Beijing, 100191, China  
Tel: +86-10-62304633-2079 Fax: +86-10-62304633-2504  
E-mail: cttl@chinattl.com http://www.chinattl.cn

### Measurement Conditions

DASY system configuration, as far as not given on page 1.

DASY Version	DASY52	52.10.1.1476
Extrapolation	Advanced Extrapolation	
Phantom	Triple Flat Phantom 5.1C	
Distance Dipole Center - TSL	10 mm	with Spacer
Zoom Scan Resolution	dx, dy, dz = 5 mm	
Frequency	1900 MHz $\pm$ 1 MHz	

### Head TSL parameters

The following parameters and calculations were applied.

	Temperature	Permittivity	Conductivity
Nominal Head TSL parameters	22.0 °C	40.0	1.40 mho/m
Measured Head TSL parameters	(22.0 $\pm$ 0.2) °C	40.4 $\pm$ 6 %	1.44 mho/m $\pm$ 6 %
Head TSL temperature change during test	<1.0 °C	----	----

### SAR result with Head TSL

SAR averaged over 1 $cm^3$ (1 g) of Head TSL	Condition	
SAR measured	250 mW input power	10.1 mW / g
SAR for nominal Head TSL parameters	normalized to 1W	39.8 mW / g $\pm$ 18.8 % (k=2)
SAR averaged over 10 $cm^3$ (10 g) of Head TSL	Condition	
SAR measured	250 mW input power	5.32 mW / g
SAR for nominal Head TSL parameters	normalized to 1W	21.1 mW / g $\pm$ 18.7 % (k=2)

### Body TSL parameters

The following parameters and calculations were applied.

	Temperature	Permittivity	Conductivity
Nominal Body TSL parameters	22.0 °C	53.3	1.52 mho/m
Measured Body TSL parameters	(22.0 $\pm$ 0.2) °C	53.3 $\pm$ 6 %	1.49 mho/m $\pm$ 6 %
Body TSL temperature change during test	<1.0 °C	----	----

### SAR result with Body TSL

SAR averaged over 1 $cm^3$ (1 g) of Body TSL	Condition	
SAR measured	250 mW input power	9.95 mW / g
SAR for nominal Body TSL parameters	normalized to 1W	40.2 mW / g $\pm$ 18.8 % (k=2)
SAR averaged over 10 $cm^3$ (10 g) of Body TSL	Condition	
SAR measured	250 mW input power	5.40 mW / g
SAR for nominal Body TSL parameters	normalized to 1W	21.8 mW / g $\pm$ 18.7 % (k=2)



Add: No.51 Xueyuan Road, Haidian District, Beijing, 100191, China  
Tel: +86-10-62304633-2079 Fax: +86-10-62304633-2504  
E-mail: cttl@chinattl.com http://www.chinattl.cn

## Appendix (Additional assessments outside the scope of CNAS L0570)

### Antenna Parameters with Head TSL

Impedance, transformed to feed point	53.8Ω+ 8.45jΩ
Return Loss	- 21.0dB

### Antenna Parameters with Body TSL

Impedance, transformed to feed point	48.8Ω+ 9.35jΩ
Return Loss	- 20.4dB

### General Antenna Parameters and Design

Electrical Delay (one direction)	1.065 ns
----------------------------------	----------

After long term use with 100W radiated power, only a slight warming of the dipole near the feedpoint can be measured.

The dipole is made of standard semirigid coaxial cable. The center conductor of the feeding line is directly connected to the second arm of the dipole. The antenna is therefore short-circuited for DC-signals. On some of the dipoles, small end caps are added to the dipole arms in order to improve matching when loaded according to the position as explained in the "Measurement Conditions" paragraph. The SAR data are not affected by this change. The overall dipole length is still according to the Standard.

No excessive force must be applied to the dipole arms, because they might bend or the soldered connections near the feedpoint may be damaged.

### Additional EUT Data

Manufactured by	SPEAG
-----------------	-------

### DASY5 Validation Report for Head TSL

Date: 09.10.2018

Test Laboratory: CTTL, Beijing, China

**DUT: Dipole 1900 MHz; Type: D1900V2; Serial: D1900V2 - SN: 5d159**

Communication System: UID 0, CW; Frequency: 1900 MHz; Duty Cycle: 1:1

Medium parameters used:  $f = 1900$  MHz;  $\sigma = 1.438$  S/m;  $\epsilon_r = 40.37$ ;  $\rho = 1000$  kg/m<sup>3</sup>

Phantom section: Center Section

DASY5 Configuration:

- Probe: EX3DV4 - SN7464; ConvF(8.39, 8.39, 8.39) @ 1900 MHz; Calibrated: 9/12/2017
- Sensor-Surface: 1.4mm (Mechanical Surface Detection)
- Electronics: DAE4 Sn1524; Calibrated: 9/13/2017
- Phantom: MFP\_V5.1C ; Type: QD 000 P51CA; Serial: 1062
- Measurement SW: DASY52, Version 52.10 (1); SEMCAD X Version 14.6.11 (7439)

**System Performance Check/Zoom Scan (7x7x7) (7x7x7)/Cube 0: Measurement grid:**

$dx=5$ mm,  $dy=5$ mm,  $dz=5$ mm

Reference Value = 99.53 V/m; Power Drift = 0.01 dB

Peak SAR (extrapolated) = 18.9 W/kg

**SAR(1 g) = 10.1 W/kg; SAR(10 g) = 5.32 W/kg**

Maximum value of SAR (measured) = 15.6 W/kg

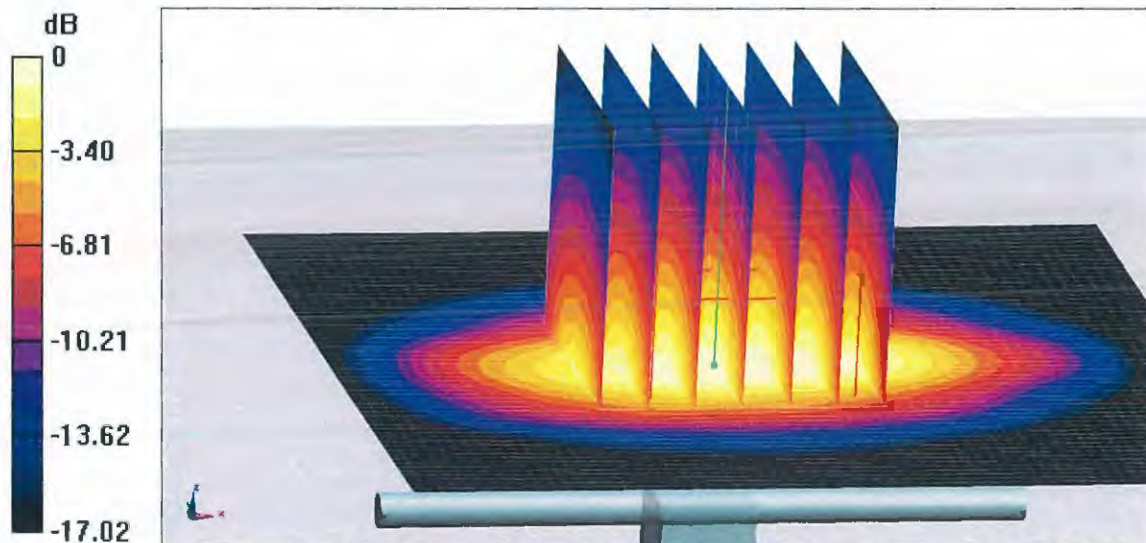

**0 dB = 15.6 W/kg = 11.93 dBW/kg**



Add: No.51 Xueyuan Road, Haidian District, Beijing, 100191, China  
Tel: +86-10-62304633-2079 Fax: +86-10-62304633-2504  
E-mail: cttl@chinattl.com http://www.chinattl.cn

### Impedance Measurement Plot for Head TSL

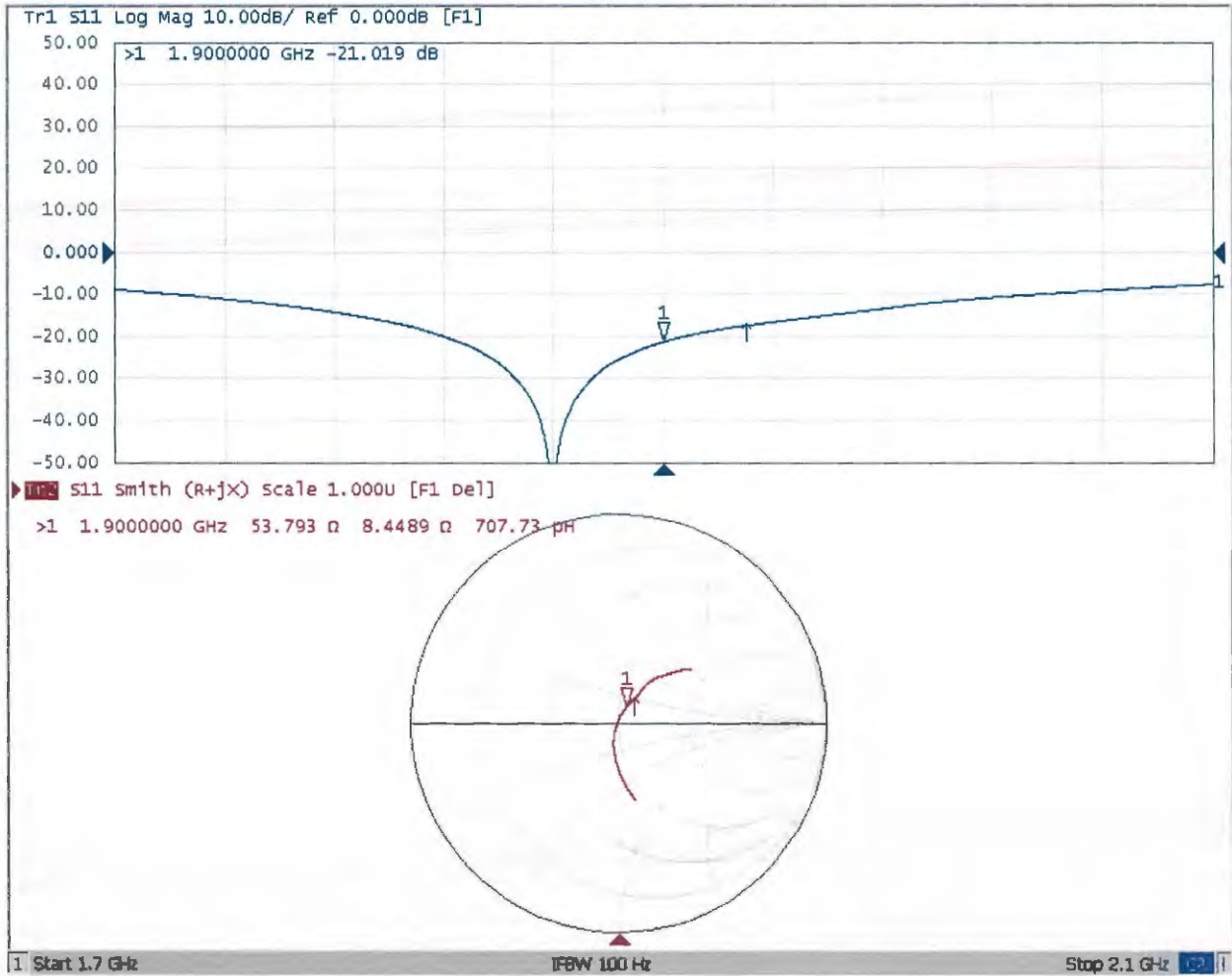

### DASY5 Validation Report for Body TSL

Date: 09.10.2018

Test Laboratory: CTTL, Beijing, China

**DUT: Dipole 1900 MHz; Type: D1900V2; Serial: D1900V2 - SN: 5d159**

Communication System: UID 0, CW; Frequency: 1900 MHz; Duty Cycle: 1:I

Medium parameters used:  $f = 1900$  MHz;  $\sigma = 1.493$  S/m;  $\epsilon_r = 53.34$ ;  $\rho = 1000$  kg/m<sup>3</sup>

Phantom section: Right Section

DASY5 Configuration:

- Probe: EX3DV4 - SN7464; ConvF(8.32, 8.32, 8.32) @ 1900 MHz; Calibrated: 9/12/2017
- Sensor-Surface: 1.4mm (Mechanical Surface Detection)
- Electronics: DAE4 Sn1524; Calibrated: 9/13/2017
- Phantom: MFP\_V5.1C ; Type: QD 000 P51CA; Serial: 1062
- Measurement SW: DASY52, Version 52.10 (1); SEMCAD X Version 14.6.11 (7439)

**System Performance Check/Zoom Scan (7x7x7) (7x7x7)/Cube 0:** Measurement grid:  
dx=5mm, dy=5mm, dz=5mm

Reference Value = 96.14 V/m; Power Drift = -0.02 dB

Peak SAR (extrapolated) = 17.5 W/kg

**SAR(1 g) = 9.95 W/kg; SAR(10 g) = 5.4 W/kg**

Maximum value of SAR (measured) = 15.0 W/kg

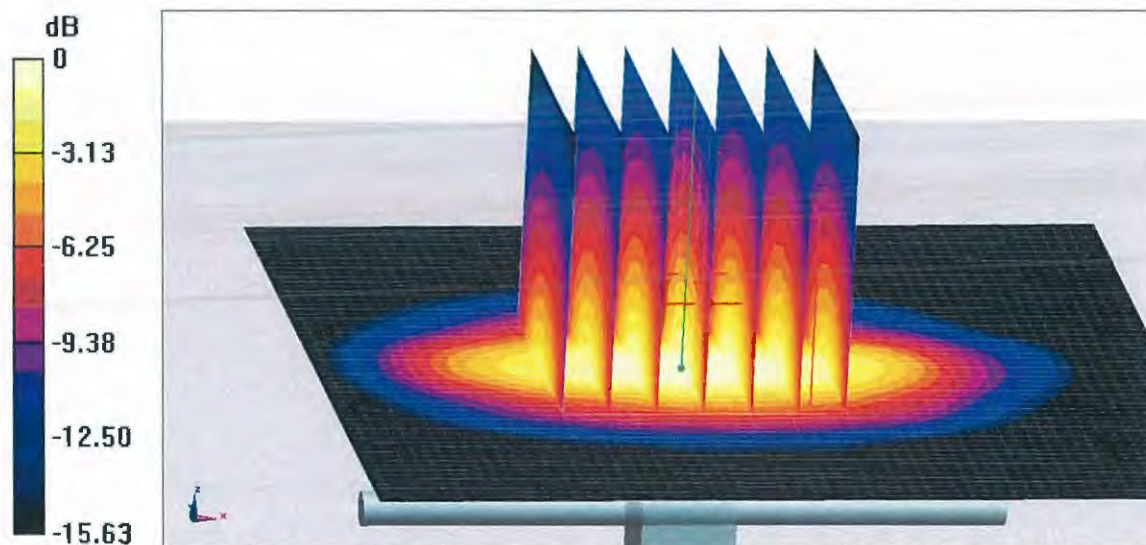

0 dB = 15.0 W/kg = 11.76 dBW/kg



Add: No.51 Xueyuan Road, Haidian District, Beijing, 100191, China  
Tel: +86-10-62304633-2079 Fax: +86-10-62304633-2504  
E-mail: cttl@chinattl.com http://www.chinattl.cn

### Impedance Measurement Plot for Body TSL

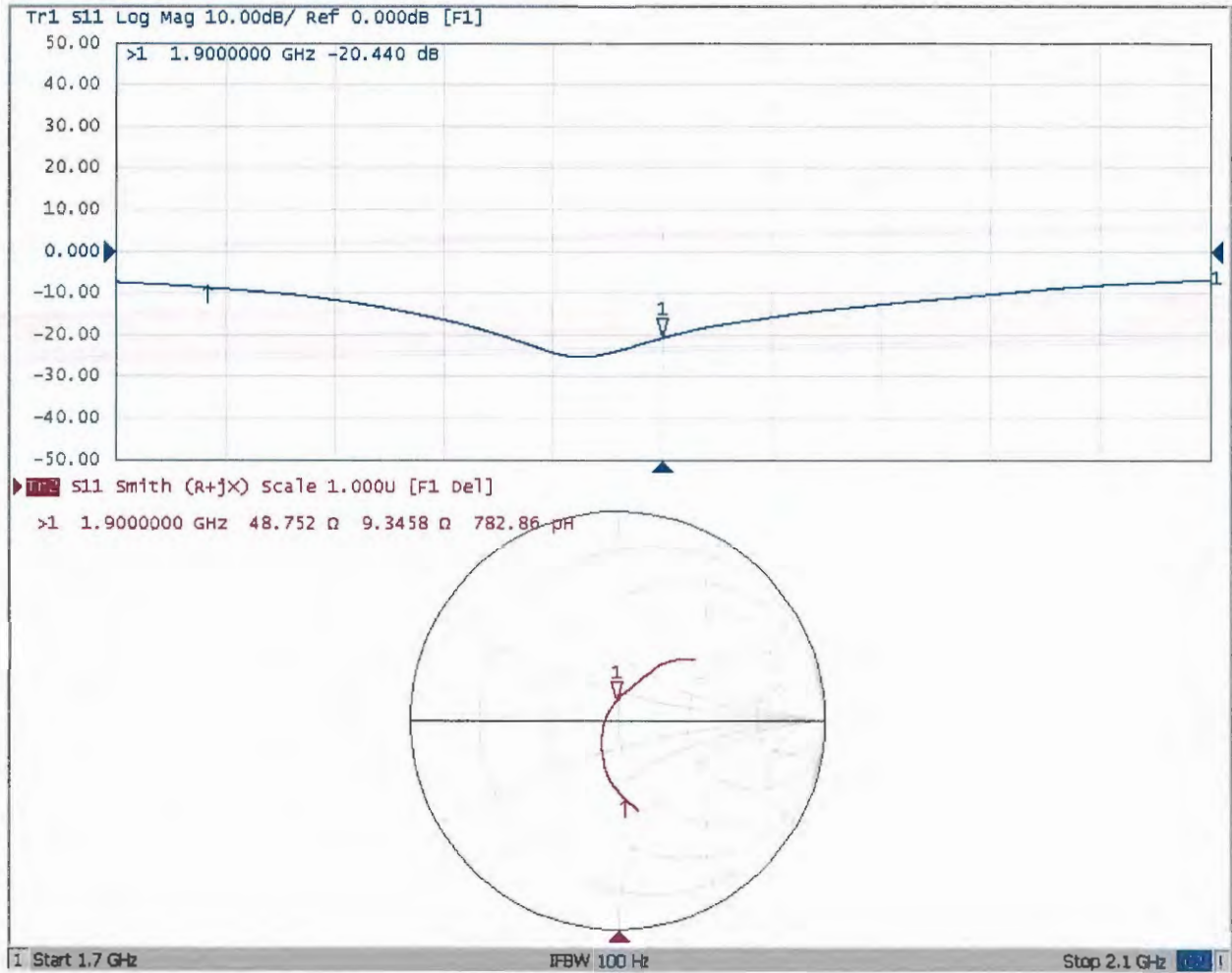



In Collaboration with  
**s p e a g**  
 CALIBRATION LABORATORY



中国认可  
 国际互认  
 校准  
 CALIBRATION  
 CNAS L0570

Add: No.51 Xueyuan Road, Haidian District, Beijing, 100191, China  
 Tel: +86-10-62304633-2079 Fax: +86-10-62304633-2504  
 E-mail: cttl@chinattl.com http://www.chinattl.cn

Client

ADT\_CN

Certificate No:

Z18-60316

## CALIBRATION CERTIFICATE

Object D2450V2 - SN: 893

Calibration Procedure(s) FF-Z11-003-01  
 Calibration Procedures for dipole validation kits

Calibration date: August 31, 2018

This calibration Certificate documents the traceability to national standards, which realize the physical units of measurements(SI). The measurements and the uncertainties with confidence probability are given on the following pages and are part of the certificate.

All calibrations have been conducted in the closed laboratory facility: environment temperature(22±3)°C and humidity<70%.

Calibration Equipment used (M&TE critical for calibration)

Primary Standards	ID #	Cal Date(Calibrated by, Certificate No.)	Scheduled Calibration
Power Meter NRVD	102083	01-Nov-17 (CTTL, No.J17X08756)	Oct-18
Power sensor NRV-Z5	100542	01-Nov-17 (CTTL, No.J17X08756)	Oct-18
Reference Probe EX3DV4	SN 7464	12-Sep-17(SPEAG,No.EX3-7464_Sep17)	Sep-18
DAE4	SN 1524	13-Sep-17(SPEAG,No.DAE4-1524_Sep17)	Sep-18
Secondary Standards	ID #	Cal Date(Calibrated by, Certificate No.)	Scheduled Calibration
Signal Generator E4438C	MY49071430	23-Jan-18 (CTTL, No.J18X0056)	Jan-19
NetworkAnalyzer E5071C	MY46110673	24-Jan-18 (CTTL, No.J18X00561)	Jan-19

	Name	Function	Signature
Calibrated by:	Zhao Jing	SAR Test Engineer	
Reviewed by:	Lin Hao	SAR Test Engineer	
Approved by:	Qi Dianyuan	SAR Project Leader	

Issued: September 3, 2018

This calibration certificate shall not be reproduced except in full without written approval of the laboratory.





In Collaboration with

**s p e a g**  
**CALIBRATION LABORATORY**

Add: No.51 Xueyuan Road, Haidian District, Beijing, 100191, China  
Tel: +86-10-62304633-2079 Fax: +86-10-62304633-2504  
E-mail: cttl@chinattl.com http://www.chinattl.cn

#### Glossary:

TSL	tissue simulating liquid
ConvF	sensitivity in TSL / NORM <sub>x,y,z</sub>
N/A	not applicable or not measured

#### Calibration is Performed According to the Following Standards:

- IEEE Std 1528-2013, "IEEE Recommended Practice for Determining the Peak Spatial-Averaged Specific Absorption Rate (SAR) in the Human Head from Wireless Communications Devices: Measurement Techniques", June 2013
- IEC 62209-1, "Measurement procedure for assessment of specific absorption rate of human exposure to radio frequency fields from hand-held and body-mounted wireless communication devices- Part 1: Device used next to the ear (Frequency range of 300MHz to 6GHz)", July 2016
- IEC 62209-2, "Procedure to measure the Specific Absorption Rate (SAR) For wireless communication devices used in close proximity to the human body (frequency range of 30MHz to 6GHz)", March 2010
- KDB865664, SAR Measurement Requirements for 100 MHz to 6 GHz

#### Additional Documentation:

- DASY4/5 System Handbook

#### Methods Applied and Interpretation of Parameters:

- Measurement Conditions:* Further details are available from the Validation Report at the end of the certificate. All figures stated in the certificate are valid at the frequency indicated.
- Antenna Parameters with TSL:* The dipole is mounted with the spacer to position its feed point exactly below the center marking of the flat phantom section, with the arms oriented parallel to the body axis.
- Feed Point Impedance and Return Loss:* These parameters are measured with the dipole positioned under the liquid filled phantom. The impedance stated is transformed from the measurement at the SMA connector to the feed point. The Return Loss ensures low reflected power. No uncertainty required.
- Electrical Delay:* One-way delay between the SMA connector and the antenna feed point. No uncertainty required.
- SAR measured:* SAR measured at the stated antenna input power.
- SAR normalized:* SAR as measured, normalized to an input power of 1 W at the antenna connector.
- SAR for nominal TSL parameters:* The measured TSL parameters are used to calculate the nominal SAR result.

The reported uncertainty of measurement is stated as the standard uncertainty of Measurement multiplied by the coverage factor  $k=2$ , which for a normal distribution Corresponds to a coverage probability of approximately 95%.



Add: No.51 Xueyuan Road, Haidian District, Beijing, 100191, China  
 Tel: +86-10-62304633-2079 Fax: +86-10-62304633-2504  
 E-mail: cttl@chinattl.com http://www.chinattl.cn

### Measurement Conditions

DASY system configuration, as far as not given on page 1.

DASY Version	DASY52	52.10.1.1476
Extrapolation	Advanced Extrapolation	
Phantom	Triple Flat Phantom 5.1C	
Distance Dipole Center - TSL	10 mm	with Spacer
Zoom Scan Resolution	dx, dy, dz = 5 mm	
Frequency	2450 MHz ± 1 MHz	

### Head TSL parameters

The following parameters and calculations were applied.

	Temperature	Permittivity	Conductivity
Nominal Head TSL parameters	22.0 °C	39.2	1.80 mho/m
Measured Head TSL parameters	(22.0 ± 0.2) °C	38.8 ± 6 %	1.80 mho/m ± 6 %
Head TSL temperature change during test	<1.0 °C	---	---

### SAR result with Head TSL

<b>SAR averaged over 1 cm<sup>3</sup> (1 g) of Head TSL</b>	Condition	
SAR measured	250 mW input power	13.3 mW / g
SAR for nominal Head TSL parameters	normalized to 1W	<b>53.1 mW / g ± 18.8 % (k=2)</b>
<b>SAR averaged over 10 cm<sup>3</sup> (10 g) of Head TSL</b>	Condition	
SAR measured	250 mW input power	6.20 mW / g
SAR for nominal Head TSL parameters	normalized to 1W	<b>24.8 mW / g ± 18.7 % (k=2)</b>

### Body TSL parameters

The following parameters and calculations were applied.

	Temperature	Permittivity	Conductivity
Nominal Body TSL parameters	22.0 °C	52.7	1.95 mho/m
Measured Body TSL parameters	(22.0 ± 0.2) °C	52.3 ± 6 %	1.98 mho/m ± 6 %
Body TSL temperature change during test	<1.0 °C	---	---

### SAR result with Body TSL

<b>SAR averaged over 1 cm<sup>3</sup> (1 g) of Body TSL</b>	Condition	
SAR measured	250 mW input power	13.0 mW / g
SAR for nominal Body TSL parameters	normalized to 1W	<b>51.5 mW / g ± 18.8 % (k=2)</b>
<b>SAR averaged over 10 cm<sup>3</sup> (10 g) of Body TSL</b>	Condition	
SAR measured	250 mW input power	6.12 mW / g
SAR for nominal Body TSL parameters	normalized to 1W	<b>24.4 mW / g ± 18.7 % (k=2)</b>



Add: No.51 Xueyuan Road, Haidian District, Beijing, 100191, China  
Tel: +86-10-62304633-2079 Fax: +86-10-62304633-2504  
E-mail: cttl@chinattl.com http://www.chinattl.cn

## Appendix (Additional assessments outside the scope of CNAS L0570)

### Antenna Parameters with Head TSL

Impedance, transformed to feed point	53.4Ω+ 5.49jΩ
Return Loss	- 24.1dB

### Antenna Parameters with Body TSL

Impedance, transformed to feed point	49.5Ω+ 6.97jΩ
Return Loss	- 23.1dB

### General Antenna Parameters and Design

Electrical Delay (one direction)	1.025 ns
----------------------------------	----------

After long term use with 100W radiated power, only a slight warming of the dipole near the feedpoint can be measured.

The dipole is made of standard semirigid coaxial cable. The center conductor of the feeding line is directly connected to the second arm of the dipole. The antenna is therefore short-circuited for DC-signals. On some of the dipoles, small end caps are added to the dipole arms in order to improve matching when loaded according to the position as explained in the "Measurement Conditions" paragraph. The SAR data are not affected by this change. The overall dipole length is still according to the Standard.

No excessive force must be applied to the dipole arms, because they might bend or the soldered connections near the feedpoint may be damaged.

### Additional EUT Data

Manufactured by	SPEAG
-----------------	-------



Add: No.51 Xueyuan Road, Haidian District, Beijing, 100191, China  
Tel: +86-10-62304633-2079 Fax: +86-10-62304633-2504  
E-mail: cttl@chinattl.com http://www.chinattl.cn

**DASY5 Validation Report for Head TSL**

Date: 08.31.2018

Test Laboratory: CTTL, Beijing, China

**DUT: Dipole 2450 MHz; Type: D2450V2; Serial: D2450V2 - SN: 893**

Communication System: UID 0, CW; Frequency: 2450 MHz; Duty Cycle: 1:1

Medium parameters used:  $f = 2450$  MHz;  $\sigma = 1.802$  S/m;  $\epsilon_r = 38.84$ ;  $\rho = 1000$  kg/m<sup>3</sup>

Phantom section: Right Section

DASY5 Configuration:

- Probe: EX3DV4 - SN7464; ConvF(7.89, 7.89, 7.89) @ 2450 MHz; Calibrated: 9/12/2017
- Sensor-Surface: 1.4mm (Mechanical Surface Detection)
- Electronics: DAE4 Sn1524; Calibrated: 9/13/2017
- Phantom: MFP\_V5.1C ; Type: QD 000 P51CA; Serial: 1062
- Measurement SW: DASY52, Version 52.10 (1); SEMCAD X Version 14.6.11 (7439)

**Dipole Calibration/Zoom Scan (7x7x7) (7x7x7)/Cube 0:** Measurement grid: dx=5mm, dy=5mm, dz=5mm

Reference Value = 100.4 V/m; Power Drift = 0.04 dB

Peak SAR (extrapolated) = 27.7 W/kg

**SAR(1 g) = 13.3 W/kg; SAR(10 g) = 6.2 W/kg**

Maximum value of SAR (measured) = 22.2 W/kg

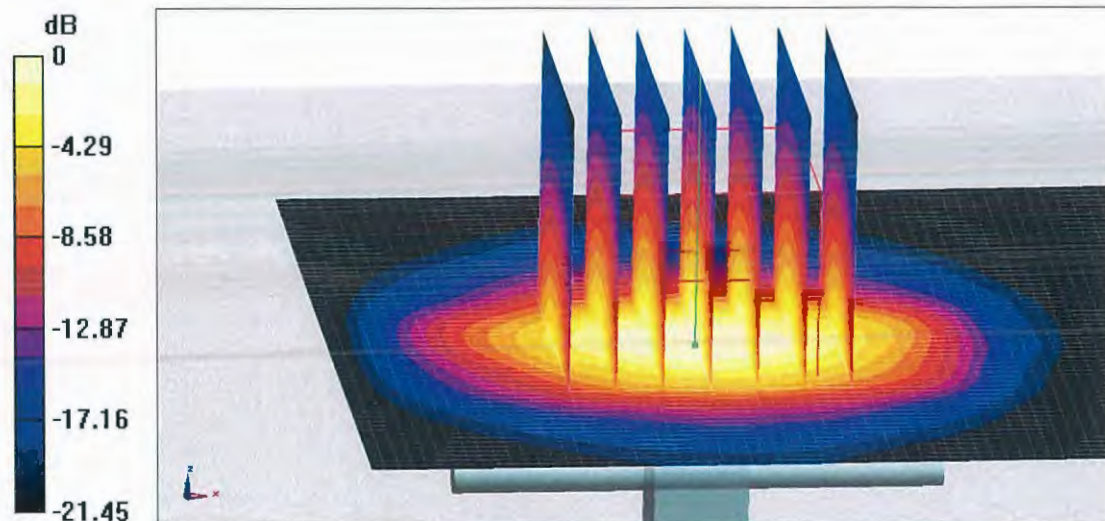

0 dB = 22.2 W/kg = 13.46 dBW/kg



Add: No.51 Xueyuan Road, Haidian District, Beijing, 100191, China  
Tel: +86-10-62304633-2079 Fax: +86-10-62304633-2504  
E-mail: cttl@chinattl.com http://www.chinattl.cn

### Impedance Measurement Plot for Head TSL

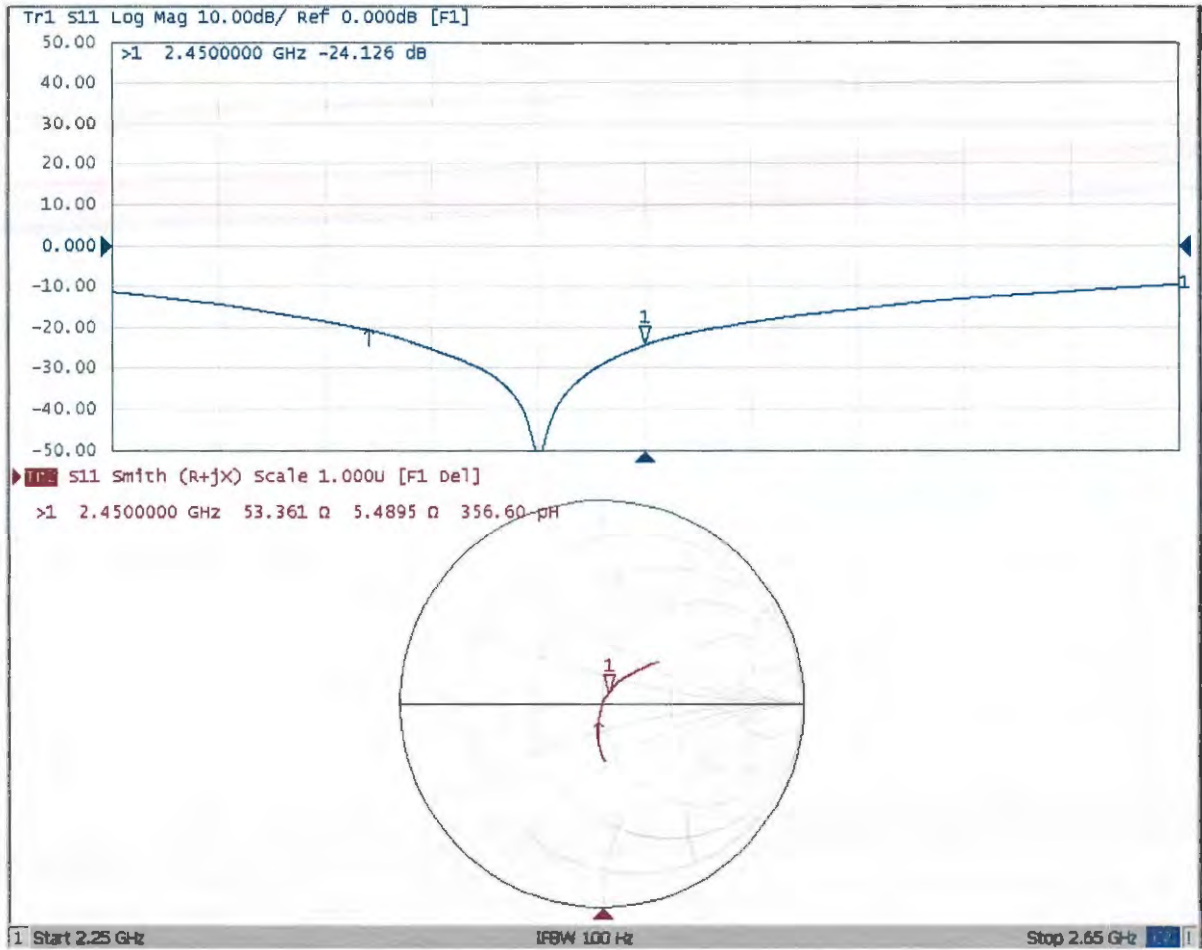



Add: No.51 Xueyuan Road, Haidian District, Beijing, 100191, China  
Tel: +86-10-62304633-2079 Fax: +86-10-62304633-2504  
E-mail: cttl@chinattl.com http://www.chinattl.cn

**DASY5 Validation Report for Body TSL**

Date: 08.30.2018

Test Laboratory: CTTL, Beijing, China

**DUT: Dipole 2450 MHz; Type: D2450V2; Serial: D2450V2 - SN: 893**

Communication System: UID 0, CW; Frequency: 2450 MHz; Duty Cycle: 1:1

Medium parameters used:  $f = 2450$  MHz;  $\sigma = 1.982$  S/m;  $\epsilon_r = 52.34$ ;  $\rho = 1000$  kg/m<sup>3</sup>

Phantom section: Center Section

DASY5 Configuration:

- Probe: EX3DV4 - SN7464; ConvF(8.09, 8.09, 8.09) @ 2450 MHz; Calibrated: 9/12/2017
- Sensor-Surface: 1.4mm (Mechanical Surface Detection)
- Electronics: DAE4 Sn1524; Calibrated: 9/13/2017
- Phantom: MFP\_V5.1C ; Type: QD 000 P51CA; Serial: 1062
- Measurement SW: DASY52, Version 52.10 (1); SEMCAD X Version 14.6.11 (7439)

**Dipole Calibration/Zoom Scan (7x7x7) (7x7x7)/Cube 0:** Measurement grid: dx=5mm, dy=5mm, dz=5mm

Reference Value = 98.86 V/m; Power Drift = 0.00 dB

Peak SAR (extrapolated) = 26.3 W/kg

**SAR(1 g) = 13 W/kg; SAR(10 g) = 6.12 W/kg**

Maximum value of SAR (measured) = 21.4 W/kg

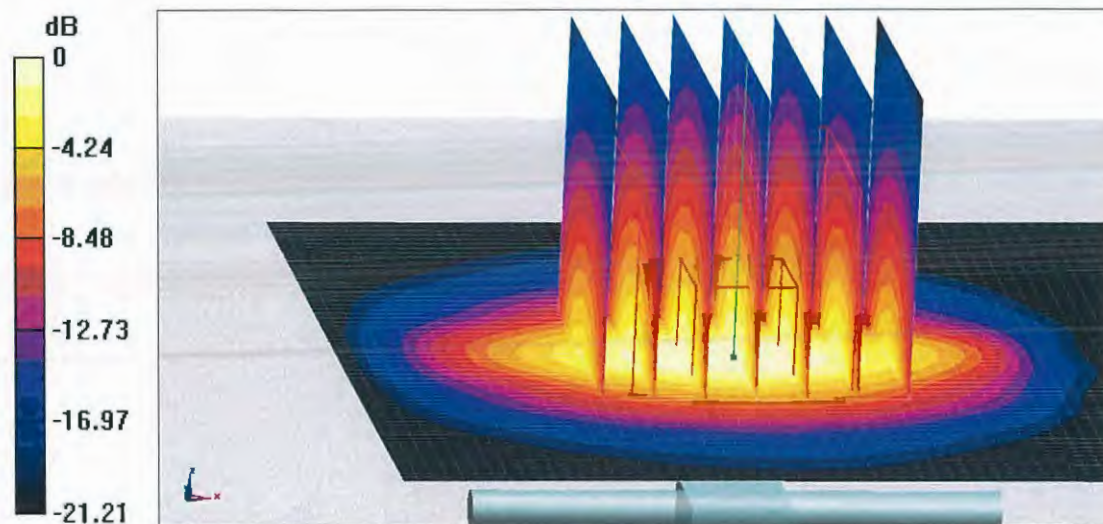

0 dB = 21.4 W/kg = 13.30 dBW/kg



Add: No.51 Xueyuan Road, Haidian District, Beijing, 100191, China  
Tel: +86-10-62304633-2079 Fax: +86-10-62304633-2504  
E-mail: cttl@chinattl.com http://www.chinattl.cn

### Impedance Measurement Plot for Body TSL

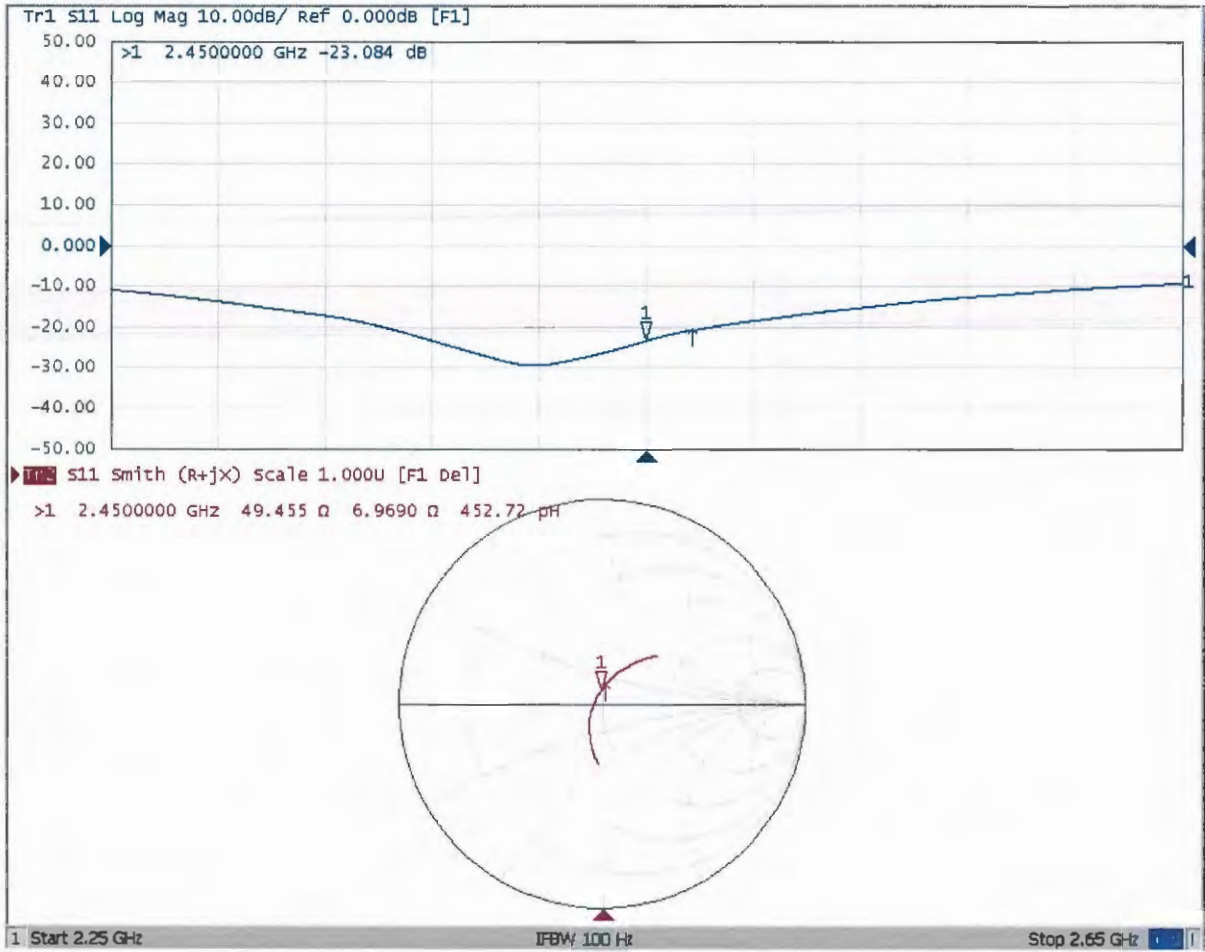

1341

ADT-CN

## IMPORTANT NOTICE

### USAGE OF THE DAE 4

The DAE unit is a delicate, high precision instrument and requires careful treatment by the user. There are no serviceable parts inside the DAE. Special attention shall be given to the following points:

**Battery Exchange:** The battery cover of the DAE4 unit is closed using a screw, over tightening the screw may cause the threads inside the DAE to wear out.

**Shipping of the DAE:** Before shipping the DAE to SPEAG for calibration, remove the batteries and pack the DAE in an antistatic bag. This antistatic bag shall then be packed into a larger box or container which protects the DAE from impacts during transportation. The package shall be marked to indicate that a fragile instrument is inside.

**E-Stop Failures:** Touch detection may be malfunctioning due to broken magnets in the E-stop. Rough handling of the E-stop may lead to damage of these magnets. Touch and collision errors are often caused by dust and dirt accumulated in the E-stop. To prevent E-stop failure, the customer shall always mount the probe to the DAE carefully and keep the DAE unit in a non-dusty environment if not used for measurements.

**Repair:** Minor repairs are performed at no extra cost during the annual calibration. However, SPEAG reserves the right to charge for any repair especially if rough unprofessional handling caused the defect.

**DASY Configuration Files:** Since the exact values of the DAE input resistances, as measured during the calibration procedure of a DAE unit, are not used by the DASY software, a nominal value of 200 MOhm is given in the corresponding configuration file.

**Important Note:**

**Warranty and calibration is void if the DAE unit is disassembled partly or fully by the Customer.**

**Important Note:**

**Never attempt to grease or oil the E-stop assembly. Cleaning and readjusting of the E-stop assembly is allowed by certified SPEAG personnel only and is part of the annual calibration procedure.**

**Important Note:**

**To prevent damage of the DAE probe connector pins, use great care when installing the probe to the DAE. Carefully connect the probe with the connector notch oriented in the mating position. Avoid any rotational movement of the probe body versus the DAE while turning the locking nut of the connector. The same care shall be used when disconnecting the probe from the DAE.**





Accredited by the Swiss Accreditation Service (SAS)  
The Swiss Accreditation Service is one of the signatories to the EA  
Multilateral Agreement for the recognition of calibration certificates

Accreditation No.: **SCS 0108**

Client **ADT-CN (Auden)**

Certificate No: **DAE4-1341\_Aug18**

## CALIBRATION CERTIFICATE

Object **DAE4 - SD 000 D04 BM - SN: 1341**

Calibration procedure(s) **QA CAL-06.v29  
Calibration procedure for the data acquisition electronics (DAE)**

Calibration date: **August 28, 2018**

This calibration certificate documents the traceability to national standards, which realize the physical units of measurements (SI).  
The measurements and the uncertainties with confidence probability are given on the following pages and are part of the certificate.

All calibrations have been conducted in the closed laboratory facility: environment temperature ( $22 \pm 3$ )°C and humidity < 70%.

Calibration Equipment used (M&TE critical for calibration)

Primary Standards	ID #	Cal Date (Certificate No.)	Scheduled Calibration
Keithley Multimeter Type 2001	SN: 0810278	31-Aug-17 (No:21092)	Aug-18
Secondary Standards	ID #	Check Date (in house)	Scheduled Check
Auto DAE Calibration Unit	SE UWS 053 AA 1001	04-Jan-18 (in house check)	In house check: Jan-19
Calibrator Box V2.1	SE UMS 006 AA 1002	04-Jan-18 (in house check)	In house check: Jan-19

	Name	Function	Signature
Calibrated by:	Eric Hainfeld	Laboratory Technician	
Approved by:	Sven Kühn	Deputy Manager	

Issued: August 28, 2018

This calibration certificate shall not be reproduced except in full without written approval of the laboratory.



Accredited by the Swiss Accreditation Service (SAS)

The Swiss Accreditation Service is one of the signatories to the EA  
Multilateral Agreement for the recognition of calibration certificates

Accreditation No.: **SCS 0108**

## Glossary

DAE data acquisition electronics  
Connector angle information used in DASY system to align probe sensor X to the robot coordinate system.

## Methods Applied and Interpretation of Parameters

- *DC Voltage Measurement*: Calibration Factor assessed for use in DASY system by comparison with a calibrated instrument traceable to national standards. The figure given corresponds to the full scale range of the voltmeter in the respective range.
- *Connector angle*: The angle of the connector is assessed measuring the angle mechanically by a tool inserted. Uncertainty is not required.
- The following parameters as documented in the Appendix contain technical information as a result from the performance test and require no uncertainty.
  - *DC Voltage Measurement Linearity*: Verification of the Linearity at +10% and -10% of the nominal calibration voltage. Influence of offset voltage is included in this measurement.
  - *Common mode sensitivity*: Influence of a positive or negative common mode voltage on the differential measurement.
  - *Channel separation*: Influence of a voltage on the neighbor channels not subject to an input voltage.
  - *AD Converter Values with inputs shorted*: Values on the internal AD converter corresponding to zero input voltage
  - *Input Offset Measurement*: Output voltage and statistical results over a large number of zero voltage measurements.
  - *Input Offset Current*: Typical value for information; Maximum channel input offset current, not considering the input resistance.
  - *Input resistance*: Typical value for information: DAE input resistance at the connector, during internal auto-zeroing and during measurement.
  - *Low Battery Alarm Voltage*: Typical value for information. Below this voltage, a battery alarm signal is generated.
  - *Power consumption*: Typical value for information. Supply currents in various operating modes.

## DC Voltage Measurement

A/D - Converter Resolution nominal

High Range: 1LSB = 6.1 $\mu$ V, full range = -100...+300 mV

Low Range: 1LSB = 61nV, full range = -1.....+3mV

DASY measurement parameters: Auto Zero Time: 3 sec; Measuring time: 3 sec

Calibration Factors	X	Y	Z
High Range	403.760 $\pm$ 0.02% (k=2)	403.982 $\pm$ 0.02% (k=2)	403.691 $\pm$ 0.02% (k=2)
Low Range	3.98727 $\pm$ 1.50% (k=2)	4.00567 $\pm$ 1.50% (k=2)	4.00055 $\pm$ 1.50% (k=2)

## Connector Angle

Connector Angle to be used in DASY system	169.5 $^{\circ}$ $\pm$ 1 $^{\circ}$
---	-------------------------------------

## Appendix (Additional assessments outside the scope of SCS0108)

### 1. DC Voltage Linearity

High Range	Reading ( $\mu\text{V}$ )	Difference ( $\mu\text{V}$ )	Error (%)
Channel X + Input	200038.81	-0.53	-0.00
Channel X + Input	20008.93	2.65	0.01
Channel X - Input	-20004.32	1.13	-0.01
Channel Y + Input	200038.86	-0.49	-0.00
Channel Y + Input	20007.60	1.41	0.01
Channel Y - Input	-20004.90	0.64	-0.00
Channel Z + Input	200040.45	0.71	0.00
Channel Z + Input	20002.67	-3.40	-0.02
Channel Z - Input	-20006.75	-1.11	0.01

Low Range	Reading ( $\mu\text{V}$ )	Difference ( $\mu\text{V}$ )	Error (%)
Channel X + Input	2002.18	0.28	0.01
Channel X + Input	201.99	0.21	0.10
Channel X - Input	-197.87	0.29	-0.15
Channel Y + Input	2002.01	0.14	0.01
Channel Y + Input	201.19	-0.51	-0.25
Channel Y - Input	-199.05	-0.95	0.48
Channel Z + Input	2001.51	-0.25	-0.01
Channel Z + Input	200.12	-1.43	-0.71
Channel Z - Input	-200.14	-1.86	0.94

### 2. Common mode sensitivity

DASY measurement parameters: Auto Zero Time: 3 sec; Measuring time: 3 sec

	Common mode Input Voltage (mV)	High Range Average Reading ( $\mu\text{V}$ )	Low Range Average Reading ( $\mu\text{V}$ )
Channel X	200	12.05	11.04
	- 200	-10.36	-11.68
Channel Y	200	-5.59	-6.00
	- 200	4.98	4.47
Channel Z	200	-22.35	-22.59
	- 200	20.13	19.94

### 3. Channel separation

DASY measurement parameters: Auto Zero Time: 3 sec; Measuring time: 3 sec

	Input Voltage (mV)	Channel X ( $\mu\text{V}$ )	Channel Y ( $\mu\text{V}$ )	Channel Z ( $\mu\text{V}$ )
Channel X	200	-	-3.88	-2.83
Channel Y	200	5.06	-	-2.33
Channel Z	200	9.82	3.14	-

#### 4. AD-Converter Values with inputs shorted

DASY measurement parameters: Auto Zero Time: 3 sec; Measuring time: 3 sec

	High Range (LSB)	Low Range (LSB)
Channel X	15976	16401
Channel Y	15930	16931
Channel Z	16272	17413

#### 5. Input Offset Measurement

DASY measurement parameters: Auto Zero Time: 3 sec; Measuring time: 3 sec

Input 10M $\Omega$

	Average ( $\mu$ V)	min. Offset ( $\mu$ V)	max. Offset ( $\mu$ V)	Std. Deviation ( $\mu$ V)
Channel X	1.41	0.49	2.58	0.45
Channel Y	0.92	-0.09	1.95	0.43
Channel Z	-1.81	-2.94	-0.68	0.46

#### 6. Input Offset Current

Nominal Input circuitry offset current on all channels: <25fA

#### 7. Input Resistance (Typical values for information)

	Zeroing (kOhm)	Measuring (MOhm)
Channel X	200	200
Channel Y	200	200
Channel Z	200	200

#### 8. Low Battery Alarm Voltage (Typical values for information)

Typical values	Alarm Level (VDC)
Supply (+ Vcc)	+7.9
Supply (- Vcc)	-7.6

#### 9. Power Consumption (Typical values for information)

Typical values	Switched off (mA)	Stand by (mA)	Transmitting (mA)
Supply (+ Vcc)	+0.01	+6	+14
Supply (- Vcc)	-0.01	-8	-9



Accredited by the Swiss Accreditation Service (SAS)  
The Swiss Accreditation Service is one of the signatories to the EA  
Multilateral Agreement for the recognition of calibration certificates

Accreditation No.: **SCS 0108**

Client **ADT-CN (Auden)**

Certificate No: **EX3-3873\_Aug18**

## CALIBRATION CERTIFICATE

Object: **EX3DV4 - SN:3873**

Calibration procedure(s): **QA CAL-01.v9, QA CAL-14.v4, QA CAL-23.v5, QA CAL-25.v6  
Calibration procedure for dosimetric E-field probes**

Calibration date: **August 31, 2018**

This calibration certificate documents the traceability to national standards, which realize the physical units of measurements (SI).  
The measurements and the uncertainties with confidence probability are given on the following pages and are part of the certificate.

All calibrations have been conducted in the closed laboratory facility: environment temperature (22 ± 3)°C and humidity < 70%.

Calibration Equipment used (M&TE critical for calibration)

Primary Standards	ID	Cal Date (Certificate No.)	Scheduled Calibration
Power meter NRP	SN: 104778	04-Apr-18 (No. 217-02672/02673)	Apr-19
Power sensor NRP-Z91	SN: 103244	04-Apr-18 (No. 217-02672)	Apr-19
Power sensor NRP-Z91	SN: 103245	04-Apr-18 (No. 217-02673)	Apr-19
Reference 20 dB Attenuator	SN: S5277 (20x)	04-Apr-18 (No. 217-02682)	Apr-19
Reference Probe ES3DV2	SN: 3013	30-Dec-17 (No. ES3-3013_Dec17)	Dec-18
DAE4	SN: 660	21-Dec-17 (No. DAE4-660_Dec17)	Dec-18
Secondary Standards	ID	Check Date (in house)	Scheduled Check
Power meter E4419B	SN: GB41293874	06-Apr-16 (in house check Jun-18)	In house check: Jun-20
Power sensor E4412A	SN: MY41498087	06-Apr-16 (in house check Jun-18)	In house check: Jun-20
Power sensor E4412A	SN: 000110210	06-Apr-16 (in house check Jun-18)	In house check: Jun-20
RF generator HP 8648C	SN: US3642U01700	04-Aug-99 (in house check Jun-18)	In house check: Jun-20
Network Analyzer E8358A	SN: US41080477	31-Mar-14 (in house check Oct-17)	In house check: Oct-18

Calibrated by:	Name <b>Claudio Leubler</b>	Function <b>Laboratory Technician</b>	Signature 
Approved by:	Name <b>Katja Pokovic</b>	Function <b>Technical Manager</b>	Signature 

Issued: September 1, 2018

This calibration certificate shall not be reproduced except in full without written approval of the laboratory.



Accredited by the Swiss Accreditation Service (SAS)

Accreditation No.: **SCS 0108**

The Swiss Accreditation Service is one of the signatories to the EA Multilateral Agreement for the recognition of calibration certificates

### Glossary:

TSL	tissue simulating liquid
NORM <sub>x,y,z</sub>	sensitivity in free space
ConvF	sensitivity in TSL / NORM <sub>x,y,z</sub>
DCP	diode compression point
CF	crest factor (1/duty_cycle) of the RF signal
A, B, C, D	modulation dependent linearization parameters
Polarization $\varphi$	$\varphi$ rotation around probe axis
Polarization $\vartheta$	$\vartheta$ rotation around an axis that is in the plane normal to probe axis (at measurement center), i.e., $\vartheta = 0$ is normal to probe axis
Connector Angle	information used in DASY system to align probe sensor X to the robot coordinate system

### Calibration is Performed According to the Following Standards:

- IEEE Std 1528-2013, "IEEE Recommended Practice for Determining the Peak Spatial-Averaged Specific Absorption Rate (SAR) in the Human Head from Wireless Communications Devices: Measurement Techniques", June 2013
- IEC 62209-1, "Measurement procedure for the assessment of Specific Absorption Rate (SAR) from hand-held and body-mounted devices used next to the ear (frequency range of 300 MHz to 6 GHz)", July 2016
- IEC 62209-2, "Procedure to determine the Specific Absorption Rate (SAR) for wireless communication devices used in close proximity to the human body (frequency range of 30 MHz to 6 GHz)", March 2010
- KDB 865664, "SAR Measurement Requirements for 100 MHz to 6 GHz"

### Methods Applied and Interpretation of Parameters:

- NORM<sub>x,y,z</sub>**: Assessed for E-field polarization  $\vartheta = 0$  ( $f \leq 900$  MHz in TEM-cell;  $f > 1800$  MHz: R22 waveguide). NORM<sub>x,y,z</sub> are only intermediate values, i.e., the uncertainties of NORM<sub>x,y,z</sub> does not affect the  $E^2$ -field uncertainty inside TSL (see below ConvF).
- NORM(f)<sub>x,y,z</sub>** = NORM<sub>x,y,z</sub> \* frequency\_response (see Frequency Response Chart). This linearization is implemented in DASY4 software versions later than 4.2. The uncertainty of the frequency response is included in the stated uncertainty of ConvF.
- DCP<sub>x,y,z</sub>**: DCP are numerical linearization parameters assessed based on the data of power sweep with CW signal (no uncertainty required). DCP does not depend on frequency nor media.
- PAR**: PAR is the Peak to Average Ratio that is not calibrated but determined based on the signal characteristics
- A<sub>x,y,z</sub>; B<sub>x,y,z</sub>; C<sub>x,y,z</sub>; D<sub>x,y,z</sub>; VR<sub>x,y,z</sub>**: A, B, C, D are numerical linearization parameters assessed based on the data of power sweep for specific modulation signal. The parameters do not depend on frequency nor media. VR is the maximum calibration range expressed in RMS voltage across the diode.
- ConvF and Boundary Effect Parameters**: Assessed in flat phantom using E-field (or Temperature Transfer Standard for  $f \leq 800$  MHz) and inside waveguide using analytical field distributions based on power measurements for  $f > 800$  MHz. The same setups are used for assessment of the parameters applied for boundary compensation (alpha, depth) of which typical uncertainty values are given. These parameters are used in DASY4 software to improve probe accuracy close to the boundary. The sensitivity in TSL corresponds to NORM<sub>x,y,z</sub> \* ConvF whereby the uncertainty corresponds to that given for ConvF. A frequency dependent ConvF is used in DASY version 4.4 and higher which allows extending the validity from  $\pm 50$  MHz to  $\pm 100$  MHz.
- Spherical isotropy (3D deviation from isotropy)**: in a field of low gradients realized using a flat phantom exposed by a patch antenna.
- Sensor Offset**: The sensor offset corresponds to the offset of virtual measurement center from the probe tip (on probe axis). No tolerance required.
- Connector Angle**: The angle is assessed using the information gained by determining the NORM<sub>x</sub> (no uncertainty required).

# Probe EX3DV4

## SN:3873

Manufactured: March 13, 2012  
Calibrated: August 31, 2018

Calibrated for DASY/EASY Systems  
(Note: non-compatible with DASY2 system!)



## DASY/EASY - Parameters of Probe: EX3DV4 - SN:3873

### Basic Calibration Parameters

	Sensor X	Sensor Y	Sensor Z	Unc (k=2)
Norm ( $\mu\text{V}/(\text{V}/\text{m})^2$ ) <sup>A</sup>	0.37	0.45	0.48	$\pm 10.1 \%$
DCP (mV) <sup>B</sup>	101.7	99.8	96.7	

### Modulation Calibration Parameters

UID	Communication System Name		A dB	B dB/ $\mu\text{V}$	C	D dB	VR mV	Unc <sup>E</sup> (k=2)
0	CW	X	0.0	0.0	1.0	0.00	156.8	$\pm 3.5 \%$
		Y	0.0	0.0	1.0		170.2	
		Z	0.0	0.0	1.0		154.8	

The reported uncertainty of measurement is stated as the standard uncertainty of measurement multiplied by the coverage factor  $k=2$ , which for a normal distribution corresponds to a coverage probability of approximately 95%.

<sup>A</sup> The uncertainties of Norm X,Y,Z do not affect the  $E^2$ -field uncertainty inside TSL (see Pages 5 and 6).

<sup>B</sup> Numerical linearization parameter: uncertainty not required.

<sup>E</sup> Uncertainty is determined using the max. deviation from linear response applying rectangular distribution and is expressed for the square of the field value.

## DASY/EASY - Parameters of Probe: EX3DV4 - SN:3873

### Calibration Parameter Determined in Head Tissue Simulating Media

f (MHz) <sup>C</sup>	Relative Permittivity <sup>F</sup>	Conductivity (S/m) <sup>F</sup>	ConvF X	ConvF Y	ConvF Z	Alpha <sup>G</sup>	Depth <sup>G</sup> (mm)	Unc (k=2)
750	41.9	0.89	10.15	10.15	10.15	0.49	0.80	± 12.0 %
835	41.5	0.90	9.69	9.69	9.69	0.36	0.99	± 12.0 %
900	41.5	0.97	9.42	9.42	9.42	0.45	0.85	± 12.0 %
1450	40.5	1.20	8.72	8.72	8.72	0.37	0.80	± 12.0 %
1750	40.1	1.37	8.39	8.39	8.39	0.31	0.87	± 12.0 %
1900	40.0	1.40	8.12	8.12	8.12	0.34	0.85	± 12.0 %
2300	39.5	1.67	7.72	7.72	7.72	0.29	0.86	± 12.0 %
2450	39.2	1.80	7.19	7.19	7.19	0.30	0.95	± 12.0 %
2600	39.0	1.96	7.11	7.11	7.11	0.35	0.85	± 12.0 %
5250	35.9	4.71	4.90	4.90	4.90	0.40	1.80	± 13.1 %
5600	35.5	5.07	4.56	4.56	4.56	0.40	1.80	± 13.1 %
5800	35.3	5.27	4.60	4.60	4.60	0.40	1.80	± 13.1 %

<sup>C</sup> Frequency validity above 300 MHz of ± 100 MHz only applies for DASY v4.4 and higher (see Page 2), else it is restricted to ± 50 MHz. The uncertainty is the RSS of the ConvF uncertainty at calibration frequency and the uncertainty for the indicated frequency band. Frequency validity below 300 MHz is ± 10, 25, 40, 50 and 70 MHz for ConvF assessments at 30, 64, 128, 150 and 220 MHz respectively. Above 5 GHz frequency validity can be extended to ± 110 MHz.

<sup>F</sup> At frequencies below 3 GHz, the validity of tissue parameters ( $\epsilon$  and  $\sigma$ ) can be relaxed to ± 10% if liquid compensation formula is applied to measured SAR values. At frequencies above 3 GHz, the validity of tissue parameters ( $\epsilon$  and  $\sigma$ ) is restricted to ± 5%. The uncertainty is the RSS of the ConvF uncertainty for indicated target tissue parameters.

<sup>G</sup> Alpha/Depth are determined during calibration. SPEAG warrants that the remaining deviation due to the boundary effect after compensation is always less than ± 1% for frequencies below 3 GHz and below ± 2% for frequencies between 3-6 GHz at any distance larger than half the probe tip diameter from the boundary.

## DASY/EASY - Parameters of Probe: EX3DV4 - SN:3873

### Calibration Parameter Determined in Body Tissue Simulating Media

f (MHz) <sup>C</sup>	Relative Permittivity <sup>F</sup>	Conductivity (S/m) <sup>F</sup>	ConvF X	ConvF Y	ConvF Z	Alpha <sup>G</sup>	Depth <sup>G</sup> (mm)	Unc (k=2)
750	55.5	0.96	9.67	9.67	9.67	0.50	0.80	± 12.0 %
835	55.2	0.97	9.49	9.49	9.49	0.37	0.96	± 12.0 %
1750	53.4	1.49	7.80	7.80	7.80	0.33	0.93	± 12.0 %
1900	53.3	1.52	7.61	7.61	7.61	0.36	0.86	± 12.0 %
2300	52.9	1.81	7.52	7.52	7.52	0.40	0.88	± 12.0 %
2450	52.7	1.95	7.39	7.39	7.39	0.30	0.96	± 12.0 %
2600	52.5	2.16	7.28	7.28	7.28	0.20	1.08	± 12.0 %
5250	48.9	5.36	4.27	4.27	4.27	0.50	1.90	± 13.1 %
5600	48.5	5.77	3.77	3.77	3.77	0.50	1.90	± 13.1 %
5800	48.2	6.00	4.00	4.00	4.00	0.50	1.90	± 13.1 %

<sup>C</sup> Frequency validity above 300 MHz of ± 100 MHz only applies for DASY v4.4 and higher (see Page 2), else it is restricted to ± 50 MHz. The uncertainty is the RSS of the ConvF uncertainty at calibration frequency and the uncertainty for the indicated frequency band. Frequency validity below 300 MHz is ± 10, 25, 40, 50 and 70 MHz for ConvF assessments at 30, 64, 128, 150 and 220 MHz respectively. Above 5 GHz frequency validity can be extended to ± 110 MHz.

<sup>F</sup> At frequencies below 3 GHz, the validity of tissue parameters ( $\epsilon$  and  $\sigma$ ) can be relaxed to ± 10% if liquid compensation formula is applied to measured SAR values. At frequencies above 3 GHz, the validity of tissue parameters ( $\epsilon$  and  $\sigma$ ) is restricted to ± 5%. The uncertainty is the RSS of the ConvF uncertainty for indicated target tissue parameters.

<sup>G</sup> Alpha/Depth are determined during calibration. SPEAG warrants that the remaining deviation due to the boundary effect after compensation is always less than ± 1% for frequencies below 3 GHz and below ± 2% for frequencies between 3-6 GHz at any distance larger than half the probe tip diameter from the boundary.

# Frequency Response of E-Field

(TEM-Cell:ifi110 EXX, Waveguide: R22)

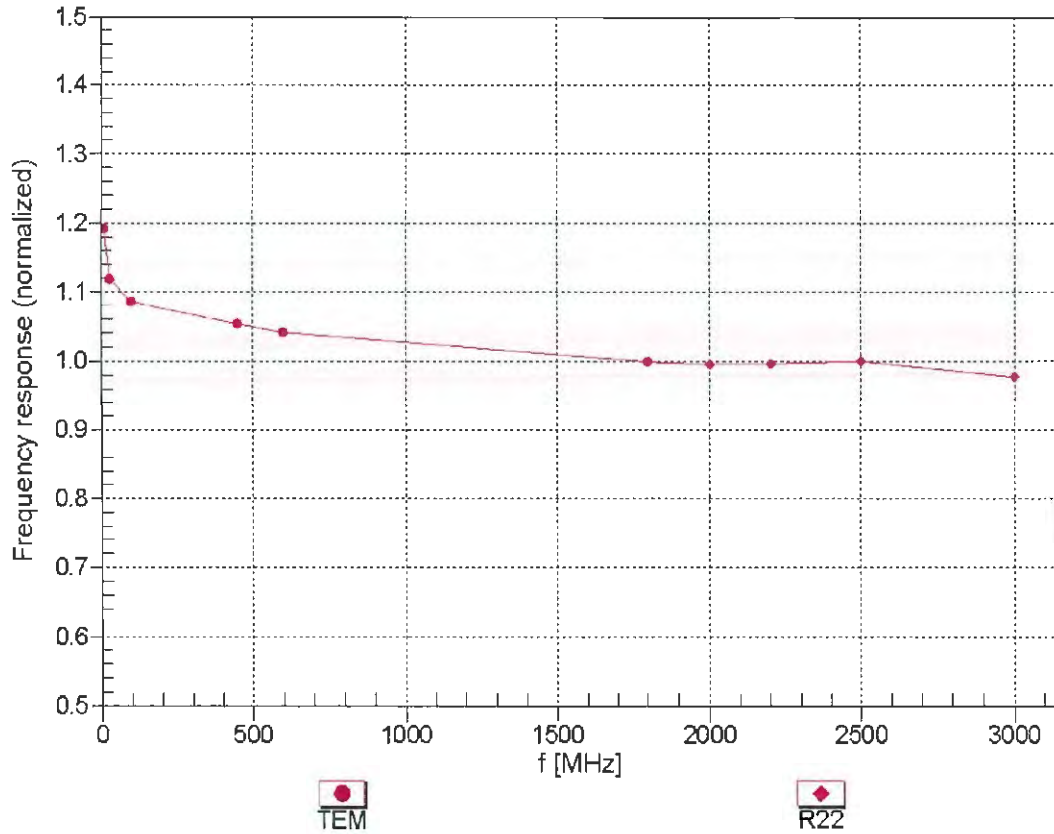

Uncertainty of Frequency Response of E-field:  $\pm 6.3\%$  (k=2)

### Receiving Pattern ( $\phi$ ), $\vartheta = 0^\circ$

f=600 MHz,TEM

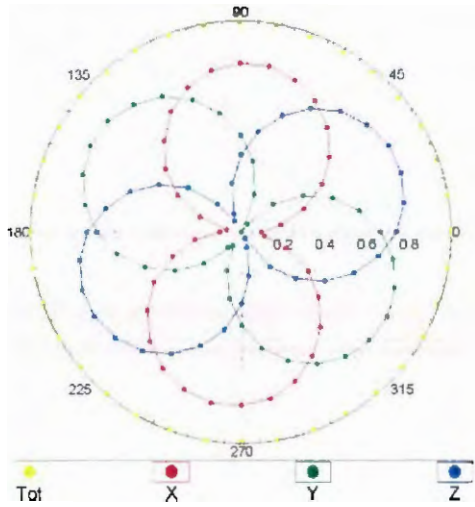

f=1800 MHz,R22

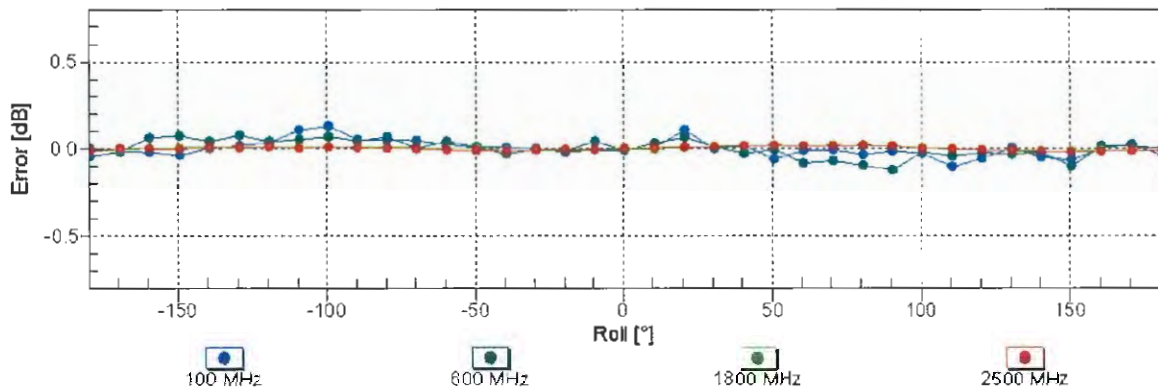
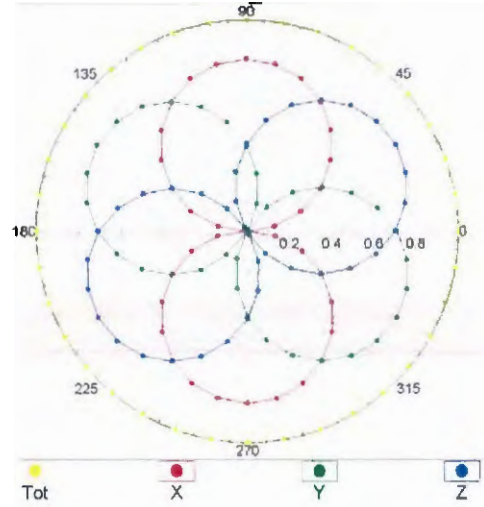

Uncertainty of Axial Isotropy Assessment:  $\pm 0.5\%$  (k=2)

## Dynamic Range $f(\text{SAR}_{\text{head}})$ (TEM cell, $f_{\text{eval}} = 1900 \text{ MHz}$ )

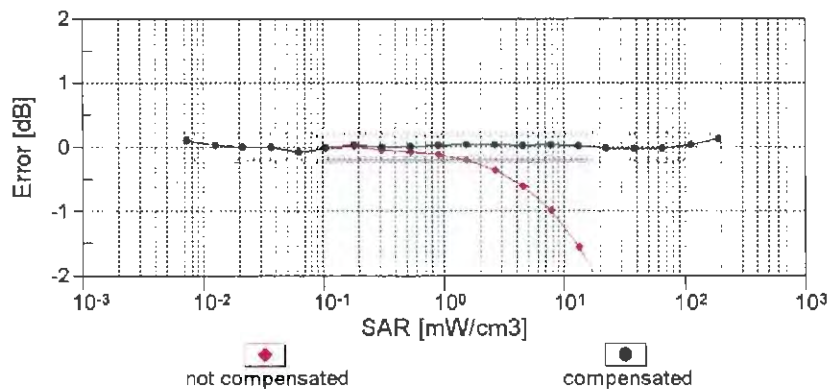
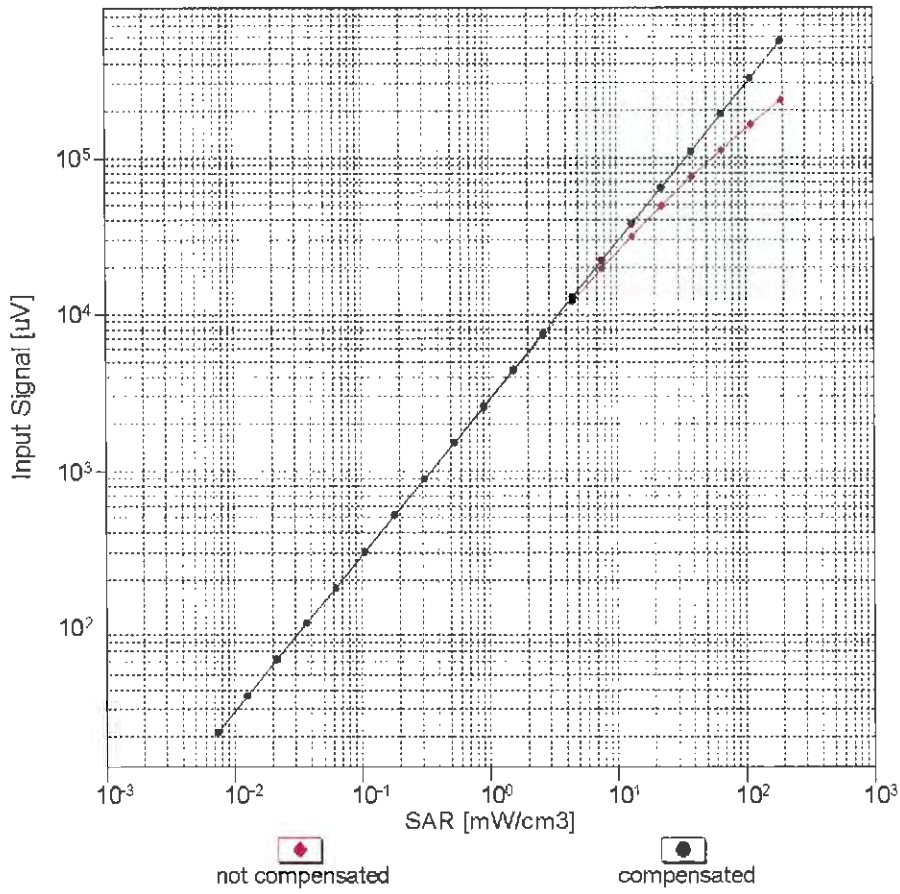

**Uncertainty of Linearity Assessment:  $\pm 0.6\%$  ( $k=2$ )**

# Conversion Factor Assessment

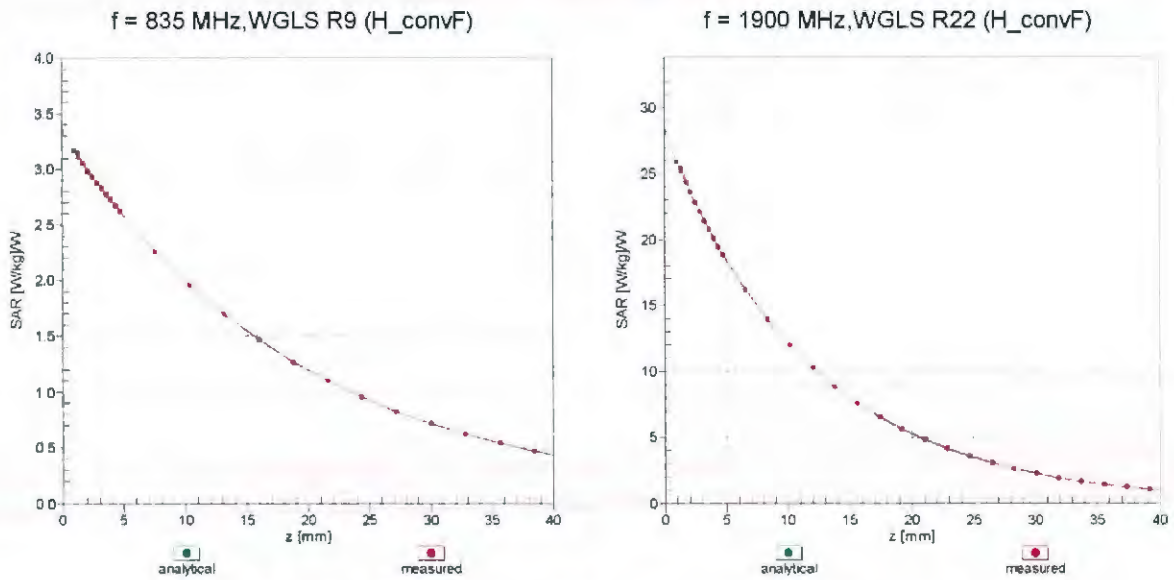

## Deviation from Isotropy in Liquid Error ( $\phi, \theta$ ), f = 900 MHz

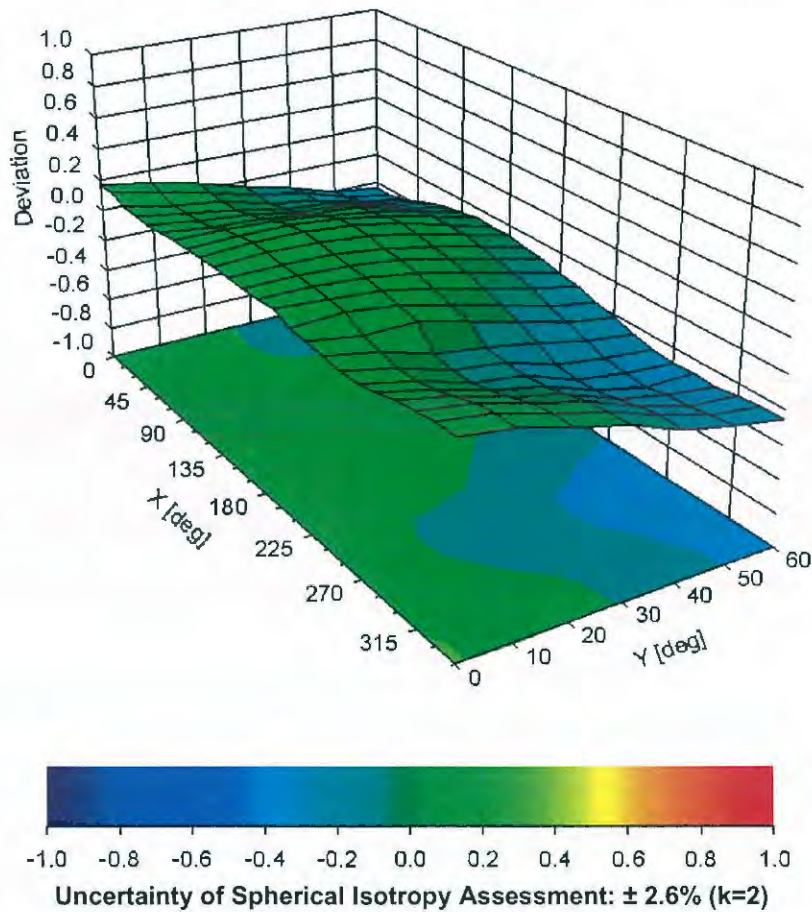

## DASY/EASY - Parameters of Probe: EX3DV4 - SN:3873

### Other Probe Parameters

Sensor Arrangement	Triangular
Connector Angle (°)	20.5
Mechanical Surface Detection Mode	enabled
Optical Surface Detection Mode	disabled
Probe Overall Length	337 mm
Probe Body Diameter	10 mm
Tip Length	9 mm
Tip Diameter	2.5 mm
Probe Tip to Sensor X Calibration Point	1 mm
Probe Tip to Sensor Y Calibration Point	1 mm
Probe Tip to Sensor Z Calibration Point	1 mm
Recommended Measurement Distance from Surface	1.4 mm





## Appendix D. Photographs of EUT and Setup