



TEST REPORT

Test Report No. : UL-RPT-RP12505086JD11A

Customer : Apple Inc.
Model No. : A2116
FCC ID : BCGA2116
Test Standard(s) : FCC Part 15.207

Test Laboratory : UL VS LTD, Basingstoke, Hampshire, RG24 8AH, United Kingdom

1. This test report shall not be reproduced in full or partial, without the written approval of UL VS LTD.
2. The results in this report apply only to the sample(s) tested.
3. This sample tested is in compliance with the above standard(s).
4. The test results in this report are traceable to the national or international standards.
5. Version 1.0.

Date of Issue: 16 January 2019

Checked by: 
Ian Watch
Senior Test Engineer, Radio Laboratory

Company Signatory: 
Sarah Williams
Senior Test Engineer, Radio Laboratory
UL VS LTD



UL VS LTD

Pavilion A, Ashwood Park, Ashwood Way, Basingstoke, Hampshire, RG23 8BG, UK
Telephone: +44 (0)1256 312000
Facsimile: +44 (0)1256 312001

Customer Information

Company Name:	Apple Inc.
Address:	One Apple Park Way Cupertino, California 95014 U.S.A.
Contact Name:	Stuart Thomas

Report Revision History

Version Number	Issue Date	Revision Details	Revised By
1.0	16/01/2019	Initial Version	Ian Watch

Table of Contents

Customer Information	2
Report Revision History	2
Table of Contents	3
1. Attestation of Test Results	4
1.1. Description of EUT	4
1.2. General Information	4
1.3. Summary of Test Results	4
1.4. Deviations from the Test Specification	4
2. Summary of Testing	5
2.1. Facilities and Accreditation	5
2.2. Methods and Procedures	5
2.3. Calibration and Uncertainty	5
2.4. Test and Measurement Equipment	6
3. Equipment Under Test (EUT)	7
3.1. Identification of Equipment Under Test (EUT)	7
3.2. Modifications Incorporated in the EUT	7
3.3. Additional Information Related to Testing	8
3.4. Description of Available Antennas	9
3.5. Description of Test Setup	9
4. AC Power Line Conducted Emissions Test Results	11
4.1. Transmitter AC Conducted Spurious Emissions	11

1. Attestation of Test Results

1.1. Description of EUT

The equipment under test was a desktop computer with WLAN and BT radios.

1.2. General Information

Specification Reference:	47CFR15.207
Specification Title:	Code of Federal Regulations Volume 47 (Telecommunications): Part 15 Subpart C (Intentional Radiators) - Section 15.207
Location of Testing:	UL VS Ltd, Unit 3 Horizon, Wade Road, Kingsland Business Park, Basingstoke, Hampshire, RG24 8AH, United Kingdom
Test Dates:	04 December 2018 to 17 December 2018

1.3. Summary of Test Results

FCC Reference (47CFR)	Measurement	Result
Part 15.207	Transmitter AC Conducted Emissions	Complied

Note(s):

1. There are two vendors of the *WiFi/Bluetooth* radio modules, Vendor 1 and Vendor 2.

The *WiFi/Bluetooth* radio modules have the same mechanical outline (i.e. the same packaging dimension and pin layout), use the same on-board antenna matching circuit, have an identical antenna structure and are built and tested to conform to the same specification and to operate within the same tolerances.

Baseline testing was performed on the two vendors to determine the worst case.

1.4. Deviations from the Test Specification

For the measurements contained within this test report, there were no deviations from, additions to, or exclusions from the test specification identified above.

2. Summary of Testing

2.1. Facilities and Accreditation

The test site and measurement facilities used to collect data are located at Unit 3 Horizon, Wade Road, Kingsland Business Park, Basingstoke, Hampshire, RG24 8AH, United Kingdom.

UL VS LTD is accredited by UKAS. The tests reported herein have been performed in accordance with its terms of accreditation.

2.2. Methods and Procedures

Reference:	ANSI C63.10-2013
Title:	American National Standard of Procedures for Compliance Testing of Unlicensed Wireless Devices
Reference:	KDB 174176 D01 Line Conducted FAQ v01r01 June 3, 2015
Title:	AC Power-Line Conducted Emissions Frequently Asked Questions

2.3. Calibration and Uncertainty

Measuring Instrument Calibration

In accordance with UKAS requirements all the measurement equipment is on a calibration schedule. All equipment was within the calibration period on the date of testing.

Measurement Uncertainty

No measurement or test can ever be perfect and the imperfections give rise to error of measurement in the results. Consequently the result of a measurement is only an approximation to the value measured (the specific quantity subject to measurement) and is only complete when accompanied by a statement of the uncertainty of the approximation.

The expression of uncertainty of a measurement result allows realistic comparison of results with reference values and limits given in specifications and standards.

The uncertainty of the result may need to be taken into account when interpreting the measurement results.

The reported expanded uncertainties below are based on a standard uncertainty multiplied by an appropriate coverage factor such that a confidence level of approximately 95% is maintained. For the purposes of this document "approximately" is interpreted as meaning "effectively" or "for most practical purposes".

Measurement Type	Range	Confidence Level (%)	Calculated Uncertainty
AC Conducted Spurious Emissions	0.15 MHz to 30 MHz	95%	±2.40 dB

The methods used to calculate the above uncertainties are in line with those recommended within the various measurement specifications. Where measurement specifications do not include guidelines for the evaluation of measurement uncertainty the published guidance of the appropriate accreditation body is followed.

2.4. Test and Measurement Equipment

Test Equipment Used for Transmitter AC Conducted Emissions

Asset No.	Instrument	Manufacturer	Type No.	Serial No.	Date Calibration Due	Cal. Interval (Months)
M2037	Thermohygrometer	Testo	608-H1	45124925	27 Mar 2019	12
A649	LISN	Rohde & Schwarz	ESH3-Z5	825562/008	23 Aug 2019	12
A1830	Pulse Limiter	Rohde & Schwarz	ESH3-Z2	100668	06 Apr 2019	12
M1124	Test Receiver	Rohde & Schwarz	ESIB26	100046	08 Aug 2019	12
M1269	Multimeter	Fluke	179	90250210	02 May 2019	12

Test Measurement Software/Firmware Used

Name	Version	Release Date
Rohde & Schwarz EMC32	6.30.0	2008

3. Equipment Under Test (EUT)

3.1. Identification of Equipment Under Test (EUT)

Brand Name:	Apple
Model Name or Number:	A2116
Test Sample Serial Number:	C02X200XKFLX (<i>Radiated Sample</i>)
Hardware Version:	EVT
Software Version:	18E110z
FCC ID:	BCGA2116

3.2. Modifications Incorporated in the EUT

No modifications were applied to the EUT during testing.

3.3. Additional Information Related to Testing

Technology Tested:	<i>Bluetooth</i>		
Type of Unit:	Transceiver		
Channel Spacing:	1 MHz		
Mode:	Basic Rate	Enhanced Data Rate	
Modulation:	GFSK	$\pi/4$ -DQPSK	8DPSK
Packet Type: (Maximum Payload)	DH5	2DH5	3DH5
Data Rate (Mbit/s):	1	2	3
Power Supply Requirement(s):	Nominal	120 VAC 60 Hz	
Transmit Frequency Range:	2402 MHz to 2480 MHz		
Transmit Channels Tested:	Channel ID	Channel Number	Channel Frequency (MHz)
	Top	78	2480

Technology Tested:	WLAN (IEEE 802.11b,g,n) / Digital Transmission System		
Type of Unit:	Transceiver		
Modulation Type:	BPSK		
Data Rates:	802.11n HT20	MCS0	
Power Supply Requirement(s):	Nominal	120 VAC 60 Hz	
Channel Spacing:	20 MHz		
Transmit Frequency Range:	2412 MHz to 2462 MHz		
Transmit Channels Tested:	Channel Number	Channel Frequency (MHz)	
	6	2437	

Technology Tested:	WLAN (IEEE 802.11a,n) / U-NII		
Type of Unit:	Transceiver		
Modulation:	BPSK		
Data rates:	802.11n HT40	MCS0 (1 spatial stream)	
Power Supply Requirement(s):	Nominal	120 VAC 60 Hz	
Channel Spacing:	20 MHz		
Transmit Frequency Band:	5470 MHz to 5725 MHz		
Transmit Channels Tested:	Channel ID	Channel Number	Channel Frequency (MHz)
	Middle	110	5550

3.4. Description of Available Antennas

The radio utilizes 4 integrated antennas, with the following maximum gains:

Frequency Band (MHz)	G_{Antenna Core 0} (dBi)	G_{Antenna Core 1} (dBi)	G_{Antenna Core 2} (dBi)
2400-2480 (BT)	3.3	-	-
2400-2480 (WLAN)	3.7	4.8	4.3
5150-5250	1.2	2.8	4.8
5250-5350	1.5	3.2	4.5
5470-5725	2.9	2.1	4.7
5725-5850	3.1	2.0	4.9

3.5. Description of Test Setup

Support Equipment

The following support equipment was used to exercise the EUT during testing:

Description:	PHF (Personal Hands Free)
Brand Name:	Apple
Model Name or Number:	Apple EarPods
Serial Number:	Not marked or stated

Description:	USB Mouse
Brand Name:	Apple
Model Name or Number:	A1152
Serial Number:	CC2446203PNDNYPAJ

Description:	USB Keyboard
Brand Name:	Apple
Model Name or Number:	A1243
Serial Number:	CC2438202G4DQW0AC

Description:	Ethernet Hub
Brand Name:	D-Link
Model Name or Number:	DGS-1005D
Serial Number:	DR8SB92000451

Description:	USB Memory Stick
Brand Name:	SanDisk
Model Name or Number:	Ultra
Serial Number:	Not marked or stated

Operating Modes

The EUT was tested in the following operating mode(s):

- Continuously transmitting at maximum power on the middle and top channels as required.
- The EUT was tested in the following operating mode(s): Pre-scans were performed with the EUT transmitting in *Bluetooth* BDR, *Bluetooth* LE, 2.4 GHz WLAN and 5.0 GHz WLAN modes. The worst case mode was found to be *Bluetooth* BDR, 2.4 GHz WLAN and 5.0 GHz WLAN transmitting simultaneously. Final measurements were performed in this configuration.
- The EUT was transmitting at full power while powered via the mains supply.

Configuration and Peripherals

The EUT was tested in the following configuration(s):

- Final measurements were performed with the EUT configured to simultaneously transmit two signals at maximum output power. The two modes were:
 - *Bluetooth* BDR: Channel 78 / 2480 MHz
 - WLAN SDB: 2.4 GHz (802.11n HT20 MIMO) / Channel 6 / 2437 MHz and 5 GHz (802.11n HT40 MIMO) / U-NII Band 2C / Channel 110 / 5550 MHz

Pre-scan plots for all other configurations are archived on UL VS LTD IT server and available for inspection if required.

- Controlled in test mode using a software application on the EUT supplied by the customer. The application was used to enable a continuous transmission and to select the test channels as required. The customer supplied a document containing the setup instructions 'EUT_scripts.zip'.
- The EUT was powered from a 120 VAC 60 Hz single phase mains supply unless otherwise stated.
- The USB ports were terminated into accessories and the Ethernet port was terminated into an Ethernet hub.

Test Setup Diagrams

Test Setup for Transmitter AC Conducted Emissions

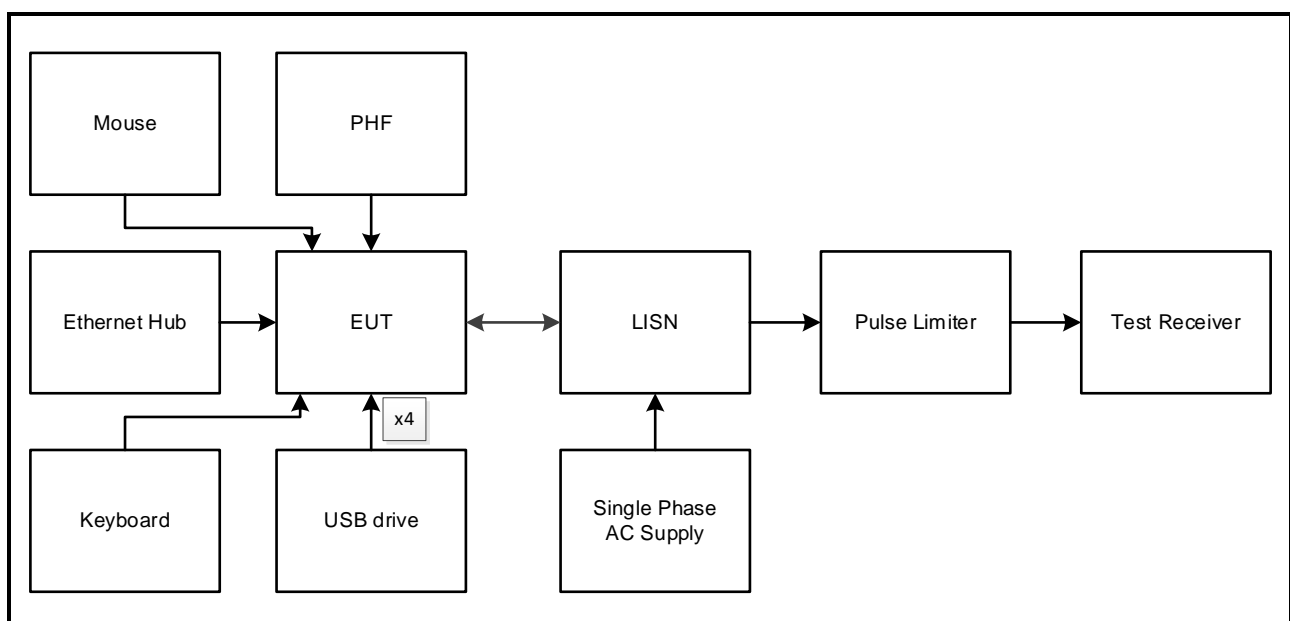

4. AC Power Line Conducted Emissions Test Results

4.1. Transmitter AC Conducted Spurious Emissions

Test Summary:

Test Engineers:	Stefan Ho, Mark Perry & Matthew Botfield	Test Dates:	04 December 2018 to 17 December 2018
Test Sample Serial Numbers:	C02X200XKFLX		

FCC Reference:	Part 15.207
Test Method Used:	ANSI C63.10 Section 6.2 / FCC KDB 174176 and notes below

Environmental Conditions:

Temperature (°C):	21 to 23
Relative Humidity (%):	40 to 46

Note(s):

1. The EUT was connected to the power supply input which was connected to a 120 VAC 60 Hz single phase supply via a LISN.
2. In accordance with FCC KDB 174176 Q4, tests were performed with a 240 VAC 60 Hz single phase supply as this was within the voltage range marked on the EUT power supply.
3. A pulse limiter was fitted between the LISN and the test receiver.
4. Pre-scans were performed with the EUT transmitting on the middle channel of *Bluetooth* BR, *Bluetooth* LE and WLAN modes. The worst case mode was found to be *Bluetooth* BR, SDB mode with 2.4 GHz WLAN and 5.0 GHz WLAN active simultaneously on the vendor 2 sample and final measurements were performed in this mode only. Pre-scan plots for all other modes are archived on the UL VS LTD IT server and available for inspection if required.

Transmitter AC Conducted Spurious Emissions (continued)**Results: Live / Quasi Peak / 120 VAC 60 Hz**

Frequency (MHz)	Line	Level (dB μ V)	Limit (dB μ V)	Margin (dB)	Result
0.150	Live	45.4	66.0	20.6	Complied
0.222	Live	46.0	62.7	16.7	Complied
0.371	Live	37.5	58.5	21.0	Complied
0.524	Live	32.5	56.0	23.5	Complied
4.376	Live	30.9	56.0	25.1	Complied
17.246	Live	37.7	60.0	22.3	Complied

Results: Live / Average / 120 VAC 60 Hz

Frequency (MHz)	Line	Level (dB μ V)	Limit (dB μ V)	Margin (dB)	Result
0.222	Live	44.8	52.7	7.9	Complied
0.371	Live	35.8	48.5	12.7	Complied
0.519	Live	28.5	46.0	17.5	Complied
0.668	Live	27.7	46.0	18.3	Complied
0.816	Live	22.7	46.0	23.3	Complied
17.250	Live	26.7	50.0	23.3	Complied

Results: Neutral / Quasi Peak / 120 VAC 60 Hz

Frequency (MHz)	Line	Level (dB μ V)	Limit (dB μ V)	Margin (dB)	Result
0.150	Neutral	45.7	66.0	20.3	Complied
0.222	Neutral	45.1	62.7	17.6	Complied
0.371	Neutral	36.0	58.5	22.5	Complied
0.524	Neutral	31.0	56.0	25.0	Complied
15.752	Neutral	34.5	60.0	25.5	Complied
17.250	Neutral	38.0	60.0	22.0	Complied

Results: Neutral / Average / 120 VAC 60 Hz

Frequency (MHz)	Line	Level (dB μ V)	Limit (dB μ V)	Margin (dB)	Result
0.222	Neutral	43.9	52.7	8.8	Complied
0.371	Neutral	34.5	48.5	14.0	Complied
0.519	Neutral	28.6	46.0	17.4	Complied
0.668	Neutral	23.3	46.0	22.7	Complied
0.821	Neutral	18.0	46.0	28.0	Complied
17.250	Neutral	27.2	50.0	22.8	Complied

Transmitter AC Conducted Spurious Emissions (continued)

Results: 120 VAC 60 Hz

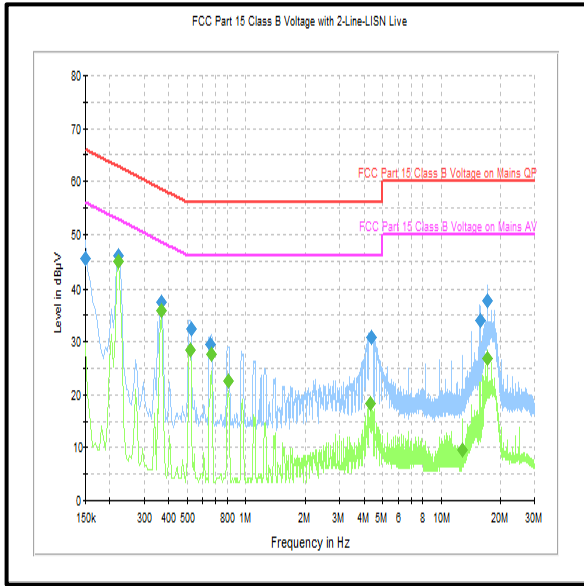

Live

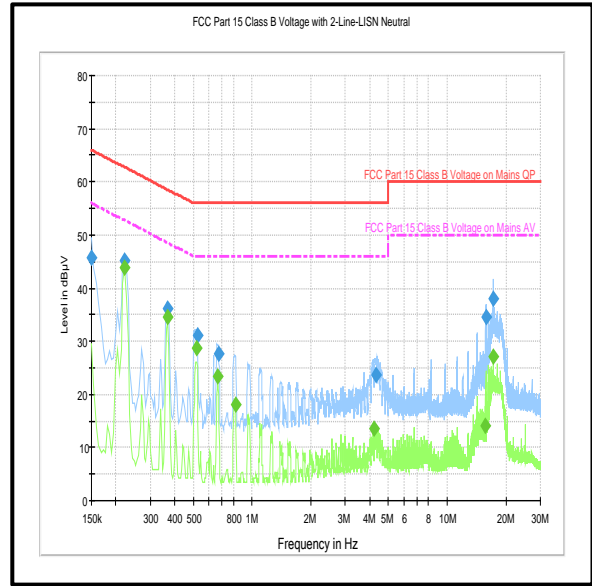

Neutral

Note: These plots are pre-scans and for indication purposes only. For final measurements, see accompanying tables.

Transmitter AC Conducted Spurious Emissions (continued)**Results: Live / Quasi Peak / 240 VAC 60 Hz**

Frequency (MHz)	Line	Level (dB μ V)	Limit (dB μ V)	Margin (dB)	Result
0.150	Live	49.2	66.0	16.8	Complied
0.222	Live	46.4	62.7	16.3	Complied
0.371	Live	37.5	58.5	21.0	Complied
0.519	Live	32.9	56.0	23.1	Complied
15.765	Live	30.5	60.0	29.5	Complied
17.259	Live	37.0	60.0	23.0	Complied

Results: Live / Average / 240 VAC 60 Hz

Frequency (MHz)	Line	Level (dB μ V)	Limit (dB μ V)	Margin (dB)	Result
0.150	Live	35.6	56.0	20.4	Complied
0.222	Live	45.2	52.7	7.5	Complied
0.371	Live	36.0	48.5	12.5	Complied
0.519	Live	29.5	46.0	16.5	Complied
15.761	Live	20.7	50.0	29.3	Complied
17.264	Live	27.1	50.0	22.9	Complied

Results: Neutral / Quasi Peak / 240 VAC 60 Hz

Frequency (MHz)	Line	Level (dB μ V)	Limit (dB μ V)	Margin (dB)	Result
0.150	Neutral	49.0	66.0	17.0	Complied
0.222	Neutral	45.4	62.7	17.3	Complied
0.366	Neutral	36.3	58.6	22.3	Complied
0.519	Neutral	30.8	56.0	25.2	Complied
15.765	Neutral	33.8	60.0	26.2	Complied
17.264	Neutral	37.7	60.0	22.3	Complied

Results: Neutral / Average / 240 VAC 60 Hz

Frequency (MHz)	Line	Level (dB μ V)	Limit (dB μ V)	Margin (dB)	Result
0.150	Neutral	34.9	56.0	21.1	Complied
0.222	Neutral	44.1	52.7	8.6	Complied
0.371	Neutral	34.3	48.5	14.2	Complied
0.519	Neutral	26.5	46.0	19.5	Complied
15.765	Neutral	26.2	50.0	23.8	Complied
17.264	Neutral	27.8	50.0	22.2	Complied

Transmitter AC Conducted Spurious Emissions (continued)

Results: 240 VAC 60 Hz

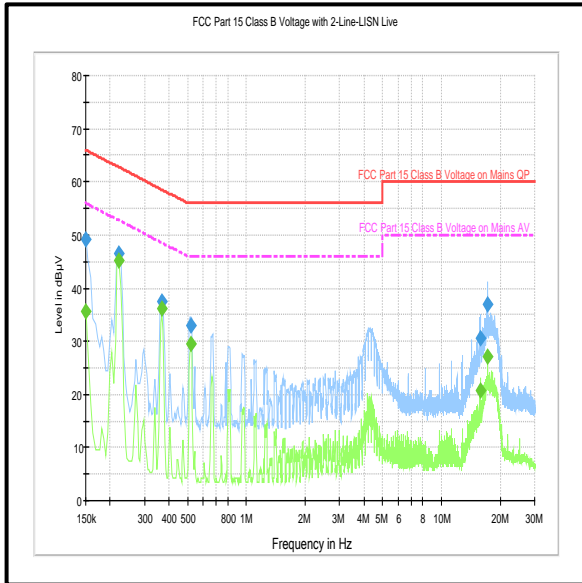

Live

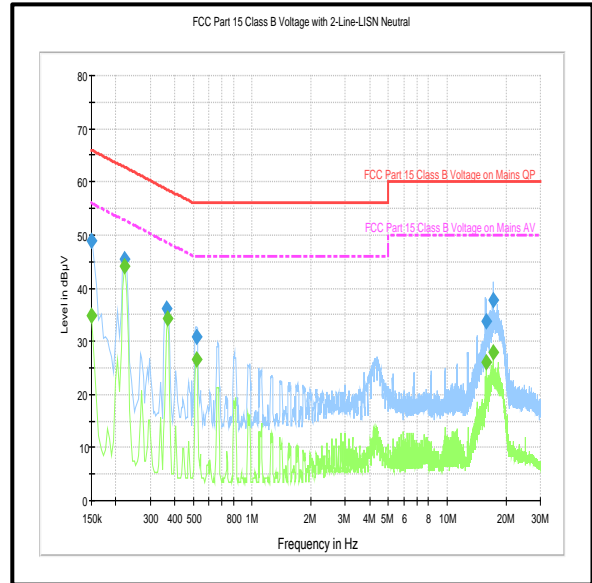

Neutral

Note: These plots are pre-scans and for indication purposes only. For final measurements, see accompanying tables.

--- END OF REPORT ---