

FCC TEST REPORT
for
Anker Technology Co., Limited

PowerTouch 10
Model No.: A2512

Prepared for : Anker Technology Co., Limited
Address : Room 1318-19, Hollywood Plaza, 610 Nathan Road, Mongkok,
Kowloon, Hong Kong

Prepared By : Shenzhen Anbotek Compliance Laboratory Limited
Address : 1/F., Building 1, SEC Industrial Park, No.0409 Qianhai Road,
Nanshan District, Shenzhen, Guangdong, China
Tel: (86) 755-26066544
Fax: (86) 755-26014772

Report Number : R011610159Y
Date of Test : Oct. 11~ Nov. 07, 2016
Date of Report : Nov. 08, 2016

TABLE OF CONTENT

Description

Page

Test Report

1. GENERAL INFORMATION.....	4
1.1. Description of Device (EUT).....	4
1.2. Auxiliary Equipment Used during Test.....	5
1.3. Description of Test Facility.....	5
1.4. Measurement Uncertainty.....	5
2. TEST METHODOLOGY.....	6
2.1. Summary of Test Results.....	6
3. CONDUCTED EMISSION TEST.....	7
3.1. Block Diagram of Test Setup.....	7
3.2. Power Line Conducted Emission Measurement Limits (15.207).....	7
3.3. Configuration of EUT on Measurement.....	7
3.4. Operating Condition of EUT.....	7
3.5. Test Procedure.....	8
3.6. Test equipment.....	8
3.7. Power Line Conducted Emission Measurement Results.....	8
4. RADIATED EMISSIONS.....	13
4.6.1.1. Test Limits (< 30 MHZ).....	13
4.6.1.2. Test Limits (≥ 30 MHz).....	13
4.6.2. Test Configuration:.....	15
4.6.3. Test Procedure.....	16
4.6.4. Test Results.....	17
6. PHOTOGRAPH.....	21
6.1 Photo of Conducted Emission Test.....	21
6.2 Photo of Radiation Emission Test.....	22
APPENDIX I (EXTERNAL PHOTOS).....	23
APPENDIX II (INTERNAL PHOTOS).....	26

TEST REPORT

Applicant : Anker Technology Co., Limited
Manufacturer : Anker Technology Co., Limited
EUT : PowerTouch 10
Model No. : A2512
Serial No. : N.A.
Trade Mark : **ANKER**
Rating : Input DC 5V, 2A, Output DC 9V, 0.5A

Measurement Procedure Used:
FCC Part15 Subpart C 2016, Paragraph 15.209

The device described above is tested by Shenzhen Anbotek Compliance Laboratory Limited to determine the maximum emission levels emanating from the device and the severe levels of the device can endure and its performance criterion. The measurement results are contained in this test report and Shenzhen Anbotek Compliance Laboratory Limited is assumed full of responsibility for the accuracy and completeness of these measurements. Also, this report shows that the EUT (Equipment Under Test) is technically compliant with the FCC Part 15 Subpart C requirements.

This report applies to above tested sample only and shall not be reproduced in part without written approval of Shenzhen Anbotek Compliance Laboratory Limited.

Date of Test : Oct. 11~ Nov. 07, 2016

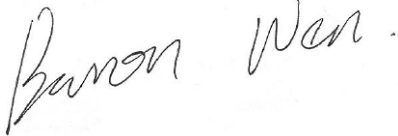
Prepared by : 
(Tested Engineer / Baron Wen)

Reviewer : 
(Project Manager / Amy Ding)

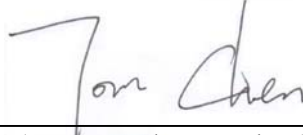
Approved & Authorized Signer : 
(Manager / Tom Chen)

1. GENERAL INFORMATION

1.1. Description of Device (EUT)

EUT : PowerTouch 10

Model Number : A2512

Test Power Supply : DC 5V

Frequency : 110~ 205kHz

Antenna Type : Loop Antenna

Antenna Gain : 2dBi

Applicant : Anker Technology Co., Limited

Address : Room 1318-19, Hollywood Plaza, 610 Nathan Road, Mongkok,
Kowloon, Hong Kong

Manufacturer : Anker Technology Co., Limited

Address : Room 1318-19, Hollywood Plaza, 610 Nathan Road, Mongkok,
Kowloon, Hong Kong

Factory : SHENZHEN RUIJING INDUSTRIAL CO., LTD.

Address : 5-6 Floor, Building 3, Minqi Industrial Area, Lishan Road, Nanshan
Shenzhen, Guangdong, 518055 China

Date of receiver : Oct. 11, 2016

Date of Test : Oct. 11~ Nov. 07, 2016

1.2. Auxiliary Equipment Used during Test

Adapter : Model No.: ETA-U90CBC
Manufacturer: SAMSUNG
Input: AC 100-240V, 50-60Hz, 0.35A
Output: DC 5V, 2A

Mobile Phone : Model No.: GALAXY S7 Edge G9350
Manufacturer: SAMSUNG

1.3. Description of Test Facility

The test facility is recognized, certified, or accredited by the following organizations:

FCC-Registration No.: 752021

Shenzhen Anbotek Compliance Laboratory Limited, EMC Laboratory has been registered and fully described in a report filed with the (FCC) Federal Communications Commission. The acceptance letter from the FCC is maintained in our files. Registration 752021, July 06, 2016.

IC-Registration No.: 8058A-1

Shenzhen Anbotek Compliance Laboratory Limited., EMC Laboratory has been registered and fully described in a report filed with the (IC) Industry Canada. The acceptance letter from the IC is maintained in our files. Registration 8058A, Jun. 13, 2016.

Test Location

All Emissions tests were performed at
Shenzhen Anbotek Compliance Laboratory Limited. at 1/F., Building 1, SEC
Industrial Park, No.0409 Qianhai Road, Nanshan District, Shenzhen, Guangdong,
China

1.4. Measurement Uncertainty

Radiation Uncertainty : Ur = 4.1 dB (Horizontal)
Ur = 4.3 dB (Vertical)

Conduction Uncertainty : Uc = 3.4dB

2. TEST METHODOLOGY

The tests documented in this report were performed in accordance with ANSI C63.10: 2013 and FCC Part 15, Paragraph 15.209.

2.1. Summary of Test Results

The EUT has been tested according to the following specifications:

Standard	Test Type	Result	Notes
FCC Part 15, Paragraph 15.107, 15.207	Conducted Emission Test	PASS	Complies
FCC Part 15, Paragraph 15.209(a)(f)	Spurious Emission	PASS	Complies

3. Conducted Emission Test

3.1. Block Diagram of Test Setup

3.1.1. Block diagram of connection between the EUT and simulators

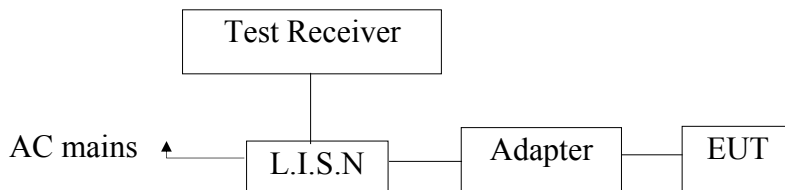

3.2. Power Line Conducted Emission Measurement Limits (15.207)

Frequency MHz	Limits dB(μV)	
	Quasi-peak Level	Average Level
0.15 ~ 0.50	66 ~ 56*	56 ~ 46*
0.50 ~ 5.00	56	46
5.00 ~ 30.00	60	50

- Notes: 1. *Decreasing linearly with logarithm of frequency.
2. The lower limit shall apply at the transition frequencies.

3.3. Configuration of EUT on Measurement

The following equipments are installed on Power Line Conducted Emission Measurement to meet the commission requirement and operating regulations in a manner which tends to maximize its emission characteristics in a normal application.

3.4. Operating Condition of EUT

- 3.4.1. Setup the EUT and simulator as shown as Section 3.1.
- 3.4.2. Turn on the power of all equipment.
- 3.4.3. Let the EUT work in test mode (Charging) and measure it.

3.5. Test Procedure

The EUT system is connected to the power mains through a line impedance stabilization network (L.I.S.N.). This provides a 50ohm coupling impedance for the EUT system. Please refer the block diagram of the test setup and photographs. Both sides of AC line are checked to find out the maximum conducted emission. In order to find the maximum emission levels, the relative positions of equipment and all of the interface cables shall be changed according to FCC ANSI C63.10-2013 on Conducted Emission Measurement.

The bandwidth of test receiver (ESCI) set at 9KHz.

The frequency range from 150KHz to 30MHz is checked.

The test results are reported on Section 3.7.

3.6. Test equipment

Item	Equipment	Manufacturer	Model No.	Serial No.	Last Cal.	Cal. Interval
1.	Two-Line V-network	Rohde & Schwarz	ENV216	100055	Apr. 17, 2016	1 Year
2.	EMI Test Receiver	Rohde & Schwarz	ESCI	100627	Apr. 17, 2016	1 Year
3.	RF Switching Unit	Compliance Direction	RSU-M2	38303	Apr. 17, 2016	1 Year

3.7. Power Line Conducted Emission Measurement Results

PASS.

The frequency range from 150KHz to 30 MHz is investigated.

Please refer the following pages.

CONDUCTED EMISSION TEST DATA

Test Site: 1# Shielded Room
 Operating Condition: Charging
 Test Specification: AC 120V, 60Hz for adapter
 Comment: Live Line
 Tem.:24°C Hum.:49%

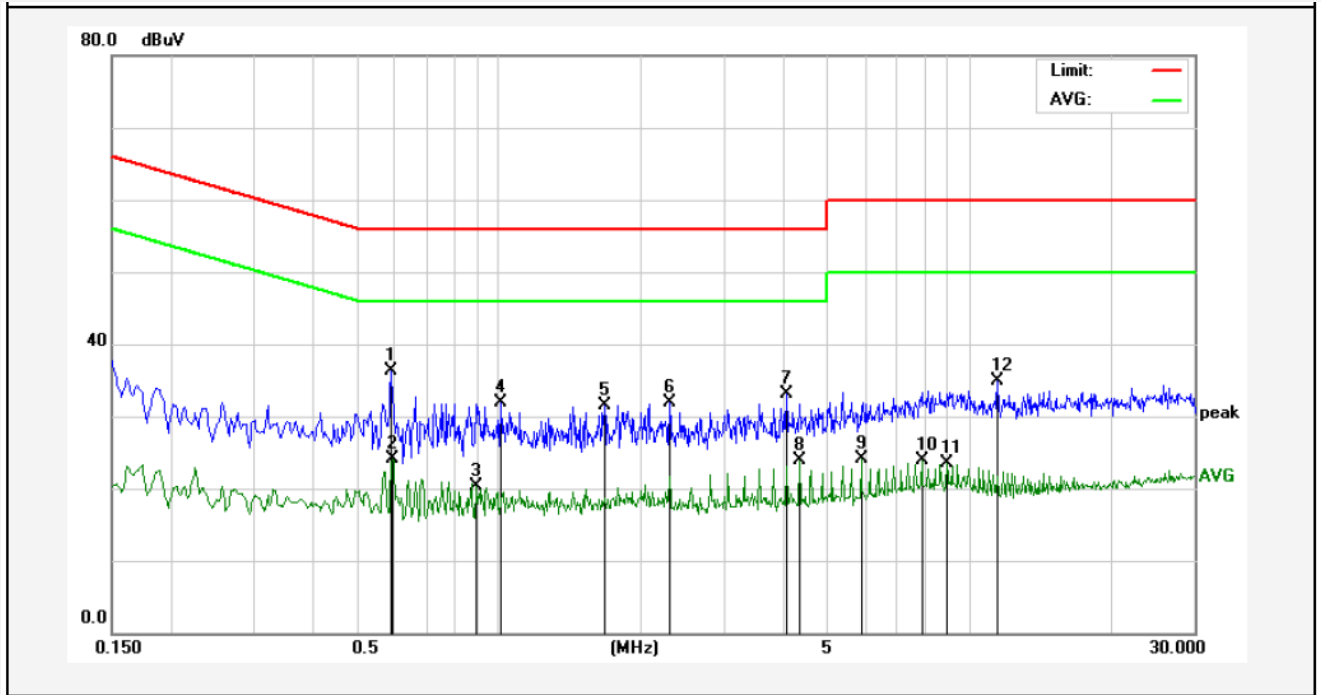

No.	Freq. (MHz)	Reading (dBuV)	Factor (dB)	Result (dBuV)	Limit dBuV	Over Limit (dB)	Detector	Remark
1	0.5899	16.20	20.01	36.21	56.00	-19.79	QP	
2	0.5940	4.04	20.01	24.05	46.00	-21.95	AVG	
3	0.8980	0.31	20.09	20.40	46.00	-25.60	AVG	
4	1.0060	11.72	20.12	31.84	56.00	-24.16	QP	
5	1.6740	11.33	20.13	31.46	56.00	-24.54	QP	
6	2.2980	11.69	20.15	31.84	56.00	-24.16	QP	
7	4.0860	13.01	20.18	33.19	56.00	-22.81	QP	
8	4.3420	3.65	20.19	23.84	46.00	-22.16	AVG	
9	5.8740	3.86	20.23	24.09	50.00	-25.91	AVG	
10	7.9140	3.56	20.28	23.84	50.00	-26.16	AVG	
11	8.9379	3.21	20.31	23.52	50.00	-26.48	AVG	
12	11.4940	14.56	20.32	34.88	60.00	-25.12	QP	

CONDUCTED EMISSION TEST DATA

Test Site: 1# Shielded Room
 Operating Condition: Charging
 Test Specification: AC 120V, 60Hz for adapter
 Comment: Neutral Line
 Tem.:24°C Hum.:49%

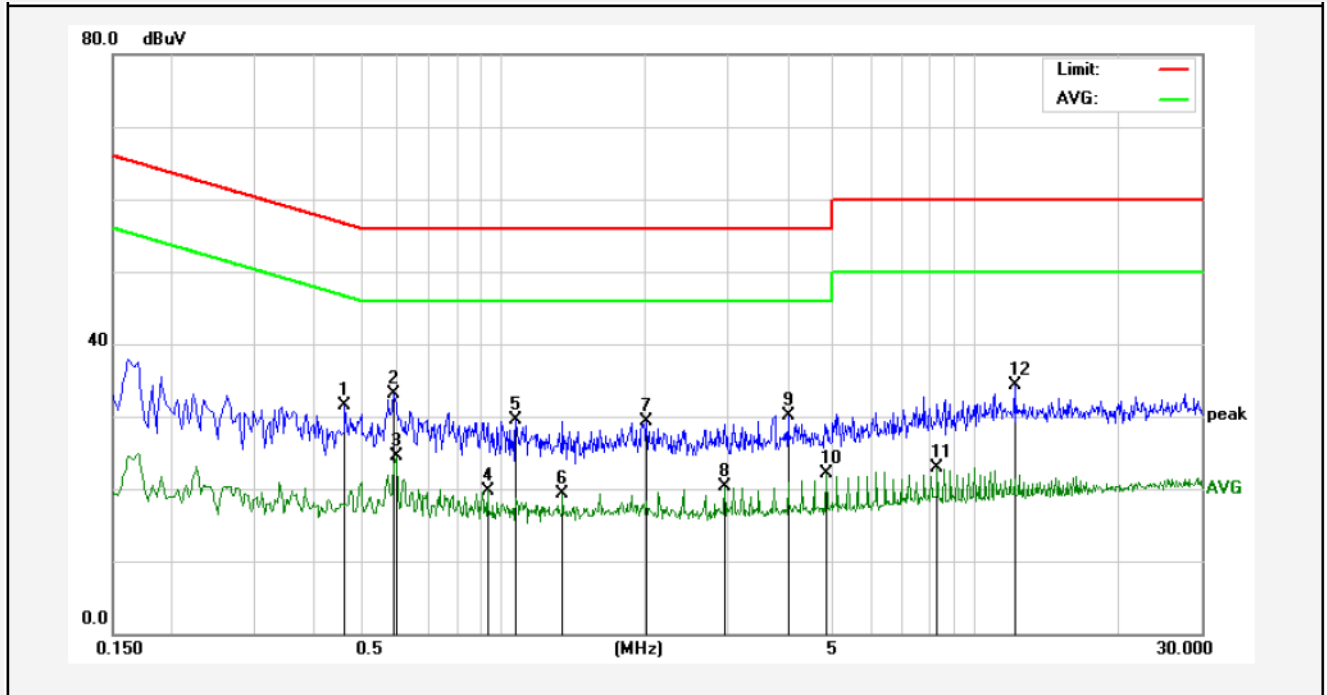

No.	Freq. (MHz)	Reading (dBuV)	Factor (dB)	Result (dBuV)	Limit dBuV	Over Limit (dB)	Detector	Remark
1	0.4660	11.52	19.96	31.48	56.58	-25.10	QP	
2	0.5899	13.13	20.01	33.14	56.00	-22.86	QP	
3	0.5980	4.53	20.01	24.54	46.00	-21.46	AVG	
4	0.9300	-0.30	20.10	19.80	46.00	-26.20	AVG	
5	1.0700	9.32	20.12	29.44	56.00	-26.56	QP	
6	1.3420	-0.80	20.13	19.33	46.00	-26.67	AVG	
7	2.0140	9.19	20.14	29.33	56.00	-26.67	QP	
8	2.9500	0.05	20.16	20.21	46.00	-25.79	AVG	
9	4.0260	9.88	20.18	30.06	56.00	-25.94	QP	
10	4.8300	1.93	20.20	22.13	46.00	-23.87	AVG	
11	8.3220	2.65	20.30	22.95	50.00	-27.05	AVG	
12	12.0780	13.96	20.31	34.27	60.00	-25.73	QP	

CONDUCTED EMISSION TEST DATA

Test Site: 1# Shielded Room
 Operating Condition: Charging
 Test Specification: AC 240V, 60Hz for adapter
 Comment: Live Line
 Tem.:24°C Hum.:49%

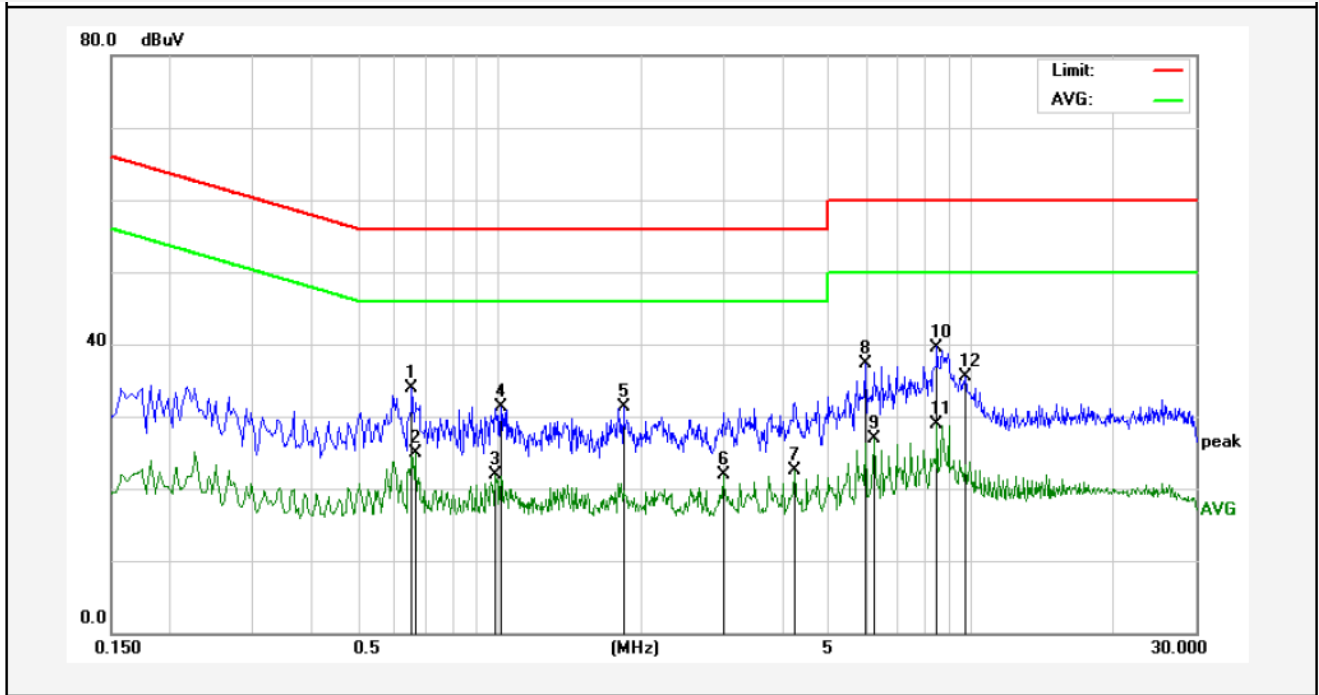

No.	Freq. (MHz)	Reading (dBuV)	Factor (dB)	Result (dBuV)	Limit dBuV	Over Limit (dB)	Detector	Remark
1	0.6540	13.94	20.03	33.97	56.00	-22.03	QP	
2	0.6620	4.85	20.03	24.88	46.00	-21.12	AVG	
3	0.9820	1.69	20.12	21.81	46.00	-24.19	AVG	
4	1.0060	11.13	20.12	31.25	56.00	-24.75	QP	
5	1.8340	11.20	20.14	31.34	56.00	-24.66	QP	
6	2.9900	1.84	20.16	22.00	46.00	-24.00	AVG	
7	4.2340	2.31	20.19	22.50	46.00	-23.50	AVG	
8	5.9780	17.13	20.23	37.36	60.00	-22.64	QP	
9	6.2300	6.63	20.24	26.87	50.00	-23.13	AVG	
10	8.4700	19.30	20.30	39.60	60.00	-20.40	QP	
11	8.4700	8.52	20.30	28.82	50.00	-21.18	AVG	
12	9.7180	15.15	20.33	35.48	60.00	-24.52	QP	

CONDUCTED EMISSION TEST DATA

Test Site: 1# Shielded Room
 Operating Condition: Charging
 Test Specification: AC 240V, 60Hz for adapter
 Comment: Neutral Line
 Tem.:24°C Hum.:49%

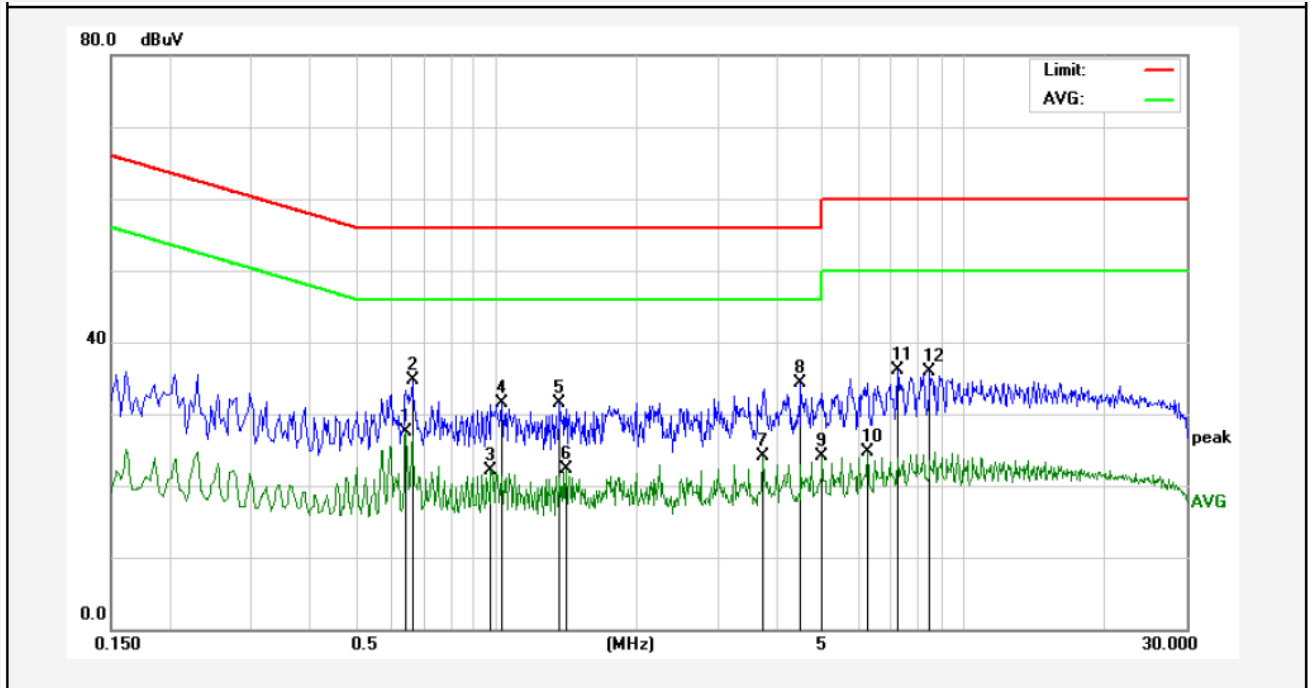

No.	Freq. (MHz)	Reading (dBuV)	Factor (dB)	Result (dBuV)	Limit dBuV	Over Limit (dB)	Detector	Remark
1	0.6419	7.40	20.02	27.42	46.00	-18.58	AVG	
2	0.6620	14.60	20.03	34.63	56.00	-21.37	QP	
3	0.9780	1.92	20.11	22.03	46.00	-23.97	AVG	
4	1.0300	11.40	20.12	31.52	56.00	-24.48	QP	
5	1.3700	11.40	20.13	31.53	56.00	-24.47	QP	
6	1.4140	2.22	20.13	22.35	46.00	-23.65	AVG	
7	3.7380	3.98	20.17	24.15	46.00	-21.85	AVG	
8	4.4820	14.02	20.19	34.21	56.00	-21.79	QP	
9	4.9820	3.84	20.21	24.05	46.00	-21.95	AVG	
10	6.2260	4.53	20.24	24.77	50.00	-25.23	AVG	
11	7.2260	15.76	20.27	36.03	60.00	-23.97	QP	
12	8.4700	15.69	20.30	35.99	60.00	-24.01	QP	

4. RADIATED EMISSIONS

4.6.1.1. Test Limits (< 30 MHz)

Frequency (MHz)	Field Strength (microvolts/meter)	Measurement Distance (meter)
0.009-0.490	2400/F(kHz)	300
0.490-1.705	24000/F(kHz)	30
1.705-30.0	30	30

4.6.1.2. Test Limits (≥ 30 MHz)

FIELD STRENGTH of Fundamental: @3M	FIELD STRENGTH of Harmonics	S15.209	
902-928 MHz		30 - 88 MHz	40 dBuV/m
2.4-2.4835 GHz		88 - 216 MHz	43.5
94 dBμV/m @3m	54 dBμV/m @3m	216 - 960 MHz	46
		ABOVE 960 MHz	54dBuV/m

In any 100 kHz bandwidth outside the frequency band in which the spread spectrum or digitally modulated intentional radiator is operating, the radio frequency power that is produced by the intentional radiator shall be at least 20 dB below that in the 100 kHz bandwidth within the band that contains the highest level of the desired power, based on either an RF conducted or a radiated measurement. Attenuation below the general limits specified in Section 15.209(a) is not required. In addition, radiated emissions which fall in the restricted bands, as defined in Section 15.205(a), must also comply with the radiated emission limits specified in Section 15.209(a) (see Section 15.205(c)).

Test Equipment

Item	Equipment	Manufacturer	Model No.	Serial No.	Last Cal.	Cal. Interval
1.	Spectrum Analysis	Agilent	E4407B	US39390582	Apr. 17, 2016	1 Year
2.	Preamplifier	Instruments corporation	EMC011830	980100	Apr. 17, 2016	1 Year
3.	EMI Test Receiver	Rohde & Schwarz	ESPI	101604	Apr. 17, 2016	1 Year
4.	Loop antenna	Schwarzbeck	FMZB 1516	452456	Apr. 20, 2016	1 Year
5.	Bilog Broadband Antenna	Schwarzbeck	VULB9163	VULB 9163-289	Apr. 20, 2016	1 Year
6.	Pre-amplifier	SONOMA	310N	186860	Apr. 17, 2016	1 Year
7.	EMI Test Software EZ-EMC	SHURPLE	N/A	N/A	N/A	N/A
8	Power Sensor	DAER	RPR3006W	15I00041SN046	Jun 30, 2016	1 Year
9	MXA Spectrum Analysis	Agilent	N9020A	MY51170037	Jun 30, 2016	1 Year
10	MXG RF Vector Signal Generator	Agilent	N5182A	MY48180656	Jun 30, 2016	1 Year
11	Signal Generator	Agilent	E4421B	MY41000743	Jun 30, 2016	1 Year
12	DC Power supply	IV	IV-8080	YQSB0096	Jun 30, 2016	1 Year
13	TEMP&HUMI PROGRAMMABLE CHAMBER	Bell Group	BE-THK-150M8	SE-0137	Mar 16, 2016	1 Year

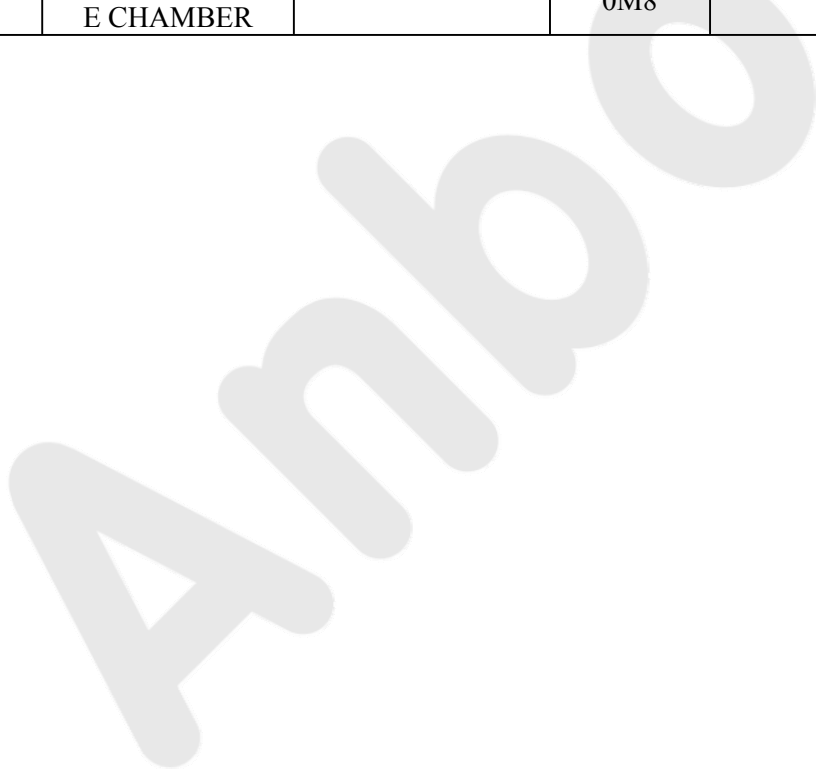

4.6.2. Test Configuration:

4.6.2.1. 9k to 30MHz emissions:

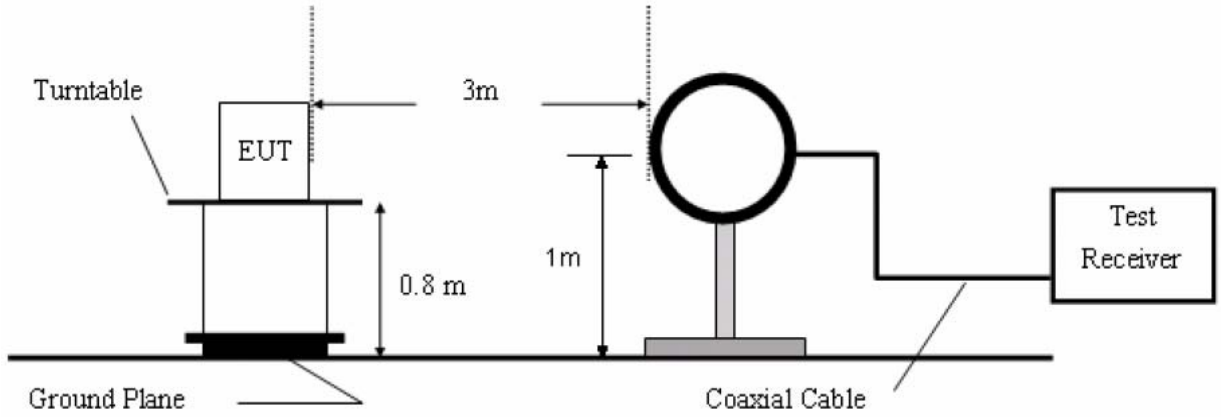

4.6.2.2. 30M to 1GHz emissions:

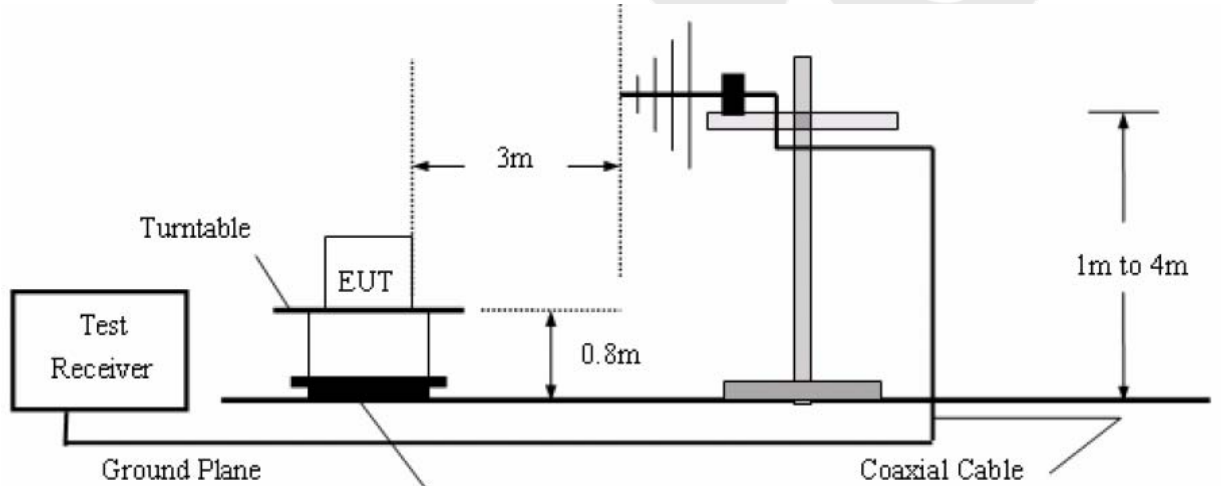

4.6.3. Test Procedure

For below 1GHz: The EUT is placed on a turntable, which is 0.8m above the ground plane. The turn table can rotate 360 degrees to determine the position of the maximum emission level. The EUT is set 3 meters away from the receiving antenna which is mounted on a antenna tower. The antenna can be moved up and down from 1 to 4 meters to find out the maximum emission level. Both horizontal and vertical polarization of the antenna are set on test.

All readings from 30MHz to 1GHz are quasi-peak values with a resolution bandwidth of 120kHz.

The EUT is tested in 9*6*6 Chamber. The device is evaluated in xyz orientation.

The test results are listed in Section 4.6.4.

Anbotek

4.6.4. Test Results

(Between 9KHz – 30 MHz)

Job No.:	011610159I	Plarization:	Horizontal
Standard:	FCC PART15 C _3m	Power Source:	AC 120V, 60Hz for adapter
Test item:	Radiation Test	Temp.(C)/Hum.(%RH):	24.4(C)/50%RH
Test Mode:	Charging	Distance:	3m

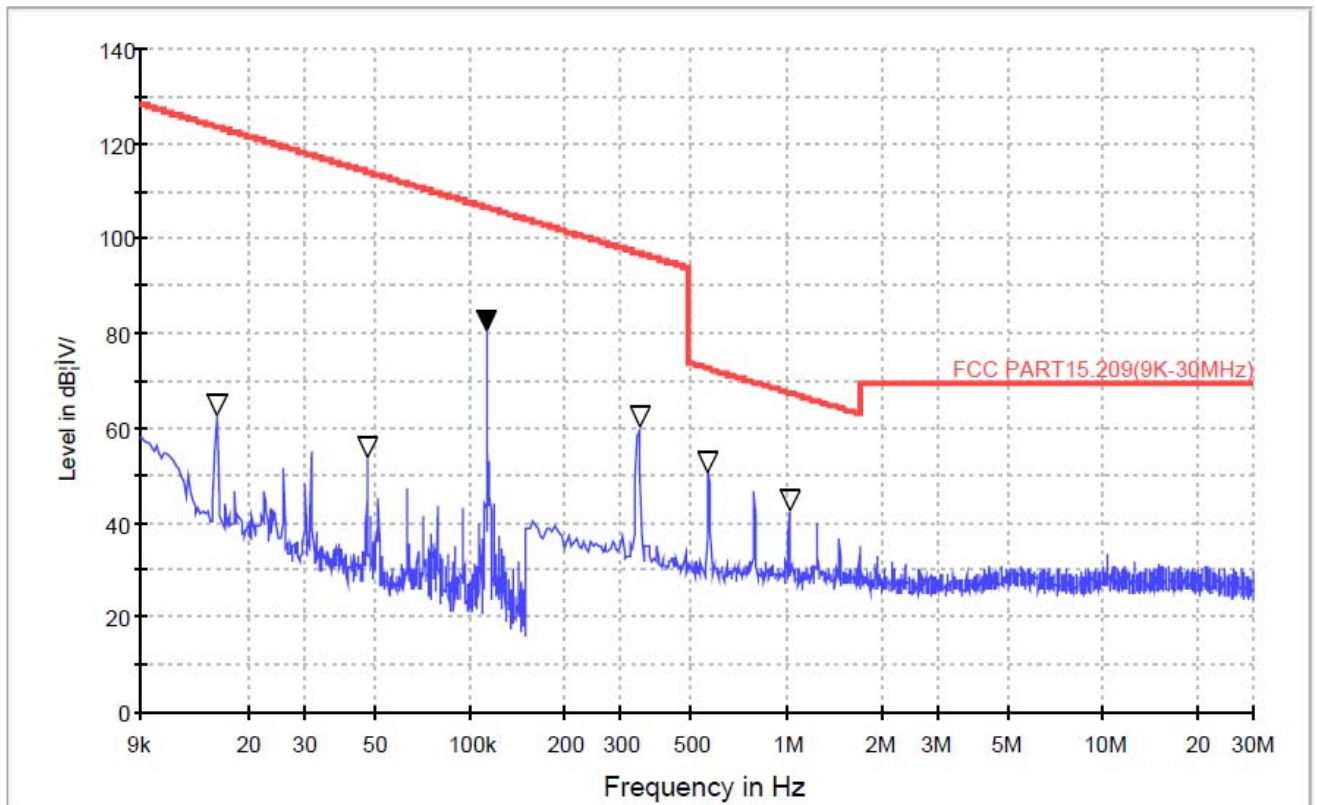

Frequency (MHz)	Read Level (dBuV)	Antenna Factor (dB/m)	Cable Loss (dB)	Preamp Factor (dB)	Level (dBuV/m)	Remark
0.0158	42.505	18.59	2.38	0	63.475	Pass
0.0483	33.385	18.67	2.39	0	54.445	Pass
0.1134	57.555	20.58	2.39	0	80.525	Pass
0.3420	35.235	21.53	2.76	0	59.525	Pass
0.5660	26.295	21.46	2.77	0	50.525	Pass
1.0530	17.695	22.87	2.86	0	43.425	Pass

Job No.:	011610159I	Plarization:	Vertical
Standard:	FCC PART15 C _3m	Power Source:	AC 120V, 60Hz for adapter
Test item:	Radiation Test	Temp.(C)/Hum.(%RH):	24.4(C)/50%RH
Test Mode:	Charging	Distance:	3m

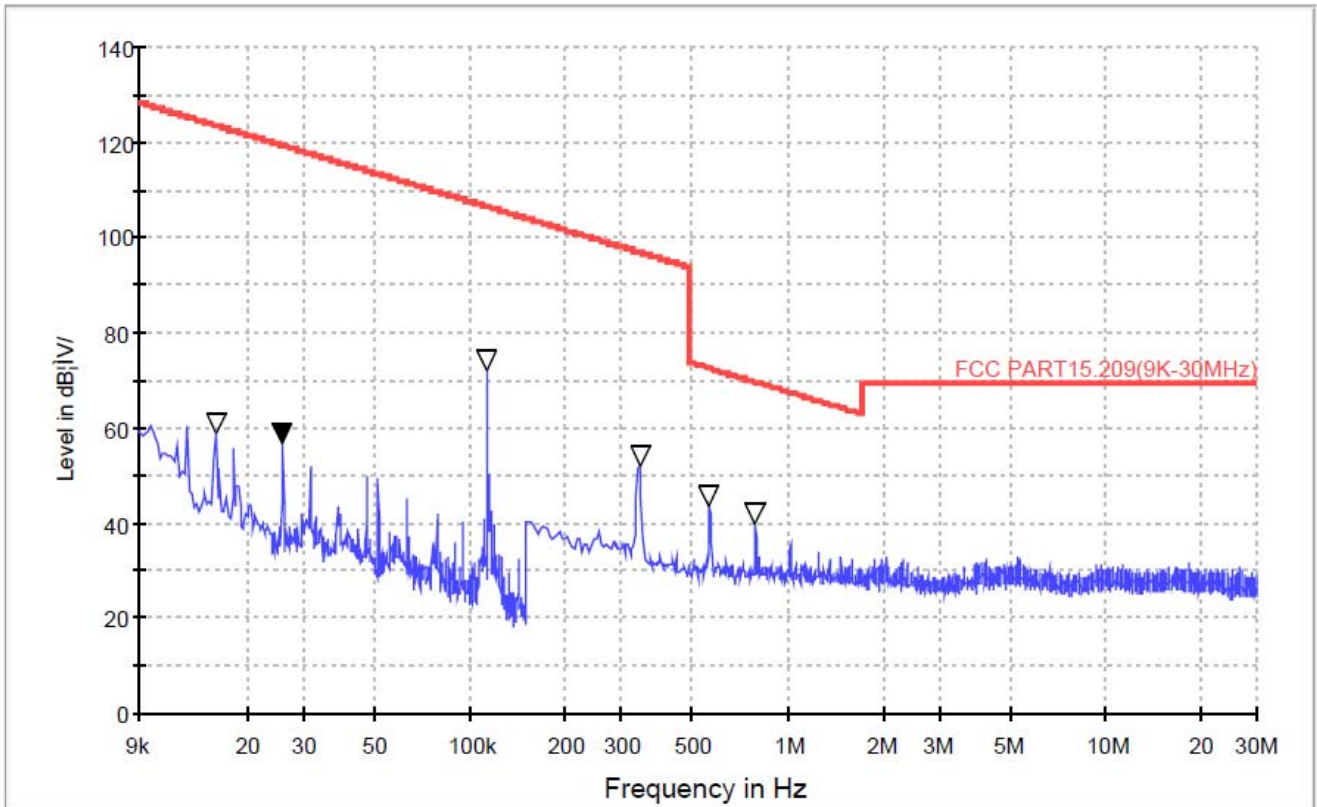

Frequency (MHz)	Read Level (dBuV)	Antenna Factor (dB/m)	Cable Loss (dB)	Preamp Factor (dB)	Level (dBuV/m)	Remark
0.0158	37.981	18.59	2.38	0	58.951	Pass
0.0256	35.596	18.67	2.39	0	56.656	Pass
0.1134	49.147	20.58	2.39	0	72.117	Pass
0.3420	27.787	21.53	2.76	0	52.077	Pass
0.5660	18.016	22.86	2.53	0	43.406	Pass
0.7940	14.336	22.86	2.53	0	39.726	Pass

(Between 30MHz –1000 MHz)

Job No.:	011610159I	Plarization:	Horizontal
Standard:	FCC PART15 C _3m	Power Source:	AC 120V, 60Hz for adapter
Test item:	Radiation Test	Temp.(C)/Hum.(%RH):	24.4(C)/50%RH
Test Mode:	Charging	Distance:	3m

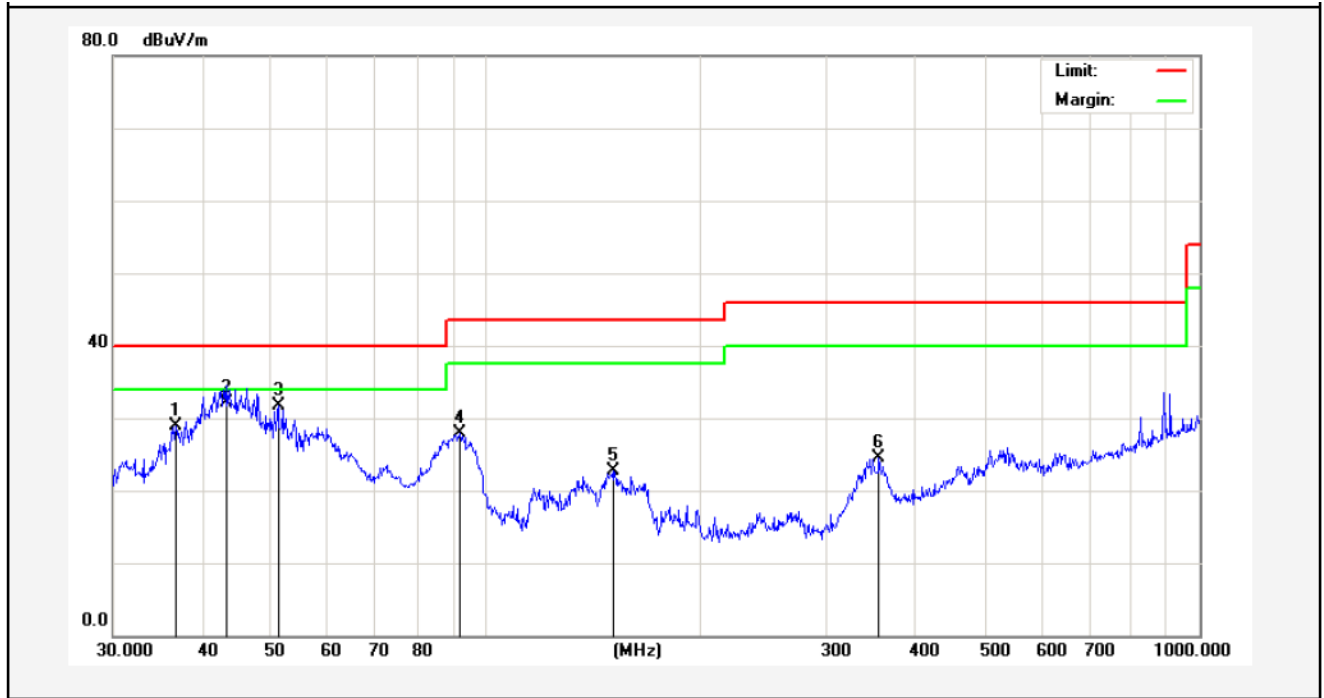

No.	Freq. (MHz)	Reading (dBuV/m)	Factor (dB/m)	Result (dBuV/m)	Limit (dBuV/)	Over Limit (dB)	Detector	Height (cm)	degree (deg)	Remark
1	36.7662	41.89	-12.91	28.98	40.00	-11.02	peak			
2	43.3534	43.80	-11.68	32.12	40.00	-7.88	QP	100	0	
3	51.1209	46.29	-14.65	31.64	40.00	-8.36	peak			
4	91.8163	45.11	-17.21	27.90	43.50	-15.60	peak			
5	150.5378	40.97	-18.33	22.64	43.50	-20.86	peak			
6	355.4273	37.39	-12.82	24.57	46.00	-21.43	peak			



Job No.:	011610159I	Plarization:	Vertical
Standard:	FCC PART15 C _3m	Power Source:	AC 120V, 60Hz for adapter
Test item:	Radiation Test	Temp.(C)/Hum.(%RH):	24.4(C)/50%RH
Test Mode:	Charging	Distance:	3m

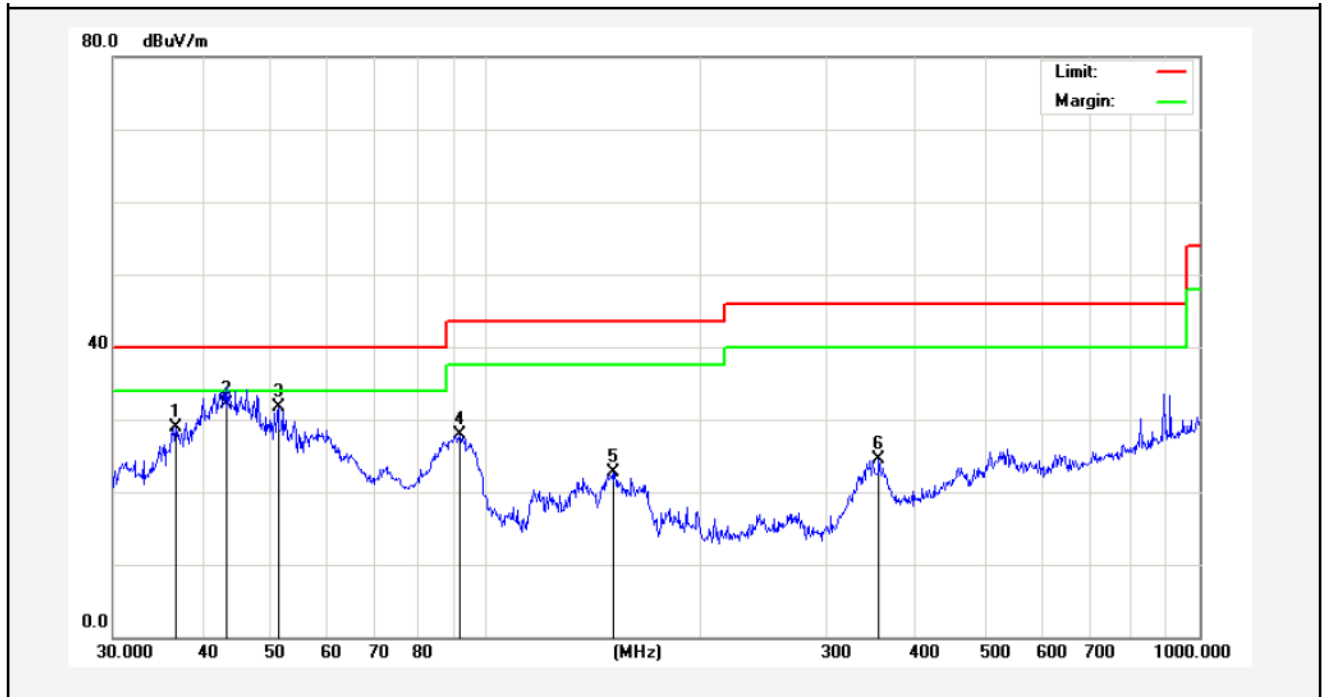

No.	Freq. (MHz)	Reading (dBuV/m)	Factor (dB/m)	Result (dBuV/m)	Limit (dBuV/)	Over Limit (dB)	Detector	Height (cm)	degree (deg)	Remark
1	36.7662	41.89	-12.91	28.98	40.00	-11.02	peak			
2	43.3534	43.80	-11.68	32.12	40.00	-7.88	QP	100	0	
3	51.1209	46.29	-14.65	31.64	40.00	-8.36	peak			
4	91.8163	45.11	-17.21	27.90	43.50	-15.60	peak			
5	150.5378	40.97	-18.33	22.64	43.50	-20.86	peak			
6	355.4273	37.39	-12.82	24.57	46.00	-21.43	peak			

6. PHOTOGRAPH

6.1 Photo of Conducted Emission Test



6.2 Photo of Radiation Emission Test

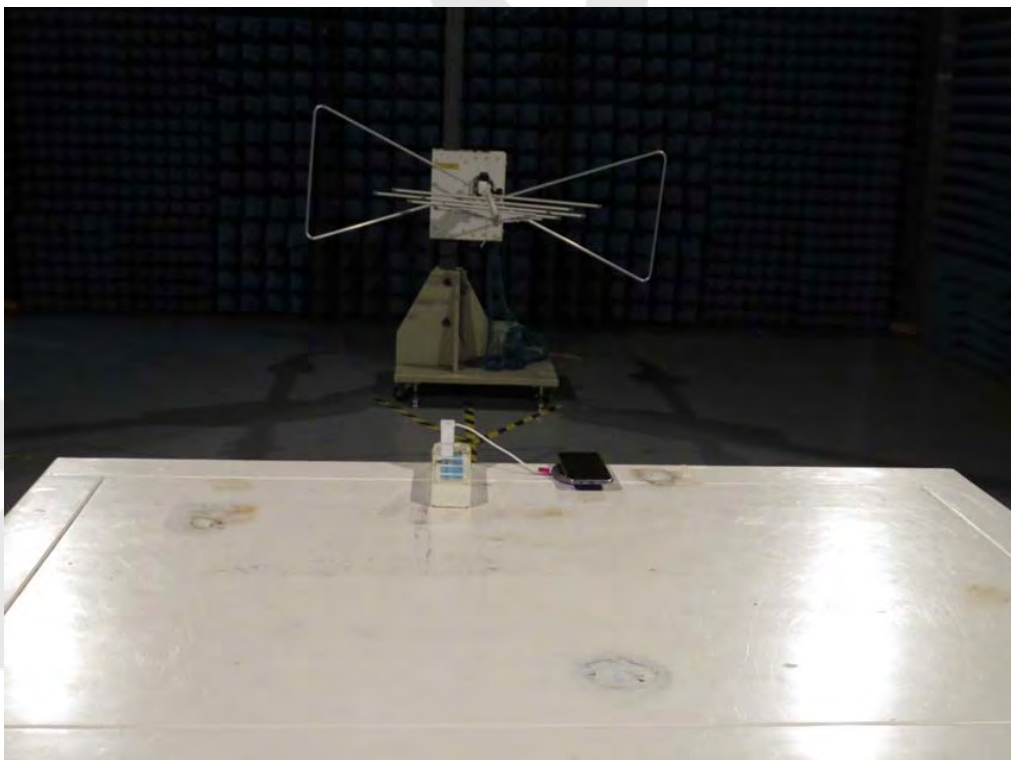
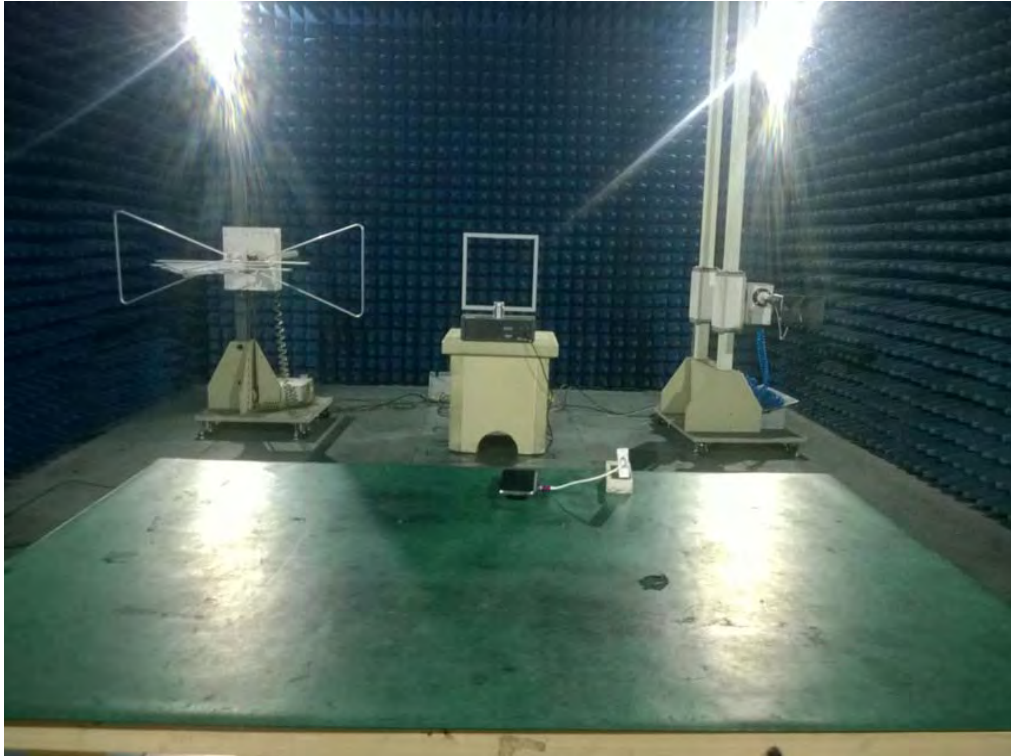

APPENDIX I (EXTERNAL PHOTOS)

1. Figure

The EUT-Top View

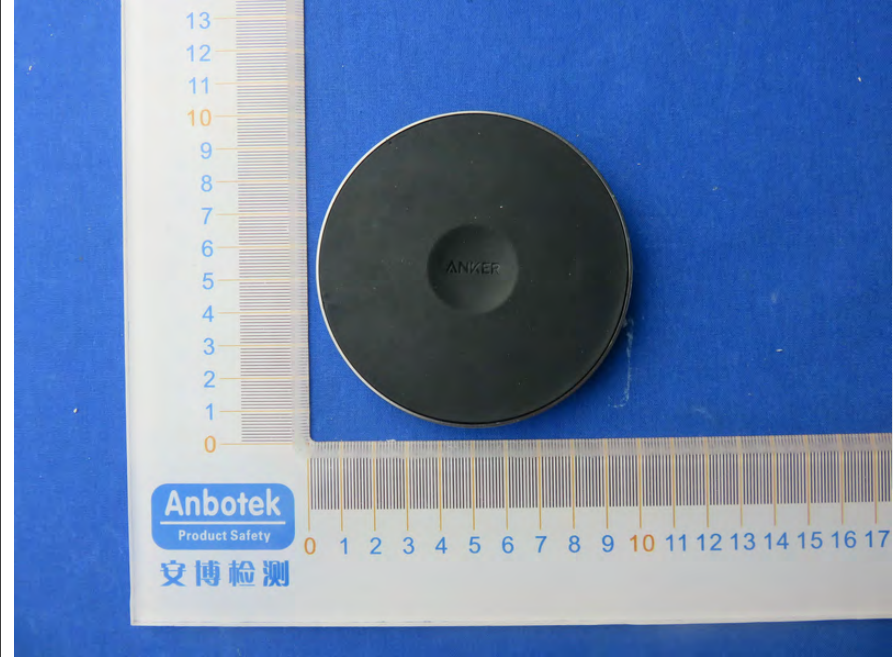

2. Figure

The EUT-Bottom View

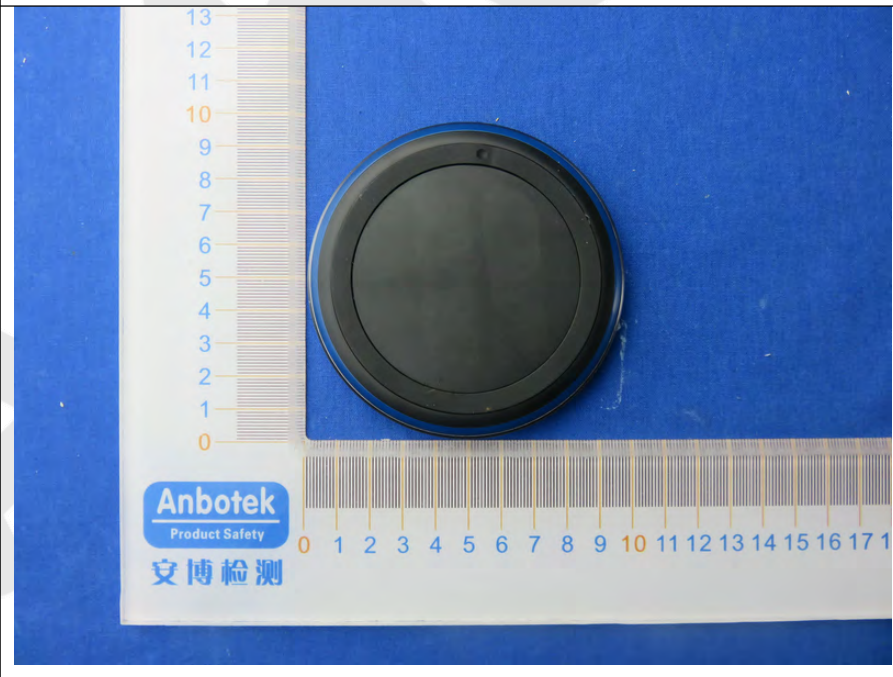

3. Figure
The EUT-Front View



4. Figure
The EUT-Back View

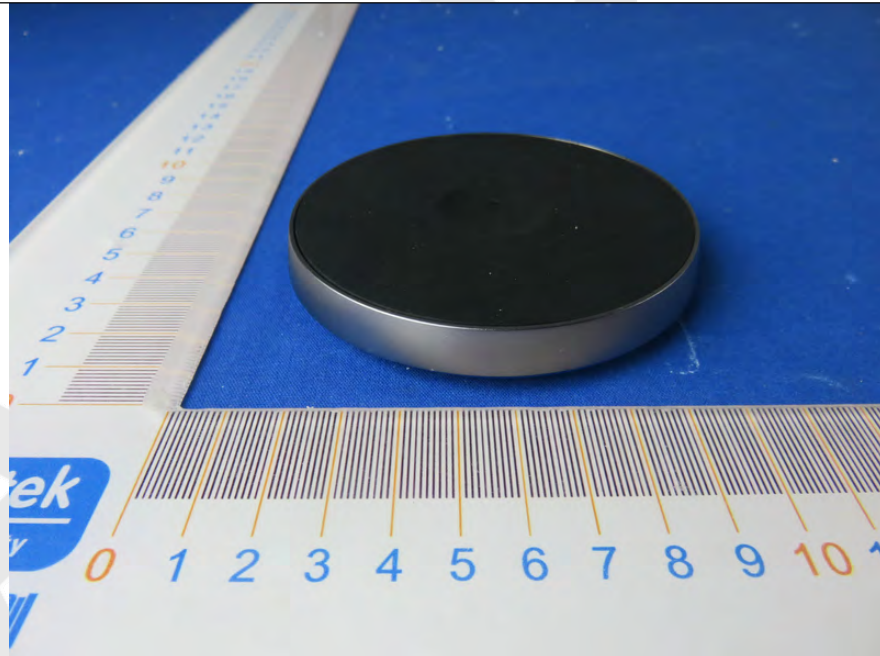

5. Figure
The EUT-Right View



6. Figure
The EUT- Left View

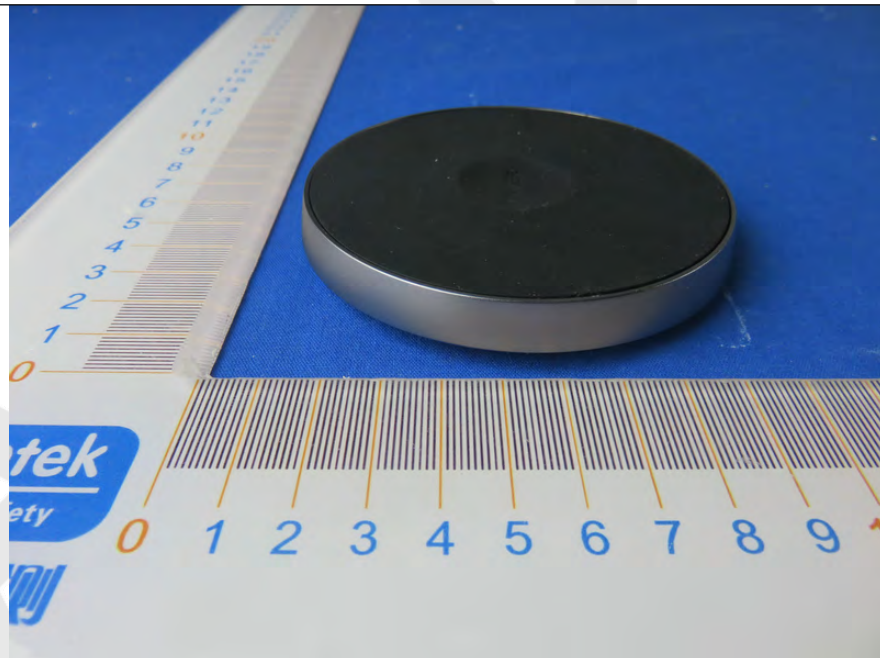

APPENDIX II (INTERNAL PHOTOS)

1. Figure
The EUT-Inside View

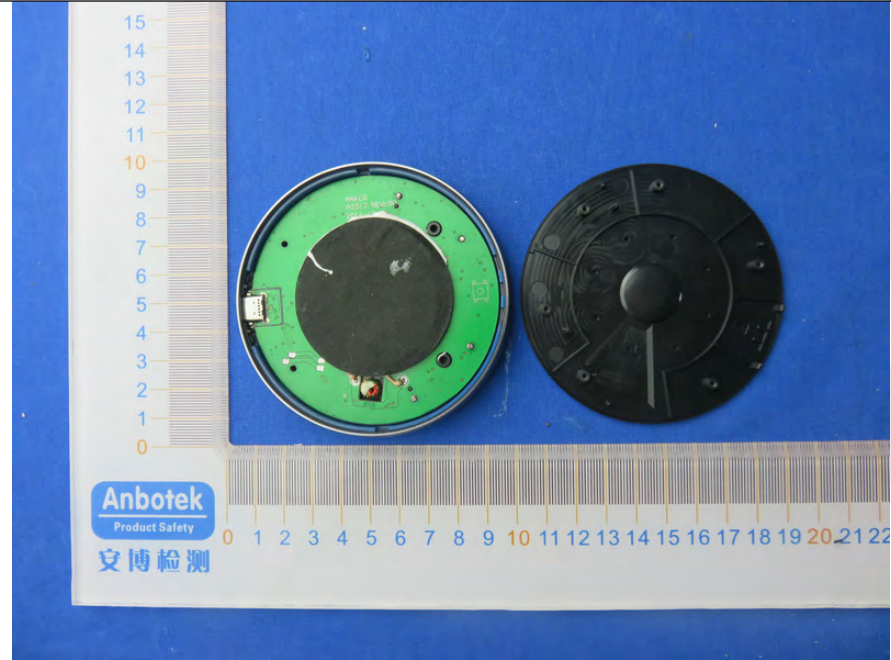

2. Figure
PCB of the EUT-Front View

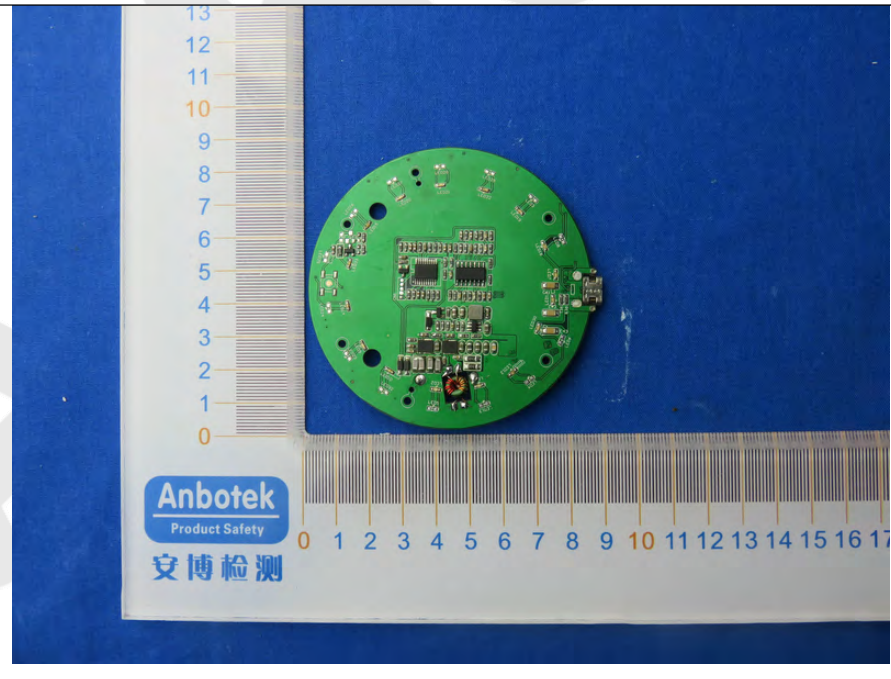

3. Figure
PCB of the EUT-Back View (1)

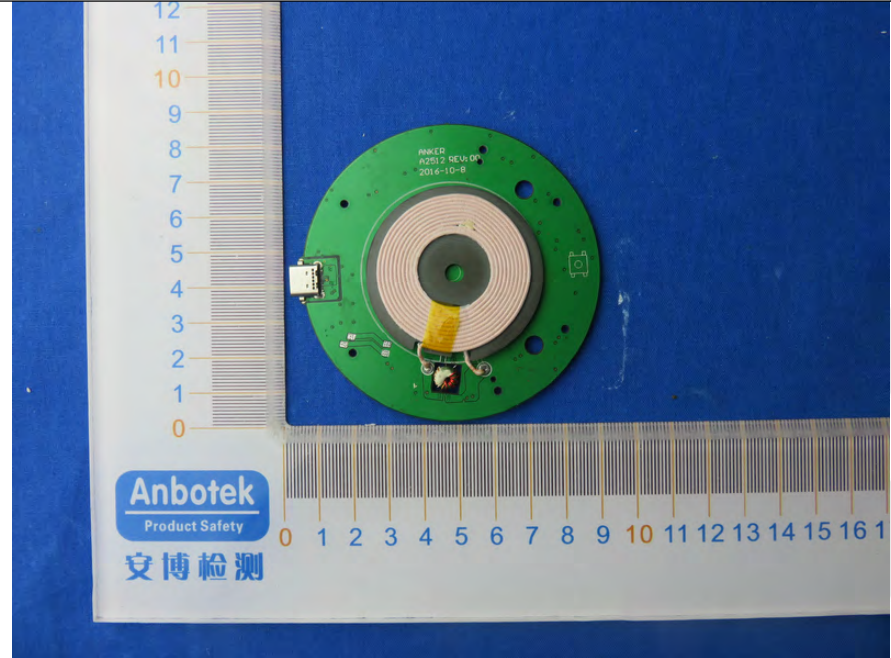

4. Figure
PCB of the EUT-Back View (2)

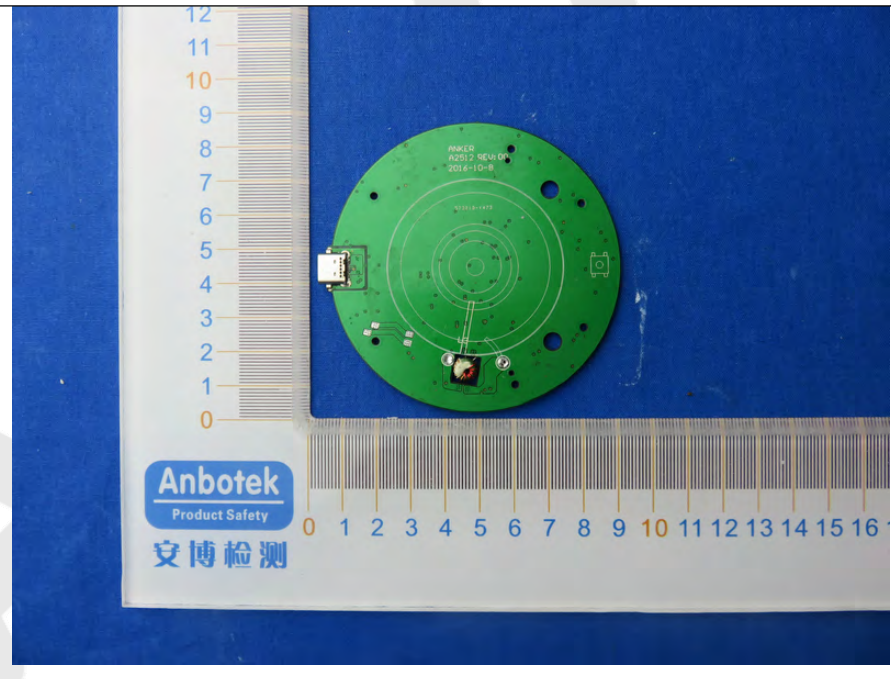

5. Figure
PCB of the Antenna View

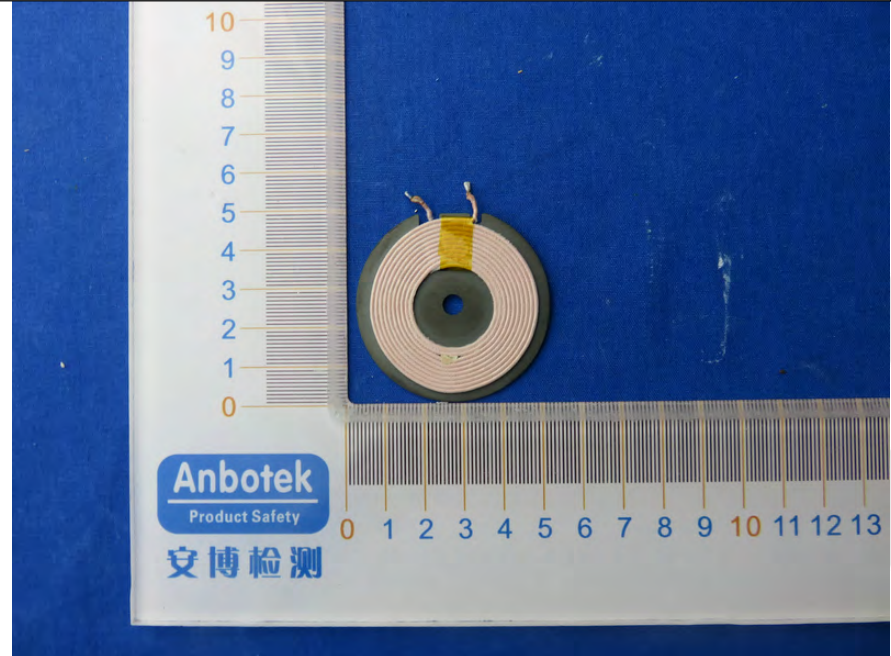

6. Figure
PCB of the Antenna View

