

For FAQs and more information, please visit:
anker.com/support

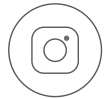

@anker_official
@anker_jp



@Anker Deutschland
@Anker Japan
@Anker



@AnkerOfficial
@Anker_JP

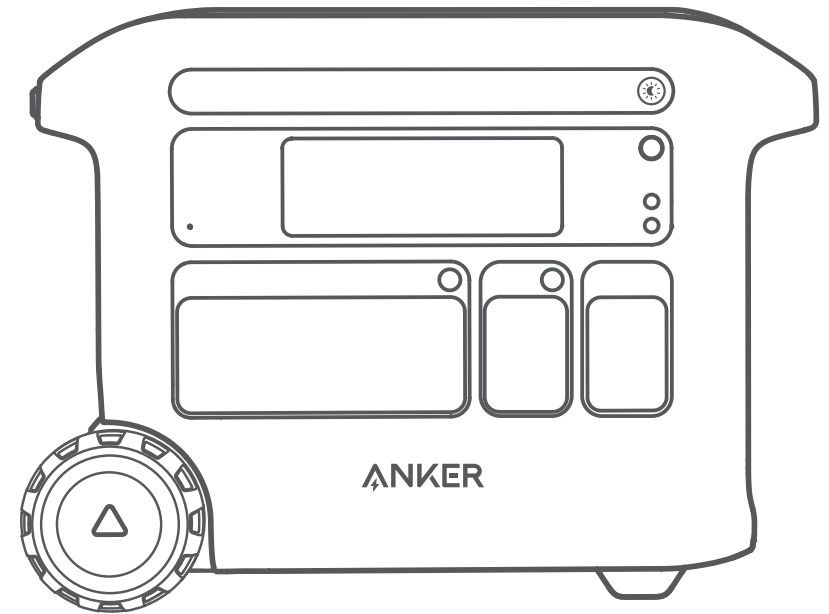

Anker 767 Portable Power Station
(GaNPrime PowerHouse 2048Wh)

USER MANUAL

What's in the Box

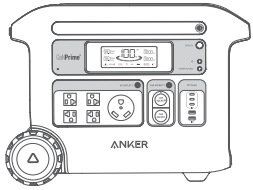

Anker 767 Portable Power Station

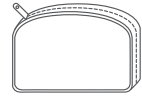

Accessories Bag

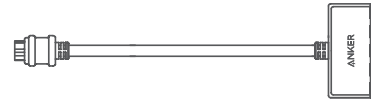

Solar Charging Cable



AC Charging Cable



Car Charging Cable



User Manual

Overview

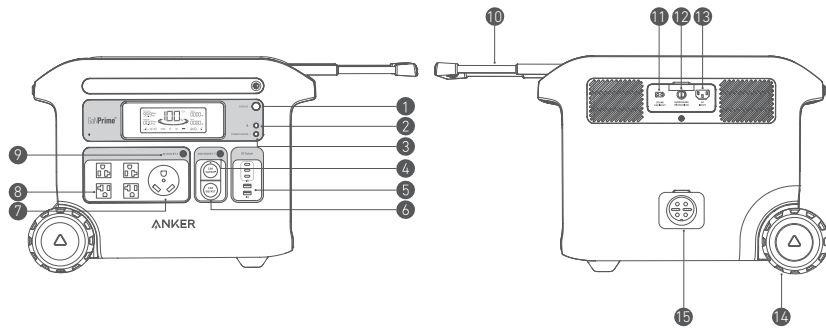

1 Display Button	9 AC Outlet Button
2 IoT Button	10 Retractable Handle (Press the button on the retractable handle and pull to extend)
3 Power Saving Button	11 Solar Input and Car Input
4 Car Socket Button	12 Overcharge Protection
5 USB Ports	13 AC Input Port
6 Car Sockets	14 Wheel(s)
7 TT-30R AC Output Port	15 Expansion Battery Port
8 NEMA-20R AC Output Ports	

Recharging Your Power Station

AC recharging (1440W Max)

Recharge your power station by connecting to a wall outlet with the AC charging cable.

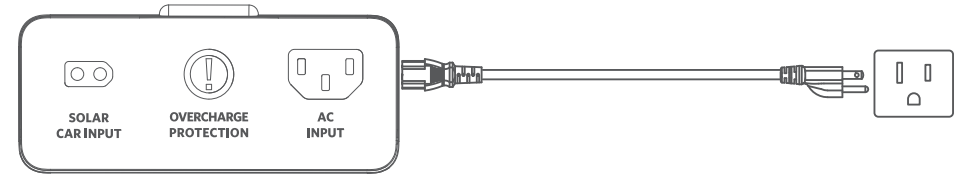

Solar Panel Recharging (1000W Max)

Recharge your power station with a maximum solar input of 1000W by connecting up to five Anker 531 Solar Panels (200W) as shown in the figure with a solar charging cable.

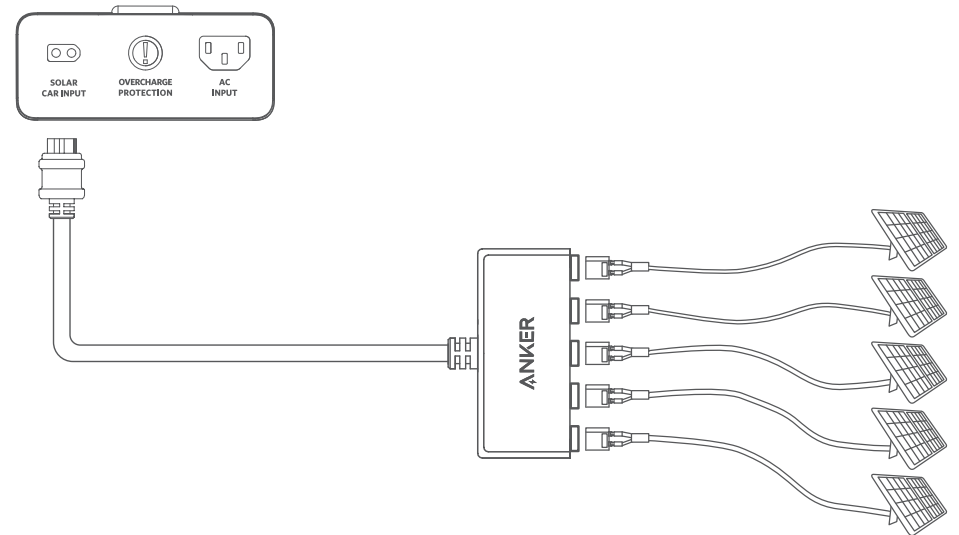

Car Recharging

Recharge your power station by connecting to a car's output port with the car charging cable.

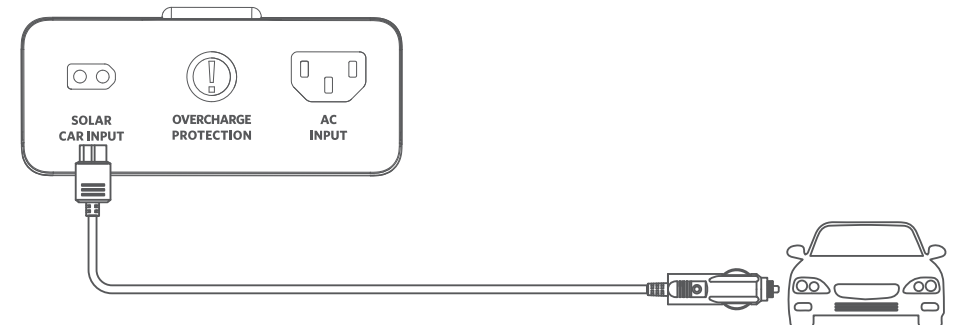

 When your portable power station only has 1% battery remaining, the "Remaining Battery" indicator will flicker to remind you to recharge.

Powering Your Devices

Power Saving Mode

Turning on the Power Saving mode prevents wasting energy as it automatically turns off the power station once all your devices are fully charged.

Turning off the Power Saving mode will enable stable charging over an extended period, such as for time-lapse photography or when using a CPAP machine overnight.

The AC outlets can intelligently identify whether a plug is inserted. This helps prevent power wastage by automatically turning off the power station if no plug is detected for more than 15 minutes, whether the Power Saving mode is turned on or off.

AC Charging

Press the AC outlet button and connect your devices to the AC output ports.

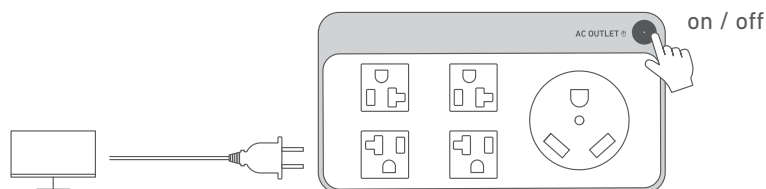

Press the AC outlet button and charge your RV via the TT-30R AC output ports. Please note that the max output of the AC outlet is 2400W, so do not power devices that are higher than 2400W.



USB Charging

Connect your devices to the USB ports.

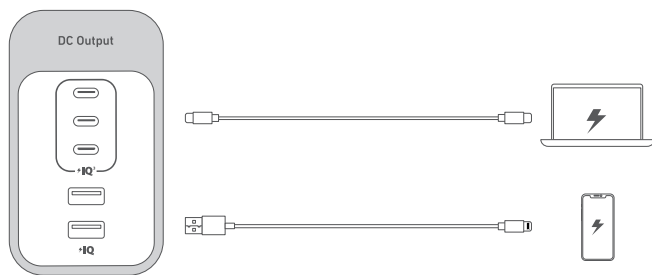

Car Socket Charging

Turn on the car socket and connect your devices to start charging.

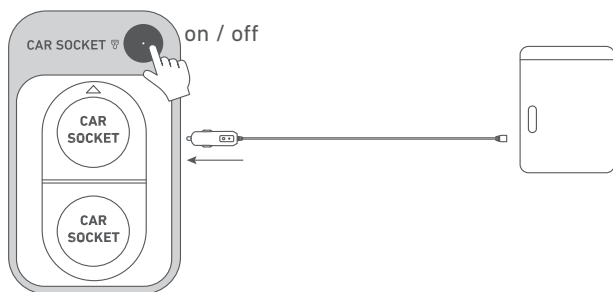

Uninterruptible Power Supply (UPS)

To use the UPS feature, connect your power station to a wall outlet with the AC charging cable, then press the AC outlet button and connect your devices via the AC output ports.

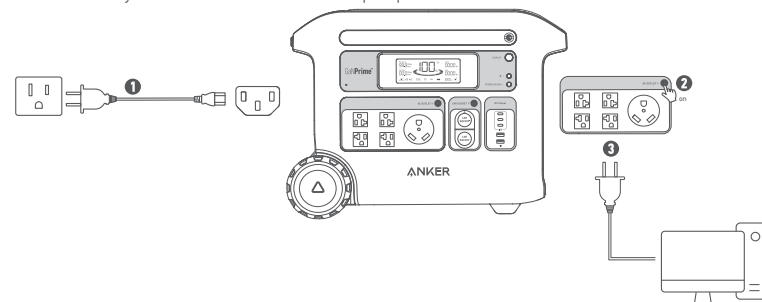

Connect with an Expansion Battery

Your power station can be connected with an expansion battery to double the capacity to 4096Wh. Please refer to the user manual of Anker 760 Portable Power Station Expansion Battery (2048Wh) for detailed instructions.

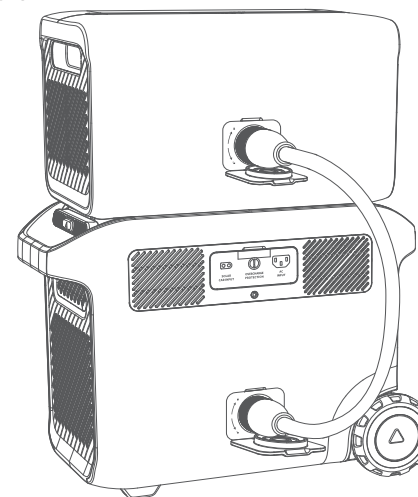

The Anker App for Smart Control

You can remotely control your power station using the Anker App. Please download the app and its user manual by scanning this QR code.

Connect the device to a network before using the app for the first time. After connecting successfully, you can connect your devices off-grid.



Light

Ambient light

Press the button once to turn on the ambient light, and press again up to 2 times to switch between brightness levels.

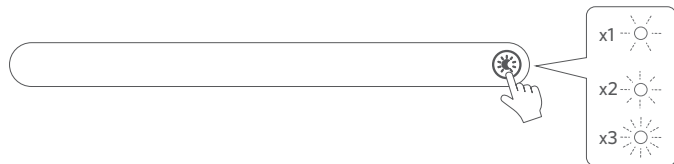

SOS Mode

Press and hold the button for 2 seconds to turn on SOS mode.



LCD Screen Guide

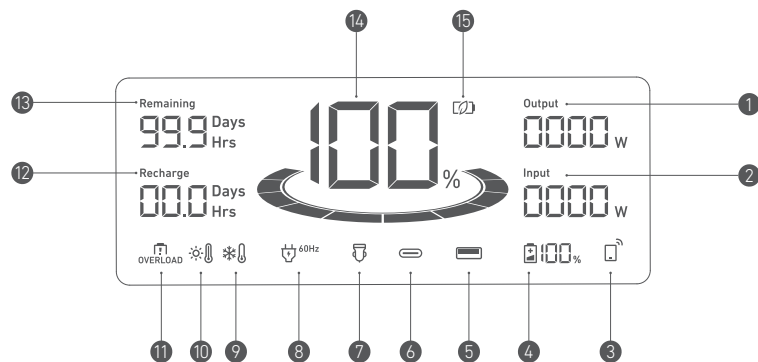

- 1 Current Output Power
- 2 Current Input Power
- 3 IoT
Press the IoT button for 2 seconds and connect your devices through the app when this icon appears on the screen.
- 4 Remaining Battery for Expansion Battery
When the expansion battery is connected successfully, this icon appears on the screen.
- 5 USB-A Output Port
- 6 USB-C Output Port
- 7 Car Charging
- 8 AC Charge and Voltage Frequency
- 9 Low-Temperature Alert
When this icon shows, stop using the power station until the icon disappears.
- 10 High-Temperature Alert
When this icon shows, stop using the power station and let it cool down until the icon disappears.
- 11 Overload Warning
This icon appears when a port is overloaded. The port will be turned off to avoid any damage. Please remove the device causing overload.
- 12 Estimated Time to Fully Recharge
- 13 Estimated Time for Battery to Deplete
- 14 Remaining Battery for Power Station
- 15 Power Saving Mode

FAQ

Q1: What is the max power output of the AC output ports?

The AC output ports can deliver a maximum of 2400W to connected devices.

Q2: Can Anker 767 Portable Power Station power a CPAP machine?

Yes, but make sure to turn off the Power Saving mode first.

Q3: What should I do when using a solar charger to charge Anker 767 Portable Power Station?

The solar input supports an 11-60V solar charger with an XT-60 connector. If you use an 11-32V solar charger, the current supports 10A max. When you use a 32-60V solar charger, the current supports 20A max. We recommend using Anker 531 Solar Panels (200W) to get the best compatibility.

Q4: Can the USB-C ports be used to charge Anker 767 Portable Power Station (input only) or are they output only?

The USB-C ports support output only.

Q5: What should I do when AC recharging fails?

If AC recharging does not work, check to see if the overload protection switch is switched on. If it is on, press down to reset and then continue recharging.

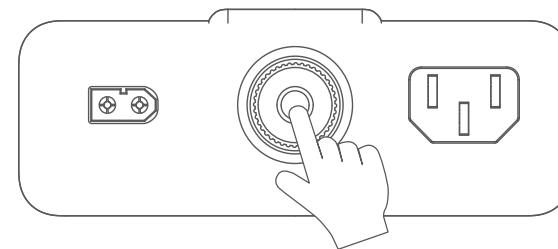

Q6: How do I reset Anker 767 Portable Power Station?

If your power station isn't working correctly, insert a paper clip or pin into the reset hole for 1 second for a factory reset. If the power station still doesn't work, please contact support@anker.com.

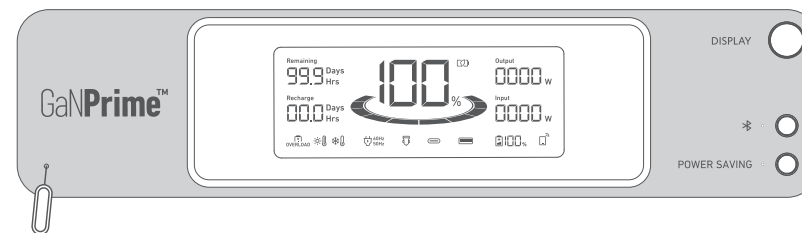

Q7: Why is the power station not working after it hasn't been used for a long time?

If the power station is stored at a low capacity for a long time, lithium batteries will self-consume power which may lead to a quick discharge. This often leads to poor conductivity and a reduced battery lifespan that causes the battery not to work.

Q8: How should I store and maintain the power station?

When storing your portable power station, please make sure that you:

- 1) Turn off all the outputs.
- 2) Store the power station in a dry and cool environment.
- 3) Check the remaining battery capacity each week. If the battery level is below 30%, fully charge the power station. Don't forget to charge it to 100% once every 3 months.

Specifications

Cell Capacity	2048 Wh
AC Input Voltage	120V~ 12A Max, 60Hz
AC Input Power (Charging)	1440W Max
AC Input Power (Bypass Mode)	1440W Max
Solar Panel Input	11-32V $\overline{\text{---}}$ 10A; 32V-60V $\overline{\text{---}}$ 20A (1000W Max)
Car Charger Output	12V $\overline{\text{---}}$ 10A
AC Output	120V~ 20A, 60Hz, 2400W Max
USB-A Output	5V $\overline{\text{---}}$ 2.4A (2.4A Max Per Port)
USB-C Output (100W)	5V $\overline{\text{---}}$ 3A/9V $\overline{\text{---}}$ 3A/15V $\overline{\text{---}}$ 3A/20V $\overline{\text{---}}$ 3A/20V $\overline{\text{---}}$ 5A (100W Max Per Port)
UPS	20ms
Discharging Temperature	-4°F-104°F / -20°C-40°C
Charging Temperature	32°F-104°F / 0°C-40°C
Size	20.7 × 15.5 × 9.8 in / 52.5 × 39.5 × 25.0 cm
Net Weight	67.2 lb / 30.5 kg

Attention



Not permitted on aircraft.

IMPORTANT SAFETY INSTRUCTIONS

WARNING - When using this product, basic precautions should always be followed, including the following:

- Read all the instructions before using the product.
- To reduce the risk of injury, close supervision is necessary when the product is used near children.
- Do not put fingers or hands into the product.
- Do not expose the product to rain or snow.
- Use of an attachment not recommended or sold by the product manufacturer may result in a risk of fire, electric shock, or injury.
- To reduce the risk of damage to the electric plug and cord, pull the plug rather than the cord when disconnecting the product.
- Do not use the product in excess of its output rating. Overload outputs above rating may result in a risk of fire or injury.
- Do not use the product or attachment that is damaged or modified. Damaged or modified batteries may exhibit unpredictable behavior resulting in fire, explosion, or risk of injury.
- Do not operate the product with a damaged cord, plug, or output cable.
- Do not disassemble the product. Take it to a qualified service person when service or repair is required. Incorrect reassembly may result in a risk of fire or electric shock.
- Do not expose the product to fire or high temperatures. Exposure to fire or temperatures above 130°C may cause explosions.
- To reduce the risk of electric shock, unplug the power pack from the outlet before attempting any instructed servicing.
- Have servicing performed by a qualified repair person using only identical replacement parts. This will ensure that the safety of the product is maintained.

- When charging a device, the product may feel warm. This is a normal operating condition and should not be a cause for concern.
- When charging the internal battery, work in a well-ventilated area and do not restrict ventilation in any way.
- Do not clean the product with harmful chemicals or detergents.
- Misuse, dropping, or excessive force may cause product damage.
- When disposing of secondary cells or batteries, keep cells or batteries of different electrochemical systems separate from each other.
- Do not use or store the power station in direct sunlight for a long period, such as in a car, cargo bed, or any other place where it will be exposed to high temperatures. Doing so may cause the product to malfunction, deteriorate, or generate heat.

CAUTION: Risk of explosion if the battery is replaced by an incorrect type.

- Disposal of a battery into a fire or hot oven, or mechanically crushing or cutting off a battery, can result in an explosion.
- Leaving a battery in an extremely high-temperature environment can result in an explosion or leakage of flammable liquid or gas.
- A battery subjected to extremely low air pressure may cause an explosion or leakage of flammable liquid or gas.
- Unplug the AC power cable to disconnect from the line voltage.

WARNING: GROUNDING INSTRUCTIONS

This product must be grounded. In the event of a malfunction or breakdown, grounding provides a path of least resistance for electrical current to reduce the risk of electric shock. This product is equipped with a cord with an equipment grounding conductor and a grounding plug. The plug must be plugged into an outlet that is properly installed and grounded in accordance with all local codes and ordinances.

WARNING – Improper connection of the equipment grounding conductor may result in an electric shock. Check with a qualified electrician if you are in doubt as to whether the product is properly grounded. Do not modify the plug provided with the product. If it does not fit the outlet, have a proper outlet installed by a qualified electrician.

Storage and Maintenance Instructions

1. Store the product between 32°F-104°F (0°C-40°C). Avoid exposing the product to rain or using the product in a humid environment.
2. To preserve the battery lifespan, charge to 100% after using. If you plan to store your power station, recharge to 100% every 3 months.
3. Keep the product on a flat surface when using, charging, and storing.

Bluetooth: The Bluetooth® word mark and logos are registered trademarks owned by the Bluetooth SIG, Inc. and any use of such marks by Anker Innovations Limited (or Anker Technology Co., Limited) is under license. Other trademarks and trade names are those of their respective owners.

FCC Statement

This device complies with Part 15 of the FCC Rules. Operation is subject to the following two conditions: (1) This device may not cause harmful interference, and (2) this device must accept any interference received, including interference that may cause undesired operation.

Warning: Changes or modifications not expressly approved by the party responsible for compliance could void the user's authority to operate the equipment.

Note: This equipment has been tested and found to comply with the limits for a Class B digital device, pursuant to Part 15 of the FCC Rules. These limits are designed to provide reasonable protection against harmful interference in a residential installation.

This equipment generates, uses, and can radiate radio frequency energy and, if not installed and used in accordance with the instructions, may cause harmful interference to radio communications. However, there is no guarantee that interference will not occur in a particular installation. If this equipment does cause harmful interference to radio or television reception, which can be determined by turning the equipment off and on, the user is encouraged to try to correct the interference by one or more of the following measures:

- (1) Reorient or relocate the receiving antenna.
- (2) Increase the separation between the equipment and receiver.
- (3) Connect the equipment into an outlet on a circuit different from that to which the receiver is connected.
- (4) Consult the dealer or an experienced radio / TV technician for help.

The following importer is the responsible party.

Company Name: Fantasia Trading LLC

Address: 5350 Ontario Mills Pkwy, Suite 100, Ontario, CA 91764

Telephone: +1-800-988-7973

RF Exposure Compliance Statement

This equipment complies with the FCC/IC radiation exposure limits set forth for an uncontrolled environment. This equipment should be installed and operated with a minimum distance of 20 cm between the radiator and your body.

Cet équipement est conforme aux limites d'exposition aux radiations FCC/IC établies pour un environnement non contrôlé. Cet équipement doit être installé et utilisé avec une distance minimale de 20 cm entre le radiateur et votre corps.

IC Statement

This device complies with Innovation, Science and Economic Development Canada's licence-exempt RSS(s). Operation is subject to the following two conditions: (1) This device may not cause interference, and (2) This device must accept any interference, including interference that may cause undesired operation of the device. Le présent appareil est conforme aux CNR d'Industrie Canada applicables aux appareils radio exempts de licence. L'exploitation est autorisée aux deux conditions suivantes : (1) l'appareil ne doit pas produire de brouillage, et (2) l'utilisateur de l'appareil doit accepter tout brouillage radioélectrique subi, même si le brouillage est susceptible d'en compromettre le fonctionnement.

This digital apparatus complies with CAN ICES-003(B)/NMB-003(B).

Declaration of Conformity

Hereby, Anker Innovations Limited declares that the product type A1780 is in compliance with Directives 2014/53/EU & 2011/65/EU. The full text of the EU declaration of conformity is available at the following internet address: <https://www.anker.com>

GB Declaration of Conformity

Hereby, Anker Innovations Limited declares that the product type A1780 is in compliance with Radio Equipment Regulations 2017 & The Restriction of the Use of Certain Hazardous Substances in Electrical and Electronic Equipment Regulations 2012. The full text of the GB declaration of conformity is available at the following internet address: <https://www.anker.com>.

Anker Innovations Limited | Room 1318-19, Hollywood Plaza, 610 Nathan Road, Mongkok, Kowloon, HongKong
The following importer is the responsible party (contract for EU and UK matters)

Anker Innovations Deutschland GmbH | Georg-Muuche-Strasse 3, 80807 Munich, Germany

Anker Technology (UK) Limited,

GNR8, 49 Clarendon Road, Watford, Hertfordshire, WD17 1HP, United Kingdom

- Products that are disassembled.
- Products that are cleaned with harmful chemicals or detergents.
- Non-quality related issues (after 30 days of purchase).
- Products purchased from unauthorized resellers.
- Products without sufficient proof of purchase.
- Products that have been refunded.
- Products with an expired warranty.
- Lost, stolen, or free products.
- Damage from outside sources.
- Repairs through 3rd parties.
- Damage from misuse of products (including, but not limited to falls, use of the product in excess of its output rating, exposure of the product to rain or snow, extremely low air pressure, extreme temperatures).
- Purchases from illegitimate resources.
- Batteries that are damaged when not used for a long time or not properly maintained according to the user manual.

Anker is Not Liable For:

- Loss of data incurred from the use of Anker products.
- Returning personal items sent to Anker.

When returning items with a prepaid shipping label provided by Anker, Anker takes responsibility for any damage or loss incurred in transit. When returning items for non-quality issues, the buyer assumes responsibility for any damage or loss incurred in transit. Anker does not provide refunds for items damaged in transit due to non-quality related warranty claims.

Refund and Warranty Claims

We offer a 30-day money-back guarantee for any reason as well as warranty claims for quality-related issues. For more details please refer to www.anker.com/anker-portable-power-station-warranty-policy

For warranty claims, you can send an email to:

US/CA/UK/DE/JP market: support@anker.com

MEA market: support.mea@anker.com

CN market: CEC-CN@anker.com

Or you can call us at:

US/CA: +1 (800)988 7973	UK: +44(0)1604 936 200
DE: +49(0)69 9579 7960	JP: +81 03 4455 7823
UAE: +971 8000 320 817	KSA: +966 8008 500 030
Kuwait: +965 2206 9086	Egypt: +20 8000 000 826
AU: +61 3 8331 4800	TR: +90(850)460 1414
RU: +8(800)511 8623	CN: +86 400 0550 036
KR: +82 0216 7070 98	IN: +91 1800 3138 831
Middle East & Africa: +971 4242 8633	

Valid Proof of Purchase

Please refer to: <https://us.anker.com/policies/refund-policy>

Shipping Costs Must Be Covered by the Buyer in the Following Situations

Please refer to: <https://us.anker.com/policies/refund-policy>

This page is attached to the Anker warranty page, and Anker reserves the right of final interpretation of the content.

Customer Service



5-Year Limited Warranty*

Lifetime Technical Support

support@anker.com
support.mea@anker.com (For Middle East and Africa Only)

(US/CA)
+1 (800)988 7973

*Please note that your rights under applicable law governing the sale of consumer goods remain unaffected by the warranties given in this Limited Warranty.

Anker Portable Power Station Warranty Policy

All Anker portable power stations purchased on AnkerDirect and Anker authorized resellers come with a limited warranty ("warranty") as set out below. By using an Anker portable power station, you are agreeing to be bound by the terms of the Anker limited warranty.

We provide a 5-year limited warranty for purchases made on AnkerDirect and Anker authorized resellers. The warranty period starts from the date of purchase.

Anker's limited warranty is restricted to the country of purchase. The limited warranty is void on items taken outside the country they were originally bought in or shipped to directly from an authorized online purchase.

Exclusions and Limitations

Not covered under warranty:

- Products that are damaged or modified.
- Products operated with a damaged cord, plug, or output cable.