



FCC RADIO TEST REPORT

FCC ID : UZ7TC210K
Equipment : Touch computer
Brand Name : Zebra
Model Name : TC210K
Applicant : Zebra Technologies Corporation
1 Zebra Plaza, Holtsville, NY 11742
Manufacturer : Zebra Technologies Corporation
1 Zebra Plaza, Holtsville, NY 11742
Standard : FCC Part 15 Subpart C §15.247

The product was received on Jan. 20, 2020 and testing was started from Jan. 22, 2020 and completed on Mar. 02, 2020. We, SPORTON INTERNATIONAL INC., EMC & Wireless Communications Laboratory, would like to declare that the tested sample has been evaluated in accordance with the test procedures and has been in compliance with the applicable technical standards.

The report must not be used by the client to claim product certification, approval, or endorsement by TAF or any agency of government.

The test results in this report apply exclusively to the tested model / sample. Without written approval of SPORTON INTERNATIONAL INC. EMC & Wireless Communications Laboratory, the test report shall not be reproduced except in full.

Louis Wu

Approved by: Louis Wu

SPORTON INTERNATIONAL INC. EMC & Wireless Communications Laboratory

No. 52, Huaya 1st Rd., Guishan Dist., Taoyuan City, Taiwan (R.O.C.)



Table of Contents

History of this test report..... 3

Summary of Test Result..... 4

1 General Description 5

 1.1 Product Feature of Equipment Under Test..... 5

 1.2 Product Specification of Equipment Under Test..... 6

 1.3 Modification of EUT 6

 1.4 Testing Location 6

 1.5 Applicable Standards..... 7

2 Test Configuration of Equipment Under Test 8

 2.1 Carrier Frequency and Channel 8

 2.2 Test Mode..... 8

 2.3 Connection Diagram of Test System..... 11

 2.4 Support Unit used in test configuration and system 12

 2.5 EUT Operation Test Setup 12

 2.6 Measurement Results Explanation Example..... 12

3 Test Result 13

 3.1 6dB and 99% Bandwidth Measurement 13

 3.2 Output Power Measurement..... 15

 3.3 Power Spectral Density Measurement 17

 3.4 Conducted Band Edges and Spurious Emission Measurement 20

 3.5 Radiated Band Edges and Spurious Emission Measurement 33

 3.6 AC Conducted Emission Measurement..... 37

 3.7 Antenna Requirements 39

4 List of Measuring Equipment..... 40

5 Uncertainty of Evaluation 41

Appendix A. AC Conducted Emission Test Result

Appendix B. Radiated Spurious Emission

Appendix C. Radiated Spurious Emission Plots

Appendix D. Duty Cycle Plots

Appendix E. Setup Photographs



History of this test report

Report No.	Version	Description	Issued Date
FR010732C	01	Initial issue of report	Mar. 03, 2020



Summary of Test Result

Report Clause	Ref Std. Clause	Test Items	Result (PASS/FAIL)	Remark
3.1	15.247(a)(2)	6dB Bandwidth	Pass	-
3.1	2.1049	99% Occupied Bandwidth	Reporting only	-
3.2	15.247(b)	Power Output Measurement	Pass	-
3.3	15.247(e)	Power Spectral Density	Pass	-
3.4	15.247(d)	Conducted Band Edges	Pass	-
		Conducted Spurious Emission	Pass	-
3.5	15.247(d)	Radiated Band Edges and Radiated Spurious Emission	Pass	Under limit 1.04 dB at 2387.805 MHz
3.6	15.207	AC Conducted Emission	Pass	Under limit 11.89 dB at 13.560 MHz
3.7	15.203 & 15.247(b)	Antenna Requirement	Pass	-

Declaration of Conformity:
The test results with all measurement uncertainty excluded are presented in accordance with the regulation limits or requirements declared by manufacturers.
Comments and Explanations:
The declared of product specification for EUT presented in the report are provided by the manufacturer, and the manufacturer takes all the responsibilities for the accuracy of product specification.

Reviewed by: Wii Chang
Report Producer: Ruby Zou



1 General Description

1.1 Product Feature of Equipment Under Test

Product Specification subjective to this standard	
Equipment	Touch computer
Brand Name	Zebra
Model Name	TC210K
Sample 1	WLAN, GMS, SE4710, NFC, 3G/32GB, Rear camera, 2-pin connector
Sample 2	WLAN, GMS, No scanner, NFC, 3G/32GB, Front & Rear camera, 2-pin connector
EUT supports Radios application	NFC WLAN 11a/b/g/n HT20/HT40 WLAN 11ac VHT20/VHT40/VHT80 Bluetooth BR/EDR/LE
HW Version	Meteor_EV1_MB_V11
OS Version	Android version 10
SW Version	FUSION_QA_2_1.0.0.007_Q
FW Version	Zebra/TC21MG/TC21:10/03-08-17.00-QG-U00-PRD/88:userdebug/release-keys
MFD	27DEC19
EUT Stage	Engineering Sample

Remark: The above EUT's information was declared by manufacturer.

Specification of Accessories				
AC Adapter	Brand Name	Zebra	Part Number	PWR-WUA5V12W0US
Battery 1	Brand Name	Zebra	Part Number	BT-000409-00
Battery 2	Brand Name	Zebra	Part Number	BT-000410-50
Battery 3	Brand Name	Zebra	Part Number	BT-000411-08
USB Cable (TypeA plug to TypeC plug)	Brand Name	Zebra	Part Number	CBL-TC5X-USBC2A-01
Adapter Cable PTT headset (3.5mm to 3.5mm)	Brand Name	Zebra	Part Number	CBL-TC51-HDST35-01
Headset 3.5mm type with PTT/micassy	Brand Name	Zebra	Part Number	HDST-35MM-PTVP-01
Snap on Trigger handle	Brand Name	Zebra	Part Number	TRG-TC2Y-SNP1-01
Belt Holster	Brand Name	Zebra	Part Number	SG-TC2Y-HLSTR1-01
Wearable Arm Mount	Brand Name	Zebra	Part Number	SG-TC2Y-ARMNT-01

Support Unit used in test configuration and system				
Type C to 3.5mm headset adaptor	Trade Name	Google	Model name	Pixel-2-2XL



1.2 Product Specification of Equipment Under Test

Standards-related Product Specification	
Tx/Rx Channel Frequency Range	2412 MHz ~ 2462 MHz
Maximum (Average) Output Power to antenna	802.11b : 20.00 dBm (0.1000 W) 802.11g : 19.90 dBm (0.0977 W) 802.11n HT20 : 20.30 dBm (0.1072 W) 802.11n HT40 : 14.40 dBm (0.0275 W) 802.11ac VHT20 : 20.40 dBm(0.1096 W) 802.11ac VHT40 : 14.50 dBm(0.0282 W)
99% Occupied Bandwidth	802.11b : 12.89MHz 802.11g : 18.33MHz 802.11n VHT20 : 19.08MHz 802.11n VHT40 : 36.76MHz
Antenna Type / Gain	PIFA Antenna with gain 0.60 dBi
Type of Modulation	802.11b : DSSS (DBPSK / DQPSK / CCK) 802.11a/g/n : OFDM (BPSK / QPSK / 16QAM / 64QAM) 802.11ac : OFDM (BPSK / QPSK / 16QAM / 64QAM / 256QAM)

1.3 Modification of EUT

No modifications are made to the EUT during all test items.

1.4 Testing Location

Test Site	SPORTON INTERNATIONAL INC. EMC & Wireless Communications Laboratory	
Test Site Location	No.52, Huaya 1st Rd., Guishan Dist., Taoyuan City, Taiwan (R.O.C.) TEL: +886-3-327-3456 FAX: +886-3-328-4978	
Test Site No.	Sporton Site No.	
	TH05-HY	CO05-HY

Note: The test site complies with ANSI C63.4 2014 requirement.

Test Site	SPORTON INTERNATIONAL INC. EMC & Wireless Communications Laboratory	
Test Site Location	No.58, Aly. 75, Ln. 564, Wenhua 3rd, Rd., Guishan Dist., Taoyuan City, Taiwan (R.O.C.) TEL: +886-3-327-0868 FAX: +886-3-327-0855	
Test Site No.	Sporton Site No.	
	03CH16-HY	

Note: The test site complies with ANSI C63.4 2014 requirement.

FCC designation No.: TW1190 and TW0007



1.5 Applicable Standards

According to the specifications of the manufacturer, the EUT must comply with the requirements of the following standards:

- ♦ FCC Part 15 Subpart C §15.247
- ♦ FCC KDB Publication No. 558074 D01 DTS Meas. Guidance v05r02
- ♦ FCC KDB 414788 D01 Radiated Test Site v01r01.
- ♦ ANSI C63.10-2013

Remark:

1. All test items were verified and recorded according to the standards and without any deviation during the test.
2. This EUT has also been tested and complied with the requirements of FCC Part 15, Subpart B, recorded in a separate test report.



2 Test Configuration of Equipment Under Test

- a. The EUT has been associated with peripherals and configuration operated in a manner tended to maximize its emission characteristics in a typical application. Frequency range investigated: conduction emission (150 kHz to 30 MHz), radiation emission (9 kHz to the 10th harmonic of the highest fundamental frequency or to 40 GHz, whichever is lower). For radiated measurement, pre-scanned in three orthogonal panels, X, Y, Z. The worst cases (X plane) were recorded in this report.
- b. AC power line Conducted Emission was tested under maximum output power.

2.1 Carrier Frequency and Channel

Frequency Band	Channel	Freq. (MHz)	Channel	Freq. (MHz)
2400-2483.5 MHz	1	2412	7	2442
	2	2417	8	2447
	3	2422	9	2452
	4	2427	10	2457
	5	2432	11	2462
	6	2437		

2.2 Test Mode

Final test modes are considering the modulation and worse data rates as below table.

Modulation	Data Rate
802.11b	1 Mbps
802.11g	6 Mbps
802.11n HT20 (Covered by VHT20)	MCS0
802.11n HT40 (Covered by VHT40)	MCS0
802.11ac VHT20	MCS0
802.11ac VHT40	MCS0

Test Cases	
AC Conducted Emission	Mode 1 :WLAN (2.4GHz) Link + Bluetooth Link + NFC On + USB Cable (CBL-TC5X-USBC2A-01) + AC Adapter (PWR-WUA5V12W0US) + Battery1_1X(BT-000409) for Sample 1



802.11b RF Avg. Output Power (dBm)						
Power vs. Channel			Power vs Data Rate			
Channel	Frequency (MHz)	Data Rate (bps)	Channel	Data Rate (bps)		
		1M		2M	5.5M	11M
Duty Cycle (%)		98.80		98.60	96.40	93.90
CH 01	2412	20.00	CH 01	19.90	19.90	19.90
CH 06	2437	20.00				
CH 11	2462	19.80				

802.11g RF Avg. Output Power (dBm)										
Power vs. Channel			Power vs Data Rate							
Channel	Frequency (MHz)	Data Rate (bps)	Channel	Data Rate (bps)						
		6M		9Mbps	12Mbps	18Mbps	24Mbps	36Mbps	48Mbps	54Mbps
Duty Cycle (%)		95.37		93.90	92.00	88.90	86.00	80.80	76.20	74.30
CH 01	2412	14.40	CH 06	19.80	19.80	19.80	19.80	19.60	19.60	19.70
CH 06	2437	19.90								
CH 11	2462	15.40								

802.11n HT20 RF Avg. Output Power (dBm)										
Power vs. Channel			Power vs Data Rate							
Channel	Frequency (MHz)	MCS Index	Channel	MCS Index						
		MCS 0		MCS 1	MCS 2	MCS 3	MCS 4	MCS 5	MCS 6	MCS 7
Duty Cycle (%)		94.10		91.60	88.30	85.40	80.30	75.80	74.30	72.60
CH 01	2412	12.70	CH 06	20.20	20.20	20.20	20.20	20.20	20.20	20.20
CH 06	2437	20.30								
CH 11	2462	15.00								



802.11n HT40 RF Avg. Output Power (dBm)										
Power vs. Channel			Power vs Data Rate							
Channel	Frequency (MHz)	MCS Index	Channel	MCS Index						
		MCS 0		MCS 1	MCS 2	MCS 3	MCS 4	MCS 5	MCS 6	MCS 7
Duty Cycle (%)		91.79		84.90	79.70	75.20	68.90	63.70	61.50	60.30
CH 03	2422	11.80	CH 06	14.30	14.30	14.30	13.90	13.90	13.90	14.30
CH 06	2437	14.40								
CH 09	2452	11.70								

802.11ac VHT20 RF Avg. Output Power (dBm)											
Power vs. Channel			Power vs Data Rate								
Channel	Frequency (MHz)	MCS Index	Channel	MCS Index							
		MCS 0		MCS 1	MCS 2	MCS 3	MCS 4	MCS 5	MCS 6	MCS 7	MCS 8
Duty Cycle (%)		95.10		91.70	88.40	85.60	80.50	76.50	74.60	73.00	69.90
CH 01	2412	12.80	CH 06	20.30	20.30	20.30	20.30	20.30	20.30	20.30	20.30
CH 06	2437	20.40									
CH 11	2462	15.10									

802.11ac VHT40 RF Avg. Output Power (dBm)												
Power vs. Channel			Power vs Data Rate									
Channel	Frequency (MHz)	MCS Index	Channel	MCS Index								
		MCS 0		MCS 1	MCS 2	MCS 3	MCS 4	MCS 5	MCS 6	MCS 7	MCS 8	MCS 9
Duty Cycle (%)		90.48		85.00	78.90	75.60	69.40	64.20	62.40	60.90	57.90	56.20
CH 03	2422	11.90	CH 06	14.40	14.40	14.40	14.00	14.00	14.00	14.40	14.40	14.40
CH 06	2437	14.50										
CH 09	2452	11.80										

2.3 Connection Diagram of Test System

<WLAN Tx Mode>

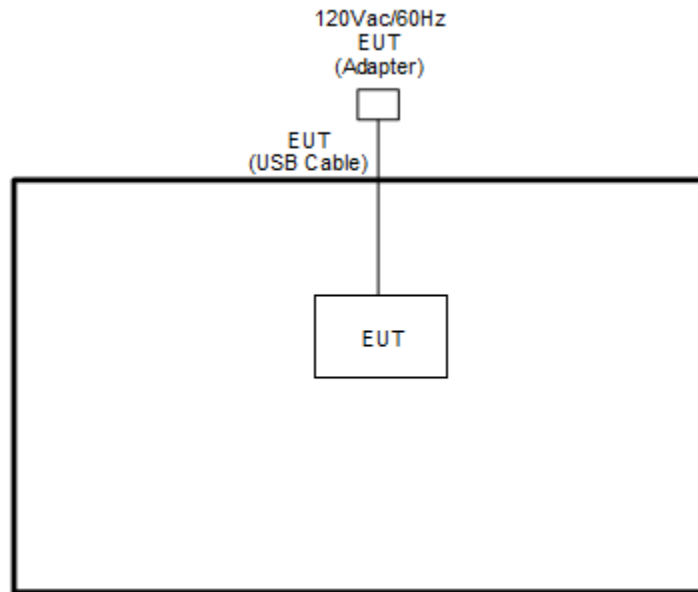

<AC Conducted Emission Mode>

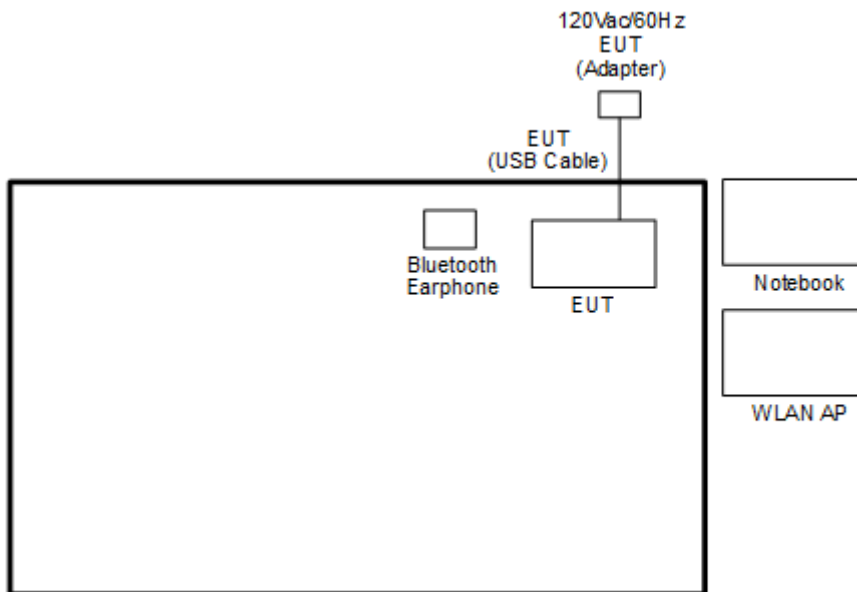

2.4 Support Unit used in test configuration and system

Item	Equipment	Trade Name	Model Name	FCC ID	Data Cable	Power Cord
1.	Bluetooth Earphone	Sony Ericsson	MW600	PY7DDA-2029	N/A	N/A
2.	WLAN AP	ASUS	RT-AC66U	MSQ-RTAC66U	N/A	Unshielded, 1.8 m
3.	Notebook	Dell	Latitude 3400	FCC DoC	N/A	AC I/P : Unshielded, 1.2m DC O/P : Shielded, 1.8m
4.	SD Card	SanDisk	MicroSD HC	FCC DoC	N/A	N/A

2.5 EUT Operation Test Setup

The RF test items, utility “QRCT4” was installed in Notebook which was programmed in order to make the EUT get into the engineering modes to provide channel selection, power level, data rate and the application type and for continuous transmitting signals.

The EUT was set to connect with the WLAN AP under large packet of transmission.

2.6 Measurement Results Explanation Example

For all conducted test items:

The offset level is set in the spectrum analyzer to compensate the RF cable loss and attenuator factor between EUT conducted output port and spectrum analyzer. With the offset compensation, the spectrum analyzer reading level is exactly the EUT RF output level.

Example:

The spectrum analyzer offset is derived from RF cable loss and attenuator factor.

Offset = RF cable loss + attenuator factor.

Following shows an offset computation example with cable loss 4.2 dB and 10dB attenuator.

$$\begin{aligned} \text{Offset(dB)} &= \text{RF cable loss(dB)} + \text{attenuator factor(dB)}. \\ &= 4.2 + 10 = 14.2 \text{ (dB)} \end{aligned}$$

3 Test Result

3.1 6dB and 99% Bandwidth Measurement

3.1.1 Limit of 6dB and 99% Bandwidth

The minimum 6 dB bandwidth shall be at least 500 kHz.

3.1.2 Measuring Instruments

See list of measuring equipment of this test report.

3.1.3 Test Procedures

1. The testing follows the ANSI C63.10 Section 6.9.3 (OBW) and 11.8.1 (6dB BW).
2. The RF output of EUT was connected to the spectrum analyzer by RF cable and attenuator. The path loss was compensated to the results for each measurement.
3. Set to the maximum power setting and enable the EUT transmit continuously.
4. Make the measurement with the spectrum analyzer's resolution bandwidth (RBW) = 100 kHz. Set the Video bandwidth (VBW) = 300 kHz. In order to make an accurate measurement. The 6 dB bandwidth must be greater than 500 kHz.
5. For 99% Bandwidth Measurement, the spectrum analyzer's resolution bandwidth (RBW) is set 1-5% of the emission bandwidth and set the Video bandwidth (VBW) $\geq 3 * RBW$.
6. Measure and record the results in the test report.

3.1.4 Test Setup





3.1.5 Test Result of 6dB and 99% Occupied Bandwidth

Test Engineer :	AnAn Wu, Luffy Lin, and Richard Qiu	Temperature :	21~25°C
		Relative Humidity :	51~54%

2.4GHz Band Single Antenna										
Mod.	Data Rate	NTX	CH.	Freq. (MHz)	99% Occupied BW (MHz)		6dB BW (MHz)		6dB BW Limit (MHz)	Pass/Fail
					Ant. 1	Ant. 2	Ant. 1	Ant. 2		
11b	1Mbps	1	1	2412	12.89	-	8.03	-	0.50	Pass
11b	1Mbps	1	6	2437	12.69	-	7.07	-	0.50	Pass
11b	1Mbps	1	11	2462	12.84	-	7.53	-	0.50	Pass
11g	6Mbps	1	1	2412	16.83	-	15.80	-	0.50	Pass
11g	6Mbps	1	6	2437	18.33	-	15.47	-	0.50	Pass
11g	6Mbps	1	11	2462	16.83	-	15.70	-	0.50	Pass
VHT20	MCS0	1	1	2412	17.98	-	16.62	-	0.50	Pass
VHT20	MCS0	1	6	2437	19.08	-	15.13	-	0.50	Pass
VHT20	MCS0	1	11	2462	17.98	-	16.32	-	0.50	Pass
VHT40	MCS0	1	3	2422	36.76	-	35.68	-	0.50	Pass
VHT40	MCS0	1	6	2437	36.36	-	35.09	-	0.50	Pass
VHT40	MCS0	1	9	2452	36.56	-	35.68	-	0.50	Pass

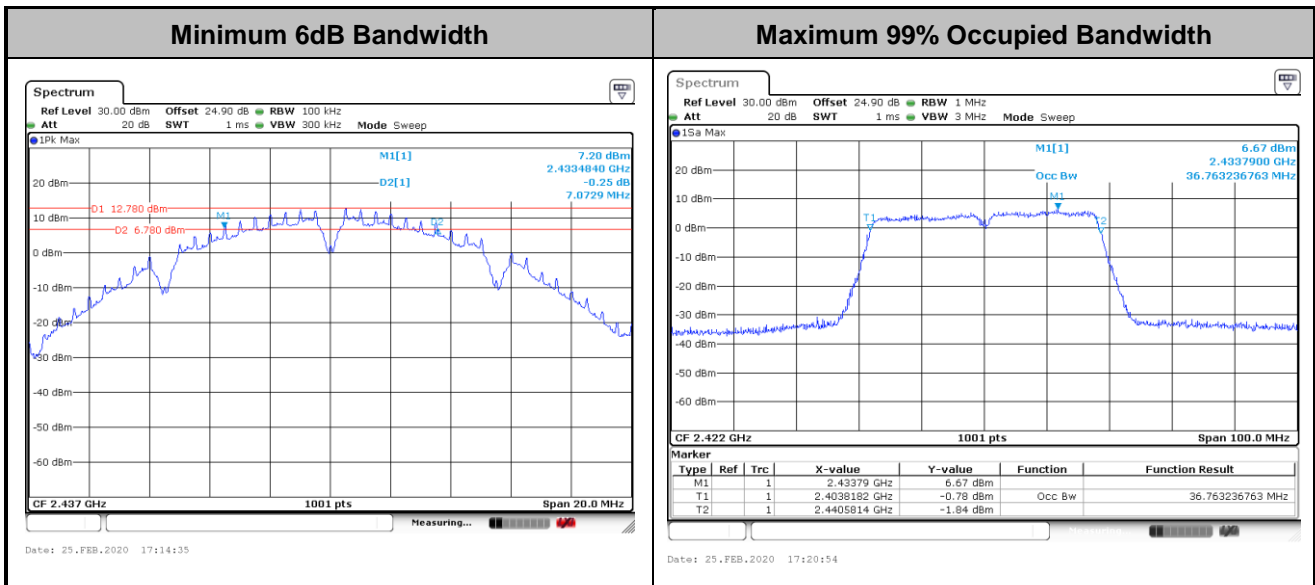

Note: The occupied channel bandwidth is maintained within the band of operation for all of the modulations.

3.2 Output Power Measurement

3.2.1 Limit of Output Power

For systems using digital modulation in the 2400-2483.5MHz, the limit for average output power is 30dBm. If transmitting antenna with directional gain greater than 6dBi is used, the average output power from the intentional radiator shall be reduced below the above stated value by the amount in dB that the directional gain of the antenna exceeds 6 dBi. In case of point-to-point operation, the limit has to be reduced by 1dB for every 3dB that the directional gain of the antenna exceeds 6dBi.

3.2.2 Measuring Instruments

See list of measuring equipment of this test report.

3.2.3 Test Procedures

1. For Average Power, the testing follows ANSI C63.10 Section 11.9.2.3.2 Method AVGPM-G
2. The RF output of EUT was connected to the power meter by RF cable and attenuator. The path loss was compensated to the results for each measurement.
3. Set to the maximum power setting and enable the EUT transmit continuously.
4. Measure the conducted output power and record the results in the test report.

3.2.4 Test Setup

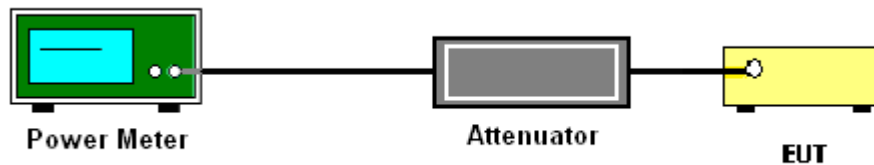



3.2.5 Test Result of Average Output Power

Test Engineer :	AnAn Wu, Luffy Lin, and Richard Qiu	Temperature :	21~25°C
		Relative Humidity :	51~54%

2.4GHz Band Single Antenna															
Mod.	Data Rate	NTX	CH.	Freq. (MHz)	Average Conducted Power (dBm)		Conducted Power Limit (dBm)		DG (dBi)		EIRP Power (dBm)		EIRP Power Limit (dBm)		Pass /Fail
					Ant. 1	Ant. 2	Ant. 1	Ant. 2	Ant. 1	Ant. 2	Ant. 1	Ant. 2	Ant. 1	Ant. 2	
11b	1Mbps	1	1	2412	20.00	-	30.00	-	0.60	-	20.60	-	36.00	-	Pass
11b	1Mbps	1	6	2437	20.00	-	30.00	-	0.60	-	20.60	-	36.00	-	Pass
11b	1Mbps	1	11	2462	19.80	-	30.00	-	0.60	-	20.40	-	36.00	-	Pass
11g	6Mbps	1	1	2412	14.40	-	30.00	-	0.60	-	15.00	-	36.00	-	Pass
11g	6Mbps	1	6	2437	19.90	-	30.00	-	0.60	-	20.50	-	36.00	-	Pass
11g	6Mbps	1	11	2462	15.40	-	30.00	-	0.60	-	16.00	-	36.00	-	Pass
HT20	MCS0	1	1	2412	12.70	-	30.00	-	0.60	-	13.30	-	36.00	-	Pass
HT20	MCS0	1	6	2437	20.30	-	30.00	-	0.60	-	20.90	-	36.00	-	Pass
HT20	MCS0	1	11	2462	15.00	-	30.00	-	0.60	-	15.60	-	36.00	-	Pass
HT40	MCS0	1	3	2422	11.80	-	30.00	-	0.60	-	12.40	-	36.00	-	Pass
HT40	MCS0	1	6	2437	14.40	-	30.00	-	0.60	-	15.00	-	36.00	-	Pass
HT40	MCS0	1	9	2452	11.70	-	30.00	-	0.60	-	12.30	-	36.00	-	Pass
VHT20	MCS0	1	1	2412	12.80	-	30.00	-	0.60	-	13.40	-	36.00	-	Pass
VHT20	MCS0	1	6	2437	20.40	-	30.00	-	0.60	-	21.00	-	36.00	-	Pass
VHT20	MCS0	1	11	2462	15.10	-	30.00	-	0.60	-	15.70	-	36.00	-	Pass
VHT40	MCS0	1	3	2422	11.90	-	30.00	-	0.60	-	12.50	-	36.00	-	Pass
VHT40	MCS0	1	6	2437	14.50	-	30.00	-	0.60	-	15.10	-	36.00	-	Pass
VHT40	MCS0	1	9	2452	11.80	-	30.00	-	0.60	-	12.40	-	36.00	-	Pass

3.3 Power Spectral Density Measurement

3.3.1 Limit of Power Spectral Density

The peak power spectral density shall not be greater than 8dBm in any 3kHz band at any time interval of continuous transmission.

3.3.2 Measuring Instruments

See list of measuring equipment of this test report.

3.3.3 Test Procedures

1. The testing follows the ANSI C63.10 Section 11.10.2 Method PKPSD.
2. The RF output of EUT was connected to the spectrum analyzer by RF cable and attenuator. The path loss was compensated to the results for each measurement.
3. Set to the maximum power setting and enable the EUT transmit continuously.
4. Make the measurement with the spectrum analyzer's resolution bandwidth (RBW) = 3 kHz. Video bandwidth VBW = 10 kHz In order to make an accurate measurement, set the span to 1.5 times DTS Channel Bandwidth. (6dB BW)
5. Detector = peak, Sweep time = auto couple, Trace mode = max hold, Allow trace to fully stabilize. Use the peak marker function to determine the maximum power level.
6. Measure and record the results in the test report.

3.3.4 Test Setup

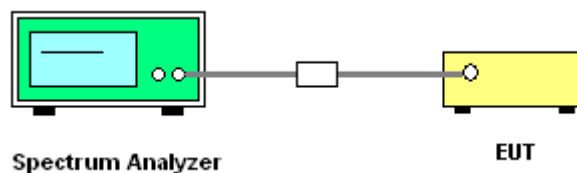



3.3.5 Test Result of Power Spectral Density

Test Engineer :	AnAn Wu, Luffy Lin, and Richard Qiu	Temperature :	21~25°C
		Relative Humidity :	51~54%

2.4GHz Band Single Antenna											
Mod.	Data Rate	NTX	CH.	Freq. (MHz)	Peak PSD (dBm/3kHz)		DG (dBi)		Peak PSD Limit (dBm/3kHz)		Pass/Fail
					Ant. 1	Ant. 2	Ant. 1	Ant. 2	Ant. 1	Ant. 2	
11b	1Mbps	1	1	2412	-2.76	-	0.60	-	8.00	-	Pass
11b	1Mbps	1	6	2437	-1.51	-	0.60	-	8.00	-	Pass
11b	1Mbps	1	11	2462	-2.09	-	0.60	-	8.00	-	Pass
11g	6Mbps	1	1	2412	-10.88	-	0.60	-	8.00	-	Pass
11g	6Mbps	1	6	2437	-4.33	-	0.60	-	8.00	-	Pass
11g	6Mbps	1	11	2462	-8.30	-	0.60	-	8.00	-	Pass
VHT20	MCS0	1	1	2412	-13.20	-	0.60	-	8.00	-	Pass
VHT20	MCS0	1	6	2437	-5.36	-	0.60	-	8.00	-	Pass
VHT20	MCS0	1	11	2462	-9.83	-	0.60	-	8.00	-	Pass
VHT40	MCS0	1	3	2422	-15.21	-	0.60	-	8.00	-	Pass
VHT40	MCS0	1	6	2437	-13.15	-	0.60	-	8.00	-	Pass
VHT40	MCS0	1	9	2452	-16.26	-	0.60	-	8.00	-	Pass

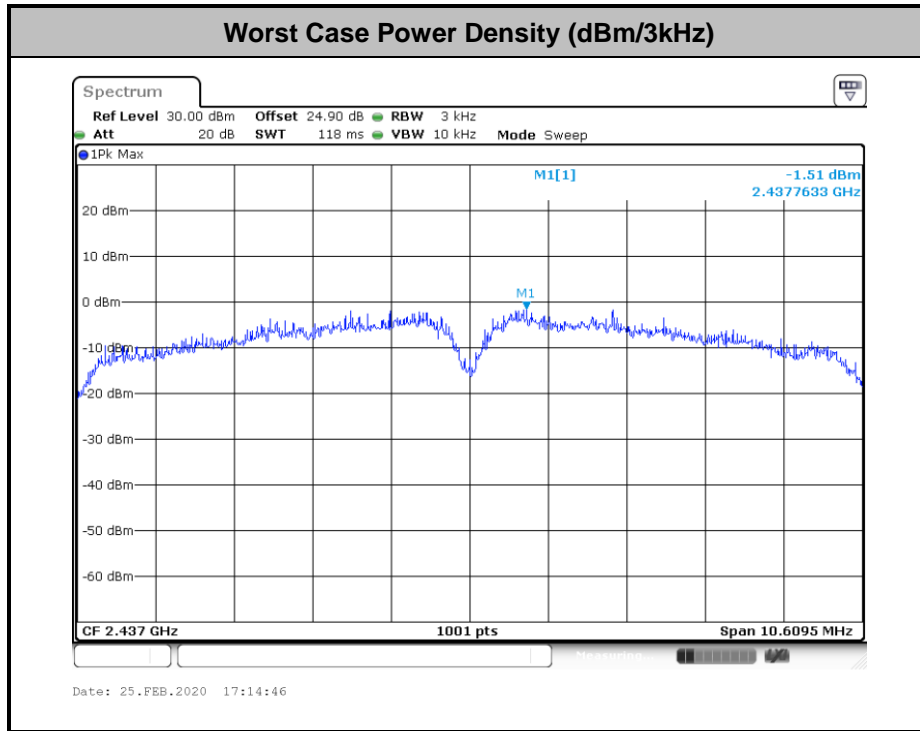

3.4 Conducted Band Edges and Spurious Emission Measurement

3.4.1 Limit of Conducted Band Edges and Spurious Emission Measurement

In any 100 kHz bandwidth outside of the authorized frequency band, the emissions which fall in the non-restricted bands shall be attenuated at least 20 dB / 30dB relative to the maximum PSD level in 100 kHz by RF conducted measurement.

3.4.2 Measuring Instruments

See list of measuring equipment of this test report.

3.4.3 Test Procedures

1. The testing follows the ANSI C63.10 Section 11.11.3 Emission level measurement.
2. The RF output of EUT was connected to the spectrum analyzer by RF cable and attenuator. The path loss was compensated to the results for each measurement.
3. Set to the maximum power setting and enable the EUT transmit continuously.
4. Set RBW = 100 kHz, VBW=300 kHz, Peak Detector. Unwanted Emissions measured in any 100 kHz bandwidth outside of the authorized frequency band shall be attenuated by at least 30 dB relative to the maximum in-band peak PSD level in 100 kHz when maximum peak conducted output power procedure is used. If the transmitter complies with the conducted power limits based on the use of RMS averaging over a time interval, the attenuation required under this paragraph shall be 30 dB instead of 20 dB per 15.247(d).
5. Measure and record the results in the test report.
6. The RF fundamental frequency should be excluded against the limit line in the operating frequency band.

3.4.4 Test Setup

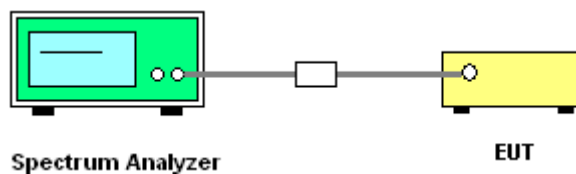



3.4.5 Test Result of Conducted Band Edges and Spurious Emission

Test Engineer :	AnAn Wu, Luffy Lin, and Richard Qiu	Temperature :	21~25°C
		Relative Humidity :	51~54%

Test Mode :	802.11b	Test Channel :	01
-------------	---------	----------------	----

100kHz PSD reference Level	Channel Plot
-----------------------------------	---------------------

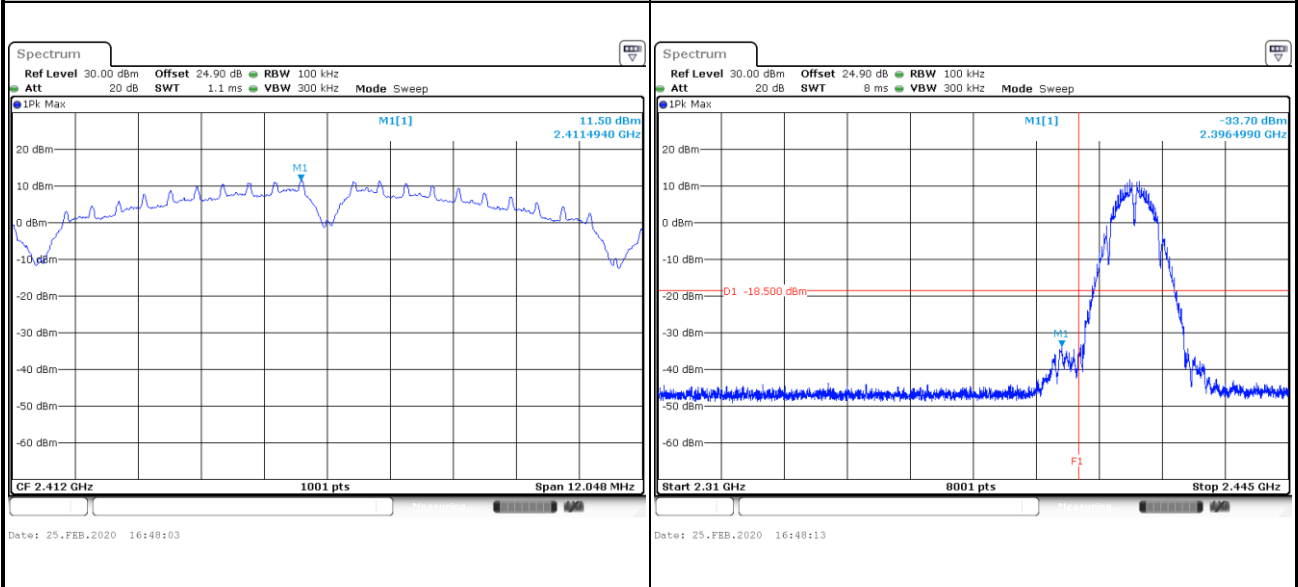

Spurious Emission 30MHz~3GHz	Spurious Emission 2GHz~25GHz
-------------------------------------	-------------------------------------

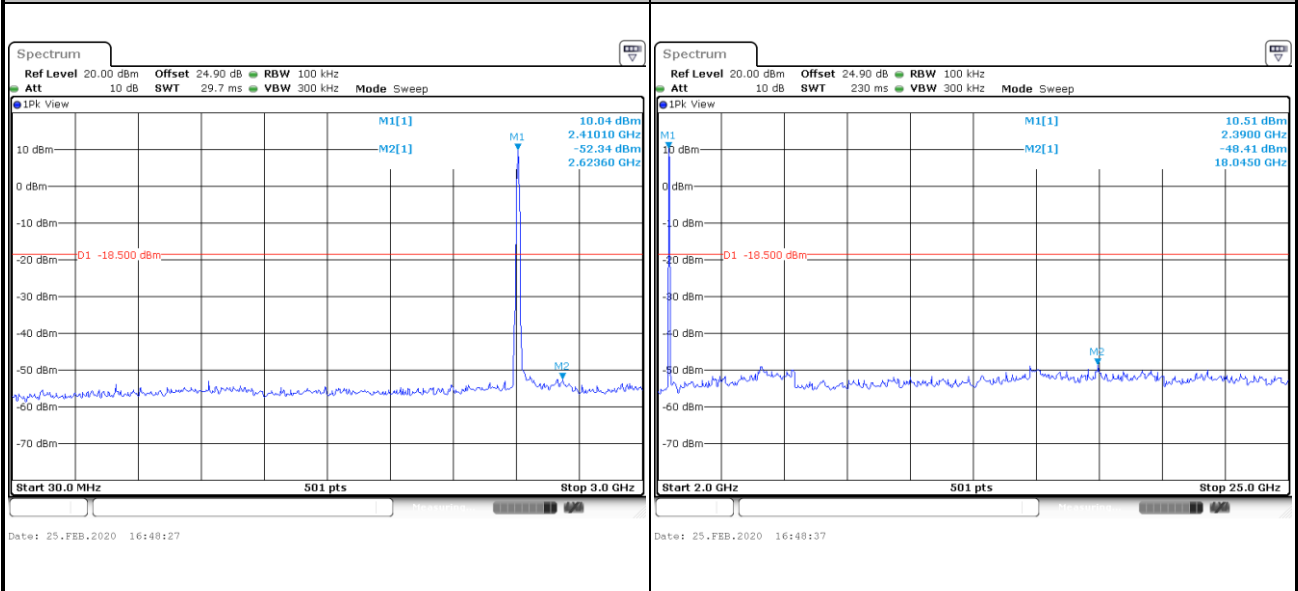



Test Mode :	802.11b	Test Channel :	06
-------------	---------	----------------	----

100kHz PSD reference Level	Channel Plot
----------------------------	--------------

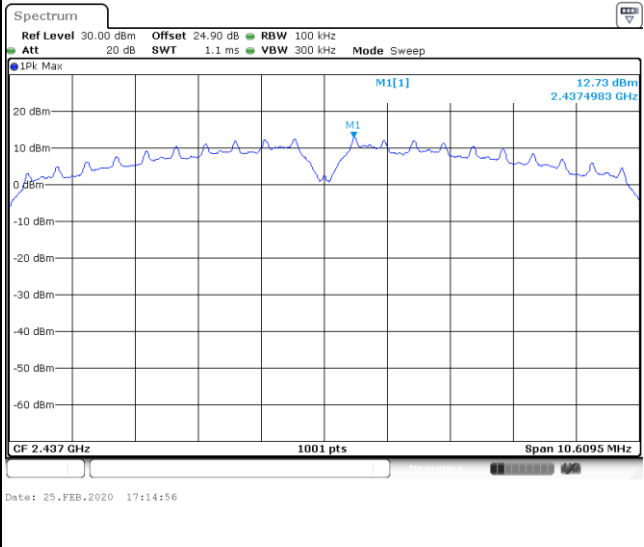

Spurious Emission 30MHz~3GHz

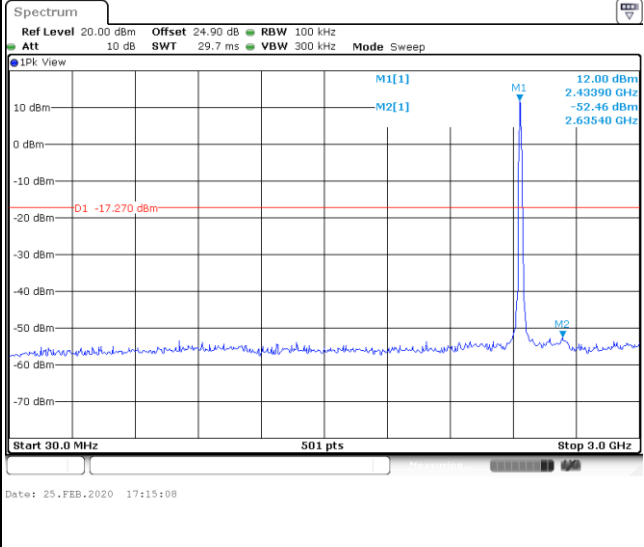

Spurious Emission 2GHz~25GHz

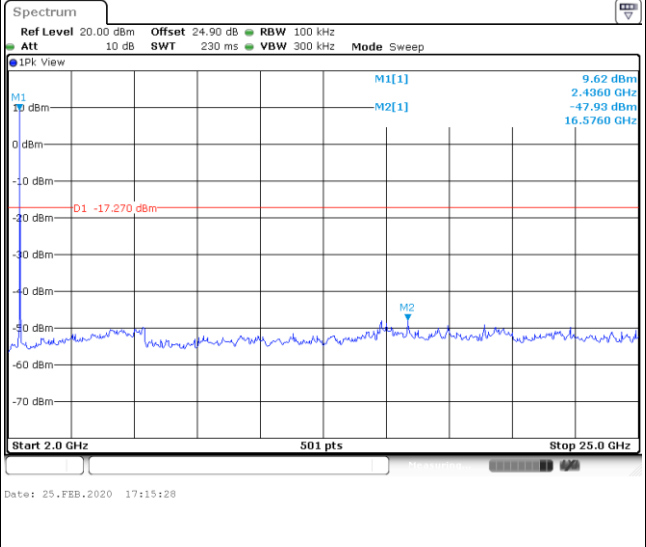



Test Mode :	802.11b	Test Channel :	11
-------------	---------	----------------	----

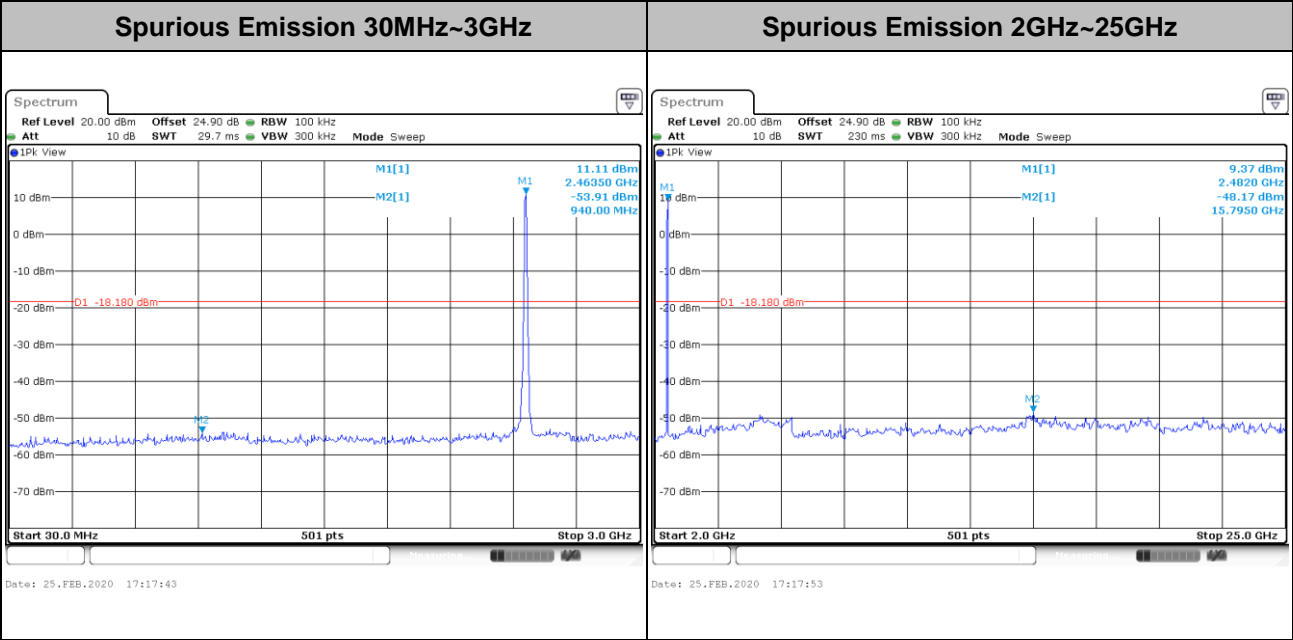
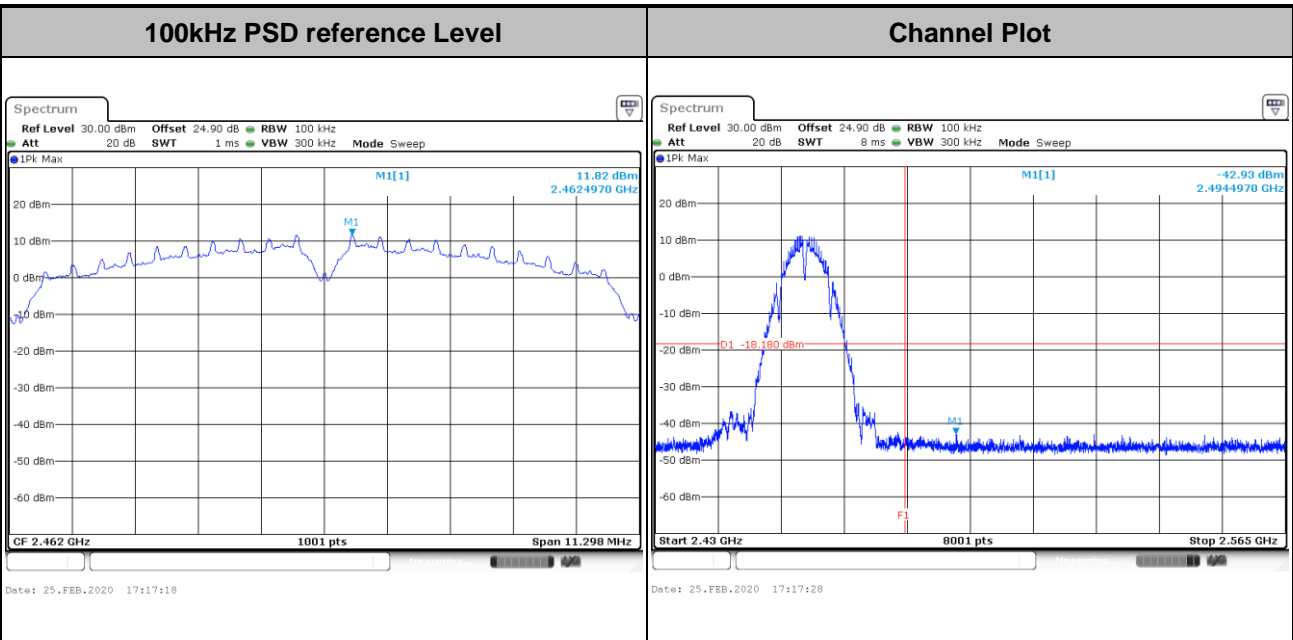



Test Mode : 802.11g Test Channel : 01

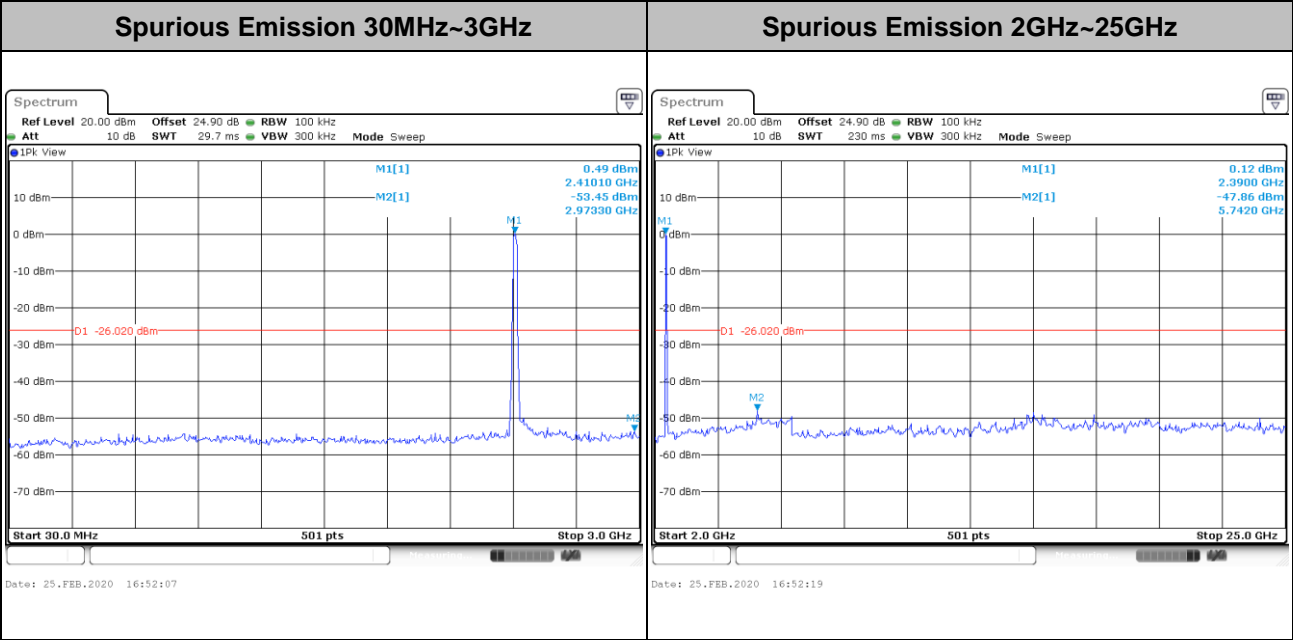
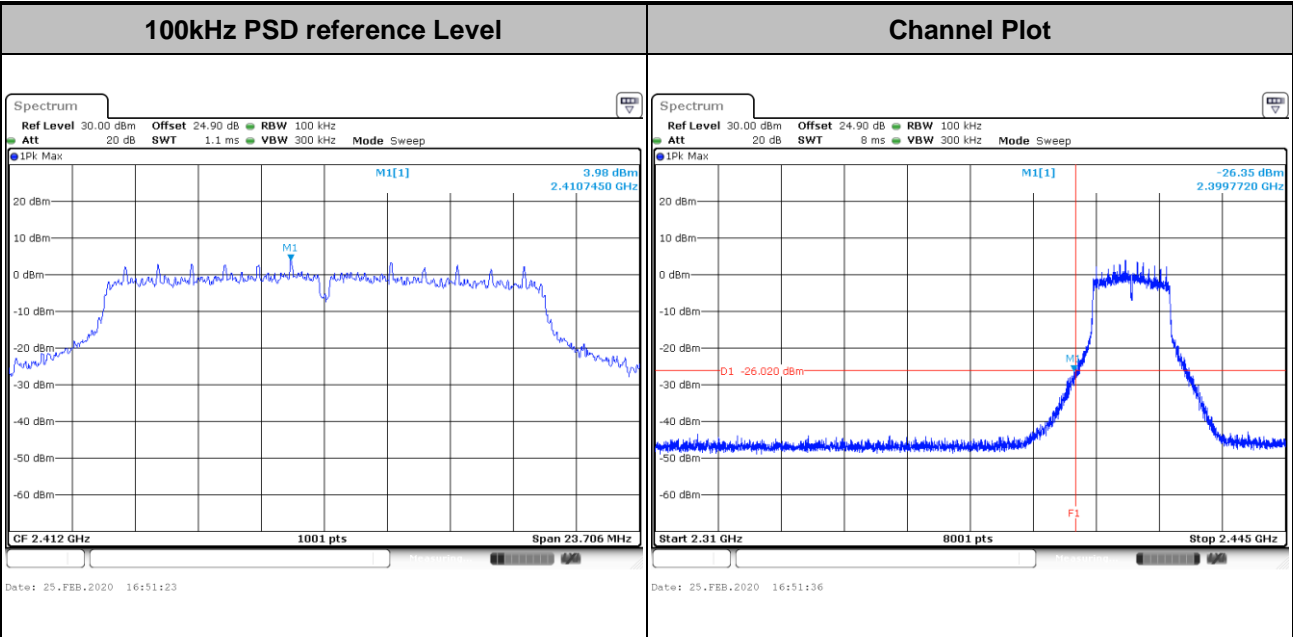



Test Mode :	802.11g	Test Channel :	06
-------------	---------	----------------	----

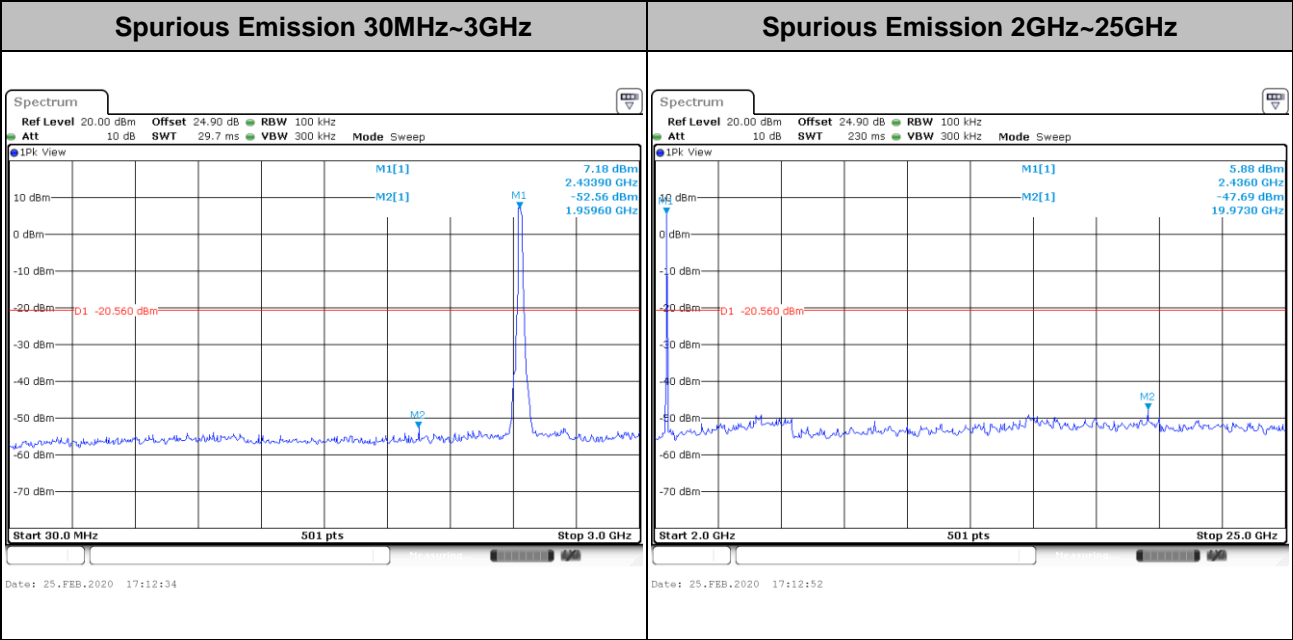
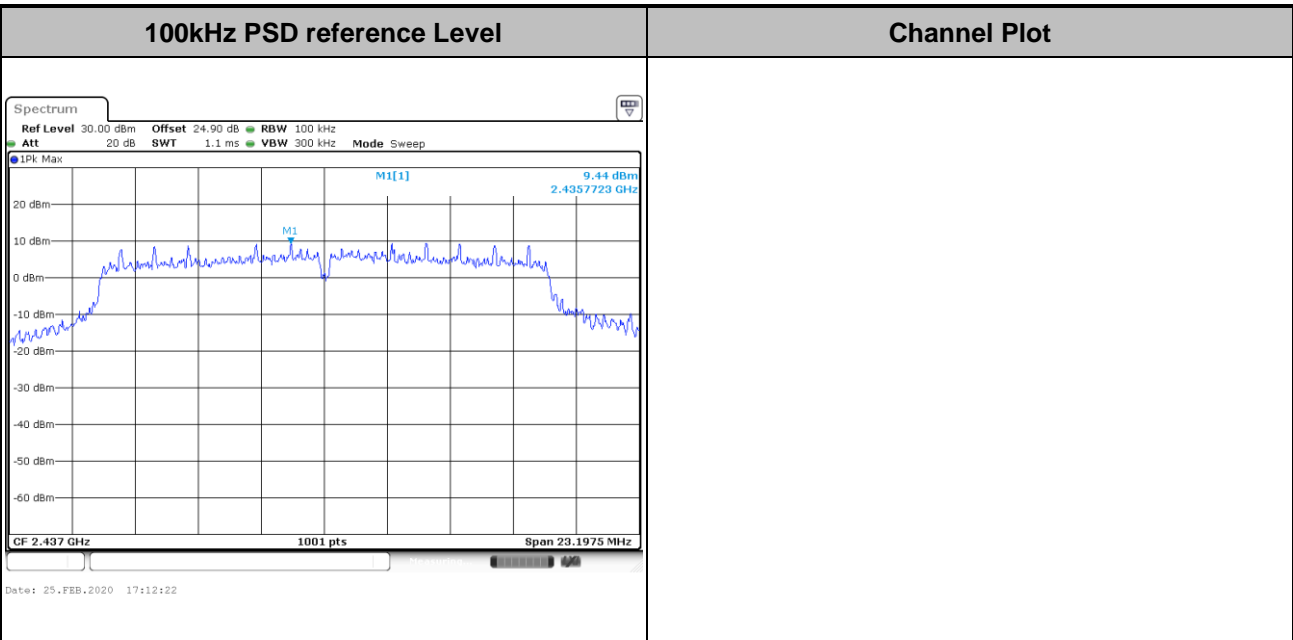



Test Mode :	802.11g	Test Channel :	11
-------------	---------	----------------	----

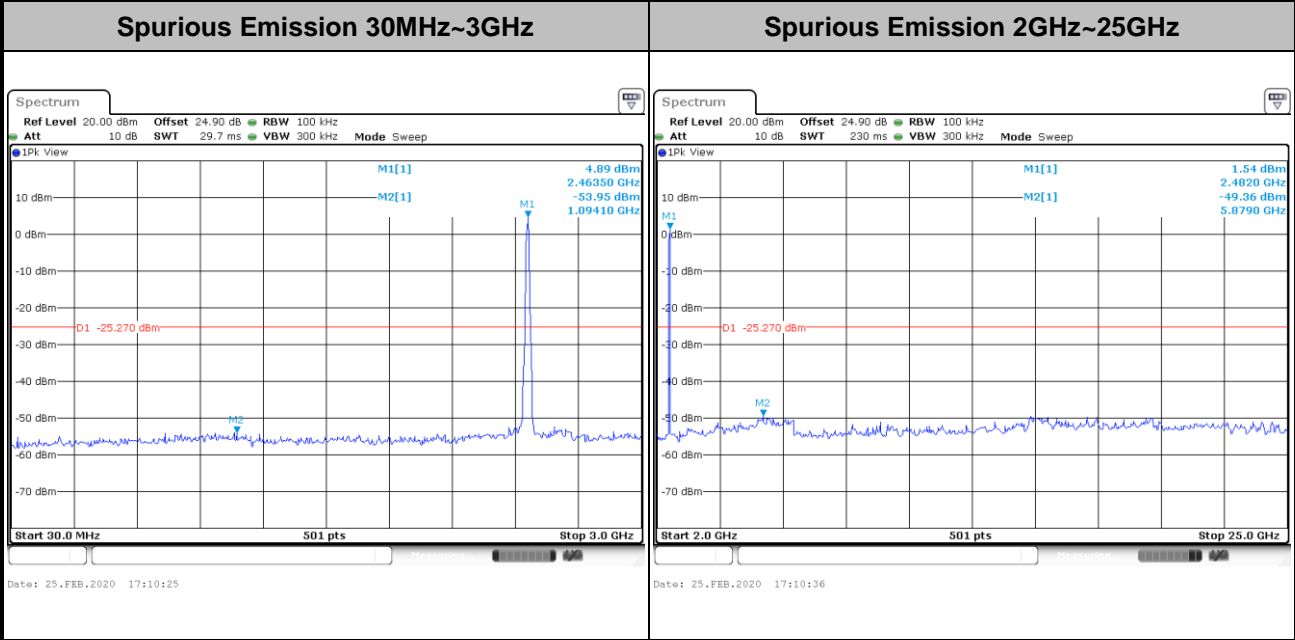
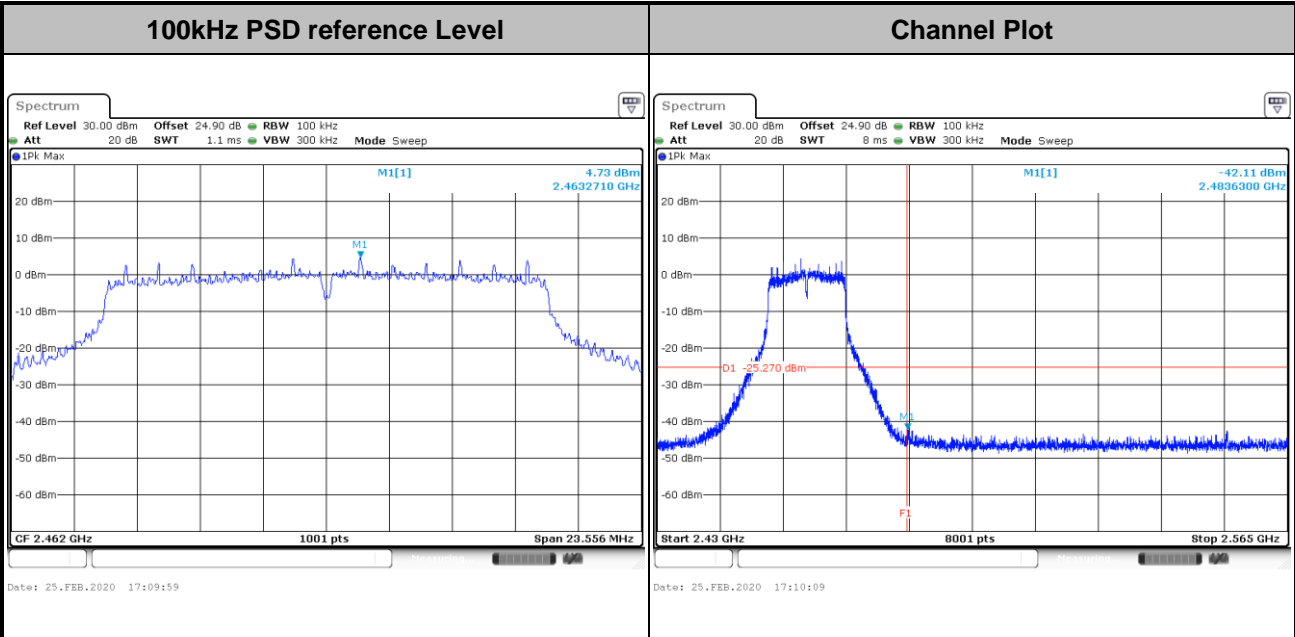



Test Mode :	802.11ac VHT20	Test Channel :	01
-------------	----------------	----------------	----

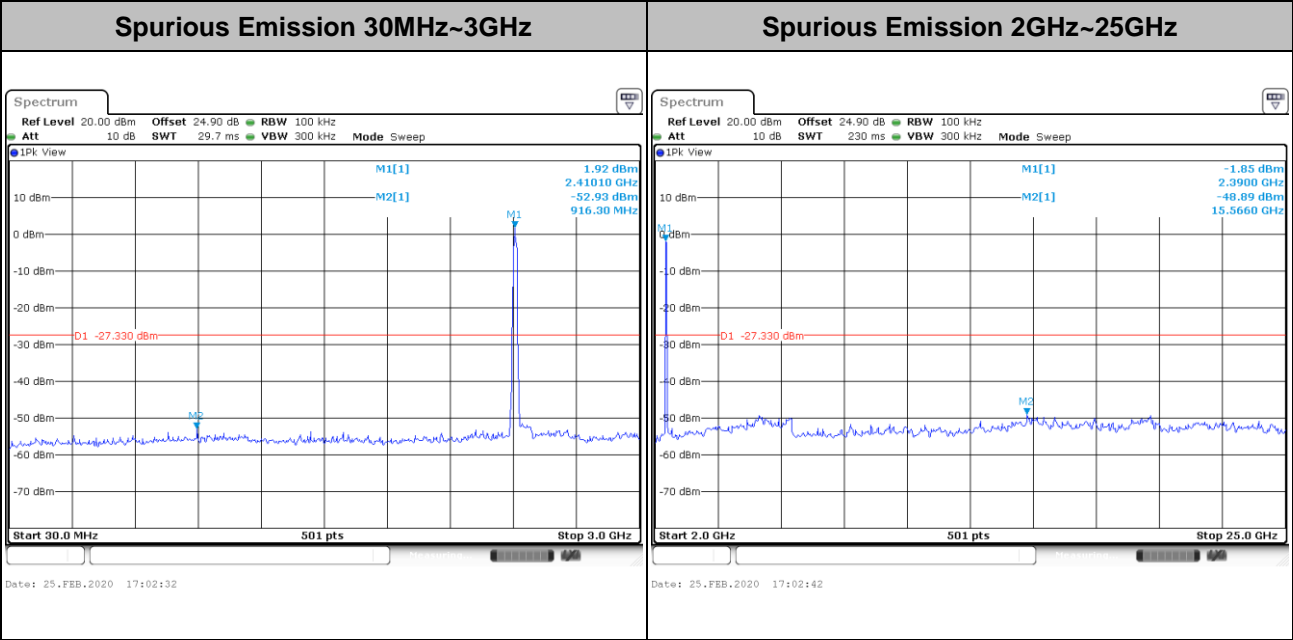
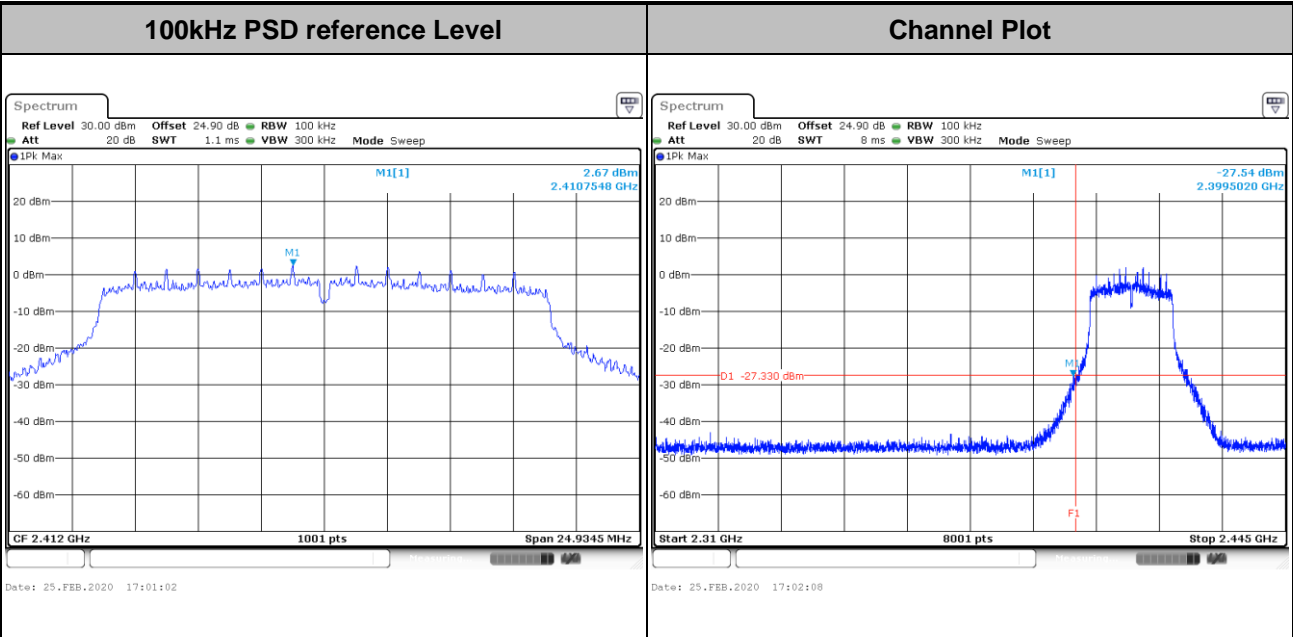



Test Mode :	802.11ac VHT20	Test Channel :	06
-------------	----------------	----------------	----

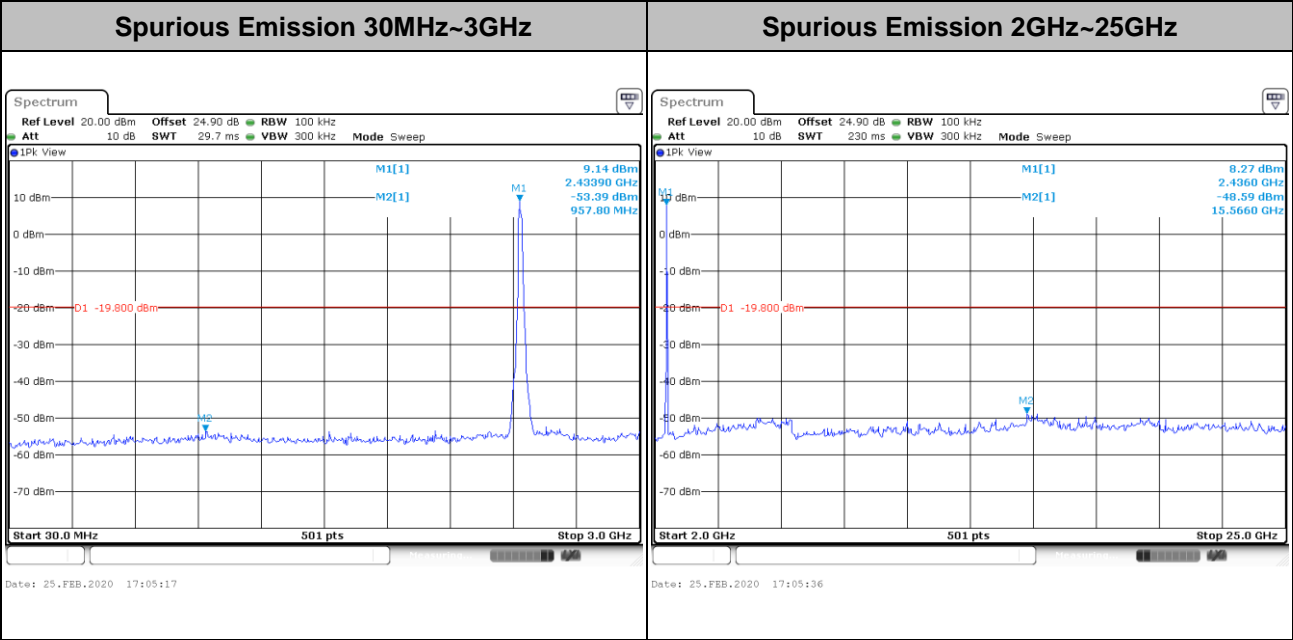
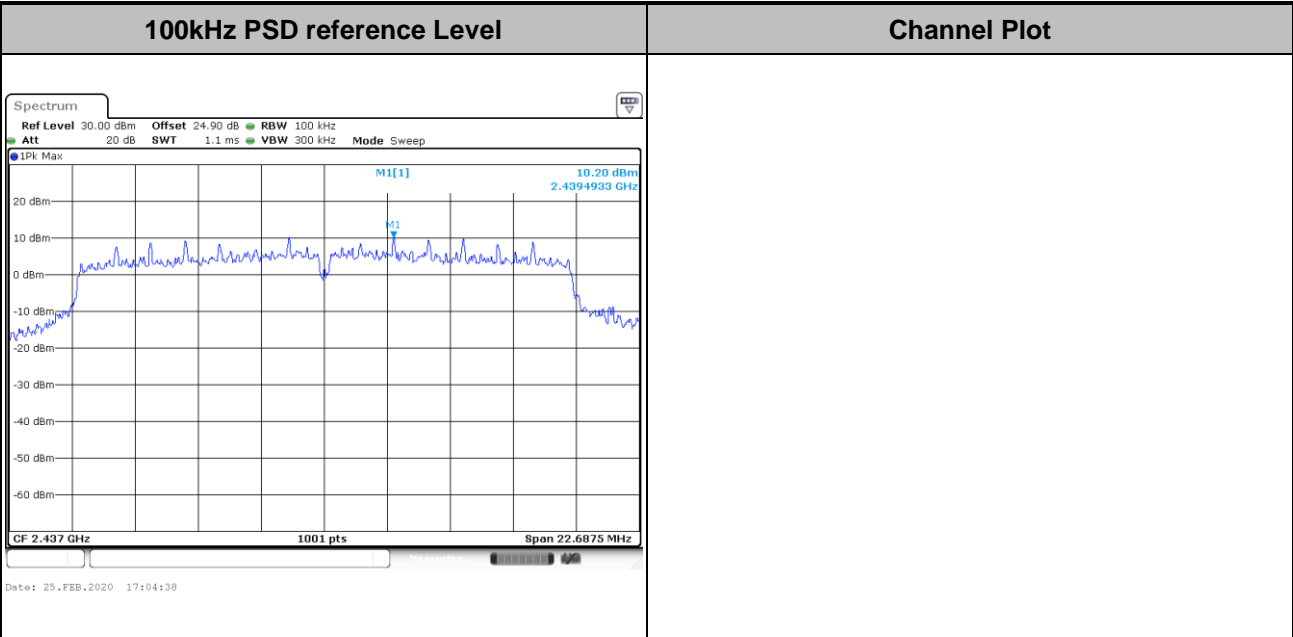



Test Mode :	802.11ac VHT20	Test Channel :	11
-------------	----------------	----------------	----

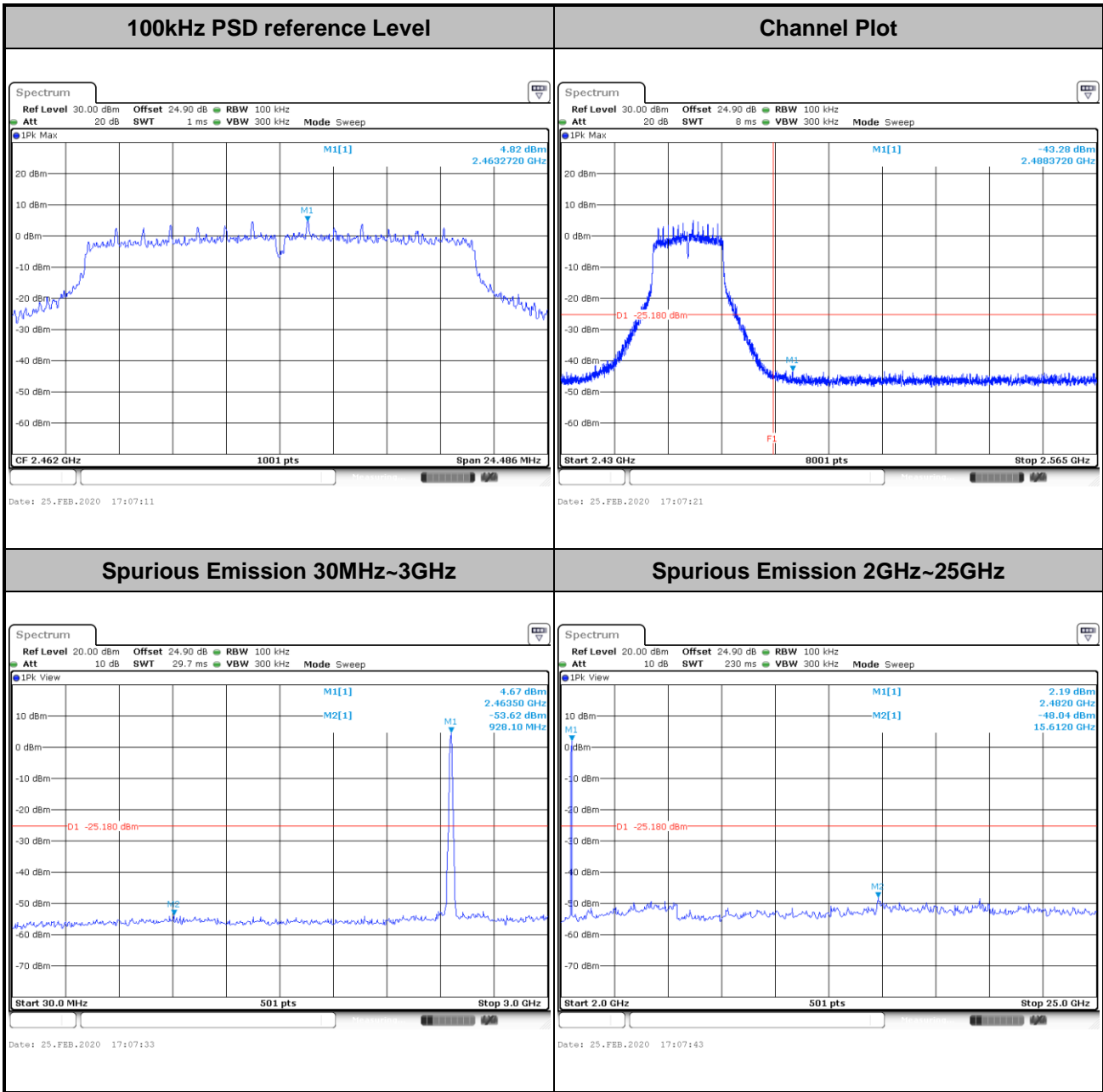



Test Mode :	802.11ac VHT40	Test Channel :	03
-------------	----------------	----------------	----

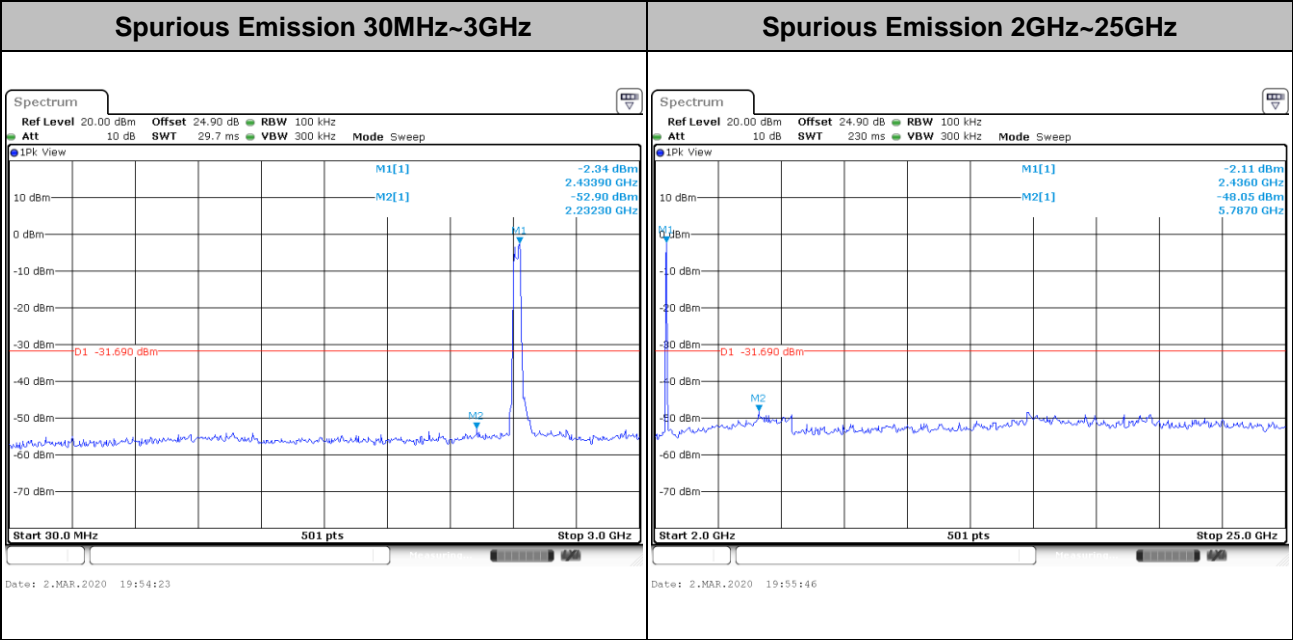
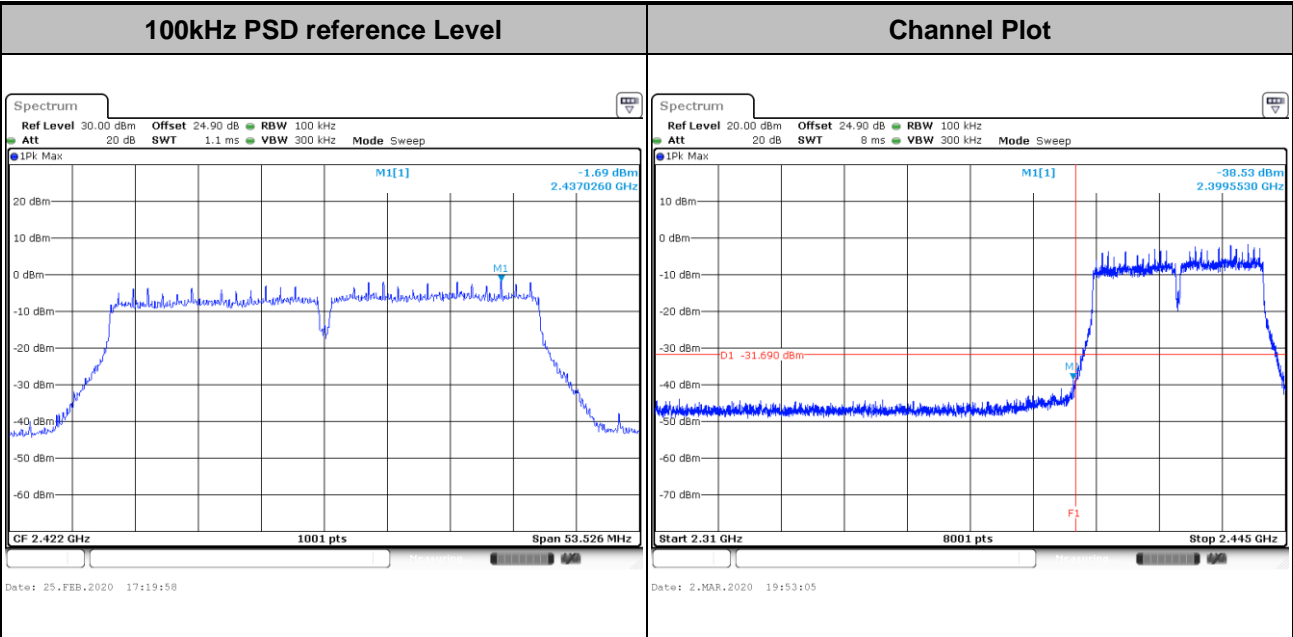



Test Mode :	802.11ac VHT40	Test Channel :	06
-------------	----------------	----------------	----

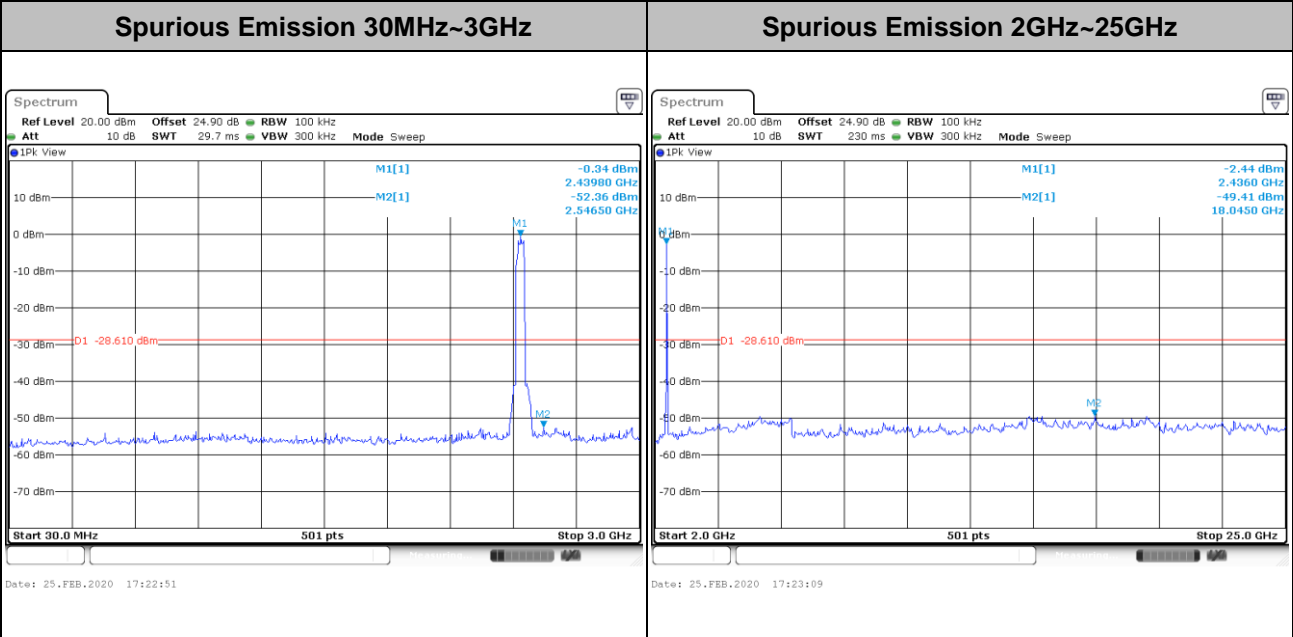
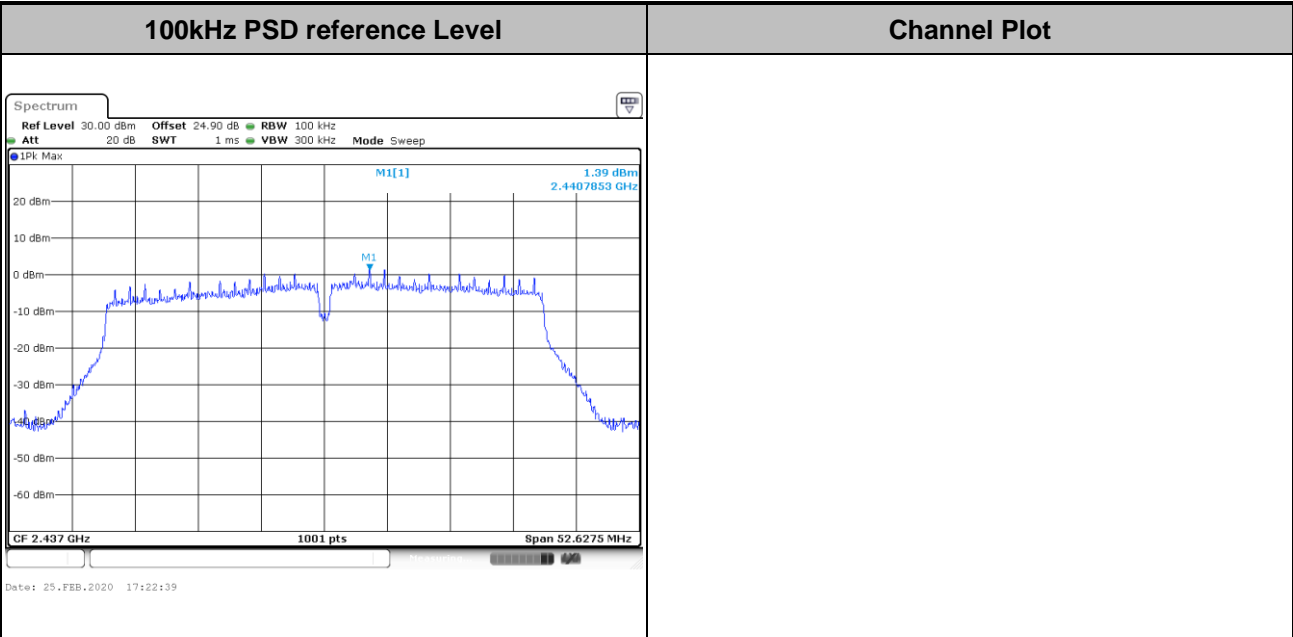



Test Mode : 802.11ac VHT40 Test Channel : 09

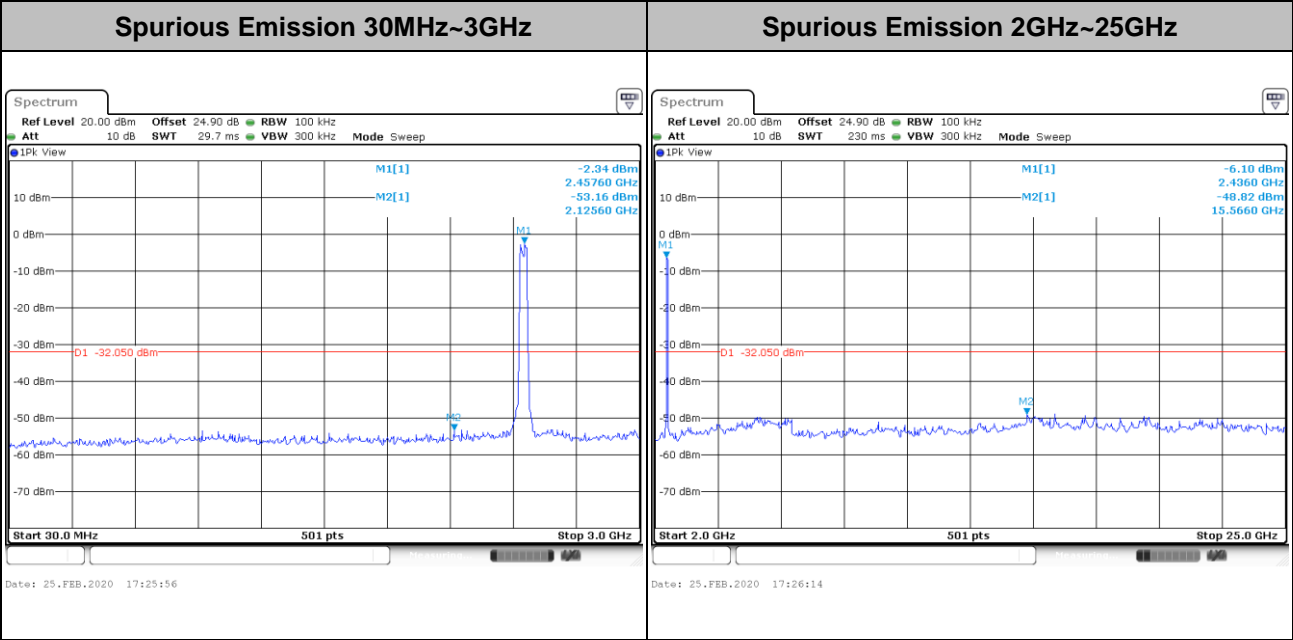
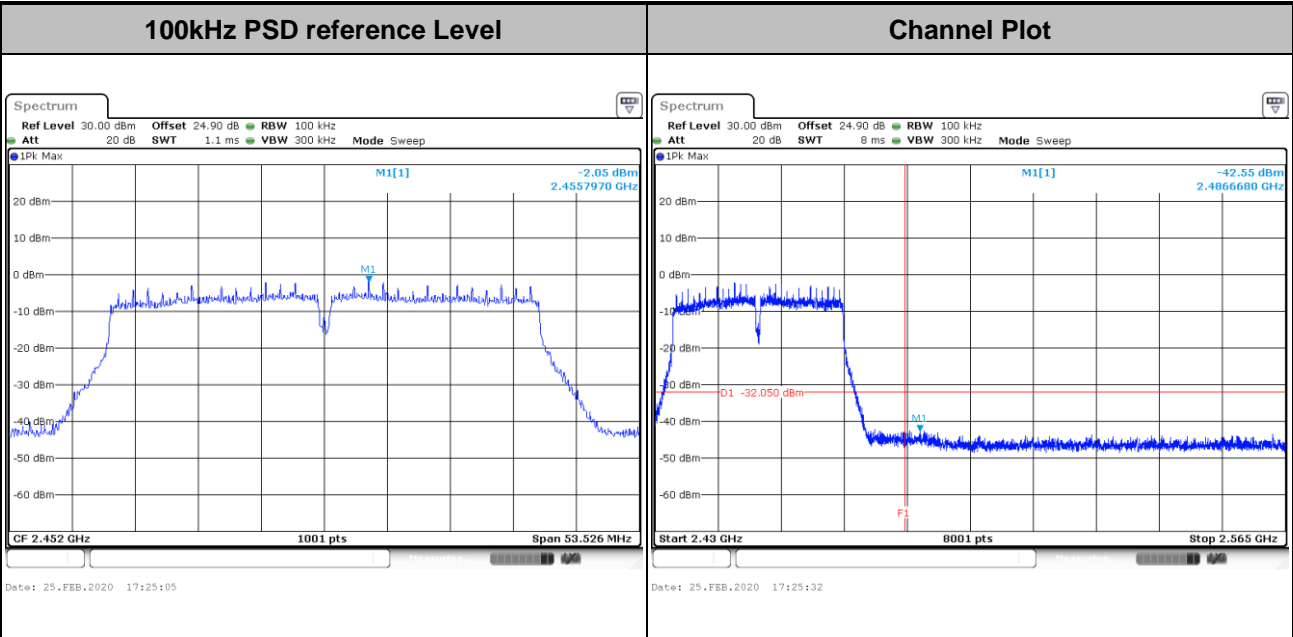



3.5 Radiated Band Edges and Spurious Emission Measurement

3.5.1 Limit of Radiated band edge and Spurious Emission Measurement

In any 100 kHz bandwidth outside the intentional radiator frequency band, all harmonics/spurious must be at least 20 dB below the highest emission level within the authorized band. If the output power of this device was measured by spectrum analyzer, the attenuation under this paragraph shall be 30 dB instead of 20 dB. In addition, radiated emissions which fall in the restricted bands must also comply with the limits as below.

Frequency (MHz)	Field Strength (microvolts/meter)	Measurement Distance (meters)
0.009 – 0.490	2400/F(kHz)	300
0.490 – 1.705	24000/F(kHz)	30
1.705 – 30.0	30	30
30 – 88	100	3
88 – 216	150	3
216 - 960	200	3
Above 960	500	3

3.5.2 Measuring Instruments

See list of measuring equipment of this test report.



3.5.3 Test Procedures

1. The testing follows the ANSI C63.10 Section 11.12.1 Radiated emission measurements.
2. The EUT was arranged to its worst case and then tune the antenna tower (from 1 m to 4 m) and turntable (from 0 degree to 360 degrees) to find the maximum reading. A pre-amp and a high pass filter are used for the test in order to get better signal level.
3. The EUT was placed on a turntable with 0.8 meter for frequency below 1GHz and 1.5 meter for frequency above 1GHz respectively above ground.
4. The EUT was set 3 meters from the interference receiving antenna, which was mounted on the top of a variable height antenna tower.
5. Corrected Reading: Antenna Factor + Cable Loss + Read Level - Preamp Factor = Level
6. For testing below 1GHz, if the emission level of the EUT in peak mode was 3 dB lower than the limit specified, then peak values of EUT will be reported, otherwise, the emissions will be repeated one by one using the CISPR quasi-peak method and reported.
7. For testing above 1GHz, the emission level of the EUT in peak mode was 20dB lower than average limit (that means the emission level in average mode also complies with the limit in average mode), then peak values of EUT will be reported, otherwise, the emissions will be measured in average mode again and reported.
8. Use the following spectrum analyzer settings:
 - (1) Span shall wide enough to fully capture the emission being measured;
 - (2) Set RBW=100 kHz for $f < 1$ GHz; $VBW \geq RBW$; Sweep = auto; Detector function = peak; Trace = max hold;
 - (3) Set RBW = 1 MHz, VBW= 3MHz for $f \geq 1$ GHz for peak measurement.
For average measurement:
 - $VBW = 10$ Hz, when duty cycle is no less than 98 percent.
 - $VBW \geq 1/T$, when duty cycle is less than 98 percent where T is the minimum transmission duration over which the transmitter is on and is transmitting at its maximum power control level for the tested mode of operation.

3.5.4 Test Setup

For radiated emissions below 30MHz

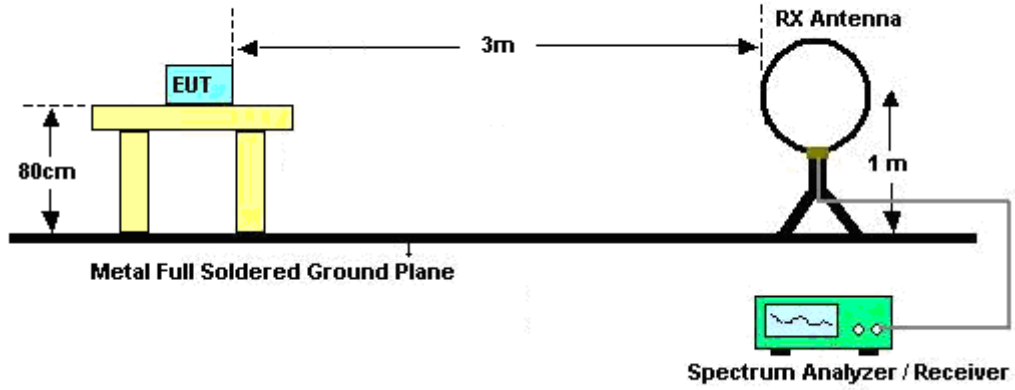

For radiated emissions from 30MHz to 1GHz

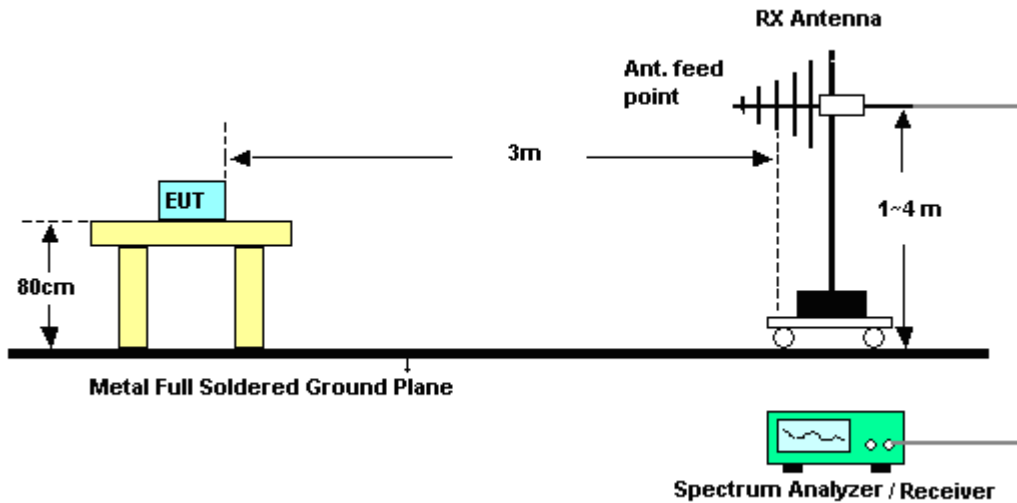

For radiated emissions above 1GHz

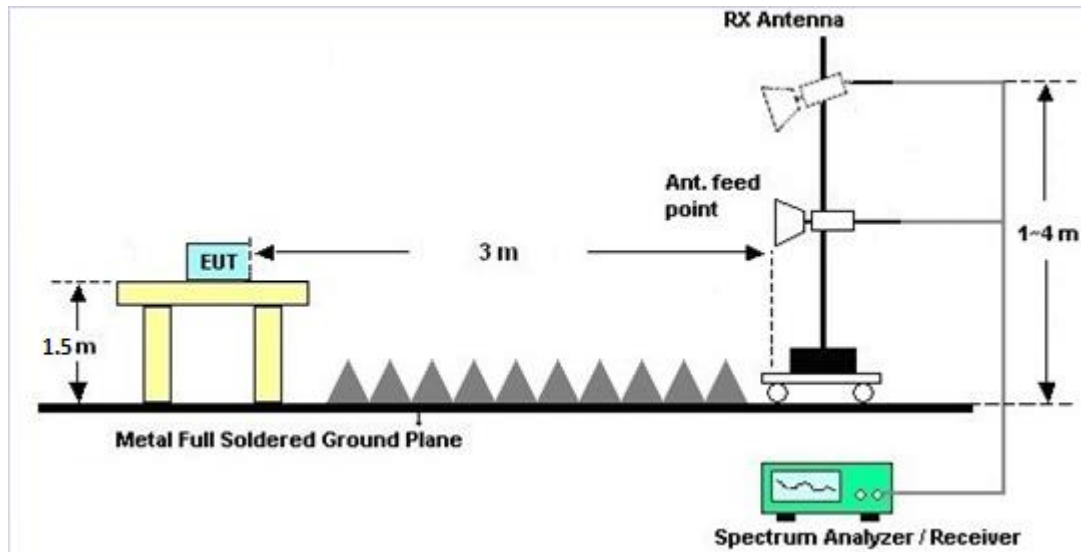

3.5.5 Test Results of Radiated Spurious Emissions (9 kHz ~ 30 MHz)

The low frequency, which started from 9 kHz to 30MHz, was pre-scanned and the result which was 20dB lower than the limit line was not reported.

There is a comparison data of both open-field test site and alternative test site - semi-Anechoic chamber according to 414788 D01 Radiated Test Site v01r01, and the result came out very similar.

3.5.6 Test Result of Radiated Spurious at Band Edges

Please refer to Appendix B and C.

3.5.7 Duty Cycle

Please refer to Appendix D.

3.5.8 Test Result of Radiated Spurious Emission (30MHz ~ 10th Harmonic)

Please refer to Appendix B and C.

3.6 AC Conducted Emission Measurement

3.6.1 Limit of AC Conducted Emission

For equipment that is designed to be connected to the public utility (AC) power line, the radio frequency voltage that is conducted back onto the AC power line on any frequency or frequencies within the band 150 kHz to 30 MHz shall not exceed the limits in the following table.

Frequency of Emission (MHz)	Conducted Limit (dB μ V)	
	Quasi-Peak	Average
0.15-0.5	66 to 56*	56 to 46*
0.5-5	56	46
5-30	60	50

*Decreases with the logarithm of the frequency.

3.6.2 Measuring Instruments

See list of measuring equipment of this test report.

3.6.3 Test Procedures

1. The EUT was placed 0.4 meter from the conducting wall of the shielding room, and it was kept at least 80 centimeters from any other grounded conducting surface.
2. Connect EUT to the power mains through a line impedance stabilization network (LISN).
3. All the support units are connecting to the other LISN.
4. The LISN provides 50 ohm coupling impedance for the measuring instrument.
5. The FCC states that a 50 ohm, 50 microhenry LISN should be used.
6. Both sides of AC line were checked for maximum conducted interference.
7. The frequency range from 150 kHz to 30 MHz was searched.
8. Set the test-receiver system to Peak Detect Function and specified bandwidth (IF bandwidth = 9kHz) with Maximum Hold Mode.

3.6.4 Test Setup



3.6.5 Test Result of AC Conducted Emission

Please refer to Appendix A.



3.7 Antenna Requirements

3.7.1 Standard Applicable

If directional gain of transmitting Antennas is greater than 6dBi, the power shall be reduced by the same level in dB comparing to gain minus 6dBi. The use of a permanently attached Antenna or of an Antenna that uses a unique coupling to the intentional radiator shall be considered sufficient to comply with the rule.

3.7.2 Antenna Anti-Replacement Construction

An embedded-in antenna design is used.

3.7.3 Antenna Gain

The antenna peak gain of EUT is less than 6 dBi. Therefore, it is not necessary to reduce maximum peak output power limit.



4 List of Measuring Equipment

Instrument	Manufacturer	Model No.	Serial No.	Characteristics	Calibration Date	Test Date	Due Date	Remark
Hygrometer	Testo	608-H2	41410069	N/A	Jun. 17, 2019	Jan. 22, 2020~ Mar. 02, 2020	Jun. 16, 2020	Conducted (TH05-HY)
Power Sensor	DARE	RPR3006W	16I00054S NO10	10MHz~6GHz	Dec. 23, 2019	Jan. 22, 2020~ Mar. 02, 2020	Dec. 22, 2020	Conducted (TH05-HY)
Signal Analyzer	Rohde & Schwarz	FSV40	101566	10Hz~40GHz	Jul. 15, 2019	Jan. 22, 2020~ Mar. 02, 2020	Jul. 14, 2020	Conducted (TH05-HY)
Spectrum Analyzer	Rohde & Schwarz	FSP40	100055	9kHz-40GHz	Aug. 14, 2019	Jan. 22, 2020~ Mar. 02, 2020	Aug. 13, 2020	Conducted (TH05-HY)
Switch Box & RF Cable	Burgeon	ETF-058	EC120838 2	N/A	Mar. 27, 2019	Jan. 22, 2020~ Mar. 02, 2020	Mar. 26, 2020	Conducted (TH05-HY)
AC Power Source	ChainTek	APC-1000W	N/A	N/A	N/A	Feb. 14, 2020	N/A	Conduction (CO05-HY)
EMI Test Receiver	Rohde & Schwarz	ESR3	102388	9kHz~3.6GHz	Nov. 15, 2019	Feb. 14, 2020	Nov. 14, 2020	Conduction (CO05-HY)
Hygrometer	Testo	608-H1	34913912	N/A	Mar. 19, 2019	Feb. 14, 2020	Mar. 18, 2020	Conduction (CO05-HY)
LISN	Rohde & Schwarz	ENV216	100080	9kHz~30MHz	Nov. 20, 2019	Feb. 14, 2020	Nov. 19, 2020	Conduction (CO05-HY)
Software	Rohde & Schwarz	EMC32 V10.30	N/A	N/A	N/A	Feb. 14, 2020	N/A	Conduction (CO05-HY)
LF Cable	HUBER + SUHNER	RG-214/U	LF01	N/A	Jan. 02, 2020	Feb. 14, 2020	Jan. 01, 2021	Conduction (CO05-HY)
Pulse Limiter	Rohde & Schwarz	ESH3-Z2	100851	N/A	Jan. 02, 2020	Feb. 14, 2020	Jan. 01, 2021	Conduction (CO05-HY)
Loop Antenna	Rohde & Schwarz	HFH2-Z2	100488	9 kHz~30 MHz	Dec. 26, 2019	Jan. 30, 2020~ Feb. 29, 2020	Dec. 25, 2020	Radiation (03CH16-HY)
Bilog Antenna	TESEQ	CBL6111D&0 0802N1D01N- 06	47020&06	30MHz to 1GHz	Oct. 13, 2019	Jan. 30, 2020~ Feb. 29, 2020	Oct. 12, 2020	Radiation (03CH16-HY)
Horn Antenna	SCHWARZBE CK	BBHA 9120 D	9120D-152 2	1G~18GHz	Sep. 19, 2019	Jan. 30, 2020~ Feb. 29, 2020	Sep. 18, 2020	Radiation (03CH16-HY)
SHF-EHF Horn Antenna	SCHWARZBE CK	BBHA 9170	BBHA9170 576	18GHz~40GHz	May 14, 2019	Jan. 30, 2020~ Feb. 29, 2020	May 13, 2020	Radiation (03CH16-HY)
Amplifier	SONOMA	310N	371607	9kHz~1000MHz	Oct. 01, 2019	Jan. 30, 2020~ Feb. 29, 2020	Sep. 30, 2020	Radiation (03CH16-HY)
Preamplifier	Keysight	83017A	MY532702 64	1GHz~26.5GHz	Dec. 11, 2019	Jan. 30, 2020~ Feb. 29, 2020	Dec.10, 2020	Radiation (03CH16-HY)
Preamplifier	Jet-Power	JPA0118-55-3 03	171000180 0054001	1GHz~18GHz	May 19, 2019	Jan. 30, 2020~ Feb. 29, 2020	May 18, 2020	Radiation (03CH16-HY)
Preamplifier	EMEC	EM18G40G	060715	18GHz~40GHz	Dec. 13, 2019	Jan. 30, 2020~ Feb. 29, 2020	Dec. 12, 2020	Radiation (03CH16-HY)
EMI Test Receiver	Keysight	N9038A(MXE)	MY572901 11	3Hz~26.5GHz	Dec. 05, 2019	Jan. 30, 2020~ Feb. 29, 2020	Dec. 04, 2020	Radiation (03CH16-HY)
Spectrum Analyzer	Agilent	E4446A	MY501801 36	3Hz~44GHz	Apr. 29, 2019	Jan. 30, 2020~ Feb. 29, 2020	Apr. 28, 2020	Radiation (03CH16-HY)
RF Cable	HUBER + SUHNER	SUCOFLEX 104	MY11680/ 4PE	NA	Aug. 30, 2019	Jan. 30, 2020~ Feb. 29, 2020	Aug. 29, 2020	Radiation (03CH16-HY)
RF Cable	HUBER + SUHNER	SUCOFLEX 104	MY11688/ 4PE	NA	Aug. 30, 2019	Jan. 30, 2020~ Feb. 29, 2020	Aug. 29, 2020	Radiation (03CH16-HY)
RF Cable	HUBER + SUHNER	SUCOFLEX 102	EC-A5-300 -5757	NA	Aug. 30, 2019	Jan. 30, 2020~ Feb. 29, 2020	Aug. 29, 2020	Radiation (03CH16-HY)
Hygrometer	TECPEL	DTM-303B	TP161243	N/A	Jun. 17, 2019	Jan. 30, 2020~ Feb. 29, 2020	Jun. 16, 2020	Radiation (03CH16-HY)
Software	Audix	E3 6.2009-8-24	RK-001136	N/A	N/A	Jan. 30, 2020~ Feb. 29, 2020	N/A	Radiation (03CH16-HY)



5 Uncertainty of Evaluation

Uncertainty of Conducted Emission Measurement (150kHz ~ 30MHz)

Measuring Uncertainty for a Level of Confidence of 95% ($U = 2Uc(y)$)	2.0
---	-----

Uncertainty of Radiated Emission Measurement (30 MHz ~ 1000 MHz)

Measuring Uncertainty for a Level of Confidence of 95% ($U = 2Uc(y)$)	4.9
---	-----

Uncertainty of Radiated Emission Measurement (1000 MHz ~ 18000 MHz)

Measuring Uncertainty for a Level of Confidence of 95% ($U = 2Uc(y)$)	6.7
---	-----

Uncertainty of Radiated Emission Measurement (18000 MHz ~ 40000 MHz)

Measuring Uncertainty for a Level of Confidence of 95% ($U = 2Uc(y)$)	3.9
---	-----



Appendix A. AC Conducted Emission Test Results

Test Engineer :	Tom Lee	Temperature :	21~25°C
		Relative Humidity :	41~52%
Test Voltage :	120Vac / 60Hz	Phase :	Line

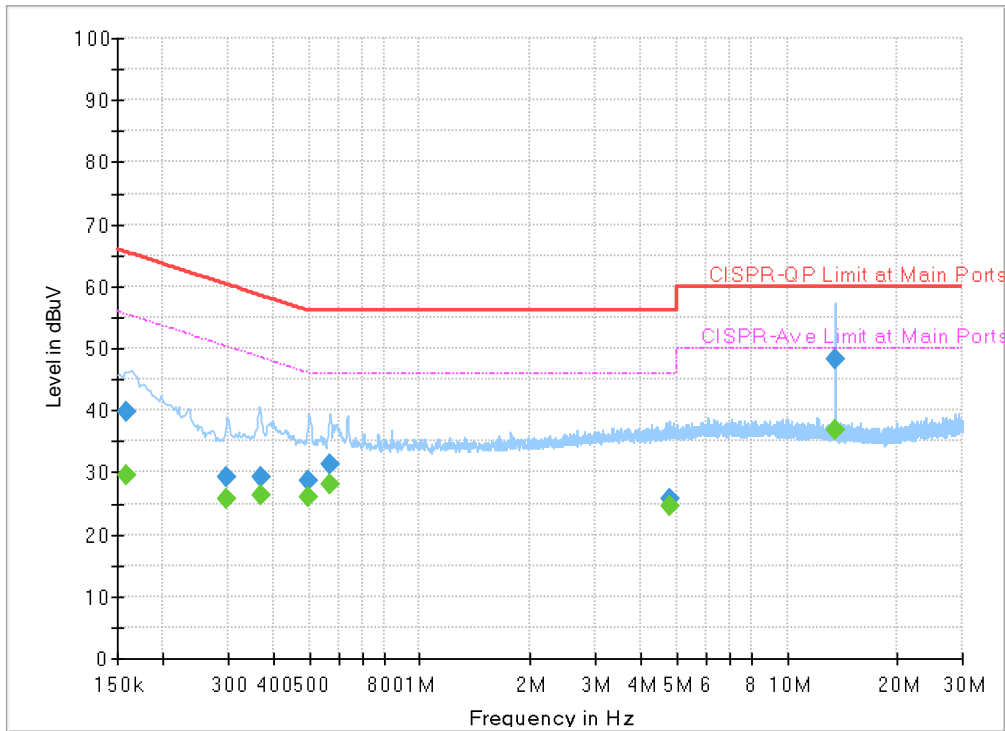

Final Result :

Frequency (MHz)	QuasiPeak (dBuV)	CAverage (dBuV)	Limit (dBuV)	Margin (dB)	Line	Filter	Corr. (dB)
0.159540	---	29.50	55.49	25.99	L1	OFF	19.5
0.159540	39.63	---	65.49	25.86	L1	OFF	19.5
0.297150	---	25.84	50.32	24.48	L1	OFF	19.5
0.297150	29.13	---	60.32	31.19	L1	OFF	19.5
0.369420	---	26.24	48.51	22.27	L1	OFF	19.5
0.369420	29.20	---	58.51	29.31	L1	OFF	19.5
0.498120	---	25.93	46.03	20.10	L1	OFF	19.5
0.498120	28.69	---	56.03	27.34	L1	OFF	19.5
0.569850	---	27.97	46.00	18.03	L1	OFF	19.5
0.569850	31.34	---	56.00	24.66	L1	OFF	19.5
4.776000	---	24.65	46.00	21.35	L1	OFF	19.7
4.776000	25.69	---	56.00	30.31	L1	OFF	19.7
13.560000	---	36.91	50.00	13.09	L1	OFF	20.1
13.560000	48.11	---	60.00	11.89	L1	OFF	20.1



Test Engineer :	Tom Lee	Temperature :	21~25°C
		Relative Humidity :	41~52%
Test Voltage :	120Vac / 60Hz	Phase :	Neutral

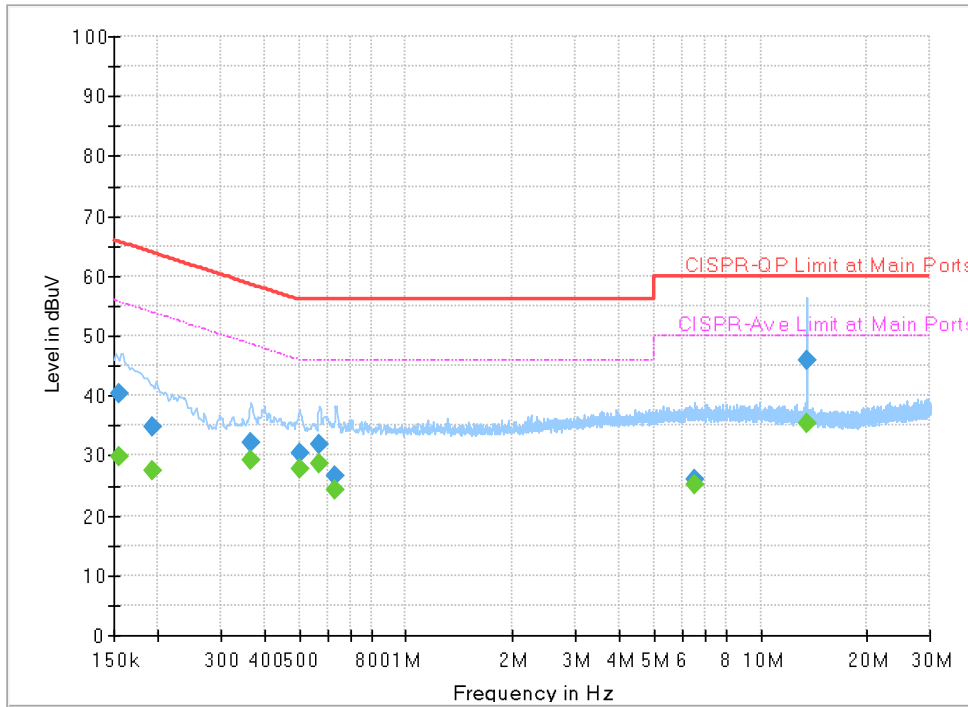

Final Result :

Frequency (MHz)	QuasiPeak (dBuV)	CAverage (dBuV)	Limit (dBuV)	Margin (dB)	Line	Filter	Corr. (dB)
0.155400	---	29.77	55.71	25.94	N	OFF	19.6
0.155400	40.47	---	65.71	25.24	N	OFF	19.6
0.192750	---	27.38	53.92	26.54	N	OFF	19.6
0.192750	34.90	---	63.92	29.02	N	OFF	19.6
0.364740	---	29.20	48.62	19.42	N	OFF	19.6
0.364740	32.15	---	58.62	26.47	N	OFF	19.6
0.501990	---	27.72	46.00	18.28	N	OFF	19.6
0.501990	30.33	---	56.00	25.67	N	OFF	19.6
0.567960	---	28.71	46.00	17.29	N	OFF	19.6
0.567960	31.92	---	56.00	24.08	N	OFF	19.6
0.627900	---	24.36	46.00	21.64	N	OFF	19.6
0.627900	26.55	---	56.00	29.45	N	OFF	19.6
6.547380	---	25.17	50.00	24.83	N	OFF	19.9
6.547380	25.96	---	60.00	34.04	N	OFF	19.9
13.560000	---	35.44	50.00	14.56	N	OFF	20.1
13.560000	45.79	---	60.00	14.21	N	OFF	20.1



Appendix B. Radiated Spurious Emission

Test Engineer :	Jacky Hung, Andy Yang, and CR Liro	Temperature :	20~25°C
		Relative Humidity :	50~60%

<Sample 1 with Battery 1>

2.4GHz 2400~2483.5MHz

WIFI 802.11b (Band Edge @ 3m)

WIFI Ant. 1	Note	Frequency (MHz)	Level (dBμV/m)	Over Limit (dB)	Limit Line (dBμV/m)	Read Level (dBμV)	Antenna Factor (dB/m)	Path Loss (dB)	Preamp Factor (dB)	Ant Pos (cm)	Table Pos (deg)	Peak Avg. (P/A)	Pol. (H/V)	
802.11b CH 01 2412MHz		2387.175	60.12	-13.88	74	44.16	27.65	18.09	29.78	104	299	P	H	
		2387.805	52.96	-1.04	54	37	27.65	18.09	29.78	104	299	A	H	
	*	2412	109.54	-	-	93.6	27.6	18.13	29.79	104	299	P	H	
	*	2412	106.96	-	-	91.02	27.6	18.13	29.79	104	299	A	H	
													H	
														H
			2388.54	58.17	-15.83	74	42.21	27.65	18.09	29.78	397	358	P	V
			2387.805	48.24	-5.76	54	32.28	27.65	18.09	29.78	397	358	A	V
	*		2412	105.5	-	-	89.56	27.6	18.13	29.79	397	358	P	V
	*		2412	102.86	-	-	86.92	27.6	18.13	29.79	397	358	A	V
														V
														V
802.11b CH 06 2437MHz		2339.26	56.33	-17.67	74	40.24	27.84	18.01	29.76	100	299	P	H	
		2388.96	44.47	-9.53	54	28.52	27.64	18.09	29.78	100	299	A	H	
	*	2437	110.39	-	-	94.42	27.6	18.17	29.8	100	299	P	H	
	*	2437	107.95	-	-	91.98	27.6	18.17	29.8	100	299	A	H	
			2487.68	57.54	-16.46	74	41.59	27.52	18.25	29.82	100	299	P	H
			2488.1	46.26	-7.74	54	30.32	27.52	18.25	29.83	100	299	A	H
			2353.54	57.09	-16.91	74	41.04	27.79	18.03	29.77	398	27	P	V
			2361.38	44.3	-9.7	54	28.27	27.75	18.05	29.77	398	27	A	V
	*		2437	107.26	-	-	91.29	27.6	18.17	29.8	398	27	P	V
	*		2437	104.77	-	-	88.8	27.6	18.17	29.8	398	27	A	V
			2491.11	56.53	-17.47	74	40.58	27.52	18.26	29.83	398	27	P	V
			2485.72	44.75	-9.25	54	28.79	27.53	18.25	29.82	398	27	A	V



802.11b CH 11 2462MHz	*	2462	110.45	-	-	94.47	27.58	18.21	29.81	100	79	P	H
	*	2462	108.08	-	-	92.1	27.58	18.21	29.81	100	79	A	H
		2486.04	60.59	-13.41	74	44.63	27.53	18.25	29.82	100	79	P	H
		2487.52	52.1	-1.9	54	36.15	27.52	18.25	29.82	100	79	A	H
													H
													H
	*	2462	106.14	-	-	90.16	27.58	18.21	29.81	341	23	P	V
	*	2462	103.94	-	-	87.96	27.58	18.21	29.81	341	23	A	V
		2486.2	58.45	-15.55	74	42.49	27.53	18.25	29.82	341	23	P	V
		2483.52	48.69	-5.31	54	32.74	27.53	18.24	29.82	341	23	A	V
													V
													V
Remark	1. No other spurious found. 2. All results are PASS against Peak and Average limit line.												



**2.4GHz 2400~2483.5MHz
WIFI 802.11b (Harmonic @ 3m)**

WIFI Ant. 1	Note	Frequency (MHz)	Level (dBµV/m)	Over Limit (dB)	Limit Line (dBµV/m)	Read Level (dBµV)	Antenna Factor (dB/m)	Path Loss (dB)	Preamp Factor (dB)	Ant Pos (cm)	Table Pos (deg)	Peak Avg. (P/A)	Pol. (H/V)
802.11b CH 01 2412MHz		4824	44.37	-29.63	74	58.88	31.15	12.45	58.11	100	0	P	H
													H
		4824	44.37	-29.63	74	58.88	31.15	12.45	58.11	100	0	P	V
													V
802.11b CH 06 2437MHz		4874	38.72	-35.28	74	53.24	31.1	12.5	58.12	100	0	P	H
		7311	42.91	-31.09	74	48.37	36.44	15.6	57.5	100	0	P	H
													H
													H
		4874	39.36	-34.64	74	53.88	31.1	12.5	58.12	100	0	P	V
		7311	42.32	-31.68	74	47.78	36.44	15.6	57.5	100	0	P	V
													V
													V
802.11b CH 11 2462MHz		4924	40.86	-33.14	74	55.36	31.1	12.53	58.13	100	0	P	H
		7386	41.68	-32.32	74	46.95	36.53	15.6	57.4	100	0	P	H
													H
													H
		4924	43.24	-30.76	74	57.74	31.1	12.53	58.13	100	0	P	V
		7386	42.07	-31.93	74	47.34	36.53	15.6	57.4	100	0	P	V
													V
													V
Remark	1. No other spurious found. 2. All results are PASS against Peak and Average limit line.												



**2.4GHz 2400~2483.5MHz
WIFI 802.11g (Band Edge @ 3m)**

WIFI Ant. 1	Note	Frequency (MHz)	Level (dBμV/m)	Over Limit (dB)	Limit Line (dBμV/m)	Read Level (dBμV)	Antenna Factor (dB/m)	Path Loss (dB)	Preamp Factor (dB)	Ant Pos (cm)	Table Pos (deg)	Peak Avg. (P/A)	Pol. (H/V)	
802.11g CH 01 2412MHz		2389.695	63.14	-10.86	74	47.19	27.64	18.09	29.78	100	331	P	H	
		2390	52.86	-1.14	54	36.91	27.64	18.09	29.78	100	331	A	H	
	*	2412	105.03	-	-	89.09	27.6	18.13	29.79	100	331	P	H	
	*	2412	98.15	-	-	82.21	27.6	18.13	29.79	100	331	A	H	
													H	
														H
			2390	60.07	-13.93	74	44.12	27.64	18.09	29.78	400	20	P	V
			2389.905	49.77	-4.23	54	33.82	27.64	18.09	29.78	400	20	A	V
	*		2412	101.32	-	-	85.38	27.6	18.13	29.79	400	20	P	V
	*		2412	94.45	-	-	78.51	27.6	18.13	29.79	400	20	A	V
														V
														V
802.11g CH 06 2437MHz		2329.6	56.28	-17.72	74	40.17	27.88	17.99	29.76	100	300	P	H	
		2389.94	45.87	-8.13	54	29.92	27.64	18.09	29.78	100	300	A	H	
	*	2437	112.34	-	-	96.37	27.6	18.17	29.8	100	300	P	H	
	*	2437	105.01	-	-	89.04	27.6	18.17	29.8	100	300	A	H	
			2484.67	58.45	-15.55	74	42.49	27.53	18.25	29.82	100	300	P	H
			2484.32	48.77	-5.23	54	32.82	27.53	18.24	29.82	100	300	A	H
			2360.68	57.12	-16.88	74	41.08	27.76	18.05	29.77	397	24	P	V
			2352.28	45.57	-8.43	54	29.52	27.79	18.03	29.77	397	24	A	V
	*		2437	108.3	-	-	92.33	27.6	18.17	29.8	397	24	P	V
	*		2437	101.31	-	-	85.34	27.6	18.17	29.8	397	24	A	V
			2485.23	56.37	-17.63	74	40.41	27.53	18.25	29.82	397	24	P	V
			2487.82	46.13	-7.87	54	30.18	27.52	18.25	29.82	397	24	A	V



802.11g CH 11 2462MHz	*	2462	106.84	-	-	90.86	27.58	18.21	29.81	108	331	P	H
	*	2462	99.83	-	-	83.85	27.58	18.21	29.81	108	331	A	H
		2483.8	61.13	-12.87	74	45.18	27.53	18.24	29.82	108	331	P	H
		2483.8	50.95	-3.05	54	35	27.53	18.24	29.82	108	331	A	H
													H
													H
	*	2462	103.7	-	-	87.72	27.58	18.21	29.81	391	23	P	V
	*	2462	96.94	-	-	80.96	27.58	18.21	29.81	391	23	A	V
		2483.96	58.23	-15.77	74	42.28	27.53	18.24	29.82	391	23	P	V
		2483.8	48.73	-5.27	54	32.78	27.53	18.24	29.82	391	23	A	V
													V
													V
Remark	1. No other spurious found. 2. All results are PASS against Peak and Average limit line.												



**2.4GHz 2400~2483.5MHz
WIFI 802.11g (Harmonic @ 3m)**

WIFI Ant. 1	Note	Frequency (MHz)	Level (dBμV/m)	Over Limit (dB)	Limit Line (dBμV/m)	Read Level (dBμV)	Antenna Factor (dB/m)	Path Loss (dB)	Preamp Factor (dB)	Ant Pos (cm)	Table Pos (deg)	Peak Avg. (P/A)	Pol. (H/V)
802.11g CH 01 2412MHz		4824	35.53	-38.47	74	50.06	31.15	12.43	58.11	100	0	P	H
													H
		4824	35.62	-38.38	74	50.15	31.15	12.43	58.11	100	0	P	V
													V
802.11g CH 06 2437MHz		4874	36.33	-37.67	74	50.87	31.1	12.48	58.12	100	0	P	H
		7311	43.14	-30.86	74	48.52	36.44	15.68	57.5	100	0	P	H
													H
													H
		4874	36.3	-37.7	74	50.84	31.1	12.48	58.12	100	0	P	V
		7311	45.24	-28.76	74	50.62	36.44	15.68	57.5	100	0	P	V
													V
													V
802.11g CH 11 2462MHz		4924	35.05	-38.95	74	49.56	31.1	12.52	58.13	100	0	P	H
		7386	41.42	-32.58	74	46.63	36.53	15.66	57.4	100	0	P	H
													H
													H
		4924	35.76	-38.24	74	50.27	31.1	12.52	58.13	100	0	P	V
		7386	41.5	-32.5	74	46.71	36.53	15.66	57.4	100	0	P	V
													V
													V
Remark	1. No other spurious found. 2. All results are PASS against Peak and Average limit line.												



2.4GHz 2400~2483.5MHz
WIFI 802.11ac VHT20 (Band Edge @ 3m)

WIFI Ant. 1	Note	Frequency (MHz)	Level (dBμV/m)	Over Limit (dB)	Limit Line (dBμV/m)	Read Level (dBμV)	Antenna Factor (dB/m)	Path Loss (dB)	Preamp Factor (dB)	Ant Pos (cm)	Table Pos (deg)	Peak Avg. (P/A)	Pol. (H/V)	
802.11ac VHT20 CH 01 2412MHz		2389.59	62.57	-11.43	74	46.62	27.64	18.09	29.78	106	291	P	H	
		2390	52.67	-1.33	54	36.72	27.64	18.09	29.78	106	291	A	H	
	*	2412	102.95	-	-	87.01	27.6	18.13	29.79	106	291	P	H	
	*	2412	95.96	-	-	80.02	27.6	18.13	29.79	106	291	A	H	
													H	
														H
			2390	59.83	-14.17	74	43.88	27.64	18.09	29.78	399	18	P	V
			2390	49.14	-4.86	54	33.19	27.64	18.09	29.78	399	18	A	V
		*	2412	100.48	-	-	84.54	27.6	18.13	29.79	399	18	P	V
		*	2412	93.19	-	-	77.25	27.6	18.13	29.79	399	18	A	V
													V	
													V	
802.11ac VHT20 CH 06 2437MHz		2338.28	56.87	-17.13	74	40.77	27.85	18.01	29.76	100	295	P	H	
		2328.9	45.78	-8.22	54	29.67	27.88	17.99	29.76	100	295	A	H	
	*	2437	111.06	-	-	95.09	27.6	18.17	29.8	100	295	P	H	
	*	2437	103.94	-	-	87.97	27.6	18.17	29.8	100	295	A	H	
			2487.33	58.97	-15.03	74	43.01	27.53	18.25	29.82	100	295	P	H
			2487.19	48.78	-5.22	54	32.82	27.53	18.25	29.82	100	295	A	H
			2378.32	56.69	-17.31	74	40.71	27.69	18.07	29.78	399	22	P	V
			2350.88	45.46	-8.54	54	29.4	27.8	18.03	29.77	399	22	A	V
		*	2437	107.89	-	-	91.92	27.6	18.17	29.8	399	22	P	V
		*	2437	100.8	-	-	84.83	27.6	18.17	29.8	399	22	A	V
		2491.6	57.33	-16.67	74	41.38	27.52	18.26	29.83	399	22	P	V	
		2488.38	46.35	-7.65	54	30.41	27.52	18.25	29.83	399	22	A	V	



802.11ac VHT20 CH 11 2462MHz	*	2462	106.81	-	-	90.83	27.58	18.21	29.81	107	295	P	H
	*	2462	99.44	-	-	83.46	27.58	18.21	29.81	107	295	A	H
		2484.6	63.33	-10.67	74	47.37	27.53	18.25	29.82	107	295	P	H
		2483.72	52.68	-1.32	54	36.73	27.53	18.24	29.82	107	295	A	H
													H
													H
	*	2462	104.31	-	-	88.33	27.58	18.21	29.81	389	20	P	V
	*	2462	96.46	-	-	80.48	27.58	18.21	29.81	389	20	A	V
		2484.68	60.45	-13.55	74	44.49	27.53	18.25	29.82	389	20	P	V
		2483.52	49.65	-4.35	54	33.7	27.53	18.24	29.82	389	20	A	V
													V
													V
Remark	1. No other spurious found. 2. All results are PASS against Peak and Average limit line.												



**2.4GHz 2400~2483.5MHz
WIFI 802.11ac VHT20 (Harmonic @ 3m)**

WIFI Ant. 1	Note	Frequency (MHz)	Level (dBµV/m)	Over Limit (dB)	Limit Line (dBµV/m)	Read Level (dBµV)	Antenna Factor (dB/m)	Path Loss (dB)	Preamp Factor (dB)	Ant Pos (cm)	Table Pos (deg)	Peak Avg. (P/A)	Pol. (H/V)
802.11ac VHT20 CH 01 2412MHz		4824	35.59	-38.41	74	50.12	31.15	12.43	58.11	100	0	P	H
													H
		4824	35.28	-38.72	74	49.81	31.15	12.43	58.11	100	0	P	V
													V
802.11ac VHT20 CH 06 2437MHz		4874	35.41	-38.59	74	49.95	31.1	12.48	58.12	100	0	P	H
		7311	42.7	-31.3	74	48.08	36.44	15.68	57.5	100	0	P	H
													H
													H
		4874	35.66	-38.34	74	50.2	31.1	12.48	58.12	100	0	P	V
		7311	42.92	-31.08	74	48.3	36.44	15.68	57.5	100	0	P	V
													V
802.11ac VHT20 CH 11 2462MHz		4924	35.59	-38.41	74	50.1	31.1	12.52	58.13	100	0	P	H
		7386	40.91	-33.09	74	46.12	36.53	15.66	57.4	100	0	P	H
													H
													H
		4924	35.33	-38.67	74	49.84	31.1	12.52	58.13	100	0	P	V
		7386	41.1	-32.9	74	46.31	36.53	15.66	57.4	100	0	P	V
													V
													V
Remark	1. No other spurious found. 2. All results are PASS against Peak and Average limit line.												



**2.4GHz 2400~2483.5MHz
WIFI 802.11ac VHT40 (Band Edge @ 3m)**

WIFI Ant. 1	Note	Frequency (MHz)	Level (dBμV/m)	Over Limit (dB)	Limit Line (dBμV/m)	Read Level (dBμV)	Antenna Factor (dB/m)	Path Loss (dB)	Preamp Factor (dB)	Ant Pos (cm)	Table Pos (deg)	Peak Avg. (P/A)	Pol. (H/V)
802.11ac VHT40 CH 03 2422MHz		2389.94	60.38	-13.62	74	44.43	27.64	18.09	29.78	100	294	P	H
		2389.8	52.08	-1.92	54	36.13	27.64	18.09	29.78	100	294	A	H
	*	2422	101.09	-	-	85.14	27.6	18.15	29.8	100	294	P	H
	*	2422	94.69	-	-	78.74	27.6	18.15	29.8	100	294	A	H
		2483.83	58.55	-15.45	74	42.6	27.53	18.24	29.82	100	294	P	H
		2486.91	48.14	-5.86	54	32.18	27.53	18.25	29.82	100	294	A	H
		2331.14	56.9	-17.1	74	40.78	27.88	18	29.76	398	21	P	V
		2389.94	48.88	-5.12	54	32.93	27.64	18.09	29.78	398	21	A	V
	*	2422	98.4	-	-	82.45	27.6	18.15	29.8	398	21	P	V
	*	2422	91.6	-	-	75.65	27.6	18.15	29.8	398	21	A	V
		2489.5	56.89	-17.11	74	40.95	27.52	18.25	29.83	398	21	P	V
		2487.68	47.09	-6.91	54	31.14	27.52	18.25	29.82	398	21	A	V
802.11ac VHT40 CH 06 2437MHz		2384.76	56.56	-17.44	74	40.6	27.66	18.08	29.78	101	298	P	H
		2389.94	47.48	-6.52	54	31.53	27.64	18.09	29.78	101	298	A	H
	*	2437	104.47	-	-	88.5	27.6	18.17	29.8	101	298	P	H
	*	2437	97.51	-	-	81.54	27.6	18.17	29.8	101	298	A	H
		2487.89	61.53	-12.47	74	45.58	27.52	18.25	29.82	101	298	P	H
		2483.5	51.83	-2.17	54	35.88	27.53	18.24	29.82	101	298	A	H
		2338.98	56.86	-17.14	74	40.77	27.84	18.01	29.76	391	17	P	V
		2387.42	46.77	-7.23	54	30.81	27.65	18.09	29.78	391	17	A	V
	*	2437	101.71	-	-	85.74	27.6	18.17	29.8	391	17	P	V
	*	2437	95.04	-	-	79.07	27.6	18.17	29.8	391	17	A	V
	2485.3	59.03	-14.97	74	43.07	27.53	18.25	29.82	391	17	P	V	
	2486.35	48.79	-5.21	54	32.83	27.53	18.25	29.82	391	17	A	V	



802.11ac VHT40 CH 09 2452MHz		2348.22	57.19	-16.81	74	41.13	27.81	18.02	29.77	108	293	P	H
		2378.6	46.8	-7.2	54	30.82	27.69	18.07	29.78	108	293	A	H
	*	2452	101.7	-	-	85.72	27.6	18.19	29.81	108	293	P	H
	*	2452	93.64	-	-	77.66	27.6	18.19	29.81	108	293	A	H
		2487.89	62.33	-11.67	74	46.38	27.52	18.25	29.82	108	293	P	H
		2488.31	52.77	-1.23	54	36.83	27.52	18.25	29.83	108	293	A	H
		2314.48	57.09	-16.91	74	40.93	27.94	17.97	29.75	387	18	P	V
		2345.28	47.04	-6.96	54	30.97	27.82	18.02	29.77	387	18	A	V
	*	2452	98.11	-	-	82.13	27.6	18.19	29.81	387	18	P	V
	*	2452	91.43	-	-	75.45	27.6	18.19	29.81	387	18	A	V
		2488.24	60.06	-13.94	74	44.12	27.52	18.25	29.83	387	18	P	V
		2487.12	50.86	-3.14	54	34.9	27.53	18.25	29.82	387	18	A	V
Remark	1. No other spurious found. 2. All results are PASS against Peak and Average limit line.												



**2.4GHz 2400~2483.5MHz
WIFI 802.11ac VHT40 (Harmonic @ 3m)**

WIFI Ant. 1	Note	Frequency (MHz)	Level (dBμV/m)	Over Limit (dB)	Limit Line (dBμV/m)	Read Level (dBμV)	Antenna Factor (dB/m)	Path Loss (dB)	Preamp Factor (dB)	Ant Pos (cm)	Table Pos (deg)	Peak Avg. (P/A)	Pol. (H/V)
802.11ac VHT40 CH 03 2422MHz		4844	34.79	-39.21	74	49.28	31.19	12.44	58.12	100	0	P	H
		7266	41.05	-32.95	74	46.6	36.33	15.68	57.56	100	0	P	H
													H
													H
		4844	35.24	-38.76	74	49.73	31.19	12.44	58.12	100	0	P	V
		7266	41.2	-32.8	74	46.75	36.33	15.68	57.56	100	0	P	V
802.11ac VHT40 CH 06 2437MHz		4874	35.24	-38.76	74	49.78	31.1	12.48	58.12	100	0	P	H
		7311	41.1	-32.9	74	46.48	36.44	15.68	57.5	100	0	P	H
													H
													H
		4874	35.48	-38.52	74	50.02	31.1	12.48	58.12	100	0	P	V
		7311	41.57	-32.43	74	46.95	36.44	15.68	57.5	100	0	P	V
802.11ac VHT40 CH 09 2452MHz		4904	36.1	-37.9	74	50.71	31.02	12.5	58.13	100	0	P	H
		7356	41.55	-32.45	74	46.74	36.59	15.66	57.44	100	0	P	H
													H
													H
		4904	34.98	-39.02	74	49.59	31.02	12.5	58.13	100	0	P	V
		7356	42.3	-31.7	74	47.49	36.59	15.66	57.44	100	0	P	V
Remark	1. No other spurious found.												
	2. All results are PASS against Peak and Average limit line.												



Emission below 1GHz
2.4GHz WIFI 802.11b (LF)

WIFI	Note	Frequency	Level	Over	Limit	Read	Antenna	Path	Preamp	Ant	Table	Peak	Pol.	
Ant.				Limit	Line	Level	Factor	Loss	Factor	Pos	Pos	Avg.		
1		(MHz)	(dBμV/m)	(dB)	(dBμV/m)	(dBμV)	(dB/m)	(dB)	(dB)	(cm)	(deg)	(P/A)	(H/V)	
2.4GHz 802.11b LF		82.38	24.6	-15.4	40	41.65	13.74	1.52	32.31	-	-	P	H	
		95.96	31.2	-12.3	43.5	46.51	15.29	1.66	32.26	100	0	P	H	
		287.05	23.39	-22.61	46	33.78	18.98	2.98	32.35	-	-	P	H	
		569.32	28.45	-17.55	46	30.3	26.02	4.1	31.97	-	-	P	H	
		872.93	32.28	-13.72	46	30.21	29.03	5.08	32.04	-	-	P	H	
		964.11	34.84	-19.16	54	29.55	31.09	5.36	31.16	-	-	P	H	
														H
		44.55	33.97	-6.03	40	48.33	16.91	1.1	32.37	100	0	P	V	
		178.41	27.49	-16.01	43.5	42.49	14.97	2.33	32.3	-	-	P	V	
		592.6	28.96	-17.04	46	31.07	25.63	4.19	31.93	-	-	P	V	
		736.16	30.83	-15.17	46	30.52	27.88	4.66	32.23	-	-	P	V	
		893.3	33.57	-12.43	46	31.41	28.98	5.13	31.95	-	-	P	V	
		988.36	34.93	-19.07	54	29.75	30.61	5.45	30.88	-	-	P	V	
														V
													V	
Remark	1. No other spurious found. 2. All results are PASS against limit line.													



<Sample 2 with Battery 1>

2.4GHz 2400~2483.5MHz

WIFI 802.11b (Band Edge @ 3m)

WIFI Ant. 1	Note	Frequency (MHz)	Level (dBμV/m)	Over Limit (dB)	Limit Line (dBμV/m)	Read Level (dBμV)	Antenna Factor (dB/m)	Path Loss (dB)	Preamp Factor (dB)	Ant Pos (cm)	Table Pos (deg)	Peak Avg. (P/A)	Pol. (H/V)	
802.11b CH 01 2412MHz		2388.435	57.86	-16.14	74	41.9	27.65	18.09	29.78	141	74	P	H	
		2387.49	48.7	-5.3	54	32.74	27.65	18.09	29.78	141	74	A	H	
	*	2412	112.13	-	-	96.19	27.6	18.13	29.79	141	74	P	H	
	*	2412	108.88	-	-	92.94	27.6	18.13	29.79	141	74	A	H	
													H	
														H
			2387.385	56.49	-17.51	74	40.53	27.65	18.09	29.78	398	360	P	V
			2387.385	46.31	-7.69	54	30.35	27.65	18.09	29.78	398	360	A	V
	*		2412	108.24	-	-	92.3	27.6	18.13	29.79	398	360	P	V
	*		2412	105.02	-	-	89.08	27.6	18.13	29.79	398	360	A	V
														V
													V	
Remark	1. No other spurious found. 2. All results are PASS against Peak and Average limit line.													

2.4GHz 2400~2483.5MHz

WIFI 802.11b (Harmonic @ 3m)

WIFI Ant. 1	Note	Frequency (MHz)	Level (dBμV/m)	Over Limit (dB)	Limit Line (dBμV/m)	Read Level (dBμV)	Antenna Factor (dB/m)	Path Loss (dB)	Preamp Factor (dB)	Ant Pos (cm)	Table Pos (deg)	Peak Avg. (P/A)	Pol. (H/V)
802.11b CH 01 2412MHz		4824	48.58	-25.42	74	63.09	31.15	12.45	58.11	100	0	P	H
													H
		4824	47.15	-26.85	74	61.66	31.15	12.45	58.11	100	0	P	V
Remark	1. No other spurious found. 2. All results are PASS against Peak and Average limit line.												



Emission below 1GHz
2.4GHz WIFI 802.11b (LF)

WIFI	Note	Frequency	Level	Over	Limit	Read	Antenna	Path	Preamp	Ant	Table	Peak	Pol.	
Ant.				Limit	Line	Level	Factor	Loss	Factor	Pos	Pos	Avg.		
1		(MHz)	(dBμV/m)	(dB)	(dBμV/m)	(dBμV)	(dB/m)	(dB)	(dB)	(cm)	(deg)	(P/A)	(H/V)	
2.4GHz 802.11b LF		94.99	32.27	-11.23	43.5	47.65	15.24	1.65	32.27	-	-	P	H	
		183.26	30.26	-13.24	43.5	45.43	14.78	2.36	32.31	-	-	P	H	
		298.69	23.99	-22.01	46	34.1	19.21	3.04	32.36	-	-	P	H	
		488.81	25.85	-20.15	46	30.47	23.76	3.72	32.1	-	-	P	H	
		563.5	27.9	-18.1	46	29.67	26.14	4.07	31.98	-	-	P	H	
		903.97	35.79	-10.21	46	33.41	29.09	5.16	31.87	100	0	P	H	
														H
														H
			51.34	29.72	-10.28	40	47.4	13.55	1.2	32.43	100	0	P	V
			187.14	31.02	-12.48	43.5	46.2	14.75	2.38	32.31	-	-	P	V
			344.28	21.32	-24.68	46	30.23	20.22	3.16	32.29	-	-	P	V
			435.46	24.86	-21.14	46	30.57	22.89	3.56	32.16	-	-	P	V
			621.7	28.46	-17.54	46	30.33	25.82	4.28	31.97	-	-	P	V
			820.55	32.61	-13.39	46	31.92	28.03	4.94	32.28	-	-	P	V
														V
													V	
Remark	1. No other spurious found. 2. All results are PASS against limit line.													



<Sample 1 with Battery 2>

2.4GHz 2400~2483.5MHz

WIFI 802.11b (Band Edge @ 3m)

WIFI Ant. 1	Note	Frequency (MHz)	Level (dBμV/m)	Over Limit (dB)	Limit Line (dBμV/m)	Read Level (dBμV)	Antenna Factor (dB/m)	Path Loss (dB)	Preamp Factor (dB)	Ant Pos (cm)	Table Pos (deg)	Peak Avg. (P/A)	Pol. (H/V)	
802.11b CH 01 2412MHz		2388.015	59.53	-14.47	74	43.57	27.65	18.09	29.78	143	76	P	H	
		2388.015	52.77	-1.23	54	36.81	27.65	18.09	29.78	143	76	A	H	
	*	2412	112.31	-	-	96.37	27.6	18.13	29.79	143	76	P	H	
	*	2412	109.19	-	-	93.25	27.6	18.13	29.79	143	76	A	H	
													H	
														H
			2387.595	57.72	-16.28	74	41.76	27.65	18.09	29.78	398	352	P	V
			2387.805	48.82	-5.18	54	32.86	27.65	18.09	29.78	398	352	A	V
	*		2412	107.95	-	-	92.01	27.6	18.13	29.79	398	352	P	V
	*		2412	104.8	-	-	88.86	27.6	18.13	29.79	398	352	A	V
														V
														V
Remark	1. No other spurious found. 2. All results are PASS against Peak and Average limit line.													

2.4GHz 2400~2483.5MHz

WIFI 802.11b (Harmonic @ 3m)

WIFI Ant. 1	Note	Frequency (MHz)	Level (dBμV/m)	Over Limit (dB)	Limit Line (dBμV/m)	Read Level (dBμV)	Antenna Factor (dB/m)	Path Loss (dB)	Preamp Factor (dB)	Ant Pos (cm)	Table Pos (deg)	Peak Avg. (P/A)	Pol. (H/V)	
802.11b CH 01 2412MHz		4824	44.94	-29.06	74	59.45	31.15	12.45	58.11	100	0	P	H	
													H	
													H	
			4824	44.86	-29.14	74	59.37	31.15	12.45	58.11	100	0	P	V
														V
														V
Remark	1. No other spurious found. 2. All results are PASS against Peak and Average limit line.													



Emission below 1GHz
2.4GHz WIFI 802.11b (LF)

WIFI	Note	Frequency	Level	Over	Limit	Read	Antenna	Path	Preamp	Ant	Table	Peak	Pol.	
Ant.				Limit	Line	Level	Factor	Loss	Factor	Pos	Pos	Avg.		
1		(MHz)	(dBμV/m)	(dB)	(dBμV/m)	(dBμV)	(dB/m)	(dB)	(dB)	(cm)	(deg)	(P/A)	(H/V)	
2.4GHz 802.11b LF		95.96	28.32	-15.18	43.5	43.65	15.29	1.64	32.26	-	-	P	H	
		183.26	26.98	-16.52	43.5	42.24	14.78	2.27	32.31	-	-	P	H	
		288.99	23.76	-22.24	46	34.18	19.05	2.89	32.36	-	-	P	H	
		501.42	26.39	-19.61	46	30.82	23.95	3.71	32.09	-	-	P	H	
		705.12	30.03	-15.97	46	31.3	26.46	4.43	32.16	-	-	P	H	
		861.29	32.06	-13.94	46	30.2	29.05	4.9	32.09	100	0	P	H	
														H
														H
			50.37	28.81	-11.19	40	46	14.07	1.17	32.43	-	-	P	V
			187.14	33.73	-9.77	43.5	48.99	14.75	2.3	32.31	100	0	P	V
			389.87	22.26	-23.74	46	29.72	21.43	3.33	32.22	-	-	P	V
			570.29	28.73	-17.27	46	30.69	26	4.01	31.97	-	-	P	V
			755.56	31.41	-14.59	46	31.03	28.06	4.59	32.27	-	-	P	V
			884.57	32.08	-13.92	46	30.08	29.04	4.95	31.99	-	-	P	V
														V
													V	
Remark	1. No other spurious found. 2. All results are PASS against limit line.													



<Sample 1 with Battery 3>

2.4GHz 2400~2483.5MHz

WIFI 802.11b (Band Edge @ 3m)

WIFI Ant. 1	Note	Frequency (MHz)	Level (dBμV/m)	Over Limit (dB)	Limit Line (dBμV/m)	Read Level (dBμV)	Antenna Factor (dB/m)	Path Loss (dB)	Preamp Factor (dB)	Ant Pos (cm)	Table Pos (deg)	Peak Avg. (P/A)	Pol. (H/V)	
802.11b CH 01 2412MHz		2387.91	59.34	-14.66	74	43.38	27.65	18.09	29.78	141	80	P	H	
		2387.91	52.56	-1.44	54	36.6	27.65	18.09	29.78	141	80	A	H	
	*	2412	111.8	-	-	95.86	27.6	18.13	29.79	141	80	P	H	
	*	2412	108.55	-	-	92.61	27.6	18.13	29.79	141	80	A	H	
													H	
			2387.175	57.66	-16.34	74	41.7	27.65	18.09	29.78	397	359	P	V
			2387.805	49.86	-4.14	54	33.9	27.65	18.09	29.78	397	359	A	V
	*		2412	109.29	-	-	93.35	27.6	18.13	29.79	397	359	P	V
	*		2412	106.11	-	-	90.17	27.6	18.13	29.79	397	359	A	V
														V
Remark	1. No other spurious found. 2. All results are PASS against Peak and Average limit line.													

2.4GHz 2400~2483.5MHz

WIFI 802.11b (Harmonic @ 3m)

WIFI Ant. 1	Note	Frequency (MHz)	Level (dBμV/m)	Over Limit (dB)	Limit Line (dBμV/m)	Read Level (dBμV)	Antenna Factor (dB/m)	Path Loss (dB)	Preamp Factor (dB)	Ant Pos (cm)	Table Pos (deg)	Peak Avg. (P/A)	Pol. (H/V)	
802.11b CH 01 2412MHz		4824	43.16	-30.84	74	57.67	31.15	12.45	58.11	100	0	P	H	
		7236	49.42	-24.58	74	55.19	36.24	15.59	57.6	100	0	P	H	
													H	
													H	
			4824	44.87	-29.13	74	59.38	31.15	12.45	58.11	100	0	P	V
			7236	50.9	-23.1	74	56.67	36.24	15.59	57.6	100	0	P	V
														V
														V
Remark	1. No other spurious found. 2. All results are PASS against Peak and Average limit line.													



Emission below 1GHz
2.4GHz WIFI 802.11b (LF)

WIFI	Note	Frequency	Level	Over	Limit	Read	Antenna	Path	Preamp	Ant	Table	Peak	Pol.	
Ant.				Limit	Line	Level	Factor	Loss	Factor	Pos	Pos	Avg.		
1		(MHz)	(dBμV/m)	(dB)	(dBμV/m)	(dBμV)	(dB/m)	(dB)	(dB)	(cm)	(deg)	(P/A)	(H/V)	
2.4GHz 802.11b LF		95.96	32.59	-10.91	43.5	47.9	15.29	1.66	32.26	100	0	P	H	
		183.26	27.07	-16.43	43.5	42.24	14.78	2.36	32.31	-	-	P	H	
		453.89	24.83	-21.17	46	30.12	23.23	3.62	32.14	-	-	P	H	
		578.05	28.81	-17.19	46	30.99	25.66	4.12	31.96	-	-	P	H	
		749.74	30.74	-15.26	46	30.2	28.09	4.71	32.26	-	-	P	H	
		903.97	32.14	-13.86	46	29.76	29.09	5.16	31.87	-	-	P	H	
														H
														H
			50.37	29.35	-10.65	40	46.53	14.07	1.18	32.43	-	-	P	V
			188.11	30.51	-12.99	43.5	45.71	14.73	2.38	32.31	-	-	P	V
			464.56	24.82	-21.18	46	29.88	23.42	3.65	32.13	-	-	P	V
			634.31	29.46	-16.54	46	30.81	26.33	4.32	32	-	-	P	V
			758.47	31.42	-14.58	46	30.87	28.09	4.74	32.28	-	-	P	V
			896.21	35.88	-10.12	46	33.7	28.98	5.14	31.94	100	0	P	V
														V
													V	
Remark	1. No other spurious found. 2. All results are PASS against limit line.													



Note symbol

*	Fundamental Frequency which can be ignored. However, the level of any unwanted emissions shall not exceed the level of the fundamental frequency.
!	Test result is over limit line.
P/A	Peak or Average
H/V	Horizontal or Vertical



A calculation example for radiated spurious emission is shown as below:

WIFI	Note	Frequency	Level	Over	Limit	Read	Antenna	Path	Preamp	Ant	Table	Peak	Pol.
Ant.				Limit	Line	Level	Factor	Loss	Factor	Pos	Pos	Avg.	
1		(MHz)	(dBμV/m)	(dB)	(dBμV/m)	(dBμV)	(dB/m)	(dB)	(dB)	(cm)	(deg)	(P/A)	(H/V)
802.11b		2390	55.45	-18.55	74	54.51	32.22	4.58	35.86	103	308	P	H
CH 01													
2412MHz		2390	43.54	-10.46	54	42.6	32.22	4.58	35.86	103	308	A	H

1. Path Loss(dB) = Cable loss(dB) + Filter loss(dB) + Attenuator loss(dB)
2. Level(dBμV/m) =
Antenna Factor(dB/m) + Path Loss(dB) + Read Level(dBμV) - Preamp Factor(dB)
3. Over Limit(dB) = Level(dBμV/m) – Limit Line(dBμV/m)

For Peak Limit @ 2390MHz:

1. Level(dBμV/m)
= Antenna Factor(dB/m) + Path Loss(dB) + Read Level(dBμV) - Preamp Factor(dB)
= 32.22(dB/m) + 4.58(dB) + 54.51(dBμV) – 35.86 (dB)
= 55.45 (dBμV/m)
2. Over Limit(dB)
= Level(dBμV/m) – Limit Line(dBμV/m)
= 55.45(dBμV/m) – 74(dBμV/m)
= -18.55(dB)

For Average Limit @ 2390MHz:

1. Level(dBμV/m)
= Antenna Factor(dB/m) + Path Loss(dB) + Read Level(dBμV) - Preamp Factor(dB)
= 32.22(dB/m) + 4.58(dB) + 42.6(dBμV) – 35.86 (dB)
= 43.54 (dBμV/m)
2. Over Limit(dB)
= Level(dBμV/m) – Limit Line(dBμV/m)
= 43.54(dBμV/m) – 54(dBμV/m)
= -10.46(dB)

Both peak and average measured complies with the limit line, so test result is “PASS”.



Appendix C. Radiated Spurious Emission Plots

Test Engineer :	Jacky Hung, Andy Yang, and CR Liro	Temperature :	20~25°C
		Relative Humidity :	50~60%

Note symbol

-L	Low channel location
-R	High channel location



<Sample 1 with Battery 1>

2.4GHz 2400~2483.5MHz
WIFI 802.11b (Band Edge @ 3m)

WIFI	2.4GHz 2400~2483.5MHz Band Edge @ 3m	
ANT	802.11b CH01 2412MHz	
1	Horizontal	Fundamental
Peak	<p>Site : 03CH16-HY Condition : PEAK_BE_74 3m 91200_1522 HORIZONTAL Detector : Peak Project : 010732</p>	<p>Site : 03CH16-HY Condition : PEAK_74 3m 91200_1522 HORIZONTAL Detector : Peak Project : 010732</p>
Avg.	<p>Site : 03CH16-HY Condition : AVG_BE_54 3m 91200_1522 HORIZONTAL Detector : Peak Project : 010732</p>	<p>Site : 03CH16-HY Condition : AVG_54 3m 91200_1522 HORIZONTAL Detector : Peak Project : 010732</p>

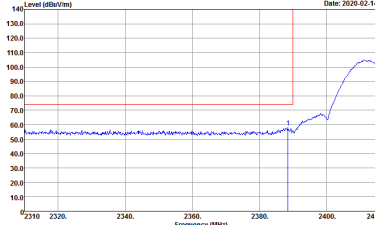
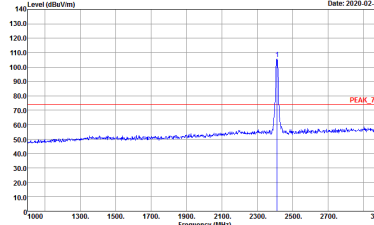
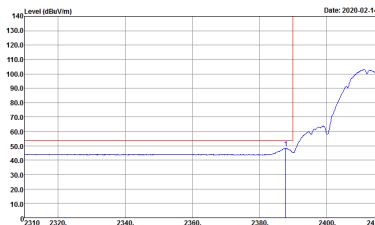
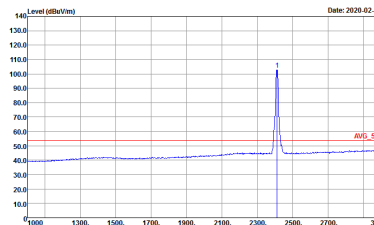

WIFI	2.4GHz 2400~2483.5MHz Band Edge @ 3m	
ANT	802.11b CH01 2412MHz	
1	Vertical	Fundamental
Peak	 <p>Site : 03CH16-HY Condition : PEAK_BE_74 3m 91200_1522 VERTICAL RBW:1000.000KHz VBW:3000.000KHz SWT:Auto Detector : Peak Project : 010732</p>	 <p>Site : 03CH16-HY Condition : PEAK_74 3m 91200_1522 VERTICAL RBW:1000.000KHz VBW:3000.000KHz SWT:Auto Detector : Peak Project : 010732</p>
Avg.	 <p>Site : 03CH16-HY Condition : AVG_BE_54 3m 91200_1522 VERTICAL RBW:1000.000KHz VBW:0.010KHz SWT:Auto Detector : Peak Project : 010732</p>	 <p>Site : 03CH16-HY Condition : AVG_54 3m 91200_1522 VERTICAL RBW:1000.000KHz VBW:0.010KHz SWT:Auto Detector : Peak Project : 010732</p>

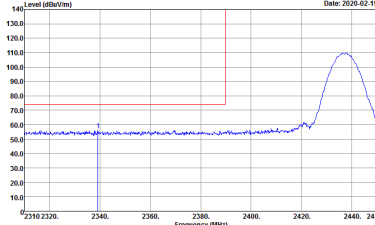
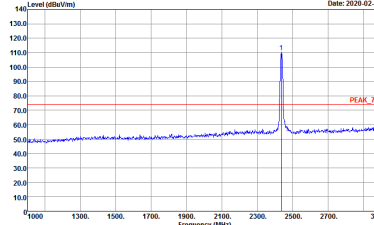
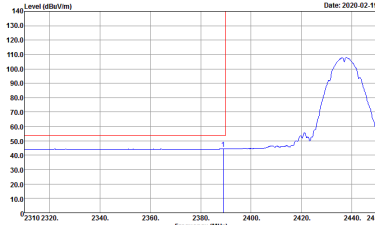
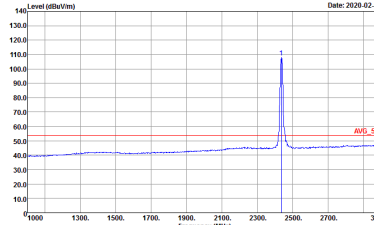

WIFI	2.4GHz 2400~2483.5MHz Band Edge @ 3m	
ANT	802.11b CH06 2437MHz - L	
1	Horizontal	Fundamental
Peak	 <p>Site : 03CH16-HY Condition : PEAK_BE_74 3m 91200_1522 HORIZONTAL RBW:1000.000KHz VBW:3000.000KHz SWT:Auto Detector : Peak Project : 010732</p>	 <p>Site : 03CH16-HY Condition : PEAK_74 3m 91200_1522 HORIZONTAL RBW:1000.000KHz VBW:3000.000KHz SWT:Auto Detector : Peak Project : 010732</p>
Avg.	 <p>Site : 03CH16-HY Condition : AVG_BE_54 3m 91200_1522 HORIZONTAL RBW:1000.000KHz VBW:0.010KHz SWT:Auto Detector : Peak Project : 010732</p>	 <p>Site : 03CH16-HY Condition : AVG_54 3m 91200_1522 HORIZONTAL RBW:1000.000KHz VBW:0.010KHz SWT:Auto Detector : Peak Project : 010732</p>

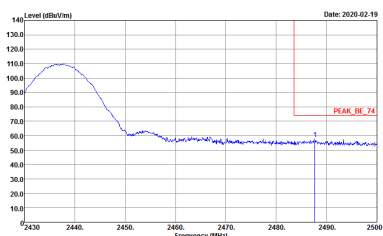
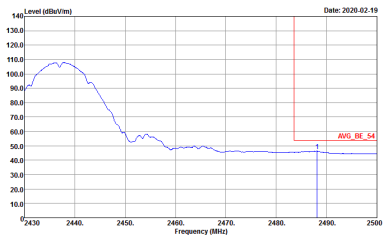

WIFI	2.4GHz 2400~2483.5MHz Band Edge @ 3m	
ANT	802.11b CH06 2437MHz - R	
1	Horizontal	Fundamental
<p>Peak</p>	 <p>Site : 03CH16-HY Condition : PEAK_BE_74 3m 91200_1522 HORIZONTAL RBW:1000.000KHz VBW:3000.000KHz SWF:Auto Detector : Peak Project : 010732</p>	<p>Left blank</p>
<p>Avg.</p>	 <p>Site : 03CH16-HY Condition : AVG_BE_54 3m 91200_1522 HORIZONTAL RBW:1000.000KHz VBW:3000.000KHz SWF:Auto Detector : Peak Project : 010732</p>	<p>Left blank</p>

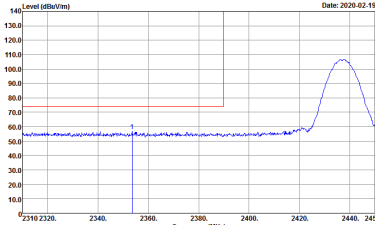
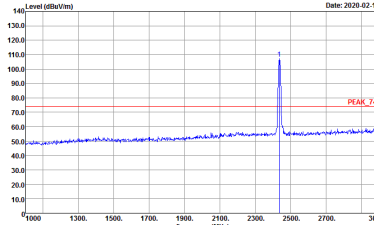
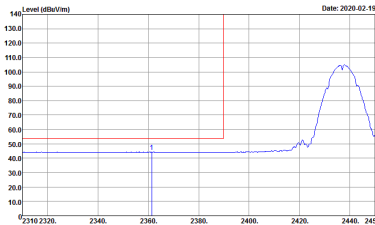
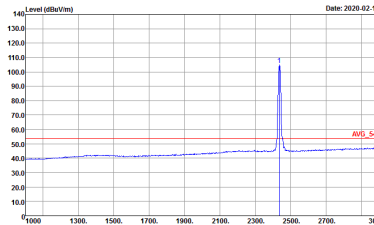

WIFI	2.4GHz 2400~2483.5MHz Band Edge @ 3m	
ANT	802.11b CH06 2437MHz - L	
1	Vertical	Fundamental
Peak	 <p>Site : 03CH16-HY Condition : PEAK_BE_74 3m 91200_1522 VERTICAL RBW:1000.000KHz VBW:3000.000KHz SWT:Auto Detector : Peak Project : 010732</p>	 <p>Site : 03CH16-HY Condition : PEAK_74 3m 91200_1522 VERTICAL RBW:1000.000KHz VBW:3000.000KHz SWT:Auto Detector : Peak Project : 010732</p>
Avg.	 <p>Site : 03CH16-HY Condition : AVG_BE_54 3m 91200_1522 VERTICAL RBW:1000.000KHz VBW:0.010KHz SWT:Auto Detector : Peak Project : 010732</p>	 <p>Site : 03CH16-HY Condition : AVG_54 3m 91200_1522 VERTICAL RBW:1000.000KHz VBW:0.010KHz SWT:Auto Detector : Peak Project : 010732</p>

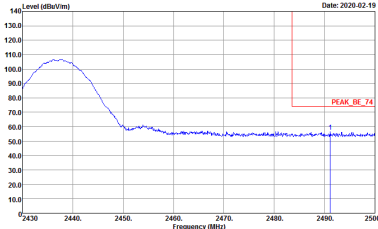
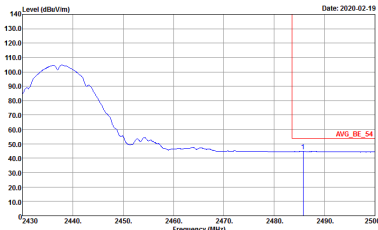

WIFI	2.4GHz 2400~2483.5MHz Band Edge @ 3m	
ANT	802.11b CH06 2437MHz - R	
1	Vertical	Fundamental
<p>Peak</p>	 <p>Site : 03CH16-HY Condition : PEAK_BE_74 3m 91200_1522 VERTICAL RBW:1000.000KHz VBW:3000.000KHz SWF:Auto Detector : Peak Project : 010732</p>	<p>Left blank</p>
<p>Avg.</p>	 <p>Site : 03CH16-HY Condition : AVG_BE_54 3m 91200_1522 VERTICAL RBW:1000.000KHz VBW:0.010KHz SWF:Auto Detector : Peak Project : 010732</p>	<p>Left blank</p>

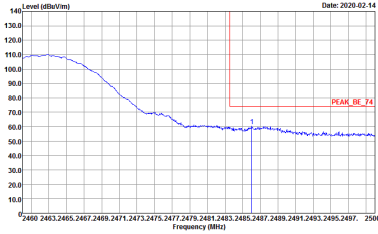
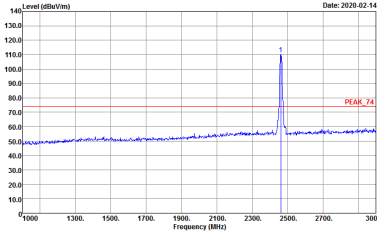
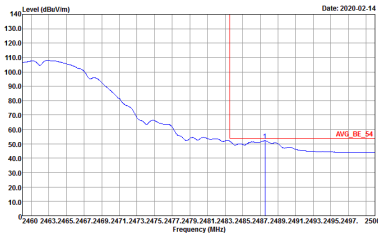
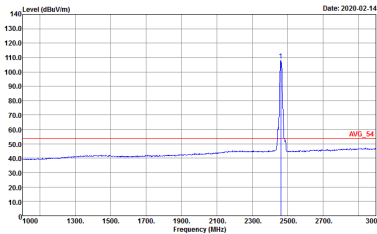

WIFI	2.4GHz 2400~2483.5MHz Band Edge @ 3m	
ANT	802.11b CH11 2462MHz	
1	Horizontal	Fundamental
Peak	 <p>Site : 03CH16-HY Condition : PEAK_BE_74 3m 91200_1522 HORIZONTAL RBW:1000.000KHz VBW:3000.000KHz SWT:Auto Detector : Peak Project : 010732</p>	 <p>Site : 03CH16-HY Condition : PEAK_74 3m 91200_1522 HORIZONTAL RBW:1000.000KHz VBW:3000.000KHz SWT:Auto Detector : Peak Project : 010732</p>
Avg.	 <p>Site : 03CH16-HY Condition : AVG_BE_54 3m 91200_1522 HORIZONTAL RBW:1000.000KHz VBW:0.010KHz SWT:Auto Detector : Peak Project : 010732</p>	 <p>Site : 03CH16-HY Condition : AVG_54 3m 91200_1522 HORIZONTAL RBW:1000.000KHz VBW:0.010KHz SWT:Auto Detector : Peak Project : 010732</p>

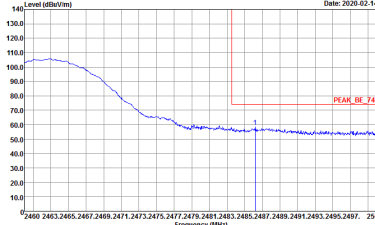
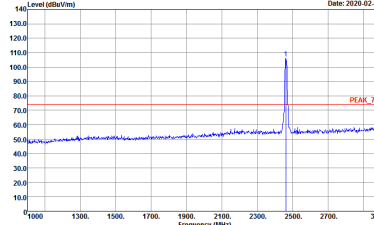
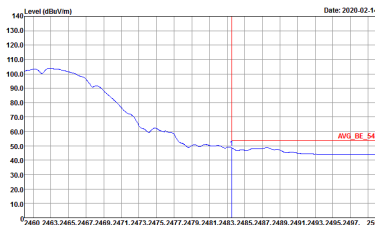
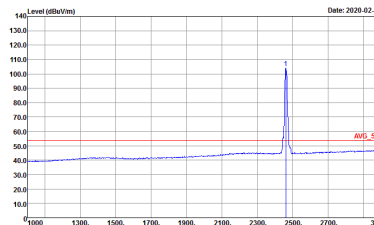

WIFI	2.4GHz 2400~2483.5MHz Band Edge @ 3m	
ANT	802.11b CH11 2462MHz	
1	Vertical	Fundamental
Peak	 <p>Site : 03CH16-HY Condition : PEAK_BE_74 3m 91200_1522 VERTICAL RBW:1000.000KHz VBW:3000.000KHz SWT:Auto Detector : Peak Project : 010732</p>	 <p>Site : 03CH16-HY Condition : PEAK_74 3m 91200_1522 VERTICAL RBW:1000.000KHz VBW:3000.000KHz SWT:Auto Detector : Peak Project : 010732</p>
Avg.	 <p>Site : 03CH16-HY Condition : AVG_BE_54 3m 91200_1522 VERTICAL RBW:1000.000KHz VBW:0.010KHz SWT:Auto Detector : Peak Project : 010732</p>	 <p>Site : 03CH16-HY Condition : AVG_54 3m 91200_1522 VERTICAL RBW:1000.000KHz VBW:0.010KHz SWT:Auto Detector : Peak Project : 010732</p>

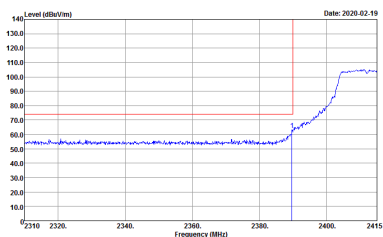
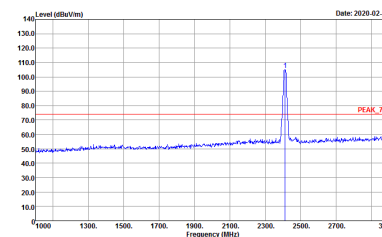
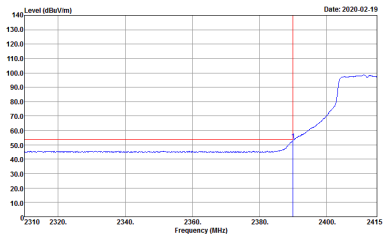
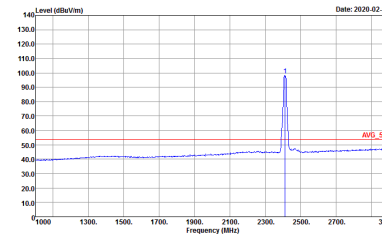

2.4GHz 2400~2483.5MHz
WIFI 802.11g (Band Edge @ 3m)

WIFI	2.4GHz 2400~2483.5MHz Band Edge @ 3m	
ANT	802.11g CH01 2412MHz	
1	Horizontal	Fundamental
Peak	 <p>Site : 03CH16-1HY Condition : PEAK_BE_74 3m 91200_1522 HORIZONTAL Detector : Peak Project : 010732 Setting : 14</p>	 <p>Site : 03CH16-1HY Condition : PEAK_74 3m 91200_1522 HORIZONTAL Detector : Peak Project : 010732 Setting : 14</p>
Avg.	 <p>Site : 03CH16-1HY Condition : AVG_BE_54 3m 91200_1522 HORIZONTAL Detector : Peak Project : 010732 Setting : 14</p>	 <p>Site : 03CH16-1HY Condition : AVG_54 3m 91200_1522 HORIZONTAL Detector : Peak Project : 010732 Setting : 14</p>

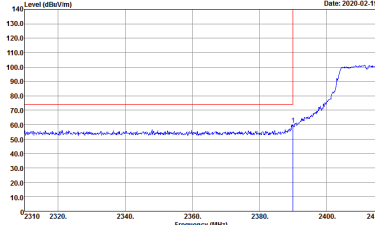
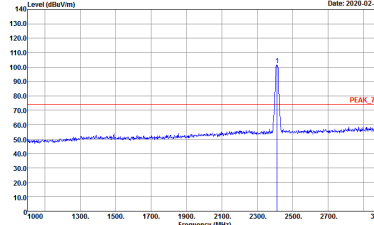
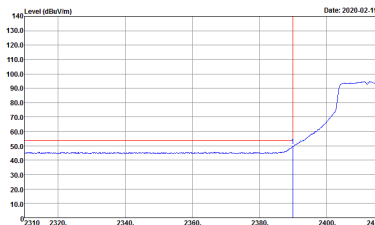
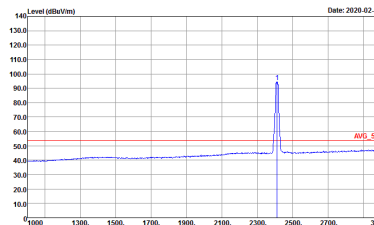

WIFI	2.4GHz 2400~2483.5MHz Band Edge @ 3m	
ANT	802.11g CH01 2412MHz	
1	Vertical	Fundamental
Peak	 <p>Site : 03CH16-HY Condition : PEAK_BE_74 3m 91200_1522 VERTICAL Detector : Peak Project : 010732 Setting : 14</p>	 <p>Site : 03CH16-HY Condition : PEAK_74 3m 91200_1522 VERTICAL Detector : Peak Project : 010732 Setting : 14</p>
Avg.	 <p>Site : 03CH16-HY Condition : AVG_BE_54 3m 91200_1522 VERTICAL Detector : Peak Project : 010732 Setting : 14</p>	 <p>Site : 03CH16-HY Condition : AVG_54 3m 91200_1522 VERTICAL Detector : Peak Project : 010732 Setting : 14</p>

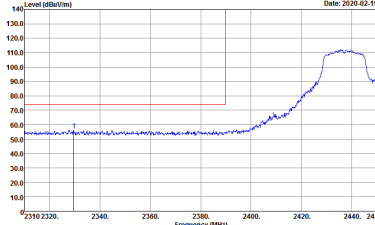
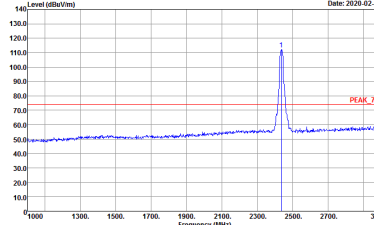
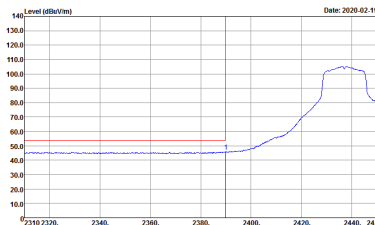
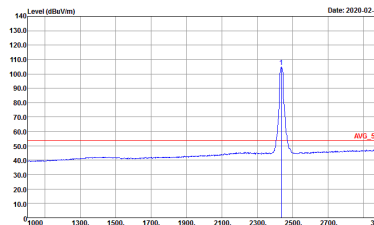

WIFI	2.4GHz 2400~2483.5MHz Band Edge @ 3m	
ANT	802.11g CH06 2437MHz - L	
1	Horizontal	Fundamental
Peak	 <p>Site : 03CH16-HY Condition : PEAK_BE_74 3m 91200_1522 HORIZONTAL RBW:1000.000KHz VBW:3000.000KHz SWT:Auto Detector : Peak Project : 010732</p>	 <p>Site : 03CH16-HY Condition : PEAK_74 3m 91200_1522 HORIZONTAL RBW:1000.000KHz VBW:3000.000KHz SWT:Auto Detector : Peak Project : 010732</p>
Avg.	 <p>Site : 03CH16-HY Condition : AVG_BE_54 3m 91200_1522 HORIZONTAL RBW:1000.000KHz VBW:1000KHz SWT:Auto Detector : Peak Project : 010732</p>	 <p>Site : 03CH16-HY Condition : AVG_54 3m 91200_1522 HORIZONTAL RBW:1000.000KHz VBW:1000KHz SWT:Auto Detector : Peak Project : 010732</p>

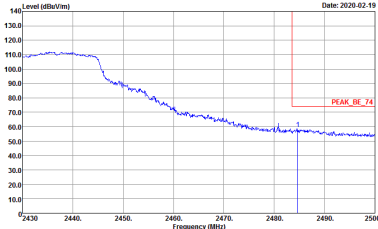
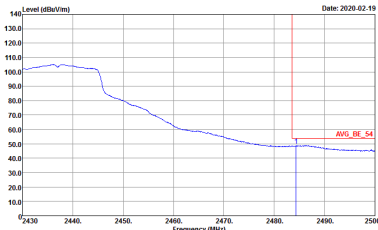

WIFI	2.4GHz 2400~2483.5MHz Band Edge @ 3m	
ANT	802.11g CH06 2437MHz - R	
1	Horizontal	Fundamental
<p>Peak</p>	 <p>Site : 03CH16-HY Condition : PEAK_BE_74 3m 91200_1522 HORIZONTAL RBW:1000.000kHz VBW:3000.000kHz SWF:Auto Detector : Peak Project : 010732</p>	<p>Left blank</p>
<p>Avg.</p>	 <p>Site : 03CH16-HY Condition : AVG_BE_54 3m 91200_1522 HORIZONTAL RBW:1000.000kHz VBW:1.000kHz SWF:Auto Detector : Peak Project : 010732</p>	<p>Left blank</p>

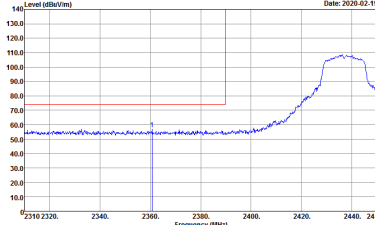
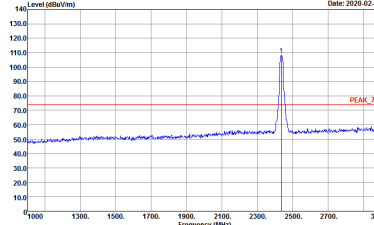
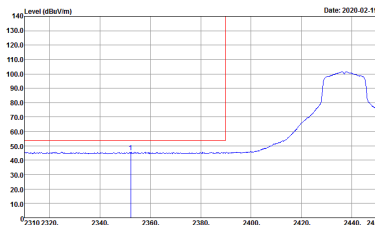
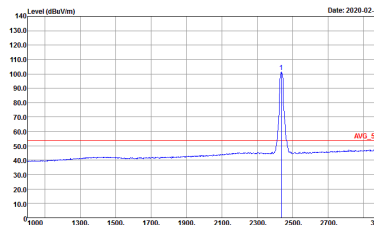

WIFI	2.4GHz 2400~2483.5MHz Band Edge @ 3m	
ANT	802.11g CH06 2437MHz - L	
1	Vertical	Fundamental
Peak	 <p>Site : 03CH16-HY Condition : PEAK_BE_74 3m 91200_1522 VERTICAL RBW:1000.000KHz VBW:3000.000KHz SWT:Auto Detector : Peak Project : 010732</p>	 <p>Site : 03CH16-HY Condition : PEAK_74 3m 91200_1522 VERTICAL RBW:1000.000KHz VBW:3000.000KHz SWT:Auto Detector : Peak Project : 010732</p>
Avg.	 <p>Site : 03CH16-HY Condition : AVG_BE_54 3m 91200_1522 VERTICAL RBW:1000.000KHz VBW:1000KHz SWT:Auto Detector : Peak Project : 010732</p>	 <p>Site : 03CH16-HY Condition : AVG_54 3m 91200_1522 VERTICAL RBW:1000.000KHz VBW:1000KHz SWT:Auto Detector : Peak Project : 010732</p>

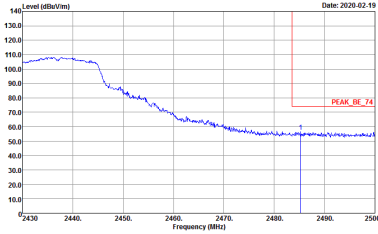
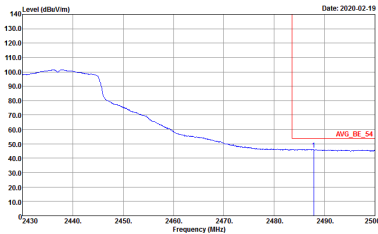

WIFI	2.4GHz 2400~2483.5MHz Band Edge @ 3m	
ANT	802.11g CH06 2437MHz - R	
1	Vertical	Fundamental
Peak	 <p>Site : 03CH16-HY Condition : PEAK_BE_74 3m 91200_1522 VERTICAL RBW:1000.000KHz VBW:3000.000KHz SWF:Auto Detector : Peak Project : 010732</p>	Left Blank
Avg.	 <p>Site : 03CH16-HY Condition : AVG_BE_54 3m 91200_1522 VERTICAL RBW:1000.000KHz VBW:1.000KHz SWF:Auto Detector : Peak Project : 010732</p>	Left Blank

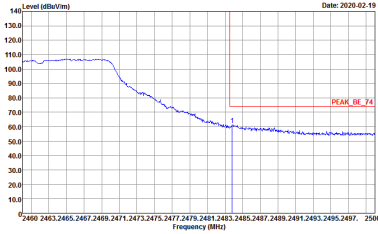
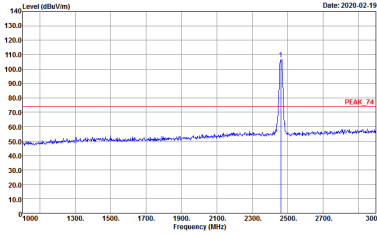
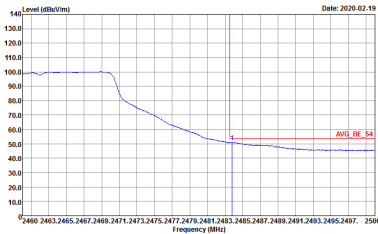
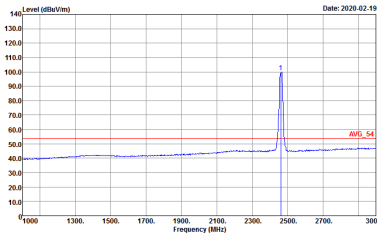

WIFI	2.4GHz 2400~2483.5MHz Band Edge @ 3m	
ANT	802.11g CH11 2462MHz	
1	Horizontal	Fundamental
Peak	 <p>Site : 03CH16-HY Condition : PEAK_BE_74 3m 91200_1522 HORIZONTAL Detector : Peak Project : 010732 Setting : 15</p>	 <p>Site : 03CH16-HY Condition : PEAK_74 3m 91200_1522 HORIZONTAL Detector : Peak Project : 010732 Setting : 15</p>
Avg.	 <p>Site : 03CH16-HY Condition : AVG_BE_54 3m 91200_1522 HORIZONTAL Detector : Peak Project : 010732 Setting : 15</p>	 <p>Site : 03CH16-HY Condition : AVG_54 3m 91200_1522 HORIZONTAL Detector : Peak Project : 010732 Setting : 15</p>

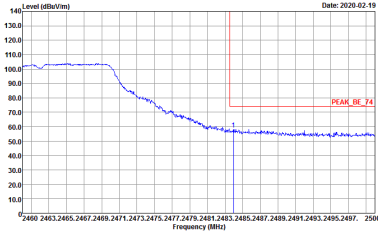
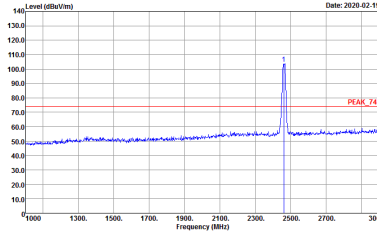
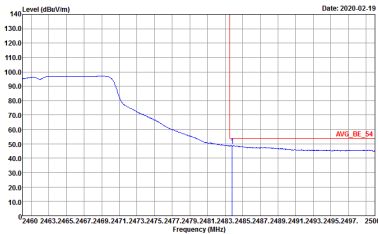
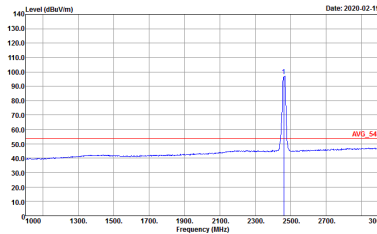

WIFI	2.4GHz 2400~2483.5MHz Band Edge @ 3m	
ANT	802.11g CH11 2462MHz	
1	Vertical	Fundamental
Peak	 <p>Site : 03CH16-HY Condition : PEAK_BE_74 3m 91200_1522 VERTICAL Detector : Peak Project : 010732 Setting : 15</p>	 <p>Site : 03CH16-HY Condition : PEAK_74 3m 91200_1522 VERTICAL Detector : Peak Project : 010732 Setting : 15</p>
Avg.	 <p>Site : 03CH16-HY Condition : AVG_BE_54 3m 91200_1522 VERTICAL Detector : Peak Project : 010732 Setting : 15</p>	 <p>Site : 03CH16-HY Condition : AVG_54 3m 91200_1522 VERTICAL Detector : Peak Project : 010732 Setting : 15</p>



2.4GHz 2400~2483.5MHz

WIFI 802.11ac VHT20 (Band Edge @ 3m)

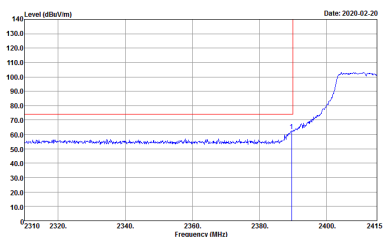
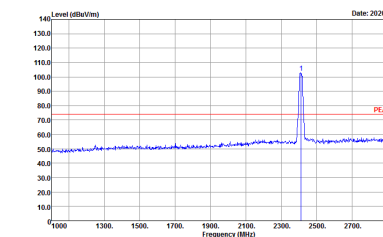
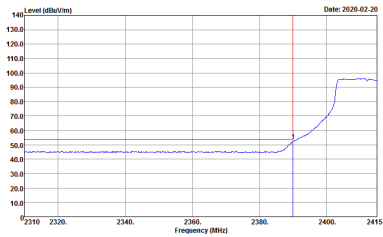
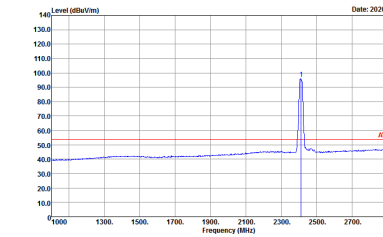
WIFI	2.4GHz 2400~2483.5MHz Band Edge @ 3m	
ANT	802.11ac VHT20 CH01 2412MHz	
1	Horizontal	Fundamental
Peak	 <p>Site : 03CH16-1FY Condition : PEAK_BE_74 3m 91200_1522 HORIZONTAL Detector : Peak Project : 010732 Setting : 12.5</p>	 <p>Site : 03CH16-1FY Condition : PEAK_74 3m 91200_1522 HORIZONTAL Detector : Peak Project : 010732 Setting : 12.5</p>
	 <p>Site : 03CH16-1FY Condition : AVG_BE_54 3m 91200_1522 HORIZONTAL Detector : Peak Project : 010732 Setting : 12.5</p>	 <p>Site : 03CH16-1FY Condition : AVG_54 3m 91200_1522 HORIZONTAL Detector : Peak Project : 010732 Setting : 12.5</p>

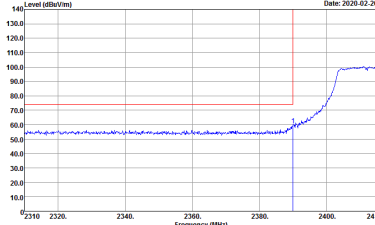
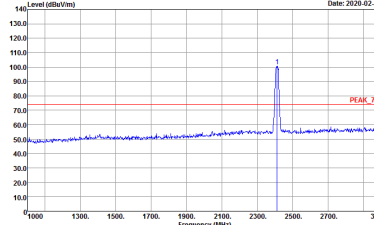
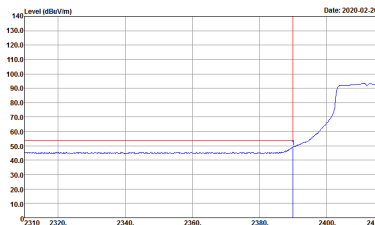
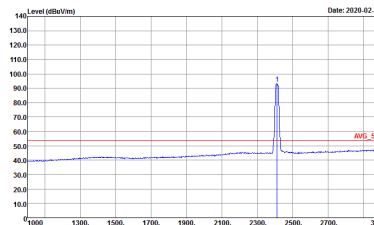

WIFI	2.4GHz 2400~2483.5MHz Band Edge @ 3m	
ANT	802.11ac VHT20 CH01 2412MHz	
1	Vertical	Fundamental
Peak	 <p>Site : 03CH16-HY Condition : PEAK_BE_74 3m 91200_1522 VERTICAL RBW:1000.000KHz VBW:3000.000KHz SWT:Auto Detector : Peak Project : 010732 Setting : 12.5</p>	 <p>Site : 03CH16-HY Condition : PEAK_74 3m 91200_1522 VERTICAL RBW:1000.000KHz VBW:3000.000KHz SWT:Auto Detector : Peak Project : 010732 Setting : 12.5</p>
Avg.	 <p>Site : 03CH16-HY Condition : AVG_BE_54 3m 91200_1522 VERTICAL RBW:1000.000KHz VBW:1000KHz SWT:Auto Detector : Peak Project : 010732 Setting : 12.5</p>	 <p>Site : 03CH16-HY Condition : AVG_54 3m 91200_1522 VERTICAL RBW:1000.000KHz VBW:1000KHz SWT:Auto Detector : Peak Project : 010732 Setting : 12.5</p>

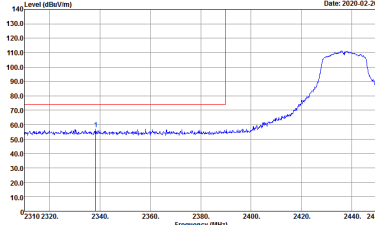
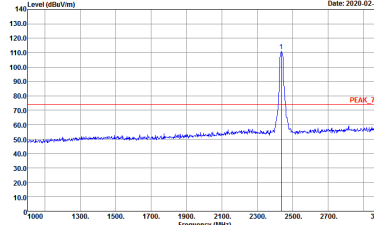
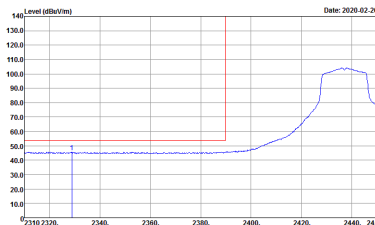
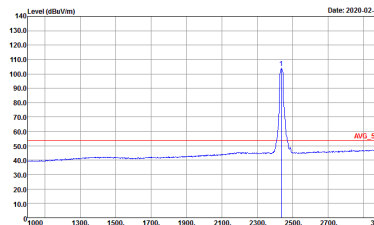

WIFI	2.4GHz 2400~2483.5MHz Band Edge @ 3m	
ANT	802.11ac VHT20 CH06 2437MHz - L	
1	Horizontal	Fundamental
Peak	 <p>Site : 03CH16-HY Condition : PEAK_BE_74 3m 91200_1522 HORIZONTAL Detector : Peak Project : 010732 Setting : 19</p>	 <p>Site : 03CH16-HY Condition : PEAK_74 3m 91200_1522 HORIZONTAL Detector : Peak Project : 010732 Setting : 19</p>
Avg.	 <p>Site : 03CH16-HY Condition : AVG_BE_54 3m 91200_1522 HORIZONTAL Detector : Peak Project : 010732 Setting : 19</p>	 <p>Site : 03CH16-HY Condition : AVG_54 3m 91200_1522 HORIZONTAL Detector : Peak Project : 010732 Setting : 19</p>

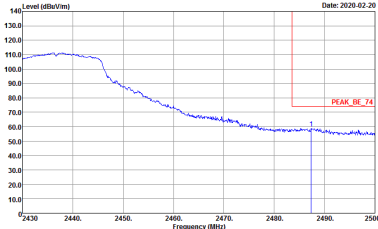
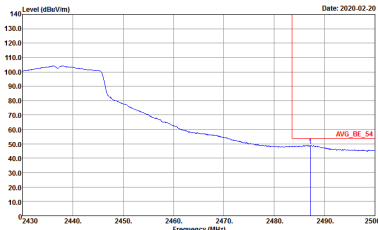

WIFI	2.4GHz 2400~2483.5MHz Band Edge @ 3m	
ANT	802.11ac VHT20 CH06 2437MHz - R	
1	Horizontal	Fundamental
<p>Peak</p>	 <p>Site : 03CH16-HY Condition : PEAK_BE_74 3m 91200_1522 HORIZONTAL RBW:1000.000kHz VBW:3000.000kHz SWF:Auto Detector : Peak Project : 010732 Setting : 19</p>	<p>Left blank</p>
<p>Avg.</p>	 <p>Site : 03CH16-HY Condition : AVG_BE_54 3m 91200_1522 HORIZONTAL RBW:1000.000kHz VBW:1.000kHz SWF:Auto Detector : Peak Project : 010732 Setting : 19</p>	<p>Left blank</p>

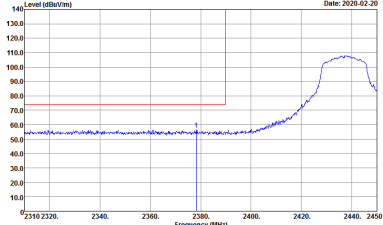
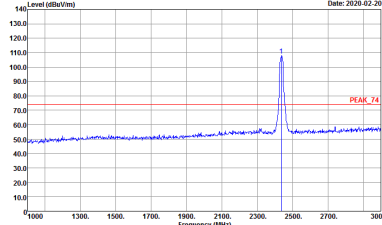
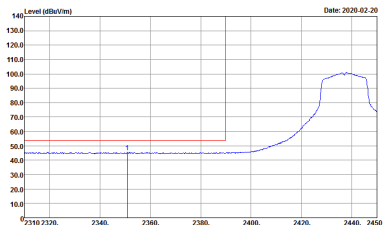
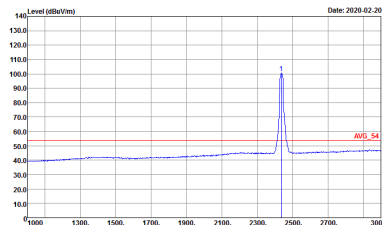

WIFI	2.4GHz 2400~2483.5MHz Band Edge @ 3m	
ANT	802.11ac VHT20 CH06 2437MHz - L	
1	Vertical	Fundamental
Peak	 <p>Site : 03CH16-HY Condition : PEAK_BE_74 3m 91200_1522 VERTICAL RBW:1000.000KHz VBW:3000.000KHz SWT:Auto Detector : Peak Project : 010732 Setting : 19</p>	 <p>Site : 03CH16-HY Condition : PEAK_74 3m 91200_1522 VERTICAL RBW:1000.000KHz VBW:3000.000KHz SWT:Auto Detector : Peak Project : 010732 Setting : 19</p>
Avg.	 <p>Site : 03CH16-HY Condition : AVG_BE_54 3m 91200_1522 VERTICAL RBW:1000.000KHz VBW:1000KHz SWT:Auto Detector : Peak Project : 010732 Setting : 19</p>	 <p>Site : 03CH16-HY Condition : AVG_54 3m 91200_1522 VERTICAL RBW:1000.000KHz VBW:1000KHz SWT:Auto Detector : Peak Project : 010732 Setting : 19</p>

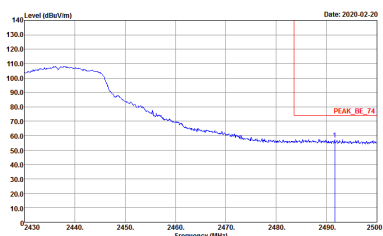
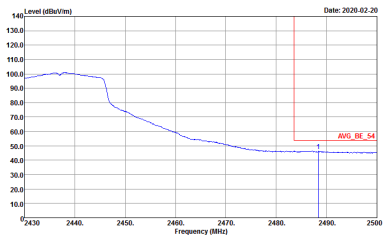

WIFI	2.4GHz 2400~2483.5MHz Band Edge @ 3m	
ANT	802.11ac VHT20 CH06 2437MHz - R	
1	Vertical	Fundamental
<p>Peak</p>	 <p>Site : 03CH16-HY Condition : PEAK_BE_74 3m 91200_1522 VERTICAL Detector : Peak Project : 010732 Setting : 19</p>	<p>Left blank</p>
<p>Avg.</p>	 <p>Site : 03CH16-HY Condition : AVG_BE_54 3m 91200_1522 VERTICAL Detector : Peak Project : 010732 Setting : 19</p>	<p>Left blank</p>

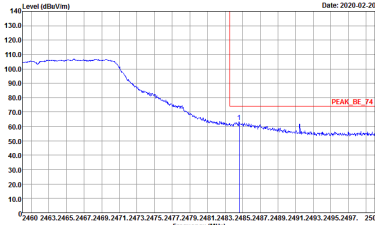
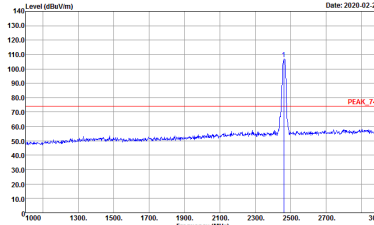
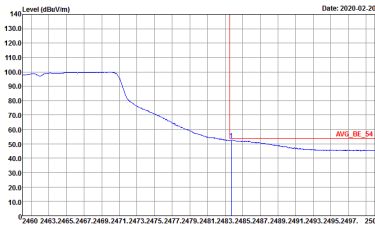
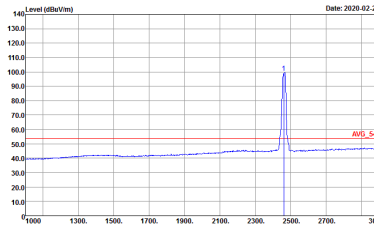

WIFI	2.4GHz 2400~2483.5MHz Band Edge @ 3m	
ANT	802.11ac VHT20 CH11 2462MHz	
1	Horizontal	Fundamental
Peak	 <p>Site : 03CH16-HY Condition : PEAK_BE_74 3m 91200_1522 HORIZONTAL Detector : Peak Project : 010732 Setting : 15</p>	 <p>Site : 03CH16-HY Condition : PEAK_74 3m 91200_1522 HORIZONTAL Detector : Peak Project : 010732 Setting : 15</p>
Avg.	 <p>Site : 03CH16-HY Condition : AVG_BE_54 3m 91200_1522 HORIZONTAL Detector : Peak Project : 010732 Setting : 15</p>	 <p>Site : 03CH16-HY Condition : AVG_54 3m 91200_1522 HORIZONTAL Detector : Peak Project : 010732 Setting : 15</p>

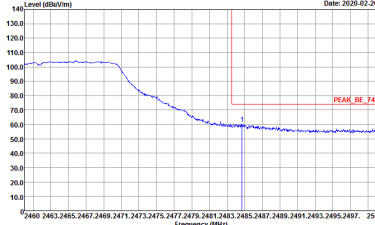
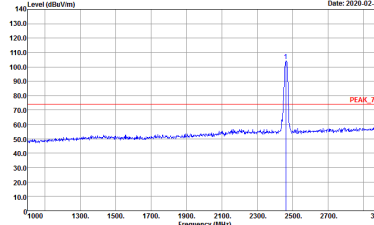
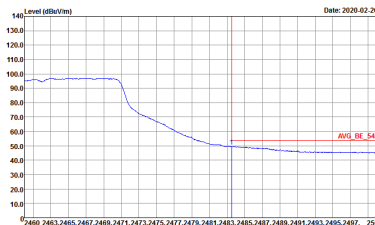
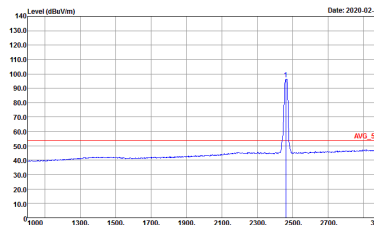

WIFI	2.4GHz 2400~2483.5MHz Band Edge @ 3m	
ANT	802.11ac VHT20 CH11 2462MHz	
1	Vertical	Fundamental
Peak	 <p>Site : 03CH16-11Y Condition : PEAK_BE_74 3m 91200_1522 VERTICAL Detector : Peak Project : 010732 Setting : 15</p>	 <p>Site : 03CH16-11Y Condition : PEAK_74 3m 91200_1522 VERTICAL Detector : Peak Project : 010732 Setting : 15</p>
Avg.	 <p>Site : 03CH16-11Y Condition : AVG_BE_54 3m 91200_1522 VERTICAL Detector : Peak Project : 010732 Setting : 15</p>	 <p>Site : 03CH16-11Y Condition : AVG_54 3m 91200_1522 VERTICAL Detector : Peak Project : 010732 Setting : 15</p>

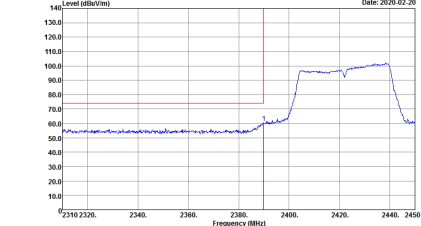
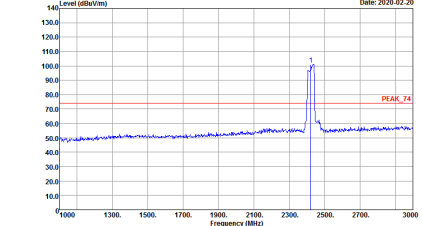
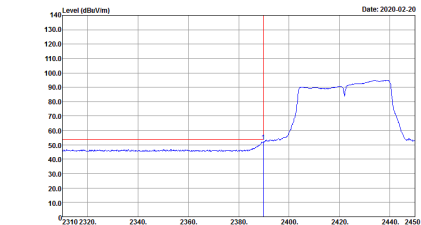
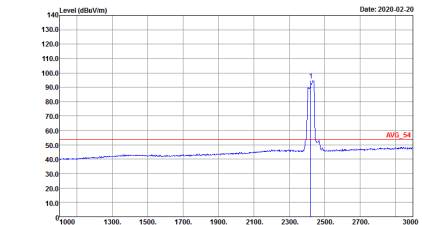

2.4GHz 2400~2483.5MHz
 WIFI 802.11ac VHT40 (Band Edge @ 3m)

WIFI	2.4GHz 2400~2483.5MHz Band Edge @ 3m	
ANT	802.11ac VHT40 CH03 2422MHz - L	
1	Horizontal	Fundamental
Peak	 <p>Site : 03CH16-HY Condition : PEAK_BE_74 3m 91200_1522 HORIZONTAL Detector : Peak Project : 010732 Setting : 11</p>	 <p>Site : 03CH16-HY Condition : PEAK_74 3m 91200_1522 HORIZONTAL Detector : Peak Project : 010732 Setting : 11</p>
Avg.	 <p>Site : 03CH16-HY Condition : AVG_BE_54 3m 91200_1522 HORIZONTAL Detector : Peak Project : 010732 Setting : 11</p>	 <p>Site : 03CH16-HY Condition : AVG_54 3m 91200_1522 HORIZONTAL Detector : Peak Project : 010732 Setting : 11</p>

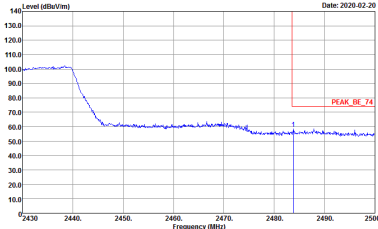
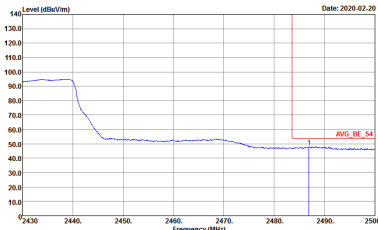

WIFI	2.4GHz 2400~2483.5MHz Band Edge @ 3m	
ANT	802.11ac VHT40 CH03 2422MHz - R	
1	Horizontal	Fundamental
<p>Peak</p>	 <p>Site : 03CH16-HY Condition : PEAK_BE_74 3m 91200_1522 HORIZONTAL RBW:1000.000kHz VBW:3000.000kHz SWF:Auto Detector : Peak Project : 010732 Setting : 11</p>	<p>Left blank</p>
<p>Avg.</p>	 <p>Site : 03CH16-HY Condition : AVG_BE_54 3m 91200_1522 HORIZONTAL RBW:1000.000kHz VBW:3.000kHz SWF:Auto Detector : Peak Project : 010732 Setting : 11</p>	<p>Left blank</p>

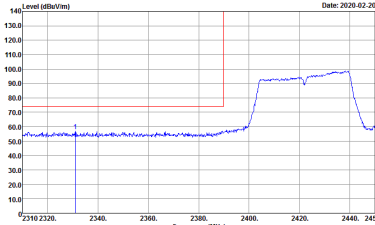
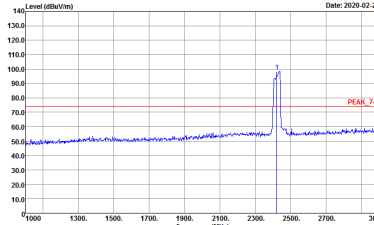
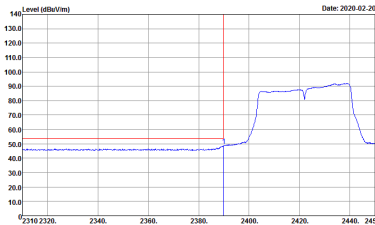
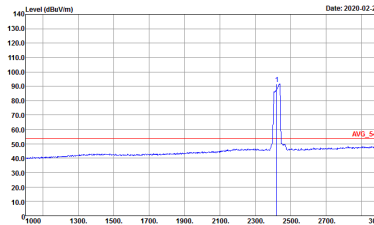

WIFI	2.4GHz 2400~2483.5MHz Band Edge @ 3m	
ANT	802.11ac VHT40 CH03 2422MHz - L	
1	Vertical	Fundamental
Peak	 <p>Site : 03CH16-HY Condition : PEAK_BE_74 3m 91200_1522 VERTICAL Detector : Peak Project : 010732 Setting : 11</p>	 <p>Site : 03CH16-HY Condition : PEAK_74 3m 91200_1522 VERTICAL Detector : Peak Project : 010732 Setting : 11</p>
Avg.	 <p>Site : 03CH16-HY Condition : AVG_BE_54 3m 91200_1522 VERTICAL Detector : Peak Project : 010732 Setting : 11</p>	 <p>Site : 03CH16-HY Condition : AVG_54 3m 91200_1522 VERTICAL Detector : Peak Project : 010732 Setting : 11</p>

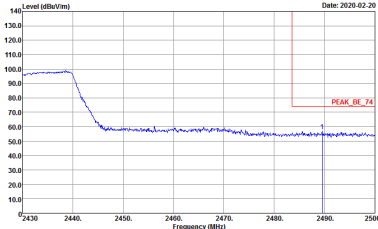
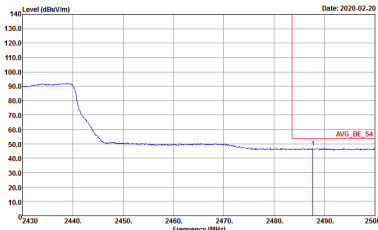

WIFI	2.4GHz 2400~2483.5MHz Band Edge @ 3m	
ANT	802.11ac VHT40 CH03 2422MHz - R	
1	Vertical	Fundamental
Peak	 <p>Date: 2020-02-20</p> <p>Site : 03CH16-HY Condition : PEAK_BE_74 3m 91200_1522 VERTICAL RBW:1000.000KHz VBW:3000.000KHz SWF:Auto Detector : Peak Project : 010732 Setting : 11</p>	Left blank
Avg.	 <p>Date: 2020-02-20</p> <p>Site : 03CH16-HY Condition : AVG_BE_54 3m 91200_1522 VERTICAL RBW:1000.000KHz VBW:3.000KHz SWF:Auto Detector : Peak Project : 010732 Setting : 11</p>	Left blank

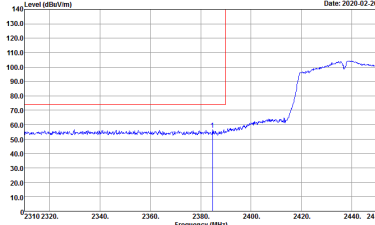
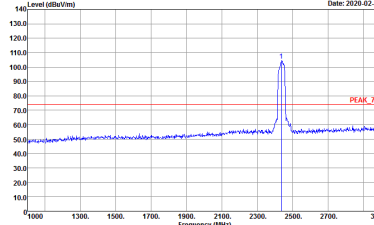
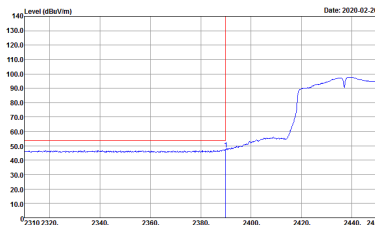
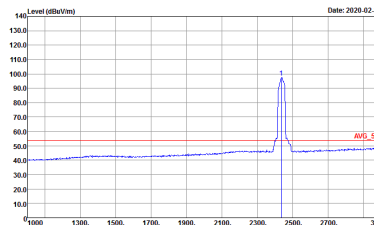

WIFI	2.4GHz 2400~2483.5MHz Band Edge @ 3m	
ANT	802.11ac VHT40 CH06 2437MHz - L	
1	Horizontal	Fundamental
Peak	 <p>Site : 03CH16-HY Condition : PEAK_BE_74 3m 91200_1522 HORIZONTAL Detector : Peak Project : 010732 Setting : 13.5</p>	 <p>Site : 03CH16-HY Condition : PEAK_74 3m 91200_1522 HORIZONTAL Detector : Peak Project : 010732 Setting : 13.5</p>
Avg.	 <p>Site : 03CH16-HY Condition : AVG_BE_54 3m 91200_1522 HORIZONTAL Detector : Peak Project : 010732 Setting : 13.5</p>	 <p>Site : 03CH16-HY Condition : AVG_54 3m 91200_1522 HORIZONTAL Detector : Peak Project : 010732 Setting : 13.5</p>

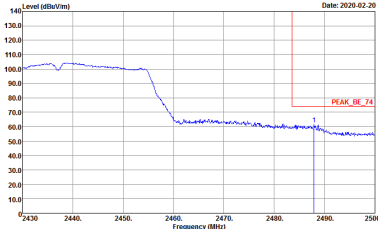
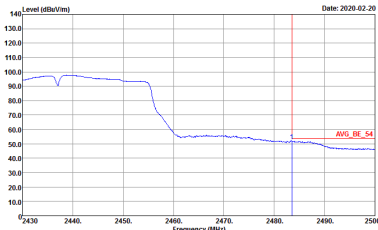

WIFI	2.4GHz 2400~2483.5MHz Band Edge @ 3m	
ANT	802.11ac VHT40 CH06 2437MHz - R	
1	Horizontal	Fundamental
<p>Peak</p>	 <p>Site : 03CH16-HY Condition : PEAK_BE_74 3m 91200_1522 HORIZONTAL RBW:1000.000kHz VBW:3000.000kHz SWF:Auto Detector : Peak Project : 010732 Setting : 13.5</p>	<p>Left blank</p>
<p>Avg.</p>	 <p>Site : 03CH16-HY Condition : AVG_BE_54 3m 91200_1522 HORIZONTAL RBW:1000.000kHz VBW:3.000kHz SWF:Auto Detector : Peak Project : 010732 Setting : 13.5</p>	<p>Left blank</p>

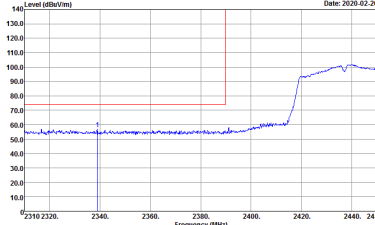
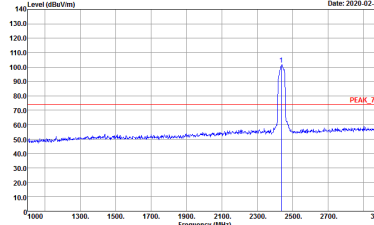
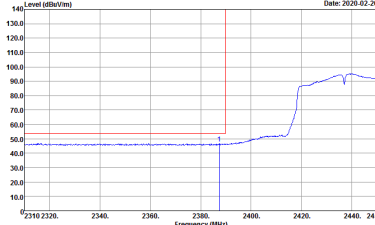
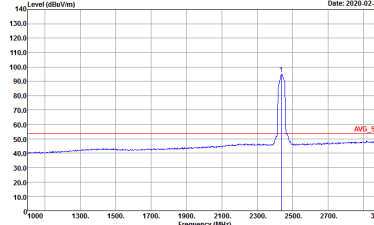

WIFI	2.4GHz 2400~2483.5MHz Band Edge @ 3m	
ANT	802.11ac VHT40 CH06 2437MHz - L	
1	Vertical	Fundamental
Peak	 <p>Site : 03CH16-HY Condition : PEAK_BE_74 3m 91200_1522 VERTICAL Detector : Peak Project : 010732 Setting : 13.5</p>	 <p>Site : 03CH16-HY Condition : PEAK_74 3m 91200_1522 VERTICAL Detector : Peak Project : 010732 Setting : 13.5</p>
Avg.	 <p>Site : 03CH16-HY Condition : AVG_BE_54 3m 91200_1522 VERTICAL Detector : Peak Project : 010732 Setting : 13.5</p>	 <p>Site : 03CH16-HY Condition : AVG_54 3m 91200_1522 VERTICAL Detector : Peak Project : 010732 Setting : 13.5</p>

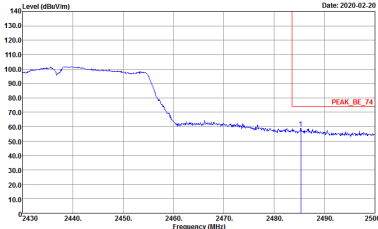
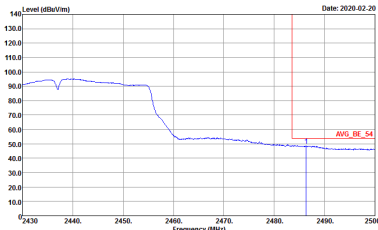

WIFI	2.4GHz 2400~2483.5MHz Band Edge @ 3m	
ANT	802.11ac VHT40 CH06 2437MHz - R	
1	Vertical	Fundamental
<p>Peak</p>	 <p>Date: 2020-02-20</p> <p>Site : 03CH16-HY Condition : PEAK_BE_74 3m 91200_1522 VERTICAL RBW:1000.000kHz VBW:3000.000kHz SWF:Auto Detector : Peak Project : 010732 Setting : 13.5</p>	<p>Left blank</p>
<p>Avg.</p>	 <p>Date: 2020-02-20</p> <p>Site : 03CH16-HY Condition : AVG_BE_54 3m 91200_1522 VERTICAL RBW:1000.000kHz VBW:3.000kHz SWF:Auto Detector : Peak Project : 010732 Setting : 13.5</p>	<p>Left blank</p>

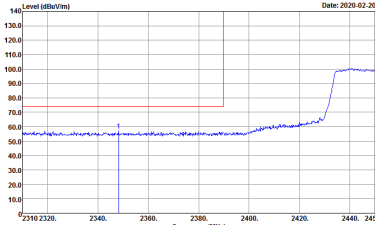
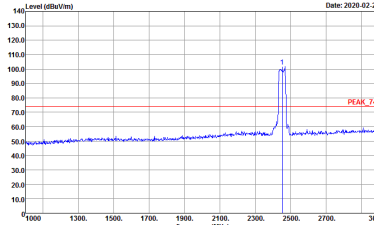
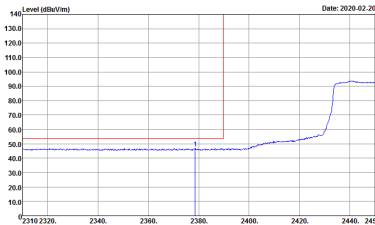
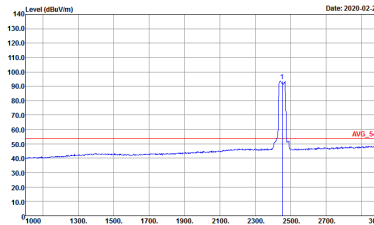

WIFI	2.4GHz 2400~2483.5MHz Band Edge @ 3m	
ANT	802.11ac VHT40 CH09 2452MHz - L	
1	Horizontal	Fundamental
Peak	 <p>Site : 03CH16-HY Condition : PEAK_BE_74 3m 91200_1522 HORIZONTAL Detector : Peak Project : 010732 Setting : 11</p>	 <p>Site : 03CH16-HY Condition : PEAK_74 3m 91200_1522 HORIZONTAL Detector : Peak Project : 010732 Setting : 11</p>
Avg.	 <p>Site : 03CH16-HY Condition : AVG_BE_54 3m 91200_1522 HORIZONTAL Detector : Peak Project : 010732 Setting : 11</p>	 <p>Site : 03CH16-HY Condition : AVG_54 3m 91200_1522 HORIZONTAL Detector : Peak Project : 010732 Setting : 11</p>

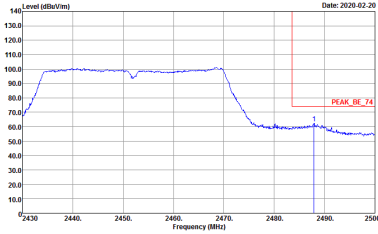
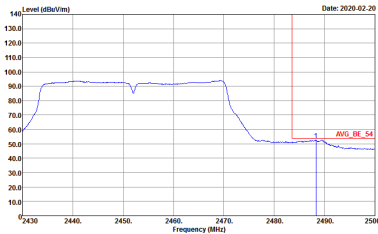

WIFI	2.4GHz 2400~2483.5MHz Band Edge @ 3m	
ANT	802.11ac VHT40 CH09 2452MHz - R	
1	Horizontal	Fundamental
<p>Peak</p>	 <p>Date: 2020-02-20</p> <p>Site : 03CH16-HY Condition : PEAK_BE_74 3m 91200_1522 HORIZONTAL RBW:1000.000kHz VBW:3000.000kHz SWF:Auto Detector : Peak Project : 010732 Setting : 11</p>	<p>Left blank</p>
<p>Avg.</p>	 <p>Date: 2020-02-20</p> <p>Site : 03CH16-HY Condition : AVG_BE_54 3m 91200_1522 HORIZONTAL RBW:1000.000kHz VBW:3.000kHz SWF:Auto Detector : Peak Project : 010732 Setting : 11</p>	<p>Left blank</p>

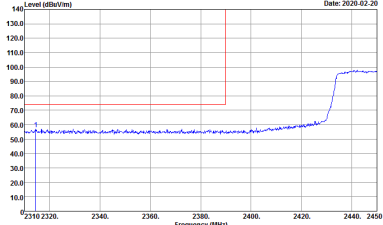
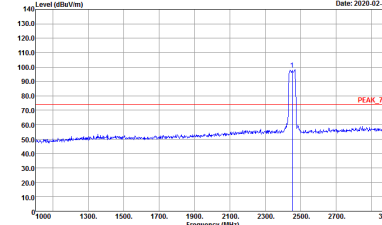
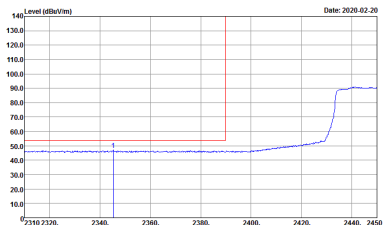
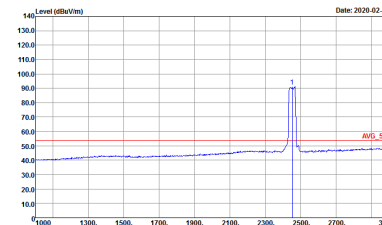

WIFI	2.4GHz 2400~2483.5MHz Band Edge @ 3m	
ANT	802.11ac VHT40 CH09 2452MHz - L	
1	Vertical	Fundamental
Peak	 <p>Site : 03CH16-HY Condition : PEAK_8E_74 3m 91200_1522 VERTICAL Detector : Peak Project : 010732 Setting : 11</p>	 <p>Site : 03CH16-HY Condition : PEAK_74 3m 91200_1522 VERTICAL Detector : Peak Project : 010732 Setting : 11</p>
Avg.	 <p>Site : 03CH16-HY Condition : AVG_8E_54 3m 91200_1522 VERTICAL Detector : Peak Project : 010732 Setting : 11</p>	 <p>Site : 03CH16-HY Condition : AVG_54 3m 91200_1522 VERTICAL Detector : Peak Project : 010732 Setting : 11</p>

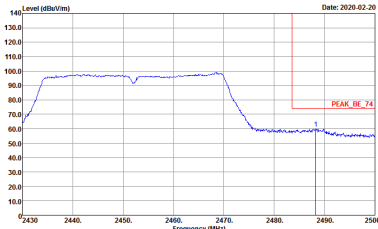
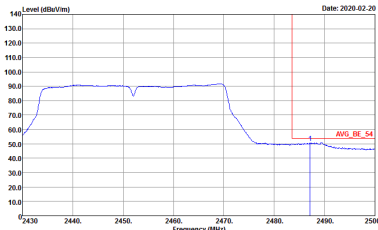

WIFI	2.4GHz 2400~2483.5MHz Band Edge @ 3m	
ANT	802.11ac VHT40 CH09 2452MHz - R	
1	Vertical	Fundamental
<p>Peak</p>	 <p>Date: 2020-02-20</p> <p>Site : 03CH16-HY Condition : PEAK_BE_74 3m 91200_1522 VERTICAL RBW:1000.000kHz VBW:3000.000kHz SWF:Auto Detector : Peak Project : 010732 Setting : 11</p>	<p>Left blank</p>
<p>Avg.</p>	 <p>Date: 2020-02-20</p> <p>Site : 03CH16-HY Condition : AVG_BE_54 3m 91200_1522 VERTICAL RBW:1000.000kHz VBW:3.000kHz SWF:Auto Detector : Peak Project : 010732 Setting : 11</p>	<p>Left blank</p>



2.4GHz 2400~2483.5MHz

WIFI 802.11b (Harmonic @ 3m)

WIFI	2.4GHz 2400~2483.5MHz Harmonic @ 3m	
ANT	802.11b CH01 2412MHz	
1	Horizontal	Vertical
Peak Avg.	<p>Site : 03CH16-1FY Condition : PEAK_74 3m 91200_1522 HORIZONTAL Detector : Peak Project : 010732</p>	<p>Site : 03CH16-1FY Condition : PEAK_74 3m 91200_1522 VERTICAL Detector : Peak Project : 010732</p>



WIFI	2.4GHz 2400~2483.5MHz Harmonic @ 3m	
ANT	802.11b CH06 2437MHz	
1	Horizontal	Vertical
Peak Avg.	<p>Site : 03CH16-HY Condition : PEAK_74 3m 91200_1522 HORIZONTAL Detector : Peak Project : 010732</p>	<p>Site : 03CH16-HY Condition : PEAK_74 3m 91200_1522 VERTICAL Detector : Peak Project : 010732</p>



WIFI	2.4GHz 2400~2483.5MHz Harmonic @ 3m	
ANT	802.11b CH11 2462MHz	
1	Horizontal	Vertical
Peak Avg.	<p>Site : 03CH16-HY Condition : PEAK_74 3m 91200_1522 HORIZONTAL Detector : Peak Project : 010732</p>	<p>Site : 03CH16-HY Condition : PEAK_74 3m 91200_1522 VERTICAL Detector : Peak Project : 010732</p>



2.4GHz 2400~2483.5MHz

WIFI 802.11g (Harmonic @ 3m)

WIFI	2.4GHz 2400~2483.5MHz Harmonic @ 3m	
ANT	802.11g CH01 2412MHz	
1	Horizontal	Vertical
Peak Avg.	<p>Site : 03CH16-1FY Condition : PEAK_74 3m 91200_1522 HORIZONTAL Detector : Peak Project : 010732 Setting : 14</p>	<p>Site : 03CH16-1FY Condition : PEAK_74 3m 91200_1522 VERTICAL Detector : Peak Project : 010732 Setting : 14</p>



WIFI	2.4GHz 2400~2483.5MHz Harmonic @ 3m	
ANT	802.11g CH06 2437MHz	
1	Horizontal	Vertical
Peak Avg.	<p>Site : 03CH16-HY Condition : PEAK_74 3m 91200_1522 HORIZONTAL Detector : Peak Project : 010732</p>	<p>Site : 03CH16-HY Condition : PEAK_74 3m 91200_1522 VERTICAL Detector : Peak Project : 010732</p>



WIFI	2.4GHz 2400~2483.5MHz Harmonic @ 3m	
ANT	802.11g CH11 2462MHz	
1	Horizontal	Vertical
Peak Avg.	<p>Site : 03CH16-HY Condition : PEAK_74 3m 91200_1522 HORIZONTAL Detector : Peak Project : 010732 Setting : IS</p>	<p>Site : 03CH16-HY Condition : PEAK_74 3m 91200_1522 VERTICAL Detector : Peak Project : 010732 Setting : IS</p>



2.4GHz 2400~2483.5MHz

WIFI 802.11ac VHT20 (Harmonic @ 3m)

WIFI	2.4GHz 2400~2483.5MHz Harmonic @ 3m	
ANT	802.11ac VHT20 CH01 2412MHz	
1	Horizontal	Vertical
Peak Avg.	<p>Site : 03CH16-1FY Condition : PEAK_74 3m 91200_1522 HORIZONTAL Detector : Peak Project : 010732 Setting : 12.5</p>	<p>Site : 03CH16-1FY Condition : PEAK_74 3m 91200_1522 VERTICAL Detector : Peak Project : 010732 Setting : 12.5</p>



WIFI	2.4GHz 2400~2483.5MHz Harmonic @ 3m	
ANT	802.11ac VHT20 CH06 2437MHz	
1	Horizontal	Vertical
Peak Avg.	<p>Site : 03CH16-HY Condition : PEAK_74 3m 91200_1522 HORIZONTAL Detector : Peak Project : 010732</p>	<p>Site : 03CH16-HY Condition : PEAK_74 3m 91200_1522 VERTICAL Detector : Peak Project : 010732</p>



WIFI	2.4GHz 2400~2483.5MHz Harmonic @ 3m	
ANT	802.11ac VHT20 CH11 2462MHz	
1	Horizontal	Vertical
Peak Avg.	<p>Site : 03CH16-HY Condition : PEAK_74 3m 91200_1522 HORIZONTAL Detector : Peak Project : 010732 Setting : IS</p>	<p>Site : 03CH16-HY Condition : PEAK_74 3m 91200_1522 VERTICAL Detector : Peak Project : 010732 Setting : IS</p>



2.4GHz 2400~2483.5MHz

WIFI 802.11ac VHT40 (Harmonic @ 3m)

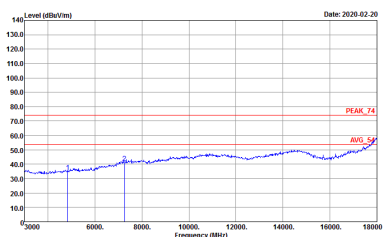
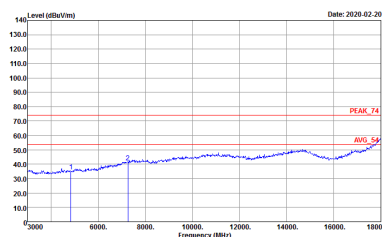
WIFI	2.4GHz 2400~2483.5MHz Harmonic @ 3m	
ANT	802.11ac VHT40 CH03 2422MHz	
1	Horizontal	Vertical
Peak Avg.	 <p>Site : 03CH16-1FY Condition : PEAK_74 3m 91200_1522 HORIZONTAL Detector : Peak Project : 010732 Setting : 11</p>	 <p>Site : 03CH16-1FY Condition : PEAK_74 3m 91200_1522 VERTICAL Detector : Peak Project : 010732 Setting : 11</p>



WIFI	2.4GHz 2400~2483.5MHz Harmonic @ 3m	
ANT	802.11ac VHT40 CH06 2437MHz	
1	Horizontal	Vertical
Peak Avg.	<p>Site : 03CH16-HY Condition : PEAK_74 3m 91200_1522 HORIZONTAL Detector : Peak Project : 010732 Setting : 13.5</p>	<p>Site : 03CH16-HY Condition : PEAK_74 3m 91200_1522 VERTICAL Detector : Peak Project : 010732 Setting : 13.5</p>



WIFI	2.4GHz 2400~2483.5MHz Harmonic @ 3m	
ANT	802.11ac VHT40 CH09 2452MHz	
1	Horizontal	Vertical
Peak Avg.	<p>Site : 03CH16-HY Condition : PEAK_74 3m 91200_1522 HORIZONTAL Detector : Peak Project : 010732 Setting : 11</p>	<p>Site : 03CH16-HY Condition : PEAK_74 3m 91200_1522 VERTICAL Detector : Peak Project : 010732 Setting : 11</p>

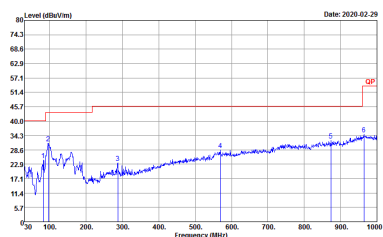
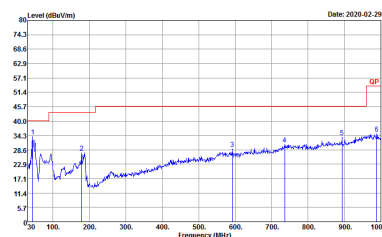

Emission below 1GHz
2.4GHz WIFI 802.11b (LF)

WIFI	2.4GHz 2400~2483.5MHz	
ANT	802.11b LF	
1	Horizontal	Vertical
QP / Peak	 <p>Site : 03CH16-1FY Condition : QP 3m B1LOG_47020406 HORIZONTAL Detector : Peak Project : 010732</p>	 <p>Site : 03CH16-1FY Condition : QP 3m B1LOG_47020406 VERTICAL Detector : Peak Project : 010732</p>



<Sample 2 with Battery 1>

2.4GHz 2400~2483.5MHz
WIFI 802.11b (Band Edge @ 3m)

WIFI	2.4GHz 2400~2483.5MHz Band Edge @ 3m	
ANT	802.11b CH01 2412MHz	
1	Horizontal	Fundamental
Peak	<p>Site : 03CH16-HY Condition : PEAK_BE_74 3m 91200_1522 HORIZONTAL Detector : Peak Project : 010732</p>	<p>Site : 03CH16-HY Condition : PEAK_74 3m 91200_1522 HORIZONTAL Detector : Peak Project : 010732</p>
Avg.	<p>Site : 03CH16-HY Condition : AVG_BE_54 3m 91200_1522 HORIZONTAL Detector : Peak Project : 010732</p>	<p>Site : 03CH16-HY Condition : AVG_54 3m 91200_1522 HORIZONTAL Detector : Peak Project : 010732</p>

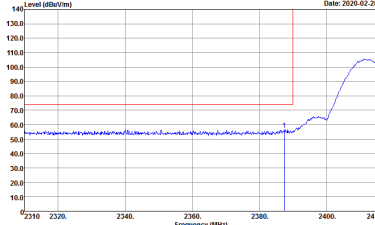
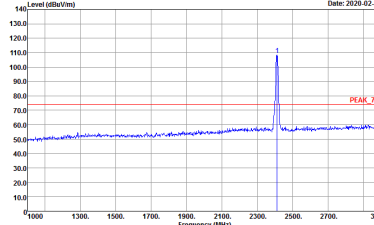
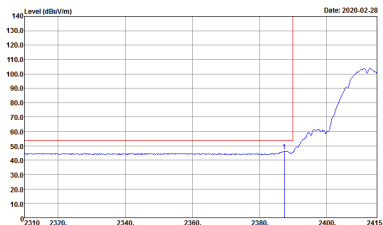
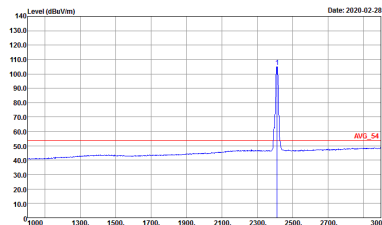

WIFI	2.4GHz 2400~2483.5MHz Band Edge @ 3m	
ANT	802.11b CH01 2412MHz	
1	Vertical	Fundamental
Peak	 <p>Site : 03CH16-HY Condition : PEAK_BE_74 3m 91200_1522 VERTICAL RBW:1000.000KHz VBW:3000.000KHz SWT:Auto Detector : Peak Project : 010732</p>	 <p>Site : 03CH16-HY Condition : PEAK_74 3m 91200_1522 VERTICAL RBW:1000.000KHz VBW:3000.000KHz SWT:Auto Detector : Peak Project : 010732</p>
Avg.	 <p>Site : 03CH16-HY Condition : AVG_BE_54 3m 91200_1522 VERTICAL RBW:1000.000KHz VBW:0.010KHz SWT:Auto Detector : Peak Project : 010732</p>	 <p>Site : 03CH16-HY Condition : AVG_54 3m 91200_1522 VERTICAL RBW:1000.000KHz VBW:0.010KHz SWT:Auto Detector : Peak Project : 010732</p>



2.4GHz 2400~2483.5MHz

WIFI 802.11b (Harmonic @ 3m)

WIFI	2.4GHz 2400~2483.5MHz Harmonic @ 3m	
ANT	802.11b CH01 2412MHz	
1	Horizontal	Vertical
Peak Avg.	<p>Site : 03CH16-1FY Condition : PEAK_74 3m 91200_1522 HORIZONTAL Detector : Peak Project : 010732</p>	<p>Site : 03CH16-1FY Condition : PEAK_74 3m 91200_1522 VERTICAL Detector : Peak Project : 010732</p>

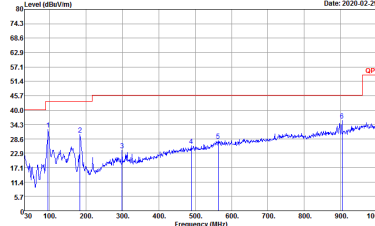
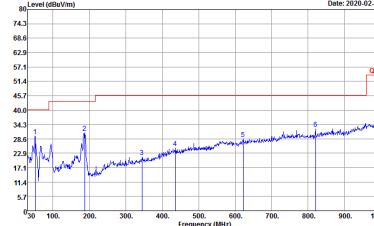

Emission below 1GHz
2.4GHz WIFI 802.11b (LF)

WIFI	2.4GHz 2400~2483.5MHz	
ANT	802.11b LF	
1	Horizontal	Vertical
QP / Peak	 <p>Site : 03CH16-1FY Condition : QP 3m B1LOG_47020406 HORIZONTAL Detector : Peak Project : 010732</p>	 <p>Site : 03CH16-1FY Condition : QP 3m B1LOG_47020406 VERTICAL Detector : Peak Project : 010732</p>



<Sample 1 with Battery 2>

2.4GHz 2400~2483.5MHz
WIFI 802.11b (Band Edge @ 3m)

WIFI	2.4GHz 2400~2483.5MHz Band Edge @ 3m	
ANT	802.11b CH01 2412MHz	
1	Horizontal	Fundamental
Peak	<p>Site : 03CH16-1HY Condition : PEAK_BE_74 3m 91200_1522 HORIZONTAL Detector : Peak Project : 010732</p>	<p>Site : 03CH16-1HY Condition : PEAK_74 3m 91200_1522 HORIZONTAL Detector : Peak Project : 010732</p>
Avg.	<p>Site : 03CH16-1HY Condition : AVG_BE_54 3m 91200_1522 HORIZONTAL Detector : Peak Project : 010732</p>	<p>Site : 03CH16-1HY Condition : AVG_54 3m 91200_1522 HORIZONTAL Detector : Peak Project : 010732</p>

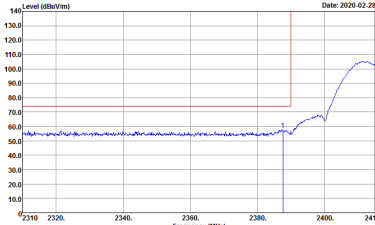
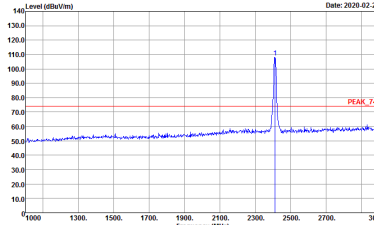
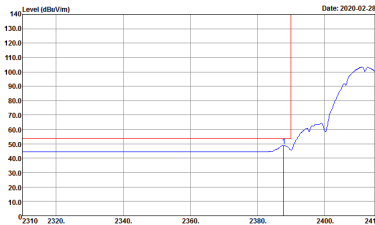
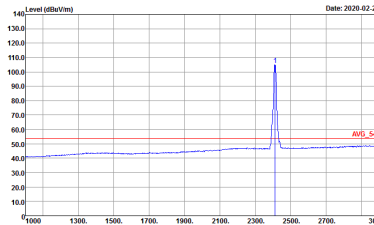

WIFI	2.4GHz 2400~2483.5MHz Band Edge @ 3m	
ANT	802.11b CH01 2412MHz	
1	Vertical	Fundamental
Peak	 <p>Site : 03CH16-HY Condition : PEAK_BE_74 3m 91200_1522 VERTICAL RBW:1000.000KHz VBW:3000.000KHz SWT:Auto Detector : Peak Project : 010732</p>	 <p>Site : 03CH16-HY Condition : PEAK_74 3m 91200_1522 VERTICAL RBW:1000.000KHz VBW:3000.000KHz SWT:Auto Detector : Peak Project : 010732</p>
Avg.	 <p>Site : 03CH16-HY Condition : AVG_BE_54 3m 91200_1522 VERTICAL RBW:1000.000KHz VBW:0.010KHz SWT:Auto Detector : Peak Project : 010732</p>	 <p>Site : 03CH16-HY Condition : AVG_54 3m 91200_1522 VERTICAL RBW:1000.000KHz VBW:0.010KHz SWT:Auto Detector : Peak Project : 010732</p>



2.4GHz 2400~2483.5MHz

WIFI 802.11b (Harmonic @ 3m)

WIFI	2.4GHz 2400~2483.5MHz Harmonic @ 3m	
ANT	802.11b CH01 2412MHz	
1	Horizontal	Vertical
<p>Peak</p> <p>Avg.</p>	<p>Site : 03CH16-1FY Condition : PEAK_74 3m 91200_1522 HORIZONTAL Detector : Peak Project : 010732</p>	<p>Site : 03CH16-1FY Condition : PEAK_74 3m 91200_1522 VERTICAL Detector : Peak Project : 010732</p>



Emission below 1GHz
2.4GHz WIFI 802.11b (LF)

Table with 2 columns: Horizontal and Vertical. Each column contains a spectral plot showing Level (dBuV/m) vs Frequency (MHz) from 50 to 1000 MHz. The plots show a blue signal line with several peaks and a red line labeled 'QP' at the top right. Metadata for both plots includes Site: 03CH16-11Y, Condition: QP 3m B1LOG_47020406, Detector: Peak, and Project: 010732.

QP / Peak



<Sample 1 with Battery 3>

2.4GHz 2400~2483.5MHz
WIFI 802.11b (Band Edge @ 3m)

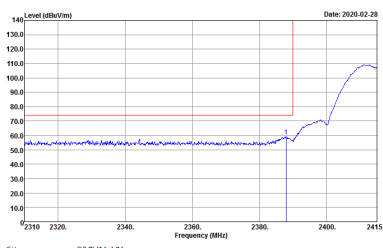
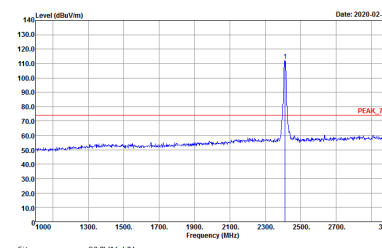
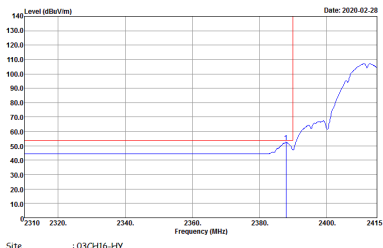
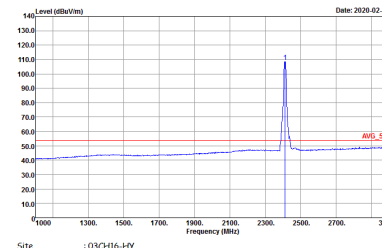
WIFI	2.4GHz 2400~2483.5MHz Band Edge @ 3m	
ANT	802.11b CH01 2412MHz	
1	Horizontal	Fundamental
Peak	 <p>Site : 03CH16-HY Condition : PEAK_BE_74 3m 91200_1522 HORIZONTAL Detector : Peak Project : 010732</p>	 <p>Site : 03CH16-HY Condition : PEAK_74 3m 91200_1522 HORIZONTAL Detector : Peak Project : 010732</p>
Avg.	 <p>Site : 03CH16-HY Condition : AVG_BE_54 3m 91200_1522 HORIZONTAL Detector : Peak Project : 010732</p>	 <p>Site : 03CH16-HY Condition : AVG_54 3m 91200_1522 HORIZONTAL Detector : Peak Project : 010732</p>

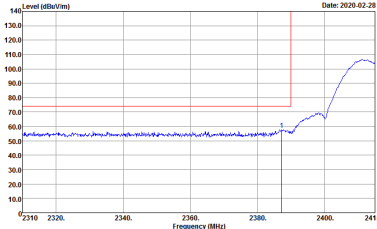
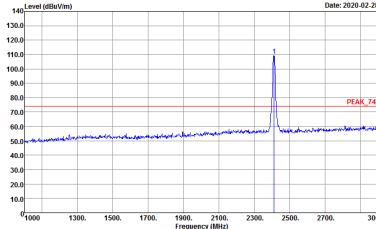
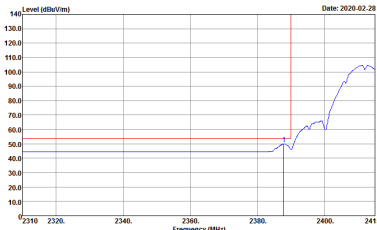
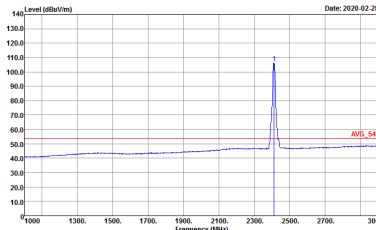

WIFI	2.4GHz 2400~2483.5MHz Band Edge @ 3m	
ANT	802.11b CH01 2412MHz	
1	Vertical	Fundamental
Peak	 <p>Site : 03CH16-HY Condition : PEAK_BE_74 3m 91200_1522 VERTICAL RBW:1000.000KHz VBW:3000.000KHz SWT:Auto Detector : Peak Project : 010732</p>	 <p>Site : 03CH16-HY Condition : PEAK_74 3m 91200_1522 VERTICAL RBW:1000.000KHz VBW:3000.000KHz SWT:Auto Detector : Peak Project : 010732</p>
Avg.	 <p>Site : 03CH16-HY Condition : AVG_BE_54 3m 91200_1522 VERTICAL RBW:1000.000KHz VBW:0.010KHz SWT:Auto Detector : Peak Project : 010732</p>	 <p>Site : 03CH16-HY Condition : AVG_54 3m 91200_1522 VERTICAL RBW:1000.000KHz VBW:0.010KHz SWT:Auto Detector : Peak Project : 010732</p>



2.4GHz 2400~2483.5MHz

WIFI 802.11b (Harmonic @ 3m)

WIFI	2.4GHz 2400~2483.5MHz Harmonic @ 3m	
ANT	802.11b CH01 2412MHz	
1	Horizontal	Vertical
Peak Avg.	<p>Site : 03CH16-1FY Condition : PEAK_74 3m 91200_1522 HORIZONTAL Detector : Peak Project : 010732</p>	<p>Site : 03CH16-1FY Condition : PEAK_74 3m 91200_1522 VERTICAL Detector : Peak Project : 010732</p>



Emission below 1GHz
2.4GHz WIFI 802.11b (LF)

WIFI	2.4GHz 2400~2483.5MHz	
ANT	802.11b LF	
1	Horizontal	Vertical
QP / Peak	<p>Site : 03CH16-1FY Condition : QP 3m B1LOG_47020406 HORIZONTAL Detector : Peak Project : 010732</p>	<p>Site : 03CH16-1FY Condition : QP 3m B1LOG_47020406 VERTICAL Detector : Peak Project : 010732</p>



Appendix D. Duty Cycle Plots

Band	Duty Cycle(%)	T(us)	1/T(kHz)	VBW Setting	Duty Factor(dB)
802.11b	98.80	-	-	10Hz	0.05
802.11g	95.37	2060	0.49	1kHz	0.21
2.4GHz 802.11n HT20	94.10	1915	0.52	1kHz	0.26
2.4GHz 802.11n HT40	91.79	950	1.05	3kHz	0.37
2.4GHz 802.11ac VHT20	95.10	1940	0.52	1kHz	0.22
2.4GHz 802.11ac VHT40	90.48	950	1.05	3kHz	0.43

802.11b

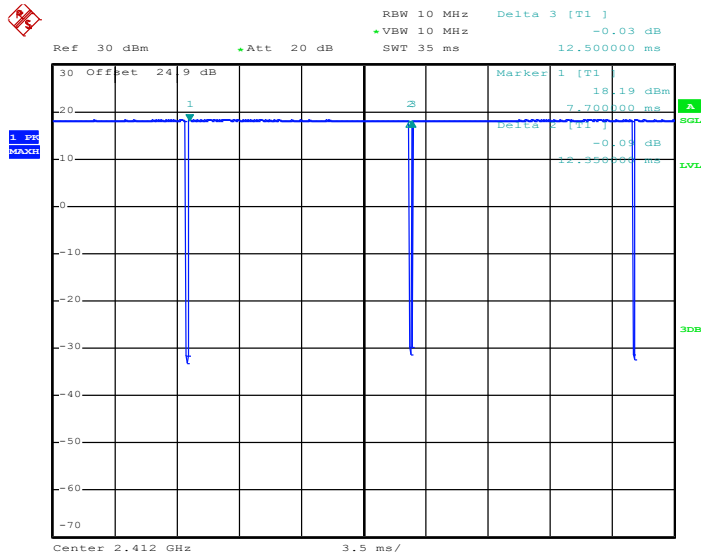

Date: 22.JAN.2020 20:01:05



802.11g

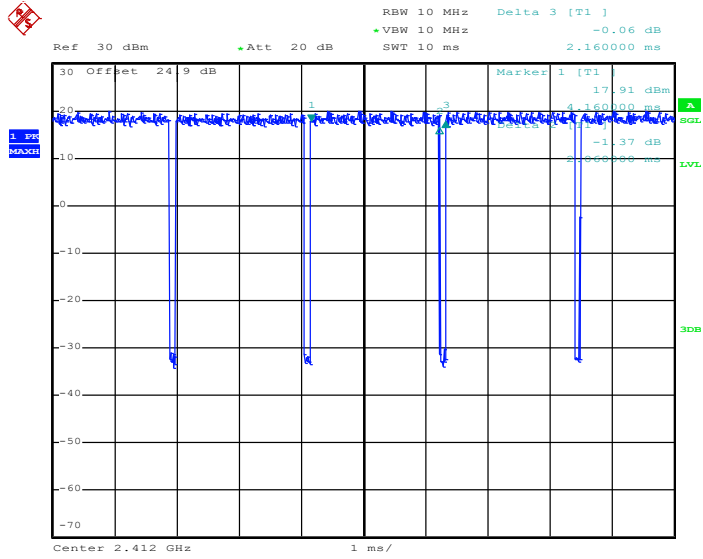

Date: 22.JAN.2020 20:03:16

802.11n HT20

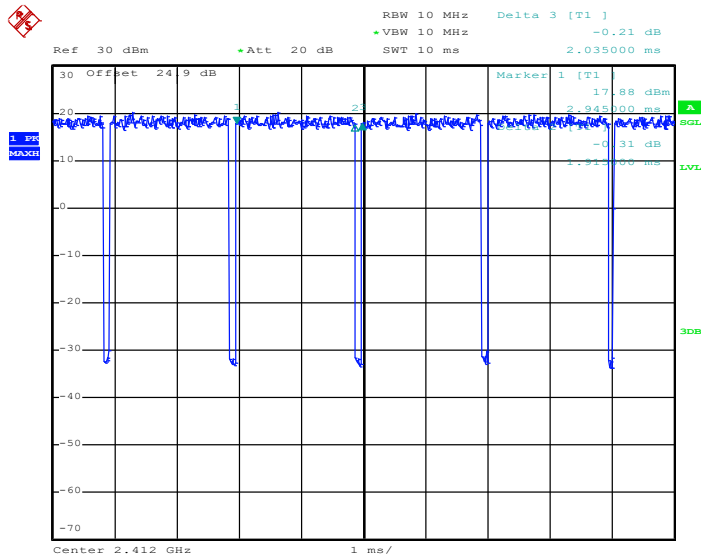

Date: 22.JAN.2020 20:04:40



802.11n HT40

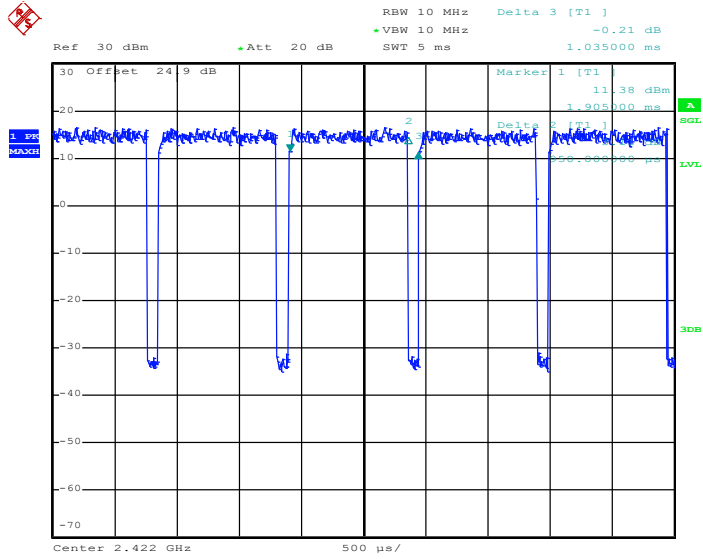

Date: 22.JAN.2020 20:05:53

802.11ac VHT20

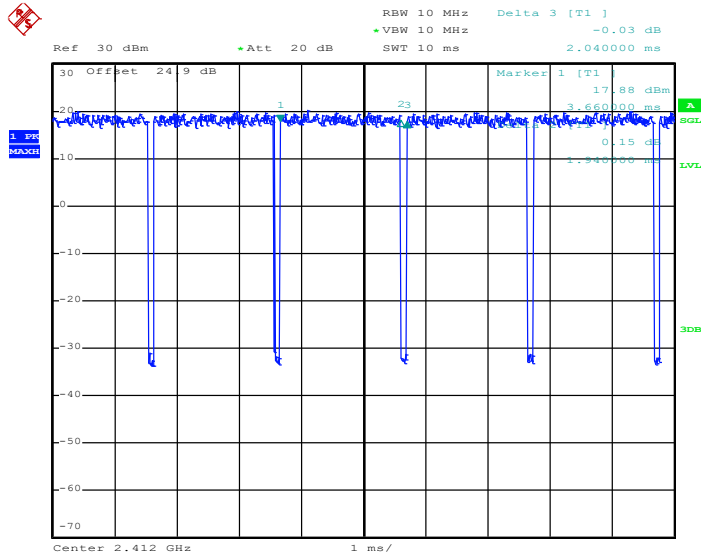

Date: 22.JAN.2020 20:07:35



802.11ac VHT40

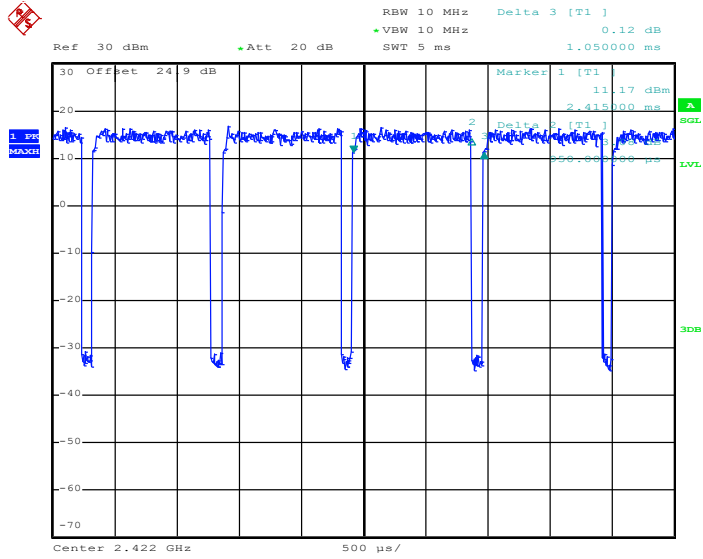

Date: 22.JAN.2020 20:09:26