



Test Report No.: RF2212WDG0234-1



TEST REPORT



Applicant	Sony Group Corporation
Address	1-7-1 Konan Minato-ku Tokyo 108-0075 JP

Manufacturer or Supplier	Sony Interactive Entertainment Inc.
Address	1-7-1 Konan Minato-ku Tokyo 108-0075 JP
Product	Computer Entertainment System
Brand Name	SONY
Model	CFI-Y1001
Additional Model & Model Difference	N/A
Date of tests	Mar. 02, 2023 ~ May 17, 2023

The tests have been carried out according to the requirements of the following standard:

FCC Part 15, Subpart C, Section 15.247

CONCLUSION: The submitted sample was found to COMPLY with the test requirement

Tested by Lucas Chen Project Engineer / EMC Department	Approved by Glyn He Assistant Manager / EMC Department
	 Date: Jun. 12, 2023

This report is governed by, and incorporates by reference, the Conditions of Testing as posted at the date of issuance of this report at <http://www.bureauveritas.com/home/about-us/our-business/cps/about-us/terms-conditions/> and is intended for your exclusive use. Any copying or replication of this report to or for any other person or entity, or use of our name or trademark, is permitted only with our prior written permission. This report sets forth our findings solely with respect to the test samples identified herein. The results set forth in this report are not indicative or representative of the quality or characteristics of the lot from which a test sample was taken or any similar or identical product unless specifically and expressly noted. Our report includes all of the tests requested by you and the results thereof based upon the information that you provided to us. Measurement uncertainty is only provided upon request for accredited tests. Statements of conformity are based on simple acceptance criteria without taking measurement uncertainty into account, unless otherwise requested in writing. You have 60 days from date of issuance of this report to notify us of any material error or omission caused by our negligence or if you require measurement uncertainty; provided, however, that such notice shall be in writing and shall specifically address the issue you wish to raise. A failure to raise such issue within the prescribed time shall constitute your unqualified acceptance of the completeness of this report, the tests conducted and the correctness of the report contents.

TABLE OF CONTENTS

RELEASE CONTROL RECORD	4
1 SUMMARY OF TEST RESULTS.....	5
2 MEASUREMENT UNCERTAINTY	5
3 GENERAL INFORMATION	6
3.1 GENERAL DESCRIPTION OF EUT	6
3.2 DESCRIPTION OF TEST MODES	8
3.2.1 CONFIGURATION OF SYSTEM UNDER TEST	8
3.2.2 TEST MODE APPLICABILITY AND TESTED CHANNEL DETAIL.....	8
3.3 GENERAL DESCRIPTION OF APPLIED STANDARDS	11
3.4 DESCRIPTION OF SUPPORT UNITS	11
3.5 CONFIGURATION OF SYSTEM UNDER TEST	12
3.6 DUTY CYCLE OF TESET SIGNAL.....	13
4 TEST TYPES AND RESULTS.....	14
4.1 CONDUCTED EMISSION MEASUREMENT	14
4.1.1 LIMITS OF CONDUCTED EMISSION MEASUREMENT	14
4.1.2 TEST INSTRUMENTS.....	14
4.1.3 TEST PROCEDURES	15
4.1.4 DEVIATION FROM TEST STANDARD	15
4.1.5 TEST SETUP	16
4.1.6 EUT OPERATING CONDITIONS	16
4.1.7 TEST RESULTS	17
4.2 RADIATED EMISSION MEASUREMENT	19
4.2.1 LIMITS OF RADIATED EMISSION MEASUREMENT	19
4.2.2 TEST INSTRUMENTS.....	20
4.2.3 TEST PROCEDURES	21
4.2.4 DEVIATION FROM TEST STANDARD	22
4.2.5 TEST SETUP	22
4.2.6 EUT OPERATING CONDITIONS	23
4.2.7 TEST RESULTS	24
4.3 6DB BANDWIDTH MEASUREMENT	32
4.3.1 LIMITS OF 6DB BANDWIDTH MEASUREMENT	32
4.3.2 TEST INSTRUMENTS.....	32
4.3.3 TEST PROCEDURE.....	33



4.3.4	DEVIATION FROM TEST STANDARD	33
4.3.5	TEST SETUP	34
4.3.6	EUT OPERATING CONDITIONS	34
4.3.7	TEST RESULTS	35
4.4	CONDUCTED OUTPUT POWER.....	39
4.4.1	LIMITS OF CONDUCTED OUTPUT POWER MEASUREMENT	39
4.4.2	TEST SETUP	39
4.4.3	TEST INSTRUMENTS.....	39
4.4.4	TEST PROCEDURES	39
4.4.5	DEVIATION FROM TEST STANDARD	39
4.4.6	EUT OPERATING CONDITIONS	39
4.4.7	TEST RESULTS	40
4.5	POWER SPECTRAL DENSITY MEASUREMENT	42
4.5.1	LIMITS OF POWER SPECTRAL DENSITY MEASUREMENT	42
4.5.2	TEST SETUP	42
4.5.3	TEST INSTRUMENTS.....	42
4.5.4	TEST PROCEDURE.....	42
4.5.5	DEVIATION FROM TEST STANDARD	42
4.5.6	EUT OPERATING CONDITION	42
4.5.7	TEST RESULTS	43
4.6	OUT OF BAND EMISSION MEASUREMENT	47
4.6.1	LIMITS OF OUT OF BAND EMISSION MEASUREMENT	47
4.6.2	TEST SETUP	47
4.6.3	TEST INSTRUMENTS.....	47
4.6.4	TEST PROCEDURE.....	47
4.6.5	DEVIATION FROM TEST STANDARD	48
4.6.6	EUT OPERATING CONDITION	48
4.6.7	TEST RESULTS	49
5	PHOTOGRAPHS OF THE TEST CONFIGURATION	52
6	APPENDIX A - MODIFICATIONS RECORDERS FOR ENGINEERING CHANGES TO THE EUT BY THE LAB	53



**BUREAU
VERITAS**

Test Report No.: RF2212WDG0234-1

RELEASE CONTROL RECORD

ISSUE NO.	REASON FOR CHANGE	DATE ISSUED
RF2212WDG0234-1	Original release	Jun. 12, 2023



1 SUMMARY OF TEST RESULTS

The EUT has been tested according to the following specifications:

APPLIED STANDARD: FCC PART 15, SUBPART C (SECTION 15.247)			
STANDARD SECTION	TEST TYPE AND LIMIT	RESULT	REMARK
15.207	AC Power Conducted Emission	PASS	Meet the requirement of limit.
15.205 15.209	Radiated Emission	PASS	Meet the requirement of limit.
15.247(d)	Out of band Emission Measurement	PASS	Meet the requirement of limit.
15.247(a)(2)	6dB bandwidth	PASS	Meet the requirement of limit.
15.247(b)	Conducted Output power	PASS	Meet the requirement of limit.
15.247(e)	Power Spectral Density	PASS	Meet the requirement of limit.
15.203	Antenna Requirement	PASS	Meet the requirement of limit.

2 MEASUREMENT UNCERTAINTY

Where relevant, the following measurement uncertainty levels have been estimated for tests performed on the EUT as specified in CISPR 16-4-2:

MEASUREMENT	FREQUENCY	UNCERTAINTY
Conducted emissions	0.15MHz ~ 30MHz	2.68dB
Radiated emissions	9KHz ~ 30MHz	2.80dB
	30MHz ~ 1GMHz	4.24dB
	1GHz ~ 18GHz	4.76dB
	18GHz ~ 40GHz	4.50dB

This uncertainty represents an expanded uncertainty expressed at approximately the 95% confidence level using a coverage factor of k = 2.



3 GENERAL INFORMATION

3.1 GENERAL DESCRIPTION OF EUT

PRODUCT	Computer Entertainment System
MODEL NO.	CFI-Y1001
ADDITIONAL MODEL	N/A
FCC ID	AK8CFIY1001
NOMINAL VOLTAGE	Powered by Type-C Host Unit or DC 3.87V from Li-ion Battery
MODULATION TECHNOLOGY	DTS
MODULATION TYPE	$\pi/4$ DQPSK
OPERATING FREQUENCY	2404.39578-2476.39578MHz
PEAK OUTPUT POWER	4.046mW (Max. Measured)
ANTENNA TYPE	Chain 0: FPCB Antenna, with 1.26dBi gain Chain 1: FPCB Antenna, with -0.85dBi gain
I/O PORTS	Refer to user's manual
CABLE SUPPLIED	Type-C Cable: Shielded, Detachable, 1.5m
RF POWER SETTING IN TEST SW	See notes 5

NOTES:

1. For a more detailed features description, please refer to the manufacturer's specifications or the user's manual.
2. For the test results, the EUT had been tested with all conditions. But only the worst case was shown in test report.
3. Please refer to the EUT photo document (Reference No.: 2212WDG0234-3) for detailed product photo.
4. The working status of the two antennas is as follows.

MODULATION MODE	TX FUNCTION
$\pi/4$ DQPSK	2 Chains (SISO)



5. By means of test software provided by manufacturer, the power levels during the tests were set according to the following codes:

Chain 0

$\pi/4$ DQPSK	
CHANNEL	POWER SETTING
1	0x11
19	0x11
37	0x11

Chain 1

$\pi/4$ DQPSK	
CHANNEL	POWER SETTING
1	0x11
19	0x11
37	0x11



3.2 DESCRIPTION OF TEST MODES

37 channels are provided for $\pi/4$ DQPSK:

CHANNEL	FREQ. (MHZ)	CHANNEL	FREQ. (MHZ)	CHANNEL	FREQ. (MHZ)	CHANNEL	FREQ. (MHZ)
1	2404.39578	11	2424.39578	21	2444.39578	31	2464.39578
2	2406.39578	12	2426.39578	22	2446.39578	32	2466.39578
3	2408.39578	13	2428.39578	23	2448.39578	33	2468.39578
4	2410.39578	14	2430.39578	24	2450.39578	34	2470.39578
5	2412.39578	15	2432.39578	25	2452.39578	35	2472.39578
6	2414.39578	16	2434.39578	26	2454.39578	36	2474.39578
7	2416.39578	17	2436.39578	27	2456.39578	37	2476.39578
8	2418.39578	18	2438.39578	28	2458.39578		
9	2420.39578	19	2440.39578	29	2460.39578		
10	2422.39578	20	2442.39578	30	2462.39578		

3.2.1 CONFIGURATION OF SYSTEM UNDER TEST

Please see section 5 photographs of the test configuration for reference.

3.2.2 TEST MODE APPLICABILITY AND TESTED CHANNEL DETAIL

Pre-Scan has been conducted to determine the worst-case mode from all possible combinations between available modulations, data rates, XYZ axis, power supply voltage range and antenna ports. The worst case was found when positioned on X axis for radiated emission. Following test modes were selected for the final test, and the final worst case is marked in boldface and recorded in the report:

EUT CONFIGURE MODE	APPLICABLE TO				DESCRIPTION
	RE<1G	RE≥1G	PLC	APCM	
A	√	√	√	-	Powered by Adaptor
B	-	-	-	√	Powered by DC 3.87V from Li-ion Battery

Where **RE<1G**: Radiated Emission below 1GHz **RE≥1G**: Radiated Emission above 1GHz
PLC: Power Line Conducted Emission **APCM**: Antenna Port Conducted Measurement



POWER LINE CONDUCTED EMISSION TEST:

- Pre-Scan has been conducted to determine the worst-case mode from all possible combinations between available modulations, antenna ports (if EUT with antenna diversity architecture), and packet types.
- Following channels were selected for the final test as listed below.

EUT CONFIGURE MODE	AVAILABLE CHANNEL	TESTED CHANNEL	MODULATION TECHNOLOGY	MODULATION TYPE
A	1 to 37	2.4G Link	DTS	$\pi/4$ DQPSK

For the test results, only the worst case was shown in test report.

RADIATED EMISSION TEST (BELOW 1GHz):

- Pre-Scan has been conducted to determine the worst-case mode from all possible combinations between available modulations, data rates, XYZ axis and antenna ports (if EUT with antenna diversity architecture).
- Following channels were selected for the final test as listed below.

EUT CONFIGURE MODE	AVAILABLE CHANNEL	TESTED CHANNEL	MODULATION TECHNOLOGY	MODULATION TYPE
A	1 to 37	37	DTS	$\pi/4$ DQPSK

For the test results, only the worst case was shown in test report.

RADIATED EMISSION TEST (ABOVE 1GHz):

Pre-Scan has been conducted to determine the worst-case mode from all possible combinations between available modulations, data rates, XYZ axis and antenna ports (if EUT with antenna diversity architecture).

- Following channels were selected for the final test as listed below.

EUT CONFIGURE MODE	AVAILABLE CHANNEL	TESTED CHANNEL	MODULATION TECHNOLOGY	MODULATION TYPE
A	1 to 37	1,19, 37	DTS	$\pi/4$ DQPSK



ANTENNA PORT CONDUCTED MEASUREMENT:

- This item includes all test value of each mode, but only includes spectrum plot of worst value of each mode.
- Pre-Scan has been conducted to determine the worst-case mode from all possible combinations between available modulations, data rates and antenna ports (if EUT with antenna diversity architecture).
- Following channels were selected for the final test as listed below.

EUT CONFIGURE MODE	AVAILABLE CHANNEL	TESTED CHANNEL	MODULATION TECHNOLOGY	MODULATION TYPE
B	1 to 37	1, 19, 37	DTS	π/4 DQPSK

TEST CONDITION:

APPLICABLE TO	ENVIRONMENTAL CONDITIONS	TEST VOLTAGE	TESTED BY
RE<1G	25deg. C, 55%RH	Powered by adaptor	Stalker
RE≥1G	25deg. C, 52%RH	Powered by adaptor	Stalker
PLC	25deg. C, 56%RH	Powered by adaptor	Ming Bai
APCM	25deg. C, 58%RH	DC 3.87V from fully battery	Vincent



3.3 GENERAL DESCRIPTION OF APPLIED STANDARDS

The EUT is a RF Product. According to the specifications of the manufacturer, it must comply with the requirements of the following standards:

FCC Part 15, Subpart C, Section 15.247

558074 D01 15.247 Meas Guidance v05r02

ANSI C63.10-2013

Note: All test items have been performed and recorded as per the above standards.

3.4 DESCRIPTION OF SUPPORT UNITS

The EUT has been tested as an independent unit together with other necessary accessories or support units. The following support units or accessories were used to form a representative test configuration during the tests.

NO.	PRODUCT	BRAND	MODEL NO.	SERIAL NO.	FCC ID
1	Adaptor	N/A	A829-120167C-US1	N/A	N/A
2	SPECIAL 2.4GHZ WIRELESS Debugging board	N/A	N/A	N/A	N/A

NO.	SIGNAL CABLE DESCRIPTION OF THE ABOVE SUPPORT UNITS
1	N/A
2	Type-C Cable: Shielded, Detachable, 1.5m

3.5 CONFIGURATION OF SYSTEM UNDER TEST

For Conducted Emission Test

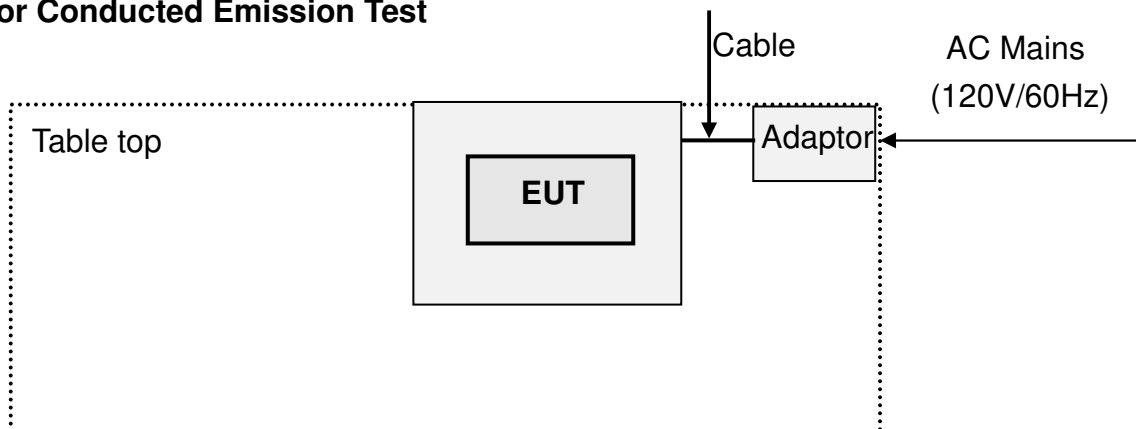

Note: For the actual test configuration, please refer to the attached file (Test Setup Photo).

For Radiated Emission Test

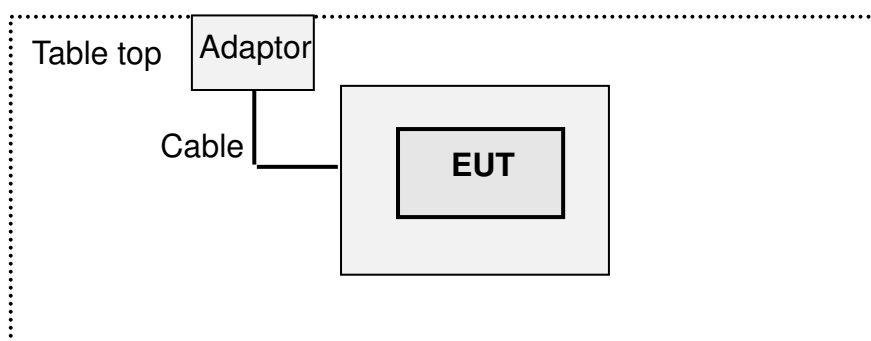

Note: For the actual test configuration, please refer to the attached file (Test Setup Photo).



**BUREAU
VERITAS**

Test Report No.: RF2212WDG0234-1

3.6 DUTY CYCLE OF TESET SIGNAL

Test Mode	On Time (ms)	Period (ms)	Duty Cycle (%)	VBW Setting
$\pi/4$ DQPSK	1	1	100	10Hz

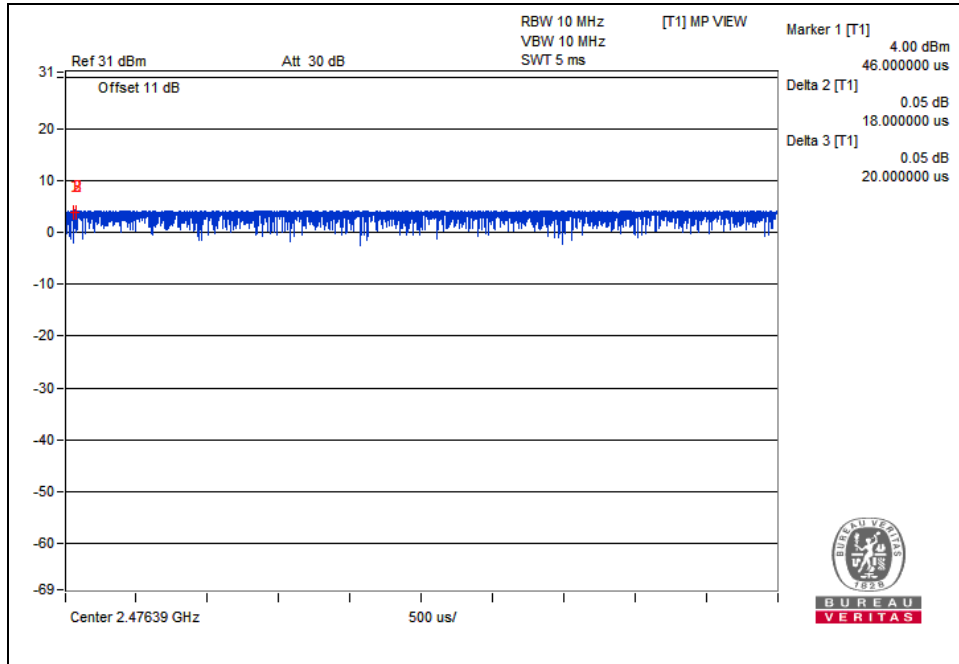



4 TEST TYPES AND RESULTS

4.1 CONDUCTED EMISSION MEASUREMENT

4.1.1 LIMITS OF CONDUCTED EMISSION MEASUREMENT

FREQUENCY OF EMISSION (MHz)	CONDUCTED LIMIT (dBµV)	
	Quasi-peak	Average
0.15 ~ 0.5	66 to 56	56 to 46
0.5 ~ 5	56	46
5 ~ 30	60	50

- NOTES:**
1. The lower limit shall apply at the transition frequencies.
 2. The limit decreases in line with the logarithm of the frequency in the range of 0.15 to 0.50MHz.
 3. All emanations from a class A/B digital device or system, including any network of conductors and apparatus connected thereto, shall not exceed the level of field strengths specified above.

4.1.2 TEST INSTRUMENTS

Equipment	Manufacturer	Model No.	Serial No.	Next Cal.
EMI Test Receiver	Rohde&Schwarz	ESR7	101494	Jan. 10,24
Artificial Mains Network	Rohde&Schwarz	ENV216	101173	Jan. 11,24
Artificial Mains Network	Rohde&Schwarz	ESH3-Z5	100317	Jan. 10,24
V-LISN (CISPR 25)	SCHWARZBECK	NNBM 8124-200	8124-200 05857	Jun. 14, 23
V-LISN (CISPR 25)	SCHWARZBECK	NNBM 8124-200	8124-200 05858	Jun. 14, 23
Voltage probe	SCHWARZBECK	TK 9421	TK 9421-176	Jul. 27, 23
Coaxial RF Cable	SUHNER	RG 223/U-CE	G2310066DG	Jul. 24, 23
Test software	ADT	ADT_Cond_V7.3.7	N/A	N/A

- NOTES:**
1. The test was performed in shielded room 553.
 2. The calibration interval of the above test instruments is 12 months. And the calibrations are traceable to CEPREI/CHINA, GRGT/CHINA and NIM/CHINA.



**BUREAU
VERITAS**

Test Report No.: RF2212WDG0234-1

4.1.3 TEST PROCEDURES

- a. The EUT was placed 0.4 meters from the conducting wall of the shielded room with EUT being connected to the power mains through a line impedance stabilization network (LISN). Other support units were connected to the power mains through another LISN. The two LISNs provide 50 ohm/ 50uH of coupling impedance for the measuring instrument.
- b. Both lines of the power mains connected to the EUT were checked for maximum conducted interference.
- c. The frequency range from 150kHz to 30MHz was searched. Emission levels under (Limit - 20dB) was not recorded.

NOTE: All modes of operation were investigated and the worst-case emissions are reported.

4.1.4 DEVIATION FROM TEST STANDARD

No deviation.



4.1.5 TEST SETUP

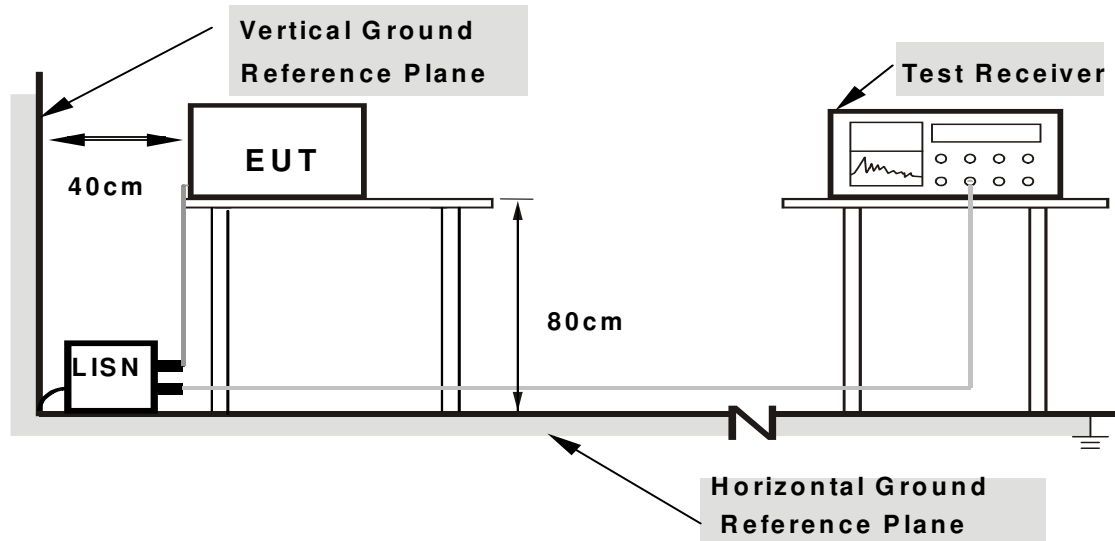

- Note: 1.Support units were connected to second LISN.**
2.Both of LISNs (AMN) are 80 cm from EUT and at least 80 from other units and other metal planes

For the actual test configuration, please refer to the attached file (Test Setup Photo).

4.1.6 EUT OPERATING CONDITIONS

- a. Turned on the power and connected of all equipment.
- b. EUT was operated according to the type used was description in manufacturer's specifications or the User's Manual.



**BUREAU
VERITAS**

Test Report No.: RF2212WDG0234-1

4.1.7 TEST RESULTS

CONDUCTED DATA: 2.4G Wireless Link

PHASE	Line	6dB BANDWIDTH	9kHz
--------------	------	----------------------	------

No.	Freq. [MHz]	Corr. Factor (dB)	Reading Value		Emission Level		Limit		Margin	
			[dB (uV)]		[dB (uV)]		[dB (uV)]		(dB)	
			Q.P.	AV.	Q.P.	AV.	Q.P.	AV.	Q.P.	AV.
1	0.15225	10.05	27.47	10.54	37.52	20.59	65.88	55.88	-28.40	-35.28
2	0.20627	10.11	27.00	11.06	37.11	21.17	63.40	53.40	-26.25	-32.19
3	0.34975	10.19	27.04	9.47	37.23	19.66	58.97	48.97	-21.74	-29.31
4	0.75812	10.24	26.28	10.38	36.52	20.62	56.00	46.00	-19.48	-25.38
5	5.00000	10.41	32.43	22.03	42.84	32.44	56.00	46.00	-13.16	-13.56
6	8.44350	10.64	34.91	25.06	45.55	35.70	60.00	50.00	-14.45	-14.30

REMARKS: The emission levels of other frequencies were very low against the limit.

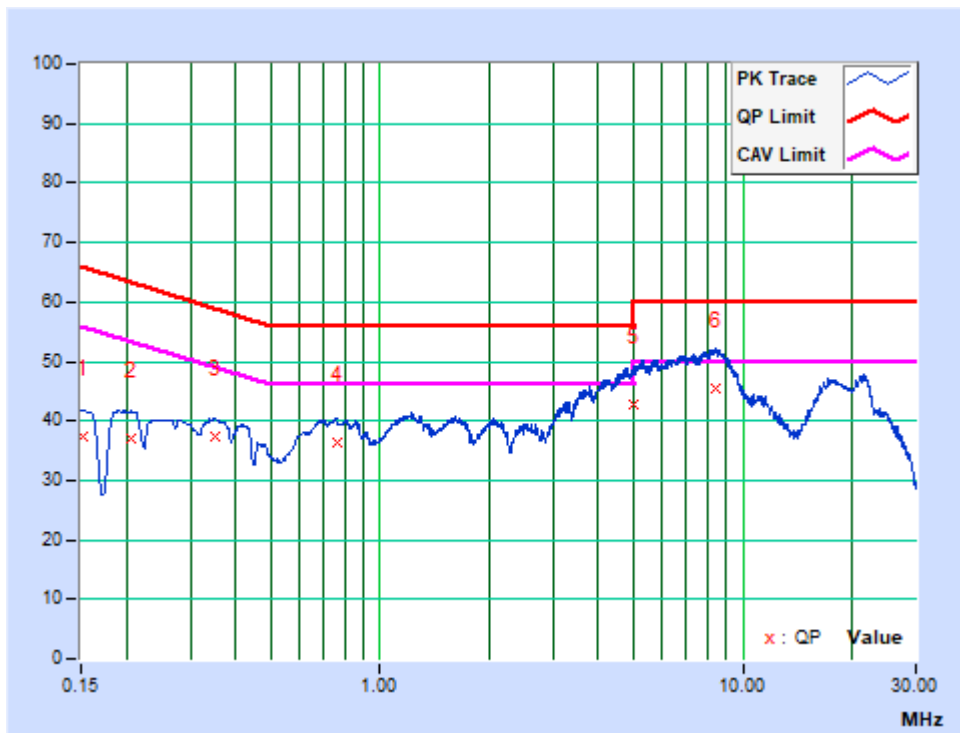



**BUREAU
VERITAS**

Test Report No.: RF2212WDG0234-1

PHASE	Neutral	6dB BANDWIDTH	9kHz
--------------	---------	----------------------	------

No.	Freq. [MHz]	Corr. Factor (dB)	Reading Value		Emission Level		Limit		Margin	
			[dB (uV)]		[dB (uV)]		[dB (uV)]		(dB)	
			Q.P.	AV.	Q.P.	AV.	Q.P.	AV.	Q.P.	AV.
1	0.21067	10.11	27.30	8.87	37.41	18.98	63.18	53.18	-25.77	-34.20
2	0.69900	10.24	26.26	9.67	36.50	19.91	56.00	46.00	-19.50	-26.09
3	1.12653	10.24	25.98	10.99	36.22	21.23	56.00	46.00	-19.78	-24.77
4	2.08725	10.26	23.03	10.90	33.29	21.16	56.00	46.00	-22.71	-24.84
5	5.00000	10.41	30.68	18.18	41.09	28.59	56.00	46.00	-14.91	-17.41
6	8.26575	10.63	32.02	20.86	42.65	31.49	60.00	50.00	-17.40	-18.51

REMARKS: The emission levels of other frequencies were very low against the limit.

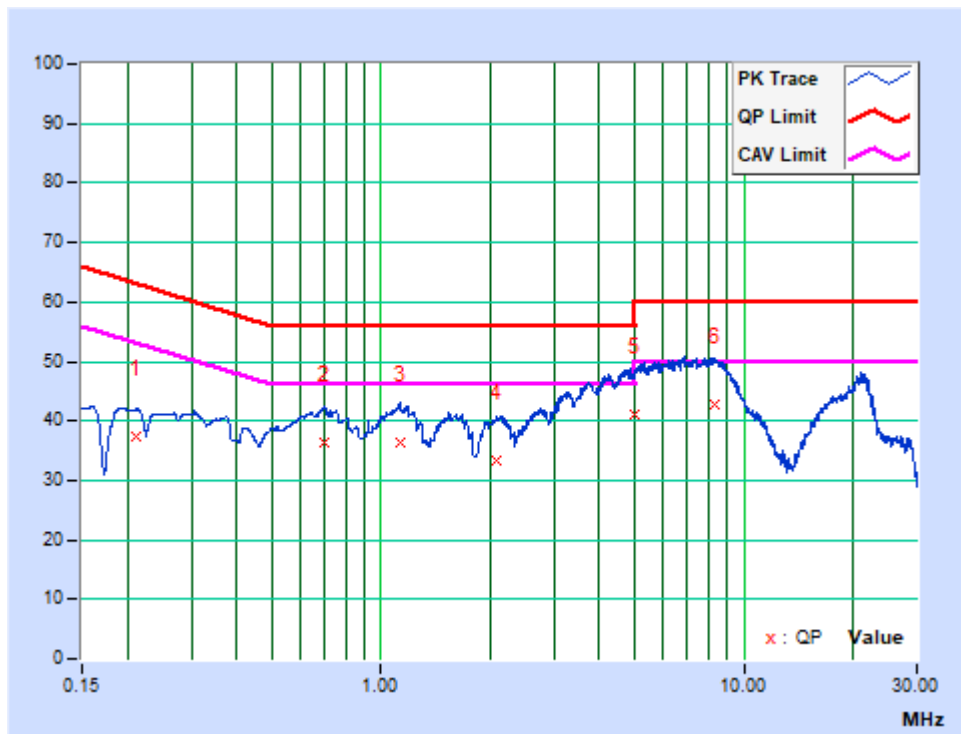

**Bureau Veritas Shenzhen Co., Ltd.
Dongguan Branch**

No. 96, Guantai Road (Houjie Section), Houjie
Town, Dongguan City, Guangdong Province.
523942. People's Republic of China.

Tel: +86 769 8998 2098
Fax: +86 769 8593 1080
Email: customerservice.dg@bureauveritas.com



4.2 RADIATED EMISSION MEASUREMENT

4.2.1 LIMITS OF RADIATED EMISSION MEASUREMENT

Radiated emissions which fall in the restricted bands, as defined in Section 15.205(a), must also comply with the radiated emission limits specified in Section 15.209(a).

FREQUENCIES (MHz)	FIELD STRENGTH (microvolts/meter)	MEASUREMENT DISTANCE (meters)
0.009 ~ 0.490	2400/F(kHz)	300
0.490 ~ 1.705	24000/F(kHz)	30
1.705 ~ 30.0	30	30
30 ~ 88	100	3
88 ~ 216	150	3
216 ~ 960	200	3
Above 960	500	3

NOTES:

1. The lower limit shall apply at the transition frequencies.
2. Emission level (dBuV/m) = 20 log Emission level (uV/m).
3. As shown in 15.35(b), for frequencies above 1000MHz, the field strength limits are based on average detector, however, the peak field strength of any emission shall not exceed the maximum permitted average limits, specified above by more than 20dB under any condition of modulation.



4.2.2 TEST INSTRUMENTS

Equipment	Manufacturer	Model No.	Serial No.	Next Cal.
EMI Test Receiver	Rohde&Schwarz	ESU40	100449	Jan. 10, 24
Signal and Spectrum Analyzer	Rohde&Schwarz	FSV7	102331	Apr. 05, 24
Active Loop Antenna (9KHz -30MHz)	SCHWARZBECK	FMZB 1519B	1519B-045	Apr. 20, 24
Amplifier (9KHz -1GHz)	Burgeon	BPA-530	100210	Mar. 06, 24
Trilog-Broadband Antenna	SCHWARZBECK	VULB 9168	9168-554	Jan. 08, 24
Horn Antenna (1GHz -18GHz)	ETS -Lindgren	3117	00062558	Apr. 01, 24
Horn Antenna (18GHz -40GHz)	SCHWARZBECK	BBHA 9170	BBHA9170147	Apr. 01, 24
3m Semi-anechoic Chamber	ETS-LINDGREN	9m*6m*6m	NSEMC003	May 22, 23
Test Software	ADT	ADT_Radiated_V7.6.15.9.2	N/A	N/A
Broadband Preamplifier (1GHz~18GHz)	SCHWARZBECK	BBV9718	305	Apr. 24, 24
Pre-Amplifier (18GHz-40GHz)	EMCI	EMC 184045	980102	Jan. 16, 24
BLUETOOTH TESTER	Rohde&Schwarz	CBT32	100811	N/A

NOTES:

1. The test was performed in 966 Chamber.
2. The calibration interval of the above test instruments is 12 months and the calibrations are traceable to CEPREI/CHINA, GRGT/CHINA and NIM/CHINA.
3. The horn antenna is used only for the measurement of emission frequency above 1GHz if tested.
4. The FCC Site Registration No. is 749762.



4.2.3 TEST PROCEDURES

- a. The EUT was placed on the top of a rotating table 1.5 meters (above 1GHz) and 0.8 meters (below 1GHz) above the ground at a 3 meters semi-anechoic chamber. The table was rotated 360 degrees to determine the position of the highest radiation.
- b. The EUT was set 3 meters away from the interference-receiving antenna, which was mounted on the top of a variable-height antenna tower.
- c. The antenna is a broadband antenna, and its height is varied from one meter to four meters above the ground to determine the maximum value of the field strength. Both horizontal and vertical polarizations of the antenna are set to make the measurement.
- d. For each suspected emission, the EUT was arranged to its worst case and then the antenna was tuned to heights from 1 meter to 4 meters and the rotatable table was turned from 0 degrees to 360 degrees to find the maximum reading.
- e. The test-receiver system was set to Peak Detect Function and Specified Bandwidth with Maximum Hold Mode.
- f. For below 30MHz, a loop antenna with its vertical plane is place 3m from the EUT and rotated about its vertical axis for maximum response at each azimuth about the EUT. And the centre of the loop shall be 1.3m above the ground.
- g. During the test, each emission was maximized by: having the EUT continuously working, investigated all operating modes, rotated about all 3 axis (X, Y & Z) and considered typical configuration to obtain worst position, manipulating interconnecting cables, For battery operated equipment, the equipment tests shall be perform using fresh batteries. The turntable was rotated to maximize the emission level.

NOTES:

1. The resolution bandwidth and video bandwidth of test receiver/spectrum analyzer is 120kHz for Quasi-peak detection at frequency below 1GHz.
2. The resolution bandwidth of test receiver/spectrum analyzer is 1 MHz and video bandwidth is 3MHz for Peak detection at frequency above 1GHz.
3. The resolution bandwidth of test receiver/spectrum analyzer is 1MHz and the video bandwidth is 10Hz(Duty cycle > 98%) for Average detection (AV) at frequency above 1GHz.
4. All modes of operation were investigated and the worst-case emissions are reported.
5. The testing of the EUT was performed on all 3 orthogonal axes; the worst-case test configuration was reported on the file test setup photo.



4.2.4 DEVIATION FROM TEST STANDARD

No deviation.

4.2.5 TEST SETUP

Below 30MHz test setup

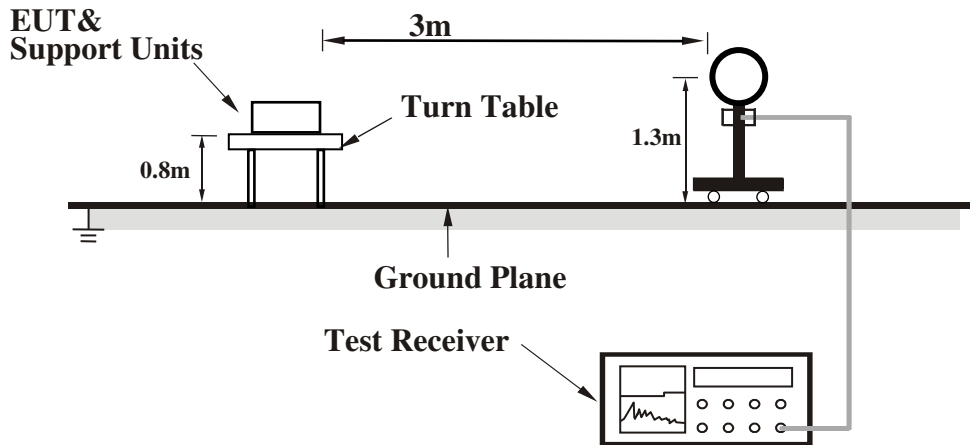

Below 1GHz test setup

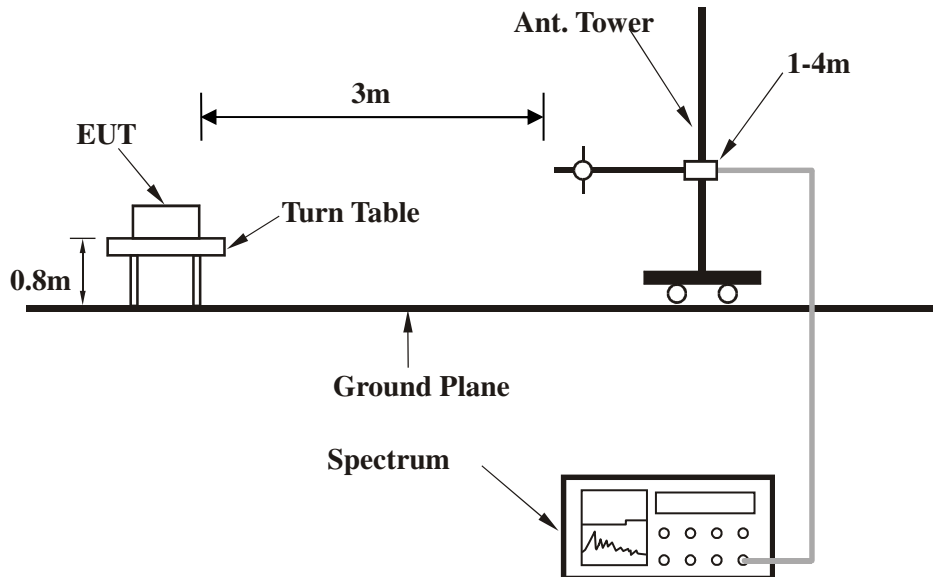

Note: For the actual test configuration, please refer to the attached file (Test Setup Photo).

Above 1GHz test setup

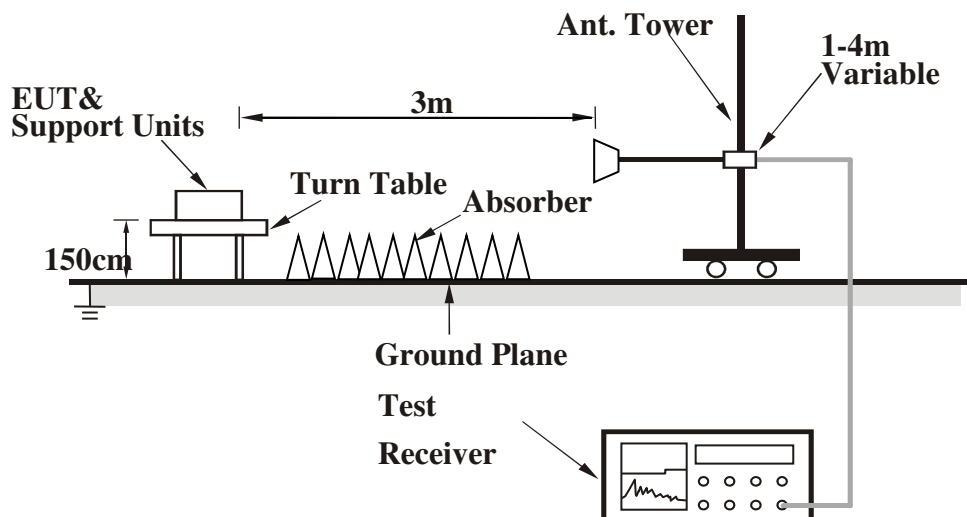

Note: For the actual test configuration, please refer to the attached file (Test Setup Photo).

4.2.6 EUT OPERATING CONDITIONS

- a. Set the EUT under full load condition and placed them on a testing table.
- b. Set the transmitter part of EUT under transmission condition continuously at specific channel frequency.
- c. The necessary accessories enable the EUT in full functions.



4.2.7 TEST RESULTS

BELOW 1GHz WORST-CASE DATA:

II/4 DQPSK (Worst-case chain 1)

CHANNEL	TX Channel 37	DETECTOR FUNCTION	Quasi-Peak (QP)
FREQUENCY RANGE	9KHz ~ 1GHz		

ANTENNA POLARITY & TEST DISTANCE: HORIZONTAL AT 3 M								
NO.	FREQ. (MHz)	EMISSION LEVEL (dBuV/m)	LIMIT (dBuV/m)	MARGIN (dB)	ANTENNA HEIGHT (m)	TABLE ANGLE (Degree)	RAW VALUE (dBuV)	CORRECTION FACTOR (dB/m)
1	30.00	25.2 QP	40.0	-14.8	2.00 H	55	43.2	-18.0
2	54.87	23.1 QP	40.0	-16.9	2.00 H	42	39.7	-16.6
3	103.06	26.5 QP	43.5	-17.0	2.00 H	68	47.1	-20.6
4	121.71	25.5 QP	43.5	-18.0	2.00 H	12	44.0	-18.6
5	297.37	17.1 QP	46.0	-28.9	2.00 H	120	31.8	-14.8
6	417.07	21.7 QP	46.0	-24.3	2.00 H	155	33.4	-11.7

REMARKS:

1. Emission level (dBuV/m) = Raw Value (dBuV) + Correction Factor (dB/m).
2. Correction Factor (dB/m) = Antenna Factor (dB/m) + Cable Factor (dB).
3. The emission levels of other frequencies were greater than 20dB margin.
4. 9KHz~30MHz have been test and test data more than 20dB margin.
5. Margin value = Emission level – Limit value

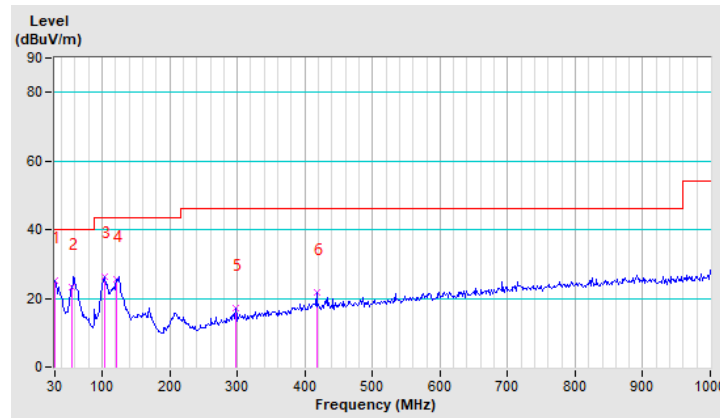



**BUREAU
VERITAS**

Test Report No.: RF2212WDG0234-1

CHANNEL	TX Channel 37	DETECTOR FUNCTION	Quasi-Peak (QP)
FREQUENCY RANGE	9KHz ~ 1GHz		

ANTENNA POLARITY & TEST DISTANCE: VERTICAL AT 3 M								
NO.	FREQ. (MHz)	EMISSION LEVEL (dBuV/m)	LIMIT (dBuV/m)	MARGIN (dB)	ANTENNA HEIGHT (m)	TABLE ANGLE (Degree)	RAW VALUE (dBuV)	CORRECTION FACTOR (dB/m)
1	30.00	27.0 QP	40.0	-13.1	2.00 V	110	45.0	-18.0
2	54.92	30.4 QP	40.0	-9.6	1.00 V	211	47.0	-16.6
3	106.17	26.9 QP	43.5	-16.6	1.90 V	166	47.0	-20.1
4	123.27	24.0 QP	43.5	-19.5	1.99 V	150	42.3	-18.3
5	297.37	20.0 QP	46.0	-26.0	2.00 V	136	34.8	-14.8
6	403.08	19.7 QP	46.0	-26.3	2.00 V	84	31.9	-12.2

REMARKS:

1. Emission level (dBuV/m) = Raw Value (dBuV) + Correction Factor (dB/m).
2. Correction Factor (dB/m) = Antenna Factor (dB/m) + Cable Factor (dB).
3. The emission levels of other frequencies were greater than 20dB margin.
4. 9KHz~30MHz have been test and test data more than 20dB margin.
5. Margin value = Emission level – Limit value

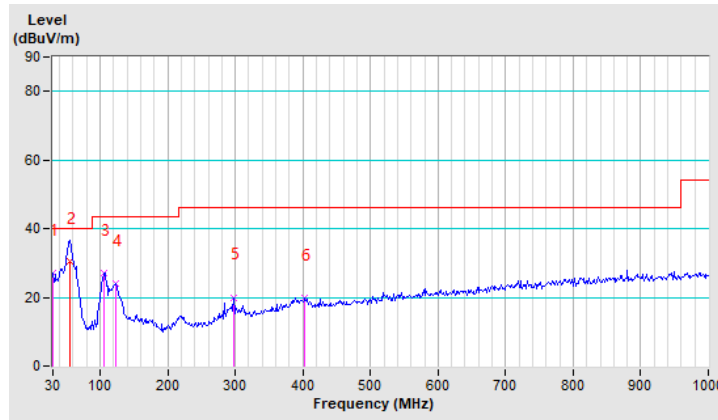

**Bureau Veritas Shenzhen Co., Ltd.
Dongguan Branch**

No. 96, Guantai Road (Houjie Section), Houjie
Town, Dongguan City, Guangdong Province.
523942. People's Republic of China.

Tel: +86 769 8998 2098
Fax: +86 769 8593 1080
Email: customerservice.dg@bureauveritas.com



**BUREAU
VERITAS**

Test Report No.: RF2212WDG0234-1

ABOVE 1GHz TEST DATA:

π/4 DQPSK

Chain 0

CHANNEL	TX Channel 1	DETECTOR FUNCTION	Peak (PK)
FREQUENCY RANGE	1GHz ~ 25GHz		Average (AV)

ANTENNA POLARITY & TEST DISTANCE : HORIZONTAL AT 3 M								
NO.	FREQ. (MHz)	EMISSION LEVEL (dBuV/m)	LIMIT (dBuV/m)	MARGIN (dB)	ANTENNA HEIGHT (m)	TABLE ANGLE (Degree)	RAW VALUE (dBuV)	CORRECTION FACTOR (dB/m)
1	2390.00	46.9 PK	74.0	-27.1	1.73 H	104	44.2	2.7
2	2390.00	35.9 AV	54.0	-18.1	1.73 H	104	33.2	2.7
3	*2404.39	95.0 PK			1.73 H	104	92.3	2.7
4	*2404.39	92.4 AV			1.73 H	104	89.7	2.7
5	4808.70	50.6 PK	74.0	-23.5	2.06 H	55	42.3	8.2
6	4808.70	40.3 AV	54.0	-13.7	2.06 H	55	32.0	8.2
7	#7213.05	51.3 PK	74.0	-22.7	1.00 H	92	41.8	9.5
8	#7213.05	40.2 AV	54.0	-13.8	1.00 H	92	30.7	9.5
ANTENNA POLARITY & TEST DISTANCE : VERTICAL AT 3 M								
NO.	FREQ. (MHz)	EMISSION LEVEL (dBuV/m)	LIMIT (dBuV/m)	MARGIN (dB)	ANTENNA HEIGHT (m)	TABLE ANGLE (Degree)	RAW VALUE (dBuV)	CORRECTION FACTOR (dB/m)
1	2390.00	47.2 PK	74.0	-26.8	1.00 V	82	44.5	2.7
2	2390.00	38.4 AV	54.0	-15.6	1.00 V	82	35.8	2.7
3	*2404.39	84.8 PK			1.05 V	82	82.1	2.7
4	*2404.39	80.6 AV			1.05 V	82	77.8	2.7
5	4808.70	51.3 PK	74.0	-22.7	1.80 V	96	43.1	8.2
6	4808.70	40.3 AV	54.0	-13.7	1.80 V	96	32.1	8.2
7	#7213.05	51.3 PK	74.0	-22.7	2.41 V	92	41.8	9.5
8	#7213.05	39.3 AV	54.0	-14.7	2.41 V	92	29.8	9.5

REMARKS:

1. Emission level (dBuV/m) = Raw Value (dBuV) + Correction Factor (dB/m).
2. Correction Factor (dB/m) = Antenna Factor (dB/m) + Cable Factor (dB).
3. The emission levels of other frequencies were greater than 20dB margin.
4. Margin value = Emission level – Limit value.
5. " * ": Fundamental frequency.
6. " # ": The radiated frequency is out of the restricted band.

Bureau Veritas Shenzhen Co., Ltd.
Dongguan Branch

No. 96, Guantai Road (Houjie Section), Houjie
Town, Dongguan City, Guangdong Province.
523942. People's Republic of China.

Tel: +86 769 8998 2098
Fax: +86 769 8593 1080
Email: customerservice.dg@bureauveritas.com



CHANNEL	TX Channel 19	DETECTOR FUNCTION	Peak (PK)
FREQUENCY RANGE	1GHz ~ 25GHz		Average (AV)

ANTENNA POLARITY & TEST DISTANCE : HORIZONTAL AT 3 M								
NO.	FREQ. (MHz)	EMISSION LEVEL (dBuV/m)	LIMIT (dBuV/m)	MARGIN (dB)	ANTENNA HEIGHT (m)	TABLE ANGLE (Degree)	RAW VALUE (dBuV)	CORRECTION FACTOR (dB/m)
1	*2440.39	95.8 PK			1.66 H	80	92.9	2.9
2	*2440.39	92.5 AV			1.66 H	80	89.6	2.9
3	4880.70	51.4 PK	74.0	-22.6	1.80 H	92	42.6	8.8
4	4880.70	39.5 AV	54.0	-14.5	1.80 H	92	30.8	8.8
5	7321.05	52.4 PK	74.0	-21.6	1.06 H	75	42.8	9.6
6	7321.05	40.3 AV	54.0	-13.7	1.06 H	75	30.7	9.6
ANTENNA POLARITY & TEST DISTANCE : VERTICAL AT 3 M								
NO.	FREQ. (MHz)	EMISSION LEVEL (dBuV/m)	LIMIT (dBuV/m)	MARGIN (dB)	ANTENNA HEIGHT (m)	TABLE ANGLE (Degree)	RAW VALUE (dBuV)	CORRECTION FACTOR (dB/m)
1	*2440.39	85.6 PK			1.00 V	155	82.8	2.9
2	*2440.39	81.7 AV			1.00 V	155	78.9	2.9
3	4880.70	48.9 PK	74.0	-25.1	1.00 V	95	40.2	8.8
4	4880.70	38.6 AV	54.0	-15.4	1.00 V	95	29.9	8.8
5	7321.05	49.4 PK	74.0	-24.6	1.00 V	108	39.8	9.6
6	7321.05	37.6 AV	54.0	-16.4	1.00 V	108	28.0	9.6

REMARKS:

1. Emission level (dBuV/m) = Raw Value (dBuV) + Correction Factor (dB/m).
2. Correction Factor (dB/m) = Antenna Factor (dB/m) + Cable Factor (dB).
3. The emission levels of other frequencies were greater than 20dB margin.
4. Margin value = Emission level – Limit value.
5. " * ": Fundamental frequency.



CHANNEL	TX Channel 37	DETECTOR FUNCTION	Peak (PK)
FREQUENCY RANGE	1GHz ~ 25GHz		Average (AV)

ANTENNA POLARITY & TEST DISTANCE : HORIZONTAL AT 3 M								
NO.	FREQ. (MHz)	EMISSION LEVEL (dBuV/m)	LIMIT (dBuV/m)	MARGIN (dB)	ANTENNA HEIGHT (m)	TABLE ANGLE (Degree)	RAW VALUE (dBuV)	CORRECTION FACTOR (dB/m)
1	*2476.39	93.3 PK			1.30 H	88	90.3	3.0
2	*2476.39	90.2 AV			1.30 H	88	87.2	3.0
3	2483.50	55.0 PK	74.0	-19.0	1.30 H	88	52.0	3.0
4	2483.50	42.8 AV	54.0	-11.2	1.30 H	88	39.8	3.0
5	4952.70	48.4 PK	74.0	-25.6	1.80 H	85	39.1	9.3
6	4952.70	38.7 AV	54.0	-15.3	1.80 H	85	29.4	9.3
7	7429.05	50.8 PK	74.0	-23.2	1.49 H	88	41.2	9.7
8	7429.05	39.9 AV	54.0	-14.1	1.49 H	88	30.2	9.7
ANTENNA POLARITY & TEST DISTANCE : VERTICAL AT 3 M								
NO.	FREQ. (MHz)	EMISSION LEVEL (dBuV/m)	LIMIT (dBuV/m)	MARGIN (dB)	ANTENNA HEIGHT (m)	TABLE ANGLE (Degree)	RAW VALUE (dBuV)	CORRECTION FACTOR (dB/m)
1	*2476.39	84.3 PK			1.34 V	224	81.3	3.0
2	*2476.39	80.8 AV			1.34 V	224	77.9	3.0
3	2483.50	46.5 PK	74.0	-27.5	1.33 V	223	43.6	3.0
4	2483.50	35.4 AV	54.0	-18.6	1.33 V	223	32.4	3.0
5	4952.70	49.1 PK	74.0	-24.9	1.48 V	34	39.9	9.3
6	4952.70	37.9 AV	54.0	-16.1	1.48 V	34	28.6	9.3
7	7429.05	49.1 PK	74.0	-24.9	1.32 V	48	39.4	9.7
8	7429.05	38.5 AV	54.0	-15.5	1.32 V	48	28.8	9.7

REMARKS:

1. Emission level (dBuV/m) = Raw Value (dBuV) + Correction Factor (dB/m).
2. Correction Factor (dB/m) = Antenna Factor (dB/m) + Cable Factor (dB).
3. The emission levels of other frequencies were greater than 20dB margin.
4. Margin value = Emission level – Limit value.
5. " * " : Fundamental frequency.



π/4 DQPSK

Chain 1

CHANNEL	TX Channel 1	DETECTOR FUNCTION	Peak (PK)
FREQUENCY RANGE	1GHz ~ 25GHz		Average (AV)

ANTENNA POLARITY & TEST DISTANCE : HORIZONTAL AT 3 M								
NO.	FREQ. (MHz)	EMISSION LEVEL (dBuV/m)	LIMIT (dBuV/m)	MARGIN (dB)	ANTENNA HEIGHT (m)	TABLE ANGLE (Degree)	RAW VALUE (dBuV)	CORRECTION FACTOR (dB/m)
1	2390.00	46.9 PK	74.0	-27.1	1.70 H	130	44.2	2.7
2	2390.00	34.7 AV	54.0	-19.3	1.70 H	130	32.0	2.7
3	*2404.39	94.7 PK			1.70 H	130	91.9	2.7
4	*2404.39	91.4 AV			1.70 H	130	88.6	2.7
5	4808.70	51.1 PK	74.0	-22.9	1.00 H	90	42.8	8.2
6	4808.70	41.3 AV	54.0	-12.7	1.00 H	90	33.1	8.2
7	#7213.05	49.1 PK	74.0	-24.9	2.00 H	51	39.6	9.5
8	#7213.05	38.8 AV	54.0	-15.2	2.00 H	51	29.3	9.5
ANTENNA POLARITY & TEST DISTANCE : VERTICAL AT 3 M								
NO.	FREQ. (MHz)	EMISSION LEVEL (dBuV/m)	LIMIT (dBuV/m)	MARGIN (dB)	ANTENNA HEIGHT (m)	TABLE ANGLE (Degree)	RAW VALUE (dBuV)	CORRECTION FACTOR (dB/m)
1	2390.00	46.6 PK	74.0	-27.4	1.10 V	70	43.9	2.7
2	2390.00	36.7 AV	54.0	-17.3	1.10 V	70	34.0	2.7
3	*2404.39	92.4 PK			1.10 V	70	89.6	2.7
4	*2404.39	86.7 AV			1.10 V	70	84.0	2.7
5	4808.70	51.0 PK	74.0	-23.0	1.00 V	85	42.8	8.2
6	4808.70	41.0 AV	54.0	-13.0	1.00 V	85	32.8	8.2
7	#7213.05	50.1 PK	74.0	-23.9	1.60 V	52	40.6	9.5
8	#7213.05	38.7 AV	54.0	-15.3	1.60 V	52	29.2	9.5

REMARKS:

1. Emission level (dBuV/m) = Raw Value (dBuV) + Correction Factor (dB/m).
2. Correction Factor (dB/m) = Antenna Factor (dB/m) + Cable Factor (dB).
3. The emission levels of other frequencies were greater than 20dB margin.
4. Margin value = Emission level – Limit value.
5. " * " : Fundamental frequency.
6. " # " : The radiated frequency is out of the restricted band.



**BUREAU
VERITAS**

Test Report No.: RF2212WDG0234-1

CHANNEL	TX Channel 19	DETECTOR FUNCTION	Peak (PK)
FREQUENCY RANGE	1GHz ~ 25GHz		Average (AV)

ANTENNA POLARITY & TEST DISTANCE : HORIZONTAL AT 3 M								
NO.	FREQ. (MHz)	EMISSION LEVEL (dBuV/m)	LIMIT (dBuV/m)	MARGIN (dB)	ANTENNA HEIGHT (m)	TABLE ANGLE (Degree)	RAW VALUE (dBuV)	CORRECTION FACTOR (dB/m)
1	*2440.39	96.3 PK			1.70 H	96	93.4	2.9
2	*2440.39	92.4 AV			1.70 H	96	89.5	2.9
3	4880.70	48.1 PK	74.0	-25.9	1.40 H	280	39.3	8.8
4	4880.70	37.8 AV	54.0	-16.2	1.40 H	280	29.1	8.8
5	7321.05	48.6 PK	74.0	-25.4	1.75 H	352	39.1	9.6
6	7321.05	37.3 AV	54.0	-16.7	1.75 H	352	27.7	9.6
ANTENNA POLARITY & TEST DISTANCE : VERTICAL AT 3 M								
NO.	FREQ. (MHz)	EMISSION LEVEL (dBuV/m)	LIMIT (dBuV/m)	MARGIN (dB)	ANTENNA HEIGHT (m)	TABLE ANGLE (Degree)	RAW VALUE (dBuV)	CORRECTION FACTOR (dB/m)
1	*2440.39	93.5 PK			1.00 V	85	90.6	2.9
2	*2440.39	87.5 AV			1.00 V	85	84.6	2.9
3	4880.70	48.7 PK	74.0	-25.3	1.00 V	19	40.0	8.8
4	4880.70	38.2 AV	54.0	-15.8	1.00 V	19	29.5	8.8
5	7321.05	50.0 PK	74.0	-24.0	1.00 V	202	40.4	9.6
6	7321.05	38.2 AV	54.0	-15.8	1.00 V	202	28.6	9.6

REMARKS:

1. Emission level (dBuV/m) = Raw Value (dBuV) + Correction Factor (dB/m).
2. Correction Factor (dB/m) = Antenna Factor (dB/m) + Cable Factor (dB).
3. The emission levels of other frequencies were greater than 20dB margin.
4. Margin value = Emission level – Limit value.
5. " * ": Fundamental frequency.

Bureau Veritas Shenzhen Co., Ltd.
Dongguan Branch

No. 96, Guantai Road (Houjie Section), Houjie
Town, Dongguan City, Guangdong Province.
523942. People's Republic of China.

Tel: +86 769 8998 2098
Fax: +86 769 8593 1080
Email: customerservice.dg@bureauveritas.com



BUREAU
VERITAS

Test Report No.: RF2212WDG0234-1

CHANNEL	TX Channel 37	DETECTOR FUNCTION	Peak (PK)
FREQUENCY RANGE	1GHz ~ 25GHz		Average (AV)

ANTENNA POLARITY & TEST DISTANCE : HORIZONTAL AT 3 M								
NO.	FREQ. (MHz)	EMISSION LEVEL (dBuV/m)	LIMIT (dBuV/m)	MARGIN (dB)	ANTENNA HEIGHT (m)	TABLE ANGLE (Degree)	RAW VALUE (dBuV)	CORRECTION FACTOR (dB/m)
1	*2476.39	94.8 PK			2.44 H	273	91.8	3.0
2	*2476.39	91.3 AV			2.44 H	273	88.4	3.0
3	2483.50	59.9 PK	74.0	-14.1	2.44 H	273	57.0	3.0
4	2483.50	44.5 AV	54.0	-9.5	2.44 H	273	41.5	3.0
5	4952.70	50.1 PK	74.0	-23.9	2.40 H	252	40.8	9.3
6	4952.70	38.2 AV	54.0	-15.8	2.40 H	252	28.9	9.3
7	7429.05	51.3 PK	74.0	-22.7	2.08 H	70	41.6	9.7
8	7429.05	40.4 AV	54.0	-13.6	2.08 H	70	30.7	9.7
ANTENNA POLARITY & TEST DISTANCE : VERTICAL AT 3 M								
NO.	FREQ. (MHz)	EMISSION LEVEL (dBuV/m)	LIMIT (dBuV/m)	MARGIN (dB)	ANTENNA HEIGHT (m)	TABLE ANGLE (Degree)	RAW VALUE (dBuV)	CORRECTION FACTOR (dB/m)
1	*2476.39	90.8 PK			1.23 V	65	87.9	3.0
2	*2476.39	87.3 AV			1.23 V	65	84.3	3.0
3	2483.50	55.9 PK	74.0	-18.1	1.23 V	65	52.9	3.0
4	2483.50	45.6 AV	54.0	-8.4	1.23 V	65	42.6	3.0
5	4952.70	47.1 PK	74.0	-26.9	1.80 V	40	37.8	9.3
6	4952.70	37.3 AV	54.0	-16.7	1.80 V	40	28.1	9.3
7	7429.05	49.6 PK	74.0	-24.4	1.00 V	220	40.0	9.7
8	7429.05	39.3 AV	54.0	-14.7	1.00 V	220	29.6	9.7

REMARKS:

1. Emission level (dBuV/m) = Raw Value (dBuV) + Correction Factor (dB/m).
2. Correction Factor (dB/m) = Antenna Factor (dB/m) + Cable Factor (dB).
3. The emission levels of other frequencies were greater than 20dB margin.
4. Margin value = Emission level – Limit value.
5. " * " : Fundamental frequency.

Bureau Veritas Shenzhen Co., Ltd.
Dongguan Branch

No. 96, Guantai Road (Houjie Section), Houjie
Town, Dongguan City, Guangdong Province.
523942. People's Republic of China.

Tel: +86 769 8998 2098
Fax: +86 769 8593 1080
Email: customerservice.dg@bureauveritas.com



4.3 6dB BANDWIDTH MEASUREMENT

4.3.1 LIMITS OF 6dB BANDWIDTH MEASUREMENT

The minimum of 6dB Bandwidth Measurement is 0.5 MHz.

4.3.2 TEST INSTRUMENTS

Equipment	Manufacturer	Model No.	Serial No.	Next Cal.
Power Sensor	Keysight	U2021XA	MY57320002	Jan. 11, 24
Power Meter	Anritsu	ML2495A	1139001	Aug. 22, 23
Power Sensor	Anritsu	MA2411B	1531155	Aug. 22, 23
Digital Multimeter	FLUKE	15B	A1220010DG	N/A
Humid & Temp Programmable Tester	Haida	HD-225T	110807201	Nov. 02, 23
Oscilloscope	Agilent	DSO9254A	MY51260160	Jul. 27, 23
Signal and Spectrum Analyzer	Rohde&Schwarz	FSV40	101094	Jan. 11, 24
Signal Generator	Agilent	N5183A	MY50140980	Jul. 20, 23
MXG-B RF Vector Signal Generator	Keysight	N5182B	MY56200288	Jul. 20, 23
BLUETOOTH TESTER	Rohde&Schwarz	CBT32	100811	N/A
Attenuator	MINI	BW-S10W2+	S130129FGE2	N/A
DC Source	Keysight	E3642A	MY56146098	N/A
Test software	ADT	ADT_RF Test Software V6.6.5.3	N/A	N/A

NOTES:

1. The test was performed in RF Oven room.
2. The calibration interval of the above test instruments is 12 months and the calibrations are traceable to CEPREI/CHINA, GRGT/CHINA and NIM/CHINA.



**BUREAU
VERITAS**

Test Report No.: RF2212WDG0234-1

4.3.3 TEST PROCEDURE

1. Set RBW = 100 kHz.
2. Set the video bandwidth (VBW) ≥ 3 RBW.
3. Detector = Peak.
4. Trace mode = max hold.
5. Sweep = auto couple.
6. Allow the trace to stabilize.
7. Measure the maximum width of the emission that is constrained by the frequencies associated with the two outermost amplitude points (upper and lower frequencies) that are attenuated by 6 dB relative to the maximum level measured in the fundamental emission.

4.3.4 DEVIATION FROM TEST STANDARD

No deviation.



4.3.5 TEST SETUP

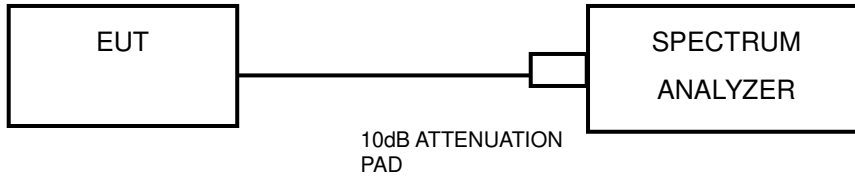

4.3.6 EUT OPERATING CONDITIONS

The software provided by client to enable the EUT under transmission condition continuously at lowest, middle and highest channel frequencies individually.



BUREAU VERITAS

Test Report No.: RF2212WDG0234-1

4.3.7 TEST RESULTS

II/4 DQPSK

Chain 0

CHANNEL	CHANNEL FREQUENCY (MHz)	6dB BANDWIDTH (MHz)	MINIMUM LIMIT (MHz)	PASS / FAIL
1	2404.39578	3.56	0.5	PASS
19	2440.39578	3.62	0.5	PASS
37	2476.39578	3.58	0.5	PASS

CH1

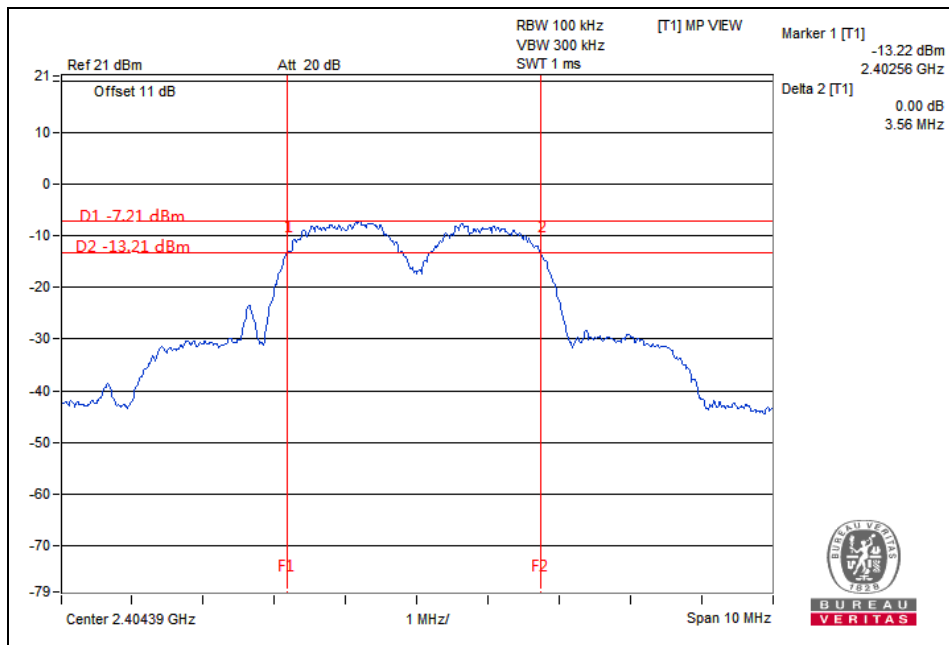



BUREAU VERITAS

Test Report No.: RF2212WDG0234-1

CH19

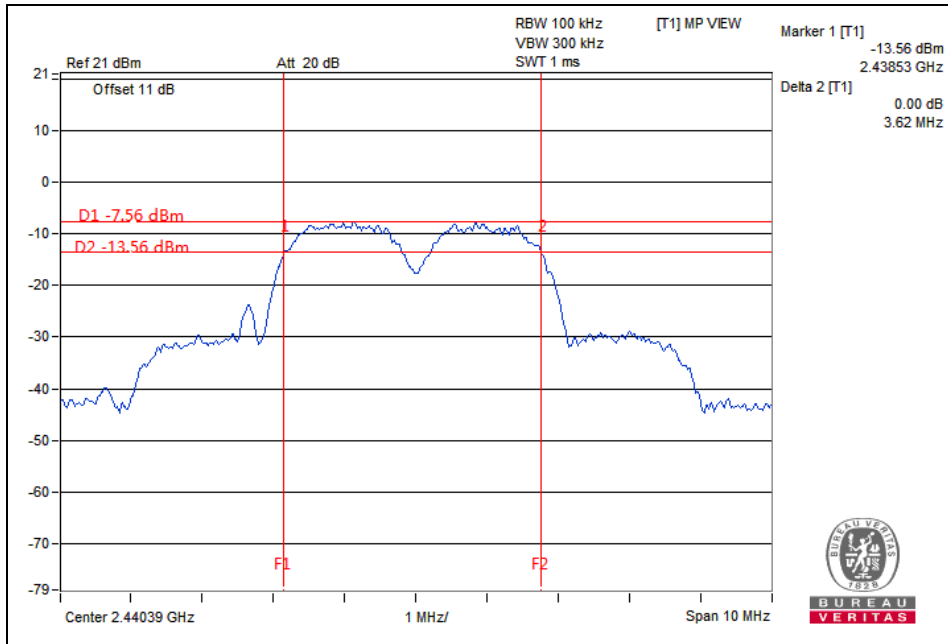

CH37

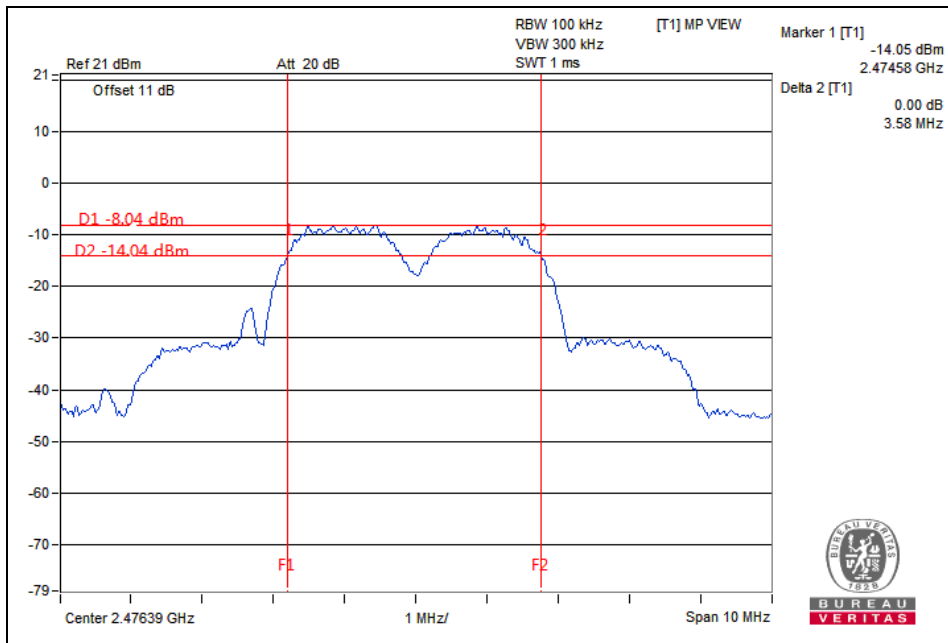



BUREAU VERITAS

Test Report No.: RF2212WDG0234-1

Chain 1

CHANNEL	CHANNEL FREQUENCY (MHz)	6dB BANDWIDTH (MHz)	MINIMUM LIMIT (MHz)	PASS / FAIL
1	2404.39578	3.54	0.5	PASS
19	2440.39578	3.58	0.5	PASS
37	2476.39578	3.50	0.5	PASS

CH1

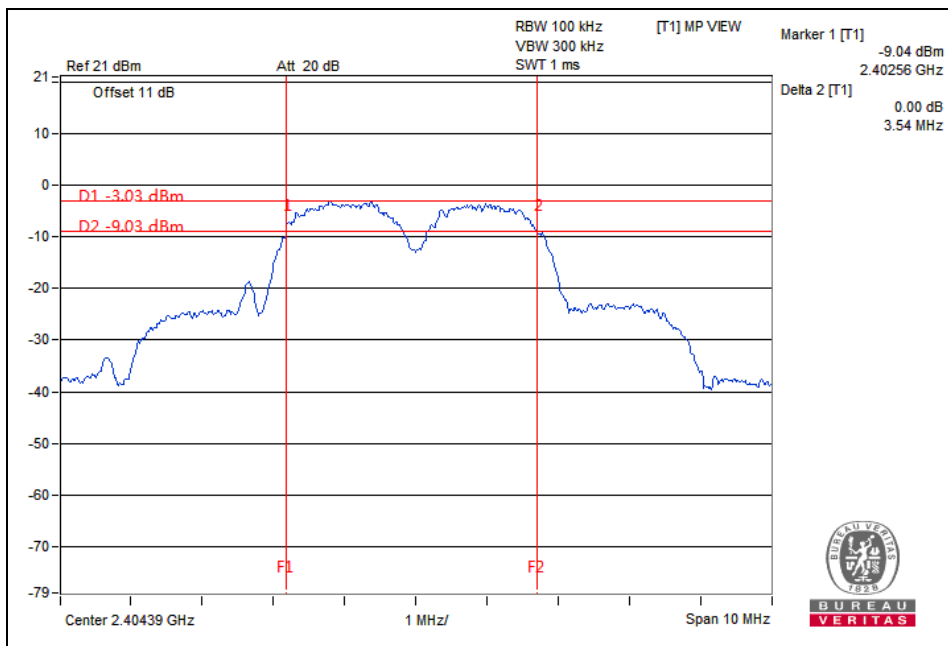



BUREAU VERITAS

Test Report No.: RF2212WDG0234-1

CH19

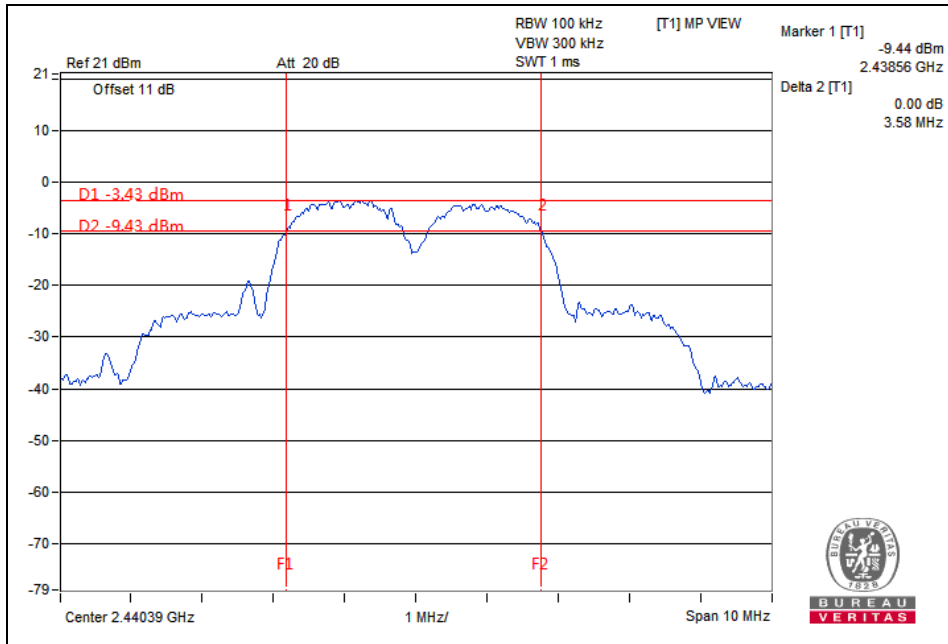

CH37

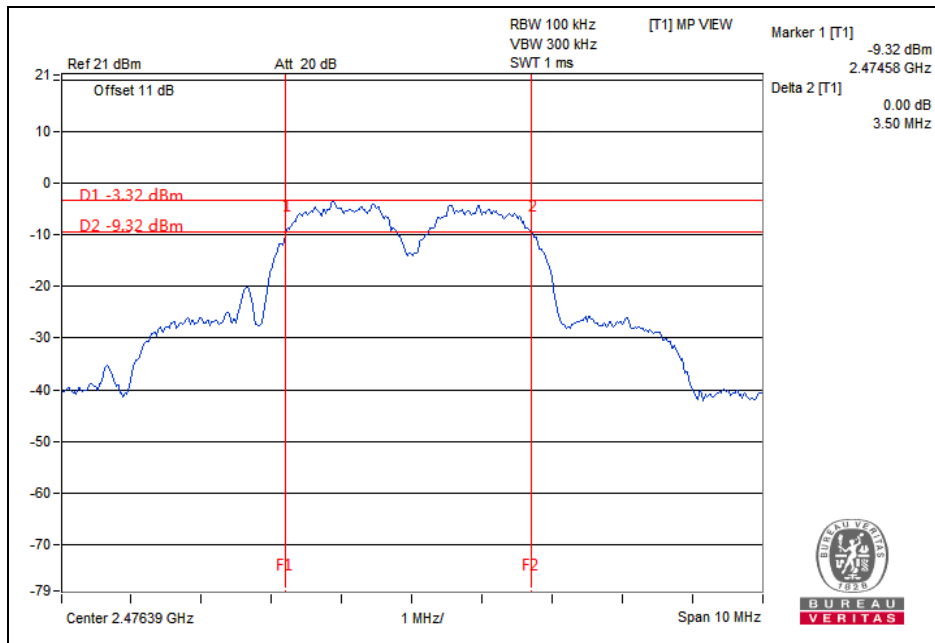



4.4 CONDUCTED OUTPUT POWER

4.4.1 LIMITS OF CONDUCTED OUTPUT POWER MEASUREMENT

For systems using digital modulation in the 2400–2483.5 MHz band: 1 Watt (30dBm)

4.4.2 TEST SETUP

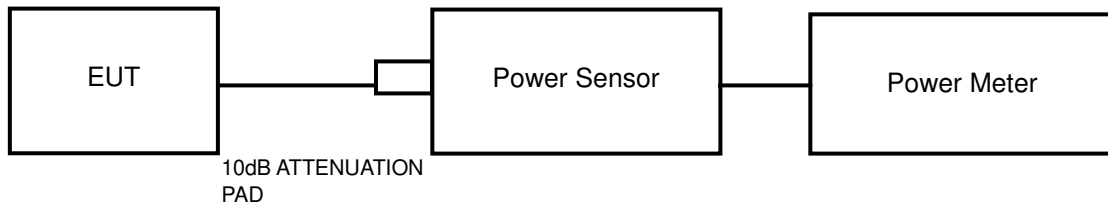

4.4.3 TEST INSTRUMENTS

Refer to section 4.3.2 to get information of above instrument.

4.4.4 TEST PROCEDURES

A peak power sensor was used on the output port of the EUT. A power meter was used to read the response of the peak power sensor and set the detector to PEAK. Record the power level.

An average power sensor was used on the output port of the EUT. A power meter was used to read the response of the average power sensor and set the detector to AVERAGE. Record the power level.

4.4.5 DEVIATION FROM TEST STANDARD

No deviation.

4.4.6 EUT OPERATING CONDITIONS

The software provided by client to enable the EUT under transmission condition continuously at lowest, middle and highest channel frequencies individually.



4.4.7 TEST RESULTS

MAXIMUM PEAK OUTPUT POWER

II/4 DQPSK

Chain 0

CHANNEL	CHANNEL FREQUENCY (MHz)	PEAK POWER (dBm)	PEAK POWER (mW)	PEAK POWER LIMIT (W)	PASS/FAIL
1	2404.39578	1.49	1.409	1	PASS
19	2440.39578	1.41	1.384	1	PASS
37	2476.39578	0.96	1.247	1	PASS

Chain 1

CHANNEL	CHANNEL FREQUENCY (MHz)	PEAK POWER (dBm)	PEAK POWER (mW)	PEAK POWER LIMIT (W)	PASS/FAIL
1	2404.39578	6.07	4.046	1	PASS
19	2440.39578	5.63	3.656	1	PASS
37	2476.39578	5.06	3.206	1	PASS

AVERAGE OUTPUT POWER (FOR REFERENCE)

The average power sensor was used on the output port of the EUT. A power meter was used to read the response of the power sensor. Record the power level.

II/4 DQPSK

Chain 0

CHANNEL	CHANNEL FREQUENCY (MHz)	AVERAGE POWER (dBm)
1	2404.39578	-2.04
19	2440.39578	-2.05
37	2476.39578	-2.46

Chain 1

CHANNEL	CHANNEL FREQUENCY (MHz)	AVERAGE POWER (dBm)
1	2404.39578	2.49
19	2440.39578	2.14
37	2476.39578	1.62



4.5 POWER SPECTRAL DENSITY MEASUREMENT

4.5.1 LIMITS OF POWER SPECTRAL DENSITY MEASUREMENT

The Maximum of Power Spectral Density Measurement is 8dBm/3KHz.

4.5.2 TEST SETUP

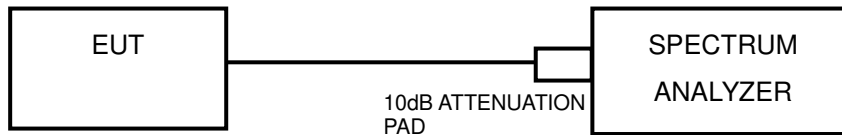

4.5.3 TEST INSTRUMENTS

Refer to section 4.3.2 to get information of above instrument.

4.5.4 TEST PROCEDURE

1. Set the span to 1.5 times the DTS bandwidth
2. Set the RBW = 3 kHz, VBW $\geq 3 \times$ RBW, Detector = peak.
3. Sweep time = auto couple, Trace mode = max hold, allow trace to fully stabilize.
4. Use the peak marker function to determine the maximum amplitude level.

4.5.5 DEVIATION FROM TEST STANDARD

No deviation.

4.5.6 EUT OPERATING CONDITION

The software provided by client to enable the EUT under transmission condition continuously at lowest, middle and highest channel frequencies individually.



BUREAU VERITAS

Test Report No.: RF2212WDG0234-1

4.5.7 TEST RESULTS

II/4 DQPSK

Chain 0

Channel	FREQ. (MHz)	PSD (dBm/3kHz)	Limit (dBm/3kHz)	PASS /FAIL
1	2404.39578	-22.05	8	PASS
19	2440.39578	-21.57	8	PASS
37	2476.39578	-21.32	8	PASS

CH1

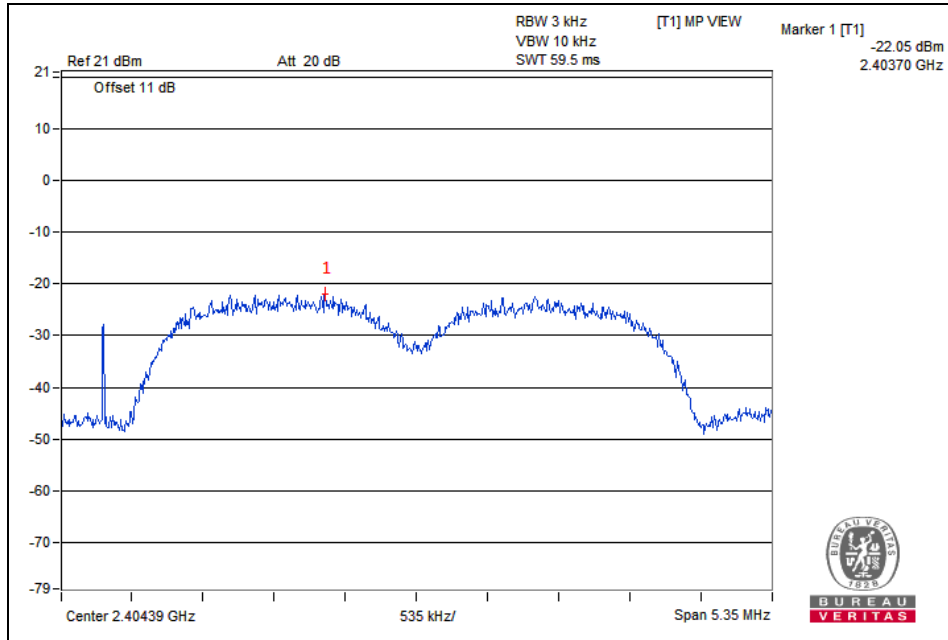



BUREAU VERITAS

Test Report No.: RF2212WDG0234-1

CH19

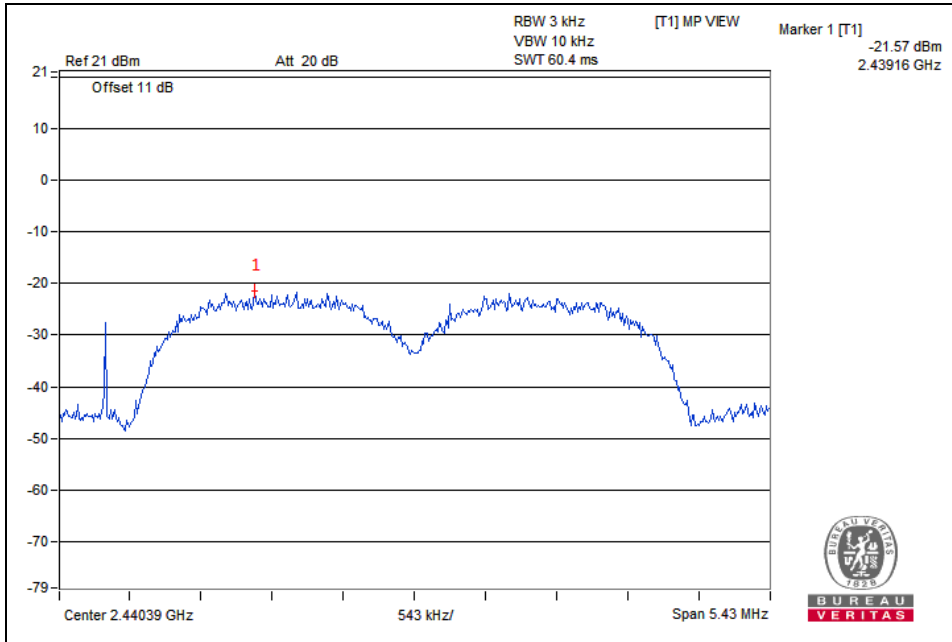

CH37

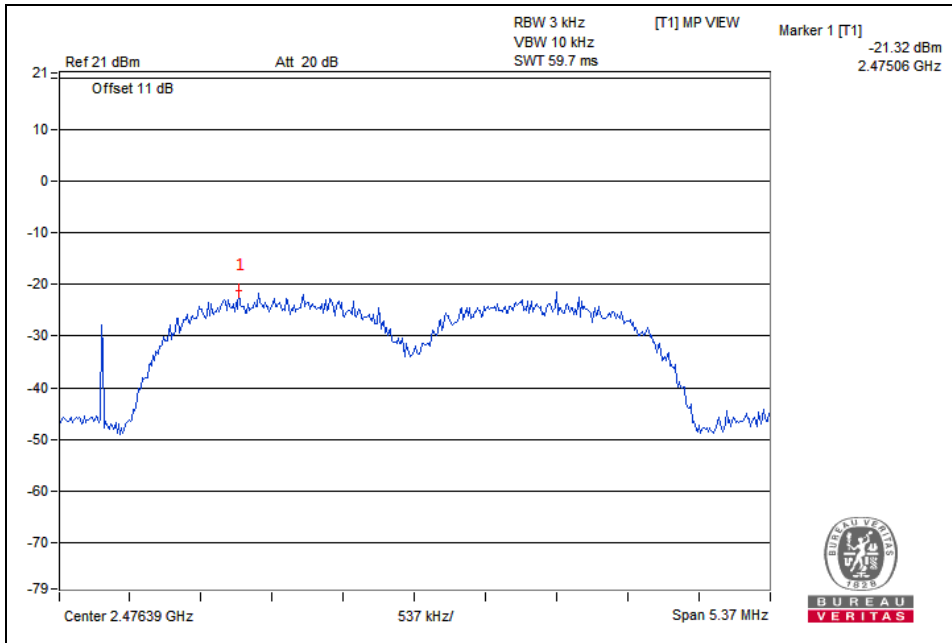



BUREAU VERITAS

Test Report No.: RF2212WDG0234-1

Chain 1

Channel	FREQ. (MHz)	PSD (dBm/3kHz)	Limit (dBm/3kHz)	PASS /FAIL
1	2404.39578	-16.53	8	PASS
19	2440.39578	-16.68	8	PASS
37	2476.39578	-17.75	8	PASS

CH1

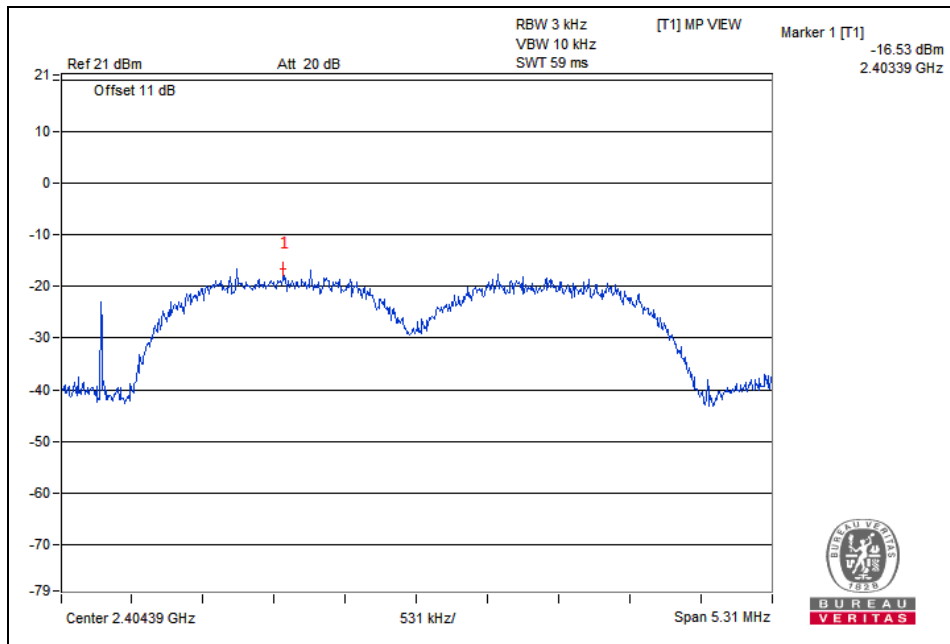



BUREAU VERITAS

Test Report No.: RF2212WDG0234-1

CH19

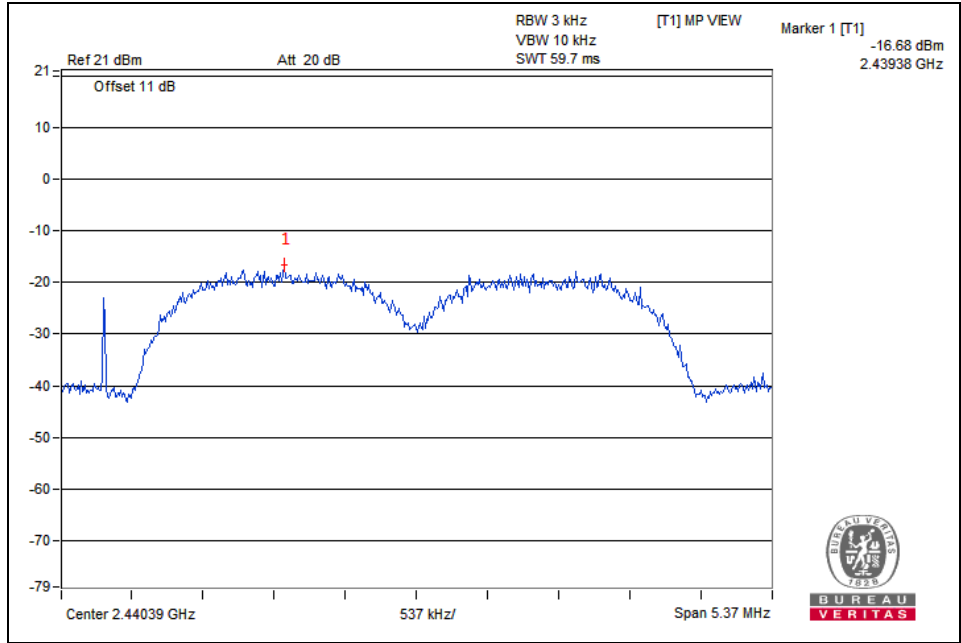

CH37

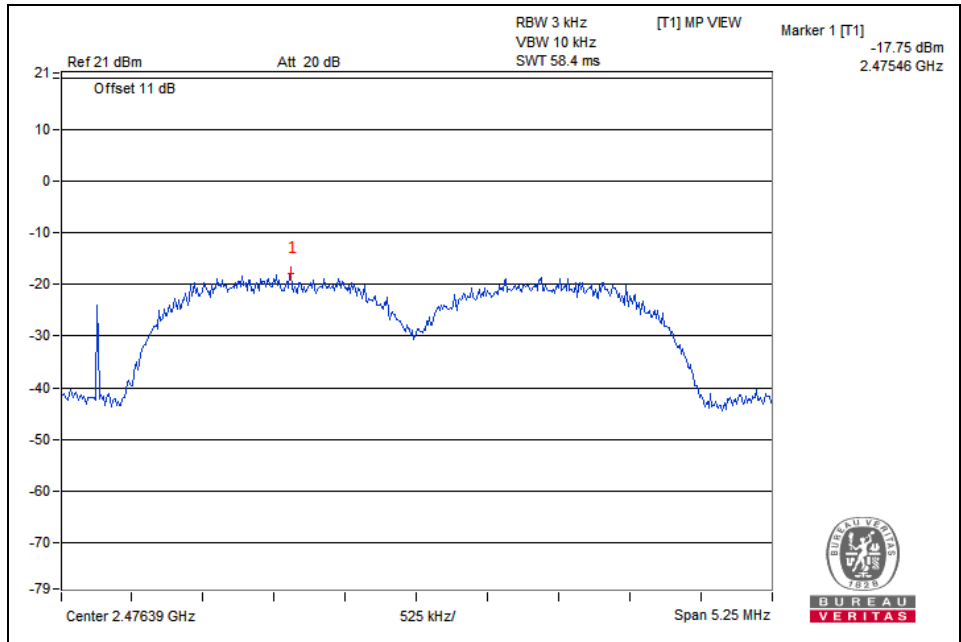

Bureau Veritas Shenzhen Co., Ltd.
Dongguan Branch

No. 96, Guantai Road (Houjie Section), Houjie
Town, Dongguan City, Guangdong Province.
523942. People's Republic of China.

Tel: +86 769 8998 2098
Fax: +86 769 8593 1080
Email: customerservice.dg@bureauveritas.com



4.6 OUT OF BAND EMISSION MEASUREMENT

4.6.1 LIMITS OF OUT OF BAND EMISSION MEASUREMENT

Below -20dB of the highest emission level of operating band (in 100kHz Resolution Bandwidth).

4.6.2 TEST SETUP

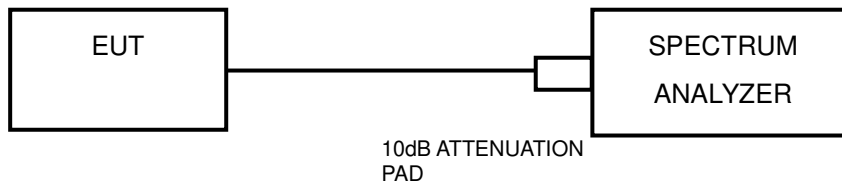

4.6.3 TEST INSTRUMENTS

Refer to section 4.3.2 to get information of above instrument.

4.6.4 TEST PROCEDURE

MEASUREMENT PROCEDURE REF

1. Set the RBW = 100 kHz.
2. Set the VBW \geq 300 kHz.
3. Detector = peak.
4. Sweep time = auto couple.
5. Trace mode = max hold.
6. Allow trace to fully stabilize.
7. Use the peak marker function to determine the maximum power level in any 100 kHz band segment within the fundamental EBW.



**BUREAU
VERITAS**

Test Report No.: RF2212WDG0234-1

MEASUREMENT PROCEDURE OOB

1. Set RBW = 100 kHz.
2. Set VBW \geq 300 kHz.
3. Set span to encompass the spectrum to be examined
4. Detector = peak.
5. Trace Mode = max hold.
6. Sweep = auto couple.

4.6.5 DEVIATION FROM TEST STANDARD

No deviation.

4.6.6 EUT OPERATING CONDITION

The software provided by client to enable the EUT under transmission condition continuously at lowest, middle and highest channel frequencies individually.



BUREAU VERITAS

Test Report No.: RF2212WDG0234-1

4.6.7 TEST RESULTS

Π/4 DQPSK

Chain 0

CH 1

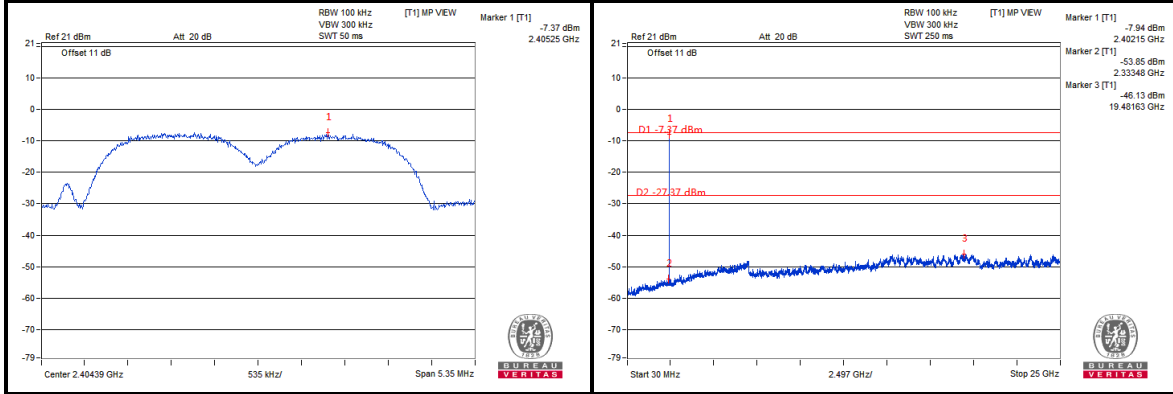

CH 19

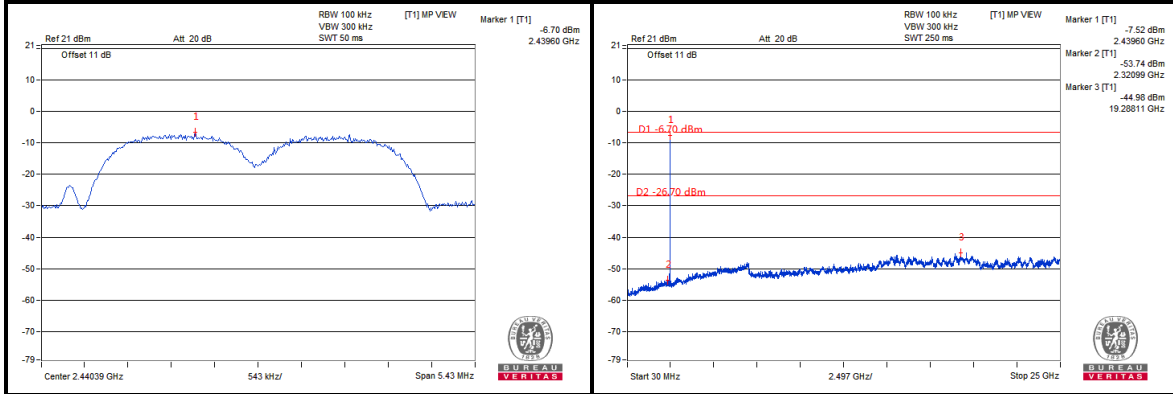

CH 37

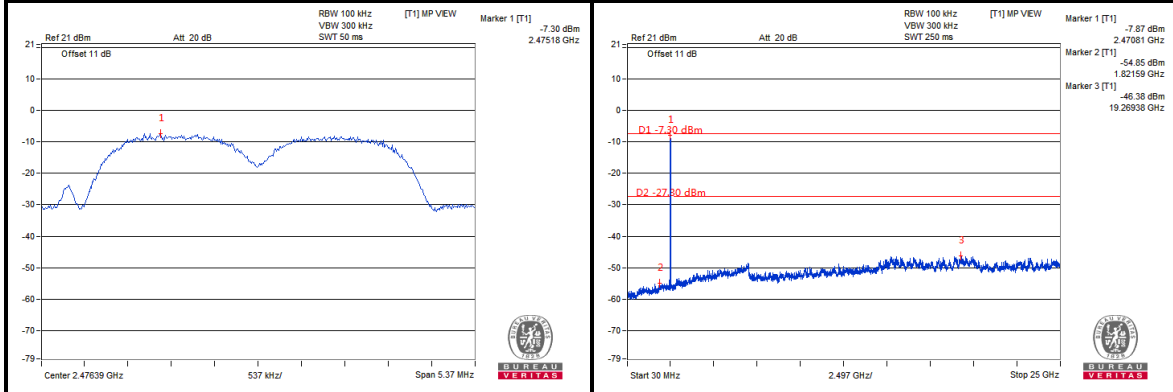

Bureau Veritas Shenzhen Co., Ltd.
Dongguan Branch

No. 96, Guantai Road (Houjie Section), Houjie
Town, Dongguan City, Guangdong Province.
523942, People's Republic of China.

Tel: +86 769 8998 2098
Fax: +86 769 8593 1080
Email: customerservice.dg@bureauveritas.com



BUREAU VERITAS

Test Report No.: RF2212WDG0234-1

Chain 1

CH 1

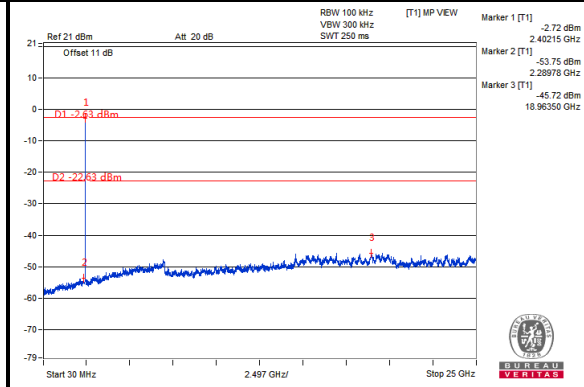
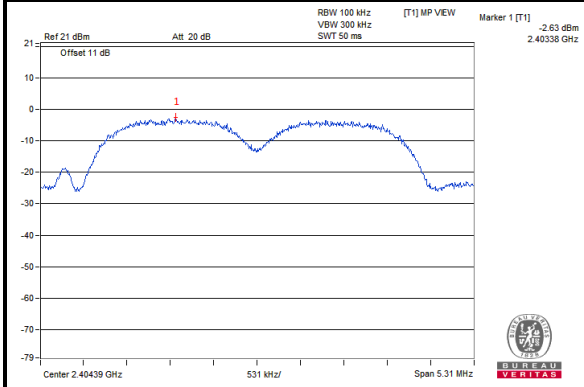

CH 19

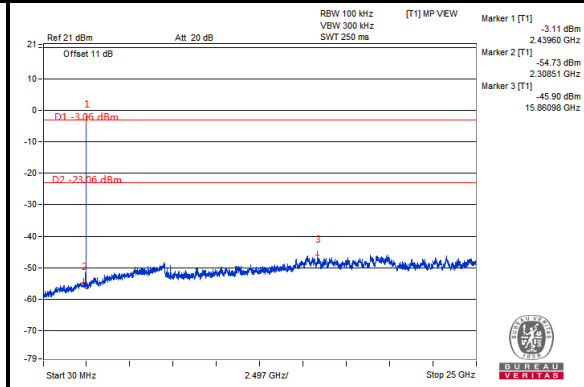
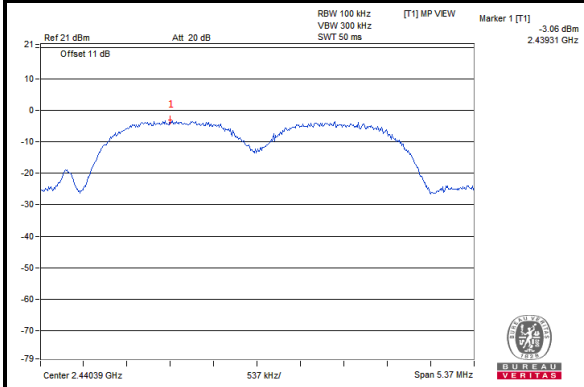

CH 37

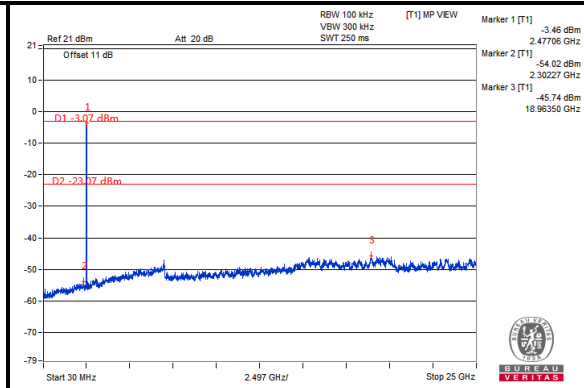
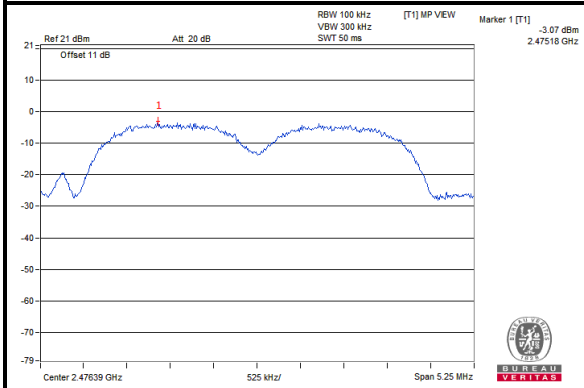

Bureau Veritas Shenzhen Co., Ltd. Dongguan Branch

No. 96, Guantai Road (Houjie Section), Houjie Town, Dongguan City, Guangdong Province. 523942. People's Republic of China.

Tel: +86 769 8998 2098 Fax: +86 769 8593 1080 Email: customerservice.dg@bureauveritas.com



BUREAU VERITAS

Test Report No.: RF2212WDG0234-1

II/4 DQPSK

Chain 0

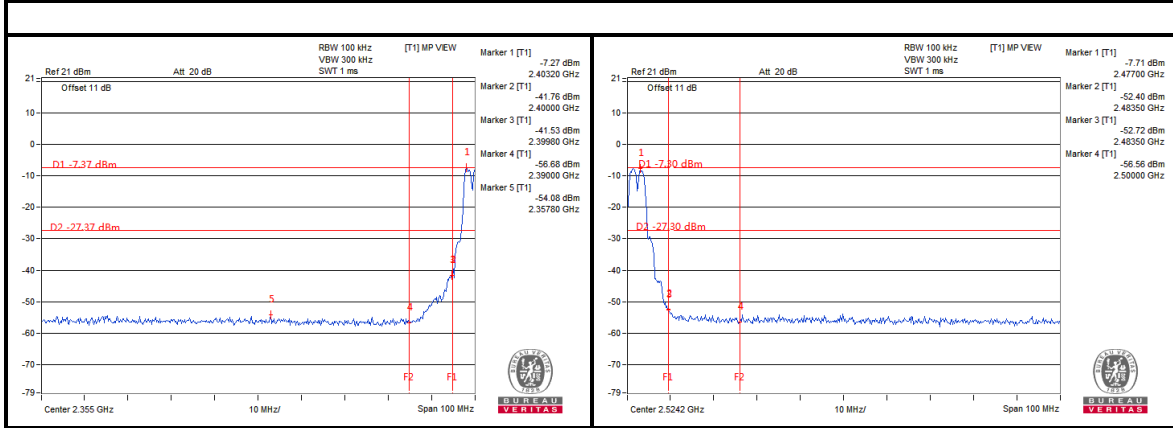

Chain 1

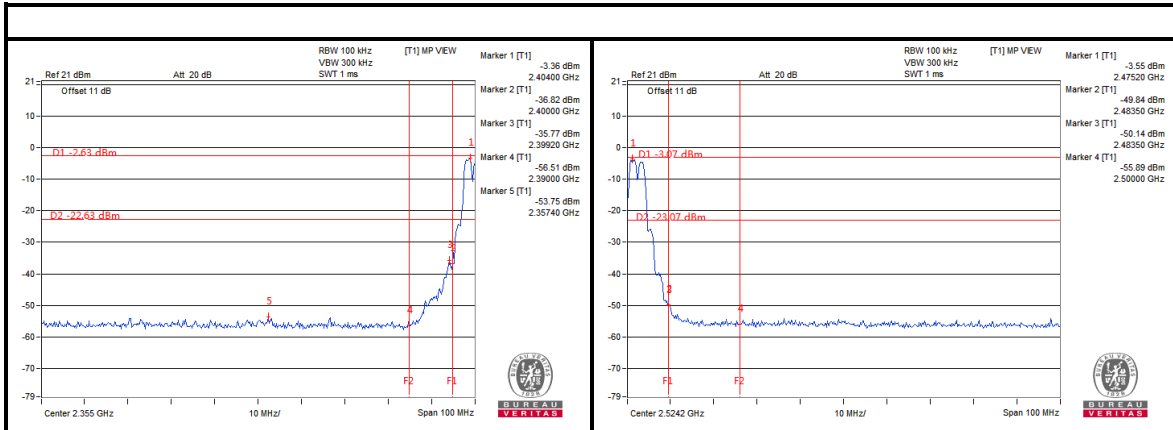

Bureau Veritas Shenzhen Co., Ltd.
Dongguan Branch

No. 96, Guantai Road (Houjie Section), Houjie
Town, Dongguan City, Guangdong Province.
523942, People's Republic of China.

Tel: +86 769 8998 2098
Fax: +86 769 8593 1080
Email: customerservice.dg@bureauveritas.com



**BUREAU
VERITAS**

Test Report No.: RF2212WDG0234-1

5 PHOTOGRAPHS OF THE TEST CONFIGURATION

Please refer to the attached file (Test Setup Photo).



**BUREAU
VERITAS**

Test Report No.: RF2212WDG0234-1

6 APPENDIX A - MODIFICATIONS RECORDERS FOR ENGINEERING CHANGES TO THE EUT BY THE LAB

No any modifications are made to the EUT by the lab during the test.

---END---