



*Tonale*

2024 OWNER'S MANUAL

This Owner's Manual illustrates and describes the operation of features and equipment that are either standard or optional on this vehicle. This manual may also include a description of features and equipment that are no longer available or were not ordered on this vehicle. Please disregard any features and equipment described in this manual that are not on this vehicle. FCA US LLC reserves the right to make changes in design and specifications, and/or make additions to or improvements to its products without imposing any obligation upon itself to install them on products previously manufactured.

With respect to any vehicles sold in Canada, the name FCA US LLC shall be deemed to be deleted and the name FCA Canada Inc. used in substitution therefore.

## ROADSIDE ASSISTANCE

**24 HOURS, 7 DAYS A WEEK AT YOUR SERVICE.**

**CALL 1-855-299-1368 OR VISIT [ALFAROMEO.RSAHELP.COM](http://ALFAROMEO.RSAHELP.COM) (USA)**

**SERVICES: Flat Tire Service, Out Of Gas/Fuel Delivery, Battery Jump Assistance, Lockout Service and Towing Service**

Please see the Customer Assistance chapter in this Owner's Manual for further information.

FCA US LLC reserves the right to modify the terms or discontinue the Roadside Assistance Program at any time. The Roadside Assistance Program is subject to restrictions and conditions of use, that are determined solely by FCA US LLC.

**⚠ WARNING:** Operating, servicing and maintaining a passenger vehicle or off-highway motor vehicle can expose you to chemicals including engine exhaust, carbon monoxide, phthalates, and lead, which are known to the State of California to cause cancer and birth defects or other reproductive harm. To minimize exposure, avoid breathing exhaust, do not idle the engine except as necessary, service your vehicle in a well-ventilated area and wear gloves or wash your hands frequently when servicing your vehicle. For more information go to [www.P65Warnings.ca.gov/passenger-vehicle](http://www.P65Warnings.ca.gov/passenger-vehicle).



# TABLE OF CONTENTS

1	INTRODUCTION.....	7
2	GETTING TO KNOW YOUR VEHICLE.....	15
3	GETTING TO KNOW YOUR INSTRUMENT PANEL .....	79
4	STARTING AND OPERATING .....	98
5	MULTIMEDIA .....	149
6	SAFETY.....	169
7	IN CASE OF EMERGENCY .....	210
8	SERVICING AND MAINTENANCE .....	230
9	TECHNICAL SPECIFICATIONS .....	273
10	CUSTOMER ASSISTANCE.....	278
11	INDEX .....	284

1

2

3

4

5

6

7

8

9

10

11

## INTRODUCTION

<b>SYMBOLS KEY</b> . . . . .	<b>8</b>
<b>ROLLOVER WARNING</b> . . . . .	<b>8</b>
<b>VEHICLE MODIFICATIONS/ALTERATIONS</b> . . . . .	<b>9</b>
<b>SYMBOL GLOSSARY</b> . . . . .	<b>9</b>

## GETTING TO KNOW YOUR VEHICLE

<b>HIGH VOLTAGE BATTERY</b> . . . . .	<b>15</b>
Battery Conditioning . . . . .	16
Regenerative Braking System (RBS) . . . . .	16
E-Selec Mode . . . . .	17
<b>HIGH VOLTAGE CHARGING OPERATION</b> . . . . .	<b>18</b>
SAE J1772 Charging Inlet . . . . .	18
AC Level 1 Charging (120 Volt, 12 Amp) . . . . .	18
AC Level 2 Charging (240 Volt, 40 Amp) . . . . .	25
Charging Times . . . . .	25
Vehicle Charge Indicators . . . . .	26
Hybrid Electric Pages . . . . .	29
<b>KEYS</b> . . . . .	<b>31</b>
Key Fobs . . . . .	31
<b>SENTRY KEY</b> . . . . .	<b>34</b>
<b>IGNITION SWITCH</b> . . . . .	<b>35</b>
Keyless Enter 'n Go™ Ignition . . . . .	35
Keyless Enter 'n Go™ Ignition — PHEV Only . . . . .	36
<b>REMOTE START — IF EQUIPPED</b> . . . . .	<b>37</b>
How To Use Remote Start . . . . .	38
To Exit Remote Start Mode . . . . .	38
Remote Start Front Defrost Activation — If Equipped . . . . .	38
Remote Start Comfort Systems — If Equipped . . . . .	39

Remote Start Windshield Wiper De-Icer Activation — If Equipped . . . . .	39
Remote Start Abort Message — If Equipped . . . . .	39
Scheduled Cabin Conditioning (SCC) — If Equipped (PHEV Only) . . . . .	39
<b>DOORS</b> . . . . .	<b>40</b>
Manual Door Locks . . . . .	40
Power Door Locks . . . . .	41
Keyless Enter 'n Go™ — Passive Entry . . . . .	41
Automatic Door Locks — If Equipped . . . . .	43
Automatic Unlock Doors On Exit . . . . .	43
Dead Lock Device — If Equipped . . . . .	43
Child-Protection Door Lock System — Rear Doors . . . . .	44
<b>STEERING WHEEL</b> . . . . .	<b>44</b>
Tilt/Telescoping Steering Column . . . . .	44
Heated Steering Wheel — If Equipped . . . . .	45
<b>DRIVER MEMORY SETTINGS — IF EQUIPPED</b> . . . . .	<b>45</b>
Programming The Memory Feature . . . . .	45
Memory Position Recall . . . . .	45
<b>SEATS</b> . . . . .	<b>46</b>
Manual Adjustment Rear Seats . . . . .	46
Power Adjustment Front Seats . . . . .	46
Front Heated Seats — If Equipped . . . . .	47
Front Ventilated Seats — If Equipped . . . . .	48
Rear Seat Armrest — If Equipped . . . . .	48
Head Restraints . . . . .	49
<b>UCONNECT VOICE RECOGNITION QUICK TIPS — IF EQUIPPED</b> . . . . .	<b>50</b>
Introducing Voice Recognition . . . . .	50
Basic Voice Commands . . . . .	50
Get Started . . . . .	50
Additional Information . . . . .	51

<b>MIRRORS</b> . . . . .	<b>51</b>
Inside Rearview Mirror . . . . .	51
Illuminated Vanity Mirrors . . . . .	51
Outside Mirrors . . . . .	51
Outside Automatic Dimming Mirrors — If Equipped . . . . .	51
Power Adjustment Mirrors . . . . .	52
Folding Mirrors . . . . .	52
Heated Mirrors — If Equipped . . . . .	53
<b>UNIVERSAL GARAGE DOOR OPENER (HOMELINK®) — IF EQUIPPED</b> . . . . .	<b>53</b>
Before You Begin Programming HomeLink® . . . . .	53
Erasing All The HomeLink® Channels . . . . .	53
Identifying Whether You Have A Rolling Code Or Non-Rolling Code Device . . . . .	53
Programming HomeLink® To A Garage Door Opener . . . . .	54
Programming HomeLink® To A Miscellaneous Device . . . . .	54
Reprogramming A Single HomeLink® Button . . . . .	55
Canadian/Gate Operator Programming . . . . .	55
Security . . . . .	55
Troubleshooting Tips . . . . .	56
<b>EXTERIOR LIGHTS</b> . . . . .	<b>56</b>
Multifunction Lever . . . . .	56
Headlight Switch . . . . .	56
Daytime Running Lights (DRLs) — If Equipped . . . . .	57
High/Low Beam Switch . . . . .	57
Automatic High Beam Headlights — If Equipped . . . . .	57
Flash-To-Pass . . . . .	57
Automatic Headlights — If Equipped . . . . .	57

Headlights On Automatically With Wipers — If Equipped . . . . .	57	<b>POWER SUNROOF — IF EQUIPPED . . . . .</b>	<b>71</b>	Battery Saver On/Battery Saver Mode Message — Electrical Load Reduction Actions — If Equipped . . . . .	86
Headlight Delay . . . . .	58	Opening And Closing The Sunroof . . . . .	71	<b>WARNING LIGHTS AND MESSAGES . . . . .</b>	<b>87</b>
Lights-On Reminder . . . . .	58	Opening And Closing The Power Sunshade . . . . .	72	Red Warning Lights . . . . .	87
Rear Fog Lights — If Equipped . . . . .	58	Pinch Protect Feature . . . . .	72	Yellow Warning Lights . . . . .	90
Cornering Lights — If Equipped . . . . .	58	Re-Initialization Procedure . . . . .	72	Yellow Indicator Lights . . . . .	94
Turn Signals . . . . .	58	Sunroof Maintenance . . . . .	73	Green Indicator Lights . . . . .	94
Lane Change Assist . . . . .	58	<b>HOOD . . . . .</b>	<b>73</b>	White Indicator Lights . . . . .	95
Battery Saver Feature . . . . .	58	Opening The Hood . . . . .	73	Blue Indicator Lights . . . . .	95
<b>INTERIOR LIGHTS . . . . .</b>	<b>59</b>	Closing The Hood . . . . .	73	Gray Indicator Lights . . . . .	95
Interior Courtesy Lights . . . . .	59	<b>LIFTGATE . . . . .</b>	<b>74</b>	<b>ONBOARD DIAGNOSTIC SYSTEM — OBD II . . . . .</b>	<b>96</b>
<b>WINDSHIELD WIPERS AND WASHERS . . . . .</b>	<b>60</b>	Unlock/Open The Liftgate . . . . .	74	Onboard Diagnostic System (OBD II) Cybersecurity . . . . .	96
Windshield Wiper Operation . . . . .	60	Lock/Close The Liftgate . . . . .	74	<b>EMISSIONS INSPECTION AND MAINTENANCE PROGRAMS . . . . .</b>	<b>96</b>
Rain Sensing Wipers — If Equipped . . . . .	61	Power Liftgate — If Equipped . . . . .	75	<b>STARTING AND OPERATING</b>	
Rear Window Wiper/Washer . . . . .	62	Adjustable Power Liftgate Height . . . . .	76	<b>STARTING THE ENGINE — GAS . . . . .</b>	<b>98</b>
<b>CLIMATE CONTROLS . . . . .</b>	<b>62</b>	Hands-Free Liftgate — If Equipped . . . . .	76	Normal Starting . . . . .	98
Automatic Climate Control Descriptions And Functions . . . . .	62	Cargo Area Features . . . . .	77	Extended Park Starting . . . . .	99
Automatic Temperature Control (ATC) . . . . .	65	<b>GETTING TO KNOW YOUR INSTRUMENT PANEL</b>		After Starting — Warming Up The Engine . . . . .	99
Climate Voice Commands . . . . .	65	<b>INSTRUMENT CLUSTER . . . . .</b>	<b>79</b>	If Engine Fails To Start . . . . .	99
Operating Tips . . . . .	65	Instrument Cluster Descriptions . . . . .	80	Stopping The Engine . . . . .	99
<b>INTERIOR STORAGE AND EQUIPMENT . . . . .</b>	<b>66</b>	<b>INSTRUMENT CLUSTER DISPLAY . . . . .</b>	<b>80</b>	<b>STARTING THE VEHICLE — PHEV . . . . .</b>	<b>100</b>
Storage . . . . .	66	Instrument Cluster Display Location And Controls . . . . .	80	Normal Starting . . . . .	100
USB Control . . . . .	67	Oil Change Reset . . . . .	82	After Starting . . . . .	101
Power Outlets — If Equipped . . . . .	68	Stop Safely And Leave The Vehicle As Soon As Possible . . . . .	82	To Turn Off The Vehicle Using ENGINE START/STOP Button . . . . .	101
Wireless Charging Pad — If Equipped . . . . .	69	Electric Mode Temporarily Unavailable . . . . .	83	<b>ENGINE BREAK-IN RECOMMENDATIONS . . . . .</b>	<b>101</b>
<b>WINDOWS . . . . .</b>	<b>70</b>	Fuel And Oil Refresh Mode . . . . .	83	<b>PARK BRAKE . . . . .</b>	<b>101</b>
Power Window Controls . . . . .	70	Power Steering Check Message . . . . .	84	Electric Park Brake (EPB) . . . . .	101
Automatic Window Features . . . . .	70	Gear Shift Indicator (GSI) — If Equipped . . . . .	84		
Power Window System Initialization . . . . .	70	Instrument Cluster Display Menu Items . . . . .	84		
Window Lockout Switch . . . . .	71				
Wind Buffeting . . . . .	71				

<b>AUTOMATIC TRANSMISSION . . . . .</b>	<b>104</b>	<b>CRUISE CONTROL SYSTEMS . . . . .</b>	<b>114</b>	<b>LANESENSE — IF EQUIPPED . . . . .</b>	<b>133</b>
Ignition Park Interlock . . . . .	105	Adaptive Cruise Control (ACC) . . . . .	114	LaneSense Operation . . . . .	133
Brake/Transmission Shift Interlock (BTSI) System . . . . .	105	<b>TRAFFIC SIGN RECOGNITION — IF EQUIPPED . . . . .</b>	<b>120</b>	Turning LaneSense On Or Off . . . . .	134
6-SPEED OR 9-SPEED AUTOMATIC TRANSMISSION . . . . .	105	Activation/Deactivation . . . . .	120	LaneSense Warning Message . . . . .	134
<b>ALL-WHEEL DRIVE (AWD) . . . . .</b>	<b>108</b>	Traffic Sign Recognition Modes . . . . .	120	Changing LaneSense Status . . . . .	135
<b>ELECTRIC POWER STEERING (EPS) . . . . .</b>	<b>108</b>	Indications On The Display . . . . .	121	<b>PARKVIEW REAR BACK UP CAMERA . . . . .</b>	<b>135</b>
<b>ALFA DNA SELECTOR — GAS . . . . .</b>	<b>109</b>	<b>INTELLIGENT ADAPTIVE CRUISE CONTROL — IF EQUIPPED . . . . .</b>	<b>121</b>	<b>SURROUND VIEW CAMERA SYSTEM — IF EQUIPPED . . . . .</b>	<b>136</b>
Alfa DNA System . . . . .	109	Activation/Deactivation . . . . .	121	<b>REFUELING THE VEHICLE — GAS . . . . .</b>	<b>138</b>
Driving Modes . . . . .	109	<b>ACTIVE DRIVING ASSIST SYSTEM — IF EQUIPPED . . . . .</b>	<b>122</b>	<b>REFUELING THE VEHICLE — PHEV (IF EQUIPPED) . . . . .</b>	<b>139</b>
<b>ALFA DNA SELECTOR — HYBRID . . . . .</b>	<b>110</b>	Operation . . . . .	122	<b>VEHICLE LOADING . . . . .</b>	<b>141</b>
Alfa DNA System . . . . .	110	Turning Active Driving Assist On Or Off . . . . .	122	Certification Label . . . . .	141
Driving Modes . . . . .	110	Indications On The Display . . . . .	124	<b>TRAILER TOWING . . . . .</b>	<b>142</b>
<b>ALFA ACTIVE SUSPENSION (AAS) — IF EQUIPPED . . . . .</b>	<b>111</b>	Minimum Risk Maneuver . . . . .	124	Common Towing Definitions . . . . .	142
<b>STOP/START SYSTEM — IF EQUIPPED . . . . .</b>	<b>111</b>	System Status . . . . .	125	Trailer Towing Weights (Maximum Trailer Weight Ratings) . . . . .	143
Autostop Mode . . . . .	111	System Operation/Limitations . . . . .	125	Trailer And Tongue Weight . . . . .	144
Possible Reasons The Engine Does Not Autostop . . . . .	112	<b>PARKSENSE FRONT/REAR PARK ASSIST SYSTEM — IF EQUIPPED . . . . .</b>	<b>125</b>	Towing Requirements . . . . .	144
To Start The Engine While In Autostop Mode . . . . .	112	ParkSense Sensors . . . . .	125	Towing Tips . . . . .	146
To Manually Turn Off The Stop/Start System . . . . .	112	ParkSense Warning Display . . . . .	126	<b>RECREATIONAL TOWING (BEHIND MOTORHOME) . . . . .</b>	<b>146</b>
To Manually Turn On The Stop/Start System . . . . .	112	ParkSense Display . . . . .	126	Towing This Vehicle Behind Another Vehicle . . . . .	146
System Malfunction . . . . .	112	Enabling And Disabling ParkSense . . . . .	126	Recreational Towing . . . . .	147
<b>ACTIVE SPEED LIMITER — IF EQUIPPED . . . . .</b>	<b>113</b>	Service The ParkSense Park Assist System . . . . .	126	<b>DRIVING TIPS . . . . .</b>	<b>147</b>
Activation . . . . .	113	Cleaning The ParkSense System . . . . .	126	Driving On Slippery Surfaces . . . . .	147
Exceeding The Set Speed . . . . .	113	ParkSense System Usage Precautions . . . . .	127	Driving Through Water . . . . .	147
Deactivation . . . . .	113	Side Distance Warning (SDW) System . . . . .	127	<b>MULTIMEDIA</b>	
<b>INTELLIGENT SPEED ASSIST (ISA) — IF EQUIPPED . . . . .</b>	<b>114</b>	<b>PARKSENSE ACTIVE PARK ASSIST SYSTEM — IF EQUIPPED . . . . .</b>	<b>129</b>	<b>UCONNECT SYSTEMS . . . . .</b>	<b>149</b>
Activation . . . . .	114	Enabling And Disabling The ParkSense Active Park Assist System . . . . .	129	<b>CYBERSECURITY . . . . .</b>	<b>149</b>
Sign Capture Modes . . . . .	114	Parallel/Perpendicular Parking Space Assistance Operation . . . . .	130	<b>UCONNECT SETTINGS . . . . .</b>	<b>149</b>
Exceeding The Set Speed . . . . .	114	Exiting The Parking Space . . . . .	132	Customer Programmable Features . . . . .	149
Deactivation . . . . .	114				

<b>STEERING WHEEL AUDIO CONTROLS —</b>			
<b>IF EQUIPPED</b> . . . . .	166		
Steering Wheel Rotary Control . . . . .	166		
Controls on Central Tunnel . . . . .	166		
<b>MY CAR</b> . . . . .	166		
<b>PERFORMANCE PAGES</b> . . . . .	167		
Technical Gauges . . . . .	167		
Consumption History — If Equipped . . . . .	167		
Accessory Gauges . . . . .	168		
<b>RADIO OPERATION AND MOBILE PHONES</b> . . . . .	168		
Regulatory And Safety Information . . . . .	168		
<b>SAFETY</b>			
<b>SAFETY FEATURES</b> . . . . .	169		
Anti-Lock Brake System (ABS) . . . . .	169		
Electronic Brake Control (EBC) System . . . . .	169		
<b>AUXILIARY DRIVING SYSTEMS</b> . . . . .	173		
Blind Spot Monitoring (BSM) — If Equipped . . . . .	173		
Forward Collision Warning (FCW) With Mitigation — If Equipped . . . . .	176		
Tire Pressure Monitoring System (TPMS) . . . . .	179		
<b>OCCUPANT RESTRAINT SYSTEMS</b> . . . . .	182		
Occupant Restraint Systems Features . . . . .	182		
Important Safety Precautions . . . . .	182		
Seat Belt Systems . . . . .	182		
Supplemental Restraint Systems (SRS) . . . . .	188		
Child Restraints . . . . .	199		
<b>SAFETY TIPS</b> . . . . .	207		
Transporting Passengers . . . . .	207		
Transporting Pets . . . . .	207		
Connected Vehicles . . . . .	208		
Safety Checks You Should Make Inside The Vehicle . . . . .	208		
		Periodic Safety Checks You Should Make	
		209	
		209	
		209	
		<b>IN CASE OF EMERGENCY</b>	
		210	
		210	
		213	
		213	
		213	
		214	
		217	
		217	
		217	
		219	
		220	
		220	
		220	
		221	
		222	
		223	
		223	
		224	
		225	
		225	
		226	
		227	
		228	
		228	
		228	
		229	
		229	
		230	
		230	
		232	
		232	
		233	
		234	
		234	
		234	
		235	
		235	
		235	
		236	
		236	
		237	
		238	
		238	
		239	
		240	
		243	
		243	
		244	
		257	
		257	
		257	
		263	
		266	
		266	
		267	

<b>DEPARTMENT OF TRANSPORTATION UNIFORM</b>	
<b>TIRE QUALITY GRADES</b> . . . . .	<b>268</b>
Treadwear . . . . .	268
Traction Grades . . . . .	268
Temperature Grades . . . . .	268
<b>STORING THE VEHICLE — GAS</b> . . . . .	<b>269</b>
<b>STORING THE VEHICLE — PHEV</b> . . . . .	<b>269</b>
<b>BODYWORK</b> . . . . .	<b>270</b>
Protection From Atmospheric Agents . . . . .	270
Body And Underbody Maintenance . . . . .	270
Preserving The Bodywork . . . . .	271
<b>INTERIORS</b> . . . . .	<b>271</b>
Seats And Fabric Parts . . . . .	271
Plastic And Coated Parts . . . . .	272
Leather Surfaces . . . . .	272
Glass Surfaces . . . . .	272
<b>TECHNICAL SPECIFICATIONS</b>	
<b>VEHICLE IDENTIFICATION NUMBER (VIN)</b> . . . . .	<b>273</b>
<b>BRAKE SYSTEM</b> . . . . .	<b>273</b>
<b>WHEEL AND TIRE TORQUE SPECIFICATIONS</b> . . . . .	<b>273</b>
Torque Specifications . . . . .	273
<b>FUEL REQUIREMENTS</b> . . . . .	<b>274</b>
1.3L Engine . . . . .	274
2.0L Engine . . . . .	274
Reformulated Gasoline . . . . .	274
Gasoline/Oxygenate Blends . . . . .	274
E-85 Usage In Non-Flex Fuel Vehicles . . . . .	274
CNG And LP Fuel System Modifications . . . . .	275
Methylcyclopentadienyl Manganese Tricarbonyl (MMT) In Gasoline . . . . .	275
Materials Added To Fuel . . . . .	275
Fuel System Cautions . . . . .	275
<b>FLUID CAPACITIES</b> . . . . .	<b>276</b>
<b>ENGINE FLUIDS AND LUBRICANTS</b> . . . . .	<b>277</b>
<b>CHASSIS FLUIDS AND LUBRICANTS</b> . . . . .	<b>277</b>
<b>CUSTOMER ASSISTANCE</b>	
<b>SUGGESTIONS FOR OBTAINING SERVICE FOR YOUR VEHICLE</b> . . . . .	<b>278</b>
Prepare For The Appointment . . . . .	278
Prepare A List . . . . .	278
Be Reasonable With Requests . . . . .	278
<b>IF YOU NEED ASSISTANCE</b> . . . . .	<b>278</b>
Roadside Assistance . . . . .	278
FCA US LLC Customer Center . . . . .	279
FCA Canada Inc. Customer Care . . . . .	279
Alfa Romeo Customer Care (Puerto Rico and US Virgin Islands) . . . . .	279
Mexico . . . . .	279
Puerto Rico And US Virgin Islands . . . . .	279
Customer Assistance For The Hearing Or Speech Impaired (TDD/TTY) . . . . .	279
Service Contract . . . . .	280
<b>WARRANTY INFORMATION</b> . . . . .	<b>280</b>
<b>MOPAR® PARTS</b> . . . . .	<b>280</b>
<b>REPORTING SAFETY DEFECTS</b> . . . . .	<b>280</b>
In The 50 United States And Washington, D.C. . . . .	280
In Canada . . . . .	281
<b>ORDERING AND ACCESSING ADDITIONAL OWNER'S INFORMATION</b> . . . . .	<b>281</b>
<b>CHANGE OF OWNERSHIP OR ADDRESS</b> . . . . .	<b>281</b>
<b>GENERAL INFORMATION</b> . . . . .	<b>282</b>



# INTRODUCTION

**Dear Customer,**

We would like to congratulate and thank you for the purchase of your Alfa Romeo.

We have written this Owner's Manual to help you get to know all of the features of your vehicle and use it in the best possible way. Please take the necessary time to familiarize yourself with all the dynamic features of your vehicle.

Here you will find important information and warnings regarding the use of your vehicle, and how to achieve the best performance from the technical features of your Alfa Romeo.

You are advised to read through the Owner's Manual before taking it on the road for the first time. It is important to become familiar with the controls of your vehicle, especially with sections concerning the brakes, handling, transmission, and vehicle behavior on different road surfaces.

This Owner's Manual also provides a description of special features and tips, as well as essential information for the safe driving, care, and maintenance of your Alfa Romeo over time.

Along with your Owner's Manual, you will also find a description of the services that Alfa Romeo offers to its customers, the vehicle's warranty coverage, and the details of the terms and conditions for maintaining its validity. These documents are meant to introduce the superior service provided by Alfa Romeo.

For questions or comments pertaining to your vehicle, please contact:

Alfa Romeo Customer Care Center:

P.O. Box 21-8004 Auburn Hills, MI

48321-8004

Phone: 1-844-Alfa-USA

(1-844-253-2872)

Alfa Romeo Customer Care (Canada):



P.O. Box 1621

Windsor, Ontario N9A 4H6

Phone: 1-877-230-0563 (English)

Phone: 1-877-515-9112 (French)

## SYMBOLS KEY

<b>WARNING!</b>	These statements apply to operating procedures that could result in a collision, bodily injury and/or death.
<b>CAUTION!</b>	These statements apply to procedures that could result in damage to your vehicle.
<b>NOTE:</b>	A suggestion which will improve installation, operation, and reliability. If not followed, may result in damage.
<b>TIP:</b>	General ideas/solutions/suggestions on easier use of the product or functionality.
<b>PAGE REFERENCE ARROW</b> 	Follow this reference for additional information on a particular feature.
<b>FOOTNOTE</b> 	Supplementary and relevant information pertaining to the topic.

If you do not read the entire Owner's Manual, you may miss important information. Observe all Cautions and Warnings.

## ROLLOVER WARNING

Utility vehicles have a significantly higher rollover rate than other types of vehicles. This vehicle has a higher ground clearance and a higher center of gravity than many passenger vehicles. It is capable of performing better in a wide variety of off-road applications. Driven in an unsafe manner, all vehicles can go out of control. Because of the higher center of gravity, if this vehicle is out of control it may roll over while some other vehicles may not.

Do not attempt sharp turns, abrupt maneuvers, or other unsafe driving actions that can cause loss of vehicle control. Failure to operate this vehicle safely may result in a collision, rollover of the vehicle, and severe or fatal injury. Drive carefully.



90614090

**Rollover Warning Label**

Failure to use the driver and passenger seat belts provided is a major cause of severe or fatal injury. In fact, the US government notes that the universal use of existing seat belts could cut the highway death toll by 10,000 or more each year and could reduce disabling injuries by two million annually. In a rollover crash, an unbelted person is significantly more likely to die than a person wearing a seat belt. Always buckle up.

## VEHICLE MODIFICATIONS/ALTERATIONS

### WARNING!



Any modifications or alterations to this vehicle could seriously affect its roadworthiness and safety and may lead to a collision resulting in serious injury or death.







## SYMBOL GLOSSARY







Some car components have colored labels with symbols indicating precautions to be observed when using this component. It is important to follow all warnings when operating your vehicle. See below for the definition of each symbol ↪ page 87.





### NOTE:

Warning and Indicator lights are different based upon equipment options and current vehicle status. Some telltales are optional and may not appear.







Red Warning Lights	
	Air Bag Warning Light ↪ page 87
	Brake Warning Light ↪ page 88
	Battery Charge Warning Light ↪ page 88







Red Warning Lights	
	Door Open Warning Light ↪ page 88
	Drowsy Driver Detected Warning Light ↪ page 88
	Electric Power Steering (EPS) Fault Warning Light ↪ page 88
	Electronic Throttle Control (ETC) Warning Light ↪ page 89
	Engine Coolant Temperature Warning Light ↪ page 89
	Hood Open Warning Light ↪ page 89







Red Warning Lights	
	Liftgate Open Warning Light ↪ page 89
	Oil Pressure Warning Light ↪ page 89
	Oil Temperature Warning Light ↪ page 89
	Plug Status Fault Warning Light ↪ page 89
	Seat Belt Reminder Warning Light ↪ page 90
	Service Hybrid System Warning Light ↪ page 90







Red Warning Lights	
	SOS Battery Fail Warning Light ↪ page 90
	Traction Battery Fault Warning Light ↪ page 90
	Torque Limited Warning Light ↪ page 90
	Transmission Fault Warning Light ↪ page 90
	Vehicle Security Warning Light ↪ page 90





Yellow Warning Lights	
	Acoustic Vehicle Alerting System (AVAS) Fault Warning Light ↪ page 90



Yellow Warning Lights	
	Active Speed Limiter Fault Indicator Light ↔ page 91
	Auto Liftgate Fault Indicator Light ↔ page 90
	Blind Spot Detection Fault Warning Light ↔ page 91
	Anti-Lock Brake System (ABS) Warning Light ↔ page 91
	Drowsy Driver Detected System Fault Warning Light ↔ page 91
	Electric Park Brake Warning Light ↔ page 91







Yellow Warning Lights	
	Electronic Stability Control (ESC) Active Warning Light ↔ page 91
	Electronic Stability Control (ESC) OFF Warning Light ↔ page 91
	Fuel Cutoff Warning Light ↔ page 91
	Fuel Cutoff Failure Warning Light ↔ page 91
	Fuel Level Sensor Failure Warning Light ↔ page 91
	Lane Keep Assist Warning Light ↔ page 91



Yellow Warning Lights	
	Service Lane Keep Assist Warning Light ↔ page 92
	Low Fuel Warning Light ↔ page 92
	Engine Check/Malfunction Indicator (MIL) Warning Light ↔ page 92
	Keyless Enter 'n Go™/Service Passive Entry Warning Light ↔ page 92
	Rain Sensor Failure Light ↔ page 92
	Service Forward Collision Warning (FCW) Light ↔ page 92



Yellow Warning Lights	
	Service Stop/Start System Warning Light ↔ page 92
	Tire Pressure Monitoring System (TPMS) Warning Light ↔ page 92
	Towing Hook Breakdown Warning Light ↔ page 93
	PHEV Traction Battery Cut-off Warning Light ↔ page 93
	Traffic Sign Recognition (TSR) Fault Warning Light ↔ page 93
	Transmission Temperature Warning Light ↔ page 93





Yellow Indicator Lights	
	Exterior Lights Failure Indicator Light ↔ page 94
	Forward Collision Warning (FCW) OFF Indicator Light ↔ page 94
	Icy Road Condition Indicator Light ↔ page 94
	Immobilizer Fail / VPS Electrical Alarm Indicator Light ↔ page 94

Green Indicator Lights	
	Active Speed Limiter SET Indicator Light ↔ page 113
	Hold 'n Go Indicator Light ↔ page 94

Green Indicator Lights	
	Auto Low Beams Indicator Light ↔ page 94
	Parking/Headlights On Indicator Light ↔ page 94
	Ready To Drive Indicator Light ↔ page 95
	Plug Status Indicator Light ↔ page 94
	Turn Signal Indicator Lights ↔ page 95
	Stop/Start Active Indicator Light ↔ page 95

Green Indicator Lights	
	E-Boost Engaged Indicator Light ↔ page 95
	E-Drive Electric Mode Indicator Light ↔ page 95

Blue Indicator Lights	
	High Beams Indicator Light ↔ page 95
	Auto High Beams Active Indicator Light ↔ page 95

White Indicator Lights	
	Auto High Beams Active Indicator Light ↔ page 95
	Auto Low Beams Indicator Light ↔ page 95
	E-Boost Available Indicator Light ↔ page 95
	Idle Coasting Indicator Light ↔ page 95

Gray Indicator Lights	
	E-Boost Unavailable Indicator Light ↔ page 95



# GETTING TO KNOW YOUR VEHICLE

## HIGH VOLTAGE BATTERY

Your vehicle is equipped with a Lithium-ion high voltage battery that is used to power the electric powertrain systems and the 12 Volt vehicle electrical system.

The high voltage battery is located underneath the vehicle.

Lithium-ion batteries provide the following benefits:

- Lithium-ion batteries are much lighter than other types of rechargeable batteries of the same size.
- Lithium-ion batteries hold their charge; they only lose approximately three percent of their charge per month.
- Lithium-ion batteries have no memory, which means that you do not have to completely discharge them before recharging, as with some other batteries.
- Lithium-ion batteries can be recharged and discharged thousands of times.

### High Voltage Battery Service Disconnect

The high voltage battery service disconnect is located under the load floor of the cargo area, at the front left side. Only a qualified service technician should access the high voltage battery service disconnect.

If your vehicle requires high voltage battery service, see an authorized dealer.

### WARNING!

- Never try to remove the high voltage battery service disconnect. The high voltage battery service disconnect is used when your vehicle requires service by a qualified technician at an authorized dealership. Failure to follow this warning can result in electrical shock, toxic emissions, fire, and other hazards which can cause death or serious injury including severe burns, respiratory injuries, and blindness.
- The high voltage battery and battery case have no parts that you or an unqualified technician can service. Under no circumstances should you or an unqualified technician open, disassemble, penetrate, or tamper with the high voltage battery, battery case, their cables, or connectors. Damage to these components can result in electrical shock, toxic emissions, fire, and other hazards which can cause death or serious injury including severe burns, respiratory injuries, and blindness. You should take the vehicle to an authorized dealership for any service or maintenance on these high voltage components.
- The high voltage system can be hot during and after starting, and when the vehicle is shut off or charging. Be careful of both the high voltage and the high temperature. Failure to do so can result in severe burns.

### Disposal of the High Voltage Battery

Your vehicle's high voltage battery is designed to last the life of your vehicle. See an authorized dealer for information on the disposal of the battery if it should require replacement.

### WARNING!

Your vehicle contains a sealed Lithium-ion high voltage battery. If the battery is disposed of improperly, there is a risk of electrical shock and toxic emissions which can cause severe burns, respiratory injuries, fires, and other hazards resulting in serious injury or death.

### General Information

The vehicle is also equipped with a Battery Management system that is designed to:

- Ensure safe operation
- Maximize driving range
- Maximize the life expectancy of the high voltage battery

### NOTE:

During vehicle start up and shut down, a clicking noise may be heard from within the vehicle. When the vehicle is preparing to start, the high voltage battery contactors inside the battery are closed to make the stored electricity inside available for vehicle use. After the vehicle is shut down, the contactors open to electrically isolate the battery from other vehicle systems. The clicking noise is the sound of these contactors as they open and close during normal operation.

**WARNING!**

In the event of a collision:

- If your vehicle is still drivable, pull off the road and place the transmission in the PARK position, apply the parking brake, and turn the vehicle off.
- Check your vehicle to see if there are exposed high-voltage parts or cables. To avoid electrical shock which can result in serious injury or death, never touch wiring, connectors, and other high-voltage parts, such as the inverter unit and the Lithium-ion battery.
- If the vehicle receives a strong impact to the floor while driving, stop the vehicle in a safe location and check the floor.
- Leaks or damage to the Lithium-ion battery may result in a fire and toxic emissions which can cause severe burns, respiratory injuries, and other serious injuries or death. If you discover these leaks, contact emergency services immediately. Since the fluid leak may be Lithium Manganate from the Lithium-ion battery, never touch the fluid leak inside or outside of the vehicle. If the fluid contacts your skin or eyes, wash these areas immediately with a large amount of water and obtain immediate medical attention to help avoid serious injury.
- If a fire occurs inside your vehicle, leave the vehicle as soon as possible. Only use a type ABC, BC, or C fire extinguisher that is meant for use on electrical fires. Using a small amount of water, or the incorrect fire extinguisher can result in serious injury or death from electrical shock.

*(Continued)*

**WARNING!**

- If you are not able to safely assess the vehicle due to vehicle damage, do not touch the vehicle. Leave the vehicle and contact emergency services. Advise first responders that this is a hybrid-electric vehicle.
- In the event of an accident that requires bodywork, refer to an authorized dealership.

**BATTERY CONDITIONING**

In extreme temperatures, high or low, the high voltage battery may need to be conditioned, and therefore may require the vehicle to be plugged in prior to the next use of the vehicle.

If the ambient temperature is 5 °F (-15 °C) or below at vehicle shut down, the instrument cluster will display the message “Plug In Vehicle To Condition Battery”.

If the battery temperature is below -22 °F (-30 °C), or 131 °F (55 °C) or above, the vehicle will NOT start:

- If the vehicle is plugged in at these battery temperatures, the vehicle will not start and the instrument cluster will display the message “Please Leave Key In RUN — Battery Conditioning Needed” until battery conditioning is complete.
- If the vehicle is not plugged in at these battery temperatures, the vehicle will not start and the “Plug In Vehicle To Condition Battery” message will be shown in the instrument cluster display.

**NOTE:**

- When the “Please Leave Key In RUN — Battery Conditioning Needed” message is displayed, keep the ignition in the RUN position for the battery to recover. Place the ignition back in the OFF position when the message disappears, and then start the vehicle. When this message is displayed, do not operate any air conditioning controls.
- Under these high or low temperatures, while the vehicle is plugged in and the ignition is in the OFF position, the vehicle may “wake up” to precondition the high voltage battery for use.
- It is recommended that the vehicle be plugged in overnight when possible, to maximize the electric range of the vehicle.

The messages will only be displayed when the ignition is in the RUN position and the high voltage battery is not ready to provide propulsion power. The messages will also display if there was a failed attempt to achieve READY state when the high voltage battery cell temperatures were either too cold, or too hot.

**REGENERATIVE BRAKING SYSTEM (RBS)**

Your vehicle has a RBS. The RBS replenishes the vehicle's high voltage battery during deceleration, and is particularly useful in stop-and-go city traffic. The electric motors, which propel the vehicle forward, can operate as generators when braking. The RBS recharges the high voltage battery under certain braking conditions by recapturing energy that would otherwise be lost while braking. The electric power that is generated goes back into the high voltage battery for later use, for example when acceleration is desired.

The RBS uses conventional hydraulic friction brakes, regenerative braking, or a combination to slow the vehicle. If the system detects slippery conditions while braking, ONLY friction is used to slow the vehicle. The RBS can result in extended life of the hydraulic service brakes; however, all inspection, scheduled maintenance, and service intervals for the vehicle service brakes must be followed.

### Max Regeneration

Max Regeneration is a supplemental feature of the RBS. When activated, it will use the RBS to help slow the vehicle when the driver releases the accelerator pedal. This feature allows you to moderately reduce driving speed without pressing the brake pedal. It is always necessary to apply the brake pedal to bring the vehicle to a complete stop. The Driving History screen shows the value of energy recovered from the high-voltage battery during eCoasting and eBraking energy recovery operations → page 29.

- **eCoasting:** Intervenes in place of the exhaust brake when the throttle is released, allowing energy recovery when slowing down, even when the brake pedal is released. It will differentiate depending on the selected drive mode. When the accelerator pedal is released, the system recovers energy during the slowing down phase of the car. It is always active regardless of the selected drive mode. eCoasting is possible if the automatic transmission is in the Drive position. While in “Sport” mode, eCoasting has a more pronounced deceleration when the accelerator pedal is released. When “Sport” mode is not selected, eCoasting has a setting that favors driving comfort.
- **eBraking:** eBraking is always active regardless of the selected operating mode, and activates the high-voltage battery charging when the brake pedal is pressed, thereby recovering energy during braking. It is useful when driving in the city, where there are continuous stops and starts. To make the most efficient use of the system, the braking phase should be modulated by applying gradual pressure on the brake pedal to allow maximum energy recovery.
- **Electric:** Prevents the engine from running, unless you absolutely need it.
  - Driving in electric mode allows the vehicle to use up to the full capability of the electric drivetrain, and if the electric drivetrain is operating at its peak power, then pressing the accelerator pedal more will not result in more power. To access the full capability of the engine plus electric motors, switch to Hybrid or e-Save.
  - Engine will switch on during a Wide Open Throttle (WOT) event, or if cruise control requires it.
  - Vehicle will switch to hybrid mode upon reaching < 1% State of Charge (SOC) or due to system needs. See → page 86 for information on where to view your vehicle’s SOC.
- **e-Save:** Aims to maintain a high level of SOC/Electric range for later use. It can be customized in settings to increase the SOC to predefined levels.
  - e-Save settings can be found in the Uconnect Hybrid Electric App.
  - When e-Save is selected on a fully charged vehicle, the SOC will drop slightly for optimal performance.
  - The Battery Save setting aims to maintain the SOC at the current level. Under heavy load, such as while pulling a trailer, SOC may decrease. When coasting, the SOC may increase.
  - The Battery Charge setting uses power from the engine to increase SOC to the selected target. If the SOC is above the target when e-Save mode is activated, then the vehicle will automatically switch between gas and battery until SOC reaches the target.
  - The e-Save mode button must be pressed to activate Battery Save or Battery Charge.

## E-SELEC MODE

This system allows the driver to select different modes by first pressing the e-Save button located below the gear shifter. Once selected the different modes are customizable in your touchscreen display.



**E-Select Mode Switch**

- **Hybrid:** Prioritizes electric range first, then gas range.
  - Automatically switches between using gas and battery for greatest efficiency and performance.
  - Best heating/cooling and acceleration performance.

## HIGH VOLTAGE CHARGING OPERATION

### SAE J1772 CHARGING INLET

Your vehicle uses an industry standard SAE J1772 charge inlet (vehicle charge inlet) for both AC Level 1 (120 V) and AC Level 2 (240 V) charging.



**Vehicle Charge Inlet Location**

Open the charge port door by pushing near the rear outer edge of the door, near the center to unlatch. To close the charge port door, engage the door latch by pushing on the rear outer edge near the center.

### AC LEVEL 1 CHARGING (120 VOLT, 12 AMP)

Your vehicle is equipped with a 120 Volt AC, SAE J1772 Level 1 Electric Vehicle Supply Equipment (EVSE), also referred to as a Portable Charging Cordset (EVSE). AC Level 1 charging requires a conventional NEMA 5-15R 120 Volt AC grounded wall outlet along with the Portable Charging Cordset (EVSE) provided with the vehicle.

#### WARNING!

Please be sure to follow the warnings below. Failure to do so may result in serious injury or death.

- Discontinue use of the Portable Charging Cordset (EVSE) immediately if the plug or outlet becomes hot to the touch or if you notice any unusual odors.
- Do not use the Portable Charging Cordset (EVSE) in building structures that use fuse-based circuit protection. Use only with electrical circuits protected by circuit breakers.
- Do not use the Portable Charging Cordset (EVSE) if other devices are plugged into the same circuit.
- When unplugging the Portable Charging Cordset (EVSE) from the wall outlet, be sure to pull by the plug, and not the cord.
- Do not pull, twist, bend, step on or drag the cord of the Portable Charging Cordset (EVSE).
- Stop using the Portable Charging Cordset (EVSE) immediately if charging stops before it's completed when the plug or cord is moved or adjusted.
- Do not use the Portable Charging Cordset (EVSE) if the plug has a loose connection with the wall outlet or if the wall outlet is damaged or rusted.
- If in any doubt about the wall outlet and/or circuit, contact a qualified electrician.
- Do not use if a malfunction occurs or if the Portable Charging Cordset (EVSE) has been damaged in any manner. It is recommended that you contact an authorized dealership.
- There are no user serviceable parts inside the Portable Charging Cordset (EVSE). Do not attempt to repair or service the Portable Charging Cordset (EVSE), doing so will void the New Vehicle Warranty.



**Portable Charging Cordset (EVSE)**

#### WARNING!

**INSTRUCTIONS PERTAINING TO A RISK OF FIRE OR ELECTRIC SHOCK:** Electrical shock, fire, and other serious hazards can occur if the Portable Charging Cordset (EVSE) is not used properly. This vehicle uses a high voltage current. Failure to follow the proper charging instructions in this publication can cause serious injury or death. There are no serviceable parts in the Portable Charging Cordset (EVSE). Do not open, disassemble, penetrate, or tamper with the Portable Charging Cordset (EVSE). Failure to follow this warning can result in electrical shock, fire, property damage, and death or serious injury.

The Portable Charging Cordset (EVSE) is stored in the rear cargo area below the load floor. To access this area, lift the handle of the load floor cover, and remove the Portable Charging Cordset (EVSE) from the storage bag in the rear cargo area.

### Moving, Transporting, And Storage Instructions

After use, the Portable Charging Cordset (EVSE) should be placed in the storage bag and put back in the cargo storage area. If the Portable Charging Cordset (EVSE) will be left outside the vehicle, be sure to protect the device's connection end from moisture, dirt, and debris accumulation and contamination.

#### NOTE:

The Portable Charging Cordset (EVSE) is used for AC Level 1 charging only.

#### WARNING!

**IMPORTANT SAFETY INSTRUCTIONS PERTAINING TO A RISK OF FIRE OR ELECTRIC SHOCK:** This publication contains important instructions and warnings that should be followed during charging operations. Failure to follow these warnings and instructions can result in electrical shock and fire which can cause death or serious injury.

- Read this entire publication before using the Portable Charging Cordset (EVSE).
- Do not put fingers or objects into the Portable Charging Cordset (EVSE) connector.
- Do not use the Portable Charging Cordset (EVSE) if the flexible power cord is frayed, broken, has cracked insulation, or any other signs of damage.
- Do not use the Portable Charging Cordset (EVSE) if the enclosure or the connector is broken, cracked, open, or shows any other indication of damage.
- Do not use the Portable Charging Cordset (EVSE) with an extension cord or plug adapters.
- The Portable Charging Cordset (EVSE) may attempt to reset and run after a power interruption.

(Continued)

#### WARNING!

- There are no user serviceable parts inside the Portable Charging Cordset (EVSE). Do not attempt to repair or service the Portable Charging Cordset (EVSE) yourself – personal injury may result.
- When using a charging station with the Portable Charging Cordset (EVSE) attached, ensure the charging station's cable is not visibly damaged before plugging into the vehicle.
- Do not allow children to operate the Portable Charging Cordset (EVSE). Adult supervision is mandatory when children are in proximity to the charge station that is in use.
- Do not use a charge station or vehicle charge inlet that is worn or damaged with the AC Level 2 charging cable. Plugging into worn or damaged receptacles may cause damage to the Portable Charging Cordset (EVSE) and vehicle.
- Ensure that the Portable Charging Cordset (EVSE) is always stored in a safe place. Do not expose the EVSE J1772 vehicle connector to rain or wet conditions. Avoid allowing water or other liquids to pour or drip onto the vehicle connection end of the J1772 EVSE connector. If water penetrates the electrical device, the risk of electrical shock increases. Ensure that all plugs and cables are free of moisture before using the Portable Charging Cordset (EVSE).
- In a collision, a loose Portable Charging Cordset (EVSE) in the vehicle could cause injury. It could fly around in a sudden stop and strike someone in the vehicle. Do not store the Portable Charging Cordset (EVSE) on the cargo load floor, or in the passenger compartment.

(Continued)

#### WARNING!

- The Portable Charging Cordset (EVSE) has been tested for use in temperatures ranging from -40°F to 122°F (-40°C to 50°C).
- The Portable Charging Cordset (EVSE) should be stored at temperatures between -40°F and 176°F (-40°C and 80°C).
- SAVE THESE INSTRUCTIONS.

### Portable Charging Cordset (EVSE)

The Portable Charging Cordset (EVSE) is compliant with SAE J1772, and applicable for use with vehicles fitted with standard SAE J1772 charge inlets. The Portable Charging Cordset (EVSE) includes:

- A charge connector
- A NEMA 6 rated enclosure with a Charge Current Interrupt Device (CCID) with a status indicator display
- An AC Power Cord with a NEMA 5-15P right angle plug
- An indoor/outdoor charge cable, EV-rated
- A Status Indicator Display

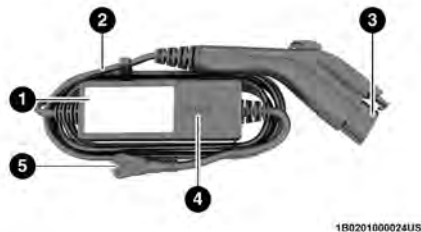

**Portable Charging Cordset (EVSE)**

- 1 – Portable Charging Cordset (EVSE) Enclosure
- 2 – Charge Cable
- 3 – Charge Connector
- 4 – Status Indicator Display
- 5 – AC Plug

## Grounding Instructions

### For A Grounded, Cord-Connected Product:

The Portable Charging Cordset (EVSE) must be grounded. If it should malfunction or break down, grounding provides a path of least resistance for an electric current to reduce the risk of electric shock. The Portable Charging Cordset (EVSE) is equipped with a cord having an equipment-grounding conductor and a grounding plug. The plug must be plugged into an appropriate outlet that is properly installed and grounded in accordance with all local codes and ordinances.

### WARNING!

**INSTRUCTIONS PERTAINING TO A RISK OF FIRE OR ELECTRIC SHOCK:** Do not use the Portable Charging Cordset (EVSE) on electrical circuits with two-prong outlets; use with improper outlets could result in electric shock, fire, property damage, and death or serious injury. Check with a qualified electrician if you are in doubt as to whether the wall outlet is properly grounded. Do not modify the plug prongs provided with the Portable Charging Cordset (EVSE) – if it does not fit the outlet, you must have a proper outlet installed by a qualified electrician.

## Portable Charging Cordset (EVSE) Installation And Operating Instructions

1. Always insert the AC plug prongs of the Portable Charging Cordset (EVSE) into a 15 A, or 20 A, 120 VAC, 60 Hz, grounded wall outlet first. Do not use an extension cord, outlet/plug adapter, or a worn outlet. The Portable Charging Cordset (EVSE) will not operate safely unless it is plugged directly into the wall outlet.

### NOTE:

The Portable Charging Cordset (EVSE) should be plugged into a dedicated circuit, not a circuit shared with other devices drawing electricity on the circuit.



**AC Plug And Wall Outlet**

### WARNING!

**INSTRUCTIONS PERTAINING TO A RISK OF FIRE OR ELECTRIC SHOCK:** Do not use the Portable Charging Cordset (EVSE) on electrical circuits with two-prong outlets; use with improper outlets could result in electric shock, fire, property damage, and death or serious injury. Check with a qualified electrician if you are in doubt as to whether the wall outlet is properly grounded. Do not modify the plug prongs provided with the Portable Charging Cordset (EVSE) – if it does not fit the outlet, you must have a proper outlet installed by a qualified electrician.

2. Check to see if the Portable Charging Cordset (EVSE) is ready to charge by reviewing the indicator lights.

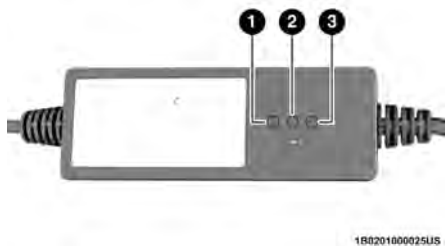

#### Portable Charging Cordset (EVSE) Indicator Lights

- 1 — Check Outlet Indicator Light  
 2 — Fault Indicator Light  
 3 — AC Power Indicator Light

3. If the Portable Charging Cordset (EVSE) is ready to charge, ensure the vehicle is in PARK, and then connect the charge connector to the vehicle's charge inlet. You will hear a "click" when the charge connector is inserted correctly and coupled with the vehicle's charge inlet.



#### Inserting The Charge Connector Into The Vehicle Charge Inlet

4. When the vehicle commences charging, the green indicator light will turn on.

#### NOTE:

The vehicle should start charging automatically. If not, please check the following:

- Portable Charging Cordset (EVSE) — The Portable Charging Cordset (EVSE) status indicator lights illuminate green, red, or yellow to identify the charging status ↪ page 22.
- Wall Outlet — Check whether the wall outlet is functional (no power outage) and/or plug the Portable Charging Cordset (EVSE) into a different wall outlet.

- Charging Schedule — Check whether or not the charging schedules have been enabled. If enabled, check that you are within the scheduled time and day of the week. If a charging schedule has been enabled in the vehicle, and it is outside the time and day of the week, you may override the schedule for this charging event by plugging in the charge connector, unplugging it, and then plugging it back into the vehicle charge inlet. Complete the double plug sequence within 10 seconds for it to override the set schedule.
  - Hood Ajar — Check whether the hood is open. Charging is disabled while the hood is open, and will resume when the hood closes.
5. To stop the charging process, disconnect the Portable Charging Cordset (EVSE) from the vehicle first, and then from the wall outlet. To disengage the vehicle coupler, push the button on the connector.



#### Removing The Charge Connector From The Vehicle Charge Inlet

6. Close the inlet door when a Portable Charging Cordset (EVSE) is not connected to the vehicle.

**NOTE:**

It is good practice to keep the ignition in the OFF position while conducting Level 1 charging. This minimizes any additional vehicle loads the Portable Charging Cordset (EVSE) has to support. The additional electrical loads will extend the high voltage battery charging time.

### Troubleshooting Using The Status Indicator Display

If the vehicle is not charging properly, consult the status indicator lights.

The **Green LED** signals correct operation of the system.

The **Red LED** signals a failure in the charging system.

The **Yellow LED** signals a failure with the outlet.

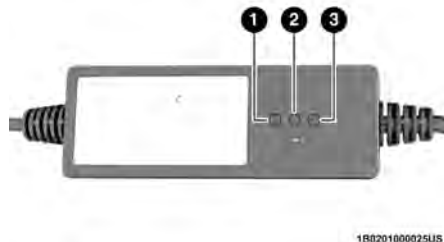

**LED Indicator Lights**

- 1 – Yellow LED
- 2 – Red LED
- 3 – Green LED

Any faults in charging are displayed by the LEDs, either steady or flashing, located on the status indicator display of the Portable Charging Cordset (EVSE). Refer to the following troubleshooting table:

Portable Charging Cordset (EVSE) Charging System Failure Troubleshooting				
Green LED	Red LED	Yellow LED	Description	Action/Consequences
OFF	OFF	OFF	Portable Charging Cordset (EVSE) not connected to the domestic charging outlet or power failure in the domestic power supply mains.	
ON	OFF	OFF	There are no faults in the domestic power supply mains, so the Portable Charging Cordset (EVSE) can be connected to the charge inlet on the vehicle.	
ON	ON (Flashing)	ON	Overheating at the charging outlet of the domestic power supply mains.	When the normal temperature is reached, the system will make a new charge attempt at a lower current level.



Portable Charging Cordset (EVSE) Charging System Failure Troubleshooting				
Green LED	Red LED	Yellow LED	Description	Action/Consequences
ON	OFF	ON (Flashing)	Charging to a lower current level due to overheating of the charging outlet of the domestic power supply mains.	
ON	ON	ON (Flashing)	Overheating at the charging outlet of the domestic power supply mains.	Carefully disconnect the Portable Charging Cordset (EVSE) from both the vehicle and power outlet and wait for the plug and outlet to return to normal temperatures. Then, reconnect the Portable Charging Cordset (EVSE) to the power outlet and vehicle and charge again. Contact a qualified electrician in case of a new anomaly.
ON	ON (2 Blinks)	ON (2 Blinks)	Lack of grounding cable in the charging outlet of the domestic power supply mains.	The system will make a new charge attempt after 30 seconds (6 attempts in total).
ON	ON	ON (2 Blinks)	Lack of grounding cable in the charging outlet of the domestic power supply mains.	The new charge attempt failed. Disconnect the Portable Charging Cordset (EVSE) from the vehicle and the outlet and reconnect it, then try to charge again. Contact a qualified electrician in case of a new anomaly.
ON (Flashing)	OFF	OFF	Domestic mains power incorrectly supplied.	The system will make a new charge attempt after 30 seconds (6 attempts total). If the fault persists, disconnect the Portable Charging Cordset (EVSE) from the vehicle and the outlet and reconnect it, then try to charge again. Contact a qualified electrician in case of a new anomaly.
ON	ON (Flashing)	OFF	Charge Current Interrupt Device (CCID) fault trip over one second after relay closure. Portable Charging Cordset (EVSE) retrying to charge the vehicle.	The system will make a new charge attempt after 30 seconds (6 attempts in total).
ON	ON	OFF	Charge Current Interrupt Device (CCID) fault, Retry Exhausted or Retry is disallowed if trips within one second of relay closure.	The new charge attempt failed. Disconnect the Portable Charging Cordset (EVSE) from the vehicle and the outlet and reconnect it, then try to charge again. Contact an authorized dealership in case of a new anomaly.

Portable Charging Cordset (EVSE) Charging System Failure Troubleshooting				
Green LED	Red LED	Yellow LED	Description	Action/Consequences
ON	ON	OFF	Dispersion of the electricity on the vehicle.	Disconnect the Portable Charging Cordset (EVSE) from the vehicle and the outlet and reconnect it, then try to charge again. Contact an authorized dealership in case of a new anomaly.
ON	ON (Flashing)	OFF	Electric charging current too high.	The system will make a new charge attempt after 30 seconds (6 attempts total).
ON	ON (7 Blinks)	OFF	Electric charging current too high.	The new charge attempt failed. Disconnect the Portable Charging Cordset (EVSE) from the vehicle and the outlet and reconnect it, then try to charge again. Contact an authorized dealership in case of a new anomaly.
ON	ON (2 Blinks)	OFF	Charging abnormality on the vehicle.	The system will make a new charge attempt after 30 seconds (6 attempts total).
ON	ON (3 Blinks)	OFF	Portable Charging Cordset (EVSE) failure.	If the fault persists, disconnect the Portable Charging Cordset (EVSE) from the vehicle and the domestic power outlet and reconnect it, then try to charge again. Contact an authorized dealership in case of a new anomaly.
ON	ON (4 Blinks)	OFF		
ON	ON (5 Blinks)	OFF		
ON	ON (6 Blinks)	OFF		
ON	ON (6 Blinks)	OFF		

Guidelines for preventing fire and electric shock:

- Ensure the Portable Charging Cordset (EVSE) is positioned so it will not be stepped on, tripped over, or otherwise subjected to damage or stress.
- There are no user serviceable parts inside.
- Do not use the Portable Charging Cordset (EVSE) if it is visibly damaged. Contact an authorized dealership for service.
- Do not place fingers, or any other objects inside the charge connector.
- Do not allow children to operate the Portable Charging Cordset (EVSE). Adult supervision is mandatory when children are in proximity when the Portable Charging Cordset (EVSE) is in use.
- Do not use the Portable Charging Cordset (EVSE) with an extension cord or plug adapters.
- Do not unplug the Portable Charging Cordset (EVSE) from the wall outlet during a charging operation.

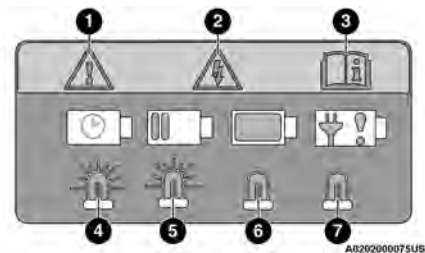

Charging Inlet Warning Label

- 1 – Dangerous Situation
- 2 – Risk Of Electric Shock
- 3 – Reference Owner's Information
- 4 – Charging Timer Set
- 5 – Charging Procedure In Progress
- 6 – Charging Procedure Complete
- 7 – Fault In Charging Procedure

**NOTE:**

During normal operation, the charge connector or AC plug may feel warm. If either one feels hot during charging, unplug the Portable Charging Cordset (EVSE) and have a qualified electrician inspect the wall outlet before you continue charging ↪ page 282.

**WARNING!**

**INSTRUCTIONS PERTAINING TO A RISK OF FIRE OR ELECTRIC SHOCK:** Do not use the Portable Charging Cordset (EVSE) with an outlet that is worn or damaged. Failure to follow this warning can result in electrical shock, fire, property damage, and death or serious injury.

## AC LEVEL 2 CHARGING (240 VOLT, 40 AMP)

AC Level 2 (240 Volt) charging requires a 240 Volt, Level 2 Electric Vehicle Supply Equipment (EVSE) charging station. A 40 Amp Level 2 EVSE for home installation is recommended. The Level 2 EVSE connects to a 40 Amp circuit breaker and delivers 32 Amp maximum to the vehicle.

When using public charging stations, ensure the charging station is ready to provide charge and the vehicle is in PARK before the Level 2 EVSE is plugged into the vehicle's charge inlet. You will hear a "click" when the charge connector is inserted correctly and is coupled with the vehicle's charge inlet.

**NOTE:**

The vehicle should start charging automatically. If not, please check the following:

- Charging Station – Check the indications and instructions at the charging station.
- Charging Schedule – Check whether the charging schedule is enabled and if so, whether the vehicle is currently within the scheduled charge time/day (weekday/weekend). If the charging schedule is enabled within the vehicle, you may override it for

this charging event by plugging in the charge connector, unplugging it, and then plugging it back into the vehicle charge inlet. Complete the double plug sequence within 10 seconds for it to override the set schedule.

- Hood Ajar – Check whether the hood is open. Charging is disabled while the hood is open, and will resume when the hood closes.

To stop the charging process:

- Press the button located on the Level 2 EVSE vehicle connector.
- Remove the connector from the vehicle charge inlet.
- Plug the charge handle into the Level 2 EVSE station and coil the charging cord onto its holder. Do not leave the charging cord lying on the ground.

## CHARGING TIMES

The following factors determine the time it takes to charge the high voltage battery:

- The high voltage battery's current State Of Charge (SOC)
- The type of Electric Vehicle Supply Equipment (EVSE) used (Level 1 – 120 V or Level 2 – 240 V)
- Ambient temperature
- Whether the vehicle's ignition is in the RUN position during charging

**NOTE:**

- The following charging times are estimates based on charging a high voltage battery that has a <1% State Of Charge (SOC) value displayed in the instrument cluster.

- Charging times will vary based on the age, condition, SOC, available current being provided to the charger from its energy source, and temperature of the high voltage battery.
- Charging times may be longer if a thermal self-protection reduces the charging current from the EVSE being used.
- If the vehicle's ignition is in the ON/RUN position, the vehicle charge indicator may not indicate greater than a 99% SOC and will continue to charge the vehicle, due to the vehicle loads.

Type of EVSE	Estimated Charge Time
Level 1 (120 V/12 A)	Approximately 12-13 hours
Level 2 (240 V/32 A)	Approximately 2-3 hours

## VEHICLE CHARGE INDICATORS

### Instrument Panel High Voltage Battery Display

There is a battery display indicator located in the rear left side of the vehicle and gives immediate feedback on the charging status. The battery display will indicate the current State Of Charge (SOC) for the high voltage battery. When plugged in, the battery symbol also indicates the battery level along with messages about the charge or whether the system is waiting to charge due to the charge schedule. These will appear unless there is a charging fault. A green plug telltale will be shown in the cluster, as well as applicable messaging when charging.

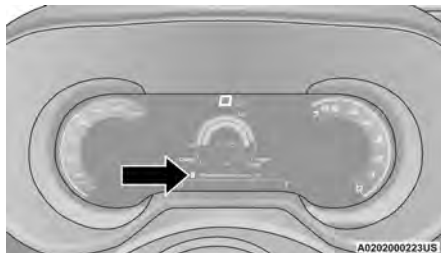

**High Voltage Battery Display**

### State Of Charge Indicator

In addition to the battery display in the instrument cluster, your vehicle is equipped with a visual SOC indicator. The SOC indicator is made up of five lights, which will illuminate when the vehicle is plugged into the charging system.

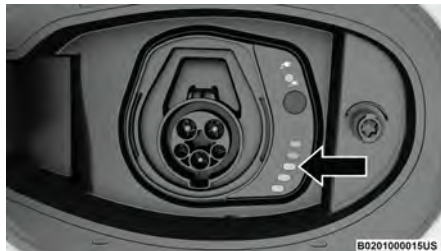

**State Of Charge Indicator**

The SOC indicator provides a visual indication of the high voltage battery's charge status during charging. It is also used to indicate a charging problem as well as waiting for a scheduled charge to begin.

### NOTE:

The lights scroll one at a time when the vehicle is plugged in outside of its charging schedule time/day of the week, and it is waiting on the schedule to begin charging.

In extreme hot or cold environments, the lights on the SOC indicator may not illuminate. Charge status is available in the instrument cluster display. In the event of an error in the charging process, the outer two lights will blink.

When the hood is open, the lights on the SOC indicator will not be illuminated.



Number Of Indicator Lights Illuminated	Percent Of Battery Charge
1st light blinks	0 - 20%
1st light on, 2nd light blinks	21 - 40%
1st and 2nd lights on, 3rd light blinks	41 - 60%
1st, 2nd, and 3rd lights on, 4th light blinks	61 - 80%
1st, 2nd, 3rd, and 4th lights on, 5th light blinks	81 - 99%
All five lights on	100%
Two outer lights are blinking	Indicates an error in the charging process
Lights turn on one at a time	Indicates system is waiting for scheduled time in charge schedule to begin charging
All lights turn on, then immediately turn off	Indicates a successful plug-in

**NOTE:**

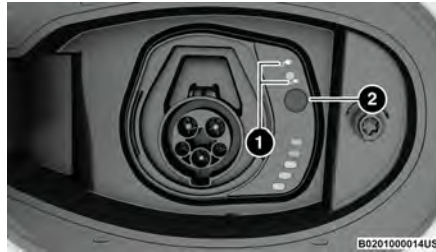
For each segment of lights illuminated indicating the percent of battery charge, two different blink rates are used. A blink rate of 1 second on/1 second off indicates that the first half is charging. The blink rate will increase to 0.5 second on/0.5 second off to indicate that the second half is charging. When the battery is fully charged, the blinking stops and the lights remain illuminated as charging continues.

**Smart Charging Port**

- 1 – White LED Charging Mode Icons
- 2 – Charging Button

White LED Charging Mode Icons	
	Charge now
	Charge by scheduled charge (if set)

**Charging Button:** has different uses and sequences depending on which charging mode is set:

- **No scheduled charge**
  - Plug the vehicle: charge starts
  - Push the charging button: charge is stopped
  - Push again the charging button: charge starts again
- **Scheduled charge (not started yet)**
  - Plug the vehicle, scheduled charge is ready (as set)
  - Push the charging button: charge starts
  - Push again the charging button: charge is stopped, and scheduled charge is set again
- **Scheduled charge (set and started)**
  - Plug the charging button: charge is stopped
  - Push the charging button: immediate charge starts (scheduled charge is overridden)
  - To restart the scheduled charge: unplug and plug-in again the inlet

Next to the charging inlet, there is an LED that changes color based on charging status.



**Charging Inlet LED Location**

LED Charging Inlet	
LED Light Color	Status
Blue	Indicates that the system is waiting for a scheduled recharge.
Flashing Green	Charging process in place.
Solid Green	Indicates the vehicle is fully charged.
Blinking Red	Indicates a fault in the charging system.

## HYBRID ELECTRIC PAGES

Within your Uconnect system is the Hybrid Electric App that allows you to see your vehicle's power flow, understand your driving history, and set a charging schedule for your vehicle's high voltage battery. To access this app, press the Apps button on the main menu bar of the radio's touchscreen, and locate the Hybrid Electric App. Pressing the app icon brings you to a set of hybrid electric pages: Power Flow, Driving History, Charging Schedule, e-Save, and Charge Settings (if equipped).



Apps Menu Screen

### Power Flow

The Power Flow screen shows the current power readings for all of the following:

- Engine - Shows the amount of power (in kW) the engine is generating. Based on vehicle operating conditions, this power is used to: propel the vehicle, provide passenger compartment heating, power vehicle electrical loads, and charge the high voltage battery. Engine operation is controlled to maximize fuel economy.
- Battery - Shows the amount of power (in kW) the high voltage battery is currently providing/absorbing. A negative kW indicates the vehicle's high voltage battery is charging.

- Climate - Shows the amount of power (in kW) the Climate Control system is using to maintain the current interior temperature.

Power Flow paths are indicated by the direction of the arrows on the touchscreen.



Power Flow Screen

### Driving History

The Driving History screen shows the miles (km) driven in both Full Electric and Hybrid (battery and engine powered) modes for both the previous week and the current week. The data is displayed in a bar graph: Electric mode in teal and Hybrid mode in blue.

On the bar graph, miles (km) driven on the same day in Electric mode (battery only) are always shown below miles (km) driven in Hybrid mode. When one day of the week exceeds 100 miles (160 km) driven, the values for miles (km) driven in Electric and Hybrid modes will be listed above the bar graph in respective colors (teal for Electric and blue for Hybrid).

The regeneration graphs show the amount of energy through coasting and braking for the current and previous week.

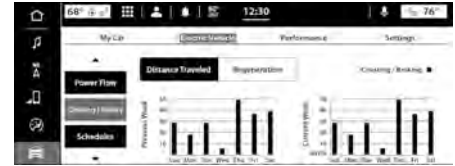

Driving History Screen

### Charging Schedule

To set a charging schedule, select the Hybrid Electric App on the touchscreen and follow these steps:

1. If the charging cable is connected to the vehicle, select "Activate PHEV", then select "Schedules".

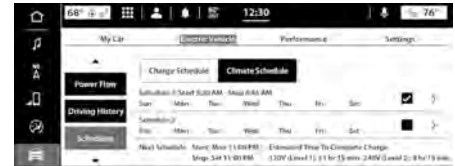

Charging Schedules Screen

2. Select one of the two charging schedules by pressing the appropriate arrow on the right side of the screen.
3. Select if Scheduled Charging should "Charge Until Full".
4. Set the Charge Start & Stop Times: Hours & Minutes.

**NOTE:**

Access the “Repeat Every” feature to select the day(s) on which to start charging.

**Set Charge Schedule**

- When done, press the back arrow. The active schedule will be indicated by the check mark to the right of the schedule event line. The Event Action and Time will be displayed.
- To add another Scheduled Charging event, repeat these steps.

**NOTE:**

A maximum of two independent Scheduled Charging events can be scheduled at a given time.

**Charge Until Full**

If “Charge Until Full” is selected, the vehicle must be plugged in within five minutes of the start time. The following are situations in which “Charge Until Full” may not be honored:

- If selected for five days (Monday through Friday), and the vehicle is plugged in five or more minutes after the start time on any of those days, “Charge Until Full” will not be honored for that day. “Charge Until Full” will resume on the next day at the scheduled time.
- If there are multiple plug/unplug events after first being plugged in within five minutes, “Charge Until Full” will not be honored for that day.
- If other schedules (Charge Interval, etc.) are set at a later time in addition to “Charge Until Full” being selected, and the vehicle is plugged in five or more minutes after the scheduled start time, “Charge Until Full” will not be honored for that day. The next available schedule will be followed.

**NOTE:**

- If the charging schedule is not enabled, the vehicle will charge whenever plugged in. It is not necessary to set up the charging schedule to charge the vehicle.
- If the vehicle is plugged in outside of the charging schedule set in the Uconnect system (and Charge Until Full is not selected), the vehicle’s battery will not charge. Charging will only begin immediately if the vehicle is plugged in within the time and day of the week set in the schedule. Otherwise, charging will automatically begin when the selected charge time/day of the week occurs or whenever the vehicle is plugged in with no charge schedule set.
- Scheduled Charging may be bypassed and charging will begin automatically if the high voltage battery state of charge is below its optimal operating point.
- If the vehicle is turned off outside of the charging window, a radio pop-up message will be displayed, which provides an option to begin charging the vehicle immediately. The pop-up message asks the driver if they would like to “Charge Now?” and provides other information, including the next charging schedule start time and estimated time to charge the battery to 100%. If within one hour of selecting

“Yes,” the vehicle is connected to a powered EVSE, the vehicle will immediately begin to charge (temporarily ignoring any set charge schedule). To fully deactivate the charge schedule, refer to the “Schedules” feature within the Hybrid Electric app.

- The charging schedule can also be overridden if an EVSE is plugged in, unplugged, and then plugged in a second time to the vehicle. After the first plug in of the vehicle, wait until the battery charge indicator on the instrument panel lights up before unplugging. This “double plug sequence” will override the schedule that is set in the radio, and begin charging the vehicle immediately. The double plug sequence must be completed within 10 seconds for it to override the programmed schedule.
- If “Charge Until Full” is selected, and the vehicle is plugged in after the start time of the schedule, the vehicle will start charging when it reaches the start time the next day. If you would like to begin charging immediately, and continue charging until the vehicle is fully charged, you can select the “Charge Now” option or use the double plug override option.



## SCHEDULE BYPASS

### NOTE:

If the vehicle is turned off outside of the charging window, a radio pop-up message will be displayed. The pop-up message asks the driver if they would like to “Charge Now?” and provides the next charging schedule start time and estimated time to charge the battery to 100%. If within one hour of selecting “Yes”, the vehicle is connected to a powered EVSE, the vehicle will immediately begin to charge (temporarily ignoring any set charge schedule). To fully deactivate the charge schedule, select the “Enable Schedule” checkbox until the check mark is removed from the box.

The charging schedule can also be overridden if the EVSE is plugged in, unplugged, and then plugged in a second time to the vehicle. This double plug sequence will override the set schedule in the Hybrid Electric App, and begin charging the vehicle immediately. The double plug sequence must be completed within 10 seconds for it to override the programmed schedule.

### e-Save

The fourth screen within the Hybrid Electric App is the e-Save screen. From this screen, you can specify the behavior of the e-Save drive mode:

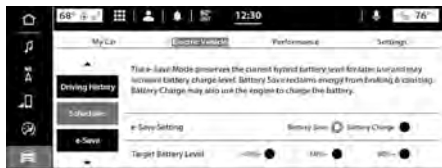

e-Save Screen

- **Battery Save** - Maintains the high voltage State of Charge (SOC) at its current level under most driving scenarios.

### NOTE:

- The SOC may increase if there is sufficient energy capture through regenerative braking.
- **Battery Charge** - Uses additional power from the gas engine to increase the high voltage SOC, up to 40%, 60%, or 80% capacity. If the vehicle SOC is greater than the Battery Charge Target Charge Level, the vehicle will use the gas and battery to efficiently deplete down to the target level while the vehicle is driven.

## Charge Settings — If Equipped

The fifth screen within the Hybrid Electric App is the Charge Setting screen. From this screen, you can select the rate at which your vehicle charges. Rate selections 1 (low rate of charge) through 5 (high rate of charge) are available. The lower the selected rate, the longer it will take for your vehicle to reach a full charge.



Charge Setting Screen

The Charge Setting can be adjusted by pressing the “+” or “-” buttons, and the estimated time until full charge will update on the right side of the screen to reflect the selected Charge Setting. The display also shows information related to:

- **Battery Level** — Indicates, in percentage, the high-voltage battery SOC.
- **Estimate time to 100%** — Corresponds to the time required to obtain full recharging of the high-voltage battery.

### NOTE:

- The Charge Setting will be saved each time the vehicle is turned off, then back on again.
- For information on jump starting your vehicle  page 222.

## KEYS

### KEY FOBS

Your vehicle is equipped with a key fob which supports Passive Entry, Remote Keyless Entry (RKE), Keyless Enter 'n Go™ (if equipped), Remote Start (if equipped), and Panic button operation. The key fob allows you to lock or unlock the doors and liftgate from distances up to approximately 66 ft (20 m). In some conditions, this distance can be reduced or increased. The key fob does not need to be pointed at the vehicle to activate the system. The key fob also contains an emergency key, which is stored in the rear of the key fob.

**NOTE:**

- The key fob's wireless signal may be blocked if the key fob is located next to a metallic object, mobile phone, laptop, wireless charging pad, or other electronic device. This may result in poor performance.
- If the key fob's battery is near depletion, the key fob performance can be reduced.
- With the ignition on and the vehicle moving at 2 mph (4 km/h), all RKE commands are disabled.

**Keyless Ignition Key Fob**

B0204000152US

- 1 — Unlock
- 2 — Liftgate
- 3 — Panic
- 4 — Lock
- 5 — Remote Start (If Equipped)

**NOTE:**

In case the ignition switch does not change with the push of a button, the key fob may have a low or fully depleted battery. A low key fob battery can be verified by referring to the instrument cluster, which will display directions to follow → page 282.

**To Unlock/Lock The Doors And Liftgate**

Push and release the unlock button on the key fob once to unlock the driver's door. If selected within Uconnect Settings, pushing the unlock button twice within five seconds will unlock all the doors and the liftgate. To lock all the doors and the liftgate, push the lock button once. Unlock settings can be changed within the Uconnect system → page 149.

When the doors are unlocked, the turn signals will flash and the illuminated entry system will be activated. When the doors are locked, the turn signals will flash and the horn will chirp.

**Using The Panic Feature**

To turn the Panic feature on or off, push the Panic button on the key fob. When the Panic feature is activated, the turn signals will flash, the horn may pulse on and off (if equipped with horn alarm), and the interior lights will turn on.

The Panic feature will stay on for three minutes unless you turn it off by either pushing the Panic button a second time or driving the vehicle at a speed of 15 mph (24 km/h) or greater.

**NOTE:**

- The interior lights will turn off if you place the ignition in the ON/RUN position while the Panic feature is activated. However, the exterior lights and horn (if equipped with horn alarm) will remain on.
- You may need to be closer than 66 ft (20 m) from the vehicle when using the key fob to turn off the Panic feature due to the radio frequency noises emitted by the system.

**Key Left Vehicle Feature**

If a valid key fob is no longer detected inside the vehicle while the vehicle's ignition system is in the ON/RUN or START position, the message "Key Fob Has Left The Vehicle" will be shown in the instrument cluster display and an interior chime will sound. An exterior audible and visual alert will also be activated to warn the driver. The vehicle's horn will rapidly chirp three times along with a single flash of the vehicle's exterior lights.

**NOTE:**

- The doors have to be open and then closed in order for the vehicle to detect a key fob. The Key Left Vehicle feature will activate when the first door is closed and no key fob is detected in the vehicle. If the warning has been activated, and the other doors are closed, no other warnings will be issued.
- These alerts will not be activated in situations where either the vehicle's engine is left running with the key fob inside, or the key fob's wireless signals are blocked.

## Using The Key Fob To Open/Close Vehicle Windows — If Equipped

### To Open The Windows

From outside of the vehicle, push the unlock button on the key fob twice, and hold for several seconds. All vehicle door windows will open.

### To Close The Windows

From outside of the vehicle, push the lock button on the key fob twice, and hold for several seconds. All vehicle door windows will close.

### NOTE:

- This feature is enabled through Uconnect Settings [↔](#) page 149.
- Vehicle must be equipped with front and rear auto up/down windows.

## Replacing The Battery In The Key Fob

The replacement battery is one CR2032 battery.

### NOTE:

- Customers are recommended to use a battery obtained from Mopar®. Aftermarket coin battery dimensions may not meet the original OEM coin battery dimensions.
- Perchlorate material — special handling may apply. See [www.dtsc.ca.gov/hazardouswaste/perchlorate](http://www.dtsc.ca.gov/hazardouswaste/perchlorate) for further information.
- Do not touch the battery terminals that are on the back housing or the printed circuit board.

To replace the key fob battery, proceed as follows:

1. Place the key fob with the buttons facing downward, then press on both sides of the key fob at the same time while sliding the cover downward to remove.



Remove Key Fob Cover

B0204000153US

2. Remove the emergency key by lifting it out of its housing.



Remove Emergency Key

B0204000154US

3. Remove the battery cap by rotating it counterclockwise.



Remove Battery Cap

B0204000155US

4. Remove the key fob battery from its housing and replace it with the same type.



Key Fob Battery Replacement

B0204000156US

**WARNING!**

- The integrated key fob contains a coin cell battery. Do not ingest the battery; there is a chemical burn hazard. If the coin cell battery is swallowed, it can cause severe internal burns in just two hours and can lead to death.
- If you think a battery may have been swallowed or placed inside any part of the body, seek immediate medical attention.
- Keep new and used batteries away from children. If the battery compartment does not close securely, stop using the product and keep it away from children.

## Programming And Requesting Additional Key Fobs

Programming the key fob may be performed by an authorized dealer.

**NOTE:**

- Once a key fob is programmed to a vehicle, it cannot be repurposed and reprogrammed to another vehicle.
- Only key fobs that are programmed to the vehicle electronics can be used to start and operate the vehicle.

**WARNING!**

- Always remove the key fobs from the vehicle and lock all doors when leaving the vehicle unattended.

*(Continued)*

**WARNING!**

- For vehicles equipped with Keyless Enter 'n Go™ Ignition, always remember to place the ignition in the OFF position when exiting the vehicle.

Duplication of key fobs may be performed at an authorized dealer. This procedure consists of programming a blank key fob to the vehicle electronics. A blank key fob is one that has never been programmed.

**NOTE:**

- When having the Sentry Key Immobilizer system serviced, bring all vehicle keys with you to an authorized dealer.
- Keys must be ordered to the correct key cut to match the vehicle locks.
- It is not mandatory to replace the key fob if a new emergency key is needed, and vice versa.

## SENTRY KEY

The Sentry Key Immobilizer system prevents unauthorized vehicle operation by disabling the engine. The system does not need to be armed or activated. Operation is automatic, regardless of whether the vehicle is locked or unlocked.

The system uses a key fob, keyless push button ignition and a Radio Frequency (RF) receiver to prevent unauthorized vehicle operation. Therefore, only key fobs that are programmed to the vehicle can be used to start and operate the vehicle. The system cannot reprogram a key fob obtained from another vehicle.

After placing the ignition in the ON/RUN position, the Vehicle Security Light will turn on for three seconds for a bulb check. If the light remains on after the bulb check, it indicates that there is a problem with the electronics. In addition, if the light begins to flash after the bulb check, it indicates that someone attempted to start the engine with an invalid key fob. In the event that a valid key fob is used to start the engine but there is an issue with the vehicle electronics, the engine will start and shut off after two seconds.

If the Vehicle Security Light turns on during normal vehicle operation (vehicle running for longer than 10 seconds), it indicates that there is a fault in the electronics. Should this occur, have the vehicle serviced as soon as possible by an authorized dealer.

**CAUTION!**

The Sentry Key Immobilizer system is not compatible with some aftermarket Remote Start systems. Use of these systems may result in vehicle starting problems and loss of security protection.

All of the key fobs provided with your new vehicle have been programmed to the vehicle electronics  
 page 282.

**NOTE:**

A key fob that has not been programmed is also considered an invalid key.

## IGNITION SWITCH

### KEYLESS ENTER 'N GO™ IGNITION

This feature allows the driver to operate the ignition with the push of a button as long as the key fob is in the passenger compartment.

The START/STOP ignition button has three operating modes. The three modes are: OFF, ON/RUN, and START.



B0205000055US

**START/STOP Ignition Button**

The push button ignition can be placed in the following modes:

#### OFF

- The engine is stopped.
- Some electrical devices (e.g., power locks, etc.) are still available.

#### ON/RUN

- Driving mode.
- All electrical devices are available (e.g., climate controls, heated seats, etc.).

#### START

- The engine will start.

#### Starting The Engine With A Depleted Key Fob Battery

If the ignition state/mode does not change with the push of a button, the key fob may have a low or depleted battery. In this situation, a backup method can be used to operate the ignition switch:

Place the key fob in the cupholder, and then press the ignition button.



B0205000055US

**Place Key Fob In Cupholder**

#### NOTE:

If the key fob battery is depleted, and the vehicle doors were locked using the key fob lock button, Passive Entry lock button (if equipped), or the vehicle App (if equipped), the engine must be started using the described backup starting method. The vehicle doors can then be unlocked using one of the unlock methods (key fob, Passive Entry handle, or vehicle App).

#### To Stop The Engine With A Depleted Key Fob Battery

Push and hold the ignition button for several seconds, or push it three times quickly.

#### NOTE:

- The ignition button will not activate if the key fob is inside the rear cargo compartment while the liftgate is open.
- If the ignition is in the ON/RUN position for 30 minutes while the gear selector is in PARK, the ignition will automatically be placed in the OFF position.
- For information on normal starting, see [page 98](#).
- When opening the driver's door and the ignition is in the ON/RUN (engine not running) position, a chime will sound to remind you to place the ignition in the OFF position. In addition to the chime, the "Vehicle On" message will display in the cluster.

#### Disabling A Key Fob Left Inside The Vehicle

The key fob can be disabled from starting the vehicle if it is left in the passenger compartment. To do this, proceed as follows:

1. Close all doors and the liftgate.
2. Push the lock button on another key fob twice, or push the Passive Entry lock button on the door handle (with another key fob within range), waiting three seconds between each push.
3. Wait 30 seconds without unlocking the vehicle or opening any doors.

To reactivate the previously disabled key fob, the vehicles must be either unlocked or started with a key fob.

**WARNING!**

- When exiting the vehicle, always remove the key fob from the vehicle and lock your vehicle.
- Never leave children alone in a vehicle, or with access to an unlocked vehicle.
- Allowing children to be in a vehicle unattended is dangerous for a number of reasons. A child or others could be seriously or fatally injured. Children should be warned not to touch the parking brake, brake pedal or the gear selector.
- Do not leave the key fob in or near the vehicle, or in a location accessible to children, and do not leave the ignition of a vehicle equipped with Keyless Enter 'n Go™ in the ON/RUN position. A child could operate power windows, other controls, or move the vehicle.
- Do not leave children or animals inside parked vehicles in hot weather. Interior heat buildup may cause serious injury or death.

**CAUTION!**

An unlocked vehicle is an invitation for thieves. Always remove key fob from the vehicle and lock all doors when leaving the vehicle unattended.

## KEYLESS ENTER 'N GO™ IGNITION — PHEV ONLY

This feature allows the driver to operate the ignition with the push of a button as long as the key fob is in the passenger compartment.

**NOTE:**

This vehicle is equipped with an automatic shutdown feature. If the vehicle is left with the ignition in the RUN position (engine not running) with gear selector in PARK for 30 minutes, it will automatically turn off the vehicle. If the driver door is opened, then closed while propulsion is active and the vehicle is in PARK, the vehicle will shut down. Notifications have been designed into this feature to raise awareness of the timed event by showing messages in the instrument cluster display.

The instrument cluster display will also show the message "Ready to Drive" accompanied with three audible chimes while the driver door is opened while the ignition state is in READY mode. The interior warnings will occur regardless of whether the key fob remains in the vehicle or is removed. The horn will sound three times, and the turn signals will flash, if the key fob is removed from the vehicle while the ignition state is in READY mode.

To restart the vehicle, follow the normal process for starting your vehicle.

The START/STOP ignition button has three operating modes. The three modes are: OFF, ON/RUN, and START.



B0205000058US

**START/STOP Ignition Button****NOTE:**

- Pushing the START/STOP ignition button may only activate the Electric Propulsion System and not start the vehicle's engine (if running the engine is not currently required by the Hybrid system). READY will show in the instrument cluster display whenever the vehicle is operating in Electric mode and the vehicle is stationary.
- If the vehicle's ignition is in either ACC or RUN, the vehicle charge indicator may not display a value greater than 99% state of charge due to vehicle loads.

The push button ignition can be placed in the following modes:

**OFF**

- The engine is stopped.
- Some electrical devices (e.g., power locks, etc.) are still available.
- Mechanical power (Vehicle Propulsion) is not available

**ON/RUN**

- Driving mode.
- All electrical devices are available (e.g., climate controls, heated seats, etc.).
- As long as READY appears in the instrument cluster display, it does not matter if the engine is running or not, vehicle propulsion is available

**START**

- The engine will start.

**NOTE:**

- Vehicle propulsion is only available after the vehicle has passed through the START position.
- If the brake is pressed and the ignition is placed in the RUN position with a charging cable connected to the vehicle, the instrument cluster display will not display the READY state. When the charging cable is unplugged from the vehicle, the vehicle will go into the READY state. If the vehicle is not shifted out of PARK 30 minutes after being unplugged, the vehicle will disable the READY state. After an additional 30 minutes with no change in ignition status, the ignition will turn off and the vehicle will power down  page 98.

**Conditions Which May Cause The Engine To Run**

- When the Hybrid Battery State of Charge (SOC) has reached <1%
- When applying maximum vehicle acceleration
- While maintaining the Exhaust System Catalyst Temperature in Hybrid or e-Save modes
- When the hood is open with the ignition in RUN, post-START mode
- When Manual Mode/Tip Mode is in use

- When the engine is temporarily operating in Fuel and Oil Refresh Mode (e.g. if the system detects a stale fuel or aged oil condition after a long period without combustion engine operation)
- When the vehicle is started in very cold ambient temperatures
- When the vehicle is in a lower ambient temperature and may need to support passenger compartment heating

For information on starting the engine with a depleted key fob battery, see  page 35.

**WARNING!**

- When exiting the vehicle, always remove the key fob from the vehicle and lock your vehicle.
- Never leave children alone in a vehicle, or with access to an unlocked vehicle.
- Allowing children to be in a vehicle unattended is dangerous for a number of reasons. A child or others could be seriously or fatally injured. Children should be warned not to touch the parking brake, brake pedal or the gear selector.
- Do not leave the key fob in or near the vehicle, or in a location accessible to children, and do not leave the ignition of a vehicle equipped with Keyless Enter 'n Go™ in the ON/RUN position. A child could operate power windows, other controls, or move the vehicle.
- Do not leave children or animals inside parked vehicles in hot weather. Interior heat buildup may cause serious injury or death.

**CAUTION!**

An unlocked vehicle is an invitation for thieves. Always remove key fob from the vehicle and lock all doors when leaving the vehicle unattended.

2

**REMOTE START — IF EQUIPPED**

This system uses the key fob to start the engine conveniently from outside the vehicle while still maintaining security. The system has a range of approximately 328 ft (100 m).

Remote Start is used to defrost windows in cold weather and to reach a comfortable climate in all ambient conditions before the customer enters the vehicle.

**NOTE:**

- For PHEV Models: Remote Start while the vehicle is plugged in may not always start the engine.
- Obstructions between the vehicle and key fob may reduce this range  page 282.

**WARNING!**

- Do not start or run an engine in a closed garage or confined area. Exhaust gas contains carbon monoxide (CO) which is odorless and colorless. Carbon monoxide is poisonous and can cause serious injury or death when inhaled.
- Keep key fobs away from children. Operation of the Remote Start system, windows, door locks or other controls could cause serious injury or death.

## HOW TO USE REMOTE START

Push and release the Remote Start button on the key fob twice within five seconds. The vehicle doors will lock, the parking lights will flash, and the horn will chirp twice (if programmed). Then, the engine will start, and the vehicle will remain in the Remote Start mode for a 15 minute cycle. Pushing the Remote Start button a third time shuts the engine off.

### NOTE:

- With Remote Start, the engine will only run for 15 minutes.
- Remote Start can only be used twice.
- If an engine fault is present or fuel level is low, the vehicle will start and then shut down in 10 seconds.
- The parking lights will turn on and remain on during Remote Start mode.
- For security, power window and power sunroof operation (if equipped) are disabled when the vehicle is in the Remote Start mode.
- The ignition must be placed in the ON/RUN position before the Remote Start sequence can be repeated for a third cycle.

All of the following conditions must be met before the engine will remote start:

- Gear selector in PARK
- Doors closed
- Hood closed
- Liftgate closed
- Hazard switch off
- Brake switch inactive (brake pedal not pressed)
- Battery at an acceptable charge level

- Key Fob Panic button not pushed
- System not disabled from previous Remote Start event
- Ignition in the OFF position
- Fuel level meets minimum requirement
- Malfunction Indicator Light (MIL) is not illuminated
- **For PHEV Models:** Malfunction Indicator Light (MIL) is not illuminated while the vehicle's propulsion system is active

### WARNING!

- Do not start or run an engine in a closed garage or confined area. Exhaust gas contains carbon monoxide (CO) which is odorless and colorless. Carbon monoxide is poisonous and can cause serious injury or death when inhaled.
- Keep key fobs away from children. Operation of the Remote Start system, windows, door locks or other controls could cause serious injury or death.

## TO EXIT REMOTE START MODE

To drive the vehicle after starting the Remote Start system, push and release the START/STOP ignition button prior to the end of the 15 minute cycle.

The Remote Start system will turn the engine off if the Remote Start button on the key fob is pushed again, or if the engine is allowed to run for the entire 15 minute cycle. Once the ignition is placed in the ON/RUN position, the climate controls will resume previously set operations (temperature, blower control, etc.).

**For PHEV Models:** The ignition can be placed in the RUN (Propulsion System Available) position by pushing the ignition button with the key fob inside the vehicle, and then pushing the ignition button one more time to place the ignition in the OFF position.

### NOTE:

- For vehicles not equipped with the Keyless Enter 'n Go™ — Passive Entry feature, the ignition switch must be in the ON/RUN position in order to drive the vehicle.
- For vehicles equipped with the Keyless Enter 'n Go™ — Passive Entry feature, the message "Remote Start Active — Push Start Button" will show in the instrument cluster display until you push the START/STOP ignition button.
- To avoid unintentional shutdowns, the system will disable for two seconds after receiving a valid Remote Start request.

## REMOTE START FRONT DEFROST ACTIVATION — IF EQUIPPED

When Remote Start is active, and the outside ambient temperature is 40°F (4.5°C) or below, the system will automatically activate front defrost for 15 minutes or less. The timing is dependent on the ambient temperature. Once the timer expires, the system will automatically adjust the settings depending on ambient conditions. See "Remote Start Comfort Systems — If Equipped" in the next section for detailed operation.



## REMOTE START COMFORT SYSTEMS — IF EQUIPPED

When Remote Start is activated, the front and rear defrost will automatically turn on in cold weather. The heated steering wheel and driver heated seat feature will turn on if programmed in the Comfort menu screen within Uconnect Settings ↪ page 149. In warm weather, the driver vented seat feature will automatically turn on when Remote Start is activated, if programmed in the Comfort menu screen. The vehicle will adjust the climate control settings depending on the outside ambient temperature.

### Automatic Temperature Control (ATC) — If Equipped

The climate controls will automatically adjust to the optimal temperature and mode settings depending on the outside ambient temperature. This will occur until the ignition is placed in the ON/RUN position where the climate controls will resume their previous settings.

### Manual Temperature Control (MTC) — If Equipped

- In ambient temperatures of 40 °F (4.5 °C) or below, the climate settings will default to maximum heat, with fresh air entering the cabin. If the front defrost timer expires, the vehicle will enter Mix mode.
- In ambient temperatures from 40 °F (4.5 °C) to 78 °F (26 °C), the climate settings will be based on the last settings selected by the driver.
- In ambient temperatures of 78 °F (26 °C) or above, the climate settings will default to MAX A/C, Bi-Level mode, with Recirculation on.

For more information on ATC, MTC, and climate control settings, see ↪ page 62.

### NOTE:

These features will stay on through the duration of Remote Start, or until the ignition is placed in the ON/RUN position. The climate control settings will change, and exit the automatic defaults, if manually adjusted by the driver while the vehicle is in Remote Start mode. This includes turning the climate controls off using the OFF button.

## REMOTE START WINDSHIELD WIPER DE-ICER ACTIVATION — IF EQUIPPED

When Remote Start is active and the outside ambient temperature is less than 33 °F (0.6 °C), the Windshield Wiper De-Icer will activate. Exiting Remote Start will resume its previous operation. If the Windshield Wiper De-Icer was active, the timer and operation will continue.

## REMOTE START ABORT MESSAGE — IF EQUIPPED

One of the following messages will display in the instrument cluster display if the vehicle fails to remote start or exits Remote Start prematurely:

- Remote Start Aborted — Door Open
- Remote Start Aborted — Hood Open
- Remote Start Aborted — Fuel Low
- Remote Start Aborted — Liftgate Open
- Remote Start Aborted — Too Cold
- Remote Start Aborted — Time Expired
- Remote Start Disabled — Start Vehicle To Reset

The message will stay active until the ignition is placed in the ON/RUN position.

## SCHEDULED CABIN CONDITIONING (SCC) — IF EQUIPPED (PHEV ONLY)

This feature allows the driver to pre-condition (warm up or cool down) the passenger cabin based on a planned departure time. The target temperature is preset to the same values used by the Remote Start feature. Unlike Remote Start, the driver does not need to initiate the cabin conditioning by pushing the Remote Start button, instead, a programmed departure time will be used. Also, all scheduled cabin conditioning will be powered by the vehicle's high voltage battery working in conjunction with any Electrical Vehicle Supply Equipment (EVSE) connected to the vehicle. Unlike Remote Start, in SCC the vehicle's gas engine will not start to provide power or heat for cabin conditioning.

The SCC event times are used to wake up the vehicle so that the Climate Control system can condition the passenger cabin prior to the scheduled departure time. Based on vehicle operating conditions, ambient temperature, and the next programmed departure time, the vehicle will determine when to begin cabin conditioning.

### NOTE:

If the ambient temperature is less than 40 °F (4.5 °C), the vehicle's front and rear defrosters and heated mirrors will also be activated during an Scheduled Cabin Conditioning event.

The SCC will continue for a maximum of 15 minutes after the scheduled departure time. The SCC feature can be activated a second time after the first 15 minutes of conditioning have expired. After this second activation, the vehicle's ignition must be placed in the ON/RUN position to allow future activations.

All of the following conditions must be met before the vehicle will initiate a scheduled SCC event:

- Gear selector in PARK
- Doors closed
- Hood closed
- Liftgate closed
- Hazard switch off
- 12 Volt battery at an acceptable charge level
- Key fob not located inside the vehicle
- Ignition in the OFF position
- Remote Start has not been activated
- SCC has not been activated twice in a row
- Malfunction Indicator Light is not illuminated

#### Scheduling An SCC Event:

1. Select the Hybrid Electric App on the touchscreen.
2. Select “Schedules”.



**Schedules Screen**

3. Select the schedule to be set (1,2, or 3) by pressing the appropriate arrow on the right side of the touchscreen.

4. Choose “Climate Schedule”.



**Select Climate Schedule**

5. Select if SCC should stop when the high voltage battery drops to 25% or lower.
6. Set the Departure Time: Hours, Minutes, and AM/PM.

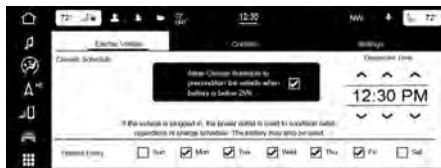

**Set Climate Schedule**

7. Select the days that this SCC event will occur. The “Repeat” indicator illuminates to indicate that SCC will occur every week on the selected day(s), at the selected time.

If you uncheck the “Repeat” option, all the days of the week will be grayed out and the vehicle will perform only one SCC event, which will occur at the next available time that matches the SCC event time (regardless of what day it was originally set to occur before “Repeat” was unchecked).

8. To schedule another SCC event, press the X and repeat these steps.

## DOORS

### MANUAL DOOR LOCKS

The front doors can be manually unlocked by pulling the inside door handle. The driver’s door can also be manually locked/unlocked by inserting the emergency key into the lock cylinder on the outside door handle.

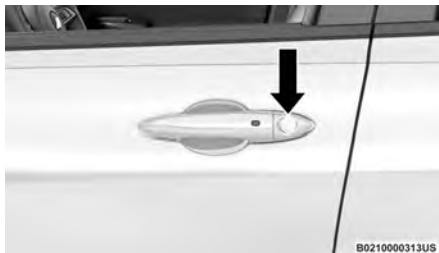

**Driver's Door Cylinder Lock**

The rear doors can be manually unlocked with a double pull of the inside door handle.

All doors except the driver’s door can be manually locked by inserting the emergency key into the emergency lock and rotating the key. The emergency lock lever is located on the door latch face of each door.

**Emergency Lock****NOTE:**

- Manually locking the vehicle will not arm the Vehicle Security system.
- The manual door locks will not lock or unlock the liftgate.

**WARNING!**

- For personal security and safety in the event of a collision, lock the vehicle doors before you drive as well as when you park and exit the vehicle.
- When exiting the vehicle, always remove the key fob from the vehicle and lock your vehicle. If equipped with a Keyless Enter 'n Go™ Ignition, always make sure the keyless ignition is in the OFF position, remove the key fob from the vehicle and lock the vehicle. Unsupervised use of vehicle equipment may cause severe personal injuries or death.

*(Continued)***WARNING!**

- Never leave children alone in a vehicle, or with access to an unlocked vehicle. Allowing children to be in a vehicle unattended is dangerous for a number of reasons. A child or others could be seriously or fatally injured. Children should be warned not to touch the parking brake, brake pedal or the gear selector.
- Do not leave the key fob in or near the vehicle, or in a location accessible to children. Do not leave the Keyless Enter 'n Go™ Ignition in the ON/RUN position. A child could operate power windows, other controls, or move the vehicle.

**POWER DOOR LOCKS**

The power door lock switches are located on each front door panel. Push the switch to lock or unlock the doors and liftgate.

**Power Door Lock Switch**

If you push the power door lock switch while the ignition is in the ON/RUN position, and any door or the liftgate is open, the power locks will not operate. This prevents you from accidentally locking the key fob in the vehicle. Placing the ignition in the OFF position or closing the doors and liftgate will allow the locks to operate.

**NOTE:**

There are lights in the driver and passenger locks that indicate when the doors are locked. If you attempt to lock the doors when a door is opened, the light on the drivers door will flash.

**KEYLESS ENTER 'N GO™ — PASSIVE ENTRY**

The Passive Entry system is an enhancement to the vehicle's Remote Keyless Entry system and a feature of Keyless Enter 'n Go™ — Passive Entry. This feature allows you to lock and unlock the vehicle's door(s) without having to push the key fob lock or unlock buttons.

**NOTE:**

- Passive Entry may be programmed on/off through Uconnect Settings ↔ page 149.
- The key fob may not detect the Passive Entry system if it is located next to a mobile phone, laptop or other electronic device; these devices may block the key fob's wireless signal and prevent the Passive Entry system from locking and unlocking the vehicle.
- If wearing gloves, if it has been raining/snowing, or there is salt/dirt covering the Passive Entry door handle, the unlock sensitivity can be affected, resulting in a slower response time.

- The doors may unlock when water is sprayed on the Passive Entry door handles, if the key fob is located outside of the vehicle within 5 ft (1.5 m) of the handle.
- If the vehicle is unlocked by Passive Entry and no door is opened within 60 seconds, the vehicle will relock and, will arm the Vehicle Security system (if equipped).

#### To Unlock From The Driver's Side Or Passenger's Side

With a valid Passive Entry key fob within 5 ft (1.5 m) of either front door handle, grab the door handle to unlock the door automatically.

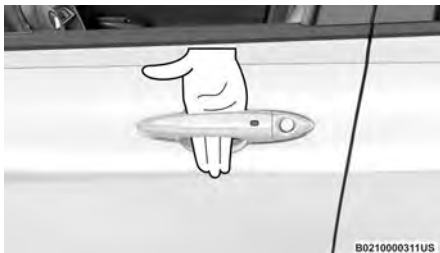

#### Grab The Door Handle To Unlock

- Either the driver door only or all doors will unlock when you grab hold of the front driver's door handle, depending on the selected setting in the Uconnect system ↪ page 149.
- All doors and the liftgate will unlock when the front passenger door handle is grabbed regardless of the driver's door unlock preference setting.

#### Frequency Operated Button Integrated Key (FOB/IK-Safe)

To minimize the possibility of unintentionally locking a Passive Entry key fob inside your vehicle, the Passive Entry system is equipped with an automatic door unlock feature which will function if the ignition switch is in the OFF position.

There are three situations that trigger a FOB/IK-Safe search in any Passive Entry vehicle:

- A lock request is made by a valid Passive Entry key fob while a door is open.
- A lock request is made by the Passive Entry door handle while a door is open.
- A lock request is made by the door panel switch while the door is open.

When any of these situations occur, after all open doors are shut, the FOB/IK-Safe search will be executed. If it detects a Passive Entry key fob inside the vehicle and it does not detect any Passive Entry key fobs outside the vehicle, then the vehicle will unlock and alert the customer.

#### NOTE:

The vehicle will only unlock the doors when a valid Passive Entry key fob is detected inside the vehicle. The vehicle will not unlock the doors when any of the following conditions are true:

- The doors are manually locked using the door lock knobs.
- Three attempts are made to lock the doors using the door panel switch and then the doors are closed.
- There is a valid Passive Entry key fob outside the vehicle and within 5 ft (1.5 m) of either Passive Entry door handle.

#### To Lock The Vehicle's Doors And Liftgate

With one of the vehicle's Passive Entry key fobs within 5 ft (1.5 m) of either front door handle, push the Passive Entry lock button located on the outside door handle to lock the vehicle doors and liftgate.



#### Push The Door Handle Button To Lock

#### NOTE:

DO NOT grab the door handle when pushing the door handle lock button. This could unlock the door(s).



#### DO NOT Grab The Door Handle When Locking

**NOTE:**

- After pushing the door handle button, you must wait two seconds before you can lock or unlock the doors, using either Passive Entry door handle. This is done to allow you to check if the vehicle is locked by pulling the door handle without the vehicle unlocking.
- If Passive Entry is disabled using the Uconnect settings, the key fob protection described in "Frequency Operated Button Integrated Key (FOB/IK-Safe)" remains active/functional.
- The Passive Entry system will not operate if the key fob battery is depleted.

**To Unlock/Enter The Liftgate**

With one of the vehicle's Passive Entry key fobs close to the liftgate, push the electronic liftgate release button to open the liftgate.



**Electronic Liftgate Handle**

- 1 — Passive Entry Button  
2 — Electronic Liftgate Release Button

**NOTE:**

- If the key fob is inadvertently forgotten inside of the cargo area, and an attempt is made to close it from outside, the liftgate will not lock. With the doors locked, the liftgate unlocked, and the key fob detected inside the vehicle, the liftgate will unlock again and the lights flash twice.
- Before driving, make sure the liftgate is closed correctly.

**To Lock The Liftgate**

With a valid Passive Entry key fob within 5 ft (1.5 m) of the liftgate, push the Passive Entry lock button located on the outside liftgate door handle.

**NOTE:**

- The liftgate Passive Entry lock button will lock all doors and the liftgate ↪ page 282.
- For additional information on how to use your liftgate, refer to ↪ page 74.

**AUTOMATIC DOOR LOCKS — IF EQUIPPED**

When enabled, the door locks will lock automatically when the vehicle's speed exceeds 12 mph (20 km/h). The auto door lock feature is enabled or disabled within the Uconnect system ↪ page 149.

**AUTOMATIC UNLOCK DOORS ON EXIT**

The doors will unlock automatically on vehicles with power door locks if:

1. The Automatic Unlock Doors On Exit feature is enabled.
2. All doors are closed.
3. The gear selector was not in PARK, then is placed in PARK.
4. Any door is opened.

**DEAD LOCK DEVICE — IF EQUIPPED**

The Dead Lock Device is a safety device that prevents the use of the internal door handles of the vehicle and the power door lock switch. This device prevents the doors from opening within the passenger compartment. The device works on all doors.

**Arming The Device**

- The device is armed after two pushes of the lock button on the key fob
- For vehicles equipped with Passive Entry, the device will also work by pushing the lock button on the driver's or passenger's side exterior door handle

The arming of the device is indicated by three flashes of the turn signals.

**NOTE:**

The device does not operate if one or more doors are not properly closed.

**Disarming The Device**

- The device will automatically disarm by pushing the unlock button on the key fob
- By placing the ignition in the ON/RUN position
- For vehicles equipped with Passive Entry, the device will also disarm by using the driver's or passenger's Passive Entry door handle to unlock and open the door

## CHILD-PROTECTION DOOR LOCK SYSTEM — REAR DOORS

To provide a safer environment for small children riding in the rear seats, the rear doors are equipped with a Child-Protection Door Lock system.

To use the system, open each rear door, use a flat-blade screwdriver (or emergency key) and rotate the dial to the lock or unlock position. When the system on a door is engaged, that door can only be opened by using the outside door handle even if the inside door lock is in the unlocked position.



**Child-Protection Door Lock Function**

### NOTE:

- When the Child-Protection Door Lock system is engaged, the door can be opened only by using the outside door handle even though the inside door lock is in the unlocked position.
- After disengaging the Child-Protection Door Lock system, always test the door from the inside to make certain it is in the desired position.

- After engaging the Child-Protection Door Lock system, always test the door from the inside to make certain it is in the desired position.
- For emergency exit with the system engaged, rotate the door lock button until the lock indicator is hidden (unlocked position), lower the window, and open the door with the outside door handle.

### WARNING!

Avoid trapping anyone in a vehicle in a collision. Remember that the rear doors can only be opened from the outside when the Child-Protection locks are engaged (locked).

### NOTE:

Always use this device when carrying children. After engaging the child lock on both rear doors, check for effective engagement by trying to open a door with the internal handle. Once the Child-Protection Door Lock system is engaged, it is impossible to open the doors from inside the vehicle. Before getting out of the vehicle, be sure to check that there is no one left inside.

## STEERING WHEEL

### TILT/TELESCOPING STEERING COLUMN

This feature allows you to tilt the steering column upward or downward. It also allows you to lengthen or shorten the steering column. The tilt/telescoping lever is located below the steering wheel at the end of the steering column.



**Tilt/Telescoping Lever**

To unlock the steering column, push the control handle downward (toward the floor). To tilt the steering column, move the steering wheel upward or downward as desired. To lengthen or shorten the steering column, pull the steering wheel outward or push it inward as desired. To lock the steering column in position, push the control handle upward until fully engaged.

### WARNING!

Do not adjust the steering column while driving. Adjusting the steering column while driving or driving with the steering column unlocked, could cause the driver to lose control of the vehicle. Failure to follow this warning may result in serious injury or death.

## HEATED STEERING WHEEL — IF EQUIPPED



The steering wheel contains a heating element that helps warm your hands in cold weather. Once the heated steering wheel has been turned on, it will stay on until the operator turns it off. The heated steering wheel may not turn on when it is already warm.



To access the heated steering wheel button, press the Comfort settings button within the Uconnect system.

- Press the heated steering wheel button once to turn the heat on.
- Press the heated steering wheel button a second time to turn the heat off.

### NOTE:

The engine must be running for the heated steering wheel to operate.

For information on use with the Remote Start system, see [➔](#) page 39.

### WARNING!

- Persons who are unable to feel pain to the skin because of advanced age, chronic illness, diabetes, spinal cord injury, medication, alcohol use, exhaustion, or other physical conditions must exercise care when using the steering wheel heater. It may cause burns even at low temperatures, especially if used for long periods.

*(Continued)*

### WARNING!

- Do not place anything on the steering wheel that insulates against heat, such as a blanket or steering wheel covers of any type or material. This may cause the steering wheel heater to overheat.

## DRIVER MEMORY SETTINGS — IF EQUIPPED

This feature allows the driver to save up to three different memory profiles for easy recall through a memory switch. Each memory profile saves desired position settings for the following features:

- Driver seat position
- A set of desired radio station presets



Memory Switches

The memory setting switch is located on the driver's door trim panel. The switch consists of three buttons (1), (2) and (3) which are used to recall either of the three saved memory profiles and to activate the memory save functions.

## PROGRAMMING THE MEMORY FEATURE

To create a new memory profile, perform the following:

### NOTE:

Vehicle must be stationary. Saving a new memory profile will erase an existing profile from memory.

1. Place the vehicle's ignition in the ON position.
2. Adjust the seat to the desired position.
3. Push the desired memory profile button (1, 2, or 3) for 1.5 seconds. A beep will sound to confirm the memory profile has been successfully stored.

## MEMORY POSITION RECALL

To recall the memory settings for driver, push briefly the desired memory button number (1, 2 or 3).

### NOTE:

- Recalling a memory setting profile can also be done about 20 minutes after the doors are opened and about 20 minutes after the engine is stopped.
- The movement of the seat is suspended if the engine is started following the recall.

## SEATS

Seats are a part of the Occupant Restraint system of the vehicle.

### WARNING!

- It is dangerous to ride in a cargo area, inside or outside of a vehicle. In a collision, people riding in these areas are more likely to be seriously injured or killed.
- Do not allow people to ride in any area of your vehicle that is not equipped with seats and seat belts. In a collision, people riding in these areas are more likely to be seriously injured or killed.
- Be sure everyone in your vehicle is in a seat and using a seat belt properly.

## MANUAL ADJUSTMENT REAR SEATS

### WARNING!

Do not pile luggage or cargo higher than the top of the seatback. This could impair visibility or become a dangerous projectile in a sudden stop or collision.

## 60/40 Split Folding Rear Seat With Fold-Flat Feature

To provide additional storage area, each rear seat can be folded flat. This allows for extended cargo space and still maintains some rear seating room.

### NOTE:

Prior to folding the rear seat, it may be necessary to position the front seat to its mid-track position. Also, be sure that the front seats are fully upright and positioned forward. This will allow the rear seat to fold down easily.

### WARNING!

- It is extremely dangerous to ride in a cargo area, inside or outside of a vehicle. In a collision, people riding in these areas are more likely to be seriously injured or killed.
- Do not allow people to ride in any area of your vehicle that is not equipped with seats and seat belts.
- Be sure everyone in your vehicle is in a seat and using a seat belt properly.

## TO LOWER THE REAR SEAT

1. Pull the seatback release lever located on either side of the upper outer edge of the seat.



Rear Seat Release Levers

2. Fold that side of the rear seatback completely forward.

## TO RAISE THE REAR SEAT

### NOTE:

If interference from the cargo area prevents the seatback from fully locking, you will have difficulty returning the seat to its proper position.

Raise the seatback and lock it into place.

The release lever will show a red indicator while in the unlocked position. Once the seat is locked in, the red indicator will no longer be visible.

### WARNING!

Be certain that the seatback is securely locked into position. If the seatback is not securely locked into position the seat will not provide the proper stability for child seats and/or passengers. An improperly latched seat could cause serious injury.

## POWER ADJUSTMENT FRONT SEATS

Some models may be equipped with a power driver's seat and/or power passenger seat. The power seat switch and power seat recliner switch are located on the outboard side of the seat near the floor. Use the power seat switch to adjust seat height, angle, or forward/rearward position. Use the power seat recline switch to adjust the angle of the seatback.





**Power Seat Switches**

- 1 – Power Seat Switch  
2 – Power Recline Switch

#### Forward Or Rearward Adjustment

The seat can be adjusted both forward and rearward. Push the seat switch forward or rearward, the seat will move in the direction of the switch. Release the switch when the desired position has been reached.

#### Height Adjustment

The height of the seats can be adjusted up or down. Pull upward or push downward on the seat switch, the seat will move in the direction of the switch. Release the switch when the desired position is reached.

#### Tilt Adjustment

The angle of the seat cushion can be adjusted up or down. Pull upward or push downward on the front of the seat switch and the front of the seat cushion will move in the direction of the switch.

### Reclining The Seatback Forward Or Rearward

The seatback can be reclined both forward and rearward. Push the seat recliner switch forward or rearward. The seatback will move in the direction of the switch. Release the switch when the desired position has been reached.

#### WARNING!

Do not ride with the seatback reclined so that the shoulder belt is no longer resting against your chest. In a collision you could slide under the seat belt, which could result in serious injury or death.

### Power Lumbar — If Equipped

Vehicles equipped with power driver or passenger seats may be equipped with power lumbar. The power lumbar switch is located on the outboard side of the power seat. Push the switch forward to increase the lumbar support. Push the switch rearward to decrease the lumbar support. Pushing upward or downward on the switch will raise and lower the position of the support.



**Power Lumbar Switch**

2

### FRONT HEATED SEATS — IF EQUIPPED

#### WARNING!

- Persons who are unable to feel pain to the skin because of advanced age, chronic illness, diabetes, spinal cord injury, medication, alcohol use, exhaustion or other physical condition must exercise care when using the seat heater. It may cause burns even at low temperatures, especially if used for long periods of time.
- Do not place anything on the seat or seatback that insulates against heat, such as a blanket or cushion. This may cause the seat heater to overheat. Sitting in a seat that has been overheated could cause serious burns due to the increased surface temperature of the seat.



The front heated seats control buttons are located within the Uconnect system. You can gain access to the control buttons through the climate or controls screen.

- Press the heated seat button once to turn the HI setting on.
- Press the heated seat button a second time to turn the MED setting on.
- Press the heated seat button a third time to turn the LO setting on.
- Press the heated seat button a fourth time to turn the heating elements off.

If the HI level setting is selected, the system will automatically switch to a lower level after approximately 15 minutes (depending on environmental conditions) of continuous operation. The heated seat feature will then turn off automatically approximately 45 minutes after switching to a lower level.

#### NOTE:

The engine must be running for the heated seats to operate.

For information on use with the Remote Start system, see page 39.

## FRONT VENTILATED SEATS — IF EQUIPPED



Located in the seat cushion and seat back are fans that draw the air from the passenger compartment and move air through fine perforations in the seat cover to help keep the driver and front passenger cooler in higher ambient temperatures. The fans operate at three speeds: HI, MED, and LO.

The front ventilated seats control buttons are located within the Uconnect system. You can gain access to the control buttons through the climate screen or the controls screen.

- Press the ventilated seat button once to choose HI.
- Press the ventilated seat button a second time to choose MED.
- Press the ventilated seat button a third time to choose LO.
- Press the ventilated seat button a fourth time to turn the ventilated seat off.

#### NOTE:

The engine must be running for the ventilated seats to operate.

For information on use with the Remote Start system, see page 39.

## REAR SEAT ARMREST — IF EQUIPPED

The center part of the rear seat can also be used as a rear armrest with cup holders, pull the rear armrest strap to release it from the seat and pull forward.

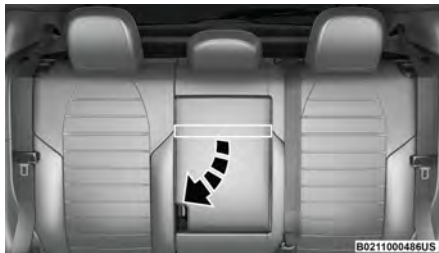

**Pull Rear Armrest Strap**

#### WARNING!

Be certain that the seatback is securely locked into position. If the seatback is not securely locked into position the seat will not provide the proper stability for child seats and/or passengers. An improperly latched seat could cause serious injury.

## HEAD RESTRAINTS

Head restraints are designed to reduce the risk of injury by restricting head movement in the event of a rear impact. Head restraints should be adjusted so that the top of the head restraint is located above the top of your ear.

### WARNING!

- All occupants, including the driver, should not operate a vehicle or sit in a vehicle's seat until the head restraints are placed in their proper positions in order to minimize the risk of neck injury in the event of a crash.
- Head restraints should never be adjusted while the vehicle is in motion. Driving a vehicle with the head restraints improperly adjusted or removed could cause serious injury or death in the event of a collision.

### NOTE:

Do not reverse the head restraints (making the rear of the head restraint face forward) in an attempt to gain additional clearance to the back of your head.

### Front Head Restraint Adjustment

Your vehicle is equipped with front two-way driver and passenger head restraints.

To raise the head restraint, pull upward on the head restraint. To lower the head restraint, push the adjustment button, located at the base of the head restraint, and push downward on the head restraint.



Head Restraint Adjustment

- 1 – Release Button  
2 – Adjustment Button

### WARNING!

- All occupants, including the driver, should not operate a vehicle or sit in a vehicle's seat until the head restraints are placed in their proper positions in order to minimize the risk of neck injury in the event of a crash.
- Head restraints should never be adjusted while the vehicle is in motion. Driving a vehicle with the head restraints improperly adjusted or removed could cause serious injury or death in the event of a collision.

## Rear Head Restraint Adjustment

The rear outboard head restraints can be adjusted up or down.

To raise the outboard head restraint, pull upward on the head restraint. To lower the head restraint, push the adjustment button, located at the base of the head restraint, and push downward on the head restraint.

2



Outboard Head Restraint Adjustment Button

### WARNING!

ALL the head restraints MUST be reinstalled in the vehicle to properly protect the occupants.

## Head Restraint Removal

To remove the front head restraints, proceed as follows:

1. Raise the head restraint to its maximum height.
2. Push the adjustment button and the release button at the side of the two supports at the same time.
3. Pull upward on the head restraint to fully remove it.

To reinstall the head restraints, proceed as follows:

1. Hold down both the adjustment button and release button while placing the head restraint posts into the holes.
2. Then, reposition the head restraint to the appropriate height for the passengers.
3. Replace the seatback to the appropriate position for passengers.

#### NOTE:

- The rear outboard head restraints may be removed by inserting a pointed object such as a pen into the release button location. Follow the preceding front head restraints instructions for removal steps.
- The rear center head restraint is fixed, and is not adjustable or removable.

#### WARNING!

- A loose head restraint thrown forward in a collision or hard stop could cause serious injury or death to occupants of the vehicle. Always securely stow removed head restraints in a location outside the occupant compartment.
- ALL the head restraints MUST be reinstalled in the vehicle to properly protect the occupants. Follow the preceding reinstallation instructions prior to operating the vehicle or occupying a seat.

## UCONNECT VOICE RECOGNITION QUICK TIPS — IF EQUIPPED

### INTRODUCING VOICE RECOGNITION

Start using Uconnect Voice Recognition with these helpful quick tips. It provides the key Voice Commands and tips you need to know to control your vehicle's Voice Recognition (VR) system.

### BASIC VOICE COMMANDS

The following Voice Commands can be given at any point while using your Uconnect system.

Push the Voice Recognition (VR) button. You can also say the Wake Up word "Hey, Alfa", "Hey, Alfa Romeo", or Hey, Uconnect". After the beep, say:

- "**Cancel**" to stop a current voice session.
- "**Help**" to hear a list of suggested Voice Commands.
- "**Repeat**" to listen to the system prompts again.

Notice the visual cues that inform you of your Voice Recognition system's status.

### GET STARTED

The VR button is used to activate/deactivate your Voice Recognition system. You can also use the system's "Wake Up" word to activate voice recognition. The Wake Up word can be set through the Uconnect Settings [↪ page 149](#).

Helpful hints for using Voice Recognition:

- Reduce background noise. Wind noise and passenger conversations are examples of noise that may impact recognition.

- Speak clearly at a normal pace and volume while facing straight ahead.
- Each time you give a Voice Command, first push the VR button or say the Wake Up word, wait until after the beep, then say your Voice Command.
- You can interrupt the help message or system prompts by pushing the VR button and saying a Voice Command from the current category.
- You can also interrupt the help message or system prompts by speaking. This feature is called "barge-in" and can be set through the Uconnect Settings [↪ page 149](#).



**Uconnect Voice Command Buttons**

1 — For Vehicles Equipped With Navigation: Push The Voice Recognition Button To Begin Radio, Media, Navigation, Climate, Start Or Answer A Phone Call, And Send Or Receive A Text

1 — For Vehicles Not Equipped With Navigation: Push The Phone Button To Answer An Incoming Phone Call

## ADDITIONAL INFORMATION

© 2023 FCA US LLC. All rights reserved. Mopar and Uconnect are registered trademarks and Mopar Owner Connect is a trademark of FCA US LLC. SiriusXM® and all related marks and logos are trademarks of SiriusXM® Radio Inc. ↩ page 282.

For Uconnect system support, call 1-877-855-8400 (24 hours a day 7 days a week) or visit DriveUconnect.com (US) or DriveUconnect.ca (Canada).

## MIRRORS

### INSIDE REARVIEW MIRROR

#### Automatic Dimming Mirror

This mirror automatically adjusts for headlight glare from vehicles behind you.

The rearview mirror can be adjusted left and right, or tilted up and down. The mirror should be adjusted to center on the view through the rear window.

#### NOTE:

The Automatic Dimming Mirror feature is disabled when the vehicle is in REVERSE to improve the driver's rear view.



B0215000194US

**Automatic Dimming Mirror**

#### CAUTION!

To avoid damage to the mirror during cleaning, never spray any cleaning solution directly onto the mirror. Apply the solution onto a clean cloth and wipe the mirror clean.

### ILLUMINATED VANITY MIRRORS

To access an illuminated vanity mirror, flip down one of the visors and lift the mirror cover.



B0215000192US

**Lift Illuminated Vanity Mirror Cover**

#### Sun Visor Slide-On-Rod Feature — If Equipped

The sun visor Slide-On-Rod feature allows for additional flexibility in positioning the sun visor to block out the sun.

1. Fold down the sun visor.
2. Unclip the visor from the center clip.
3. Pivot the sun visor toward the side window.
4. Extend the sun visor for additional sun blockage.

#### NOTE:

The sun visor can also be extended while the sun visor is against the windshield for additional sun blockage through the front of the vehicle.

### OUTSIDE MIRRORS

The outside mirror(s) can be adjusted to the center of the adjacent lane of traffic to achieve the optimal view.

#### NOTE:

The passenger side convex outside mirror will give a much wider view to the rear, and especially of the lane next to your vehicle.

#### WARNING!

Vehicles and other objects seen in the passenger side convex mirror will look smaller and farther away than they really are. Relying too much on your passenger side convex mirror could cause you to collide with another vehicle or other object. Use your inside mirror when judging the size or distance of a vehicle seen in the passenger side convex mirror.

### OUTSIDE AUTOMATIC DIMMING MIRRORS — IF EQUIPPED

The driver's outside mirror and if equipped, the passenger's outside mirror, will automatically dim for glare from vehicles behind you. This feature is controlled by the inside automatic dimming mirror. The mirrors will automatically adjust for headlight glare when the inside mirror adjusts.

## POWER ADJUSTMENT MIRRORS

The power mirror control switch is located on the driver's side door trim panel.

To adjust a mirror, rotate the mirror selection switch to the left or to the right, and then push the mirror adjustment switch in any of the four directions.



**Power Mirror Switch**

- 1 — Mirror Selector Switch
- 2 — Mirror Adjustment Switch
- 3 — Power Folding Position (If Equipped)

### NOTE:

- To adjust the power mirrors, the ignition must be in the ON/RUN position.
- Once adjustment is complete, rotate the knob to the neutral position to prevent accidental movements.
- The power mirror switches will remain active for up to three minutes after the ignition is placed in the OFF position. Opening either front door will cancel this feature.

### Power Folding — If Equipped

To fold the outside mirrors in, push the power folding mirror switch. Push the switch a second time to unfold the mirrors to the driving position. Any push of the power folding mirror switch will reverse the operation.

If the power mirror control switch is moved again during door mirror folding (from closed to open position and vice versa), the movement direction is reversed.

### Automatic Power Folding — If Equipped

The outside mirrors may be equipped with an automatic folding feature, designed to help in narrow parking situations or in tight spaces. When pulling into a narrow space, the mirrors will fold-in automatically. The mirrors will automatically unfold when exiting the narrow space.

### NOTE:

- If the power fold mirror button is pressed, it must be pressed again to unfold the mirror.
- The outside mirrors must always be in the unfolded position when the vehicle is in motion, except when driving through narrow locations.

## FOLDING MIRRORS

The exterior mirrors are hinged to allow the mirror to pivot forward or rearward to help avoid damage. The mirror has two detent positions: normal and full rearward.



**Folding Mirror**



**Folding Mirror Positions**

- 1 — Full Rearward Position
- 2 — Normal Driving Position

## HEATED MIRRORS — IF EQUIPPED



These mirrors are heated to melt frost or ice. This feature will be activated whenever you turn on the rear window defroster (if equipped) ↪ page 62.

## UNIVERSAL GARAGE DOOR OPENER (HOMELINK®) — IF EQUIPPED



HomeLink® Buttons On Sun Visor

Use this QR code to access your digital experience.



- HomeLink® replaces up to three hand-held transmitters that operate devices such as garage door openers, motorized gates, lighting, or home security systems. The HomeLink® unit is powered by your vehicle's 12 Volt battery.
- The HomeLink® buttons that are located in the overhead console or sun visor designate the three different HomeLink® channels.
- To operate HomeLink®, push and release any of the programmed HomeLink® buttons. These buttons will activate the devices they are programmed to with each press of the corresponding HomeLink® button.
- The HomeLink® indicator light is located above the center button.

### NOTE:

HomeLink® is disabled when the Vehicle Security system is active ↪ page 282.

## BEFORE YOU BEGIN PROGRAMMING HOMELINK®

For efficient programming and accurate transmission of the Radio Frequency (RF) signal, it is recommended that a new battery be placed in the hand-held transmitter of the device that is being programmed to the HomeLink® system. Make sure your hand-held transmitter is programmed to activate the device you are trying to program your HomeLink® button to.

Ensure that your vehicle is parked outside of the garage before you begin programming.

It is recommended that you erase all the channels of your HomeLink® before you use it for the first time.

## ERASING ALL THE HOMELINK® CHANNELS

To erase the channels, follow this procedure:

1. Place the ignition switch in the ON/RUN position.
2. Push and hold the two outside HomeLink® buttons (I and III) for up to 20 seconds, or until the HomeLink® indicator light flashes.

### NOTE:

Erasing all channels should only be performed when programming HomeLink® for the first time. Do not erase channels when programming additional buttons.

## IDENTIFYING WHETHER YOU HAVE A ROLLING CODE OR NON-ROLLING CODE DEVICE

Before programming a device to one of your HomeLink® buttons, you must determine whether the device has a rolling code or non-rolling code.

### Rolling Code Devices

To determine if your device has a rolling code, a good indicator is its manufacturing date. Typically, devices manufactured after 1995 have rolling codes. A device with a rolling code will also have a "LEARN" or "TRAIN" button located where the antenna is attached to the device. The button may not be immediately visible when looking at the device. The name and color of the button may vary slightly by manufacturer.

**NOTE:**

The “LEARN” or “TRAIN” button is not the button you normally use to operate the device.

**Non-rolling Code Devices**

Most devices manufactured before 1995 will not have a rolling code. These devices will also not have a “LEARN” or “TRAIN” button.

## PROGRAMMING HOMELINK® TO A GARAGE DOOR OPENER

To program any of the HomeLink® buttons to activate your garage door opener motor, proceed as follows:

**NOTE:**

All HomeLink® buttons are programmed using this procedure. You do not need to erase all channels when programming additional buttons.

1. Place the ignition switch in the ON/RUN position.
2. Place the garage door opener transmitter 1 to 3 inches (3 to 8 cm) away from the HomeLink® button you wish to program, while keeping the HomeLink® indicator light in view.
3. Push and hold the HomeLink® button you want to program while you push and hold the garage door opener transmitter button you are trying to replicate.
4. Continue to hold both buttons and observe the HomeLink® indicator light. The HomeLink® indicator light will flash slowly and then rapidly. Once this happens, release both buttons.

**NOTE:**

Make sure the garage door opener motor is plugged in before moving on to the rolling code/non-rolling code final steps.

**Rolling Code Garage Door Opener Final Steps****NOTE:**

You have 30 seconds in which to initiate rolling code final step 2, after completing rolling code final step 1.

1. At the garage door opener motor (in the garage), locate the “LEARN” or “TRAIN” button. This can usually be found where the hanging antenna wire is attached to the garage door opener motor. Firmly push and release the “LEARN” or “TRAIN” button.
2. Return to the vehicle and push the programmed HomeLink® button three times (holding the button for two seconds each time). If the garage door opener motor operates, programming is complete.
3. Push the programmed HomeLink® button to confirm that the garage door opener motor operates. If the garage door opener motor does not operate, repeat the final steps for the rolling code procedure.

**Non-Rolling Code Garage Door Opener Final Steps**

1. Push and hold the programmed HomeLink® button and observe the HomeLink® indicator light. If the HomeLink® indicator light stays on constantly, programming is complete.
2. Push the programmed HomeLink® button to confirm that the garage door opener motor operates. If the garage door opener motor does not operate, repeat the steps from the beginning.

**WARNING!**

- Your motorized door or gate will open and close while you are programming the universal transmitter. Do not program the transmitter if people or pets are in the path of the door or gate.
- Do not run your vehicle in a closed garage or confined area while programming the transmitter. Exhaust gas from your vehicle contains carbon monoxide (CO) which is odorless and colorless. Carbon monoxide is poisonous when inhaled and can cause you and others to be severely injured or killed.

## PROGRAMMING HOMELINK® TO A MISCELLANEOUS DEVICE

The procedure on how to program HomeLink® to a miscellaneous device follows the same procedure as programming to a garage door opener ↪ page 149. Be sure to determine if the device has a rolling code, or non-rolling code before beginning the programming process.

**NOTE:**

Canadian Radio Frequency (RF) laws require transmitter signals to time-out (or quit) after several seconds of transmission, which may not be long enough for HomeLink® to pick up the signal during programming. Similar to this Canadian law, some U.S. gate operators are designed to time-out in the same manner. The procedure may need to be performed multiple times to successfully pair the device to your HomeLink® buttons.



## REPROGRAMMING A SINGLE HOMELINK® BUTTON

To reprogram a single HomeLink® button that has been previously trained, without erasing all the channels, proceed as follows. Be sure to determine whether the new device you want to program the HomeLink® button to has a rolling code, or non-rolling code.

1. Place the ignition in the ON/RUN position, without starting the engine.
2. Push and hold the desired HomeLink® button until the HomeLink® indicator light begins to flash after 20 seconds. **Do not release the button.**
3. **Without releasing the button**, proceed with Step 2 in "Programming HomeLink® To A Garage Door Opener" and follow all remaining steps.

## CANADIAN/GATE OPERATOR PROGRAMMING

For programming transmitters in Canada/United States that require the transmitter signals to "time-out" after several seconds of transmission:

Canadian Radio Frequency (RF) laws require transmitter signals to time-out (or quit) after several seconds of transmission, which may not be long enough for HomeLink® to pick up the signal during programming. Similar to this Canadian law, some U.S. gate operators are designed to time-out in the same manner.

It may be helpful to unplug the device during the cycling process to prevent possible overheating of the garage door or gate motor.

1. Place the ignition in the ON/RUN position.

### NOTE:

For vehicles equipped with Keyless Enter 'n Go™, place the ignition in the RUN position. Make sure while programming HomeLink® with the engine on that your vehicle is outside of your garage, or that the garage door remains open at all times.

2. Place the hand-held transmitter 1 to 3 inches (3 to 8 cm) away from the HomeLink® button you wish to program while keeping the HomeLink® indicator light in view.
3. Continue to push and hold the HomeLink® button while you push and release (cycle) your hand-held transmitter every two seconds until HomeLink® has successfully accepted the frequency signal. The indicator light will flash slowly and then rapidly when fully trained.
4. Watch for the HomeLink® indicator to change flash rates. When it changes, it is programmed. It may take up to 30 seconds or longer in rare cases. The garage door may open and close while you are programming.
5. Push and hold the programmed HomeLink® button and observe the indicator light.

### NOTE:

- If the indicator light stays on constantly, programming is complete and the garage door/device should activate when the HomeLink® button is pushed.
- To program the two remaining HomeLink® buttons, repeat each step for each remaining button. **DO NOT** erase the channels.

If you unplugged the garage door opener/device for programming, plug it back in at this time.

### Reprogramming A Single HomeLink® Button (Canadian/Gate Operator)

To reprogram a channel that has been previously trained, follow these steps:

1. Place the ignition in the ON/RUN position.
2. Press and hold the desired HomeLink® button until the indicator light begins to flash after 20 seconds. Do not release the button.
3. Without releasing the button, proceed with "Canadian/Gate Operator Programming" Step 2 and follow all remaining steps.

## SECURITY

It is advised to erase all channels before you sell or turn in your vehicle.

To do this, push and hold the two outside buttons for 20 seconds until the indicator flashes. Note that all channels will be erased. Individual channels cannot be erased.

The HomeLink® universal transmitter is disabled when the Vehicle Security system is active.

## TROUBLESHOOTING TIPS

If you are having trouble programming HomeLink®, here are some of the most common solutions:

- Replace the battery in the garage door opener hand-held transmitter.
- Push the LEARN button on the garage door opener to complete the training for a rolling code.
- Did you unplug the device for programming and remember to plug it back in?

If you have any problems, or require assistance, please call toll-free 1-800-355-3515 or on the Internet at HomeLink.com for information or assistance.

### WARNING!

- Vehicle exhaust contains carbon monoxide, a dangerous gas. Do not run your vehicle in the garage while programming the transmitter. Exhaust gas can cause serious injury or death.
- Your motorized door or gate will open and close while you are programming the universal transmitter. Do not program the transmitter if people, pets or other objects are in the path of the door or gate. Only use this transmitter with a garage door opener that has a “stop and reverse” feature as required by Federal safety standards. This includes most garage door opener models manufactured after 1982. Do not use a garage door opener without these safety features.

## EXTERIOR LIGHTS

### MULTIFUNCTION LEVER



B0216000280US

**Multifunction Lever**

The multifunction lever controls the operation of the turn signals, headlight beam selection and passing lights. The multifunction lever is located on the left side of the steering column.

### HEADLIGHT SWITCH

The headlight switch is located on the left side of the instrument panel. This switch controls the operation of the headlights, parking lights, automatic headlights (if equipped), fog lights, instrument panel lights, and interior lights.

#### NOTE:

**For PHEV Models:** The fuel door release button is located to the left of the headlight control.



B0216000312US

**Headlight Switch**

- 1 — Rotate Headlight Control
- 2 — Rear Fog Light Button
- 3 — Instrument Panel Dimmer Control

To turn on the headlights, rotate the headlight switch clockwise. When the headlight switch is on, the parking lights, taillights, license plate light and instrument panel lights are also turned on.

The headlight switch is equipped with a momentary 0 (off) detent. When the vehicle is at a standstill and the headlight switch is held in the 0 (off) position, the Day-time Running Lights (DRLs) will turn on. As soon as the vehicle starts to move, the 0 (off) position is disabled and the DRLs may turn off and low beam headlights may automatically turn on based on exterior ambient light levels.

From the 0 (off) position, rotate the headlight switch clockwise to the first detent for automatic headlights, the second detent for parking lights and instrument panel lights operation, or to the third detent for headlights, parking lights, and instrument panel lights operation.

## DAYTIME RUNNING LIGHTS (DRLS) — IF EQUIPPED

The Daytime Running Lights (DRLs) (low intensity) come on automatically whenever the ignition is placed in the ON/RUN position, and the headlight switch is turned to the AUTO position, and the dusk sensor detects sufficient external light.

### NOTE:

- For vehicles sold in Canada, the Daytime Running Lights will automatically deactivate when the front fog lights are turned on.
- On some vehicles, the Daytime Running Lights may deactivate, or reduce intensity, on one side of the vehicle (when a turn signal is activated on that side), or on both sides of the vehicle (when the hazard warning lights are activated).

## HIGH/LOW BEAM SWITCH

Push the multifunction lever towards the instrument panel to switch the headlights to high beams. The headlight switch must first be turned to the AUTO or on position.

The high beam indicator will illuminate in the instrument cluster when the high beams are active.

Push the lever forward again to return to low beam headlights.

## AUTOMATIC HIGH BEAM HEADLIGHTS — IF EQUIPPED

The Automatic High Beam Headlight system provides increased forward lighting at night by automating high beam control through the use of a digital camera mounted on the windshield. This camera detects vehicle specific light and automatically switches from high beams to low beams until the approaching vehicle is out of view.

To activate the Automatic High Beam Headlights, proceed as follows:

1. Within the Uconnect system, set "Auto Dim High Beams" to "ON".
2. Place the headlight switch in the AUTO position.
3. Push the multifunction lever forward to activate the high beams.

### NOTE:

Broken, muddy, or obstructed headlights and taillights of vehicles in the field of view will cause headlights to remain on longer (closer to the vehicle). Also, dirt, film, and other obstructions on the windshield or camera lens will cause the system to function improperly.

## FLASH-TO-PASS

You can signal another vehicle with your headlights by lightly pulling the multifunction lever toward you. This will cause the high beam headlights to turn on, and remain on, until the lever is released.

## AUTOMATIC HEADLIGHTS — IF EQUIPPED



This system automatically turns the headlights on or off according to ambient light levels. To turn the system on, rotate the headlight switch clockwise to the AUTO position.

When the system is on, the headlight time delay feature is also on. This means the headlights will stay on for up to 90 seconds after you place the ignition into the OFF position. To turn the automatic system off, move the headlight switch out of the AUTO position.

### NOTE:

The engine must be running before the headlights will come on in the automatic mode.

## HEADLIGHTS ON AUTOMATICALLY WITH WIPERS — IF EQUIPPED

If your vehicle is equipped with Automatic Headlights, it also has this customer-programmable feature. When your headlights are in the automatic mode and the engine is running, they will automatically turn on when the wiper system is on. This feature is programmable through the Uconnect system.

### NOTE:

When your headlights come on during the daytime, the vehicle will monitor outside brightness and decide if the instrument panel needs to be dimmed.

## HEADLIGHT DELAY

To aid in your exit, your vehicle is equipped with a headlight delay that will leave the headlights on for approximately 90 seconds. This delay is initiated when the ignition is placed in the OFF position while the headlight switch is on, and then the headlight switch is cycled off. Headlight delay can be canceled by either turning the headlight switch on then off, or by placing the ignition in the ON/RUN position.

### NOTE:

The headlight delay time is programmable through Uconnect Settings ➔ page 149.

## LIGHTS-ON REMINDER

If the headlights or parking lights are on after the ignition is in the OFF position, a chime will sound to alert the driver when the driver's door is opened.

## REAR FOG LIGHTS — IF EQUIPPED

To activate the rear fog lights, turn on the parking lights or the low beam headlights, and push the fog light button on the headlight switch.



**Fog Light Button**

The fog lights will operate only when the parking lights are on, or when the vehicle headlights are on low beam. An indicator light located in the instrument cluster display will illuminate when the fog lights are on. The fog lights will turn off when the button is pushed a second time, when the headlight switch is rotated to the off position, or the high beam is selected.

## CORNERING LIGHTS — IF EQUIPPED

The cornering lights are a feature to improve visibility at night while turning the vehicle. When activated, a light incorporated in the headlight assembly will illuminate on the side of the vehicle the steering wheel is rotated, or that the turn signal indicator is on. It can be activated through the Uconnect system ➔ page 149.

## TURN SIGNALS

Move the multifunction lever up or down to activate the turn signals. The arrows on each side of the instrument cluster display flash to show proper operation.

Once the turn signal lever is activated, it will return to its original position. To cancel the turn signal action, the lever must be moved again or the turn in that direction must be completed.

### NOTE:

If either light remains on and does not flash, or there is a very fast flash rate, check for a defective outside light bulb.

## LANE CHANGE ASSIST

Lightly push the multifunction lever up or down, without moving beyond the detent, and the turn signal will flash three times then automatically turn off.

To turn off the flashing before the end of the cycle, move the lever in the opposite direction until the first click (about half way).

## BATTERY SAVER FEATURE

To protect the battery, if the headlight switch is left in the low beam or parking lights position when the ignition is placed in the OFF position, the lights are deactivated after eight minutes. The lights can also be turned off manually by rotating the headlight switch to the 0 (off) position.

## INTERIOR LIGHTS

### INTERIOR COURTESY LIGHTS

Courtesy and dome lights are turned on when the front doors are opened.

To protect the battery, the interior lights will turn off automatically 15 minutes after the ignition is placed in the OFF position, and no other activity in the vehicle has occurred. This will occur if the interior lights were turned on manually or are on because a door is open. This includes the glove compartment light and the cargo area light. To restore interior light operation, either place the ignition in the ON/RUN position, or push the light switch on and then back off.

### Front Map Reading Lights

The front map/reading and overhead lights are mounted in the overhead console. Each light can be turned on by pushing the corresponding switch on the console. These switches are backlit for nighttime visibility. To turn the lights off, push the switch a second time.



Overhead Console

- 1 — Reading/Map Light Switch
- 2 — Rear Overhead Lights Switch
- 3 — Overhead Lights Switch
- 4 — Overhead Lights On/Off When Doors Open

#### NOTE:

Before exiting the vehicle, ensure that the overhead lights are off. This will prevent the battery from discharging once the doors are closed. If a light is left on accidentally, the overhead lights will turn off automatically approximately 15 minutes after the ignition has been placed in the OFF position.

#### Overhead Light Timing

On certain models, to assist getting in and out of the vehicle at night or in poorly-lit areas, two timed modes have been provided.

#### Timing While Getting Into The Vehicle

The overhead lights turn on according to the following modes:

- Will illuminate for approximately three minutes when the doors are unlocked.
- Will illuminate for approximately three minutes when one of the doors is opened.
- Will illuminate for approximately 27 seconds when each individual door is closed and switch off simultaneously when the doors are locked.

Timing is interrupted when the ignition is placed in the ON/RUN position.

#### Three Modes Are Available For Turning Off Overhead Lighting:

- When all doors are closed after entering the vehicle, the three-minute timer will stop and a seconds timer will start for the interior lights. This timing will stop when the ignition is placed in the ON/RUN position.
- When doors are locked (either with key fob or with the emergency key inserted in driver side door), the overhead light turns off.
- The interior lights will turn off after 15 minutes to preserve the battery.

#### Timing While Getting Out Of The Vehicle

After placing the ignition in the OFF position, the overhead lights will turn on as follows:

- For a few seconds after the engine stops.
- For approximately three minutes when one of the doors is opened.
- For several seconds when the last door is closed.

The timing stops automatically when the doors are locked.

## Rear Overhead Light

The rear overhead lights are activated or deactivated by on/off switches located on the front overhead console or within the rear overhead lights themselves.



**Rear Overhead Light On/Off Switches**

The light turns on when a door is opened.

### NOTE:

The light will turn off automatically after a few minutes if a door is left open. To turn it on again, open another door or close and reopen the same door.

## Instrument Panel Dimmer Control

The instrument panel dimmer control is part of the headlight switch and is located on the driver's side of the instrument panel.

Rotating the instrument panel dimmer up or down will adjust the brightness of the instrument panel lights if the built-in light sensor determines that the ambient light levels are low enough that the backlighting should be enabled.



**Instrument Panel Dimmer**

## Interior Ambient Lighting — If Equipped

The brightness of the interior passenger compartment lights can be adjusted through Uconnect Settings [↪ page 149](#).

The lights can be adjusted to six different levels of brightness.

## Battery Saver Feature

To protect the battery, the interior lights will turn off automatically 15 minutes after the ignition switch is placed in the OFF position. This will occur if the interior lights were switched on manually or are on because a door is open.

## WINDSHIELD WIPERS AND WASHERS

The windshield wiper/washer controls are located on the windshield wiper/washer lever on the right side of the steering column. The front wipers are operated by rotating a switch, located on the end of the lever. For information on the rear wiper/washer, see [↪ page 62](#).

## WINDSHIELD WIPER OPERATION

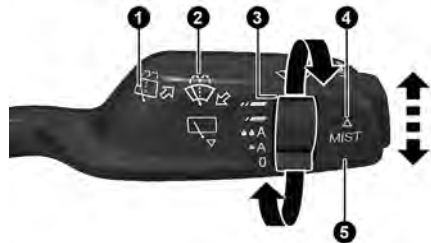

**Windshield Wiper Operation**

- 1 — Push Forward For Rear Washer
- 2 — Pull For Front Washer
- 3 — Rotate Switch For Front Wiper Operation
- 4 — Push Up for Mist Feature
- 5 — Pull Lever Downward For Rear Wiper Operation

**NOTE:**

Your vehicle may also be equipped with a Menu View button at the end of your Windshield Wiper Stalk, for more information see ⇨ page 80



Rotating the switch to the Low Continuous Wiper Speed position activates the first (low) level continuous speed of the windshield wipers in manual mode.



Rotating the switch to the High Continuous Wiper Speed position activates the second (high) level continuous speed of the windshield wipers in manual mode.



Rotating the switch to the O (off) position turns the windshield wipers off.

**Rain Sensor Sensitivity Level**

Rotating the switch to the Low Sensitivity Rain Sensing position, activates the first, less sensitive level of the Rain Sensing function.



Rotating the switch to the High Sensitivity Rain Sensing position, activates the second, more sensitive level of the Rain Sensing function ⇨ page 61.

**Windshield Washer**

To use the washer, pull the windshield wiper lever toward the steering wheel and hold.

Both the windshield washer jet and the windshield wipers will be activated. The wipers and washer will continue to operate until you let go of the lever.

The windshield wipers stop working three strokes after the stalk is released, followed by a final stroke six seconds later to complete the cycle.

**Mist**

Push the lever upward to the MIST position and release for a single wiping cycle.

**NOTE:**

The Mist feature does not activate the washer pump; therefore, no washer fluid will be sprayed on the windshield. The washer function must be used in order to spray the windshield with washer fluid.

For information on wiper care and replacement, see ⇨ page 238.

**WARNING!**

Sudden loss of visibility through the windshield could lead to a collision. You might not see other vehicles or other obstacles. To avoid sudden icing of the windshield during freezing weather, warm the windshield with the defroster before and during windshield washer use.

**CAUTION!**

Always remove any buildup of snow that prevents the windshield wiper blades from returning to the parked position. If the windshield wiper switch is turned off, and the blades cannot return to the parked position, damage to the wiper motor may occur.

**RAIN SENSING WIPERS — IF EQUIPPED**

This feature senses rain or snowfall on the windshield and automatically activates the wipers. The Rain Sensor is located behind the interior rearview mirror.

**Rain Sensor**

The sensor has an adjustment range that varies progressively from wiper still (no stroke) when the windshield is dry, to wiper at continuous speed (fast operation) with intense rain.

**Activation**

1. Rotate the wiper switch to the Low Sensitivity Rain Sensing position or High Sensitivity Rain Sensing position.
  2. Tap the wiper stalk upwards.
- The variation in sensitivity during rain sensor operation is signaled by a stroke of the wiper.

If the windshield washer is used with the rain sensor activated, the normal washing cycle is performed, and then the rain sensor resumes its normal automatic operation.

**NOTE:**

Keep the glass in the sensor area clean.

**Deactivation**

To turn off the Rain Sensing Wipers, use the wiper switch or place the ignition in the OFF position.

In the event of malfunction of the rain sensor while it is active, the windshield wiper operates intermittently at a speed consistent with the sensitivity setting of the rain sensor, whether or not there is rain on the glass for as long as the sensor failure is indicated on the display.

The sensor continues to operate and it is possible to set the windshield wiper to continuous mode (low or high). The failure indication remains on for as long as the sensor is active.

The rain sensor is able to recognize and automatically adjust itself when the following conditions occur:

- Presence of dirt on the controlled surface (e.g., salt, dirt, etc.).
- Presence of streaks of water caused by the worn window wiper blades.
- Difference between day and night.

**REAR WINDOW WIPER/WASHER**

Shifting the vehicle into REVERSE with the windshield wiper operating activates a single cycle of the rear window wiper.

Push the windshield wiper lever downward (with the vehicle in REVERSE) to activate/deactivate continuous rear wiper operation.

Push the windshield wiper lever downward (without the vehicle in REVERSE) to activate/deactivate intermittent rear wiper operation.

Push the windshield wiper lever towards the instrument panel to activate the rear window washer (a brief push activates one washing cycle, while keeping the stalk pushed washes continuously until the stalk is released).

**NOTE:**

Make sure the rear wiper is turned off when cleaning the windshield glass.

**CLIMATE CONTROLS**

The Climate Control system allows you to regulate the temperature, air flow, and direction of air circulating throughout the vehicle. The controls are located on the touchscreen and on the instrument panel below the radio.

**AUTOMATIC CLIMATE CONTROL DESCRIPTIONS AND FUNCTIONS**

**Uconnect 5 NAV With 10.25-Inch Display Automatic Climate Controls**



**Instrument Panel Center Stack Climate Controls**

**MAX A/C Button**

Press and release the MAX A/C button on the touchscreen to change the current setting to the coldest output of air. The MAX A/C indicator illuminates when MAX A/C is on.

Pressing the button again will cause the MAX A/C operation to exit. Pressing other settings will cause the MAX A/C to exit.

**NOTE:**

The MAX A/C button is only available on the touchscreen.

**A/C Button**

Press and release the A/C button on the touchscreen, or push the button on the faceplate to change the current setting. The A/C indicator illuminates when A/C is ON.

The Air Conditioning (A/C) button allows the operator to manually activate or deactivate the air conditioning system. When the air conditioning system is turned on, dehumidified air will flow through the outlets into the cabin.



If your air conditioning performance seems lower than expected, check the front of the A/C condenser (located in front of the radiator), for an accumulation of dirt or insects. Clean with a gentle water spray from the front of the radiator and through the condenser. If the problem persists, please contact an authorized dealer.

## Recirculation Button



Press and release this button on the touchscreen, or push the button on the faceplate, to change the system between automatic, recirculation, and outside air modes. Recirculation can be used when outside conditions such as smoke, odors, dust, or high humidity are present. Recirculation can be used in all modes. Recirculation may be unavailable (button on the touchscreen grayed out) if conditions exist that could create fogging on the inside of the windshield. The A/C can be deselected manually without disturbing the mode control selection. Continuous use of the Recirculation mode may make the inside air stuffy and window fogging may occur. Extended use of this mode is not recommended.

## AUTO Button



Press and release this button on the touchscreen, or push the button on the faceplate, to change the current setting. The AUTO indicator illuminates when AUTO is on. This feature automatically controls the interior cabin temperature by adjusting distribution and amount of airflow. Toggling this function will cause the system to switch between manual override mode and automatic modes  
 ⇨ page 65.

## MAX Defrost Button



Press and release the touchscreen button, or push and release the button on the faceplate, to change the current airflow setting to Defrost mode. The indicator illuminates when this feature is on. Performing this function will cause the automatic climate controls to change to manual mode, and the following settings will occur:

- The blower speed increases to full (all LEDs on)

### NOTE:

The blower speed increases to full only if warm outlet temperature can be guaranteed. Otherwise, the blower bars will be proportional to outlet air temperature.

- The air conditioning compressor is turned on (A/C LED off)
- Both driver and passenger temperature controls are set to HI
- Defrost mode is selected (LED on)
- Rear defroster is turned on (LED on)
- The air recirculation is turned off (LED off)

If MAX Defrost mode is turned off, the Climate Control system will return to the previous setting. MAX Defrost automatically turns off after a few minutes.

## Rear Defrost Button



Press and release the button on the touchscreen, or push and release the button on the faceplate, to turn on the rear window defroster and the heated outside mirrors (if equipped). The Rear Defrost indicator illuminates when the rear window defroster is on. The rear window defroster automatically turns off after 10 minutes.

### CAUTION!

Failure to follow these cautions can cause damage to the heating elements:

- Use care when washing the inside of the rear window. Do not use abrasive window cleaners on the interior surface of the window. Use a soft cloth and a mild washing solution, wiping parallel to the heating elements. Labels can be peeled off after soaking with warm water.
- Do not use scrapers, sharp instruments, or abrasive window cleaners on the interior surface of the window.
- Keep all objects a safe distance from the window.

## Driver And Passenger Temperature Control Buttons

These buttons provide the driver and passenger with independent temperature control.



Push upward on the driver's or passenger's side toggle switch on the faceplate, or press and slide the temperature bar towards the red arrow button on the touchscreen for warmer temperature settings.



Push downward the driver's or passenger's side toggle switch on the faceplate, or press and slide the temperature bar towards the blue arrow button on the touchscreen for cooler temperature settings.

## SYNC Button



Press the SYNC button on the touchscreen to toggle the Sync feature on/off. The SYNC indicator is illuminated when SYNC is on. SYNC is used to synchronize the passenger temperature setting with the driver temperature setting. Changing the passenger temperature setting while in SYNC will automatically exit this feature.

### NOTE:

The SYNC button is only available on the touchscreen.

## Blower Control



Blower Control is used to regulate the amount of air forced through the Climate Control system. There are seven blower speeds available. Adjusting the blower will cause automatic mode to switch to manual operation. The speeds can be selected using either the blower control buttons on the faceplate or the buttons on the touchscreen.

### Faceplate

Press the small blower icon button to decrease the blower speed, or press the large blower icon button to increase the blower speed.

### Touchscreen

Blower speed can also be selected by pressing a number on the blower bar area.

## Mode Control



Select Mode by pressing one of the Mode buttons on the touchscreen, or the faceplate, to change the airflow distribution mode. The airflow distribution mode can be adjusted so air comes from the instrument panel outlets, floor outlets, defrost outlets and demister outlets.

## Panel Mode



Air comes from the outlets in the instrument panel. Each of these outlets can be individually adjusted to direct the flow of air. The air vanes of the center outlets and outboard outlets can be moved up and down or side to side to regulate airflow direction. There is a shut-off wheel located below the air vanes to shut off or adjust the amount of airflow from these outlets.

## Bi-Level Mode



Air comes from the instrument panel outlets and floor outlets. A slight amount of air is directed through the defrost and side window demister outlets.

### NOTE:

Bi-Level mode is designed under comfort conditions to provide cooler air out of the panel outlets and warmer air from the floor outlets.

## Floor Mode



Air comes from the floor outlets. A slight amount of air is directed through the defrost, side window demister outlets, and panel outboard outlets.

## Defrost Mode



Air comes from the windshield and side window demister outlets. When the defrost button is selected, the blower level may increase. Use Defrost mode with maximum temperature settings for best windshield and side window defrosting and defogging. When toggling the front defrost mode button, the Climate Control system will return to the previous setting.

## Mix Mode



Air is directed through the floor, defrost, and side window demister outlets. This setting works best in cold or snowy conditions that require extra heat to the windshield. This setting is good for maintaining comfort while reducing moisture on the windshield. A slight amount of air is also directed through the panel outboard outlets.

## Combine Modes

### Dual Level Combination

Front Defrost and Panel Mode

### Tri-Level Combination

Front Defrost, Panel Mode, and Floor Mode



The driver or front passenger can combine two or three of the modes described by selecting them individually on the climate control screen. Combine modes by pressing each icon on the touchscreen.

## Climate Control OFF Button



Press and release this button on the touchscreen, or push and release the button on the faceplate to turn the Climate Control ON/OFF.

## AUTOMATIC TEMPERATURE CONTROL (ATC)

### Automatic Operation

1. Push the AUTO button on the faceplate, or the AUTO button on the touchscreen (if equipped) on the Automatic Temperature Control (ATC) Panel.
2. Next, adjust the temperature you would like the system to maintain by adjusting the temperature control buttons. Once the desired temperature is displayed, the system achieves and automatically maintains that comfort level.
3. When the system is set up for your comfort level, it is not necessary to change the settings. You experience the greatest efficiency by simply allowing the system to function automatically.

#### NOTE:

- It is not necessary to move the temperature settings for cold or hot vehicles. The system automatically adjusts the temperature, mode, and blower speed to provide comfort as quickly as possible.
- The temperature can be displayed in US or Metric units by selecting the US/Metric customer-programmable feature.

To provide you with maximum comfort in the Automatic mode during cold start-ups, the blower fan remains on low until the engine warms up. The blower increases in speed and transition into Auto mode.

### Manual Operation Override

This system offers a full complement of manual override features. The AUTO symbol in the front ATC display will be turned off when the system is being used in the manual mode.

## CLIMATE VOICE COMMANDS

Adjust vehicle temperatures hands-free and keep everyone comfortable while you keep moving ahead.

Push the VR button on the steering wheel. After the beep, say one of the following commands:

- “Set the driver temperature to 70 degrees”
- “Set the passenger temperature to 70 degrees”

**Did You Know:** Voice Command for Climate may only be used to adjust the interior temperature of your vehicle. Voice Command will not work to adjust the heated seats or steering wheel if equipped.

## OPERATING TIPS

Refer to the chart at the end of this section for suggested control settings for various weather conditions.

### Summer Operation

The engine cooling system must be protected with a high-quality antifreeze coolant to provide proper corrosion protection and to protect against engine overheating. OAT coolant (conforming to MS.90032) is recommended.

## Winter Operation

To ensure the best possible heater and defroster performance, make sure the engine cooling system is functioning properly and the proper amount, type, and concentration of coolant is used. Use of the Air Recirculation mode during Winter months is not recommended, because it may cause window fogging.

### Vacation/Storage

For information on maintaining the Climate Control system when the vehicle is being stored for an extended period of time, see [↔](#) page 269.

### Window Fogging

Vehicle windows tend to fog on the inside in mild, rainy, and/or humid weather. To clear the windows, select Defrost or Mix mode and increase the front blower speed. Do not use the Recirculation mode without A/C for long periods, as fogging may occur.









### Outside Air Intake

Make sure the air intake, located directly in front of the windshield, is free of obstructions, such as leaves. Leaves collected in the air intake may reduce airflow, and if they enter the air distribution box, they could plug the water drains. In Winter months, make sure the air intake is clear of ice, slush, and snow.

### Cabin Air Filter

The Climate Control system filters out dust and pollen from the air. Contact an authorized dealer to service your cabin air filter, and to have it replaced when needed.

## Operating Tips Chart

WEATHER	CONTROL SETTINGS
Hot Weather And Vehicle Interior Is Very Hot	Set the mode control to  (Panel Mode),  (MAX A/C) on, and blower on high. Roll down the windows for a minute to flush out the hot air. Adjust the controls as needed to achieve comfort.
Warm Weather	Turn  (A/C) on and set the mode control to  (Panel Mode).
Cool Sunny	Operate in  (Bi-Level Mode).
Cool & Humid Conditions	Set the mode control to  (Mix Mode) and turn  (A/C) on to keep windows clear.
Cold Weather	Set the mode control to  (Floor Mode). If windshield fogging starts to occur, move the control to  (Mix Mode).

## INTERIOR STORAGE AND EQUIPMENT

### STORAGE

#### Glove Compartment

The glove compartment is located on the passenger side of the instrument panel.

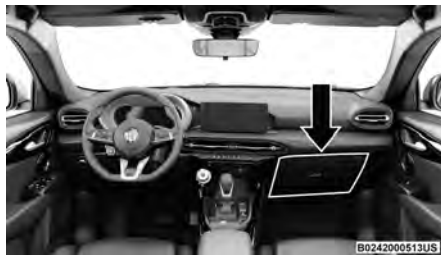

**Glove Compartment**

To open the glove compartment, pull the release handle.

#### WARNING!

Do not operate this vehicle with a glove compartment in the open position. Driving with the glove compartment open may result in injury in a collision.

#### Console Storage Compartment

To open, pull up on the latch and lift the cover.



**Center Console**

The center console has a storage area which can hold cell phones, PDAs, and other small items.

The center console can slide forward and rearward for comfort.

#### WARNING!

Do not operate this vehicle with a console compartment lid in the open position. Driving with the console compartment lid open may result in injury in a collision.

#### Door Storage

##### Front Door Storage

Storage areas are located in the door trim panels.

##### Rear Door Storage

Storage areas are located in the door trim panels.

## Seatback Storage

Located in the back of both the driver and passenger front seats are pockets that can be used for storage.

## Rear Seat Pass-Through — If Equipped

Located behind the center armrest is a pass-through door to cargo area.

The pass-through can be opened through rear seat or the cargo area. To open from the rear seat, pull the arm rest down and lift the latch to release the door. To open from the cargo area, lift the latch to release the door.

## USB CONTROL

This vehicle has data/charge ports for type USB A and C located on the central dashboard. For versions/markets where provided, the USB A and C port located on the back of the central console under the air vents are charge only. Both USB C ports, for versions/markets where provided, are Power Delivery 3.0, providing fast charging up to 40W.

Plugging in a smartphone device to a USB data/charge port will activate Android Auto™ or Apple CarPlay® features, if equipped. For further information, refer to “Android Auto™” or “Apple CarPlay®” in the Uconnect Radio Instruction Manual.

### NOTE:

Two devices can be plugged in at the same time, and both ports will provide charging capabilities. Only one port can transfer data to the system at a time.

For example, if a device is plugged into the Type A USB port and another device is plugged into the Type C USB port, a message will appear and allow you to select which device to use.

Different scenarios are listed here when a non-phone device is plugged into the smaller and larger USB ports, and when a phone device is plugged into the smaller and larger USB ports:

- “A new device is now connected. Previous connection was lost.”
- “(Phone Name) now connected. Previous connection was lost.”
- “Another device is in use through the same USB port. Please disconnect the first device to use the second device.”

Plugging in a phone or another USB device may cause the connection to a previous device to be lost.



**Front USB Ports**

- 1 — Type C USB Port
- 2 — Type A USB Port

By using a USB cable to connect an external device:

- The device can be played on the vehicle's sound system, providing the artist, track title, and album information on the radio display.

### NOTE:

Depending on track configuration, track information may not be present on the radio display.

- The device can be controlled using the radio buttons to play, and browse the contents of the device.
- The audio device battery charges when plugged into the USB port.

The second row USB ports can be used to charge an external device. These ports are charge only.

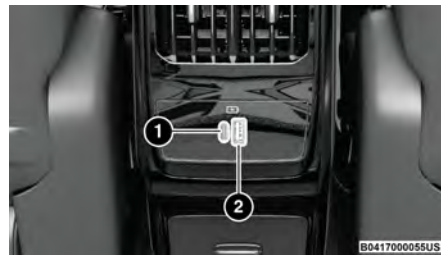

**Charge Only Rear USB Ports**

- 1 — Type C USB Port
- 2 — Type A USB Port

Both the front and rear USB C port have the ability for fast charging. They are Power Delivery 3.0 and can provide charging up to 40W.

### NOTE:

Charge unsupported devices with the Charge Only USB ports. If an unsupported device is plugged into a Media USB port, a message will display on the touchscreen that the device is not supported by the system.

## POWER OUTLETS — IF EQUIPPED

Your vehicle may be equipped with 12 Volt (13 Amp) power outlets that can be used to power cellular phones, small electronics and other low powered electrical accessories.

The Instrument Panel Power Outlet is located in the storage compartment under the climate control buttons. It will only operate when the ignition is in the ON/RUN position.



**Power Outlet**

### NOTE:

- Do not connect devices, with a power rating higher than 180 W, to the outlet. Do not use power adapters that do not fit the outlet as this may damage it.
- All accessories connected to the battery powered outlets should be removed or turned off when the vehicle is not in use to protect the battery against discharge.

If equipped, a power outlet is located in the rear cargo area.



**Rear Cargo Area Power Outlet — If Equipped**

### NOTE:

The rear cargo area power outlet can be switched from ignition powered to battery powered. See an authorized dealer for details.

Your vehicle may also be equipped with a power outlet on the back of the center console.



**Rear Center Console Power Outlet — If Equipped**

Power outlets labeled with a key symbol are powered when the ignition is in the ON/RUN position.

### WARNING!

To avoid serious injury or death:

- Only devices designed for use in this type of outlet should be inserted into any 12 Volt outlet.
- Do not touch with wet hands.
- Close the lid when not in use and while driving the vehicle.
- If this outlet is mishandled, it may cause an electric shock and failure.

### CAUTION!

- Power outlets are designed for accessory plugs only. Do not insert any other object in the power outlets as this will damage the outlet and blow the fuse. Improper use of the power outlet can cause damage not covered by your New Vehicle Limited Warranty.
- Many accessories that can be plugged in draw power from the vehicle's battery, even when not in use (i.e., cellular phones, etc.). Eventually, if plugged in long enough, the vehicle's battery will discharge sufficiently to degrade battery life and/or prevent the engine from starting.
- Accessories that draw higher power (i.e., coolers, vacuum cleaners, lights, etc.) will degrade the battery even more quickly. Only use these intermittently and with greater caution.
- After the use of high power draw accessories, or long periods of the vehicle not being started (with accessories still plugged in), the vehicle must be driven a sufficient length of time to allow the generator to recharge the vehicle's battery.

## WIRELESS CHARGING PAD — IF EQUIPPED



**Wireless Charging Pad**

Your vehicle may be equipped with a 15W 3A Qi® wireless charging pad located below the center stack, within the storage compartment. This charging pad is designed to wirelessly charge your Qi® enabled mobile phone. Qi® is a standard that allows wireless charging of your mobile phone.

Your mobile phone must be designed for Qi® wireless charging. If the phone is not equipped with Qi® wireless charging functionality, an aftermarket sleeve or a specialized back plate can be purchased from your mobile phone provider or a local electronics retailer. Please see your phone's Owner's Manual for further information.

The wireless charging pad is equipped with an anti-slip mat to hold your mobile phone in place, and an LED indicator light.

Place the device inside the prepared area delimited in the mat as shown in the image. Incorrect positioning will prevent the phone from charging.

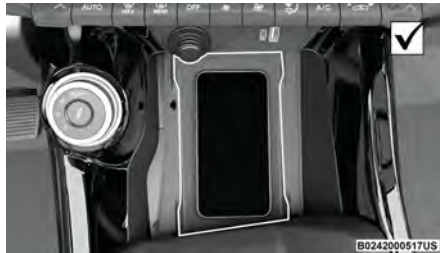

**Correct Phone Position**

### LED Indicator Status:

- No Light: Charging pad is idle or searching for a device. Device may not be compatible with the Qi® standard.
- Blue Light: Device is detected and is charging.
- Red Light/Flashing: Internal error, or foreign object is detected.
- Green Light: Device has completed battery charging (if device is equipped to transmit this information).

### Important Notes Regarding This Vehicle's Wireless Charging Pad:

- The presence of the NFC function active on a smartphone could signal malfunction anomalies.
- The ignition must be in the ON/RUN position in order for the phone to charge.
- To avoid interference with the key fob search, the wireless charging pad will stop charging when any door is opened.

- Be sure to place the mobile device correctly (display facing upward, and phone not covering the LED) on the wireless charging pad.
- Wireless charging is not as fast as when the phone is connected to a wired charger.
- The phone's protective case must be removed when placed on the wireless charging pad.
- iPhone® 12 (including iPod®) is equipped with software to protect the device from overheating. When the software is active, the rate of charge is slowed down to protect the device.
- Phones must always be placed on the wireless charging pad within the outline shown on the pad so that its charging parts connect with the charging coils of the system. Movement of the phone during charging may prevent or slow the rate of charge.
- Having multiple applications open on the phone while charging will reduce the charging efficiency, and may even shut down an application that is actively running (i.e. Apple CarPlay®). This may also cause the phone to overheat.
- Wireless chargers may implement certain methods to prevent the phone from overheating during charging such as slowing down the rate of charge. In certain instances, the device may shut down for a brief period of time (when the device reaches a certain temperature). If this happens, it does not mean there is a fault with the wireless charging pad. This may just be a protective measure to prevent damage to the phone.
- The use of multiple wireless functions at the same time (wireless charging, Apple CarPlay®, Android Auto™) could cause the device to overheat, resulting in limitation of the functions or it turning off. In this case, it is recommended to connect the system using the USB port.

- Do not place the key fob or any other type of metal/magnetized object inside the mobile phone housing or near the wireless charging pad.

**CAUTION!**

The key fob should not be placed on the charging pad or within 6 inches (15 cm) of it. Doing so can cause excessive heat buildup and damage to the fob. Placing the fob in close proximity of the charging pad blocks the fob from being detected by the vehicle and prevents the vehicle from starting.

## WINDOWS

### POWER WINDOW CONTROLS

The window controls on the driver's door control all the door windows.



**Power Window Controls**

The passenger door windows can also be operated by using the single window controls on each passenger door trim panel. The window controls will operate only when the ignition is in the ON/RUN position.

To open the window part way, push the window switch down briefly and release it when you want the window to stop.

**NOTE:**

- The power window switches will remain active for up to three minutes after the ignition is placed in the OFF position. Opening either front door will cancel this feature.
- The power windows may be operated from outside of the vehicle by using the key fob. For more information, see [page 33](#).

**WARNING!**

Never leave children unattended in a vehicle. Do not leave the key fob in or near the vehicle or in a location accessible to children, and do not leave the ignition of a vehicle equipped with Keyless Enter 'n Go™ in the ON/RUN position. Occupants, particularly unattended children, can become entrapped by the windows while operating the power window switches. Such entrapment may result in serious injury or death.

## AUTOMATIC WINDOW FEATURES

**Auto-Down Feature**

The power window switches have an Auto-Down feature. Push the window switch down for a short period of time, then release, and the window will go down automatically.

To stop the window from going all the way down during the Auto-Down operation, pull up or push the switch briefly.

**Anti-Pinch Protect**

When closing the windows, this feature will detect any obstruction in the path of the window and will automatically retract. Remove the obstruction if this occurs.

**WARNING!**

There is no anti-pinch protection when the window is almost closed. To avoid personal injury be sure to clear your arms, hands, fingers and all objects from the window path before closing.

## POWER WINDOW SYSTEM INITIALIZATION

If power supply is interrupted, the electric window automatic operation must be reinitialized.

To perform the initialization procedure, which must be done on each door with the doors closed, manually fully close the window to be initialized.



## WINDOW LOCKOUT SWITCH

The window lockout switch on the driver's door trim panel allows you to disable the window controls on the rear passenger doors. To disable the window controls, push and release the window lockout switch (the indicator light on the switch will turn on). To enable the window controls, push and release the window lockout switch again (the indicator light on the switch will turn off).



Window Lockout Switch

## WIND BUFFETING

Wind buffeting can be described as the perception of pressure on the ears or a helicopter-type sound in the ears. Your vehicle may exhibit wind buffeting with the windows down, or the sunroof (if equipped) in certain open or partially open positions. This is a normal occurrence and can be minimized. If the buffeting occurs with the rear windows open, open the front and rear windows together to minimize the buffeting. If the buffeting occurs with the sunroof open, adjust the sunroof opening to minimize the buffeting or open any window.

## POWER SUNROOF — IF EQUIPPED

The power sunroof and power sunshade switches are located between the sun visors on the overhead console.



Power Sunroof Switches

- 1 — Power Shade Open/Close Switch
- 2 — Front Panel Open/Close Switch
- 3 — Front Panel Vent Switch

### NOTE:

- Operation of the sunroof is only possible with the ignition in the ON/RUN position.
- You cannot have the sunshade closed when the sunroof is open.

### WARNING!

- Never leave children unattended in a vehicle, or with access to an unlocked vehicle. Never leave the key fob in or near the vehicle, or in a location accessible to children. Do not leave the ignition of a vehicle equipped with Keyless Enter 'n Go™ in the ON/RUN position. Occupants, particularly unattended children, can become entrapped by the power sunroof while operating the power sunroof switch. Such entrapment may result in serious injury or death.
- In a collision, there is a greater risk of being thrown from a vehicle with an open sunroof. You could also be seriously injured or killed. Always fasten your seat belt properly and make sure all passengers are also properly secured.
- Do not allow small children to operate the sunroof. Never allow your fingers, other body parts, or any object, to project through the sunroof opening. Injury may result.
- Do not use the sunroof and its related parts for supporting and/or grabbing purposes. Serious personal injury may result to fingers and other body parts as well as damage to the sunroof.

## OPENING AND CLOSING THE SUNROOF

The sunroof has two programmed automatic stops for the sunroof open position: a comfort stop position and a full open position. The comfort stop position has been optimized to minimize wind buffeting.

**Express Open/Close**

Push the switch rearward and release it within one-half second and the sunroof will open automatically from any position. The sunroof will open fully and stop automatically.

Push the switch forward and release it within one-half second and the sunroof will close automatically from any position. The sunroof will close fully and stop automatically.

During Express Open or Express Close operation, any other movement of the sunroof switch will stop the sunroof.

**Manual Open/Close**

To open the sunroof, push and hold the switch in the rearward position.

To close the sunroof, push and hold the switch in the forward position.

Any release of the switch during open or close operation will stop the sunroof movement. The sunroof will remain in a partially opened position until the switch is operated and held again.

**NOTE:**

If the sunshade is in the closed position when Express or Manual Open operation is initiated the sunshade will automatically open prior to the sunroof opening.

**Venting The Sunroof**

Push and release the Vent button within one-half second and the sunroof will open to the vent position. This is called Express Vent, and it will occur regardless of sunroof position. During Express Vent operation, any movement of the switch will stop the sunroof.

**NOTE:**

If the sunshade is in the closed position when the vent switch is pushed, the sunshade will automatically open prior to the sunroof opening to the Vent position.

## OPENING AND CLOSING THE POWER SUNSHADE

If the sunroof is open or vented, the sunshade cannot be closed beyond the half open position. Pushing the sunshade close switch when the sunroof is open/vented and the sunshade is at half open position will first automatically close the sunroof prior to the sunshade closing.

**Express Open/Close**

Push the sunshade switch rearward and release it within one-half second, the sunshade will open automatically.

Push the sunshade switch forward and release it within one-half second and the sunshade will close automatically.

During Express Open or Express Close operation, any other actuation of the sunroof switches will stop the sunshade in a partially open position.

**Manual Open/Close**

Push and hold the sunshade switch rearward, the sunshade will open.

Push and hold the switch forward and the sunshade will close and stop at full closed position.

Releasing the switch while the sunshade is in motion will stop the sunshade in a partially open position.

## PINCH PROTECT FEATURE

The sunroof has an anti-pinch safety system capable of detecting the presence of an obstacle during the closing movement. If an obstacle is detected, the system intervenes and the movement of the sunroof is immediately reversed.

## RE-INITIALIZATION PROCEDURE

Automatic operation of the sunroof must be re-initialized in case of faulty sunroof operation. It may also be necessary to re-initialize the sunroof after the vehicle's battery has been disconnected and then reconnected.

**NOTE:**

The anti-pinch safety device is deactivated during the re-initialization procedure.

Proceed as follows:

1. Place the ignition in the ON/RUN position.
2. Make sure the sunroof glass and the power sunshade are fully closed. Release the sunroof close switch, then push and hold it again within five seconds. Continue to hold the switch while the sunshade fully opens, the sunroof glass fully opens, followed by the glass fully closing then the sunshade fully closing.
3. Release the switch once all of the operations stop. Re-initialization of the sunroof motor is now complete.

**NOTE:**

If the switch is released prior to full completion of the operations described, the entire re-initialization procedure must be repeated from step 1.

4. Confirm express operations for the sunroof glass and sunshade are functional for opening and closing operations.

## SUNROOF MAINTENANCE

Use only a non-abrasive cleaner and a soft cloth to clean the glass panel. Periodically check for and clear out any debris that may have collected in the tracks.

## HOOD

### OPENING THE HOOD

#### WARNING!

**For PHEV Models:** Always place the ignition in the OFF position before opening the hood. If the ignition is in the RUN position and the Propulsion System is active when the hood is opened, the engine could automatically start, and persons not clear of the vehicle could be injured by the engine's moving parts.

Two latches must be released to open the hood.

1. Pull the hood release lever located underneath the driver's side of the instrument panel.



**Hood Release Location (Underneath Instrument Panel)**

2. Move to the outside of the vehicle. The safety latch release lever is located behind the front edge of the hood at the center. Lift the hood slightly and reach in at the center of the hood with a palm facing the ground. Once contact is made with the safety latch release lever, push it to the left to fully release the hood.



**Hood Safety Latch Release Lever Location**

3. Raise the hood completely. The operation is assisted by the addition of two gas props which hold it in the open position.

#### NOTE:

- Vehicle must be at a stop and the gear selector must be in PARK.
- You may have to push down slightly on the hood before pushing the safety latch.
- While lifting the hood, use both hands.
- Before lifting the hood, check that the wiper arms are not in motion and not in the lifted position.

- **For Hybrid models:** If the vehicle was actively charging the high voltage battery when the hood was opened, the vehicle will stop charging until the hood is closed.
- **For Hybrid models:** Electric drive mode will not be available while the hood is open. A message will show in the instrument cluster display to alert the driver.

2

### CLOSING THE HOOD

To close the hood, pull downward in a continuous motion until the crossover point, where the gas props no longer hold the hood open then let go.

#### NOTE:

- Make sure the hood is completely closed and not only fastened by the locking device by trying to open it. If it is not perfectly closed, do not try to press the hood down, but open it and repeat the procedure.
- **For PHEV Models:** If the vehicle stopped charging the high voltage battery when the hood was opened, the vehicle will resume charging when the hood closes.

#### WARNING!

Be sure the hood is fully latched before driving your vehicle. If the hood is not fully latched, it could open when the vehicle is in motion and block your vision. Failure to follow this warning could result in serious injury or death.

**CAUTION!**

To prevent possible damage, do not slam the hood to close it. Lower hood to approximately 12 inches (30 cm) and drop the hood to close. Make sure hood is fully closed for both latches. Never drive vehicle unless the hood is fully closed, with both latches engaged.

**LIFTGATE****UNLOCK/OPEN THE LIFTGATE**

The liftgate may be released in one of several ways:

- Key fob liftgate button (if equipped with power liftgate)
- Liftgate electronic release button
- Liftgate button on headlight switch (if equipped)
- Hands-Free Liftgate (if equipped)

**Headlight Switch Liftgate Button**

The key fob will release the liftgate when the liftgate is unlocked or locked. The electronic release button requires the liftgate to be unlocked.

**Liftgate Entry**

0222201587US

- 1 — Passive Entry Lock Button
- 2 — Liftgate Electronic Release Button

**To Unlock The Liftgate**

Use the key fob or the interior door unlock button on the door panel to unlock the liftgate.

**WARNING!**

Driving with the liftgate open can allow poisonous exhaust gases into your vehicle. You and your passengers could be injured by these fumes. Keep the liftgate closed when you are operating the vehicle.

**LOCK/CLOSE THE LIFTGATE**

There are several different ways to close the liftgate:

- Manually (grab the liftgate closing handle (if equipped) and pull in a downward motion)
- Key fob
- Hands-free (if equipped)
- Liftgate close or lock button (if equipped) on the liftgate door (only visible when the liftgate is open)

**NOTE:**

Before closing the liftgate, make sure to be in possession of the key fob because the liftgate may be locked.

**Liftgate Buttons (If Equipped)**

B0238000177US

- 1 — Liftgate Close Button
- 2 — Liftgate Lock Button

**To Lock The Liftgate**

With a valid Passive Entry key fob within 5 ft (1.5 m) of the liftgate, pushing the Passive Entry button located to the left of the electronic liftgate release button, will lock the vehicle only.

Use the key fob or the interior door lock button on the door panel to lock the liftgate. The manual door locks on the doors will not lock the liftgate.



Liftgate Entry

B0238000176US

- 1 – Passive Entry Lock Button  
2 – Liftgate Electronic Release Button

## POWER LIFTGATE — IF EQUIPPED



The power liftgate may be opened by pushing the liftgate button on the key fob, by pressing the power liftgate button on the headlight switch, or by pressing the liftgate electronic release button on the tailgate. Push the liftgate button on the key fob twice within five seconds to open or close the power liftgate. ↪ page 41.

When you push the liftgate button on the key fob or press the electronic liftgate release handle when the liftgate is in motion, it will pause.

The liftgate can be closed by pushing the liftgate button located on the base of the liftgate. If the liftgate is in motion, pushing the button again will reverse the liftgate.

Open or close the liftgate by pressing the power liftgate button on the headlight switch. To open press once, press again to pause opening. To close, the power liftgate button must be pressed and held for duration of closing process.

When the liftgate button on the key fob is pushed two times, the turn signals will flash twice to signal that the liftgate is opening or closing, and an audible chime can be heard (if enabled in the Uconnect Settings

↪ page 149).

The key fob and the headlight switch will open the liftgate when the liftgate is locked. The outside handle requires the liftgate to be unlocked. If the vehicle is equipped with Passive Entry, and a valid Passive Entry key fob is within 5 ft (1.5 m) of the liftgate, pulling the outside handle will unlock and open the liftgate.

### NOTE:

- Before closing the liftgate, make sure to be in possession of the key fob because the liftgate may be locked.
- Use the interior door lock/unlock button on the door panel or the key fob to lock and unlock the liftgate. The manual door locks on the doors and the exterior door lock cylinder will not lock and unlock the liftgate.
- The liftgate will either unlock along with the vehicle doors, or it will need to be unlocked by pushing the electronic liftgate release, depending on the selected setting in the Uconnect system ↪ page 149.
- The power liftgate buttons will not operate if the vehicle is in gear or the vehicle speed is above 0 mph (0 km/h).
- The power liftgate will not operate in temperatures below  $-22^{\circ}\text{F}$  ( $-30^{\circ}\text{C}$ ) or temperatures above  $150^{\circ}\text{F}$  ( $65^{\circ}\text{C}$ ). Be sure to remove any buildup of snow or ice from the liftgate before pushing any of the power liftgate switches.
- If anything obstructs the power liftgate while it is closing or opening, the liftgate will automatically reverse to the closed or open position. After multiple obstructions in the same cycle, the liftgate will automatically stop and must be opened or closed manually.
- There are pinch sensors attached to the side of the liftgate. Light pressure anywhere along these strips will cause the liftgate to return to the open position.
- The power liftgate must be in the full open position in order for the rear liftgate close button, on the base of the liftgate, to operate. If the liftgate is not fully open, push the liftgate button on the key fob to fully open the liftgate and then push it again to close.
- If the electronic liftgate release handle is pushed a second time while the power liftgate is opening, the liftgate motor will disengage to allow manual operation.
- If your liftgate is power closing and you put the vehicle in gear, the liftgate will continue to power close. However, vehicle movement may result in the detection of an obstruction.
- Allow the power system to open the liftgate. Manually pushing or pulling the liftgate may activate the liftgate obstacle detection feature and stop the power operation or reverse its direction.

**WARNING!**

- Driving with the liftgate open can allow poisonous exhaust gases into your vehicle. You and your passengers could be injured by these fumes. Keep the liftgate closed when you are operating the vehicle.
- If you are required to drive with the liftgate open, make sure that all windows are closed, and the climate control blower switch is set at high speed. Do not use the recirculation mode.
- During power operation, personal injury or cargo damage may occur. Ensure the liftgate travel path is clear. Make sure the liftgate is closed and latched before driving away.
- Personal injury or cargo damage may occur if caught in the path of the liftgate. Make sure the liftgate path is clear before activating the liftgate.

## ADJUSTABLE POWER LIFTGATE HEIGHT

The maximum height that the liftgate will open can be adjusted and saved so that the liftgate will only open to the desired height. To set a desired height, proceed as follows:

1. Open the liftgate fully, then manually pull down on the liftgate to the desired height.
2. Push and hold the lock button, located on the bottom of the liftgate, for three seconds. The turn signals will flash three times to indicate successful activation. The liftgate is now programmed to open to the set position.

To set the saved height setting to one of four preset positions, select the desired setting in Uconnect Settings ↔ page 149.

### Power Liftgate Malfunction Procedure:

1. In the event of a power malfunction to the liftgate, the liftgate can be released by accessing the service release feature in the latch. This can be done using a 3 mm diameter screwdriver.
2. From inside the gate, an eyelet can be seen. Place the screwdriver in the eyelet.
3. Rotate the screwdriver handle to actuate the lever and release the latch.
4. If liftgate is left open for an extended period of time, the liftgate may need to be closed manually to reset power liftgate functionality.

## HANDS-FREE LIFTGATE — IF EQUIPPED



Hands-Free Liftgate Activation Zone

To open or close the liftgate using hands-free activation, use a straight in and out kicking motion under the vehicle activation zone in the general location below the rear license plate. Do not move your foot sideways or in a sweeping motion or the sensors may not detect the motion.

Move your foot under the fascia/bumper, simulating a kick. When you have completed this movement, withdraw your leg. To activate the liftgate, both sensors must detect your leg.

If it is closed, the Hands-Free Liftgate unlocks and opens completely, and with another movement of the foot, it stops. A further movement of the foot reverses the direction and closes the liftgate completely, if you do not stop it again.

If it is open, with a movement of the foot, the Hands-Free Liftgate closes completely, and with another movement of the foot, it stops. If the liftgate is stopped, another movement of the foot will reverse the direction and open it completely.

### NOTE:

- To conserve the battery charge, avoid performing this operation repeatedly with the engine off.
- Opening or closing the Hands-Free Liftgate requires a valid Passive Entry key fob within 5 ft (1.5 m) of the door handle. If a valid Passive Entry key fob is not within 5 ft (1.5 m), the liftgate will not respond to any kicks.
- The Hands-Free Liftgate feature may be turned on or off through the Uconnect system ↔ page 149.
- The Hands-Free Liftgate feature should be turned off during jacking, tire changing, manual car wash, and vehicle service.

- The Hands-Free Liftgate feature can be activated by any metallic object making a similar in-and-out motion under the rear fascia/bumper, such as cleaning using a metal broom.
- The Hands-Free Liftgate will only operate when the transmission is in PARK.
- If anything obstructs the Hands-Free Liftgate while it is opening or closing, the liftgate will automatically reverse to the closed/open position, provided it meets sufficient resistance.
- There are pinch sensors attached to the side of the liftgate opening. Light pressure anywhere along these strips will cause the liftgate to return to the open position.
- If the power liftgate encounters multiple obstructions within the same cycle, the system will automatically stop. If this occurs, the liftgate must be operated manually.
- The power liftgate will release, but not power open, in temperatures below  $-12^{\circ}\text{F}$  ( $-24^{\circ}\text{C}$ ). Be sure to remove any buildup of snow or ice from the liftgate before opening the liftgate.
- If the liftgate is left open for an extended period of time (approximately one hour), the liftgate may need to be closed manually to reset power liftgate functionality.

**WARNING!**

- Driving with the liftgate open can allow poisonous exhaust gases into your vehicle. You and your passengers could be injured by these fumes. Keep the liftgate closed when you are operating the vehicle.

*(Continued)***WARNING!**

- If you are required to drive with the liftgate open, make sure that all windows are closed, and the climate control blower switch is set at high speed. Do not use the recirculation mode.
- During power operation, personal injury or cargo damage may occur. Ensure the liftgate travel path is clear. Make sure the liftgate is closed and latched before driving away.
- Personal injury or cargo damage may occur if caught in the path of the liftgate. Make sure the liftgate path is clear before activating the liftgate.

**CAUTION!**

The Hands-Free Liftgate can be turned off manually in the Uconnect system to avoid unintentional activation.

**NOTE:**

Allow the power system to open the liftgate. Manually pushing or pulling the liftgate may activate the liftgate obstacle detection feature and stop the power operation or reverse its direction.

**CARGO AREA FEATURES****Removable Rear Shelf — If Equipped**

To remove the rear shelf, proceed as follows:

1. Disconnect the two rods that support the shelf at the eyelets.

**Disconnect Rear Shelf Support Links**

2. Lift shelf off rear pins and remove from vehicle.

**Remove Rear Shelf Pin**

3. The rear shelf can be stored in the cargo area, or behind the front seat backs.

## Cargo Tie-Down Hooks And Loops

The tie-downs located on the cargo area floor should be used to secure loads safely when the vehicle is moving.

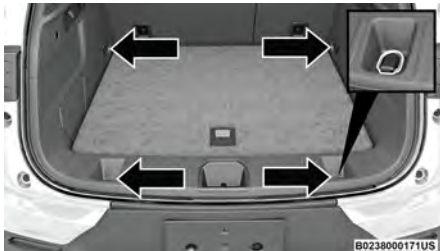

**Cargo Tie-Down Loops**

Cargo tie-down loops are located on the trim panels.

### WARNING!

- Cargo tie-downs are not safe anchors for a child seat tether strap. In a sudden stop or accident, a tie-down could pull loose and allow the child seat to come loose. A child could be badly injured. Use only the anchors provided for child seat tethers.
- To help protect against personal injury, passengers should not be seated in the rear cargo area. The rear cargo space is intended for load carrying purposes only, not for passengers, who should sit in seats and use seat belts.

*(Continued)*

### WARNING!

The weight and position of cargo and passengers can change the vehicle center of gravity and vehicle handling. To avoid loss of control resulting in personal injury, follow these guidelines for loading your vehicle:

- Do not carry loads that exceed the load limits described on the label attached to the left door or left door center pillar.
- Always place cargo evenly on the cargo floor. Put heavier objects as low and as far forward as possible.
- Place as much cargo as possible in front of the rear axle. Too much weight or improperly placed weight over or behind the rear axle can cause the vehicle to sway.
- Do not pile luggage or cargo higher than the top of the seatback. This could impair visibility or become a dangerous projectile in a sudden stop or accident.



# GETTING TO KNOW YOUR INSTRUMENT PANEL

## INSTRUMENT CLUSTER



## INSTRUMENT CLUSTER DESCRIPTIONS

1. Use this QR code to access your digital experience.



### Speedometer

- Indicates vehicle speed.

2. Instrument Cluster Display

- When the appropriate conditions exist, this display shows the instrument cluster display messages.
- The display always shows one of the main menu items after ignition is placed on.

3. Tachometer

- Indicates the engine speed in revolutions per minute (RPM x 1000).

4. Fuel Gauge

- This gauge shows the level of fuel in the fuel tank when the Keyless Push Button Ignition is in the ON/RUN position.
- The fuel pump symbol points to the side of the vehicle where the fuel door is located.
- Push the center-rear edge of the fuel



5. Oil Temperature Gauge

- The temperature gauge shows engine oil temperature. Any reading within the normal range indicates that the engine is operating satisfactorily.

### NOTE:

The Instrument Cluster Warning Indicators will illuminate briefly for a bulb check when the ignition is first cycled.

Depending on your vehicle trim, your instrument cluster display may vary.

## INSTRUMENT CLUSTER DISPLAY

Your vehicle may be equipped with an instrument cluster display, which offers useful information to the driver. With the ignition in the OFF mode, opening/closing of a door will activate the display for viewing, and display the total miles, or kilometers, in the odometer. Your instrument cluster display is designed to display important information about your vehicle's systems and features. Using the driver interactive display located on the instrument panel, your instrument cluster display can show you how systems are working and give you warnings when they aren't. The steering wheel mounted controls allow you to scroll through and enter the main menus and submenus. You can access the specific information you want and make selections and adjustments.

## INSTRUMENT CLUSTER DISPLAY LOCATION AND CONTROLS

The instrument cluster display features a driver interactive display that is located in the instrument cluster.

### NOTE:

Depending on your vehicle trim, your instrument cluster display may vary.



**Instrument Cluster Display And Controls Location**

- 1 – Instrument Cluster Display Screen
- 2 – Instrument Cluster Display Controls

The systems allow the driver to select information by pushing the following buttons mounted on the steering wheel or to control the radio:



**Instrument Cluster Display Control Thumbwheel**

- Push the **Main Screen** button to activate the Instrument Cluster Display Controls.
- **Thumbwheel**  
Use the **Thumbwheel** on the right side of the steering wheel to scroll through the menu options and submenus in the Instrument Cluster Display.
- **Thumbwheel Button**  
Press the **Thumbwheel Button** to select the highlighted menu option.

#### Main Screen Configuration — If Equipped

To customize the instrument cluster further, you are able to select up to five tiles to display information based on your needs.

- Press the **Main Screen** menu button for the Main Screen display.



**Main Screen Menu Button**

- Push the **Main Screen** button to activate the Instrument Cluster Display Controls.
- Navigate **up** or **down** using the **Thumbwheel** to highlight desired Tile.

- Press **Thumbwheel** to select the tile and navigate to the selected submenu and press **Thumbwheel** again to add your selection to your tile view.
- The **Main Screen** options are Speedometer, Navigation, Phone, Performance, Driver Assist, and Stored Messages.

#### Cluster Display Layouts

You may toggle through the different **Cluster Display Layouts** by pressing the **Menu View** button located at the end of the wiper/washer lever on the right hand side of the steering column:



**Instrument Cluster Menu View Button**

#### Cluster Display Layout Selections

- **Evolved Layout** — Gauges are displayed in a more compact fashion while allowing more space to display main screens and widgets.
- **Relax Layout** — Gauges are hidden, less information is displayed on the display; however, all main screens and widgets are available.
- **Heritage Layout** — Full sized round gauges are visible, main screens and widgets are available.

The instrument cluster display is located in the center portion of the cluster and consist of multiple sections:

- **Main Screen** — The inner ring of the display will illuminate in gray under normal conditions, yellow for non-critical warnings, red for critical warnings, and white for on demand information.
- **Submenu Dots** — Whenever there are submenus available, the position within the submenus is shown here.
- **Reconfigurable Telltales/Information**
- **Gear Selector Status (PRND)**
- **Driver Interactive Display (Compass, Temp, Range to Empty, Trip A, Trip B, Average Fuel Economy, Current Fuel Economy, Tire Pressure, and Time)**

The instrument cluster display will normally display the main menu or the screens of a selected feature of the main menu. The main display area also displays pop-up messages that consist of approximately 60 possible warning or information messages. These pop-up messages fall into several categories:

- **Five Second Stored Messages**

When the appropriate conditions occur, this type of message takes control of the main display area for five seconds and then returns to the previous screen. Most of the messages of this type are then stored (as long as the condition that activated it remains active) and can be reviewed from the "Messages" main menu item. Examples of this message type are "Right Front Turn Signal Lamp Out" and "Low Tire Pressure."

### • Unstored Messages

This message type is displayed indefinitely or until the condition that activated the message is cleared. Examples of this message type are “Turn Signal On” (if a turn signal is left on) and “Lights On” (if driver leaves the vehicle with the lights on).

### • Unstored Messages Until RUN

These messages deal primarily with the Remote Start feature. This message type is displayed until the ignition is in the RUN state. Examples of this message type are “Remote Start Canceled - Door Ajar” and “Press Brake Pedal and Push Button to Start.”

### • Five Second Unstored Messages

When the appropriate conditions occur, this type of message takes control of the main display area for five seconds and then returns to the previous screen. An example of this message type is “Automatic High Beams On.”

## OIL CHANGE RESET

Use this QR code to access your digital experience.



- Your vehicle is equipped with an engine oil change indicator system. A message will display in the instrument cluster display for five seconds to indicate the next scheduled oil change interval is due. The engine oil change indicator system is duty cycle based, which means the engine oil change interval may fluctuate, dependent upon your personal driving style.
- Unless reset, this message will continue to display each time the ignition is cycled to the ON/RUN position.

To reset the oil change indicator after performing the scheduled maintenance, refer to the following procedure:

1. Without pressing the brake pedal, push the ENGINE START/STOP button and cycle the ignition to the ON/RUN position (do not start the engine).
2. Fully press the accelerator pedal, slowly, three times within ten seconds.
3. Cycle the ignition to the OFF position.

### NOTE:

If the indicator message illuminates when you start the vehicle, the oil change indicator system did not reset. If necessary, repeat this procedure.

## STOP SAFELY AND LEAVE THE VEHICLE AS SOON AS POSSIBLE



**Stop Safely And Leave The Vehicle As Soon As Possible  
Warning Message**

- This message will be displayed continuously.
- Cannot be cleared with a button press.
- A continuous and rapid chime will sound.

A warning will appear on the instrument panel display if the system detects the high voltage battery has overheated. This can result in a vehicle fire, and the release of toxic and/or flammable gases. To reduce the risk of a larger fire, **the vehicle's high voltage propulsion system will turn off within thirty seconds of displaying this warning.** At that time, the vehicle may not accelerate. You can still steer and brake the vehicle.

**Stop and park the vehicle in an open area.** Have all passengers exit the vehicle as soon as possible and move to a safe distance away from the vehicle. After all passengers safely exit the vehicle, call emergency responders immediately. Even if you do not see flames, a fire may start at any moment, so do not attempt to re-enter or start the vehicle.

### CAUTION!

If the instrument cluster instructs you to change the engine oil, do not reset the service indicator without changing the oil. Engine damage may result.

### CAUTION!

An overheated High Voltage Battery may result in electrical systems damage. Do not attempt to restart the vehicle. The vehicle must be towed to an authorized dealer.

## ELECTRIC MODE TEMPORARILY UNAVAILABLE

If Electric mode is unavailable, the reason will display for five seconds at start up. If your check engine light comes on, see an authorized dealer immediately.



**Electric Mode Temporarily Unavailable Message**

See the following information for the most common reasons the Electric mode would be unavailable:

### Operator choices that can inhibit Electric Mode:

- Transmission control using Paddle Shifters - Return to auto mode to use Electric mode.
- Heavily depressed accelerator pedal position, requesting high power demand - Beyond the limits of the electric drivetrain, will cause engine to run, enabling the powertrain to produce its full combined power available in Hybrid mode.
- Sustained high speed operation in Electric mode - Using the engine is more efficient for high speeds than Electric mode.

- Electric range is depleted - You need to recharge to enjoy Electric mode, or you can continue normally in Hybrid.
- Hood open (or a hood switch fault) - This is to prevent unexpected engine starts with the hood open.

### Thermal protection that can inhibit Electric Mode:

- Engine, transmission or engine starting belt too cold - Some systems require warm-up to function properly if the ambient temperature is below 15 °F.
- Electric cabin heating capacity limits (or electric cabin heater fault) - Unlike Battery Electric Vehicles (BEV's), the PHEV can warm the cabin more efficiently with engine heat when operating below 15 °F outside temperature.
- HV battery, motors or contactors over temperature - This is a temporary hardware protection feature. Vehicle performance will resume once protection is no longer required. If the vehicle performance is accompanied with a Malfunction Indicator Lamp (MIL) , have the vehicle serviced at an authorized dealership.

### Component protection that can inhibit Electric Mode:

- HV battery undervoltage - Sustained EV operation at high speed, especially with aftermarket wheels and tires, can induce this.
- Other electric propulsion system faults indicated by a MIL - Please see an authorized dealer for service.
- Fuel and Oil Refresh Mode - See the following section.

## FUEL AND OIL REFRESH MODE

Since it is possible to operate this vehicle for extended periods of time without running the gas engine, the fuel within the vehicle's fuel tank can become stale or the engine oil's lubricating properties can be reduced. To prevent engine and/or fuel system damage due to stale fuel, as well as maintaining internal engine lubrication, this vehicle is equipped with a Fuel and Oil Refresh Mode.

### NOTE:

If the vehicle enters Fuel and Oil Refresh Mode to maintain engine lubrication, adding fuel will not exit the mode sooner.



**Fuel and Oil Refresh Mode Message**

The vehicle will automatically enter into the Fuel and Oil Refresh Mode to minimize potential for stale fuel, and to ensure lubrication of internal engine components. When operating in this mode, the gas engine will run to provide vehicle propulsion (electric only operation is inhibited). A message will be displayed in the instrument cluster whenever Fuel and Oil Refresh Mode is active.

The vehicle will automatically exit the Fuel and Oil Refresh Mode when fuel and lubrication conditions have been satisfied. If the vehicle enters Fuel and Oil Refresh Mode, due to fuel which has been in the fuel tank for a long period of time (becoming stale fuel), the engine will run whenever the vehicle is operational (no electric only operation) until the low fuel level warning is activated. It is also possible to exit the Fuel and Oil Refresh Mode sooner by adding a minimum of four gallons of new fuel to the vehicle's fuel tank.

If the vehicle enters Fuel and Oil Refresh Mode to maintain engine lubrication properties, the engine may run for a period of up to 2.5 hours when fully warm whenever the vehicle is operational (no electric only operation). If the vehicle is shut down before conditions to exit the refresh mode have been satisfied, the engine may run for additional time on subsequent trips. Oil refresh may take significantly longer in freezing temperatures.

#### NOTE:

- Frequent short trips at low ambient temperature conditions where the engine does not reach normal operating temperatures are more likely to trigger the Fuel and Oil Refresh Mode.
- Electric drive mode will be temporarily unavailable while the Fuel and Oil Refresh Mode is active. Do not attempt to return to Electric mode until the Fuel and Oil Refresh Mode cycle is complete.

#### CAUTION!

If the instrument cluster instructs you to change the engine oil, do not reset the service indicator without changing the oil. Engine damage may result.

## POWER STEERING CHECK MESSAGE

Presence of a "Have power steering checked" warning message and/or Electronic Power Steering (EPS) warning light on the instrument cluster display could indicate that there has been a loss of steering angle calibration.

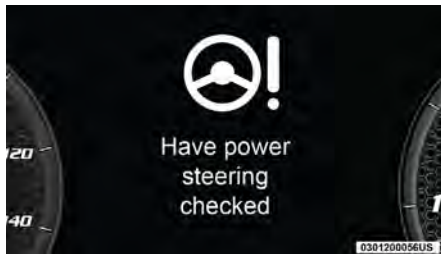

Have Power Steering Checked Warning Message

A battery replacement or disruption of power may cause this (i.e., battery disconnect). Performing a Lock-to-Lock Steering Angle Calibration may correct this condition.

➔ page 108

## GEAR SHIFT INDICATOR (GSI) — IF EQUIPPED

The GSI system is enabled on vehicles with a manual transmission, or when a vehicle with an automatic transmission is in manual shift mode. The GSI provides the driver with a visual indication when the recommended gear shift point has been reached. This indication notifies the driver that changing gear will allow a reduction in fuel consumption. When the up shift indicator is shown on the instrument cluster display, the GSI is advising the driver to engage a higher gear. When the down shift indicator is shown on the display, the GSI is advising the driver to engage a lower gear.

The GSI remains illuminated until the driver changes gears, or the driving conditions return to a situation where changing gear is not required to improve fuel consumption.

## INSTRUMENT CLUSTER DISPLAY MENU ITEMS

The instrument cluster display can be used to view the main menu items for several features. Use the **up**  $\triangle$  and **down**  $\nabla$  arrow buttons to scroll through the driver interactive display menu options until the desired menu is reached.

#### NOTE:

The instrument cluster display menu items display in the center of the instrument cluster. Menu items may vary depending on your vehicle features.

## Main Menu

Use the Thumbwheel to scroll Up and Down through the **Menu** options. Press the Thumbwheel to enter and exit the highlighted menu option.

### NOTE:

These Menu options may vary based on your vehicles trim level.

## SPEEDOMETER

The Speedometer menu options may consist of the following:

- Digital speed and speed unit (MPH or km/h)
- Gear Shift Indicator (GSI)
- Gear
- Drive mode name

The speed units can be changed from MPH to km/h by pressing the Thumbwheel.

## ODOMETER

The odometer may be visible on:

- Cluster Start-Up Animation
- Speedometer Page
- Trip A/B Widget

## NAVIGATION — IF EQUIPPED

Turn the Thumbwheel up or down to increase or decrease the zoom on this screen. Press the Thumbwheel to go back to the initial frame. The zoom level is automatically reset to the factory settings whenever the engine is restarted.

The following information is shown:

- Direction Indicators
- Distance to next change of direction (in miles or kilometers, depending on instrument panel settings)

- Suggested lanes
- Address of the road to be followed after the change of direction

Press and hold the Thumbwheel to disable the indications in the right-hand ring for the current navigation. If a predicted route is selected, the route shall start without further confirmation.

### NOTE:

During projection modes (Apple CarPlay® or Android Auto™) the native map is not available. Only native maps are able to be displayed on the instrument cluster display. Other non-native navigation systems can be displayed one at a time through the radio display.

## PHONE

This menu displays the current status of a phone connected to the vehicle via Bluetooth®. The System supports up to two phones connected at the same time. Information available in cluster depends on which phone is dynamically selected by the user in each moment (i.e. the phone in focus), to enter and select one of the phone connected user should press Thumbwheel

If no phone is connected, the menu will not function when the **OK** button is pushed. Otherwise, if a phone is connected, push the **OK** button to enter the menu. The following items will display:

- Recent calls: displays a list of the last 10 calls.
- SMS reader: displays the last 10 text messages and if they are read or unread.
- Favorite numbers: displays a maximum of 10 favorite numbers.

## PERFORMANCE

Performance page content automatically changes according to the selected drive mode.

### G-meter Dynamic



**G-meter Dynamic Screen**

This displays parameters related to car stability, the graphs illustrate the trend of the longitudinal/lateral accelerations (G-meter information), considering gravity acceleration as a reference unit.

## DRIVER ASSIST

The instrument cluster display displays the current Adaptive Cruise Control (ACC) and Lane Keep Assist (LKA) system settings. The information displayed depends on ACC system status.

The Instrument Cluster Display shows the status and settings of the driving assistance Adaptive Cruise Control, Lane Keep Assist and Active Driving Assist systems. Any instant notifications are displayed via a pop-up screen.



The instrument cluster display displays the current LKA system settings. The information displayed depends on Lane Keep Assist system status and the conditions that need to be met → page 133.

## STORED MESSAGES

Turn the Thumbwheel up and down until the Stored Messages menu option is highlighted. Press the Thumbwheel to enter and exit the Stored Messages.

Messages shown on the display via pop-up screens are stored as long as they remain valid. You can view them later in the central area of the “Messages” screen.

If multiple messages are present:

- Press the Thumbwheel to access the message list.
- Scroll through the messages by turning the Thumbwheel up or down. The presence of previous or next message is indicated by gray dots.

## CHARGE / POWER — IF EQUIPPED

The “Charge / Power” function shows the instantaneously available power on the instrument panel display.

This information is to inform the driver about the drive mode of the vehicle, if the vehicle is in charge status or power status, and if the vehicle is being powered by the engine, battery, or hybrid.

Charge/Power info can be represented by a gauge with different bar graph filling according to the current state of the battery (charging / discharging). Current battery's and engine's state will be shown using different bar graph filling colors.



Charge / Power Screen

### Charge / Power Visualization

- Sport: Battery level bar graph. No highlight for critical battery level is shown as the State of Charge (SOC) approaches the lower level, and the bar graph will be linear.
- Hybrid, Electric and e-Save: Hybrid info Range to empty composed by three range values, Total Range, Electric, and Fuel. Units to be shown according with the set selection.

### HYBRID INFO

#### Efficiency Coach

Efficiency Coach will monitor your current driving to help you drive as efficient as possible.

- “Accel” is based on amount of acceleration (Difference from MPG).
  - The gauge will only move up when accelerator pedal is pushed (or accelerating with Cruise Control or ACC).
  - Above a certain rate of change will be considered inefficient.
  - The color of the gauge bar will change from green to yellow to orange.

- “Brake” is based on amount of deceleration (slowing down).
  - The gauge will only move down when brake pedal is pushed (or decelerating with Cruise Control or ACC).
  - The color of the gauge bar will change from green to yellow to orange.
- The gauge bar color will transition smoothly up and down, and have a gradual change based on efficiency.
  - Center of gauge is 0% Accel and 0% Brake.
  - +/-0-35% of gauge fills green, +/-36-80% yellow, and +/-81-100% orange (with a blend between each color).

### E-Drive Mode

- Hybrid automatically adapts for most efficient driving.
- Electric mode saves fuel for later use.
- e-Save mode saves battery for later use.

## BATTERY SAVER ON/BATTERY SAVER MODE MESSAGE — ELECTRICAL LOAD REDUCTION ACTIONS — IF EQUIPPED

This vehicle is equipped with an Intelligent Battery Sensor (IBS) to perform additional monitoring of the electrical system and status of the vehicle battery.

In cases when the IBS detects charging system failure, or the vehicle battery conditions are deteriorating, electrical load reduction actions will take place to extend the driving time and distance of the vehicle. This is done by reducing power to or turning off non-essential electrical loads.



Load reduction is only active when the engine is running. It will display a message if there is a risk of battery depletion to the point where the vehicle may stall due to lack of electrical supply, or will not restart after the current drive cycle.

These messages indicate the vehicle battery has a low state of charge and continues to lose electrical charge at a rate that the charging system cannot sustain.

#### NOTE:

- The charging system is independent from load reduction. The charging system performs a diagnostic on the charging system continuously.
- If the Battery Charge Warning Light is on it may indicate a problem with the charging system → page 88.

The electrical loads that may be switched off (if equipped), and vehicle functions which can be effected by load reduction:

- Heated Seat/Vented Seats/Heated Wheel
- Heated/Cooled Cup Holders — If Equipped
- Rear Defroster And Heated Mirrors
- HVAC System
- 150W Power Inverter System
- Audio and Telematics System

Loss of the battery charge may indicate one or more of the following conditions:

- The charging system cannot deliver enough electrical power to the vehicle system because the electrical loads are larger than the capability of charging system. The charging system is still functioning properly.

- Turning on all possible vehicle electrical loads (e.g. HVAC to max settings, exterior and interior lights, overloaded power outlets +12 Volts, 150W, USB ports) during certain driving conditions (city driving, towing, frequent stopping).
- Installing options like additional lights, upfitter electrical accessories, audio systems, alarms and similar devices.
- Unusual driving cycles (short trips separated by long parking periods).
- The vehicle was parked for an extended period of time (weeks, months).
- The battery was recently replaced and was not charged completely.
- The battery was discharged by an electrical load left on when the vehicle was parked.
- The battery was used for an extended period with the engine not running to supply radio, lights, chargers, +12 Volts portable appliances like vacuum cleaners, game consoles and similar devices.

#### What to do when an electrical load reduction action message is present (“Battery Saver On” or “Battery Saver Mode”)

During a trip:

- Reduce power to unnecessary loads if possible:
  - Turn off redundant lights (interior or exterior)
  - Check what may be plugged into power outlets +12 Volts, 150W, USB ports
  - Check HVAC settings (blower, temperature)
  - Check the audio settings (volume)

After a trip:

- Check if any aftermarket equipment was installed (additional lights, upfitter electrical accessories, audio systems, alarms) and review specifications if any (load and Ignition Off Draw currents).

- Evaluate the latest driving cycles (distance, driving time and parking time).
- The vehicle should have service performed if the message is still present during consecutive trips and the evaluation of the vehicle and driving pattern did not help to identify the cause.

## WARNING LIGHTS AND MESSAGES

The warning/indicator lights will illuminate in the instrument panel together with a dedicated message and/or acoustic signal when applicable. These indications are indicative and precautionary and as such must not be considered as exhaustive and/or alternative to the information contained in the Owner’s Manual, which you are advised to read carefully in all cases. Always refer to the information in this chapter in the event of a failure indication. All active telltales will display first if applicable. The system check menu may appear different based upon equipment options and current vehicle status. Some telltales are optional and may not appear.

## RED WARNING LIGHTS

### Air Bag Warning Light



This warning light will illuminate to indicate a fault with the air bag, and will turn on for four to eight seconds as a bulb check when the ignition is placed in the ON/RUN position. This light will illuminate with a single chime when a fault with the air bag has been detected, it will stay on until the fault is cleared. If the light is either not on during startup, stays on, or turns on while driving, have the system inspected at an authorized dealer as soon as possible.

## Brake Warning Light



This warning light monitors various brake functions, including brake fluid level and parking brake application. If the brake light turns on it may indicate that the parking brake is applied, that the brake fluid level is low, or that there is a problem with the Anti-Lock Brake System reservoir.

If the light remains on when the parking brake has been disengaged, and the fluid level is at the full mark on the master cylinder reservoir, it indicates a possible brake hydraulic system malfunction or that a problem with the Brake Booster has been detected by the Anti-Lock Brake System (ABS) / Electronic Stability Control (ESC) system. In this case, the light will remain on until the condition has been corrected. If the problem is related to the brake booster, the ABS pump will run when applying the brake, and a brake pedal pulsation may be felt during each stop.

The dual brake system provides a reserve braking capacity in the event of a failure to a portion of the hydraulic system. A leak in either half of the dual brake system is indicated by the Brake Warning Light, which will turn on when the brake fluid level in the master cylinder has dropped below a specified level.

The light will remain on until the cause is corrected.

### NOTE:

The light may flash momentarily during sharp cornering maneuvers, which change fluid level conditions. The vehicle should have service performed, and the brake fluid level checked.

If brake failure is indicated, immediate repair is necessary.

### WARNING!

Driving a vehicle with the red brake light on is dangerous. Part of the brake system may have failed. It will take longer to stop the vehicle. You could have a collision. Have the vehicle checked immediately.

Vehicles equipped with the Anti-Lock Brake System (ABS) are also equipped with Electronic Brake Force Distribution (EBD). In the event of an EBD failure, the Brake Warning Light will turn on along with the ABS Light. Immediate repair to the ABS system is required.

Operation of the Brake Warning Light can be checked by turning the ignition switch from the OFF position to the ON/RUN position. The light should illuminate for approximately two seconds. The light should then turn off unless the parking brake is applied or a brake fault is detected. If the light does not illuminate, have the light inspected by an authorized dealer.

The light also will turn on when the parking brake is applied with the ignition switch in the ON/RUN position.

### NOTE:

This light shows only that the parking brake is applied. It does not show the degree of brake application.

## Battery Charge Warning Light



This warning light will illuminate when the battery is not charging properly. If it stays on while the engine is running, there may be a malfunction with the charging system. Contact an authorized dealer as soon as possible.

This indicates a possible problem with the electrical system or a related component.

## Door Open Warning Light



This indicator will illuminate when a door is ajar/open and not fully closed.

### NOTE:

If the vehicle is moving, there will also be a single chime.

## Drowsy Driver Detected Warning Light — If Equipped



Driver drowsiness detection helps to avoid crashes caused by fatigue by advising drowsy drivers to take a break from driving. Once Drowsy Driver is detected, a pop-up will display continuously until the driver presses the **Thumbwheel** button to clear.

Once the pop-up message is cleared, it is stored until the condition is no longer true.

## Electric Power Steering (EPS) Fault Warning Light



This warning light will turn on when there's a fault with the EPS system → page 108. Presence of a "Have power steering checked" warning message could indicate a loss of steering angle calibration → page 84.

### WARNING!

Continued operation with reduced assist could pose a safety risk to yourself and others. Service should be obtained as soon as possible.

## Electronic Throttle Control (ETC) Warning Light



This warning light will illuminate to indicate a problem with the ETC system. If a problem is detected while the vehicle is running, the light will either stay on or flash depending on the nature of the problem. Cycle the ignition when the vehicle is safely and completely stopped and the transmission is placed in the PARK position. The light should turn off. If the light remains on with the vehicle running, your vehicle will usually be drivable; however, see an authorized dealer for service as soon as possible.

### NOTE:

This light may turn on if the accelerator and brake pedals are pressed at the same time.

If the light continues to flash when the vehicle is running, immediate service is required and you may experience reduced performance, an elevated/rough idle, or engine stall and your vehicle may require towing. The light will come on when the ignition is placed in the ON/RUN position and remain on briefly as a bulb check. If the light does not come on during starting, have the system checked by an authorized dealer.

## Engine Coolant Temperature Warning Light



This warning light will illuminate to warn of an overheated engine condition. If the engine coolant temperature is too high, this light will illuminate and a single chime will sound.

If the light turns on while driving, safely pull over and stop the vehicle. If the Air Conditioning (A/C) system is on, turn it off. Also, shift the transmission into NEUTRAL (N) and idle the vehicle. If the temperature reading does not return to normal, turn the engine off immediately and call for service → page 225.

### WARNING!

A hot engine cooling system is dangerous. You or others could be badly burned by steam or boiling coolant. It is recommended to call an authorized dealer for service if your vehicle overheats → page 240.

### CAUTION!

Driving with a hot engine cooling system could damage your vehicle. If the temperature gauge reads "H", pull over and stop the vehicle. Idle the vehicle with the air conditioner turned off until the pointer drops back into the normal range. If the pointer remains on the "H", turn the engine off immediately and call an authorized dealer for service.

## Hood Open Warning Light



This warning light will illuminate when the hood is left open and not fully closed.

### NOTE:

If the vehicle is moving, there will also be a single chime.

## Liftgate Open Warning Light



This warning light will illuminate when the liftgate is open.

### NOTE:

If the vehicle is moving, there will also be a single chime.

## Oil Pressure Warning Light



This warning light will illuminate to indicate low engine oil pressure. If the light turns on while driving, stop the vehicle, shut off the engine as soon as possible, and contact an authorized dealer. A chime will sound when this light turns on.

Do not operate the vehicle until the cause is corrected. This light does not indicate how much oil is in the engine. The engine oil level must be checked under the hood.

## Oil Temperature Warning Light



This warning light will illuminate to indicate the engine oil temperature is high. If the light turns on while driving, stop the vehicle and shut off the engine as soon as possible. Wait for oil temperature to return to normal levels.

## Plug Status Fault Warning Light



This warning light will illuminate when a plug status fault is detected (when vehicle not in motion). It will be accompanied by a cluster message indicating the type of fault. You may receive one of the following messages if a fault is detected:

- **Service Charging System** – If you see a service charging system message, it is recommended to unplug and plug in again, or try a different charging station. If an issue continues, contact an authorized dealer.
- **Issue Detected Check External Charging Station** – If you see an issue detected message, the charging station might be powered off, have an internal fault or be scheduled to charge later. It is recommended to try a different charging station. If an issue continues, then contact an authorized dealer.

**NOTE:**

- Older or non-compliant J1772 EVSE models may not support charging of this vehicle. If this vehicle does not charge, it may be connected to a non-compliant Level 2 EVSE, and will flash indicators. Please identify this failure to the site operator and/or EVSE provider.
- Before this vehicle can be driven, the EVSE Charging Cord must be disconnected from the vehicle.

**Seat Belt Reminder Warning Light**

This warning light indicates when the driver or passenger seat belt is unbuckled. When the ignition is first placed in the ON/RUN position and if the driver's seat belt is unbuckled, a chime will sound and the light will turn on. When driving, if the driver or front passenger seat belt remains unbuckled, the Seat Belt Reminder Light will flash or remain on continuously and a chime will sound

➞ page 182.

**Service Hybrid System Warning Light — If Equipped**

This warning light will illuminate when service to the hybrid electric system is needed. It will be accompanied by a message in the cluster. If the telltale stays on or continues to come on, contact an authorized dealer as soon as possible.

**SOS Battery Fault Warning Light — If Equipped**

This warning light will illuminate to signal a fault with the SOS Battery system. If the light stays on or comes on during driving, we recommend you drive to the nearest service center and have the vehicle serviced immediately.

**Traction Battery Fault Warning Light**

This light alerts the driver that there is a failure in the Traction Battery System. Contact an authorized dealer if illumination persists.

**Torque Limited Warning Light**

This warning light illuminates when vehicle acceleration is limited due to a reduction in engine or electric motor performance. If the telltale stays on or continues to come on, contact an authorized dealer as soon as possible.

**Transmission Fault Warning Light — If Equipped**

This light will illuminate (together with a message in the instrument cluster display and a buzzer) to indicate a transmission fault. Contact an authorized dealer if the message remains after restarting the engine.

**Vehicle Security Warning Light — If Equipped**

This light will flash at a fast rate for approximately 15 seconds when the Vehicle Security system is arming, and then will flash slowly until the vehicle is disarmed.

**YELLOW WARNING LIGHTS****Acoustic Vehicle Alerting System (AVAS) Fault Warning Light — If Equipped**

This light alerts the driver that the AVAS system is not functioning properly. If the light stays on contact and authorized dealer for service.

**Auto Liftgate Fault Warning Light — If Equipped**

This warning light will illuminate to signal when there is a fault detected with the Auto Liftgate.

### Fuel Level Sensor Failure Warning Light



This light illuminates when there is a fuel level sensor failure. If this light illuminates, take it to an authorized dealer and have them inspect it.

### Active Speed Limiter Fault Warning Light — If Equipped



This warning light will illuminate to signal when there is a fault detected with the Active Speed Limiter.

### Blind Spot Detection Fault Warning Light



This light alerts the driver that there is a fault in the Blind Spot Detection system.

### Anti-Lock Brake System (ABS) Warning Light



This warning light monitors the ABS. The light will turn on when the ignition is placed in the ON/RUN position and may stay on for as long as four seconds.

If the ABS light remains on or turns on while driving, then the Anti-Lock portion of the brake system is not functioning and service is required as soon as possible. However, the conventional brake system will continue to operate normally, assuming the Brake Warning Light is not also on.

If the ABS light does not turn on when the ignition is placed in the ON/RUN position, have the brake system inspected by an authorized dealer.

### Drowsy Driver Detected System Fault Warning Light — If Equipped



This warning light will illuminate when the Drowsy Driver Detected (DDD) system is not operating correctly and requires service. Please see an authorized dealer.

### Electric Park Brake Warning Light



This warning light will illuminate to indicate the Electric Park Brake is not functioning properly and service is required. Contact an authorized dealer.

### Electronic Stability Control (ESC) Active Warning Light — If Equipped



This warning light will indicate when the ESC system is Active. The ESC Indicator Light in the instrument cluster will come on when the ignition is placed in the ON/RUN position, and when ESC is activated. It should go out with the engine running. If the ESC Indicator Light comes on continuously with the engine running, a malfunction has been detected in the ESC system. If this warning light remains on after several ignition cycles, and the vehicle has been driven several miles (kilometers) at speeds greater than 30 mph (48 km/h), see an authorized dealer as soon as possible to have the problem diagnosed and corrected.

- The ESC OFF Indicator Light and the ESC Indicator Light come on momentarily each time the ignition is placed in the ON/RUN position.
- The ESC system will make buzzing or clicking sounds when it is active. This is normal; the sounds will stop when ESC becomes inactive.
- This light will come on when the vehicle is in an ESC event.

### Electronic Stability Control (ESC) OFF Warning Light — If Equipped



This warning light indicates the ESC is off. Each time the ignition is turned to ON/RUN, the ESC system will be on, even if it was turned off previously.

### Fuel Cutoff Warning Light — If Equipped



This warning light will illuminate after an accident has occurred, and the system has shut the fuel off.

### Fuel Cutoff Failure Warning Light — If Equipped



This light will illuminate if there is a fuel cutoff failure. If this light illuminates, take it to an authorized dealer and have them inspect it.

### Fuel Level Sensor Failure Warning Light



This light illuminates when there is a fuel level sensor failure. If this light illuminates, take it to an authorized dealer and have them inspect it.

### Lane Keep Assist Warning Light — If Equipped



The Lane Keep Assist Warning Light will be solid yellow when the vehicle is approaching a lane marker. The warning light will flash when the vehicle is crossing the lane marker.

### Service Lane Keep Assist Warning Light — If Equipped



This warning light will illuminate when the Lane Keep Assist system is not operating and requires service. Please see an authorized dealer.

### Low Fuel Warning Light



The Low Fuel Warning Light will turn on when low fuel is detected in the fuel tank.

### Engine Check/Malfunction Indicator (MIL) Warning Light



The MIL is a part of an Onboard Diagnostic System called OBD II that monitors engine and automatic transmission control systems.

This warning light will illuminate when the ignition is in the ON/RUN position before engine start. If the bulb does not come on when turning the ignition switch from OFF to ON/RUN, have the condition checked promptly.

Certain conditions, such as a loose or missing gas cap, poor quality fuel, etc., may illuminate the light after engine start. The vehicle should be serviced if the light stays on through several typical driving styles. In most situations, the vehicle will drive normally and will not require towing.

When the engine is running, the MIL may flash to alert serious conditions that could lead to immediate loss of power or severe catalytic converter damage. The vehicle should be serviced by an authorized dealer as soon as possible if this occurs.

#### WARNING!

A malfunctioning catalytic converter can reach higher temperatures than in normal operating conditions. This can cause a fire if you drive slowly or park over flammable substances such as dry plants, wood, cardboard, etc. This could result in death or serious injury to the driver, occupants or others.

#### CAUTION!

Prolonged driving with the Malfunction Indicator Light (MIL) on could cause damage to the vehicle control system. It also could affect fuel economy and drivability. If the MIL is flashing, severe catalytic converter damage and power loss will soon occur. Immediate service is required.

### Keyless Enter 'n Go™/Service Passive Entry Warning Light



The telltale will illuminate in the event of keyless system failure.

Contact an authorized dealer as soon as possible.

### Rain Sensor Failure Light



The telltale will illuminate in the case of failure of the automatic windshield wiper. Contact an authorized dealer as soon as possible.

### Service Forward Collision Warning (FCW) Light — If Equipped



This warning light will illuminate to indicate a fault in the Forward Collision Warning System. Contact an authorized dealer for service → page 176.

### Service Stop/Start System Warning Light — If Equipped



This warning light will illuminate when the Stop/Start system is not functioning properly and service is required. Contact an authorized dealer for service.

### Tire Pressure Monitoring System (TPMS) Warning Light — If Equipped



The warning light switches on and a message is displayed to indicate that the tire pressure is lower than the recommended value and/or that slow pressure loss is occurring. In these cases, optimal tire duration and fuel consumption may not be guaranteed.

Should one or more tires be in the condition mentioned previously, the display will show the indications corresponding to each tire.

#### CAUTION!

Do not continue driving with one or more flat tires as handling may be compromised. Stop the vehicle, avoiding sharp braking and steering. If a tire puncture occurs, repair immediately using the dedicated tire repair kit and contact an authorized dealer as soon as possible.

Each tire, including the spare (if provided), should be checked monthly when cold and inflated to the inflation pressure recommended by the vehicle manufacturer on the vehicle placard or tire inflation pressure label. If your vehicle has tires of a different size than the size indicated on the vehicle placard or tire inflation pressure label, you should determine the proper tire inflation pressure for those tires.

As an added safety feature, your vehicle has been equipped with a TPMS that illuminates a low tire pressure telltale when one or more of your tires is significantly underinflated. Accordingly, when the low tire pressure telltale illuminates, you should stop and check your tires as soon as possible, and inflate them to the proper pressure. Driving on a significantly underinflated tire causes the tire to overheat and can lead to tire failure. Underinflation also reduces fuel efficiency and tire tread life, and may affect the vehicle's handling and stopping ability.

Please note that the TPMS is not a substitute for proper tire maintenance, and it is the driver's responsibility to maintain correct tire pressure, even if underinflation has not reached the level to trigger illumination of the TPMS low tire pressure telltale.

Your vehicle has also been equipped with a TPMS malfunction indicator to indicate when the system is not operating properly. The TPMS malfunction indicator is combined with the low tire pressure telltale. When the system detects a malfunction, the telltale will flash for approximately one minute and then remain continuously illuminated. This sequence will continue upon subsequent vehicle start-ups as long as the malfunction exists. When the malfunction indicator is illuminated, the system may not be able to detect or signal low tire pressure as intended. TPMS malfunctions may occur for a variety of reasons, including the installation of replacement or alternate tires or wheels on the

vehicle that prevent the TPMS from functioning properly. Always check the TPMS malfunction telltale after replacing one or more tires or wheels on your vehicle to ensure that the replacement or alternate tires and wheels allow the TPMS to continue to function properly.

#### CAUTION!

The TPMS has been optimized for the original equipment tires and wheels. TPMS pressures and warning have been established for the tire size equipped on your vehicle. Undesirable system operation or sensor damage may result when using replacement equipment that is not of the same size, type, and/or style. Aftermarket wheels can cause sensor damage. Using aftermarket tire sealants may cause the Tire Pressure Monitoring System (TPMS) sensor to become inoperable. After using an aftermarket tire sealant it is recommended that you take your vehicle to an authorized dealer to have your sensor function checked.

### Towing Hook Breakdown Warning Light — If Equipped



This light illuminates when there is a failure with the tow hook. Contact an authorized dealer for service.

### Traction Battery Cut-off Warning Light — If Equipped



This telltale will turn on to indicate the Traction Battery system is not functioning properly. Contact an authorized dealer if illumination persists.

### Traffic Sign Recognition (TSR) Fault Warning Light



This light will illuminate to indicate a TSR fault. Contact an authorized dealer if the light remains on after restarting the engine.

### Transmission Temperature Warning Light



This warning light will illuminate to warn of a high transmission fluid temperature. This may occur with strenuous usage such as trailer towing. If this light turns on, stop the vehicle and run the engine at idle or slightly faster, with the transmission in PARK or NEUTRAL, until the light turns off. Once the light turns off, you may continue to drive normally.

#### WARNING!

If you continue operating the vehicle when the Transmission Temperature Warning Light is illuminated you could cause the fluid to boil over, come in contact with hot engine or exhaust components and cause a fire.

#### CAUTION!

Continuous driving with the Transmission Temperature Warning Light illuminated will eventually cause severe transmission damage or transmission failure.

## YELLOW INDICATOR LIGHTS

### Exterior Lights Failure Indicator Light



The telltale will illuminate to indicate a failure on the following lights: Daytime Running Lights (DRL)/parking lights/trailer turn signal indicators (if present)/trailer lights (if present)/side lights/turn signal indicators/low beam/reversing light/brake lights/license plate lights.

The failure may be caused by a blown bulb or an interruption of the electrical connection. For bulb replacement ↪ page 257.

### Forward Collision Warning (FCW) Indicator Light — If Equipped



This telltale will turn on to warn you of a possible collision with the vehicle in front of you.

### Forward Collision Warning (FCW) OFF Indicator Light — If Equipped



This indicator light illuminates to indicate that Forward Collision Warning is off.

### Icy Road Condition Indicator Light — If Equipped



This light will illuminate during an icy road condition.

### Immobilizer Fail / VPS Electrical Alarm Warning Light



This telltale will illuminate when the vehicle security system has detected an attempt to break into the vehicle.

#### NOTE:

After cycling the ignition to the ON/RUN position, the Vehicle Security Warning Light could illuminate if a problem with the system is detected. This condition will result in the engine being shut off after two seconds.

## GREEN INDICATOR LIGHTS

### Active Speed Limiter SET Indicator Light



This indicator light will illuminate when the Active Speed Limiter is on and set to a specific speed ↪ page 113.

### Cruise Control SET Indicator Light



This indicator light will illuminate when the Cruise Control is set to the desired speed ↪ page 114.

### Hold 'n Go Indicator Light — If Equipped



Hold 'n Go keeps your vehicle at a complete stop without you having to keep your foot on the brake pedal. Once engaged a green HOLD indicator will appear in the Instrument Cluster Display.

### Automatic Low Beam Indicator Light — If Equipped



This indicator appears when the automatic low beam headlights are on ↪ page 56.

### Parking/Headlights On Indicator Light



This indicator light will illuminate when the parking lights or headlights are turned on.

### Plug Status Indicator Light



When plugged in, the green plug indicator light will illuminate if the Electric Vehicle Supply Equipment (EVSE) charging plug is securely attached to the charging port. This indicates that the plug is detected, but doesn't mean it is charging. It may be accompanied with a cluster message indicating the charge status:

- Plugged In And Charging
- Plugged In And Waiting to Charge On A Set Schedule
- Plugged in and Charging Complete

#### NOTE:

The vehicle cannot be driven until it is unplugged.



## Turn Signal Indicator Lights



When the left or right turn signal is activated, the turn signal indicator will flash independently and the corresponding exterior turn signal lamps will flash. Turn signals can be activated when the multifunction lever is moved down (left) or up (right).

### NOTE:

Check for an inoperative outside light bulb if either indicator flashes at a rapid rate.

## Stop/Start Active Indicator Light — If Equipped



This indicator light will illuminate when the Stop/Start function is in “Autostop” mode.

## E-Boost Engaged Indicator Light



This light alerts the driver that E-Boost mode is currently engaged.

## E-Drive Electric Mode Indicator Light



This indicator light will illuminate to indicate that the vehicle is in E-Drive Electric Mode.

## Ready To Drive Indicator Light



This indicator light will illuminate to indicate that the vehicle has enough power to be driven, regardless of the speed of the vehicle.

## WHITE INDICATOR LIGHTS

### Automatic High Beam Indicator Light — If Equipped



This indicator appears when the automatic high beam headlights are on → page 56.

### Automatic Low Beam Indicator Light — If Equipped



This indicator appears when the automatic low beam headlights are on → page 56.

### E-Boost Unavailable Indicator Light



This light alerts the driver that E-Boost mode is currently unavailable.

### Idle Coasting Indicator Light — If Equipped



The Idle Coasting/Sail feature works by allowing engine speeds to drop to idle, saving fuel. The indicator is only seen when Idle Coasting is chosen and active. In addition, there is indication when this feature is active on the Fuel Economy menu screen on your Instrument Cluster Display.

## BLUE INDICATOR LIGHTS

### High Beam Indicator Light



This indicator light will illuminate to indicate that the high beam headlights are on. With the low beams activated, push the multifunction lever forward (toward the front of the vehicle) to turn on the high beams. Pull the multifunction lever rearward (toward the rear of the vehicle) to turn off the high beams. If the high beams are off, pull the lever toward you for a temporary high beam on, “flash to pass” scenario.

### Automatic High Beam Indicator Light — If Equipped



This indicator shows that the automatic high beam headlights are on → page 56.

## GRAY INDICATOR LIGHTS

### E-Boost Available Indicator Light



This light alerts the driver that E-Boost mode is currently available.

## ONBOARD DIAGNOSTIC SYSTEM — OBD II

Your vehicle is equipped with a sophisticated Onboard Diagnostic system called OBD II. This system monitors the performance of the emissions, engine, and automatic transmission control systems. When these systems are operating properly, your vehicle will provide excellent performance and fuel economy, as well as emissions well within current government regulations.

If any of these systems require service, the OBD II system will turn on the Malfunction Indicator Light (MIL). It will also store diagnostic codes and other information to assist your service technician in making repairs. Although your vehicle will usually be drivable and not need towing, see an authorized dealer for service as soon as possible.

### CAUTION!

- Prolonged driving with the MIL on could cause further damage to the emission control system. It could also affect fuel economy and driveability. The vehicle must be serviced before any emissions tests can be performed.
- If the MIL is flashing while the vehicle is running, severe catalytic converter damage and power loss will soon occur. Immediate service is required.

## ONBOARD DIAGNOSTIC SYSTEM (OBD II) CYBERSECURITY

Your vehicle is required to have an OBD II and a connection port to allow access to information related to the performance of your emissions controls. Authorized service technicians may need to access this information to assist with the diagnosis and service of your vehicle and emissions system.

### WARNING!

- ONLY an authorized service technician should connect equipment to the OBD II connection port in order to read the VIN, diagnose, or service your vehicle.
- If unauthorized equipment is connected to the OBD II connection port, such as a driver-behavior tracking device, it may:
  - Be possible that vehicle systems, including safety related systems, could be impaired or a loss of vehicle control could occur that may result in an accident involving serious injury or death.
  - Access, or allow others to access, information stored in your vehicle systems, including personal information.

## EMISSIONS INSPECTION AND MAINTENANCE PROGRAMS



In some localities, it may be a legal requirement to pass an inspection of your vehicle's emissions control system. Failure to pass could prevent vehicle registration.

For states that require an Inspection and Maintenance (I/M), this check verifies the Malfunction Indicator Light (MIL) is functioning and is not on when the engine is running, and that the OBD II system is ready for testing.

Normally, the OBD II system will be ready. The OBD II system may **not** be ready if your vehicle was recently serviced, recently had a depleted battery or a battery replacement. If the OBD II system should be determined not ready for the I/M test, your vehicle may fail the test.

Your vehicle has a simple ignition actuated test, which you can use prior to going to the test station. To check if your vehicle's OBD II system is ready, you must do the following:

1. Cycle the ignition switch to the ON position, but do not crank or start the engine.

### NOTE:

If you crank or start the engine, you will have to start this test over.

2. As soon as you cycle the ignition switch to the ON position, you will see the Malfunction Indicator Light (MIL) symbol come on as part of a normal bulb check.

3. Approximately 15 seconds later, one of two things will happen:
- The MIL will flash for about 10 seconds and then return to being fully illuminated until you turn OFF the ignition or start the engine. This means that your vehicle's OBD II system is **not ready** and you should **not** proceed to the I/M station.
  - The MIL will not flash at all and will remain fully illuminated until you place the ignition in the off position or start the engine. This means that your vehicle's OBD II system is **ready** and you can proceed to the I/M station.

If your OBD II system is **not ready**, you should see an authorized dealer or repair facility. If your vehicle was recently serviced or had a battery failure or replacement, you may need to do nothing more than drive your vehicle as you normally would in order for your OBD II system to update. A recheck with the previously mentioned test routine may then indicate that the system is **now ready**.

Regardless of whether your vehicle's OBD II system is ready or not, if the MIL is illuminated during normal vehicle operation you should have your vehicle serviced before going to the I/M station. The I/M station can fail your vehicle because the MIL is on with the engine running.

# STARTING AND OPERATING

## STARTING THE ENGINE — GAS

Before starting your vehicle, adjust your seat, adjust both inside and outside mirrors, and fasten your seat belts.

### WARNING!

- When exiting the vehicle, always remove the key fob from the vehicle and lock your vehicle.
- Never leave children alone in a vehicle, or with access to an unlocked vehicle.
- Allowing children to be in a vehicle unattended is dangerous for a number of reasons. A child or others could be seriously or fatally injured. Children should be warned not to touch the parking brake, brake pedal or the transmission gear selector.
- Do not leave the key fob in or near the vehicle, or in a location accessible to children, and do not leave the ignition of a vehicle equipped with Keyless Enter 'n Go™ in the ON/RUN position. A child could operate power windows, other controls, or move the vehicle.
- Do not leave children or animals inside parked vehicles in hot weather. Interior heat buildup may cause serious injury or death.

Start the engine with the gear selector in the NEUTRAL or PARK position. Apply the brake before shifting to any driving range.

## NORMAL STARTING

Place the ignition switch in the START position and release when the engine starts. If the engine fails to start within 10 seconds, place the ignition switch in the OFF position, wait 10 to 15 seconds, then repeat the “Normal Starting” procedure.

### Tip Start Feature

Place the ignition switch in the START position and release it as soon as the starter engages. The starter motor will continue to run, and will automatically disengage itself when the engine is running. If the engine fails to start, place the ignition switch in the OFF position, wait 10 to 15 seconds, then repeat the “Normal Starting” procedure.

## Automatic Transmission

The gear selector must be in the NEUTRAL or PARK position before you can start the engine. Apply the brakes before shifting into any driving gear.

### CAUTION!

Damage to the transmission may occur if the following precautions are not observed:

- Do not shift between PARK, REVERSE, NEUTRAL, or DRIVE when the engine is above idle speed.
- Shift into or out of PARK or REVERSE only after the vehicle has come to a complete stop.
- Before shifting into any gear, make sure your foot is firmly on the brake pedal.

## Keyless Enter 'n Go™ Functions — Using The ENGINE START/STOP Button

1. The transmission must be in PARK or NEUTRAL.
2. Press and hold the brake pedal while pushing the ENGINE START/STOP button once.
3. The system starts the vehicle. If the vehicle fails to start, the starter will disengage automatically after 10 seconds.
4. If you wish to stop the cranking of the engine prior to the engine starting, push the ENGINE START/STOP button again.

## Keyless Enter 'n Go™ — With Driver's Foot Off The Brake Pedal (In PARK Or NEUTRAL Position)

The Keyless Enter 'n Go™ feature operates similar to an ignition switch. It has three positions, OFF, ON/RUN, and START. To change the ignition switch positions without starting the vehicle and use the accessories follow, these steps starting with the ignition switch in the OFF position:

1. Push the ENGINE START/STOP button once to change the ignition switch to the ON/RUN position.
2. Push the ENGINE START/STOP button a second time to change the ignition switch to the OFF position.

## EXTENDED PARK STARTING

### NOTE:

Extended Park condition occurs when the vehicle has not been started or driven for at least 30 days.

1. Install a battery charger or jumper cables to the battery to ensure a full battery charge during the crank cycle.
2. Place the ignition in the START position and release it when the engine starts. For Keyless Enter 'n Go™ ignition systems, press and hold the brake pedal while pushing the ENGINE START/STOP button once.
3. If the engine fails to start within 10 seconds, place the ignition in the OFF position, wait 10 to 15 seconds to allow the starter to cool, then repeat the "Extended Park Starting" procedure.
4. If the engine fails to start after eight attempts, allow the starter to cool for at least 10 minutes, then repeat the procedure.

### CAUTION!

To prevent damage to the starter, do not crank continuously for more than 10 seconds at a time. Wait 10 to 15 seconds before trying again.

## AFTER STARTING — WARMING UP THE ENGINE

The idle speed is controlled automatically and it will decrease as the engine warms up.

## IF ENGINE FAILS TO START

If the engine fails to start after you have followed the "Normal Starting" procedure, and has not experienced an Extended Park condition as identified in "Extended Park Starting" procedure, it may be flooded. Push the accelerator pedal all the way to the floor and hold it there. Crank the engine for no more than 10 seconds. This should clear any excess fuel in case the engine is flooded. Leave the ignition key in the ON/RUN position, release the accelerator pedal and repeat the "Normal Starting" procedure.

### CAUTION!

To prevent damage to the starter, do not continuously crank the engine for more than 10 seconds at a time. Wait 10 to 15 seconds before trying again.

### WARNING!

- Never pour fuel or other flammable liquid into the throttle body air inlet opening in an attempt to start the vehicle. This could result in flash fire causing serious personal injury.
- Do not attempt to push or tow your vehicle to get it started. Vehicles equipped with an automatic transmission cannot be started this way. Unburned fuel could enter the catalytic converter and once the engine has started, ignite and damage the converter and vehicle.
- If the vehicle has a discharged battery, booster cables may be used to obtain a start from a booster battery or the battery in another vehicle. This type of start can be dangerous if done improperly → page 222.

## STOPPING THE ENGINE

### Vehicles Equipped With Electronic Key (Keyless Enter 'n Go™):

To shut off the engine with vehicle speed greater than 5 mph (8 km/h), you must push and hold the ignition or push the ENGINE START/STOP button three times consecutively within a few seconds. The engine will shut down, and the ignition will be placed in the ON/RUN position.

Turning off the car (placing the ignition from the ON/RUN position to the OFF position), the power supply to the accessories are maintained for a period of three minutes.

Opening the driver's side door with the ignition in ON/RUN will sound a short chime that reminds the driver to place the ignition to OFF.

When the ignition is in the OFF position, the window switches remain active for up to 10 minutes. Opening a front door will cancel this function.

After severe driving, idle the engine to allow the temperature inside the engine compartment to cool before shutting off the engine.

## STARTING THE VEHICLE — PHEV

Before starting your vehicle, adjust your seat, adjust both inside and outside mirrors, and fasten your seat belts.

### WARNING!

- Before exiting a vehicle, always come to a complete stop, then shift the automatic transmission into PARK and apply the parking brake.
- Always make sure the ignition is in the OFF position, key fob is removed from the vehicle and vehicle is locked.
- Never leave children alone in a vehicle, or with access to an unlocked vehicle. Leaving children in a vehicle unattended is dangerous for a number of reasons. A child or others could be seriously or fatally injured. Children should be warned not to touch the parking brake, brake pedal or the gear selector.
- Do not leave the key fob in or near the vehicle, or in a location accessible to children, and do not leave the ignition of a vehicle equipped with Keyless Enter 'n Go™ in the ON/RUN position. A child could operate power windows, other controls, or move the vehicle.
- Do not leave children or animals inside parked vehicles in hot weather. Interior heat buildup may cause serious injury or death.

Always start the vehicle with the gear selector in the PARK (P) position. Apply the brake before shifting to any driving range.

In extreme temperatures, high or low, the high voltage battery may need to be conditioned, and therefore may require the vehicle to be plugged in ↪ page 16.

### NOTE:

If the ignition switch does not change with the push of a button, the key fob may have a low or depleted battery. In this situation, a back-up method can be used to operate the ignition switch. Put the key fob against the ENGINE START/STOP button and push to operate the ignition switch.

## NORMAL STARTING

**Achieving vehicle READY using the ENGINE START/STOP button.**

1. The transmission must be in PARK or NEUTRAL.
2. Press and hold the brake pedal while pushing the ENGINE START/STOP button once.
3. The READY indicator will appear in the instrument cluster display when the vehicle is in Ready to Drive mode, which may include the start of the engine depending on conditions such as battery state of charge and engine temperature.
4. If you wish to terminate Ready to Drive mode, push the button again.

**ENGINE START/STOP Button Functions — With Driver's Foot Off The Brake Pedal (In PARK Or NEUTRAL Position)**

The ENGINE START/STOP button operates similar to an ignition switch by providing three positions: OFF, ON/RUN and STOP. To change the ignition position without starting the vehicle (to power certain accessories), follow these steps:

1. Start with the ignition in the OFF position.
2. Push the ENGINE START/STOP button once, without the brake pedal being pressed, to place the ignition in the ON/RUN position.

### NOTE:

The vehicle is not able to be driven in the ON/RUN position, see "Achieving vehicle READY using the ENGINE START/STOP button" previously defined in this section for further information.

3. Push the ENGINE START/STOP button a second time, without the brake pedal being pressed, to return the ignition to the OFF position.

### NOTE:

Only press one pedal at a time while driving the vehicle. Torque performance of the vehicle could be reduced if both pedals are pressed at the same time. If pressure is detected on both pedals simultaneously, a warning message will display in the instrument cluster ↪ page 80.

### NOTE:

Only press one pedal at a time while driving the vehicle. Torque performance of the vehicle could be reduced if both pedals are pressed at the same time. If pressure is detected on both pedals simultaneously, a warning message will display in the instrument cluster.

## AFTER STARTING

To optimize energy efficiency, the vehicle will automatically control engine operation.

## TO TURN OFF THE VEHICLE USING ENGINE START/STOP BUTTON

- Place the gear selector in PARK, then push and release the ENGINE START/STOP button.
- The ignition button indicator will return to the OFF position.
  - If the gear selector is not in PARK, with vehicle speed less than 5 mph (8 km/h), when the ENGINE START/STOP button is pushed, the instrument cluster display will display a "Vehicle Not In Park" message, and the vehicle will remain running.
  - If the gear selector is not in PARK, with vehicle speed greater than 5 mph (8 km/h), when the ENGINE START/STOP button is pushed continuously for at least two seconds (or three short pushes in a row), the vehicle ignition will exit the Ready mode and enter Accessory mode. Never leave a vehicle out of the PARK position, or it could roll.

### NOTE:

- This vehicle is equipped with an automatic shut-down feature. If the vehicle is left in a READY state (vehicle running) with the gear selector in PARK for 30 minutes, the vehicle will automatically turn itself off.

- The vehicle provides automatic notification using a three horn chirp alert, cluster chiming, and a cluster message ("Key Fob Has Left The Vehicle") if the vehicle was not turned off (still "Ready to Drive") and a valid key fob for the vehicle is not detected within the passenger cabin, following the opening and closing of any passenger compartment door (requires all doors to be closed before the key fob check will occur). These automatic alerts are to remind the driver to turn off the vehicle before leaving it, as well as, to let the driver know that the vehicle's key fob may have been unintentionally removed from the vehicle by an exiting passenger. After providing the horn chirp alert, additional auto chirps will be inhibited until the gear selector has been moved out of PARK or ignition cycled.

## ENGINE BREAK-IN RECOMMENDATIONS

A long break-in period is not required for the engine and drivetrain (transmission and axle) in your vehicle.

Drive moderately during the first 300 miles (500 km). After the initial 60 miles (100 km), speeds up to 50 or 55 mph (80 or 90 km/h) are desirable.

While cruising, brief full-throttle acceleration within the limits of local traffic laws contributes to a good break-in. Wide-open throttle acceleration in low gear can be detrimental and should be avoided.

The engine oil installed in the engine at the factory is a high-quality energy conserving type lubricant. Oil changes should be consistent with anticipated climate conditions under which vehicle operations will occur. For the recommended viscosity and quality grades ↪ page 277.

### CAUTION!

Never use Non-Detergent Oil or Straight Mineral Oil in the engine or damage may result.

### NOTE:

A new engine may consume some oil during its first few thousand miles (kilometers) of operation. This should be considered a normal part of the break-in and not interpreted as a problem.

## PARK BRAKE

### ELECTRIC PARK BRAKE (EPB)

Your vehicle is equipped with an EPB system that offers simple operation, and some additional features that make the parking brake more convenient and useful.

The parking brake is primarily intended to prevent the vehicle from rolling while parked. Before leaving the vehicle, make sure that the parking brake is applied. Also, be certain to leave the transmission in PARK.

You can engage the parking brake in two ways:

- Manually, by applying the EPB switch.
- Automatically, by enabling the Auto Park Brake feature in the Customer Programmable Features section of the Uconnect settings ↪ page 149.

The EPB switch is located in the center console.



**Electric Park Brake Switch**

To apply the parking brake manually, pull up on the switch momentarily. You may hear a sound from the back of the vehicle while the parking brake engages. Once the parking brake is fully engaged, the Brake Warning Light in the instrument cluster and an indicator on the switch will illuminate. If your foot is on the brake pedal while you apply the parking brake, you may notice a small amount of brake pedal movement. The parking brake can be applied even when the ignition switch is OFF and can only be released when the ignition switch is in the ON/RUN position.

To release the parking brake manually, the ignition switch must be in the ON/RUN position. Put your foot on the brake pedal, then push the EPB switch down momentarily. You may hear a sound from the back of the car while the parking brake disengages. You may also notice a small amount of movement in the brake pedal. Once the parking brake is fully disengaged, the Brake Warning Light in the instrument cluster and the LED indicator on the switch will extinguish.

**NOTE:**

The EPB Warning Light will illuminate if the EPB switch is held for longer than 60 seconds in either the released or applied position. The light will extinguish upon releasing the switch.

If the Auto Park Brake feature is enabled, the parking brake will automatically engage whenever the transmission is placed into PARK. If your foot is on the brake pedal, you may notice a small amount of brake pedal movement while the parking brake is engaging.

The parking brake will release automatically when the ignition switch is ON/RUN, the transmission is in DRIVE or REVERSE, the driver's seat belt is buckled, and an attempt is made to drive away.

**NOTE:**

When parking on a hill, it is important to turn the front wheels toward the curb on a downhill grade and away from the curb on an uphill grade. Apply the parking brake before placing the gear selector in PARK, otherwise the load on the transmission locking mechanism may make it difficult to move the gear selector out of PARK. The parking brake should always be applied whenever the driver is not in the vehicle.

**WARNING!**

- Do not rely on the parking brake to operate effectively if the rear brakes have been immersed in water or mud.
- Never use the PARK position as a substitute for the parking brake. Always apply the parking brake fully when parked to guard against vehicle movement and possible injury or damage.

*(Continued)*

**WARNING!**

- When leaving the vehicle, always remove the key fob from the ignition and lock your vehicle.
- Never leave children alone in a vehicle, or with access to an unlocked vehicle. Allowing children to be in a vehicle unattended is dangerous for a number of reasons. A child or others could be seriously or fatally injured. Children should be warned not to touch the parking brake, brake pedal or the gear selector.
- Do not leave the key fob in or near the vehicle, or in a location accessible to children, and do not leave the ignition of a vehicle equipped with Keyless Enter 'n Go™ in the ON/RUN position. A child could operate power windows, other controls, or move the vehicle.
- Be sure the parking brake is fully disengaged before driving; failure to do so can lead to brake failure and a collision.
- Always fully apply the parking brake when leaving your vehicle, or it may roll and cause damage or injury. Also be certain to leave the transmission in PARK. Failure to do so may allow the vehicle to roll and cause damage or injury.

**CAUTION!**

If the Brake System Warning Light remains on with the parking brake released, a brake system malfunction is indicated. Have the brake system serviced by an authorized dealer immediately.



If exceptional circumstances should make it necessary to engage the parking brake while the vehicle is in motion, maintain upward pressure on the EPB switch for as long as engagement is desired. The Brake Warning Light will illuminate, and a continuous chime will sound. The rear stop lamps will also be illuminated automatically while the vehicle remains in motion.

To disengage the parking brake while the vehicle is in motion, release the switch. If the vehicle is brought to a complete stop using the parking brake, when the vehicle reaches approximately 3 mph, (5 km/h) the parking brake will remain engaged.

#### WARNING!

Driving the vehicle with the parking brake engaged, or repeated use of the parking brake to slow the vehicle, may cause serious damage to the brake system. Be sure the parking brake is fully disengaged before driving; failure to do so can lead to brake failure and a collision.

In the unlikely event of a malfunction of the EPB system, a yellow EPB Warning Light will illuminate. This may be accompanied by the Brake Warning Light flashing. In this event, urgent service of the EPB system is required. Do not rely on the parking brake to hold the vehicle stationary.

### Auto Park Brake

The EPB can be programmed to be applied automatically whenever the vehicle speed is below 1.9 mph (3 km/h) and the transmission is placed in PARK. Auto Park Brake is enabled and disabled by customer selection through the Customer Programmable Features section of the Uconnect Settings  page 149.

Any single Auto Park Brake application can be bypassed by pushing the EPB switch to the release position while the transmission is placed in PARK and the ignition is in the ON/RUN position.

### SafeHold

SafeHold is a safety feature of the EPB system that will engage the parking brake automatically if the vehicle is left unsecured while the ignition switch is in ON/RUN.

For automatic transmissions, the EPB will automatically engage if all of the following conditions are met:

- Vehicle speed is below 1.9 mph (3 km/h).
- There is no attempt to press the brake pedal and accelerator pedal.
- The seat belt is unbuckled.
- The driver's door is open.
- The vehicle is not in the PARK position.

SafeHold can be temporarily bypassed by pushing the EPB switch while the driver's door is open and the brake pedal is pressed. Once manually bypassed, SafeHold will be enabled again once the vehicle reaches 12 mph (20 km/h) or the ignition is turned to the OFF position and back to ON/RUN again.

### Hold 'N Go— If Equipped

Hold 'N Go is a comfort feature that allows the driver to remove their foot from the brake pedal once the vehicle has come to a stop. The vehicle must be held at a standstill for a predetermined amount of time by hydraulic braking. The EPB will then engage and continue to hold the vehicle at a stop until the driver applies the accelerator pedal. Hold 'N Go is enabled and disabled by customer selection through the customer programmable features section of the Uconnect Settings  page 149.

The following conditions must be met for Hold 'N Go to activate:

- Driver's door is closed
- Driver's seat belt is fastened
- Vehicle is at a standstill
- Forward gear is selected
- EPB is not applied

### Brake Service Mode

We recommend having your brakes serviced by an authorized dealer.

You should only make repairs for which you have the knowledge and the right equipment. You should only enter Brake Service Mode during brake service.

When servicing your rear brakes, it may be necessary for you or your technician to push the rear piston into the rear caliper bore. With the EPB system, this can only be done after retracting the EPB actuator. The actuator retraction can be done easily by entering Brake Service Mode through the Uconnect Settings in your vehicle. This menu-based system will guide you through the steps necessary to retract the EPB actuator in order to perform rear brake service.

Brake Service Mode has requirements that must be met in order to be activated:

- The vehicle must be at a standstill.
- The parking brake must be disabled.
- The transmission must be in PARK or NEUTRAL.
- The EPB switch not activated.
- The vehicle ignition in the ON/RUN position.
- The brake pedal not pressed.

While in Service Mode, the EPB Warning Light will flash continuously while the ignition switch is in ON/RUN.

**NOTE:**

A dedicated message will appear in the instrument cluster display if Brake Service Mode cannot be activated.

When Brake Service Mode work is complete, the following steps must be followed to reset the parking brake system to normal operation:

- Ensure the vehicle is at a standstill.
- Press the brake pedal with moderate force.
- Apply the EPB Switch.

**NOTE:**

A dedicated message will appear in the instrument cluster display if Brake Service Mode cannot be deactivated.

**WARNING!**

You can be badly injured working on or around a motor vehicle. Do only that service work for which you have the knowledge and the right equipment. If you have any doubt about your ability to perform a service job, take your vehicle to a competent mechanic.

**AUTOMATIC TRANSMISSION**

You must press and hold the brake pedal while shifting out of PARK.

**WARNING!**

- Never use the PARK (P) position as a substitute for the parking brake. Always apply the parking brake fully when exiting the vehicle to guard against vehicle movement and possible injury or damage.
- Your vehicle could move and injure you and others if it is not in PARK. Check by trying to move the gear selector out of PARK with the brake pedal released. Make sure the transmission is in PARK before exiting the vehicle.
- It is dangerous to shift out of PARK or NEUTRAL (N) if the engine speed is higher than idle speed. If your foot is not firmly pressing the brake pedal, the vehicle could accelerate quickly forward or in reverse. You could lose control of the vehicle and hit someone or something. Only shift into gear when the engine is idling normally and your foot is firmly pressing the brake pedal.
- The vehicle may not engage a newly selected gear when shifting between PARK, REVERSE (R), or DRIVE (D) if the vehicle is moving while shifting.
- Unintended movement of a vehicle could injure those in or near the vehicle. As with all vehicles, you should never exit a vehicle while the engine is running. Before exiting a vehicle, always come to a complete stop, then apply the parking brake, shift the transmission into PARK, and turn the ignition OFF. When the ignition is in the OFF position, the transmission is locked in PARK, securing the vehicle against unwanted movement.

*(Continued)*

**WARNING!**

- When leaving the vehicle, always make sure the ignition is in the OFF position, remove the key fob from the vehicle, and lock the vehicle.
- Never leave children alone in a vehicle, or with access to an unlocked vehicle. Allowing children to be in a vehicle unattended is dangerous for a number of reasons. A child or others could be seriously or fatally injured. Children should be warned not to touch the parking brake, brake pedal or the transmission gear selector.
- Do not leave the key fob in or near the vehicle (or in a location accessible to children), and do not leave the ignition in the ON/RUN position. A child could operate power windows, other controls, or move the vehicle.

**CAUTION!**

Damage to the transmission may occur if the following precautions are not observed:

- Shift into or out of PARK or REVERSE only after the vehicle has come to a complete stop.
- Do not shift between PARK, REVERSE, NEUTRAL, or DRIVE when the engine is above idle speed.
- Before shifting into any gear, make sure your foot is firmly pressing the brake pedal.

## IGNITION PARK INTERLOCK

This vehicle is equipped with an Ignition Park Interlock which requires the transmission to be in PARK (P) before the ignition can be turned to the OFF position. This helps the driver avoid inadvertently leaving the vehicle without placing the transmission in PARK. This system maintains lock of the transmission in PARK whenever the ignition is in the OFF position.

## BRAKE/TRANSMISSION SHIFT INTERLOCK (BTSI) SYSTEM

This vehicle is equipped with a BTSI that holds the transmission gear selector in PARK (P) unless the brakes are applied. To shift the transmission out of PARK, the ignition must be in the ON/RUN position (whether the engine is running or not), and the brake pedal must be pressed. The brake pedal must also be pressed to shift from NEUTRAL (N) into DRIVE (D) or REVERSE (R) when the vehicle is stopped or moving at low speeds.

## 6-SPEED OR 9-SPEED AUTOMATIC TRANSMISSION

### NOTE:

Your vehicle may be equipped with a 6-speed or 9-speed automatic transmission, depending on model. This section describes operation of both the 6-speed and 9-speed transmissions.

The transmission gear range (PRND) is displayed both beside the gear selector and in the instrument cluster. To select a gear range, push the lock button on the gear selector and move the selector rearward or forward. You must also press the brake pedal to shift the transmis-

sion out of PARK (P) (or NEUTRAL (N), when the vehicle is stopped or moving at low speeds). Select the DRIVE (D) range for normal driving.

### NOTE:

- The transmission electronics are self-calibrating; therefore, the first few shifts on a new vehicle may be somewhat abrupt. This is a normal condition, and precision shifts will develop within a few hundred miles (kilometers).
- In the event of a mismatch between the gear selector position and the actual transmission gear (for example, driver selects REVERSE (R) while driving forward), the position indicator will blink continuously until the selector is returned to the proper position, or the requested shift can be completed.

The electronically controlled transmission adapts its shift schedule based on driver inputs, along with environmental and road conditions.

The 9-speed transmission has been developed to meet the needs of current and future FWD/AWD vehicles. Software and calibration are refined to optimize the customer's driving experience and fuel economy. By design, some vehicle and driveline combinations utilize NINTH gear only in very specific driving situations and conditions.

Only shift from DRIVE to PARK or REVERSE when the accelerator pedal is released and the vehicle is stopped. Be sure to keep your foot on the brake pedal when shifting between these gears.

The transmission gear selector provides PARK, REVERSE, NEUTRAL, DRIVE, and AutoStick (+/-) shift positions. Manual shifts can be made using the AutoStick shift control  page 107. Moving the gear selector into the AutoStick (+/-) position (beside the DRIVE position) activates AutoStick mode, providing

manual shift control and displaying the current gear in the instrument cluster (as 1, 2, 3, etc.). Toggling the gear selector forward (-) or rearward (+) while in the AutoStick position will manually select the transmission gear.

### NOTE:

If the gear selector cannot be moved to the PARK, REVERSE, or NEUTRAL position (when pushed forward) it is probably in the AutoStick (+/-) position (beside the DRIVE position). In AutoStick mode, the transmission gear (1, 2, 3, etc.) is displayed in the instrument cluster. Move the gear selector to the right (into the DRIVE [D] position) for access to PARK, REVERSE, and NEUTRAL.



**Gear Selector**

## Gear Ranges

Do not press the accelerator pedal when shifting out of PARK or NEUTRAL.

### NOTE:

After selecting any gear range, wait a moment to allow the selected gear to engage before accelerating. This is especially important when the engine is cold.

**PARK (P)**

This range supplements the parking brake by locking the transmission. The engine can be started in this range. Never attempt to use PARK while the vehicle is in motion. Apply the parking brake when exiting the vehicle in this range.

When parking on a hill, apply the parking brake before shifting the transmission to PARK, otherwise the load on the transmission locking mechanism may make it difficult to move the gear selector out of PARK. As an added precaution, turn the front wheels toward the curb on a downhill grade and away from the curb on an uphill grade.

When exiting the vehicle, always:

1. Apply the parking brake.
2. Shift the transmission into PARK.
3. Turn the engine off.
4. Remove the key fob from the vehicle.

**NOTE:**

When parking on a steep slope the use of wheel chocks is recommended.

**CAUTION!**

- Before moving the transmission gear selector out of PARK, you must turn the ignition to the ON/RUN position, and also press the brake pedal. Otherwise, damage to the gear selector could result.
- DO NOT race the engine when shifting from PARK or NEUTRAL into another gear range, as this can damage the drivetrain.

The following indicators should be used to ensure that you have properly engaged the transmission into the PARK position:

- When shifting into PARK, push the lock button on the gear selector, and firmly move the selector all the way forward until it stops and is fully seated.
- Look at the transmission gear position display and verify that it indicates the PARK position (P).
- With the brake pedal released, verify that the gear selector will not move out of PARK.

**REVERSE (R)**

This range is for moving the vehicle backward. Shift into REVERSE only after the vehicle has come to a complete stop.

**NEUTRAL (N)**

Use this range when the vehicle is standing for prolonged periods with the engine running. The engine may be started in this range. Apply the parking brake and shift the transmission into PARK if you must exit the vehicle.

**WARNING!**

Do not coast in NEUTRAL and never turn off the ignition to coast down a hill. These are unsafe practices that limit your response to changing traffic or road conditions. You might lose control of the vehicle and have a collision.

**CAUTION!**

Towing the vehicle, coasting, or driving for any other reason with the transmission in NEUTRAL can cause severe transmission damage.

For Recreational Towing → page 146.

For Towing A Disabled Vehicle → page 227.

**DRIVE (D)**

This range should be used for most city and highway driving. It provides the smoothest upshifts and downshifts, and the best fuel economy. The transmission automatically upshifts through all forward gears.

When frequent transmission shifting occurs (such as when operating the vehicle under heavy loading conditions, in hilly terrain, traveling into strong head winds, or while towing a heavy trailer), use the AutoStick shift control to select a lower gear → page 107. Under these conditions, using a lower gear will improve performance and extend transmission life by reducing excessive shifting and heat buildup.

If the transmission temperature exceeds normal operating limits, the transmission controller may modify the transmission shift schedule, reduce engine torque, and/or expand the range of torque converter clutch engagement. This is done to prevent transmission damage due to overheating.

If the transmission becomes extremely hot, the Transmission Temperature Warning Light may illuminate, and the transmission may operate differently until the transmission cools down.

During cold temperatures, transmission operation may be modified depending on engine and/or transmission temperature as well as vehicle speed. This feature improves warm-up time of the engine and transmission to achieve maximum efficiency. Engagement of the torque converter clutch (and, for the 9-speed, shifts into EIGHTH or NINTH gear), are inhibited until the engine and/or transmission is warm. Normal operation will resume once the temperature(s) have risen to a suitable level.

### AUTOSTICK – IF EQUIPPED

AutoStick is a driver-interactive transmission feature providing manual shift control, giving you more control of the vehicle. AutoStick allows you to maximize engine braking, eliminate undesirable upshifts and downshifts, and improve overall vehicle performance. This feature can also provide you with more control during passing, city driving, cold slippery conditions, mountain driving, trailer towing, and many other situations.

#### Operation

In AutoStick mode, you can use the gear selector (in the MANUAL position), or the paddle shifters to the MANUAL (M) position (beside the DRIVE (D) position), or tap one of the paddle shifters on the steering wheel. Tapping the (-) paddle shifter to enter AutoStick mode will downshift the transmission to the next lower gear, while tapping (+) to enter AutoStick mode will retain the current gear. The current transmission gear will be displayed in the instrument cluster.



**Paddle Shifters**

- 1 – (-) Shift Paddle  
2 – (+) Shift Paddle

In AutoStick mode, the transmission will shift up or down when the driver moves the gear selector rearward (+) or forward (-), unless an engine lugging or overspeed condition would result. It will remain in the selected gear until another upshift or downshift is chosen, except as follows:

- 6-speed transmissions will automatically upshift when necessary to prevent engine over-speed.
- The transmission will automatically downshift as the vehicle slows (to prevent engine lugging) and will display the current gear.
- The transmission will automatically downshift to FIRST gear when coming to a stop. After a stop, the driver should manually upshift (+) the transmission as the vehicle is accelerated.
- You can start out, from a stop, in FIRST or SECOND gear (or THIRD gear, in 6-speed models). Tapping (+) (at a stop) will allow starting in SECOND gear. Starting out in SECOND gear can be helpful in snowy or icy conditions.
- If a requested downshift would cause the engine to overspeed, that shift will not occur.
- The system will ignore attempts to upshift at too low of a vehicle speed.
- Transmission shifting will be more noticeable when AutoStick is enabled.
- Holding the (-) paddle pressed, or holding the gear selector in the (-) position, will downshift the transmission to the lowest gear possible at the current speed.
- The system may revert to automatic shift mode if a fault or overheat condition is detected.

To disengage AutoStick mode, return the gear selector to the DRIVE (D) position, or press and hold the (+) paddle shifter until "D" is indicated in the instrument cluster. You can shift in or out of AutoStick mode at any time without taking your foot off the accelerator pedal.

#### **WARNING!**

Do not downshift for additional engine braking on a slippery surface. The drive wheels could lose their grip and the vehicle could skid, causing a collision or personal injury.

## TRANSMISSION LIMP HOME MODE

Transmission function is monitored electronically for abnormal conditions. If a condition is detected that could result in transmission damage, Transmission Limp Home Mode is activated. In this mode, the transmission may operate only in a fixed gear, or may remain in NEUTRAL (N). The Malfunction Indicator Light (MIL) may be illuminated. Limp Home Mode may allow the vehicle to be driven to an authorized dealer for service without damaging the transmission.

In the event of a momentary problem, the transmission can be reset to regain all forward gears by performing the following steps:

1. Stop the vehicle.
2. Shift the transmission into PARK (P), if possible. If not, shift the transmission to NEUTRAL.
3. Push and hold the ignition until the engine turns off.
4. Wait approximately 30 seconds.
5. Restart the engine.
6. Shift into the desired gear range. If the problem is no longer detected, the transmission will return to normal operation.

### NOTE:

Even if the transmission can be reset, we recommend that you visit an authorized dealer at your earliest possible convenience. An authorized dealer has diagnostic equipment to assess the condition of your transmission. If the transmission cannot be reset, authorized dealer service is required.

## TORQUE CONVERTER CLUTCH

A feature designed to improve fuel economy has been included in the automatic transmission on your vehicle. A clutch within the torque converter engages automatically at calibrated speeds. This may result in a slightly different feeling or response during normal operation in the upper gears. When the vehicle speed drops or during some accelerations, the clutch automatically disengages.

### NOTE:

The torque converter clutch will not engage until the engine and/or transmission is warm (usually after 1 to 3 miles [2 to 5 km] of driving). Because the engine speed is higher when the torque converter clutch is not engaged, it may seem as if the transmission is not shifting properly when the vehicle is cold. This is normal. The torque converter clutch will function normally once the powertrain is sufficiently warm.

## ALL-WHEEL DRIVE (AWD)

This feature provides on-demand All-Wheel Drive (AWD). The system is automatic with no driver inputs or additional driving skills required. Under normal driving conditions, the front wheels provide most of the traction. If the front wheels begin to lose traction, power is shifted automatically to the rear wheels. The greater the front wheel traction loss, the greater the power transfer to the rear wheels.

Additionally, on dry pavement under heavy throttle input (where one may have no wheel spin), torque will be sent to the rear in a preemptive effort to improve vehicle launch and performance characteristics.

### CAUTION!

All wheels must have the same size and type tires. Unequal tire sizes must not be used. Unequal tire size may cause failure of the power transfer unit.

## ELECTRIC POWER STEERING (EPS)

The electric power steering system will provide increased vehicle response and ease of maneuverability. The electric power steering system adapts to different driving conditions.

### WARNING!

Continued operation with reduced assist could pose a safety risk to yourself and others. Service should be obtained as soon as possible.



If the “HAVE POWER STEERING CHECKED”, “SERVICE POWER STEERING” or “POWER STEERING ASSIST OFF - SERVICE SYSTEM” message and a steering wheel icon display on the instrument cluster, it indicates that the vehicle needs service. It may be necessary to perform a Steering Lock-to-Lock Steering Calibration maneuver by turning the steering wheel from full left position to full right position. If the problem is still present, take the vehicle to an authorized dealer for service. It is likely the vehicle has lost power steering assistance

↩ page 84.

### Performing Lock-to-Lock Steering Angle Calibration

1. Start the engine.
2. With the wheels initially in a straight forward tire position, turn the steering wheel to the full right lock position, do not apply any pressure and hold for approximately 5 seconds until feeling kickback from the steering wheel.
3. Then turn the steering wheel to the full left lock position, do not apply any pressure and hold for approximately 5 seconds until feeling kickback from the steering wheel.
4. Return the steering wheel to the straight forward tire position and set the ignition to the OFF position, wait for all lights to turn off on the instrument cluster.
5. Then set the ignition to the ON position.

The steering angle calibration should now be calibrated. If an EPS warning message/indicator light persists, please see an authorized dealer for service.



If the “POWER STEERING SYSTEM HOT - PERFORMANCE MAY BE LIMITED” message and a steering wheel icon display on the instrument cluster, it indicates that extreme steering maneuvers may have occurred, which caused an over temperature condition in the electric power steering system. You will lose power steering assistance momentarily until the over temperature condition no longer exists. Once driving conditions are safe, pull over and let the vehicle idle for a few moments until the light turns off ↩ page 80.

### NOTE:

- Even if the power steering system is no longer operational, it is still possible to steer the vehicle. Under these conditions there will be a substantial increase in steering effort, especially at low speeds and during parking maneuvers.
- If the condition persists, see an authorized dealer for service.

## ALFA DNA SELECTOR — GAS

### ALFA DNA SYSTEM

This vehicle is equipped with an Alfa DNA system selector (located on the center console). There are up to three modes of operation to be selected according to driving style and road conditions:



Alfa DNA System Selector

- d = Dynamic (sports driving).
- n = Natural (driving in normal conditions).
- a = Stop/Start OFF.
-  = Adjusts the calibration of the active suspension (if equipped).

When the engine is stopped, the selector returns to “n” Natural Mode.

The symbol for the active mode illuminates red on the selector.

On the instrument cluster display, the different modes are characterized by different colors:

- Dynamic = Red
- Natural = Blue
- Stop/Start OFF = Green

Each Drive Mode's Performance screen is graphically different in frame color and content.

## DRIVING MODES

### Dynamic Mode

To activate Dynamic Mode rotate the selector to the letter “d”; the display will illuminate red.

The Traction Control System (TCS), Anti-Spin Regulation (ASR), Brakes Lock Differential (BLD) and Electronic Stability Control (ESC) systems have intervention thresholds that ensure more enjoyable, sportier driving while guaranteeing the stability of the vehicle.

The engine and transmission adopt a sports mapping.

### WARNING!

In Dynamic Mode, the sensitivity of the accelerator pedal increases considerably. Consequently, driving is less fluid and comfortable. The driver must ensure full control of the vehicle at all times to avoid a collision.

The Performance screen displays parameters related to vehicle stability, the graphs illustrate the trend of the longitudinal/lateral accelerations (G-meter information), considering gravity acceleration as a reference unit.

Lateral acceleration peaks are displayed on the right.

#### Natural Mode

Natural Mode is characterized by reduced engine performance and ECO shifting strategies for the automatic transmission.

To activate Natural Mode rotate the selector to the letter “n”; the display will illuminate blue.

The Performance screen shows the average and instantaneous fuel consumptions.

#### Stop/Start OFF Mode

To activate Stop/Start OFF Mode rotate the selector to the letter “a”; the display will illuminate green.

When in this mode the Stop/Start system will be deactivated.

#### Driving Mode Deactivation

To deactivate any Drive Mode, simply move the selector to any other mode.

#### NOTE:

The DNA selector will return to Natural Mode on every ignition off cycle regardless of which mode was selected during the drive cycle.

## ALFA DNA SELECTOR — HYBRID

### ALFA DNA SYSTEM

This vehicle is equipped with an Alfa DNA system selector (located on the center console). There are three modes of operation to select according to driving style and road conditions:



Alfa DNA System Selector

- d = Dynamic (sports driving).
- n = Natural (driving in normal conditions).
- a = Advanced Efficiency (electric only mode).
-  = Adjusts the calibration of the active suspension (if equipped).

When the ignition is cycled to OFF, the selector returns to “n” Natural, unless “a” Advanced Efficiency was previously selected.

The symbol for the active mode illuminates red on the selector.

On the instrument cluster display, the different modes are characterized by different colors:

- Dynamic = Red
- Natural = Blue
- Advanced Efficiency = Green

Each Drive Mode's Performance screen is graphically different in frame color and content.

### DRIVING MODES

#### Dynamic Mode

To activate Dynamic Mode rotate the selector to the letter “d”; the display will illuminate red.

Dynamic Mode uses both the electric motor and the gas engine to provide a sporty driving performance by sharpening the throttle responses, adjusting higher transmission shifts and increasing the regenerative power during decelerations.

#### WARNING!

In Dynamic Mode, the sensitivity of the accelerator pedal increases considerably. Consequently, driving is less fluid and comfortable. The driver must ensure full control of the vehicle at all times to avoid a collision.

#### Natural Mode

To activate Natural Mode rotate the selector to the “n”; the display will illuminate blue.



Natural Mode uses both the electric motor and gas engine to optimize power and minimize fuel consumption. This mode will maximize the use of the high voltage battery until the battery reaches the minimum charge level and then the gasoline engine will be used to power the vehicle.

The Performance screen shows the average and instantaneous fuel consumptions. This screen also displays parameters related to vehicle stability, the graphs illustrate the trend of the longitudinal/lateral accelerations (G-meter information), considering gravity acceleration as a reference unit.

Lateral acceleration peaks are displayed on the right.

#### Advanced Efficiency Mode

To activate Advanced Efficiency Mode rotate the selector the letter “a”; the display will illuminate green.

Advanced Efficiency Mode will use electric motor and battery power only, provided there is a sufficient state of charge. Advanced Efficiency Mode is ideal for city driving and in traffic situations.

- The system will automatically switch to Natural Mode under full throttle accelerations or when the battery state of charge is low.
- The DNA selector will remain in Advanced Efficiency Mode after ignition OFF cycle provided certain criteria has been met (driving style, battery temperature, etc..) otherwise the system will return to “n” or Natural Mode.

## ALFA ACTIVE SUSPENSION (AAS) — IF EQUIPPED

The vehicle's electronic suspension management system is aimed at optimizing the vehicle's performance.

The system continuously monitors the damping of the suspension through the actuator installed on each shock absorber. This way, the calibration of the shock absorbers can be adjusted to the conditions of the road surface and to the dynamic conditions of the vehicle, improving its comfort and road holding.

The driver can choose, even while driving (only in “Dynamic” mode), between two types of suspension calibration: a sportier or a more comfortable one.

By pushing the button, the system changes the shock absorber calibration.



**Alfa Active Suspension Button**

In case of a system failure, the shock absorber symbol will illuminate on the button and a dedicated message will appear in the instrument cluster display.

## STOP/START SYSTEM — IF EQUIPPED

The Stop/Start function is designed to reduce fuel consumption. The system will stop the engine automatically during a vehicle stop if the required conditions are met. Releasing the brake pedal or pressing the accelerator pedal will automatically restart the engine.

This vehicle has been upgraded with a heavy-duty starter, enhanced battery, and other upgraded engine parts, to handle the additional engine starts.

### AUTOSTOP MODE

The Stop/Start feature is enabled after every normal customer engine start. At that time, the system will go into STOP/START READY.

**To Activate The Autostop Mode, The Following Must Occur:**

- The system must be in STOP/START READY state. A “STOP/START READY” message will be displayed in the instrument cluster display within the Stop/Start section ↪ page 80.
- The vehicle must be completely stopped.
- The gear selector must be in a forward gear and the brake pedal pressed.

The engine will shut down, the tachometer will move to the zero position, and the Stop/Start telltale will illuminate indicating you are in Autostop. Customer settings will be maintained upon return to an engine-running condition.

## POSSIBLE REASONS THE ENGINE DOES NOT AUTOSTOP

Prior to engine shut down, the system will check many safety and comfort conditions to see if they are fulfilled. Detailed information about the operation of the Stop/Start system may be viewed in the instrument cluster display Stop/Start Screen. In the following situations the engine will not stop:

- Driver's seat belt is not buckled.
- Driver's door is not closed.
- Battery temperature is too warm or cold.
- Battery charge is low.
- The vehicle is on a steep grade.
- Cabin heating or cooling is in process and an acceptable cabin temperature has not been achieved.
- HVAC is set to full defrost mode at a high blower speed.
- HVAC is set to MAX A/C.
- Engine has not reached normal operating temperature.
- The transmission is not in a forward gear.
- Hood is open.
- Brake pedal is not pressed with sufficient pressure.
- Accelerator pedal input.
- Engine temperature is too high.
- 5 mph (8 km/h) threshold has not been achieved from previous Autostop.
- Steering angle beyond threshold.
- Adaptive Cruise Control is on and speed is set.

It may be possible for the vehicle to be driven several times without the Stop/Start system going into a STOP/START READY state under more extreme conditions of the items listed previously.

## TO START THE ENGINE WHILE IN AUTOSTOP MODE

While in a forward gear, the engine will start when the brake pedal is released or the accelerator pedal is pressed. The transmission will automatically re-engage upon engine restart.

### Conditions That Will Cause The Engine To Start Automatically While In Autostop Mode:

- The transmission selector is moved out of DRIVE (D).
- To maintain cabin temperature comfort.
- HVAC is set to full defrost mode.
- HVAC system temperature or fan speed is manually adjusted.
- Battery voltage drops too low.
- Stop/Start OFF switch is pressed.
- A Stop/Start system error occurs.
- Steering wheel is turned beyond threshold.

### Conditions That Force An Application Of The Electric Park Brake While In Autostop Mode:

- The driver's door is open and brake pedal released.
- The driver's door is open and the driver's seat belt is unbuckled.
- The engine hood has been opened.
- A Stop/Start system error occurs.

If the Electric Park Brake (EPB) is applied with the engine off, the engine may require a manual restart and the EPB may require a manual release (press brake pedal and press EPB switch) → page 80.

## TO MANUALLY TURN OFF THE STOP/START SYSTEM

Rotate the Alfa DNA Selector to the letter "a" position to turn off the Stop/Start system. The light on the switch will illuminate. The "STOP/START OFF" message will appear in the instrument cluster display and the Autostop mode will be disabled → page 80.

### NOTE:

The Stop/Start system will reset itself back to an ON condition every time the ignition is turned off and back on.

## TO MANUALLY TURN ON THE STOP/START SYSTEM

Rotate the Alfa DNA Selector to any other mode to turn Stop/Start back on.

## SYSTEM MALFUNCTION

If there is a malfunction in the Stop/Start system, the system will not shut down the engine. A "SERVICE STOP/START SYSTEM" message and a yellow Stop/Start telltale will appear in the instrument cluster display → page 80.

If the "SERVICE STOP/START SYSTEM" message appears in the instrument cluster display, have the system checked by an authorized dealer.

## ACTIVE SPEED LIMITER — IF EQUIPPED

This feature allows you to program the maximum speed of travel for your vehicle.

The Active Speed Limiter is turned on/off using the Mode button located on the left side of the steering wheel.



Mode Button

### NOTE:

- The Mode button also activates the Adaptive Cruise Control (ACC) system. Pushing the Mode button will switch between activating the Active Speed Limiter or the Adaptive Cruise Control systems. They cannot be active at the same time.
- The Active Speed Limiter can be set while the vehicle is in motion, or with the gear selector in the PARK position.

## ACTIVATION

To activate the feature, push the Mode button located on the left side of the steering wheel. A white indicator light in the instrument cluster display to signal that Active Speed Limiter has been enabled.

After the Active Speed Limiter system is enabled, activate the system by setting the speed limit of the vehicle by pushing the SET switch upward or downward.

Pushing the SET switch upward or downward to the first detent, and releasing, will result in a 1 mph (1 km/h) speed adjustment. Each subsequent movement of the switch to the first detent will result in an adjustment of 1 mph (1 km/h).

If the switch is pushed upward or downward briefly to the second detent, the set speed will adjust in 5 mph (10 km/h) increments. The new set speed is reflected in the instrument cluster display.

If the switch is held upward or downward, the set speed will continue to adjust until the switch is released.

### NOTE:

- Once the speed has been set, the indicator light in the instrument cluster display will change to green.
- If Adaptive Cruise Control (ACC) or the Active Speed Limiter is active when the ignition is placed in the OFF position, it will remain activated when the vehicle is started again.
- ACC will be unavailable while the Active Speed Limiter is in use.

## EXCEEDING THE SET SPEED

By fully pressing the accelerator pedal, the programmed maximum speed can be exceeded while the device is active.

In the event that the Active Speed Limiter set value is exceeded manually with a driver acceleration, an audible chime will sound. The indicator light will flash rapidly, and a message will appear in the instrument cluster display.

The feature will remain disabled until the vehicle speed drops below the set Active Speed Limiter value, where it will reactivate automatically.

### NOTE:

While driving at a higher speed than previously set, the set limit can be updated by pushing the SET switch upward or downward to the new desired speed.

## DEACTIVATION

To turn off Active Speed Limiter, push the Mode button again. The indicator light in the instrument cluster display will no longer be illuminated to confirm that the feature has been turned off, and Adaptive Cruise Control will be active.

The Active Speed Limiter can be deactivated by pressing the CANC button. In this case, the system is not completely turned off, and the driver can reactivate the Active Speed Limiter by pressing the RES button to the previously set speed.

## INTELLIGENT SPEED ASSIST (ISA) — IF EQUIPPED



The Intelligent Speed Assist (ISA) system combines the Active Speed Limiter and Traffic Sign Recognition (TSR) systems to automatically adjust the maximum speed of the vehicle based on detected speed limit signs.

When the ISA system is activated, the maximum speed of the vehicle will be adjusted according to the detected traffic signs depending on the Sign Capture Mode selected within Uconnect Settings → page 149.

### ACTIVATION

To activate the feature, make sure the Traffic Sign Recognition (TSR), and Intelligent Speed Assist (ISA) systems are both enabled within Uconnect Settings → page 149, then activate the Active Speed Limiter system by pushing the Mode button located on the left of the steering wheel.

The white ISA indicator light in the instrument cluster display will illuminate to signal that the system has been enabled, but not yet detected a speed limit sign.

#### NOTE:

Adaptive Cruise Control will be unavailable while the ISA system is in use.

### SIGN CAPTURE MODES

The way in which the ISA system sets a new maximum vehicle speed depends on the Sign Capture Mode set within the Uconnect system. When a new maximum speed limit is set, the ISA indicator light in the instrument cluster display will change from white to green.

#### Confirmation Mode

When Confirmation Mode is selected, and the Traffic Sign Recognition (TSR) system detects a new speed limit sign, the driver will confirm this new speed by pushing the SET switch upward briefly, then releasing. This confirmation of the new speed must be done within five seconds of a newly detected speed limit sign being shown in the instrument cluster display.

#### Automatic Mode

When Automatic Mode is selected, the ISA system will automatically adjust the maximum vehicle speed when the TSR system detects a new speed limit sign. The new speed is shown in the instrument cluster display.

The driver can reject this new speed by pushing the SET switch upward briefly, then releasing within five seconds of the new speed limit sign being detected and the speed being adjusted.

#### NOTE:

If a newly detected speed limit sign indicates a speed higher or lower than the current maximum speed limit of the Active Speed Limiter system, a message along with an up arrow or a down arrow will appear in the instrument cluster display to alert the driver.

### EXCEEDING THE SET SPEED

By fully pressing the accelerator pedal, the maximum set speed of the vehicle can be exceeded while the system is active.

When the maximum set speed is exceeded, the green indicator light on the instrument cluster display will blink until the accelerator pedal is released and the vehicle speed drops below the previously set maximum vehicle speed. The ISA system will then resume normal operation.

### DEACTIVATION

The ISA system will deactivate in the following situations:

- When the Mode button is pushed again
- When the TSR system is deactivated
- When the TSR system cannot detect/display any speed limit
- When the TSR system detects the end of the speed limit zone

### CRUISE CONTROL SYSTEMS

Your vehicle is equipped with the Adaptive Cruise Control (ACC) system. ACC will adjust the vehicle speed up to the preset speed to maintain a distance with the vehicle ahead.

#### NOTE:

If Active Speed Limiter is enabled, Adaptive Cruise Control will be unavailable, and vice versa.

### ADAPTIVE CRUISE CONTROL (ACC)

Adaptive Cruise Control (ACC) increases the driving convenience provided by Cruise Control while traveling on highways and major roadways. However, it is not a safety system and not designed to prevent collisions.

ACC will allow you to keep Cruise Control engaged in light to moderate traffic conditions without the constant need to reset your speed. ACC utilizes a radar sensor and a forward facing camera designed to detect a vehicle directly ahead of you to maintain a set speed.

**NOTE:**

- If the ACC sensor detects a vehicle ahead, ACC will apply limited braking or accelerate (not to exceed the original set speed) automatically to maintain a preset following distance, while matching the speed of the vehicle ahead.
- Any chassis/suspension or tire size modifications to the vehicle will affect the performance of the Adaptive Cruise Control and Forward Collision Warning system.

**WARNING!**

- Adaptive Cruise Control (ACC) is a convenience system. It is not a substitute for active driver involvement. It is always the driver's responsibility to be attentive to road, traffic, and weather conditions, vehicle speed, distance to the vehicle ahead and, most importantly, brake operation to ensure safe operation of the vehicle under all road conditions. Your complete attention is always required while driving to maintain safe control of your vehicle. Failure to follow these warnings can result in a collision and death or serious personal injury.
- The ACC system:
  - Does not react to pedestrians, oncoming vehicles, and stationary objects (e.g., a stopped vehicle in a traffic jam or a disabled vehicle).
  - Cannot take street, traffic, and weather conditions into account, and may be limited by adverse sight distance conditions.
  - Does not always fully recognize complex driving conditions, which can result in wrong or missing distance warnings.

*(Continued)***WARNING!**

You should turn the ACC system off:

- When driving in fog, heavy rain, heavy snow, sleet, heavy traffic, and complex driving situations (i.e., in highway construction zones).
- When entering a turn lane or highway off-ramp; when driving on roads that are winding, icy, snow-covered, slippery, or have steep uphill or downhill slopes.
- When towing a trailer up or down steep slopes.
- When circumstances do not allow safe driving at a constant speed.

**Adaptive Cruise Control (ACC) Operation**

The buttons on the left side of the steering wheel operate the ACC system.

**Adaptive Cruise Control Buttons**

- 1 — RES/Resume Button
- 2 — SET (+/-) Switch
- 3 — Mode Button
- 4 — CANC/Cancel Button
- 5 — Distance Setting Button

**Adaptive Cruise Control (ACC) System Status**

The instrument cluster display will show the current ACC system settings. The information it displays depends on ACC system status.

Push the Mode button to enable the ACC system.

**Adaptive Cruise Control Off**

When ACC is deactivated, all ACC visualizations will not be shown in the instrument cluster display.

**Adaptive Cruise Control Ready**

When ACC is activated, but the vehicle speed setting has not been selected, the white ACC icon will illuminate above dashes in place of a speed in the instrument cluster display.

**Adaptive Cruise Control Set**

When the vehicle has reached the desired speed, push the SET switch up or down briefly, then release. When the ACC speed is set, the green ACC icon over the set speed will illuminate in the instrument cluster display. When the ACC menu screen is not being viewed in the instrument cluster display, a green triangle will illuminate on the speedometer at the location of the set speed.

**NOTE:**

If the ACC system is canceled or paused, the triangle on the speedometer will change to white, indicating the saved set speed for when the RES button pushed.

## Activating Adaptive Cruise Control (ACC)

The minimum set speed for the ACC system is 19 mph (30 km/h).

### NOTE:

You cannot engage ACC under the following conditions:

- When the brakes are applied
- When the parking brake is applied
- When the gear selector is in PARK, REVERSE or NEUTRAL
- When the vehicle speed is below the minimum speed range
- When the brakes are overheated
- When the driver's door is open at low speeds
- When the driver's seat belt is unbuckled at low speeds
- When there is a stationary vehicle in front of your vehicle in close proximity

## To Activate/Deactivate

Push and release the Mode button located on the left side of the steering wheel to activate ACC. Then proceed to setting the desired speed as described in the next section.

### NOTE:

Active Speed Limiter will be unavailable while ACC is in use.

To turn the system off, push and release the Mode button again. At this time, the system will turn off and Active Speed Limiter will be active.

The system will also turn off during any of the conditions listed in "To Turn Off" ↩ page 116.

### WARNING!

Leaving the Adaptive Cruise Control (ACC) system on when not in use is dangerous. You could accidentally set the system or cause it to go faster than you want. You could lose control and have a collision. Always leave the system off when you are not using it.

## To Set A Desired Speed

When the vehicle has reached the desired speed, push the SET switch up or down briefly, then release. The instrument cluster display will show the set speed.

### WARNING!

If the Active Speed Limiter is active, the system will not react to vehicles ahead. In addition, the proximity warning does not activate and no alarm will sound even if you are too close to the vehicle ahead since neither the presence of the vehicle ahead nor the vehicle-to-vehicle distance is detected. Be sure to maintain a safe distance between your vehicle and the vehicle ahead. Always be aware which mode is selected.

If ACC is set when the vehicle speed is **below** 19 mph (30 km/h), the set speed will default to 19 mph (30 km/h).

If either system is set when the vehicle speed is **above** 19 mph (30 km/h), the set speed shall be the current speed of the vehicle.

### NOTE:

- Keeping your foot on the accelerator pedal can cause the vehicle to continue to accelerate beyond the set speed.
- If you continue to accelerate beyond the set speed while ACC is enabled, the system will not be controlling the distance between your vehicle and the vehicle ahead. The vehicle speed will only be determined by the position of the accelerator pedal.

## To Cancel

The following conditions cancel ACC:

- The brake pedal is applied
- The CANCEL (cancel) button is pushed
- The Anti-Lock Brake System (ABS) activates
- The gear selector is removed from the DRIVE position
- The Electronic Stability Control/Traction Control System (ESC/TCS) activates
- The vehicle parking brake is applied
- The braking temperature exceeds normal range (overheated)
- Driver seat belt is unbuckled at low speeds
- Driver door is opened at low speeds

## To Turn Off

The system will turn off and clear the set speed in memory if:

- The Mode button is pushed
- The ignition is placed in the OFF position

## To Resume

If ACC was canceled, and there is a set speed in memory, push the RES (resume) button and remove your foot from the accelerator pedal. The instrument cluster display will show the last set speed.

Resume can be used at any speed above 0 mph (0 km/h) when ACC is active.

### NOTE:

ACC cannot be resumed if there is a stationary vehicle in front of your vehicle in close proximity.

### WARNING!

The Resume function should only be used if traffic and road conditions permit. Resuming a set speed that is too high or too low for prevailing traffic and road conditions could cause the vehicle to accelerate or decelerate too sharply for safe operation. Failure to follow these warnings can result in a collision and death or serious personal injury.

## To Vary The Speed Setting

### To Increase Or Decrease The Set Speed

After setting a speed, you can adjust the speed by pushing the SET switch upward or decrease the speed by pushing the SET switch downward.

#### U.S. Speed (mph)

- Pushing the SET switch upward or downward to the first detent will result in a 1 mph speed adjustment. Each subsequent movement of the switch to the first detent will result in an adjustment of 1 mph.

- If the switch is pushed upward or downward briefly to the second detent, the set speed will adjust in 5 mph increments. The new set speed is reflected in the instrument cluster display.
- If the switch is held upward or downward, the set speed will continue to adjust until the switch is released.

#### Metric Speed (km/h)

- Pushing the SET switch upward or downward to the first detent will result in a 1 km/h speed adjustment. Each subsequent movement of the switch to the first detent will result in an adjustment of 1 km/h.
- If the switch is pushed upward or downward briefly to the second detent, the set speed will adjust in 10 km/h increments. The new set speed is reflected in the instrument cluster display.
- If the switch is held upward or downward, the set speed will continue to adjust until the switch is released.

### NOTE:

- When you override the set speed by pushing the SET switch upward or downward, the new set speed will be the current speed of the vehicle.
- When you use the SET switch to decelerate, if the engine's braking power does not slow the vehicle sufficiently to reach the set speed, the brake system will automatically slow the vehicle.

- The ACC system maintains set speed when driving uphill and downhill. However, a slight speed change on moderate hills is normal. In addition, downshifting may occur while climbing uphill or descending downhill. This is normal operation and necessary to maintain set speed. When driving uphill and downhill, the ACC system will cancel if the braking temperature exceeds normal range (overheated).

## TO ACCELERATE FOR PASSING

While the Cruise Control is set, press the accelerator to pass as you would normally. When the pedal is released, the vehicle will return to the set speed.

### Using Cruise Control On Hills

The transmission may downshift on hills to maintain the vehicle set speed.

The Cruise Control system maintains speed up and down hills. A slight speed change on moderate hills is normal. On steep hills, a greater speed loss or gain may occur so it may be preferable to drive without Cruise Control.

### WARNING!

Cruise Control can be dangerous where the system cannot maintain a constant speed. Your vehicle could go too fast for the conditions, and you could lose control and have an accident. Do not use Cruise Control in heavy traffic or on roads that are winding, icy, snow-covered or slippery.

## Setting The Following Distance In ACC

The specified following distance for ACC can be set by varying the distance setting between four bars (longest), three bars (long), two bars (medium) and one bar (short). Using this distance setting and the vehicle speed, ACC calculates and sets the distance to the vehicle ahead. This distance setting will show in the instrument cluster display.



**Distance Settings**

- 1 — Longest Distance Setting (Four Bars)
- 2 — Medium Distance Setting (Two Bars)
- 3 — Long Distance Setting (Three Bars)
- 4 — Short Distance Setting (One Bar)

To decrease the distance setting, push the Distance Setting Button and release. Each time the button is pushed, the distance setting increases by one bar (longer). Once the longest setting is reached, if the button is pushed again it will be set to the shortest setting available.

If a slower moving vehicle is detected in the same lane, the system will then adjust vehicle speed automatically to maintain the distance setting, regardless of the set speed.

The vehicle will then maintain the set distance until:

- The vehicle ahead accelerates to a speed above the set speed.
- The vehicle ahead moves out of your lane or view of the sensor.
- The distance setting is changed.
- The system disengages → page 116.

The maximum braking applied by ACC is limited; however, the driver can always apply the brakes manually, if necessary.

### NOTE:

The brake lights will illuminate whenever the ACC system applies the brakes.

A Proximity Warning will alert the driver if ACC predicts that its maximum braking level is not sufficient to maintain the set distance. If this occurs, a visual alert "BRAKE!" (or similar warning message) will flash in the instrument cluster display and a chime will sound while ACC continues to apply its maximum braking force.

### NOTE:

The "BRAKE!" screen in the instrument cluster display is a warning for the driver to take action and does not necessarily mean that the Forward Collision Warning system is applying the brakes autonomously.

## Overtake Aid

When driving with Adaptive Cruise Control (ACC) engaged and following a vehicle, the system will provide an additional acceleration up to the ACC set speed to assist in passing the vehicle. This additional acceleration is triggered when the driver utilizes the left turn signal and will only be active when passing on the left hand side.

## Display Warnings And Maintenance

### LIMITED OPERATION WARNING

If a warning message appears in the instrument cluster display indicating limited operation of the ACC system, a fault or obstruction of the system's radar or camera may have occurred.

If an obstruction is detected, clean the area of the windshield opposite the interior rearview mirror, where the camera is located, as well as the area of the front fascia/bumper where the sensor is located. Then check that the message has disappeared.

When the conditions limiting the system function as been corrected, normal operation will resume.

Should the fault persist, contact an authorized dealer.



## Precautions While Driving With ACC

In certain driving situations, ACC may have detection issues. In these cases, ACC may brake late or unexpectedly. The driver needs to stay alert and may need to intervene. The following are examples of these types of situations:

### TOWING A TRAILER

Towing a trailer is not recommended when using ACC.

### OFFSET DRIVING

ACC may not detect a vehicle in the same lane that is offset from your direct line of travel, or a vehicle merging in from a side lane. There may not be sufficient distance to the vehicle ahead. The offset vehicle may move in and out of the line of travel, which can cause your vehicle to brake or accelerate unexpectedly.

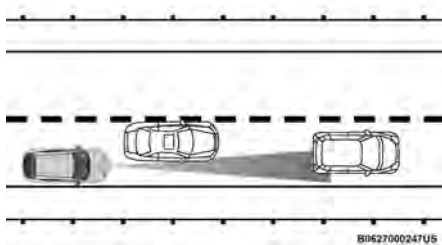

Offset Driving Condition Example

## TURNS AND BENDS

When driving on a curve with ACC engaged, the system may increase or decrease the vehicle speed for stability, with no vehicle ahead detected. Once the vehicle is out of the curve, the system will resume your original set speed. This is a part of normal ACC system functionality.

### NOTE:

On tight turns ACC performance may be limited.

### USING ACC ON HILLS

ACC performance may be limited when driving on hills. ACC may not detect a vehicle in your lane depending on the speed, vehicle load, traffic conditions, and the steepness of the hill.



ACC Hill Example

## LANE CHANGING

ACC may not detect a vehicle until it is completely in the lane in which you are traveling. In the following lane changing example, ACC has not yet detected the vehicle changing lanes and it may not detect the vehicle until it's too late for the ACC system to take action. ACC may not detect a vehicle until it is completely in the lane. There may not be sufficient distance to the lane-changing vehicle. Always be attentive and ready to apply the brakes if necessary.

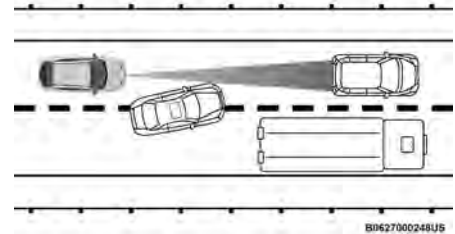

Lane Changing Example

## NARROW VEHICLES

Some narrow vehicles traveling near the outer edges of the lane or edging into the lane are not detected until they have moved fully into the lane. There may not be sufficient distance to the vehicle ahead.

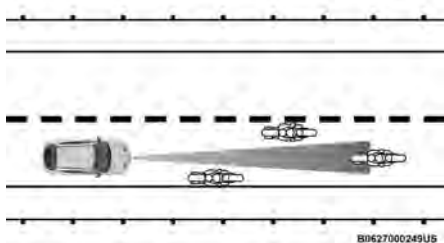

Narrow Vehicle Example

## STATIONARY OBJECTS AND VEHICLES

ACC does not react to stationary objects or vehicles. For example, ACC will not react in situations where the vehicle you are following exits your lane and the vehicle ahead is stopped in your lane. It will consider this stopped vehicle a stationary object as it did not previously detect movement from it. Always be attentive and ready to apply the brakes if necessary.

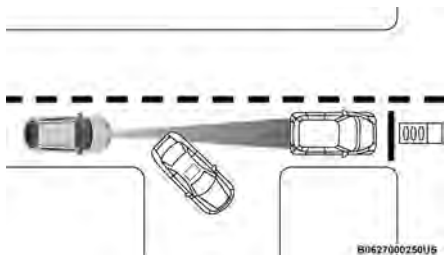

Stationary Object And Stationary Vehicle Example

## TRAFFIC SIGN RECOGNITION — IF EQUIPPED

The Traffic Sign Recognition (TSR) system uses a camera mounted on the windshield, as well as map data when the vehicle is equipped with Navigation, to detect recognizable road signs such as:

- Speed limits
- School zones
- No passing zones

### NOTE:

- The TSR system will automatically display the road sign detected in the unit of measurement (mph or km/h) selected within Uconnect Settings, or within the instrument cluster display.
- If no speed limit signs are detected, the system will revert to the speed limit signs that are stored in the Navigation system.
- The system always checks the traffic signs indicating the current speed limit signs. The system is able to recognize and display up to two different road signs in the instrument cluster display.

## ACTIVATION/DEACTIVATION

The TSR System can be enabled/disabled within the Uconnect system ↪ page 149. System ON is signaled by road signs shown on the instrument cluster display.

### NOTE:

- The TSR system will keep the activated/deactivated selection in memory between key cycles.

- Even if the system is disabled, the speed limit sign will be displayed when the driver selects it in the Driver Assist menu.

## TRAFFIC SIGN RECOGNITION MODES

TSR has three selectable modes of operation that are available through the Uconnect system.

### Visual

When Visual is selected, the system will alert the driver when the current speed of the vehicle exceeds the detected speed limit by showing a graphic in the instrument cluster display.

### Visual + Chime

When Visual + Chime is selected, the system will alert the driver when the current speed of the vehicle exceeds the detected speed limit by showing a graphic in the instrument cluster display, and by sounding an audible alert. The audible alert will last for 10 seconds, and the visual alert will remain on as long as the vehicle is exceeding the speed limit.

### NOTE:

Whenever an audible alert is requested by the TSR system, the radio is also muted.

### TSR Off

When the TSR system is turned off, the system will not show any traffic signs (unless selected in the Driver Assist menu, which will show detected speed limit signs), and no alerts will be issued to the driver.

## INDICATIONS ON THE DISPLAY

Detected traffic signs are shown in the instrument cluster display, and can display a combination of signs at one time (e.g. speed limit, supplemental info, and no passing zone signs) depending on what information is available.

### NOTE:

If no speed limit is being detected, there is a fault in the system, or the cameras are obstructed, the speed limit sign will display with dashes instead of a number.

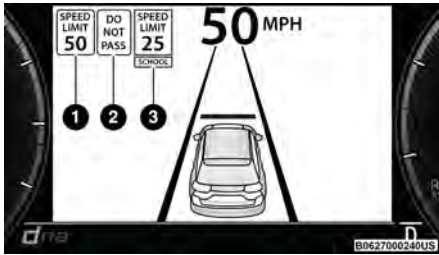

**Traffic Signs Recognized**

- 1 — Next Speed Limit Detected
- 2 — No Passing Zone Detected
- 3 — Current Speed Limit With Supplemental Information (School Zone)

### Supplemental Information

Supplemental information may be displayed, along with a newly detected speed limit, indicating special circumstances of which the driver should be aware. Available supplemental information includes:

- Rain
- Snow
- Fog
- School
- Night
- Trailer

### NOTE:

Supplemental information will not be displayed when the vehicle is ONLY equipped with GPS.

### Speed Limit Exceeded

When the vehicle's speed exceeds the displayed speed limit, the speed limit sign on the instrument cluster display will show a red outline to alert the driver.

### CAUTION!

- Functionality may be limited or the system may not work if the sensor is obstructed.
- The system may have limited operation or not work at all in weather conditions such as heavy rain, hail, and thick fog. Strong light contrasts can influence the recognition capability of the sensor.
- The area surrounding the sensor must not be covered with stickers or any other object.
- Do not tamper with or perform any operations in the area of the windshield glass directly surrounding the sensor.

(Continued)

### CAUTION!

- Clean foreign matters such as bird droppings, insects, snow or ice on the windshield. Use non-abrasive detergents and clean cloths to avoid scratching the windshield.

## INTELLIGENT ADAPTIVE CRUISE CONTROL — IF EQUIPPED

The Intelligent Adaptive Cruise Control (IACC) system allows the driver to set the Adaptive Cruise Control (ACC) speed to be equal to the traffic signs detected by the Traffic Sign Recognition (TSR) system [↪ page 120](#).

### ACTIVATION/DEACTIVATION

IACC is enabled when ACC has been activated using the Mode button on the left side of the steering wheel, and either "Confirmation" or "Automatic" sign capture mode is selected within the Uconnect system [↪ page 149](#). System ON is signaled by a green circle around the detected road sign in the instrument cluster display.

#### Setting The ACC Speed Using Confirmation Mode

When Confirmation Mode is selected, and the Traffic Sign Recognition (TSR) system detects a new speed limit sign, the driver will confirm this new speed by pushing the SET switch upward briefly, then releasing. This confirmation of the new speed must be done within five seconds of a newly detected speed limit sign being shown in the instrument cluster display.

### Setting The ACC Speed Using Automatic Mode

When Automatic Mode is selected, the ACC system will automatically adjust the speed setting when the TSR system detects a new speed limit sign.

The driver can reject this new speed by pushing the SET switch upward briefly, then releasing within five seconds of the new speed limit sign being detected and the speed being adjusted.

Set the desired following distance as you normally would using the ACC system → page 118.

## ACTIVE DRIVING ASSIST SYSTEM — IF EQUIPPED

### OPERATION

The Active Driving Assist (ADA) system is combined with the Adaptive Cruise Control (ACC) system, and centers the vehicle in the driving lane while traveling at speeds up to 93 mph (150 km/h).

For ACC system operating instructions and system limitations, see → page 114.

#### NOTE:

- The driver should always obey traffic laws and speed limits. Never drive above applicable speed limit restrictions.
- The driver can override ADA at any time by braking, accelerating, or steering the vehicle.

Just like ACC, ADA will maintain a set speed as long as the set distance between your vehicle and the vehicle in front is maintained. ADA will also keep your vehicle centered between the lane lines, and monitor for other vehicles in adjacent lanes by utilizing the Blind Spot Monitoring sensors.

ADA uses sensors within the steering wheel to measure driver attentiveness. ADA requires the driver's hands on the steering wheel at all times. The system will generally aim to keep the vehicle centered in the lane, but when the driver turns the steering wheel (e.g. to move farther away from a large vehicle in an adjacent lane) the system will reduce its control and enter "co-steering" mode. While in co-steering mode, the system will provide reduced assistance and allow the driver to control the path of the vehicle. Once the driver stops providing input to the steering wheel, the system will require a few seconds to fully resume lane centering assistance, especially during curves.

#### WARNING!

The Active Driving Assist (ADA) system is a convenience system. It is not a substitute for active driver involvement. It is always the driver's responsibility to be attentive of road traffic, weather conditions, vehicle speed, distance to the vehicle ahead, position in the lane compared to other vehicles, and brake operation to ensure safe operation of the vehicle under all road conditions. Your complete attention is always required while driving to maintain safe control of your vehicle. Failure to follow these warnings can result in a collision and death or serious personal injury.

(Continued)

#### WARNING!

You should turn off the Active Driving Assist system:

- When driving in complex driving situations (e.g. urban environments, construction zones, etc.), adverse weather or low visibility conditions (e.g. rain, snow, fog, sleet, dust), or adverse road conditions (e.g. heavy traffic, worn or missing lane markings, etc.).
- When entering a highway off-ramp, when driving on roads that are icy, snow covered, or slippery.
- When driving during difficult or uncertain conditions.

### TURNING ACTIVE DRIVING ASSIST ON OR OFF



Active Driving Assist On/Off Button

To enable the Active Driving Assist system, proceed as follows:

1. Push the Active Driving Assist on/off button located on the left side of the steering wheel. The steering wheel image will display white in the instrument cluster display until the system is engaged. If ACC was previously disabled, pushing this button will activate BOTH ACC and Active Driving Assist systems.
2. If ACC was engaged before pushing the ADA on/off button, ACC will remain active and ADA will also become engaged (once all other conditions are met).
3. If the Active Speed Limiter was active before pushing the ADA on/off button, it will then disable and activate ACC. Push the SET switch upward or downward and release when the desired driving speed is shown in the instrument cluster display.
4. If desired, adjust the ACC distance setting by pushing the Distance Setting button.

When all system conditions are met as described in "System Engagement Conditions" in the next section, the system will engage and the steering wheel image in the display will change to green.

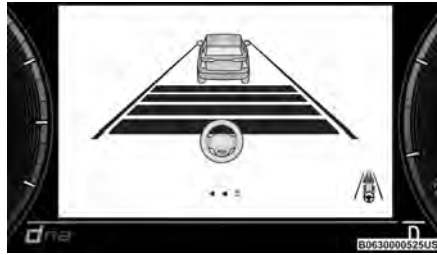

**Active Driving Assist Engaged (Steering Wheel Green)**

#### System Engagement Conditions

The following conditions must be met before the system will engage:

- Active Driving Assist system is enabled
- Driver seat belt is buckled
- System detects visible lane markings
- Driver is not pressing the brake pedal
- Driver door is closed
- Vehicle is traveling below 93 mph (150 km/h)
- Vehicle is centered in lane
- Turn signal is not activated
- Vehicle is not in a tight curve
- Driver has hands on steering wheel
- No fault warning lights for the ADA system are present
- No fault warning lights for the vehicle radar or camera are present

#### NOTE:

- The driver should always obey traffic laws and speed limits. Never drive above applicable speed limit restrictions.
- The driver can override ADA at any time by braking, accelerating, or steering the vehicle.
- For the system to detect the driver's hands on the steering wheel, the wheel must be gripped on the outside. Gripping the inside areas of the steering wheel will not satisfy the hands-on condition to engage the system.



**Do Not Grip Inside Of Steering Wheel**

#### System Deactivation

The system will be deactivated in any of the following situations:

- If the system has detected driver inattentiveness, and has gone through all escalation warnings after hands are no longer detected on the steering wheel
- If the vehicle is driving in constant traffic
- If lane markings are no longer detected

- If the brake pedal is pressed or ACC system is deactivated
- If the Active Driving Assist on/off button is pushed again (ADA will turn off)
- If a turn signal is used (unless a target is in the blind spot zone on the same side the turn signal is being applied)
- If the driver applies enough input to the steering wheel
- If the driver's seat belt is released
- If the vehicle speed exceeds 93 mph (150 km/h)
- If the Active Driving Assist on/off button is pushed again (ADA will turn off)
- If the Forward Collision Warning (FCW) system becomes active and is providing warnings/braking
- If there is glare from the sun on the vehicle's camera
- If the vehicle is driving on tight curves
- If the camera has decreased visibility due to rain, snow, etc.
- If the driver quickly applies the accelerator pedal

**NOTE:**

- Pushing the Active Driving Assist on/off button or deactivating ACC will turn the system off. All other deactivation conditions will place the system back into the "enabled" state with the steering wheel indicator displayed in white until all engagement conditions are met again.
- When the system is deactivated, the system status indicator lights will turn off, the LaneSense system will return to its previous state, and ACC will disable.

## INDICATIONS ON THE DISPLAY

The Active Driving Assist system status can always be viewed in the instrument cluster display, and status changes are shown by changes in color of the system's indicator lights.

As the system detects driver inattentiveness as previously described  page 122, the system status indicator lights will change from green, to yellow, to red. The following indicators will change in color as warnings to the driver escalate:

- Active Driving Assist Indicator (steering wheel icon in the instrument cluster display)
- Glow effect of the instrument cluster display

If driver driver's hands are not returned to the steering wheel, the system will deactivate.

**Active Driving Assist Indicators Are Off**

- ADA is not turned on/enabled by the driver.

**Active Driving Assist Indicators Are White**

- ADA is turned on/enabled by the driver, but the system is not actively steering or providing Cruise Control for the vehicle.

**Active Driving Assist Indicators Are Green**

- The system detects driver attentiveness and is actively steering and providing Cruise Control for the vehicle.

**Active Driving Assist Indicators Are Yellow**

- Driver inattentiveness has been detected, warning the driver to place hands on the steering wheel.

**Active Driving Assist Indicators Are Red**

- Driver inattentiveness is still being detected, or driver take-over is being requested, warning the driver to place hands on the steering wheel. This warning is also issued when the system has detected a tight curve and is warning the driver to take control.

**NOTE:**

The driver **MUST** replace hands on the steering wheel and take control of the vehicle when the system is deactivated.

## MINIMUM RISK MANEUVER

When the vehicle begins the hands-off steering wheel warning escalation, previously described, the system will initiate the Minimum Risk Maneuver for bringing the vehicle to a stop.

After 23 seconds from the initial absence of the hands on the steering wheel, the Adaptive Cruise Control (ACC) system will apply a brake jerk to warn the driver to take vehicle control. If, after another 3 seconds the driver does not take the control of the vehicle, the system will apply a second brake jerk.

If the absence of hands on the steering wheel persists, the system will apply automatic braking to bring the vehicle to the stop and activate the vehicle's hazard warning lights. After the vehicle is stopped, the system will unlock the doors (if previously locked).

**NOTE:**

If the driver takes control of the vehicle during the Minimum Risk Maneuver by placing hands on the steering wheel or pressing the accelerator, the system Minimum Risk Maneuver will be canceled, and the ADA system will resume normal function.

## SYSTEM STATUS

Along with changes in the system's indicator lights (green, yellow, and red), the system can also issue several accompanying warnings intended to provide the driver with enough time to react, avoid or mitigate a potential collision.

- Two haptic brake jerk warnings will be issued (red warning light is being issued).
- A steering wheel vibration warning (if enabled) will occur if the vehicle crosses a lane marker, for example, when driving on a tight curve. The steering wheel vibration feature can be turned on or off within the Uconnect system → page 149.

## SYSTEM OPERATION/LIMITATIONS

### WARNING!

The DDD system is an aid for driving and does not relieve the driver of the responsibility of driving the vehicle. If you experience fatigue while driving, pull over safely for a break without waiting for the DDD warnings. Only return to the road when you are in the right physical and mental condition to prevent endangering yourself and other drivers.

The Active Driving Assist system **DOES NOT:**

- Warn or prevent collisions with other vehicles
- Steer your vehicle around stopped vehicles, slower vehicles, construction equipment, pedestrians, or animals
- Respond to traffic lights or stop signs
- Merge onto highways or exit off ramps
- Turn your vehicle

- Change lanes
- React to cross traffic

### NOTE:

Adaptive Cruise Control (ACC) is a core component of ADA. For ACC system limitations, see → page 114.

The Active Driving Assist system may have limited or reduced functionality when one of the following conditions occur:

- The vehicle's radar sensors and/or forward facing camera is damaged, covered, misaligned, or obstructed (e.g. by mud, ice, snow, etc.)
- If the suspension alignment is not correct, if the vehicle is modified (e.g. lifting or lowering the suspension, installing different sized wheels or tires)
- Driving near highway toll booths

### NOTE:

If damage to the windshield occurs, have the windshield replaced by an authorized dealer as soon as possible.

## PARKSENSE FRONT/REAR PARK ASSIST SYSTEM — IF EQUIPPED

The ParkSense Park Assist system provides visual and audible indications of the distance between the rear, and if equipped, the front fascia/bumper and a detected obstacle when backing up or moving forward (e.g. during a parking maneuver).

### NOTE:

- The system is designed to assist the driver and not to substitute the driver.
- The driver must stay in full control of the vehicle's acceleration and braking and is responsible for controlling the vehicle's movements → page 127.

ParkSense will retain the last system state (enabled or disabled) from the last ignition cycle when the ignition is changed to the ON/RUN position.

ParkSense is active in DRIVE or REVERSE, as long as the system is on. The system will remain active until the vehicle speed is increased to approximately 8 mph (13 km/h) or above while in DRIVE or NEUTRAL, and 7 mph (11 km/h) or above while in REVERSE. While in REVERSE and above the system's operating speed, a warning will appear in the radio touchscreen indicating the vehicle speed is too fast. The system will become active again if the vehicle speed is decreased to less than approximately 6 mph (9 km/h).

## PARKSENSE SENSORS

The six ParkSense sensors (four when vehicle is not equipped with front sensors), located in the rear fascia/bumper, and the six ParkSense sensors located in the front fascia/bumper, monitor the area in front and behind the vehicle that is within the sensors' field of view. The front sensors detect obstacles from approximately 12 inches (30 cm) up to 35 inches (90 cm) from the front fascia/bumper. The rear sensors can detect obstacles from approximately 12 inches (30 cm) up to 59 inches (150 cm) from the rear fascia/bumper. These distances depend on the location, type and orientation of the obstacle in the horizontal direction.

## PARKSENSE WARNING DISPLAY

The ParkSense Warning screen will only be displayed if the settings are selected within the Uconnect system  page 149.

The ParkSense Warning screen is located within the radio touchscreen, and provides visual warnings to indicate the distance between the rear fascia/bumper and/or front fascia/bumper and the detected obstacle.

## PARKSENSE DISPLAY

The warning display will turn on indicating the system status when the vehicle is in REVERSE, or when the vehicle is in DRIVE or NEUTRAL and an obstacle has been detected.

The system will determine if an obstacle is in course of collision with the vehicle and will provide a visual warning to the driver. The system will indicate a detected obstacle by showing an arc in the left and/or right front or rear regions based on the object's distance and location relative to the vehicle. The color of the arc depends on the distance and position of the obstacle inside or outside the trajectory.

If the system detects an obstacle outside of the vehicles trajectory then it will display in grey. When the obstacle detected is on course of a collision the system will turn yellow then red. If the obstacle detected is less than 12 inches (30 cm) then a continuous tone will sound and the corresponding red arc will be displayed.

### Front Park Assist Audible Alerts

When an obstacle in course of a collision gets closer to the vehicle the tone frequency smoothly increases. The audible alert will remain on until one of the following conditions occurs:

- The vehicle is at a standstill and the gear selector is moved out of the REVERSE position.
- When the obstacle detected is outside of the vehicle path.

ParkSense will turn off the Front Park Assist audible alert (chime) after approximately three seconds when an obstacle has been detected, or if the vehicle is stationary.

### NOTE:

ParkSense will reduce the volume of the radio, if on, when the system is sounding an audible tone.

### Adjustable Chime Volume Settings

Front and Rear chime volume settings can be selected from the Uconnect system  page 149.

The chime volume settings include low, medium, and high.

ParkSense will retain its last known configuration state through ignition cycles.

## ENABLING AND DISABLING PARKSENSE



ParkSense can be enabled and disabled with the ParkSense switch, located at the rear of the gear selector.

When the ParkSense switch is pushed to disable the system, the LED in the switch will illuminate, and the display will read "ParkSense Off" when the vehicle is shifted into DRIVE or REVERSE.

### NOTE:

The ParkSense switch LED will be off when the system is active.

The ParkSense switch LED will also be illuminated when ParkSense requires service. If the ParkSense switch is pushed, and requires service, the ParkSense switch LED will blink momentarily, and then the LED will be on.

## SERVICE THE PARKSENSE PARK ASSIST SYSTEM

During vehicle start up, when the ParkSense System has detected a faulted condition, the instrument cluster will display a warning message associated with the detected fault.

If "Sensor Lock" appears in the instrument cluster display, make sure the outer surface and the underside of the rear fascia/bumper and/or front fascia/bumper is clean and clear of snow, ice, mud, dirt or other obstructions and then cycle the ignition. If the message continues to appear, see an authorized dealer.

If the "System Not Available" message appears in the instrument cluster display, see an authorized dealer.

## CLEANING THE PARKSENSE SYSTEM

Clean the ParkSense sensors with water, car wash soap and a soft cloth. Do not use rough or hard cloths. Do not scratch or poke the sensors. Otherwise, you could damage the sensors.



## PARKSENSE SYSTEM USAGE PRECAUTIONS

- Ensure that the front and rear fascias/bumpers are free of snow, ice, mud, dirt and debris to keep the ParkSense system operating properly.
- Jackhammers, large trucks, and other vibrations could affect the performance of ParkSense.
- When you turn ParkSense off, the display will read "Parksense Off" when the vehicle is shifted into DRIVE or REVERSE. Furthermore, once you turn ParkSense off, it remains off until you turn it on again, even if you cycle the ignition.
- ParkSense, when on, will reduce the volume of the radio when it is sounding a tone.
- Clean the ParkSense sensors regularly, taking care not to scratch or damage them. The sensors must not be covered with ice, snow, slush, mud, dirt or debris. Failure to do so can result in the system not working properly. The ParkSense system might not detect an obstacle behind or in front of the fascia/bumper, or it could provide a false indication that an obstacle is behind or in front of the fascia/bumper.
- Use the ParkSense switch to turn the ParkSense system off if objects such as bicycle carriers, etc. are attached to the rear fascia/bumper. Failure to do so can result in the system misinterpreting a close object as a sensor problem, causing the "System Not Available" message to be displayed in the instrument cluster display.

### NOTE:

If any objects are attached to the fascia/bumper within a 6.5 ft (2 m) field of view, they will interfere and cause false alerts and possibly blockage.

- There may be a delay in the object detection rate if the object is moving.
- The rear sensors are automatically deactivated when the trailer's electric plug is inserted in the vehicle's tow socket. The front sensors (if equipped) will stay active and can provide acoustic and visual warnings. The rear sensors are automatically reactivated when the trailer's cable plug is removed.

### WARNING!

- Drivers must be careful when backing up even when using ParkSense. Always check carefully behind your vehicle, look behind you, and be sure to check for pedestrians, animals, other vehicles, obstructions, and blind spots before backing up. You are responsible for safety and must continue to pay attention to your surroundings. Failure to do so can result in serious injury or death.
- Before using ParkSense, it is strongly recommended that the ball mount and hitch ball assembly be disconnected from the vehicle when the vehicle is not used for towing. Failure to do so can result in injury or damage to vehicles or obstacles because the hitch ball will be much closer to the obstacle than the rear fascia/bumper when the vehicle sounds the continuous tone. Also, the sensors could detect the ball mount and hitch ball assembly, depending on its size and shape, giving a false indication that an obstacle is behind the vehicle.

### CAUTION!

- ParkSense is only a parking aid and it is unable to recognize every obstacle, including small obstacles. Parking curbs might be temporarily detected or not detected at all. Obstacles located above or below the sensors will not be detected when they are in close proximity.
- The vehicle must be driven slowly when using ParkSense in order to be able to stop in time when an obstacle is detected. It is recommended that the driver looks over his/her shoulder when using ParkSense.

4

## SIDE DISTANCE WARNING (SDW) SYSTEM

The Side Distance Warning system has the function of detecting the presence of side obstacles near the vehicle using the parking sensors located in the front and rear fascias/bumpers.

### Side Distance Warning Display

The Side Distance Warning screen will only be displayed if this feature is enabled within Uconnect Settings  
 page 149.

The system warns the driver with an acoustic signal, and when selected, with visual indications on the radio touchscreen display.

WARNING ALERTS		
Distance (in/cm)	Less than 12 inches (30 cm)	12 – 23 inches (30 – 60 cm)
Arcs-Left	Red Arc	Yellow Arc
Arcs-Right	Red Arc	Yellow Arc
Audible Alert Chime	Audible alert only when the vehicle is on course for a collision	
Radio Volume Reduced	Yes	Yes

**NOTE:**

ParkSense will reduce the volume of the radio if on when the system is sounding an audible tone.

**Activation/Deactivation**

The system can operate only after driving a short distance and if the vehicle speed is between 0 and 8 mph (0 and 13 km/h) while in DRIVE or NEUTRAL, or 7 mph (11 km/h) in REVERSE. The system can be activated/deactivated via the Settings menu of the Uconnect system. If the ParkSense System is deactivated via the ParkSense switch, then the Side Distance Warning system will automatically be deactivated.

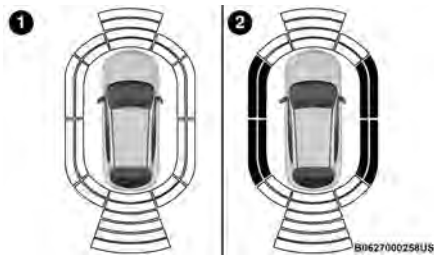
**Side Distance Warning System Status**

1 – System Not Active

2 – System Active

**NOTE:**

The vehicle needs to be driven approximately one car length in order for the Side Distance Warning system to activate.

**Side Distance Warning Usage Precautions**

Some conditions may influence the performance of the Side Distance Warning system:

**NOTE:**

- Ensure that the front and rear fascias/bumpers are free of snow, ice, mud, dirt and debris to keep the ParkSense system operating properly.
- Construction equipment, large trucks, and other vibrations could affect the performance of ParkSense.

- ParkSense, when on, will reduce the volume of the radio when it is sounding a tone.
- Clean the ParkSense sensors regularly, taking care not to scratch or damage them. The sensors must not be covered with ice, snow, slush, mud, dirt or debris. Failure to do so can result in the system not working properly. The ParkSense system might not detect an obstacle behind or in front of the fascia/bumper, or it could provide a false indication that an obstacle is behind or in front of the fascia/bumper.
- The presence of a tow hook without a trailer may interfere with the correct operation of the parking sensors. Before using the ParkSense system, it is recommended to remove the removable tow hook ball assembly and any attachments from the vehicle when it is not used for towing operations. If you leave the tow hook fitted when not towing a trailer, the tow hook could be detected as an obstacle by the sensors. Contact your authorized dealer to update the ParkSense system operations.

**WARNING!**

- Drivers must be careful when backing up even when using ParkSense. Always check carefully behind your vehicle, look behind you, and be sure to check for pedestrians, animals, other vehicles, obstructions, and blind spots before backing up. You are responsible for safety and must continue to pay attention to your surroundings. Failure to do so can result in serious injury or death.

*(Continued)*

**WARNING!**

- Before using ParkSense, it is strongly recommended that the ball mount and hitch ball assembly be disconnected from the vehicle when the vehicle is not used for towing. Failure to do so can result in injury or damage to vehicles or obstacles because the hitch ball will be much closer to the obstacle than the rear fascia/bumper when the vehicle sounds the continuous tone. Also, the sensors could detect the ball mount and hitch ball assembly, depending on its size and shape, giving a false indication that an obstacle is behind the vehicle.

**CAUTION!**

- ParkSense is only a parking aid and it is unable to recognize every obstacle, including small obstacles. Parking curbs might be temporarily detected or not detected at all. Obstacles located above or below the sensors will not be detected when they are in close proximity.
- The vehicle must be driven slowly when using ParkSense in order to be able to stop in time when an obstacle is detected. It is recommended that the driver looks over his/her shoulder when using ParkSense.

## PARKSENSE ACTIVE PARK ASSIST SYSTEM — IF EQUIPPED

The ParkSense Active Park Assist system is intended to assist the driver during parallel, perpendicular, and parallel park exit maneuvers by identifying a proper parking space, providing audible/visual instructions, and controlling the steering wheel. The ParkSense Active Park Assist system is defined as “semi-automatic” since the driver maintains control of the accelerator, gear selector and brakes. Depending on the driver’s parking maneuver selection, the ParkSense Active Park Assist system is capable of maneuvering a vehicle into a parallel or a perpendicular parking space on either side (i.e., driver side or passenger side), as well as exiting a parallel parking space.

**NOTE:**

- The driver is always responsible for controlling the vehicle, responsible for any surrounding objects, and must intervene as required.
- The system is designed to assist the driver and not to substitute the driver.
- During a semi-automatic maneuver, if the driver touches the steering wheel after being instructed to remove their hands from the steering wheel, the system will cancel, and the driver will be required to manually complete the parking maneuver.
- The system may not work in all conditions (e.g. environmental conditions such as heavy rain, snow, etc., or if searching for a parking space that has surfaces that will absorb the ultrasonic sensor waves).

- New vehicles from the dealership must have at least 30 miles (48 km) accumulated before the ParkSense Active Park Assist system is fully calibrated and performs accurately. This is due to the system’s dynamic vehicle calibration to improve the performance of the feature. The system will also continuously perform the dynamic vehicle calibration to account for differences such as over or under inflated tires and new tires.

## ENABLING AND DISABLING THE PARKSENSE ACTIVE PARK ASSIST SYSTEM



The ParkSense Active Park Assist system can be enabled and disabled with the ParkSense Active Park Assist switch, located in front of the center console, to the rear of the gear selector.

To enable the ParkSense Active Park Assist system, push the ParkSense Active Park Assist switch once (LED turns on). Pushing the switch a second time will disable the system (LED turns off).

The ParkSense Active Park Assist system will turn off automatically for any of the following conditions:

- Parking maneuver is complete.
- Vehicle speed is greater than 18 mph (30 km/h) when searching for a parking space.
- Vehicle speed is greater than 5 mph (7 km/h) during active steering guidance into the parking space.
- Steering Wheel is touched during active steering guidance into the parking space.
- ParkSense Front and Rear Park Assist switch is pushed.
- Driver’s door is opened.

- Rear liftgate is opened.
- Electronic Stability Control/Anti-lock Braking System intervention.

The ParkSense Active Park Assist system will allow a maximum number of shifts between DRIVE and REVERSE. If the maneuver cannot be completed within the maximum amount of shifts, the system will cancel and the instrument cluster display will instruct the driver to complete the maneuver manually.

The ParkSense Active Park Assist system will only operate and search for a parking space when the following conditions are present:

- Gear selector is in DRIVE.
- Ignition is in the RUN position.
- ParkSense Active Park Assist switch is activated.
- Driver's door is closed.
- Rear liftgate is closed.
- Vehicle speed is less than 18 mph (30 km/h).
- The outer surface and the underside of the front and rear fascias/bumpers are clean and clear of snow, ice, mud, dirt or other obstructions.

#### NOTE:

If the vehicle is driven above approximately 15 mph (25 km/h), the instrument cluster display will instruct the driver to slow down. If the vehicle is driven above approximately 18 mph (30 km/h), the system will cancel. The driver must then reactivate the system by pushing the ParkSense Active Park Assist switch.

When pushed, the LED on the ParkSense Active Park Assist switch will blink momentarily, and then the LED will turn off if any of the preceding conditions are not present.

If the vehicle is in any other gear than DRIVE, and an object is detected, the system will default to Parallel Park Exit. A prompt will appear in the radio screen, and the driver will need to select "Yes" or "No" for a Parallel Park Exit maneuver. Any other conditions will result in a default to a Parallel Parking maneuver.

## PARALLEL/PERPENDICULAR PARKING SPACE ASSISTANCE OPERATION

When the ParkSense Active Park Assist system is enabled, you can select between Parallel, Perpendicular, and Parallel Park Exit maneuvers in the Uconnect system.

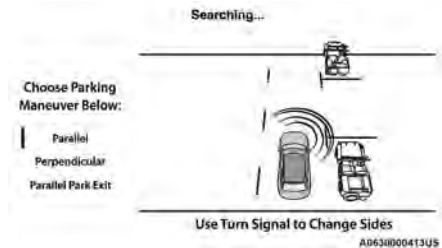

#### Choose Parking Maneuver Below

#### NOTE:

- When searching for a parking space, use the turn signal to select which side of the vehicle you want to perform the parking maneuver. The ParkSense Active Park Assist system will automatically search for a parking space on the passenger's side of the vehicle if the turn signal is not activated.

- The driver needs to make sure that the selected parking space for the maneuver remains free and clear of any obstructions (e.g. pedestrians, bicycles, etc.).
- The driver is responsible to ensure that the selected parking space is suitable for the maneuver and free/clear of anything that may be overhanging or protruding into the parking space (e.g., ladders, tailgates, etc. from surrounding objects/vehicles).
- When searching for a parking space, the driver should drive as parallel or perpendicular (depending on the type of maneuver) to other vehicles as possible.
- The feature will only indicate the last detected parking space (e.g., if passing multiple available parking spaces, the system will only indicate the last detected parking space for the maneuver).
- While the vehicle is in DRIVE, there will be a full screen image in the Uconnect display. If the driver shifts to REVERSE while searching for a parking space, a camera image will appear in the Uconnect display with a "Shift To Drive" message.

When an available parking space has been found, and the vehicle is not in position, you will be instructed to move forward to position the vehicle for a perpendicular or parallel parking sequence (depending on the type of maneuver being performed).

Once active steering begins, a camera image will display in the Uconnect display with prompts that will display for the duration of the maneuver.



### Parking Space Found – Keep Moving Forward

Once the vehicle is in position, you will be instructed to stop the vehicle's movement and remove your hands from the steering wheel. When the vehicle comes to a standstill (your hands still removed from the steering wheel), you will be instructed to place the gear selector into the REVERSE position.

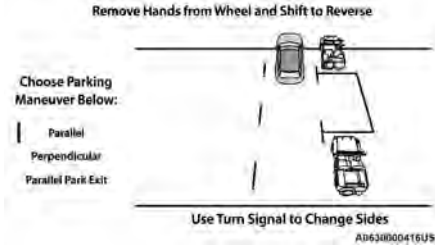

### Shift To Reverse – Parallel Parking Space

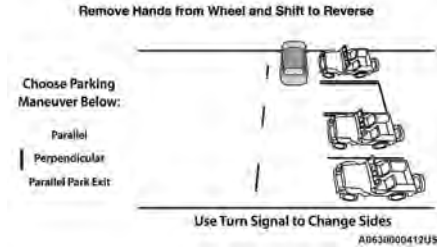

### Shift To Reverse – Perpendicular Parking Space

The system may then instruct the driver to wait for steering to complete before then instructing to check the vehicle's surroundings, and move backward. Several more gear shifts (DRIVE and REVERSE) while keeping hands off of the steering wheel will be instructed to the driver while checking the vehicle's surroundings before completing the parking maneuver. When the vehicle is in the parking position, the maneuver is complete and the driver will be instructed to check the vehicle's parking position, then shift the vehicle into PARK. The message "Active ParkSense Complete - Check Parking Position" will be displayed momentarily.

#### NOTE:

- It is the driver's responsibility to use the brake and stop the vehicle. The driver should check their surroundings and be prepared to stop the vehicle either when instructed to, or when driver intervention is required.

- It is the driver's responsibility to use the brake and accelerator during the semi-automatic parking maneuver.
- When the system instructs the driver to remove their hands from the steering wheel, the driver should check their surroundings and begin to back up slowly.
- The system will cancel the maneuver if the vehicle speed exceeds 5 mph (7 km/h) during active steering guidance into the parking space. The system will provide a warning to the driver at 3 mph (5 km/h) that tells them to slow down. The driver is then responsible for completing the maneuver if the system is canceled.
- If the system is canceled during the maneuver for any reason, the driver must take control of the vehicle.

#### WARNING!

- Drivers must be careful when performing parallel or perpendicular parking maneuvers even when using the ParkSense Active Park Assist system. Always check carefully behind and in front of your vehicle, look behind and in front of you, and be sure to check for pedestrians, animals, other vehicles, obstructions, and blind spots before backing up and moving forward. You are responsible for safety and must continue to pay attention to your surroundings. Failure to do so can result in serious injury or death.

(Continued)

**WARNING!**

- Before using the ParkSense Active Park Assist system, it is strongly recommended that the ball mount and hitch ball assembly be disconnected from the vehicle when the vehicle is not used for towing. Failure to do so can result in injury or damage to vehicles or obstacles because the hitch ball will be much closer to the obstacle than the rear fascia/bumper when the vehicle sounds the continuous tone. Also, the sensors could detect the ball mount and hitch ball assembly, depending on its size and shape, giving a false indication that an obstacle is behind the vehicle.

**CAUTION!**

- The ParkSense Active Park Assist system is only a parking aid and it is unable to recognize every obstacle, including small obstacles. Parking curbs might be temporarily detected or not detected at all. Obstacles located above or below the sensors will not be detected when they are in close proximity.
- The vehicle must be driven slowly when using the ParkSense Active Park Assist system in order to be able to stop in time when an obstacle is detected. It is recommended that the driver looks over his/her shoulder when using the ParkSense Active Park Assist system.

**EXITING THE PARKING SPACE****NOTE:**

The function does not work for exiting a perpendicular parking space, but only exiting parallel parking spaces.

**Activation**

To activate this function, push the Active ParkSense switch once, then select “Parallel Park Exit” from the Uconnect touchscreen. After selection, the system activates and instructs the driver on the operations that have to be carried out to perform the maneuver correctly.

**NOTE:**

To ensure the proper activation of the Exiting A Parallel Parking Space feature, the vehicle must be completely stationary within the parking space, and the desired exit side must be selected prior to commencing the maneuver.

**Selection Of The Maneuver Side**

Use the turn signal to choose the direction that you want to perform the maneuver. Use the right arrow indicator to perform the maneuver to the right side and use the left arrow indicator to perform the maneuver to the left.

During the maneuver, the system instructs the driver to shift to REVERSE, and operate the turn signal in the direction you want to exit. Let go of the steering wheel and use the brake or accelerator pedals as instructed, while the system handles the steering automatically for exiting the parking space. If the driver continues to carry out a voluntary or involuntary action on the steering wheel during the exit maneuver (touching or holding the steering wheel to prevent its movement), the maneuver will be interrupted.

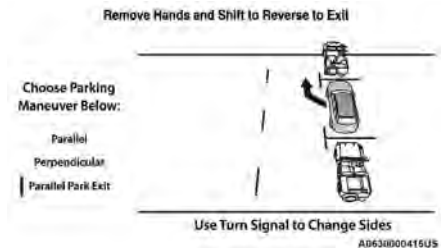
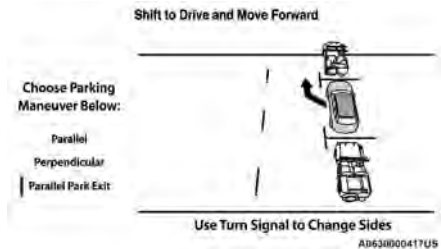
**Shift To Reverse Then Move Backward****Shift To Drive Then Move Forward****End Of Maneuver**

The semi-automatic maneuver ends when the display shows the message of a completed maneuver. At the end of the maneuver, the system gives back the vehicle control to the driver.

## Important Information

- If the sensors undergo impact which alters their position, the system operation could be greatly affected.
- The sensors reach top performance after the vehicle has gone about 30 miles (50 km) due to the dynamic tire circumference calculations used for parking.
- Clean the ParkSense sensors regularly, taking care not to scratch or damage them. The sensors must not be covered with ice, snow, slush, mud, dirt or debris. Failure to do so can result in the system not working properly. The ParkSense system might not detect an obstacle behind or in front of the fascia/bumper, or it could provide a false indication that an obstacle is behind or in front of the fascia/bumper.
- Construction equipment, large trucks, and other vibrations could affect the performance of ParkSense.
- Sensors may detect a nonexistent obstacle (echo noise) due to mechanical noises, for example while washing the vehicle or in the case of rain, strong wind, and hail.
- The sensors may not detect objects of a particular shape or made from particular materials (very thin poles, trailer beams, panels, nets, bushes, anti-parking posts, pavements, rubbish bins, motor vehicles, etc.). Always take great care to check that the vehicle and its path are actually compatible with the parking place identified by the system.
- The use of wheels and tires that are different size to the original equipment could affect the operation of the system.
- The operation of the rear sensors is automatically deactivated when the trailer's electric plug is inserted in the vehicle's tow hook socket, while the front sensors stay active and can provide acoustic and visual warnings. If this situation occurs, Active Park Assist will not work. The rear sensors are automatically reactivated when the trailer's cable plug is removed.
- In the case of parking maneuvers on roads with inclines, the performance of the system could be inferior and it may deactivate.
- If a parking maneuver is being carried out between two parked vehicles alongside a curb, the system may cause the vehicle to drive up onto the curb.
- Some maneuvers at very tight bends might be impossible to be carried out.
- Take great care to ensure that conditions do not change during the parking maneuver (e.g. if there are persons and/or animals in the parking place, moving vehicles, etc.) and intervene immediately if necessary.
- During parking maneuvers, pay attention to vehicles approaching from the opposite direction. Always abide by the law and road regulations.

### NOTE:

- Correct system operation is not guaranteed if snow chains or the compact spare tire are fitted.
- The function only informs the driver about the last appropriate parking place (parallel or perpendicular) detected by the parking sensors.
- Some messages displayed are accompanied by audible warnings.

## LANESENSE — IF EQUIPPED

### LANESENSE OPERATION

The LaneSense system is operational at speeds above 37 mph (60 km/h) and below 11.2 mph (180 km/h). The LaneSense system uses a forward facing camera to detect lane markings and measure vehicle position within the lane boundaries.

When both lane markings are detected and the driver unintentionally drifts out of the lane (no turn signal applied), the LaneSense system provides a haptic warning in the form of torque applied to the steering wheel to prompt the driver to remain within the lane boundaries. If the driver continues to unintentionally drift out of the lane, the LaneSense system provides a visual warning through the instrument cluster display to prompt the driver to remain within the lane boundaries. The driver may manually override the haptic warning by applying torque to the steering wheel at any time.

When only a single lane marking is detected and the driver unintentionally drifts across the lane marking (no turn signal applied), the LaneSense system provides a visual warning through the instrument cluster display to prompt the driver to remain within the lane. When only a single lane marking is detected, a haptic (torque) warning will not be provided.

### NOTE:

When operating conditions have been met, the LaneSense system will monitor if the driver's hands are on the steering wheel and provides an audible warning to the driver when the driver's hands are not detected on the steering wheel. The system will cancel if the driver does not return their hands to the wheel.

## TURNING LANESENSE ON OR OFF

The LaneSense on/off button is located on the on the end of the multifunction lever, to the left of the steering wheel.

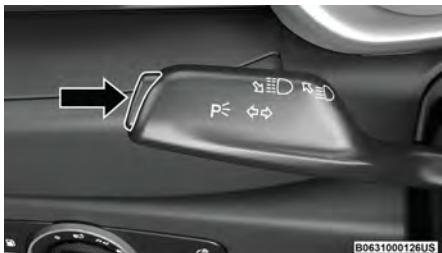

**LaneSense On/Off Button**

To turn the LaneSense system on, push the LaneSense button. The white LaneSense telltale is shown in the instrument cluster display with gray lane lines when the system is first turned on until lane markings are detected.

To turn the LaneSense system off, push the LaneSense button again. A "LaneSense OFF" message will be shown in the instrument cluster display.

### NOTE:

The LaneSense system will retain the last system state on or off from the last ignition cycle when the ignition is changed to the ON/RUN position.

## LANESENSE WARNING MESSAGE

The LaneSense system will indicate the current lane drift condition through the instrument cluster display. When the LaneSense system is on, both lane lines are gray when both of the lane boundaries have not been detected. The LaneSense telltale will be white.

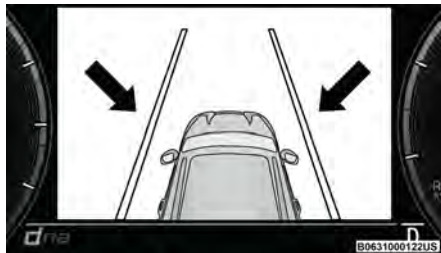

**System On (Gray Lane Lines)**

### NOTE:

When the Driver Assist screen is not selected in the instrument cluster display, the LaneSense status will be shown as a small icon at the bottom of the speedometer. The vehicle is represented by a telltale in the shape of a triangle that will change color along with the lane lines as the LaneSense status changes.

### Left Lane Departure — Only Left Lane Detected

- When the LaneSense system is on, the left lane line will change from gray to white, and the LaneSense telltale changes from white to green when only the left lane marking has been detected and the system is ready to provide visual warnings in the instrument cluster display if an unintentional lane departure occurs.

- When the LaneSense system senses the lane has been approached and is in a lane departure situation, the left lane line changes from white to yellow, and the LaneSense telltale changes from green to yellow.

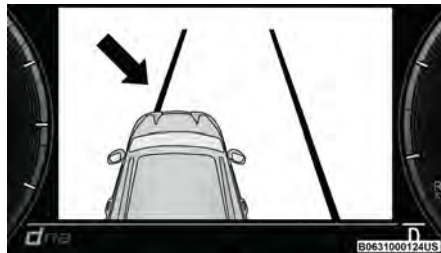

**Lane Approached (Yellow Lane Line)**

### NOTE:

The LaneSense system operates with similar behavior for a right lane departure when only the right lane marking has been detected.

### Left Lane Departure — Both Lanes Detected

- When the LaneSense system is on, both lane lines turn from gray to white to indicate that both of the lane markings have been detected. The LaneSense telltale is green when both lane markings have been detected and the system is armed and ready to provide visual warnings in the instrument cluster display, and a torque warning in the steering wheel if an unintentional lane departure occurs.



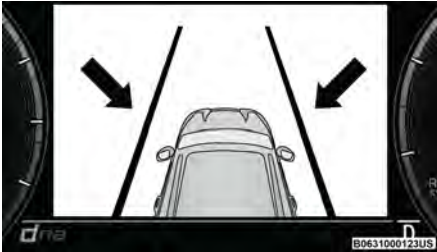

**Lanes Sensed (White Lane Lines)**

- When the LaneSense system senses a lane drift situation, the left lane line turns from white to yellow. The LaneSense telltale changes from green to yellow. At this time torque is applied to the steering wheel in the opposite direction of the lane boundary.

For example: If approaching the left side of the lane, the steering wheel will turn to the right.

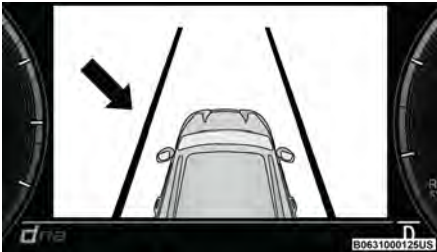

**Lane Drift Sensed (Yellow Lane Line)**

- When the LaneSense system senses the lane has been approached and is in a lane departure situation, the yellow left lane line begins to flash. At this time, torque is applied to the steering wheel in the opposite direction of the lane boundary.

For example: If approaching the left side of the lane, the steering wheel will turn to the right.

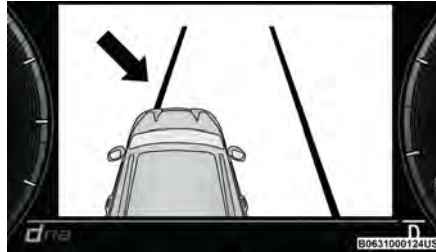

**Lane Approached (Flashing Yellow Lane Line)**

**NOTE:**

The LaneSense system operates with similar behavior for a right lane departure.

## CHANGING LANESENSE STATUS

The LaneSense system has settings to adjust the intensity of the torque warning (low/med/high) and the warning zone sensitivity (early/late) that you can configure through the Uconnect system ↗ page 149.

**NOTE:**

- When enabled the system operates above 37 mph (60 km/h) and below 112 mph (180 km/h).
- Use of the turn signal suppresses the warnings.

- The system will not apply torque to the steering wheel whenever a safety system engages (Anti-Lock Brakes, Traction Control System, Electronic Stability Control, Forward Collision Warning, etc.).

## PARKVIEW REAR BACK UP CAMERA

The ParkView Rear Back Up Camera allows you to see an on-screen image of the rear surroundings of your vehicle whenever the gear selector is put into REVERSE. The image will be displayed on the Navigation/Multimedia radio display screen along with a caution note to “Check Entire Surroundings” across the top of the screen. After five seconds this note will disappear. The ParkView camera is located on the rear of the vehicle above the rear license plate.

When the vehicle is shifted out of REVERSE with camera delay turned off, the rear camera mode is exited and the previous screen appears.

### Manual Activation Of The Back Up Camera

- Press the Controls button located in the Vehicle Controls menu, or within the Apps drawer. This button can also be configured as a shortcut on the bottom of the Uconnect display.
- Press the Back Up Camera button to turn the Rear View Camera system on.

**NOTE:**

The ParkView Rear Back Up Camera has programmable modes of operation that may be selected through the Uconnect system ↗ page 149.

When the vehicle is shifted out of REVERSE with camera delay turned off, the rear camera mode is exited and the previous screen appears. When the vehicle is shifted out of REVERSE with camera delay turned on,

the camera image will continue to be displayed for up to 10 seconds unless the following conditions occur: The vehicle speed exceeds 8 mph (13 km/h), the vehicle is shifted into PARK, the vehicle's ignition is placed in the OFF position, or the user presses the touchscreen X button to exit out of the camera video display.

When enabled, active guidelines are overlaid on the image to illustrate the width of the vehicle and its projected back up path based on the steering wheel position. A dashed center line overlay indicates the center of the vehicle to assist with parking or aligning to a hitch/receiver. Different colored zones indicate the distance to the rear of the vehicle. The following table shows the approximate distances for each zone:

Zone	Distance To The Rear Of The Vehicle
Red	0 - 1 ft (0 - 30 cm)
Yellow	1 ft - 3 ft (30 cm - 1 m)
Green	3 ft - 9.5 ft (1 m - 3 m)

#### WARNING!

Drivers must be careful when backing up even when using the ParkView Rear Back Up Camera. Always check carefully behind your vehicle, and be sure to check for pedestrians, animals, other vehicles, obstructions, or blind spots before backing up. You are responsible for the safety of your surroundings and must continue to pay attention while backing up. Failure to do so can result in serious injury or death.

#### CAUTION!

- To avoid vehicle damage, ParkView should only be used as a parking aid. The ParkView camera is unable to view every obstacle or object in your drive path.
- To avoid vehicle damage, the vehicle must be driven slowly when using ParkView to be able to stop in time when an obstacle is seen. It is recommended that the driver look frequently over his/her shoulder when using ParkView.

#### NOTE:

If snow, ice, mud, or any foreign substance builds up on the camera lens, clean the lens, rinse with water, and dry with a soft cloth. Do not cover the lens.

## SURROUND VIEW CAMERA SYSTEM — IF EQUIPPED

Your vehicle may be equipped with the Surround View Camera system that allows you to see an on-screen image of the surroundings and Top View of your vehicle whenever the gear selector is put into REVERSE or a different view is selected through the touchscreen buttons. The Top View of the vehicle will show which doors are open. The image will be displayed on the touchscreen display along with a caution note "Check Entire Surroundings" across the top of the screen. After five seconds, this note will disappear. The Surround View Camera system is comprised of four sequential cameras located in the front grille, rear liftgate and side mirrors.

#### Automatic Activation Of The Surround View Camera

When the vehicle is shifted into REVERSE, the Rear View and Top View will automatically be displayed on the Uconnect touchscreen.

The Surround View Camera will also automatically activate when the gear selector is in DRIVE or NEUTRAL and the system detects obstacles in its path. Camera view display will depend on the location of the detected obstacle.

#### Manual Activation Of The Surround View Camera

1. Press the Controls or Apps button located within the Uconnect system.
2. Press the Surround View Camera button to enter the camera's menu.



#### NOTE:

The Surround View Camera system has programmable settings that may be selected through the Uconnect system  page 149.

When the vehicle is shifted out of REVERSE with camera delay turned on, the camera image will continue to be displayed for up to 10 seconds unless the vehicle speed exceeds 8 mph (13 km/h), the vehicle is shifted into PARK or the ignition is placed in the OFF position. There is a touchscreen X button to disable the display of the camera image.

When the vehicle is shifted out of REVERSE with camera delay turned off, the Surround View Camera mode is exited and the last known screen appears again.

When enabled, active guidelines are overlaid on the image to illustrate the width of the vehicle, including the side view mirrors and its projected back up path based on the steering wheel position.

Different colored zones indicate the distance to the rear of the vehicle.

The following table shows the approximate distances for each zone:

Zone	Distance To The Rear Of The Vehicle
Red	0 - 1 ft (0 - 30 cm)
Yellow	1 ft - 3 ft (30 cm - 1 m)
Green	3 ft - 9.5 ft (1 m - 3 m)

### Modes Of Operation

Manual activation of the Surround View Camera is selected by pressing the Surround View Camera button located in the Controls menu within the Uconnect system.

#### Top View

The Top View will show in the Uconnect system with Rear View or Front View in a split screen display. There are integrated ParkSense arcs in the image at the front and rear of the vehicle. The arcs will change color from yellow to red corresponding the distance zones to the oncoming object.

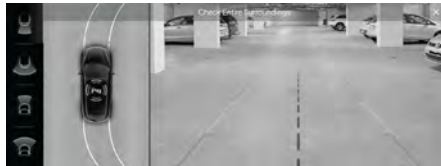

Top View With Rear View Screen

### NOTE:

- Front tires will be in image when the tires are turned.
- Due to wide angle cameras in the mirrors, the image will appear distorted.
- Top View will show which doors are open.
- Open front doors will cancel outside image.
- Open liftgate will cancel rear image while in Top View.

#### Rear View Plus Top View



This is the default view of the system in REVERSE and is always paired with the Top View of the vehicle with optional active guidelines for the projected path when enabled.

#### Rear Cross Path View



Pressing the Rear Cross Path View button will give the driver a wider angle view of the rear camera system.

#### Front View Plus Top View



Pressing the Front Plus Top View button will show you what is immediately in front of the vehicle and is always paired with the Top View of the vehicle.

#### Front Cross Path View



Pressing the Front Cross Path View button will give the driver a wider angle view of the front camera system. The Top View will be disabled when this is selected.

### NOTE:

If the Rear View Camera view was selected through the Surround View Camera menu, exiting out of the Rear View screen will return to the last known Surround View screen. If the Back Up Camera was manually activated through the Controls menu of the Uconnect system, exiting out of the display screen will return to the Controls menu.

### Deactivation

The system can be deactivated under the following conditions:

- The speed of the vehicle is greater than 8 mph (13 km/h).
- The vehicle is shifted into PARK.
- The vehicle is in any gear other than REVERSE and the touchscreen X button is pressed.
- The camera delay system is turned off manually through the Uconnect Settings menu ↩ page 149.

### NOTE:

- If snow, ice, mud, or any foreign substance builds up on the camera lenses, clean the lenses, rinse with water, and dry with a soft cloth. Do not cover the lenses.
- If a malfunction with the system has occurred, see an authorized dealer.

**WARNING!**

Drivers must be careful when backing up even when using the Surround View Camera. Always check carefully behind your vehicle, and be sure to check for pedestrians, animals, other vehicles, obstructions, or blind spots before backing up. You are responsible for the safety of your surroundings and must continue to pay attention while backing up. Failure to do so can result in serious injury or death.

**CAUTION!**

- To avoid vehicle damage, Surround View should only be used as a parking aid. The Surround View camera is unable to view every obstacle or object in your drive path.
- To avoid vehicle damage, the vehicle must be driven slowly when using Surround View to be able to stop in time when an obstacle is seen. It is recommended that the driver look frequently over his/her shoulder when using Surround View.

**REFUELING THE VEHICLE — GAS**

1. Ensure that the vehicle doors are unlocked as this unlocks the fuel door.
2. Open the fuel filler door by pushing on the outer edge of the fuel door.

**Fuel Filler Door****NOTE:**

There is no fuel filler cap. Two flapper doors inside the pipe seal the system.

3. Insert the fuel nozzle fully into the filler pipe; the nozzle opens and holds the flapper door while refueling.

**Fuel Filler Pipe**

4. Fill the vehicle with fuel, and when the fuel nozzle “clicks” or shuts off, the fuel tank is full.
5. Keep the nozzle in the filler for five seconds after nozzle clicks to allow fuel to drain from the nozzle.
6. Remove the fuel nozzle and close the fuel door.

**NOTE:**

In certain cold conditions, ice may prevent the fuel door from opening. If this occurs, lightly push on the fuel door to break the ice buildup and re-release the fuel door using the inside release button. Do not pry on the door.

**WARNING!**

- Never have any smoking materials lit in or near the vehicle when the fuel door is open or the tank is being filled.
- Never add fuel when the engine is running. This is in violation of most state and federal fire regulations and may cause the Malfunction Indicator Light to turn on.
- A fire may result if fuel is pumped into a portable container that is inside of a vehicle. You could be burned. Always place fuel containers on the ground while filling.

### Emergency Fuel Door Release

1. Open the liftgate and locate the release cap on the rear quarter trim panel to the right side of the vehicle.



**Release Cap Location**

2. Remove the release cap from the quarter trim panel by rotating the cap 90 degrees clockwise.

**NOTE:**

In some cases additional leverage may be necessary.

3. After removing the release cap, pull it directly away from the quarter trim panel to release the fuel door.



**Fuel Door Emergency Release**

4. Reinstall the release cap into the quarter trim when completed.

## REFUELING THE VEHICLE — PHEV (IF EQUIPPED)

1. Put the vehicle in the PARK position.
2. Push the fuel filler door release button (located next to the headlight switch).



**Fuel Filler Door Release Switch**

3. Pushing the button will initiate a sequence of events to depressurize the fuel system. A "Vehicle is Ready to Fuel" message will display in the cluster when the vehicle is ready to be fueled.



**Ready to  
Refuel**

B0634000180US

**Instrument Cluster Message**

**NOTE:**

- After pushing the release button you will have 20 minutes to fuel the vehicle; beyond 20 minutes you will need to push the release button again.
  - The fuel door should take 15 seconds to open under normal conditions. It may take longer to open in some situations, such as high ambient temperatures.
  - If you hear a hissing sound when the fuel cap is removed, wait to begin fueling the vehicle until after the hissing sound stops.
4. The fuel door pops away from the vehicle when it has been released. To finish opening the fuel door, manually rotate it away from the vehicle.

**NOTE:**

- If the service station fuel pump repeatedly clicks off (stops delivering fuel) before the fuel tank has been filled, push the fuel door release button again.
- If pushing the fuel door release button a second time does not correct the problem, try using a different fuel pump. If premature fuel pump shut-off continues to be a problem, take the vehicle to an authorized dealer for service.
- If the fuel door does not re-latch upon closure, push the fuel door release button again to reset the latch. If pushing the fuel door release button a second time does not correct the problem, take the vehicle to an authorized dealer for service.

**Fuel Filler Door****NOTE:**

In certain cold conditions, ice may prevent the fuel door from opening. If this occurs, lightly push on the fuel door to break the ice buildup and re-release the fuel door using the inside release button. Do not pry on the door.

5. Insert the fuel nozzle fully into the filler pipe; the nozzle opens and holds the flapper door while refueling.

**Fuel Filler Pipe**

6. Fill the vehicle with fuel, and when the fuel nozzle “clicks” or shuts off, the fuel tank is full.
7. Wait five seconds before removing the fuel nozzle to allow excess fuel to drain from nozzle.
8. Remove the fuel nozzle and close the fuel door.

**WARNING!**

- Never have any smoking materials lit in or near the vehicle when the fuel door is open or the tank is being filled.
- Never add fuel when the engine is running. This is in violation of most state and federal fire regulations and may cause the “Malfunction Indicator Light” to turn on.
- A fire may result if fuel is pumped into a portable container that is inside of a vehicle. You could be burned. Always place fuel containers on the ground while filling.

**CAUTION!**

To avoid fuel spillage and overfilling, do not “top off” the fuel tank after filling.



## Inflation Pressure

This is the cold tire inflation pressure for your vehicle for all loading conditions up to full GAWR.

## Curb Weight

The curb weight of a vehicle is defined as the total weight of the vehicle with all fluids, including vehicle fuel, at full capacity conditions, and with no occupants or cargo loaded into the vehicle. The front and rear curb weight values are determined by weighing your vehicle on a commercial scale before any occupants or cargo are added.

## Loading

The actual total weight and the weight of the front and rear of your vehicle at the ground can best be determined by weighing it when it is loaded and ready for operation.

The entire vehicle should first be weighed on a commercial scale to ensure that the GVWR has not been exceeded. The weight on the front and rear of the vehicle should then be determined separately to be sure that the load is properly distributed over the front and rear axle. Weighing the vehicle may show that the GAWR of either the front or rear axles has been exceeded but the total load is within the specified GVWR. If so, weight must be shifted from front to rear or rear to front as appropriate until the specified weight limitations are met. Store the heavier items down low and be sure that the weight is distributed equally. Stow all loose items securely before driving.

Improper weight distributions can have an adverse effect on the way your vehicle steers and handles and the way the brakes operate.

### WARNING!

Do not load your vehicle any heavier than the GVWR or the maximum front and rear GAWR. If you do, parts on your vehicle can break, or it can change the way your vehicle handles. This could cause you to lose control. Overloading can shorten the life of your vehicle.

## TRAILER TOWING

In this section you will find safety tips and information on limits to the type of towing you can reasonably do with your vehicle. Before towing a trailer, carefully review this information to tow your load as efficiently and safely as possible.

To maintain the New Vehicle Limited Warranty coverage, follow the requirements and recommendations in this manual concerning vehicles used for trailer towing.

## COMMON TOWING DEFINITIONS

The following trailer towing related definitions will assist you in understanding the following information:

### Gross Vehicle Weight Rating (GVWR)

The GVWR is the total allowable weight of your vehicle. This includes driver, passengers, cargo and tongue weight. The total load must be limited so that you do not exceed the GVWR → page 141.

### Gross Trailer Weight (GTW)

The GTW is the weight of the trailer plus the weight of all cargo, consumables and equipment (permanent or temporary) loaded in or on the trailer in its "loaded and ready for operation" condition.

The recommended way to measure GTW is to put your fully loaded trailer on a vehicle scale. The entire weight of the trailer must be supported by the scale.

### Gross Axle Weight Rating (GAWR)

The GAWR is the maximum capacity of the front and rear axles. Distribute the load over the front and rear axles evenly. Make sure that you do not exceed either front or rear GAWR → page 141.

### WARNING!

It is important that you do not exceed the maximum front or rear GAWR. A dangerous driving condition can result if either rating is exceeded. You could lose control of the vehicle and have a collision.

### Tongue Weight (TW)

The TW is the downward force exerted on the hitch ball by the trailer. You must consider this as part of the load on your vehicle.

### Trailer Frontal Area

The frontal area is the maximum height multiplied by the maximum width of the front of a trailer.



## Trailer Sway Control (TSC)

The TSC can be a mechanical telescoping link that can be installed between the hitch receiver and the trailer tongue that typically provides adjustable friction associated with the telescoping motion to dampen any unwanted trailer swaying motions while traveling. If equipped, the electronic TSC recognizes a swaying trailer and automatically applies individual wheel brakes and/or reduces engine power to attempt to eliminate the trailer sway.

## Weight-Carrying Hitch

A weight-carrying hitch supports the trailer tongue weight, just as if it were luggage located at a hitch ball or some other connecting point of the vehicle. These kinds of hitches are commonly used to tow small and medium sized trailers.

## Weight-Distributing Hitch

A Weight-Distributing system works by applying leverage through spring (load) bars. They are typically used for heavier loads to distribute trailer tongue weight to the tow vehicle's front axle and the trailer axle(s). When used in accordance with the manufacturer's directions, it provides for a more level ride, offering more consistent steering and brake control thereby enhancing towing safety. The addition of a friction/hydraulic sway control also dampens sway caused by traffic and crosswinds and contributes positively to tow vehicle and trailer stability. Trailer sway control and a Weight-Distributing (load equalizing) Hitch are recommended for heavier Tongue Weights (TW) and may be required depending on vehicle and trailer configuration/loading to comply with Gross Axle Weight Rating (GAWR) requirements.

### WARNING!

- An improperly adjusted Weight-Distributing Hitch system may reduce handling, stability, braking performance, and could result in a collision.
- Weight-Distributing systems may not be compatible with surge brake couplers. Consult with your hitch and trailer manufacturer or a reputable Recreational Vehicle dealer for additional information.

4

## TRAILER TOWING WEIGHTS (MAXIMUM TRAILER WEIGHT RATINGS)

Engine/Transmission	GCWR	Maximum GTW	Maximum Trailer TW (See Note)
2.0L / 9 Speed Auto	6,503 lb (2,950 kg)	2,000 lb (907 kg)	154 lb (70 kg)
Refer to local laws for maximum trailer towing speeds			

Engine/Transmission	GCWR	Maximum GTW	Maximum Trailer TW (See Note)
1.3L PHEV / 6 Speed Auto	6,878 lb (3,120 kg)	2,000 lb (907 kg)	154 lb (70 kg)
Refer to local laws for maximum trailer towing speeds			

### NOTE:

The trailer tongue weight must be considered as part of the combined weight of occupants and cargo (i.e., the GVWR), and the GVWR should never exceed the weight referenced on the Tire And Loading Information Placard  page 257.

## TRAILER AND TONGUE WEIGHT

Never exceed the maximum tongue weight stamped on your trailer hitch.

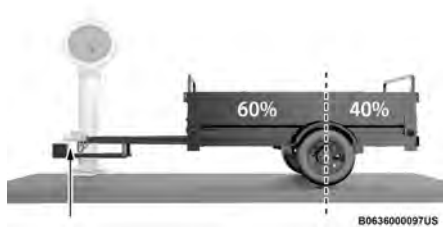

**Weight Distribution**

Consider the following items when computing the weight on the front/rear axles of the vehicle:

- The trailer tongue weight.
- The weight of any other type of cargo or equipment put in or on your vehicle.
- The weight of the driver and all passengers.

### NOTE:

Remember that everything put into or on the trailer adds to the load on your vehicle. Also, additional factory-installed options, or authorized dealer-installed options, must be considered as part of the total load on your vehicle. Refer to the Tire And Loading Information Placard located on the driver's door pillar for the maximum combined weight of occupants and cargo for your vehicle.

## TOWING REQUIREMENTS

To promote proper break-in of your new vehicle drive-train components, the following guidelines are recommended.

### CAUTION!

- Do not tow a trailer at all during the first 500 miles (805 km) the new vehicle is driven. The engine, axle or other parts could be damaged.
- Then, during the first 500 miles (805 km) that a trailer is towed, do not drive over 50 mph (80 km/h) and do not make starts at full throttle. This helps the engine and other parts of the vehicle wear in at the heavier loads.

Perform the maintenance listed in Scheduled Servicing and the proper maintenance intervals page 230. When towing a trailer, never exceed the GAWR or GCWR ratings.

### WARNING!

Improper towing can lead to a collision. Follow these guidelines to make your trailer towing as safe as possible:

- Make certain that the load is secured in the trailer and will not shift during travel. When trailering cargo that is not fully secured, dynamic load shifts can occur that may be difficult for the driver to control. You could lose control of your vehicle and have a collision.

(Continued)

### WARNING!

- When hauling cargo or towing a trailer, do not overload your vehicle or trailer. Overloading can cause a loss of control, poor performance or damage to brakes, axle, engine, transmission, steering, suspension, chassis structure or tires.
- Safety chains must always be used between your vehicle and trailer. Always connect the chains to the hook retainers of the vehicle hitch. Cross the chains under the trailer tongue and allow enough slack for turning corners.
- Vehicles with trailers should not be parked on a grade. When parking, apply the parking brake on the tow vehicle. Put the tow vehicle transmission in PARK. For four-wheel drive vehicles, make sure the transfer case is not in NEUTRAL. Always, block or "chock" the trailer wheels.
- GCWR must not be exceeded.
- **Total weight must be distributed between the tow vehicle and the trailer such that the following four ratings are not exceeded:**
  - GVWR
  - GTW
  - GAWR
  - Tongue weight rating for the trailer hitch utilized

## Towing Requirements — Tires

- Do not attempt to tow a trailer while using a compact spare tire.
- Do not drive more than 50 mph (80 km/h) when towing while using a full size spare tire.
- Proper tire inflation pressures are essential to the safe and satisfactory operation of your vehicle.
- Check the trailer tires for proper tire inflation pressures before trailer usage.
- Check for signs of tire wear or visible tire damage before towing a trailer.
- Replacing tires with a higher load carrying capacity will not increase the vehicle's GVWR and GAWR limits.
- For further information ↪ page 257.

## Towing Requirements — Trailer Brakes

- Do **not** interconnect the hydraulic brake system or vacuum system of your vehicle with that of the trailer. This could cause inadequate braking and possible personal injury.
- An electronically actuated trailer brake controller is required when towing a trailer with electronically actuated brakes. When towing a trailer equipped with a hydraulic surge actuated brake system, an electronic brake controller is not required.
- Trailer brakes are recommended for trailers over 1,000 lb (453 kg) and required for trailers in excess of 1,543 lb (700 kg).

### WARNING!

- Do not connect trailer brakes to your vehicle's hydraulic brake lines. It can overload your brake system and cause it to fail. You might not have brakes when you need them and could have an accident.
- Towing any trailer will increase your stopping distance. When towing, you should allow for additional space between your vehicle and the vehicle in front of you. Failure to do so could result in an accident.

### CAUTION!

If the trailer weighs more than 1,000 lb (453 kg) loaded, it should have its own brakes and they should be of adequate capacity. Failure to do this could lead to accelerated brake lining wear, higher brake pedal effort, and longer stopping distances.

## Towing Requirements — Trailer Lights And Wiring

Whenever you pull a trailer, regardless of the trailer size, stoplights and turn signals on the trailer are required for motoring safety.

The Trailer Tow Package may include a four- and seven-pin wiring harness. Use a factory-approved trailer harness and connector.

### NOTE:

Do not cut or splice wiring into the vehicle's wiring harness.

The electrical connections are all complete to the vehicle but you must mate the harness to a trailer connector. Refer to the following illustrations.

### NOTE:

- Disconnect the trailer wiring connector from the vehicle (or any other device plugged into vehicle's electrical connectors) before launching a boat into water.
- Be sure to reconnect once clear from water area.

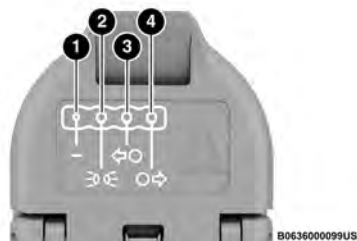
**Four-Pin Connector**

- 1 – Ground
- 2 – Park
- 3 – Left Stop/Turn
- 4 – Right Stop/Turn

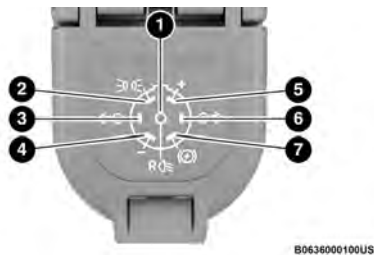
**Seven-Pin Connector**

- 1 – Backup Lamps
- 2 – Running Lamps
- 3 – Left Stop/Turn
- 4 – Ground
- 5 – Battery
- 6 – Right Stop/Turn
- 7 – Electric Brakes

## TOWING TIPS

Before towing, practice turning, stopping, and backing up the trailer in an area located away from heavy traffic.

### Automatic Transmission

Select the DRIVE (D) range when towing. The transmission controls include a drive strategy to avoid frequent shifting when towing. For increased engine braking on steep downhill grades, select the LOW range.

### Cruise Control — If Equipped

- Do not use on hilly terrain or with heavy loads.
- When using the Cruise Control, if you experience speed drops greater than 10 mph (16 km/h), disengage until you can get back to cruising speed.
- Use Cruise Control in flat terrain and with light loads to maximize fuel efficiency.

## RECREATIONAL TOWING (BEHIND MOTORHOME)

### TOWING THIS VEHICLE BEHIND ANOTHER VEHICLE

Towing Condition	Wheels Off The Ground	All-Wheel Drive (AWD)
Flat Tow	NONE	NOT ALLOWED
Dolly Tow	REAR	NOT ALLOWED
	FRONT	NOT ALLOWED
On Trailer	ALL	OK

**NOTE:**

- When towing your vehicle, always follow applicable state and provincial laws. Contact state and provincial Highway Safety offices for additional details.
- You must ensure that the Auto Park Brake feature is disabled before towing this vehicle, to avoid inadvertent Electric Park Brake engagement. The Auto Park Brake feature is enabled or disabled via the Customer Programmable Features in the Uconnect Settings.

**RECREATIONAL TOWING**

Recreational towing (with all four wheels on the ground, or using a towing dolly) is **NOT ALLOWED**. This vehicle may be towed on flatbed or vehicle trailer provided all four wheels are OFF the ground.

**CAUTION!**

Towing this vehicle with ANY of its wheels on the ground can cause severe transmission and/or power transfer unit damage. Damage from improper towing is not covered under the New Vehicle Limited Warranty.

**DRIVING TIPS****DRIVING ON SLIPPERY SURFACES**

Information in this section will aid in safe controlled launches in adverse conditions.

**Acceleration**

Rapid acceleration on snow covered, wet, or other slippery surfaces may cause the driving wheels to pull erratically to the right or left. This phenomenon occurs when there is a difference in the surface traction under the front (driving) wheels.

**WARNING!**

Rapid acceleration on slippery surfaces is dangerous. Unequal traction can cause sudden pulling of the front wheels. You could lose control of the vehicle and possibly have a collision. Accelerate slowly and carefully whenever there is likely to be poor traction (ice, snow, wet, mud, loose sand, etc.).

**Traction**

When driving on wet or slushy roads, it is possible for a wedge of water to build up between the tire and road surface. This is hydroplaning and may cause partial or complete loss of vehicle control and stopping ability. To reduce this possibility, the following precautions should be observed:

- Slow down during rainstorms or when the roads are slushy.
- Slow down if the road has standing water or puddles.
- Replace the tires when tread wear indicators first become visible.
- Keep tires properly inflated.
- Maintain sufficient distance between your vehicle and the vehicle in front of you to avoid a collision in a sudden stop.

**DRIVING THROUGH WATER**

Driving through water more than a few inches/centimeters deep will require extra caution to ensure safety and prevent damage to your vehicle.

**Flowing/Rising Water****WARNING!**

Do not drive on or across a road or path where water is flowing and/or rising (as in storm run-off). Flowing water can wear away the road or path's surface and cause your vehicle to sink into deeper water. Furthermore, flowing and/or rising water can carry your vehicle away swiftly. Failure to follow this warning may result in injuries that are serious or fatal to you, your passengers, and others around you.

**Shallow Standing Water**

Although your vehicle is capable of driving through shallow standing water, consider the following Cautions and Warnings before doing so.

**WARNING!**

Do not drive on or across a road or path where water is flowing and/or rising (as in storm run-off). Flowing water can wear away the road or path's surface and cause your vehicle to sink into deeper water. Furthermore, flowing and/or rising water can carry your vehicle away swiftly. Failure to follow this warning may result in injuries that are serious or fatal to you, your passengers, and others around you.

**CAUTION!**

- Always check the depth of the standing water before driving through it. Never drive through standing water that is deeper than the bottom of the tire rims mounted on the vehicle.
- Determine the condition of the road or the path that is under water and if there are any obstacles in the way before driving through the standing water.
- Do not exceed 5 mph (8 km/h) when driving through standing water. This will minimize wave effects.
- Driving through standing water may cause damage to your vehicle's drivetrain components. Always inspect your vehicle's fluids (i.e., engine oil, transmission, axle, etc.) for signs of contamination (i.e., fluid that is milky or foamy in appearance) after driving through standing water. Do not continue to operate the vehicle if any fluid appears contaminated, as this may result in further damage. Such damage is not covered by the New Vehicle Limited Warranty.
- Getting water inside your vehicle's engine can cause it to lock up and stall out, and cause serious internal damage to the engine. Such damage is not covered by the New Vehicle Limited Warranty.

# MULTIMEDIA

## UCONNECT SYSTEMS

For detailed information about your Uconnect 5/5 NAV With 10.25-inch Display system, refer to your Uconnect Radio Instruction Manual.

### NOTE:

Uconnect screen images are for illustration purposes only and may not reflect exact software for your vehicle.

## CYBERSECURITY

Depending on applicability, your vehicle may be able to send or receive information from a wired or wireless network. This information allows systems and features in your vehicle to function properly.

Your vehicle may be equipped with certain security features to reduce the risk of unauthorized and unlawful access to vehicle systems and wireless communications. Vehicle software technology continues to evolve over time and FCA US LLC, working with its suppliers, evaluates and takes appropriate steps as needed. As always, if you experience unusual behavior, contact an authorized dealer immediately, ↗ page 278, or refer to your Uconnect Radio Instruction Manual for additional contact information.

The risk of unauthorized and unlawful access to your vehicle systems may still exist, even if the most recent version of vehicle software (such as Uconnect software) is installed.

### WARNING!

- ONLY insert trusted media devices/components into your vehicle. Media of unknown origin could possibly contain malicious software, and if installed in your vehicle, it may increase the possibility for vehicle systems to be breached.
- As always, if you experience unusual vehicle behavior, contact an authorized dealer immediately.

### NOTE:

To help further improve user experience, features, stability, etc., and minimize the potential risk of a security breach, vehicle owners should routinely check [www.driveuconnect.com](http://www.driveuconnect.com) (US Residents) or [www.driveuconnect.ca](http://www.driveuconnect.ca) (Canadian Residents) to learn about available Uconnect software updates.

## UCONNECT SETTINGS

The Uconnect system uses a combination of buttons on the touchscreen and buttons on the faceplate located next to the shifter. These buttons allow you to access and change Programmable Features. Many features can vary by vehicle and packages.

The Uconnect Settings can be accessed by pressing the Settings tab.

Push and hold the Power dial next to the shifter for a minimum of 15 seconds to reset the radio.

## CUSTOMER PROGRAMMABLE FEATURES



**Uconnect 5/5 NAV With 10.25-inch Display Buttons On The Touchscreen And Next To The Shifter**

- 1 — Uconnect Buttons On The Touchscreen  
2 — Radio ON/OFF And Volume Control Bar

**For the Uconnect 5/5 NAV With 10.25-inch Display**

Press the Vehicle button, then press the Settings tab on the top of the touchscreen. In this menu, the Uconnect system allows you to access all of the available programmable features.

**NOTE:**

- Only one touchscreen area may be selected at a time.
- Depending on the vehicle's options, feature settings may vary.

When making a selection, press the button on the touchscreen to enter the desired menu. Once in the desired menu, press and release the preferred setting option until a check mark appears next to the setting, showing that setting has been selected. Once the setting is complete, press the Vehicle button to exit to the screen. Pressing the Up or Down Arrow button on the right side of the screen will allow you to toggle up or down through the available settings.

**Display**

When the Display button is pressed on the touchscreen, the system will display the options related to the theme (if equipped), brightness, and color of the touchscreen. The available settings are:

**NOTE:**

Depending on the vehicle's options, feature settings may vary.

Setting Name	Description
Language	This setting will change the language of the Uconnect system and Instrument Cluster Display. The available languages are Español (Mexico), English (United States), Italiano, and Français (Canada).
Display Mode	This setting will allow you to set the brightness manually or have the system set it automatically. The "Auto" setting has the system automatically adjust the display brightness. The "Manual" setting will allow the user to adjust the brightness of the display.
Set Theme	This setting will allow you to change the display theme.
Units	This setting will allow you to customize the units for "Speed" (MPH or km/h), "Distance" (mi or km), "Fuel Consumption" (MPG [US], MPG [UK], L/100 km, or km/L), "Pressure" (psi, kPa, or bar), "Temperature" (°C or °F), and "Torque" (Nm or lb-ft) units of measurement independently.
Touchscreen Beep	This setting will allow you to turn the touchscreen beep on or off.
Show Main Category Bar Labels	This setting will allow the main category bar labels to be shown on or off.
Display Brightness Nighttime	Only available if Display Mode is set to "Manual". This setting will allow you to adjust the "Brightness Nighttime" setting. Selectable options are 1 through 10.



Setting Name	Description
Display Brightness Daytime	Only available if Display Mode is set to "Manual". This setting will allow you to adjust the "Brightness Daytime" setting. Selectable options are 1 through 10.
Cluster Options	This settings allows users to select which content to display in each customizable area on the Instrument Cluster Display.
Warning Cluster Buzzer Volume	This setting will let you adjust the Warning Cluster Buzzer Volume. Selectable options are "Low", "Mid", and "High".
Navigation Turn-by-Turn Displayed in Cluster	This setting will display Navigation prompts in the Instrument Cluster Display.
Phone Pop-ups Displayed In Cluster	This setting will display smartphone notifications and messages in the Instrument Cluster Display.

## My Profile

When the My Profile button is pressed on the touchscreen, the system displays options related to the vehicle's profiles.

### NOTE:

Depending on the vehicle's options, feature settings may vary.

5

Setting Name	Description
Language	This setting will change the language of the Uconnect system and Instrument Cluster Display. The available languages are Español (Mexico), English (United States), Italiano, and Français (Canada).
Display Mode	This setting will adjust the display for the radio to "Auto" or "Manual". "Manual" allows for more customization with the radio display.
Display Brightness Nighttime	This setting will allow you to adjust the "Brightness Nighttime" setting. Selectable options are 1 through 10.
Display Brightness Daytime	This setting will allow you to adjust the "Brightness Daytime" setting. Selectable options are 1 through 10.
Set Theme	This setting will allow you to change the display theme.
Units	This setting will allow you to customize the units for "Speed" (MPH or km/h), "Distance" (mi or km), "Current Consumption" (MPG [US], MPG [UK], L/100 km, or km/L), "Pressure" (psi, kPa, or bar), "Temperature" (°C or °F), and "Torque" (lb-ft or Nm) units of measurement independently. Unit settings can be selected for "US", "Metric A", "Metric B", "Imperial", or "Custom".
Touchscreen Beep	This setting will allow you to turn the touchscreen beep on or off.
Show Main Category Bar Labels	This setting will allow the main category bar labels to be shown on or off.

Setting Name	Description
<b>Time Format</b>	This setting will allow you to set the time format (AM/PM). Sync Time With GPS must be “Off” for this setting to be available. The “12 hrs” setting will set the time to a 12-hour format. The “24 hrs” setting will set the time to a 24-hour format.
<b>Voice Options</b>	This setting will allow you to change the voice options for the radio to “Male” or “Female”.
<b>Wake Up Word</b>	This setting will allow you to set the system “Wake Up” word. The available options are “Off”, “Hey Alfa Romeo”, and “Hey Alfa”.
<b>Voice Barge-in</b>	This setting will allow Voice Barge-in to be turned on or off.
<b>Show Command List</b>	This setting will allow the Command List to be shown on or off.
<b>Ambient Color Personalization</b>	This setting will redirect to a new menu that will allow you to change the ambient lighting color in the cabin.
<b>Navigation Settings</b>	This setting will redirect to the list of Navigation settings. Refer to your Uconnect Radio Instruction Manual for further information.
<b>Auto-On Driver Heated/Ventilated Seat &amp; Heated Steering Wheel</b>	This setting will activate the vehicle’s comfort system and heated seats or heated steering wheel when the vehicle is remote started or ignition is started. The “Off” setting will not activate the comfort systems. The “Remote Start” setting will only activate the comfort systems when using Remote Start. The “All Start” setting will activate the comfort systems whenever the vehicle is started.
<b>Radio Off Delay</b>	This setting will keep certain electrical features running after the engine is turned off. When any door is opened, the electronics will deactivate. The available settings are “0 min” and “20 min”.
<b>Radio Off With Door</b>	This setting will allow you to determine if the radio shuts off when any of the doors are opened.
<b>Audio Settings</b>	This setting will open the submenu, containing the audio settings  page 161.
<b>App Drawer Favoriting Pop-ups</b>	This setting will allow you to favorite app drawer pop-ups with “On” and “Off” options.
<b>App Drawer Unfavoritings Pop-ups</b>	This setting will allow you to unfavorite app drawer pop-ups with “On” and “Off” options.
<b>New Text Message Pop-ups</b>	This setting will allow you to have pop-up notifications for new text messages. Setting options are “On” and “Off”.
<b>Missed Calls Message</b>	This setting will allow you to have pop-up notifications for missed calls. Setting options are “On” and “Off”.
<b>Navigation Pop-ups</b>	This setting will allow you to have pop-up notifications for Navigation. Setting options are “On” and “Off”.
<b>Reset App Drawer to Default Order</b>	This setting will reset the app drawer to its factory default layout.
<b>Restore Settings to Default</b>	This setting will return all the previously changed settings to their factory defaults.
<b>More Profile Options</b>	This setting will give access to more profile options.
<b>Warning Cluster Buzzer Volume</b>	This setting will let you adjust the Warning Cluster Buzzer Volume. Selectable options are “Low”, “Mid”, and “High”.
<b>Cluster Options</b>	This setting will display options for the cluster using the Uconnect touchscreen.

Setting Name	Description
<b>Auto-On Comfort</b>	This setting will activate the vehicle's comfort systems and heated seats or heated steering wheel when the vehicle is remote started or ignition is started. The "Off" setting will not activate the comfort systems. The "Remote Start" setting will only activate the comfort systems when using Remote Start. The "All Start" setting will activate the comfort systems whenever the vehicle is started.
<b>Navigation Turn-by-Turn Displayed in Cluster</b>	This setting will display Navigation prompts in the Instrument Cluster Display.
<b>Phone Pop-ups Displayed In Cluster</b>	This setting will display smartphone notifications and messages in the Instrument Cluster Display.
<b>More Profile Options</b>	This setting will open up the Edit Profile tab to adjust profile name, avatar, or to delete the selected profile.
<b>Wireless Charger Status Popups</b>	This setting will display smartphones charging status while on the wireless charger.

## Safety/Driving Assistance

When the Safety/Driving Assistance button is pressed on the touchscreen, the system displays the options related to the vehicle's safety settings. These options will differ depending on the features equipped on the vehicle. The settings may display in list form or within subfolders on the screen. To access a subfolder, select the desired folder; the available options related to that feature will then display on the screen.

### NOTE:

Depending on the vehicle's options, feature settings may vary.

Setting Name	Description
<b>Autonomous Emergency Braking— Located In Autonomous Emergency Braking Submenu</b>	This setting will turn the Forward Collision Warning (FCW) system on or off. The "Off" setting will deactivate the FCW system. The "Warning Only" setting will provide only an audible chime when a collision is detected. The "Warning + Active Braking" setting will provide an audible chime and apply some brake pressure when a collision is detected.
<b>Autonomous Emergency Braking Sensitivity — Located In Autonomous Emergency Braking Submenu</b>	This setting will change the distance at which the Forward Collision Warning alert sounds. The "Medium" setting will have the FCW system signal when an object is in view, and the possibility of a collision is detected. The "Near" setting will have the FCW system signal when the object is closer to the vehicle. The "Far" setting will have the FCW system signal when an object is at a far distance from the vehicle.
<b>Lane Keeping Warning — Located In Lane Keeping Assist submenu</b>	This setting will set the warning type for LaneSense. The available options are "Early", "Medium", and "Late".

Setting Name	Description
Lane Keeping Strength — Located In Lane Keeping Assist submenu	This setting will set the strength of the LaneSense system. The available options are “Low”, “Medium”, and “High”.
Active Driving Assist Steering Wheel Vibration	This setting will turn the Active Driving Assist Steering Wheel Vibration on or off.
Front Park Sensors Volume	This setting adjusts the volume of the Front ParkSense system. The available settings are “Low”, “Medium”, and “High”.
Rear Park Sensors Volume	This setting adjusts the volume of the Rear ParkSense system. The available settings are “Low”, “Medium”, and “High”.
Rear ParkSense Braking Assist	This setting will provide braking assistance if the Rear ParkSense system senses a collision with an object.
Blind Spot Alert	This setting will change the type of alert provided when an object is detected in the vehicle’s blind spot. The “Off” setting will turn off Blind Spot Alert. The “Lights” setting will activate the Blind Spot Alert lights on the outside mirrors. The “Lights & Chime” setting will activate both the lights on the outside mirrors and an audible chime.
Traffic Sign Recognition	This setting will turn Traffic Sign Recognition on or off.
Traffic Sign Assist	This setting will turn Traffic Sign Assist on or off.
Traffic Sign Recognition Warning	This setting will allow you to set the warning type related to the traffic sign. The available options are “Off”, “Visual”, and “Visual + Chime”.
New Speed Zone Indication	This setting will allow you to set if the system will warn you that the speed limit has changed in an area. The available options are “Off”, “Visual”, and “Visual + Chime”.
Driver Attention Assist	This setting will monitor the driver’s driving habits and warn you of any changes, indicating that the driver may be drowsy. The available options are “On” and “Off”.
Highway Assist Steering Wheel Vibration	This setting will customize the Highway Assist Steering Wheel Vibration. The available options are “On” and “Off”.
Side Distance Warning	This setting will customize the Side Distance Warning. The available options are “On” and “Off”.
Hill Start Assist	This setting will turn the Hill Start Assist system on or off.
Intelligent Speed Options	This setting will let you customize your intelligent speed options. Selectable options are “Manual Confirm” and “Auto Confirm”.
New Speed Zone Indication	This setting will allow you to set if the system will warn you that the speed limit has changed in an area. The available options are “Off”, “Visual”, and “Visual + Chime”.
Rear Seat Alert	When this setting is turned on and the rear doors are opened while the engine is running, or if the engine is turned on within 10 minutes of the door opening, a message will appear to check the rear seat when the vehicle is powered OFF.
Front Passenger Airbag	This setting will let you enable or disable the Front Passenger Airbag.

## Clock & Date

When the Clock & Date button is pressed on the touchscreen, the system displays the different options related to the vehicle's internal clock.

**NOTE:**

Depending on the vehicle's options, feature settings may vary.

Setting Name	Description
Sync Time With GPS	This setting will sync the time to the GPS receiver in the system. The system will control the time via the GPS location.
Set Time	This setting will allow you to set the hours and minutes. Sync Time With GPS must be off for this setting to be available. The "+" setting will increase the hours or minutes. The "-" setting will decrease the hours or minutes.
Time Format	This setting will allow you to set the time format (AM/PM). Sync Time With GPS must be off for this setting to be available. The "12 hrs" setting will set the time to a 12-hour format. The "24 hrs" setting will set the time to a 24-hour format. You will also be able to adjust the clock.
Set Date	This setting will allow you to set the date.
Show Time in Status Bar	This setting will place the time in the radio's status bar.
Show Time and Date During Screen Off	This setting will allow you to show the time and date while the screen is off. Available options are "On" and "Off".

5

## Phone/Bluetooth®

When the Phone/Bluetooth® button is pressed on the touchscreen, the system displays the options related to Bluetooth® connectivity from an external audio device or smart-phone. The list of paired audio devices or smartphones can be accessed from this menu.

**NOTE:**

Depending on the vehicle's options, feature settings may vary.

Setting Name	Description
Device Manager	This setting will open the Device Manager main screen.
Do Not Disturb All	This setting will open the Do Not Disturb All settings menu. The available options are "On" and "Off".
Enable Two Active Phones	This setting will enable or disable two active phones within the vehicle. The setting options are "On" and "Off".
Phone Pop-Ups Displayed In Cluster	This setting will activate phone message pop-ups in the Instrument Cluster Display.

## Voice — If Equipped

When the Voice button is pressed on the touchscreen, the system displays the options related to the vehicle's Voice Recognition feature.

**NOTE:**

Depending on the vehicle's options, feature settings may vary.

Setting Name	Description
Voice Options	This setting will allow you to change the system's voice to either "Male" or "Female".
Wake Up Word	This setting will allow you to set the system's "Wake Up" word. The available options are "Off", "Hey, Uconnect", and "Hey, Alfa".
Voice Barge-In	This setting allows you to respond to a Voice Response before the statement is completed by the system. The available options are "On" and "Off".
Show Command List	This setting will allow you to turn the Command List on or off. The "Always" setting will always show the Command List. The "With Help" setting will show the Command List and provide a brief description of what the command does. The "Never" setting will turn the Command List off.

## Navigation — If Equipped

When the Navigation button is pressed on the touchscreen, the system displays options related to the vehicle's built-in Navigation system. These settings can change which icons display on the map, how "time to arrival is calculated", and route types.

For more information on Navigation and settings, refer to your Uconnect Radio Instruction Manual.

## Camera

When the Camera button is pressed on the touchscreen, the system displays the options related to the vehicle's camera features.

**NOTE:**

Depending on the vehicle's options, feature settings may vary.

Setting Name	Description
<b>ParkView Backup Camera Delay</b>	This setting will add a delay to the ParkView Backup Camera when shifting out of REVERSE.
<b>ParkView Backup Camera Active Guidelines</b>	This setting will turn the ParkView Backup Camera Active Guidelines on or off.
<b>Surround View Camera Delay</b>	This setting will add a timed delay to the Surround View Camera when shifting out of REVERSE.
<b>Surround View Camera Guidelines</b>	This setting will turn the Surround View Camera Guidelines on or off.

## Mirrors & Wipers

When the Mirrors & Wipers button is pressed on the touchscreen, the system displays the option related to the vehicle's mirrors and wipers.

**NOTE:**

Depending on the vehicle's options, feature settings may vary.

Setting Name	Description
<b>Rain Sensor</b>	This setting will turn the Rain Sensing Auto Wipers on or off.
<b>Headlights With Wipers</b>	This setting will turn the headlights on when the wipers are activated. Setting options are "On" and "Off".
<b>Auto Folding Side Mirrors</b>	This setting will automatically fold and unfold the side-view mirrors when the vehicle is turned off, the doors are locked, or the key fob button is pushed. The available options are "On" and "Off".

## Lights

When the Lights button is pressed on the touchscreen, the system displays the options related to the vehicle's exterior and interior lights.

### NOTE:

- When the "Daytime Running Lights" feature is selected, the daytime running lights can be turned on or off. This feature is only allowed by law in the country of the vehicle purchase.
- Depending on the vehicle's options, feature settings may vary.

Setting Name	Description
Automatic High Beams	This setting will turn the Auto DimHigh Beam on or off.
Ambient Color Personalization	This setting will redirect to a new menu that will allow you to change the ambient lighting color in the cabin.
Headlight Sensitivity	This setting will allow you to set the sensitivity of the headlights depending on the amount of visible light. The greater the sensitivity set, the less the external light variation required to turn on the lights (e.g. with a setting on level 3 at sunset, the headlights turn on earlier than in levels 1 and 2). The available levels are "Level 1: Minimum Sensitivity", "Level 2: Medium Sensitivity", and "Level 3: Maximum Sensitivity".
Headlight Off Delay	This setting will allow you to set the amount of time it takes for the headlights to shut off after the vehicle is turned off. The available settings are "0 sec", "30 sec", "60 sec", and "90 sec".
Headlight Illumination On Approach	This setting will allow you to set the amount of time it takes for the headlights to shut off after the vehicle is unlocked. The available settings are "0 sec", "30 sec", "60 sec", and "90 sec".
Greeting Lights	This setting will turn the Greeting Lights on or off.
Daytime Running Lights	This setting will allow you to turn the Daytime Running Lights on or off.
Headlight Dip	This setting will lower the headlights when driving on the opposite side of the road. The available options are "On" and "Off".
Flash Lights With Lock	This setting will allow you to turn the flashing of the lights when the Lock button is pushed on the key fob on or off.
Intelligent Ambient Lighting	This setting will allow you to adjust the color of the ambient lighting. The available options are "Color 1" through "Color 5".
Interior Ambient Lighting	This setting will allow you to adjust the brightness of the interior ambient lights. The available options are "Level 1" through "Level 6".
Steering Directed Headlights	This setting will turn the Steering Directed Headlights on or off.



## Brakes

After pressing the Brakes button on the touchscreen, the following settings will be available:

**NOTE:**

Depending on the vehicle's options, feature settings may vary.

Setting Name	Description
Auto Park Brake	This setting will turn the Auto Park Brake on or off.
Brake Service	This setting will allow you to retract the brakes for servicing.
Hold 'n Go	This setting will turn the Hold 'N Go on or off.

## Doors & Locks

When the Doors & Locks button is pressed on the touchscreen, the system displays the options related to locking and unlocking the vehicle's doors.

**NOTE:**

Depending on the vehicle's options, feature settings may vary.

Setting Name	Description
Auto Door Locks	This setting will allow you to change if the doors lock automatically when the vehicle reaches 12 mph (20 km/h).
Auto Unlock On Exit	This setting will unlock the doors when any of the doors are opened from the inside.
Flash Lights With Lock	This setting will allow you to turn the flashing of the lights when the Lock button is pushed on the key fob on or off.
Sound Horn With Lock	This setting will sound the horn when the Lock button is pushed on the key fob. The "Off" setting will not sound the horn when the Lock button is pushed. The "1st Press" setting will sound the horn when the Lock button is pushed once. The "2nd Press" setting will sound the horn when the Lock button is pushed twice.
Sound Horn With Remote Start	This setting will sound the horn when the remote start is activated from the key fob.

Setting Name	Description
<b>Remote Door Unlock/1st Press Of Key Fob Unlocks</b>	This setting will change how many pushes of the Unlock button on the key fob are needed to unlock all the doors. The "Driver Door" setting will only unlock the driver door on the first push on the Unlock button. The "All Doors" setting will unlock all doors on the first push of the Unlock button.
<b>Passive Entry</b>	This setting will allow you to turn the Passive Entry feature (Keyless Enter 'n Go™) on or off.
<b>Power Liftgate Alert</b>	This setting will chime an audible alert when the power liftgate is raising or lowering. Selectable options are "On" and "Off".
<b>Power Trunk Roof Level (Custom)</b>	This setting will let you customize the angle of the power liftgate. Selectable options are "Custom", "Level 1", "Level 2", "Level 3", and "Level 4".
<b>Hands Free Power Liftgate</b>	This setting will use hands-free technology to automatically open or close the liftgate. Selectable options are "On" and "Off".

## Seats & Comfort

When the Seats & Comfort button is pressed on the touchscreen, the system displays the option related to the vehicle's comfort systems when remote start has been activated or the vehicle has been started.

### NOTE:

Depending on the vehicle's options, feature settings may vary.

Setting Name	Description
<b>Auto-On Comfort</b>	This setting will activate the vehicle's comfort systems and heated seats or heated steering wheel when the vehicle is remote started or ignition is started. The "Off" setting will not activate the comfort systems. The "Remote Start" setting will only activate the comfort systems when using Remote Start. The "All Start" setting will activate the comfort systems whenever the vehicle is started.

## Key Off Options

When the Key Off Options button is pressed on the touchscreen, the system displays the options related to vehicle shutoff. These settings will only activate when the ignition is set to OFF.

**NOTE:**

Depending on the vehicle's options, feature settings may vary.

Setting Name	Description
Radio Off Delay	This setting will keep the radio running after the engine is turned off. When any door is opened, the electronics will deactivate. The available settings are "0 min" and "20 min".
Radio Off With Door	This setting will shut the radio off when the door is opened. The available settings are "On" and "Off".
Headlight Off Delay	This setting will allow you to set the amount of time the headlights remain on after the vehicle has been turned off. The "+" will increase the amount of time. The "-" will decrease the amount of time.
Windows With Key Fob	This setting will allow you to control window function while the vehicle is off. The available options are "On" and "Off".

5

## Audio

When the Audio button is pressed on the touchscreen, the system displays options related to the vehicle's sound system. These settings can change the audio location within the vehicle, adjust the bass or treble levels, and auto-play settings from an audio device or smartphone.

**NOTE:**

Depending on the vehicle's options, feature settings may vary.

Setting Name	Description
Balance/Fade	This setting will adjust audio levels from specific speakers in the front/back and left/right of the vehicle. The Speaker icon can be moved to set audio location.
Equalizer	This setting will adjust the "Bass", "Mid", and "Treble" ranges of the audio.
Speed Adjusted Volume	This setting will adjust audio volume as speeds increase. At a higher setting, the volume will increase more as the vehicle speeds up. The available settings are "Off", "1", "2", and "3".
Surround Sound	This setting will turn the Surround Sound system on or off.
Auto Play	This setting will automatically begin playing audio from a connected device.

Setting Name	Description
<b>Auto-On Radio</b>	This setting will automatically turn the radio on when the vehicle is started. The available settings are "Off", "On", and "Recall Last". With "Recall Last", the system resumes the previous task before vehicle shut off.
<b>Radio off With Door</b>	This setting will keep the radio on when a door is opened or until the Radio Off Delay time is reached. The available settings are "On" and "Off".
<b>Loudness</b>	This setting improves the sound quality at lower volumes. The available options are "On" and "Off".
<b>Volume Adjustment</b>	This setting will allow you to set the audio volume levels for each option (Media, Phone, Navigation, etc.). You can set the volume between 0 and 38.

## Notifications

When the Notifications button is pressed on the touchscreen, the system displays the options related to Notifications for the system.

**NOTE:**

Depending on the vehicle's options, feature settings may vary.

Setting Name	Description
<b>Notification Sounds</b>	This setting controls the Notification chime that plays when a new notification is sent. The options are "On" and "Off".
<b>App Drawer Favoriting Pop-Ups</b>	This setting turns the App Favorited Pop-Up on or off.
<b>App Drawer Unfavoriting Pop-Ups</b>	This setting turns the App Unfavorited Pop-Up on or off.
<b>New Text Message Pop-Ups</b>	This setting turns receiving/storing a pop-up for new text messages of any connected phone on or off.
<b>Missed Calls Message</b>	This setting turns receiving/storing a pop-up for missed calls of any connected phone on or off.
<b>Navigation Pop-Ups</b>	This setting turns receiving/storing predictive Navigation Pop-Ups on or off.
<b>Wireless Charger Status Pop-Ups</b>	This setting turns the Wireless Charger Status Pop-Ups on or off.

## SiriusXM® Setup

When the SiriusXM® Setup button is pressed on the touchscreen, the system displays the options related to SiriusXM® satellite radio. These settings can be used to skip specific radio channels and restart favorite songs from the beginning.

**NOTE:**

- A subscription to SiriusXM® satellite radio is required for these settings to be functional.
- Depending on the vehicle's options, feature settings may vary.

Setting Name	Description
SiriusXM® Account, Profile, And Settings	This setting will redirect you to the SiriusXM® settings menu within the SiriusXM® menu.
Block Explicit	This setting will skip over content labeled as explicit. The available settings are "On" and "Off".

## Geolocation

After pressing the Geolocation button on the touchscreen, the following setting will be available:

**NOTE:**

Depending on the vehicle's options, feature settings may vary.

Setting Name	Description
Geolocation	This setting will turn the Geolocation on or off.

## Software Updates

When the Software Updates button is pressed on the touchscreen, the system will display the setting related to updating the Uconnect software.

**NOTE:**

Depending on the vehicle's options, feature settings may vary.

Setting Name	Description
Software Downloads over Wi-Fi	This setting will allow software updates to happen over Wi-Fi. Selectable options for the setting are "On" and "Off".

## System Information

When the System Information button is pressed on the touchscreen, the system displays the radio system information.

**NOTE:**

Depending on the vehicle's options, feature settings may vary.

Setting Name	Description
Software Licenses	This will display the software licensing information screen.
Version Information	When this feature is selected, a Version Information screen will appear, displaying information about the version of your radio.
License Information	When this feature is selected, a License Information screen will appear, displaying the licensing information of your radio.

## Reset

When the Reset button is pressed on the touchscreen, the system displays the options related to resetting the Uconnect system back to its default settings. These settings can clear personal data and reset selected settings from other menus.

### NOTE:

- If you want or need to perform a system reset, you can proceed by selecting the dedicated item in the Settings menu, by pushing and holding the ON/OFF button next to the shifter, or by pressing and holding the ON/OFF button on the radio touchscreen for more than five seconds.
- Depending on the vehicle's options, feature settings may vary.

Setting Name	Description
Restart Radio	This setting will reboot the radio.
Reset Apps Drawer To Default Order	This setting will return the apps drawer to the default order. The available options are "Yes" and "Cancel". The X button can also be pressed to cancel the screen.
Restore Apps	This setting will delete all of the installed apps if there is an issue with using or installing an app. The available options are "Back" and "Next".
Restore Settings to Default	This setting will return all the previously changed settings to their factory defaults.  <b>NOTE:</b> When Restoring Settings to Default, turn the ignition OFF and wait a few minutes before restarting. The incorrect execution of this operation and the short period of time between the ignition being in ON/RUN and OFF could result in the privacy settings not being maintained. In this case, repeat the operation and extend the waiting time between ignition being in ON/RUN and OFF.
Clear Personal Data	This setting will display a pop-up that gives you the option to clear all personal data from the system, including Bluetooth® devices and presets.  <b>NOTE:</b> Performing this function may take several minutes to complete.
Reset Performance Values	This setting will reset the performance values from your vehicle.
Reset Wi-Fi Password For Projection	This setting will allow you to reset the vehicle's Wi-Fi password for smartphone projection. The available options are "Yes" and "Cancel". The X button can also be pressed to cancel the screen.
Factory Reset	This setting will restore the radio to its factory default settings.

## STEERING WHEEL AUDIO CONTROLS — IF EQUIPPED

The audio controls are located on the front of the steering wheel on the right side.

The length of the press on certain buttons can change the function of these buttons.

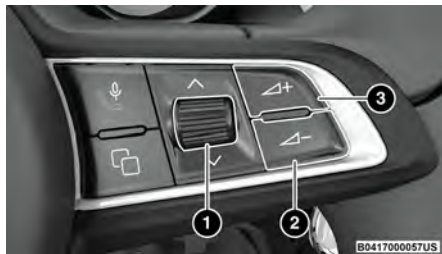

**Remote System Controls**

- 1 — Scroll Radio Stations/Tracks
- 2 — Decrease Volume
- 3 — Increase Volume

### Controls + / -

In Radio, Media, and Phone Modes, using these will increase or decrease the volume.

## STEERING WHEEL ROTARY CONTROL

- Rotate upwards in Radio Mode to select the previous radio station and downwards to select the next radio station.
- Rotate upwards in Media Mode to select the previous track and downwards to select the next track.

### NOTE:

Press Main Screen Menu button to toggle to Radio Mode from the Instrument Cluster display.

## CONTROLS ON CENTRAL TUNNEL

A rotary control is present on the central tunnel to the right side of the gear shifter and has different functionality depending on the kind of pressing and/or rotating.



**Rotary Control Central Tunnel**

### Short Press

This will activate or deactivate the Mute function for playback of audio tracks, radio stations, App streaming and incoming calls.

### Long Press

This will turn on or off the Uconnect system.

### Rotate

This will increase or decrease the volume.

## MY CAR

My Car is an application that provides indicators that will help you gain familiarity with the capabilities of your vehicle in real time.

To access My Car options, select “My Car” on the touchscreen within the Vehicle tab.

My Car includes:

- Overview
- Drive Mode Explorer

Press the desired My Car item on the touchscreen to view the content related to it.

The following describes each feature and its operation:

### Overview

The main features of this page are showing when your vehicle is due for service and the status of your tires.



**My Car Overview**



## Drive Mode Explorer

This page will show content related to the Alfa DNA system. Options on the Alfa DNA Selector are “Dynamic”, “Natural”, and “Advance Efficiency”. Some of the following is information that will be relayed on the touchscreen:

- Engine Torque
- Gas Pedal
- Shifting
- Regenerative Braking
- e-TRACTION
- Steering



**My Car Drive Mode Explorer**

The Alfa DNA System Selector will affect the options for Drive Mode Explorer ↷ page 109.

## PERFORMANCE PAGES

The Performance Pages is an application that provides performance indicators that will help you gain familiarity with the capabilities of your vehicle in real time.

To access Performance options, select “Performance” from the top page headers within the Vehicle tab.

The Performance Pages includes:

- Technical Gauges
- Consumption History — If Equipped
- Accessory Gauges

### Viewing Content

Press the desired Performance item on the touchscreen to view the content related to it.

The following describes each feature and its operation:

## TECHNICAL GAUGES

Selecting “Technical Gauges” will display the following items:

- Pressure (Turbo)
- Engine Torque Value (Torque)



**Technical Gauges**

### NOTE:

The graphic displayed may change depending on the different versions and engines.

## CONSUMPTION HISTORY — IF EQUIPPED

Selecting “Consumption History” will relay information regarding the fuel consumption of the vehicle. This information can be relayed in 60 graphic notches per minute.



**Consumption History**

5

### Fuel Consumption Chart

Each column shown in the graph displays the average “Instantaneous Consumption” recorded during the last minute of travel.

The fuel consumption graphic bar is shown on the display with “n examples” in which the last column represents the last recorded consumption values. This column will be displayed in a lighter color than the other columns for the oldest fuel consumption.

### Consumption Reset

Press the Reset icon on the display to reset the consumption values. A message will appear on the screen. Select “Yes” to reset the values.

## ACCESSORY GAUGES

Selecting “Accessory Gauges” will relay the following information:

- “Oil Temp” — engine oil temperature
- “Transm. Temp” — transmission temperature
- “Battery Voltage” — conventional battery state of charge



**Accessory Gauges**

## RADIO OPERATION AND MOBILE PHONES

Under certain conditions, the mobile phone being on in your vehicle can cause erratic or noisy performance from your radio. This condition may be lessened or eliminated by repositioning the mobile phone within the vehicle. This condition is not harmful to the radio. If your radio performance does not satisfactorily improve from repositioning the mobile phone, it is recommended that the volume be turned down or off during mobile phone operation when not using the Uconnect system.

## REGULATORY AND SAFETY INFORMATION

### US/CANADA

#### Exposure to Radio Frequency Radiation

The radiated output power of the internal wireless radio is far below the FCC and IC radio frequency exposure limits. Nevertheless, the wireless radio will be used in such a manner that the radio is 8 inches (20 cm) or further from the human body.

The internal wireless radio operates within guidelines found in radio frequency safety standards and recommendations, which reflect the consensus of the scientific community.

The radio manufacturer believes the internal wireless radio is safe for use by consumers. The level of energy emitted is far less than the electromagnetic energy emitted by wireless devices such as mobile phones. However, the use of wireless radios may be restricted in some situations or environments, such as aboard airplanes. If you are unsure of restrictions, you are encouraged to ask for authorization before turning on the wireless radio → page 282.

# SAFETY

## SAFETY FEATURES

### ANTI-LOCK BRAKE SYSTEM (ABS)

The ABS provides increased vehicle stability and brake performance under most braking conditions. The system automatically prevents wheel lock and enhances vehicle control during braking.

The ABS performs a self-check cycle to ensure that the ABS is working properly each time the vehicle is started and driven. During this self-check, you may hear a slight clicking sound as well as some related motor noises.

The ABS is activated during braking when the system detects one or more wheels are beginning to lock. Road conditions such as ice, snow, gravel, bumps, railroad tracks, loose debris, or panic stops may increase the likelihood of ABS activation(s).

You also may experience the following normal characteristics when the ABS activates:

- ABS motor noise or clicking sounds (you may continue to hear for a short time after the stop)
- Brake pedal pulsations
- A slight drop of the brake pedal at the end of the stop

The ABS is designed to function with the Original Equipment Manufacturer (OEM) tires. Modification may result in degraded ABS performance.

#### WARNING!

- The ABS contains sophisticated electronic equipment that may be susceptible to interference caused by improperly installed or high output radio transmitting equipment. This interference can cause possible loss of anti-lock braking capability. Installation of such equipment should be performed by qualified professionals.
- Pumping of the Anti-Lock Brakes will diminish their effectiveness and may lead to a collision. Pumping makes the stopping distance longer. Just press firmly on your brake pedal when you need to slow down or stop.
- The ABS cannot prevent the natural laws of physics from acting on the vehicle, nor can it increase braking or steering efficiency beyond that afforded by the condition of the vehicle brakes and tires or the traction afforded.
- The ABS cannot prevent collisions, including those resulting from excessive speed in turns, following another vehicle too closely, or hydroplaning.
- The capabilities of an ABS equipped vehicle must never be exploited in a reckless or dangerous manner that could jeopardize the user's safety or the safety of others.

### Anti-Lock Brake System (ABS) Warning Light

The yellow ABS Warning Light will turn on when the ignition is placed in the ON/RUN mode and may stay on for as long as four seconds.

If the ABS Warning Light remains on or comes on while driving, it indicates that the anti-lock portion of the brake system is not functioning and that service is required. However, the conventional brake system will continue to operate normally if the ABS Warning Light is on.

If the ABS Warning Light is on, the brake system should be serviced as soon as possible to restore the benefits of Anti-Lock Brakes. If the ABS Warning Light does not come on when the ignition is placed in the ON/RUN mode, have the light repaired as soon as possible.

### ELECTRONIC BRAKE CONTROL (EBC) SYSTEM

Your vehicle is equipped with an advanced Electronic Brake Control (EBC) system. This system includes Anti-Lock Brake System (ABS), Brake Assist System (BAS), Electronic Brake Force Distribution (EBD), Electronic Roll Mitigation (ERM), Electronic Stability Control (ESC), Hill Start Assist (HSA), and Traction Control System (TCS). These systems work together to enhance both vehicle stability and control in various driving conditions.

Your vehicle may also be equipped with Dynamic Steering Torque (DST), Hill Descent Control (HDC), Rain Brake Support (RBS), Ready Alert Braking (RAB), and Trailer Sway Control (TSC).

### Brake Assist System (BAS)

The BAS is designed to optimize the vehicle's braking capability during emergency braking maneuvers. The system detects an emergency braking situation by sensing the rate and amount of brake application and then applies optimum pressure to the brakes. This can help reduce braking distances. The BAS complements the Anti-Lock Brake System (ABS). Applying the brakes very quickly results in the best BAS assistance. To receive the benefit of the system, you must apply continuous braking pressure during the stopping sequence (do not "pump" the brakes). Do not reduce brake pedal pressure unless braking is no longer desired. Once the brake pedal is released, the BAS is deactivated.

#### WARNING!

The Brake Assist System (BAS) cannot prevent the natural laws of physics from acting on the vehicle, nor can it increase the traction afforded by prevailing road conditions. BAS cannot prevent collisions, including those resulting from excessive speed in turns, driving on very slippery surfaces, or hydroplaning. The capabilities of a BAS-equipped vehicle must never be exploited in a reckless or dangerous manner, which could jeopardize the user's safety or the safety of others.

### Brake System Warning Light

The red Brake System Warning Light will turn on when the ignition is placed in the ON/RUN mode and may stay on for as long as four seconds.

If the Brake System Warning Light remains on or comes on while driving, it indicates that the brake system is not functioning properly and that immediate service is required. If the Brake System Warning Light does not come on when the ignition is placed in the ON/RUN mode, have the light repaired as soon as possible.

### Dynamic Steering Torque (DST)

DST is a feature of the Electronic Stability Control (ESC) and Electric Power Steering (EPS) modules that provides torque at the steering wheel for certain driving conditions in which the ESC module is detecting vehicle instability. The torque that the steering wheel receives is only meant to help the driver realize optimal steering behavior in order to reach/maintain vehicle stability. The only notification the driver receives that the feature is active is the torque applied to the steering wheel.

#### NOTE:

The DST feature is only meant to help the driver realize the correct course of action through small torques on the steering wheel, which means the effectiveness of the DST feature is highly dependent on the driver's sensitivity and overall reaction to the applied torque. It is very important to realize that this feature will not steer the vehicle, meaning the driver is still responsible for steering the vehicle.

### Electronic Brake Force Distribution (EBD)

EBD manages the distribution of the braking torque between the front and rear axles by limiting braking pressure to the rear axle. This is done to prevent overslip of the rear wheels to avoid vehicle instability, and to prevent the rear axle from entering ABS before the front axle.

### Electronic Roll Mitigation (ERM)

ERM anticipates the potential for wheel lift by monitoring the driver's steering wheel input and the speed of the vehicle. When ERM determines that the rate of change of the steering wheel angle and vehicle's speed are sufficient to potentially cause wheel lift, it then applies the appropriate brake and may also reduce engine power to lessen the chance that wheel lift will occur. ERM can only reduce the chance of wheel lift occurring during severe or evasive driving maneuvers; it cannot prevent wheel lift due to other factors, such as road conditions, leaving the roadway, or striking objects or other vehicles.

#### WARNING!

Many factors, such as vehicle loading, road conditions and driving conditions, influence the chance that wheel lift or rollover may occur. ERM cannot prevent all wheel lift or rollovers, especially those that involve leaving the roadway or striking objects or other vehicles. The capabilities of an ERM-equipped vehicle must never be exploited in a reckless or dangerous manner which could jeopardize the user's safety or the safety of others.

## Electronic Stability Control (ESC)

ESC enhances directional control and stability of the vehicle under various driving conditions. ESC corrects for oversteering or understeering of the vehicle by applying the brake of the appropriate wheel(s) to counteract these conditions. Engine power may also be reduced to help the vehicle maintain the desired path.

- Oversteer — when the vehicle is turning more than appropriate for the steering wheel position.
- Understeer — when the vehicle is turning less than appropriate for the steering wheel position.

ESC uses sensors in the vehicle to determine the vehicle path intended by the driver and compares it to the actual path of the vehicle. When the actual path does not match the intended path, ESC applies the brake of the appropriate wheel to assist in counteracting the oversteer or understeer condition.

The ESC Activation/Malfunction Indicator Light located in the instrument cluster will start to flash as soon as the ESC system becomes active. The ESC Activation/Malfunction Indicator Light also flashes when the TCS is active. If the ESC Activation/Malfunction Indicator Light begins to flash during acceleration, ease up on the accelerator and apply as little throttle as possible. Be sure to adapt your speed and driving to the prevailing road conditions.

### WARNING!

- Electronic Stability Control (ESC) cannot prevent the natural laws of physics from acting on the vehicle, nor can it increase the traction afforded by prevailing road conditions. ESC cannot prevent accidents, including those resulting from excessive speed in turns, driving on very slippery surfaces, or

*(Continued)*

### WARNING!

hydroplaning. ESC also cannot prevent accidents resulting from loss of vehicle control due to inappropriate driver input for the conditions. Only a safe, attentive, and skillful driver can prevent accidents. The capabilities of an ESC equipped vehicle must never be exploited in a reckless or dangerous manner which could jeopardize the user's safety or the safety of others.

- Vehicle modifications, or failure to properly maintain your vehicle, may change the handling characteristics of your vehicle, and may negatively affect the performance of the ESC system. Changes to the steering system, suspension, braking system, tire type and size or wheel size may adversely affect ESC performance. Improperly inflated and unevenly worn tires may also degrade ESC performance. Any vehicle modification or poor vehicle maintenance that reduces the effectiveness of the ESC system can increase the risk of loss of vehicle control, vehicle rollover, personal injury and death.

## ESC Operating Modes

Depending upon model and mode of operation, the ESC system may have multiple operating modes.

### ESC On

This is the normal operating mode for the ESC. Whenever the vehicle is started, the ESC system will be in this mode. This mode should be used for most driving conditions. Alternate ESC modes should only be used for specific reasons as noted in the following paragraphs.

### Full Off

To enter the "Full Off" mode, rotate the Alfa DNA system selector to the "OFF" position for two seconds while the vehicle is stopped with the engine running. After two seconds, a chime will sound, the ESC OFF Indicator Light will illuminate, and the "ESC OFF" message will display in the instrument cluster. To turn ESC on again, rotate the Alfa DNA system selector to the "OFF" position for two seconds and the system will be set to "d" mode.

### WARNING!

- In the ESC "Full Off" mode, the engine torque reduction and stability features are disabled. Therefore, enhanced vehicle stability offered by the ESC system is unavailable. In an emergency evasive maneuver, the ESC system will not engage to assist in maintaining stability. ESC "Full Off" mode is intended for off-highway or off-road use only.
- With the ESC switched off, the enhanced vehicle stability offered by ESC is unavailable. In an emergency evasive maneuver, the ESC system will not engage to assist in maintaining stability. ESC "Full Off" mode is only intended for off-highway or off-road use.
- The Electronic Stability Control (ESC) cannot prevent the natural laws of physics from acting on the vehicle, nor can it increase the traction afforded by prevailing road conditions. ESC cannot prevent all accidents, including those resulting from excessive speed in turns, driving on very slippery surfaces, or hydroplaning. ESC also cannot prevent collisions.

## ESC Activation/Malfunction Indicator Light And ESC OFF Indicator Light



The ESC Activation/Malfunction Indicator Light in the instrument cluster will come on when the ignition is placed in the ON mode. It should go out with the engine running. If the ESC Activation/Malfunction Indicator Light comes on continuously with the engine running, a malfunction has been detected in the ESC system. If this light remains on after several ignition cycles, and the vehicle has been driven several miles (km) at speeds greater than 30 mph (48 km/h), see an authorized dealer as soon as possible to have the problem diagnosed and corrected.

The ESC Activation/Malfunction Indicator Light starts to flash as soon as the tires lose traction and the ESC system becomes active. The ESC Activation/Malfunction Indicator Light also flashes when Traction Control System (TCS) is active. If the ESC Activation/Malfunction Indicator Light begins to flash during acceleration, ease up on the accelerator and apply as little throttle as possible. Be sure to adapt your speed and driving to the prevailing road conditions.



The ESC OFF Indicator Light indicates the customer has elected to have the Electronic Stability Control (ESC) in a reduced mode.

### NOTE:

- The ESC Activation/Malfunction Indicator Light and the ESC OFF Indicator Light come on momentarily each time the ignition is placed in the ON/RUN position.

- Each time the ignition is placed in the ON/RUN position, the ESC system will be on even if it was turned off previously.
- The ESC system will make buzzing or clicking sounds when it is active. This is normal; the sounds will stop when ESC becomes inactive following the maneuver that caused the ESC activation.

## Emergency Stop Signal (ESS) — If Equipped

The ESS activates the hazard lights at a faster than normal speed when heavy brake pressure is applied. ESS will only activate when the speed is above 31 mph (50 km/h). The ESS operates independently of other lamps, and will turn on and off automatically. This indicates to others that the vehicle is stopping quickly.

### NOTE:

- A warning light will illuminate within the instrument cluster to inform the driver that the ESS feature has been activated.
- When towing a trailer, ESS will also activate the rear indicator lights of the trailer.

## Hill Start Assist (HSA)

HSA is designed to mitigate roll back from a complete stop while on an incline. If the driver releases the brake while stopped on an incline, HSA will continue to hold the brake pressure for a short period. If the driver does not apply the throttle before this time expires, the system will release brake pressure and the vehicle will roll down the hill as normal.

The following conditions must be met in order for HSA to activate:

- The feature must be enabled.
- The vehicle must be stopped.
- The parking brake must be off.
- The driver's door must be closed.
- The vehicle must be on a sufficient grade.
- The gear selection must match vehicle uphill direction (i.e., vehicle facing uphill is in forward gear; vehicle backing uphill is in REVERSE gear).
- HSA will work in REVERSE gear and all forward gears. The system will not activate if the transmission is in PARK or NEUTRAL.

### WARNING!

There may be situations where the Hill Start Assist (HSA) will not activate and slight rolling may occur, such as on minor hills or with a loaded vehicle, or while pulling a trailer. HSA is not a substitute for active driving involvement. It is always the driver's responsibility to be attentive to distance to other vehicles, people, and objects, and most importantly brake operation to ensure safe operation of the vehicle under all road conditions. Your complete attention is always required while driving to maintain safe control of your vehicle. Failure to follow these warnings can result in a collision or serious personal injury.

## Rain Brake Support (RBS)

RBS may improve braking performance in wet conditions. It will periodically apply a small amount of brake pressure to remove any water buildup on the front brake rotors. It functions when the windshield wipers are in LO or HI speed. When Rain Brake Support is active, there is no notification to the driver and no driver interaction is required.

## Ready Alert Braking (RAB)

RAB may reduce the time required to reach full braking during emergency braking situations. It anticipates when an emergency braking situation may occur by monitoring how fast the throttle is released by the driver. The Electronic Brake Controller (EBC) system will prepare the brake system for a panic stop.

## Traction Control System (TCS)

The TCS monitors the amount of wheel spin for each of the driven wheels. If wheel spin is detected, the TCS may apply brake pressure to the spinning wheel(s) and/or reduce vehicle power to provide enhanced acceleration and stability. A feature of the TCS, Brake Limited Differential (BLD) functions similarly to a limited slip differential and controls the wheel spin across a driven axle. If one wheel on a driven axle is spinning faster than the other, the system will apply the brake of the spinning wheel. This will allow more vehicle torque to be applied to the wheel that is not spinning. BLD may remain enabled even if TCS and ESC are in reduced modes.

## AUXILIARY DRIVING SYSTEMS

### BLIND SPOT MONITORING (BSM) — IF EQUIPPED

The BSM system uses two radar sensors, located inside the rear fascia/bumper, to detect highway licensable vehicles (automobiles, trucks, motorcycles, etc.) that enter the blind spot zones from the rear/front/side of the vehicle.

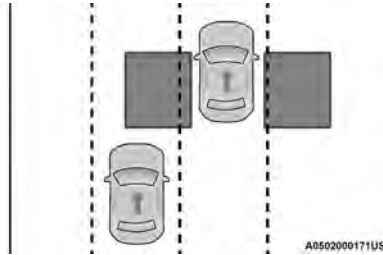

Rear Detection Zones

When the vehicle is started, the BSM Warning Light will momentarily illuminate in both outside rearview mirrors to let the driver know that the system is operational. The BSM system sensors operate when the vehicle is in any forward gear and enters standby mode when the vehicle is in PARK.

The BSM detection zone covers approximately one lane width, 12 ft (3.8 m), on both sides of the vehicle. The zone length starts at the outside mirror and extends approximately 10 ft (3 m) beyond the rear fascia/bumper of the vehicle. The BSM system monitors the detection zones on both sides of the vehicle when the vehicle speed reaches approximately 6 mph (10 km/h) or higher and will alert the driver of vehicles in these areas.

#### NOTE:

- The BSM system DOES NOT alert the driver about rapidly approaching vehicles that are outside the detection zones.
- The BSM system will automatically disable when a trailer is detected. If the attached trailer is not detected, the system detection zone DOES NOT change. Therefore, visually verify the adjacent lane is clear for both your vehicle and trailer before making a lane change. If the trailer or other object (i.e., bicycle, sports equipment) extends beyond the side of your vehicle, this may result in the BSM Warning Light remaining illuminated the entire time the vehicle is in a forward gear. It may be necessary to deactivate the BSM system manually to avoid mis-detection → page 149.

The BSM system can become blocked if snow, ice, mud, or other road contaminations accumulate on the rear fascia/bumper where the radar sensors are located. The system may also detect blockage if the vehicle is operated in areas with extremely low radar returns such as a desert or parallel to a large elevation drop. If blockage is detected, a "Blind Spot Temporarily Unavailable, Sensor Blocked" message will display in the cluster, both mirror lights will illuminate, and BSM and RCP alerts will not occur. This is normal operation. The system will automatically recover and resume function when the condition clears or when an ignition cycle occurs. To minimize system blockage, do not block the area of the rear fascia/bumper where the radar sensors are located with foreign objects (bumper stickers, bicycle racks, etc.) and keep it clear of road contaminations.



B0503001279US

**Radar Sensor Location (Driver Side Shown)**

The BSM system will provide a visual alert in the appropriate side view mirror based on a detected object when enabled. If the turn signal is then activated, and it corresponds to an alert present on that side of the vehicle, an audible chime will also be sounded when chimes are enabled. In addition to the audible alert the radio (if on) will also be muted during the chime event → page 176.



B0503001271US

**Warning Light Location**

As part of the Lane Keep Assist system, if the vehicle begins to drift into an adjacent lane that has an active LED indication, the LED will flash if steering torque is provided to guide the vehicle back to the center of the lane → page 133.

The BSM system monitors the detection zone from three different entry points (side, rear, front) while driving to see if an alert is necessary. The BSM system will issue an alert during these types of zone entries.

### Entering From The Side

Vehicles that move into your adjacent lanes from either side of the vehicle.

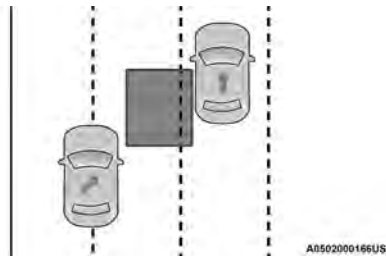

A0502000166US

**Side Monitoring**

### Entering From The Rear

Vehicles that come up from behind your vehicle on either side and enter the rear detection zone with a relative speed of less than 30 mph (48 km/h).

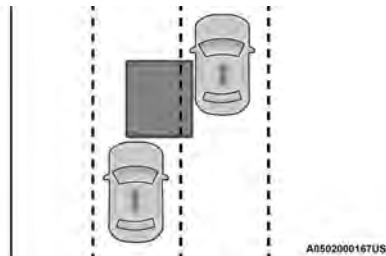

A0502000167US

**Rear Monitoring**



### Overtaking Traffic

If you pass another vehicle slowly with a relative speed less than 10 mph (16 km/h), the warning light will be illuminated. If the difference in speed between the two vehicles is greater than 10 mph (16 km/h), the warning light may not illuminate.

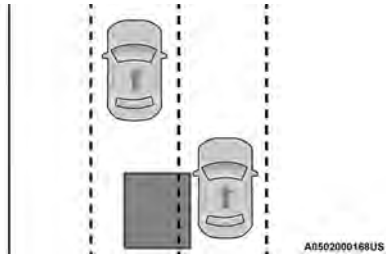

Overtaking/Approaching

A0502000168US

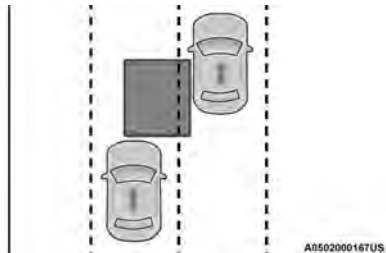

Overtaking/Passing

A0502000167US

The BSM system is designed not to issue an alert on stationary objects such as guardrails, posts, walls, foliage, berms, etc. However, occasionally the system may alert on such objects. This is normal operation and your vehicle does not require service.

The BSM system will not alert you of objects that are traveling in the opposite direction of the vehicle in adjacent lanes → page 282.

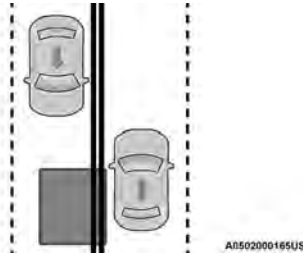

Opposing Traffic

A0502000165US

#### WARNING!

The Blind Spot Monitoring system is only an aid to help detect objects in the blind spot zones. The BSM system is not designed to detect pedestrians, bicyclists, or animals. Even if your vehicle is equipped with the BSM system, always check your vehicle's mirrors, glance over your shoulder, and use your turn signal before changing lanes. Failure to do so can result in serious injury or death.

### Rear Cross Path (RCP)

RCP is intended to aid the driver when backing out of parking spaces where their vision of oncoming vehicles may be blocked. Proceed slowly and cautiously out of the parking space until the rear end of the vehicle is exposed. The RCP system will then have a clear view of the cross traffic and if an oncoming vehicle is detected, alert the driver.

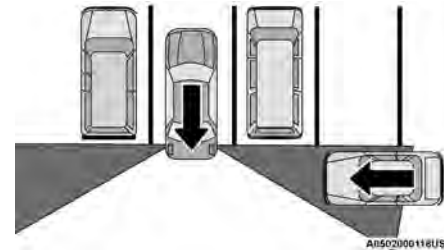

RCP Detection Zones

A0502000116US

RCP monitors the rear detection zones on both sides of the vehicle, for objects that are moving toward the side of the vehicle with a minimum speed of approximately 3 mph (5 km/h), to objects moving a maximum of approximately 20 mph (32 km/h), such as in parking lot situations.

When RCP is on and the vehicle is in REVERSE (R), the driver is alerted using both the visual and audible alarms, including reducing the radio volume anytime the system is enabled regardless of the chime setting.

**NOTE:**

In a parking lot situation, oncoming vehicles can be blocked by vehicles parked on either side. If the sensors are blocked by other structures or vehicles, the system will not be able to alert the driver.

**WARNING!**

Rear Cross Path Detection (RCP) is not a backup aid system. It is intended to be used to help a driver detect an oncoming vehicle in a parking lot situation. Drivers must be careful when backing up, even when using RCP. Always check carefully behind your vehicle, look behind you, and be sure to check for pedestrians, animals, other vehicles, obstructions, and blind spots before backing up. Failure to do so can result in serious injury or death.

**Blind Spot Modes**

Blind Spot Alert has three selectable modes of operation that are available in the Uconnect system.

**Blind Spot Alert Lights Only (Default Setting)**

When operating in Lights Only mode, the BSM system will provide a visual alert in the appropriate side view mirror based on a detected object. However, when the system is operating in Rear Cross Path (RCP) mode, the system will respond with both visual and audible alerts when a detected object is present. Whenever an audible alert is requested, the radio is muted for the duration of the chime.

**Blind Spot Alert Lights/Chime**

When operating in Blind Spot Alert Lights/Chime mode, the BSM system will provide a visual alert in the appropriate side view mirror based on a detected object. If the turn signal is then activated, and it corresponds to

an alert present on that side of the vehicle, an audible chime will also be sounded. Whenever a turn signal and detected object are present on the same side at the same time, both the visual and audible alerts will be issued. In addition to the audible alert the radio (if on) will also be muted.

When the system is in RCP, the system shall respond with both visual and audible alerts when a detected object is present. Whenever an audible alert is requested, the radio volume is reduced. Turn/hazard signal status is ignored; the RCP state always requests the chime.

**Blind Spot Alert Off**

When the BSM system is turned off, there will be no visual or audible alerts from either the BSM or RCP systems.

**NOTE:**

The BSM system will store the current operating mode when the vehicle is shut off. Each time the vehicle is started the previously stored mode will be recalled and used.

**Blocked Sensor**

If the system detects degraded performance due to contamination or foreign objects, a message will warn you of a blocked sensor and the warning indicators in side view mirrors will be illuminated. The warning indicators will remain illuminated until blockage clearing conditions are met. First clear the fascia/bumper area around the sensors of the blockage. After removing the blockage, reset the system by cycling the ignition from ON to OFF and then back ON.

**FORWARD COLLISION WARNING (FCW) WITH MITIGATION — IF EQUIPPED**

FCW with Mitigation provides the driver with audible warnings, visual warnings (within the instrument cluster display), and may apply a brake jerk to warn the driver when it detects a potential frontal collision. The warnings and limited braking are intended to provide the driver with enough time to react, avoid or mitigate the potential collision.

**NOTE:**

FCW monitors the information from the forward looking sensors/cameras as well as the Electronic Brake Controller (EBC), to calculate the probability of a forward collision. When the system determines that a forward collision is probable, the driver will be provided with audible and visual warnings and may provide a brake jerk warning.

If the driver does not take action based upon these progressive warnings, then the system will provide a limited level of active braking to help slow the vehicle and mitigate the potential forward collision. If the driver reacts to the warnings by braking and the system determines that the driver intends to avoid the collision by braking but has not applied sufficient brake force, the system will compensate and provide additional brake force as required.

If a Forward Collision Warning with Mitigation event begins at a speed below 39 mph (62 km/h), the system may provide the maximum braking possible to mitigate the potential forward collision. If the Forward Collision Warning with Mitigation event stops the vehicle completely, the system will hold the vehicle at standstill for two seconds and then release the brakes.



FCW Message

When the system determines a collision with the vehicle in front of you is no longer probable, the warning message will be deactivated ↪ page 282.

**NOTE:**

- The minimum speed for FCW activation is 3mph (5 km/h).
- The FCW alerts may be triggered on objects other than vehicles such as guardrails or sign posts based on the course prediction. This is expected and is a part of normal FCW activation and functionality.
- It is unsafe to test the FCW system. To prevent such misuse of the system, after four Active Braking events within a key cycle, the Active Braking portion of FCW will be deactivated until the next key cycle.
- The FCW system is intended for on-road use only. If the vehicle is taken off-road, the FCW system should be deactivated to prevent unnecessary warnings to the surroundings.

- The FCW system can become temporarily inoperative due to heavy rain, sun rays, snow, ice, mud, or other road contaminations accumulate on the front fascia/bumper where the camera is located. If blockage is detected, a "FCW Unavailability Due To Camera Blindness" message will display in the cluster and FCW will not function as intended. If a second occurrence happens within the same key cycle, a FCW telltail light will illuminate only. This is normal operation. The system will automatically recover and resume function when the condition clears.

**WARNING!**

Forward Collision Warning (FCW) is not intended to avoid a collision on its own, nor can FCW detect every type of potential collision. The driver has the responsibility to avoid a collision by controlling the vehicle via braking and steering. Failure to follow this warning could lead to serious injury or death.

**FCW Settings**

The Forward Collision menu setting is located in the Uconnect Settings ↪ page 149.

**NOTE:**

The default status of FCW is "Full On," this allows the system to provide warning and autonomous braking in the event of a potential frontal collision.

Changing the FCW status to "Only Warning" prevents the system from providing autonomous braking, or additional brake support if the driver is not braking adequately in the event of a potential frontal collision.

Changing the FCW status to "Off" deactivates the system, so no warning or autonomous braking will be available in case of a possible collision.

**NOTE:**

The FCW system state is kept in memory from one ignition cycle to the next. If the system is turned off, it will remain off when the vehicle is restarted.

**Changing FCW Sensitivity And Operating Status**

The FCW Sensitivity and Active Braking status are programmable through the Uconnect system  
↪ page 149.

The default sensitivity of FCW is the "Medium" setting and the system status is "Warning & Braking". This allows the system to warn the driver of a possible collision with the vehicle in front using audible/visual warnings and it applies autonomous braking.

By changing the FCW status setting to "Far", the system provides possible collision warnings on objects farther away. This results in earlier warnings and provides the most reaction time to avoid possible collisions.

**NOTE:**

The "Far" setting may result in a greater number of FCW possible collision warnings experienced.

By changing the FCW status setting to "Near", the system provides possible collision warnings on objects closer to the vehicle. This results in later warnings and provides less reaction time than the "Far" and "Medium" settings, which allows for a more dynamic driving experience.

**NOTE:**

The "Near" setting may result in a lesser number of FCW possible collision warnings experienced.

**NOTE:**

- Changing the FCW status to “Only Warning” prevents the system from providing limited active braking, or additional brake support if the driver is not braking adequately in the event of a potential frontal collision, but maintains the audible and visual warnings.
- Changing the FCW status to “Off” prevents the system from providing autonomous braking, or additional brake support if the driver is not braking adequately in the event of a potential frontal collision.
- The system will retain the last setting selected by the driver after ignition shut down.
- FCW may not react to irrelevant objects such as overhead objects, ground reflections, objects not in the path of the vehicle, stationary objects that are far away, oncoming traffic, or leading vehicles with the same or higher rates of speed.
- FCW will be disabled like ACC, with the unavailable screens.

**FCW Limited Warning**

If the instrument cluster display reads “FCW Limited Functionality” or “FCW Limited Functionality Clean Front Windshield” momentarily, there may be a condition that limits FCW functionality. Although the vehicle is still driveable under normal conditions, the active braking may not be fully available. Once the condition that limited the system performance is no longer present, the system will return to its full performance state. If the problem persists, see an authorized dealer.

**Service FCW Warning**

If the system turns off, and the instrument cluster display reads “FCW Unavailable Service Required”, there is an internal system fault. Although the vehicle is still driveable under normal conditions, have the system checked by an authorized dealer.

**Pedestrian Emergency Braking (PEB) — If Equipped**

PEB is a subsystem of the Forward Collision Warning (FCW) system which provides the driver with audible warnings and visual warnings, in the instrument cluster display. It may apply limited automatic braking when it detects a potential frontal collision with a pedestrian/cyclist.

**PEB Message**

If a PEB event begins at a speed below 39 mph (62 km/h), the system may provide maximum braking to mitigate the potential collision with a pedestrian/cyclist. If the PEB event stops the vehicle completely, the system will hold the vehicle at a standstill for two

seconds and then release the brakes. When the system determines a collision with the pedestrian/cyclist in front of you is no longer probable, the warning message will be deactivated.

The minimum speed for PEB activation is 3 mph (5 km/h).

**WARNING!**

Pedestrian Emergency Braking (PEB) is not intended to avoid a collision on its own, nor can PEB detect every type of potential collision with a pedestrian/cyclist. The driver has the responsibility to avoid a collision by controlling the vehicle via braking and steering. Failure to follow this warning could lead to serious injury or death.

**Turning PEB On Or Off****NOTE:**

The default status of PEB is “On.” This allows the system to warn you of a possible frontal collision with the pedestrian/cyclist.

The PEB button is located in the Uconnect Settings  page 149.

To turn the PEB system off, push the Pedestrian Emergency Braking OFF button.

To turn the PEB system back on, push the Warning Active Braking button.

Changing the PEB status to “Only Warning” prevents the system from providing autonomous braking, or additional brake support if the driver is not braking adequately in the event of a potential frontal collision with a pedestrian/cyclist.

Changing the PEB status to “Off” deactivates the system, so no warning or active braking will be available in case of a possible frontal collision with a pedestrian/cyclist.

#### NOTE:

The PEB system will retain the last setting selected by the driver after ignition shut down. The system will not reset to the default setting when the vehicle is restarted.

## TIRE PRESSURE MONITORING SYSTEM (TPMS)

The TPMS will warn the driver of a low tire pressure based on the vehicle recommended cold placard pressure.

The tire pressure will vary with temperature by approximately 1 psi (7 kPa) for every 12°F (6.5°C). This means that when the outside temperature decreases, the tire pressure will decrease. Tire pressure should always be set based on cold inflation tire pressure. This is defined as the tire pressure after the vehicle has not been driven for at least three hours, or driven less than 1 mile (1.6 km) after a three hour period. The cold tire inflation pressure must not exceed the maximum inflation pressure molded into the tire sidewall. The tire pressure will also increase as the vehicle is driven. This is normal and there should be no adjustment for this increased pressure.

For more information on how to properly inflate the vehicle's tires, see [↔](#) page 257.

The TPMS will warn the driver of a low tire pressure if the tire pressure falls below the low-pressure warning limit for any reason, including low temperature effects and natural pressure loss through the tire. The TPMS

will continue to warn the driver of low tire pressure as long as the condition exists, and will not turn off until the tire pressure is at or above the recommended cold placard pressure.

#### NOTE:

Once the low tire pressure warning (Tire Pressure Monitoring System Warning Light) illuminates, you must increase the tire pressure to the recommended cold placard pressure in order for the Tire Pressure Monitoring System Warning Light to turn off.

The system will automatically update and the Tire Pressure Monitoring System Warning Light will turn off once the system receives the updated tire pressures. The vehicle may need to be driven for up to 20 minutes above 15 mph (24 km/h) in order for the TPMS to receive this information.

For example, your vehicle may have a recommended cold (parked for more than three hours) placard pressure of 33 psi (227 kPa). If the ambient temperature is 68°F (20°C) and the measured tire pressure is 28 psi (193 kPa), a temperature drop to 20°F (-7°C) will decrease the tire pressure to approximately 24 psi (165 kPa). This tire pressure is low enough to turn on the Tire Pressure Monitoring System Warning Light. Driving the vehicle may cause the tire pressure to rise to approximately 28 psi (193 kPa), but the Tire Pressure Monitoring System Warning Light will still be on. In this situation, the Tire Pressure Monitoring System Warning Light will turn off only after the tires are inflated to the vehicle's recommended cold placard pressure value [↔](#) page 282.

#### NOTE:

When filling warm tires, the tire pressure may need to be increased up to an additional 4 psi (28 kPa) above the recommended cold placard pressure in order to turn the Tire Pressure Monitoring System Warning Light off.

#### CAUTION!

- The TPMS has been optimized for the original equipment tires and wheels. TPMS pressures and warning have been established for the tire size equipped on your vehicle. Undesirable system operation or sensor damage may result when using replacement equipment that is not of the same size, type, and/or style. The TPMS sensor is not designed for use on aftermarket wheels and may contribute to a poor overall system performance or sensor damage. Customers are encouraged to use Original Equipment Manufacturer (OEM) wheels to ensure proper TPMS feature operation.
- Using aftermarket tire sealants may cause the Tire Pressure Monitoring System (TPMS) sensor to become inoperable. After using an aftermarket tire sealant it is recommended that you take your vehicle to an authorized dealer to have your sensor function checked.
- After inspecting or adjusting the tire pressure always reinstall the valve stem cap. This will prevent moisture and dirt from entering the valve stem, which could damage the TPMS sensor.

**NOTE:**

- The TPMS is not intended to replace normal tire care and maintenance, or to provide warning of a tire failure or condition.
- The TPMS should not be used as a tire pressure gauge while adjusting your tire pressure.
- Driving on a significantly underinflated tire causes the tire to overheat and can lead to tire failure. Underinflation also reduces fuel efficiency and tire tread life, and may affect the vehicle's handling and stopping ability.
- The TPMS is not a substitute for proper tire maintenance, and it is the driver's responsibility to maintain correct tire pressure using an accurate tire pressure gauge, even if underinflation has not reached the level to trigger illumination of the Tire Pressure Monitoring System Warning Light.
- Seasonal temperature changes will affect tire pressure, and the TPMS will monitor the actual tire pressure in the tire.

**Premium System**

The Tire Pressure Monitoring System (TPMS) uses wireless technology with wheel rim mounted electronic sensors to monitor tire pressure levels. Sensors, mounted to each wheel as part of the valve stem, transmit tire pressure readings to the receiver module.

**NOTE:**

It is particularly important for you to check the tire pressure in all of the tires on your vehicle monthly and to maintain the proper pressure.

The TPMS consists of the following components:

- Receiver module
- Four Tire Pressure Monitoring System sensors
- Various Tire Pressure Monitoring System messages, which will display in the instrument cluster display
- Tire Pressure Monitoring System Warning Light

**Tire Pressure Monitoring System Low Pressure Warnings**

The Tire Pressure Monitoring System Warning Light will illuminate in the instrument cluster and a chime will sound when tire pressure is low in one or more of the four active road tires. In addition, the instrument cluster will display a "Tire Low" message, an "Inflate to XX" message, and a graphic showing the pressure values of each tire with the low tire pressure values highlighted or in a different color.



**Tire Pressure Monitoring System Low Pressure Warning**

Should this occur, you should stop as soon as possible and inflate the tires with low pressure (those highlighted or in a different color in the instrument cluster display graphic) to the vehicle's recommended cold placard pressure value, as shown in the "Inflate to XX" message. Once the system receives the updated tire pressures, the system will automatically update, the pressure values in the graphic display in the instrument cluster will stop being highlighted or return to their original color, and the Tire Pressure Monitoring System Warning Light will turn off.

**NOTE:**

When filling warm tires, the tire pressure may need to be increased up to an additional 4 psi (28 kPa) above the recommended cold placard pressure in order to turn the Tire Pressure Monitoring System Warning Light off. The vehicle may need to be driven for up to 20 minutes above 15 mph (24 km/h) in order for the TPMS to receive this information.

**Service TPMS Warning**

When a system fault is detected, the Tire Pressure Monitoring System Warning Light will flash on and off for 75 seconds and then remain on solid. The system fault will also sound a chime. In addition, the instrument cluster will display a "SERVICE TPM SYSTEM" message for a minimum of five seconds and then display dashes (-) in place of the pressure value to indicate which sensor is not being received.

If the ignition key is cycled, this sequence will repeat, providing the system fault still exists. If the system fault no longer exists, the Tire Pressure Monitoring System Warning Light will no longer flash, and the "SERVICE TPM SYSTEM" message will no longer display, and a pressure value will display in place of the dashes. A system fault can occur due to any of the following:

- Jamming due to electronic devices or driving next to facilities emitting the same radio frequencies as the TPMS sensors
- Installing some form of aftermarket window tinting that affects radio wave signals
- Lots of snow or ice around the wheels or wheel housings
- Using tire chains on the vehicle
- Using wheels/tires not equipped with TPMS sensors

#### Vehicles With Compact Spare Or Non-Matching Full Size Spare

1. The compact spare tire or non-matching full size does not have a Tire Pressure Monitoring System sensor. Therefore, the TPMS will not monitor the pressure in the compact or non-matching full size spare tire.
2. If you install the compact or non-matching full size spare tire in place of a road tire that has a pressure below the low-pressure warning limit, upon the next ignition key cycle, the Tire Pressure Monitoring System Warning Light will remain on and a chime will sound. In addition, the graphic in the instrument cluster will still display a different color or high-lighted pressure value and the "Inflate to XX" message.

3. After driving the vehicle for up to 20 minutes above 15 mph (24 km/h), the Tire Pressure Monitoring System Warning Light will flash on and off for 75 seconds and then remain on solid. In addition, the instrument cluster will display a "SERVICE TPM SYSTEM" message for five seconds and then display dashes (-) in place of the pressure value.
4. For each subsequent ignition key cycle, a chime will sound, the Tire Pressure Monitoring System Warning Light will flash on and off for 75 seconds and then remain on solid, and the instrument cluster will display a "SERVICE TPM SYSTEM" message for five seconds and then display dashes (-) in place of the pressure value.
5. Once you repair or replace the original road tire and reinstall it on the vehicle in place of the compact spare or non-matching full size, the TPMS will update automatically. In addition, the Tire Pressure Monitoring System Warning Light will turn off and the graphic in the instrument cluster will display a new pressure value instead of dashes (-), as long as no tire pressure is below the low-pressure warning limit in any of the four active road tires. The vehicle may need to be driven for up to 20 minutes above 15 mph (24 km/h) in order for the TPMS to receive this information.

#### TPMS Deactivation — If Equipped

The TPMS can be deactivated if replacing all four wheel and tire assemblies (road tires) with wheel and tire assemblies that do not have TPMS sensors, such as when installing winter wheel and tire assemblies on your vehicle.

To deactivate the TPMS, first replace all four wheel and tire assemblies (road tires) with tires not equipped with Tire Pressure Monitoring System (TPMS) sensors. Then, drive the vehicle for 20 minutes above 15 mph (24 km/h). The TPMS will chime, the Tire Pressure Monitoring System Warning Light will flash on and off for 75 seconds and then remain on. The instrument cluster will display the "SERVICE TPM SYSTEM" message and then display dashes (-) in place of the pressure values.

Beginning with the next ignition cycle, the TPMS will no longer chime or display the "SERVICE TPM SYSTEM" message in the instrument cluster but dashes (-) will remain in place of the pressure values.

To reactivate the TPMS, replace all four wheel and tire assemblies (road tires) with tires equipped with TPMS sensors. Then, drive the vehicle for up to 20 minutes above 15 mph (24 km/h). The TPMS will chime, the Tire Pressure Monitoring System Warning Light will flash on and off for 75 seconds and then turn off. The instrument cluster will display the "SERVICE TPM SYSTEM" message and then display pressure values in place of the dashes. On the next ignition cycle the "SERVICE TPM SYSTEM" message will no longer be displayed as long as no system fault exists.

## OCCUPANT RESTRAINT SYSTEMS

Some of the most important safety features in your vehicle are the restraint systems:

### OCCUPANT RESTRAINT SYSTEMS FEATURES

- Seat Belt Systems
- Supplemental Restraint Systems (SRS) Air Bags
- Child Restraints

Some of the safety features described in this section may be standard equipment on some models, or may be optional equipment on others. If you are not sure, ask an authorized dealer.

### IMPORTANT SAFETY PRECAUTIONS

Please pay close attention to the information in this section. It tells you how to use your restraint system properly, to keep you and your passengers as safe as possible.

Here are some simple steps you can take to minimize the risk of harm from a deploying air bag:

1. Children 12 years old and under should always ride buckled up in the rear seat of a vehicle with a rear seat.
2. A child who is not big enough to wear the vehicle seat belt properly must be secured in the appropriate child restraint or belt-positioning booster seat in a rear seating position → page 199.
3. If a child from 2 to 12 years old (not in a rear-facing child restraint) must ride in the front passenger seat, move the seat as far back as possible and use the proper child restraint → page 199.

4. Never allow children to slide the shoulder belt behind them or under their arm.
5. You should read the instructions provided with your child restraint to make sure that you are using it properly.
6. All occupants should always wear their lap and shoulder belts properly.
7. The driver and front passenger seats should be moved back as far as practical to allow the front air bags room to inflate.
8. Do not lean against the door or window. If your vehicle has side air bags, and deployment occurs, the side air bags will inflate forcefully into the space between occupants and the door and occupants could be injured.
9. If the air bag system in this vehicle needs to be modified to accommodate a disabled person, see → page 278 for customer service contact information.

#### WARNING!

- Never place a rear-facing child restraint in front of an air bag. A deploying passenger front air bag can cause death or serious injury to a child 12 years or younger, including a child in a rear-facing child restraint.
- Never install a rear-facing child restraint in the front seat of a vehicle. Only use a rear-facing child restraint in the rear seat. If the vehicle does not have a rear seat, do not transport a rear-facing child restraint in that vehicle.

## SEAT BELT SYSTEMS

Buckle up even though you are an excellent driver, even on short trips. Someone on the road may be a poor driver and could cause a collision that includes you. This can happen far away from home or on your own street.

Research has shown that seat belts save lives, and they can reduce the seriousness of injuries in a collision. Some of the worst injuries happen when people are thrown from the vehicle. Seat belts reduce the possibility of ejection and the risk of injury caused by striking the inside of the vehicle. Everyone in a motor vehicle should be belted at all times.

### Enhanced Seat Belt Use Reminder System (BeltAlert)

#### Driver And Passenger BeltAlert — If Equipped



BeltAlert is a feature intended to remind the driver and outboard front seat passenger (if equipped with outboard front passenger seat BeltAlert) to buckle their seat belts. The BeltAlert feature is active whenever the ignition switch is in the START or ON/RUN position.

#### Initial Indication

If the driver is unbuckled when the ignition switch is first in the START or ON/RUN position, a chime will signal for a few seconds. If the driver or outboard front seat passenger (if equipped with outboard front passenger seat BeltAlert) is unbuckled when the ignition switch is first in the START or ON/RUN position the Seat Belt Reminder Light will turn on and remain on until both outboard front seat belts are buckled. The outboard front passenger seat BeltAlert is not active when an outboard front passenger seat is unoccupied.



### BeltAlert Warning Sequence

The BeltAlert warning sequence is activated when the vehicle is moving above a specified vehicle speed range and the driver or outboard front seat passenger is unbuckled (if equipped with outboard front passenger seat BeltAlert) (the outboard front passenger seat BeltAlert is not active when the outboard front passenger seat is unoccupied). The BeltAlert warning sequence starts by blinking the Seat Belt Reminder Light and sounding an intermittent chime. Once the BeltAlert warning sequence has completed, the Seat Belt Reminder Light will remain on until the seat belts are buckled. The BeltAlert warning sequence may repeat based on vehicle speed until the driver and occupied outboard front seat passenger seat belts are buckled. The driver should instruct all occupants to buckle their seat belts.

### Change Of Status

If the driver or outboard front seat passenger (if equipped with outboard front passenger seat BeltAlert) unbuckles their seat belt while the vehicle is traveling, the BeltAlert warning sequence will begin until the seat belts are buckled again.

The outboard front passenger seat BeltAlert is not active when the outboard front passenger seat is unoccupied. BeltAlert may be triggered when an animal or other items are placed on the outboard front passenger seat or when the seat is folded flat (if equipped). It is recommended that pets be restrained in the rear seat (if equipped) in pet harnesses or pet carriers that are secured by seat belts, and cargo is properly stowed.

BeltAlert can be activated or deactivated by an authorized dealer. FCA US LLC does not recommend deactivating BeltAlert.

### NOTE:

If BeltAlert has been deactivated and the driver or outboard front seat passenger (if equipped with outboard front passenger seat BeltAlert) is unbuckled the Seat Belt Reminder Light will turn on and remain on until the driver and outboard front seat passenger seat belts are buckled.

### Lap/Shoulder Belts

All seating positions in your vehicle are equipped with lap/shoulder belts.

The seat belt webbing retractor will lock only during very sudden stops or collisions. This feature allows the shoulder part of the seat belt to move freely with you under normal conditions. However, in a collision the seat belt will lock and reduce your risk of striking the inside of the vehicle or being thrown out of the vehicle.

#### WARNING!

- Relying on the air bags alone could lead to more severe injuries in a collision. The air bags work with your seat belt to restrain you properly. In some collisions, the air bags won't deploy at all. Always wear your seat belt even though you have air bags.
- In a collision, you and your passengers can suffer much greater injuries if you are not properly buckled up. You can strike the interior of your vehicle or other passengers, or you can be thrown out of the vehicle. Always be sure you and others in your vehicle are buckled up properly.
- It is dangerous to ride in a cargo area, inside or outside of a vehicle. In a collision, people riding in these areas are more likely to be seriously injured or killed.

(Continued)

#### WARNING!

- Do not allow people to ride in any area of your vehicle that is not equipped with seats and seat belts.
- Be sure everyone in your vehicle is in a seat and using a seat belt properly. Occupants, including the driver, should always wear their seat belts whether or not an air bag is also provided at their seating position to minimize the risk of severe injury or death in the event of a crash.
- Wearing your seat belt incorrectly could make your injuries in a collision much worse. You might suffer internal injuries, or you could even slide out of the seat belt. Follow these instructions to wear your seat belt safely and to keep your passengers safe, too.
- Two people should never be belted into a single seat belt. People belted together can crash into one another in a collision, hurting one another badly. Never use a lap/shoulder belt or a lap belt for more than one person, no matter what their size.

#### WARNING!

- A lap belt worn too high can increase the risk of injury in a collision. The seat belt forces won't be at the strong hip and pelvic bones, but across your abdomen. Always wear the lap part of your seat belt as low as possible and keep it snug.
- A twisted seat belt may not protect you properly. In a collision, it could even cut into you. Be sure the seat belt is flat against your body, without twists. If you can't straighten a seat belt in your vehicle, take it to an authorized dealer immediately and have it fixed.

(Continued)

**WARNING!**

- A seat belt that is buckled into the wrong buckle will not protect you properly. The lap portion could ride too high on your body, possibly causing internal injuries. Always buckle your seat belt into the buckle nearest you.
- A seat belt that is too loose will not protect you properly. In a sudden stop, you could move too far forward, increasing the possibility of injury. Wear your seat belt snugly.
- A seat belt that is worn under your arm is dangerous. Your body could strike the inside surfaces of the vehicle in a collision, increasing head and neck injury. A seat belt worn under the arm can cause internal injuries. Ribs aren't as strong as shoulder bones. Wear the seat belt over your shoulder so that your strongest bones will take the force in a collision.
- A shoulder belt placed behind you will not protect you from injury during a collision. You are more likely to hit your head in a collision if you do not wear your shoulder belt. The lap and shoulder belt are meant to be used together.
- A frayed or torn seat belt could rip apart in a collision and leave you with no protection. Inspect the seat belt system periodically, checking for cuts, frays, or loose parts. Damaged parts must be replaced immediately. Do not disassemble or modify the seat belt system. If your vehicle is involved in a collision, or if you have questions regarding seat belt or retractor conditions, take your vehicle to an authorized FCA dealer or authorized FCA Certified Collision Care Program facility for inspection.

## Lap/Shoulder Belt Operating Instructions

1. Enter the vehicle and close the door. Sit back and adjust the seat.
2. The seat belt latch plate is above the back of the front seat, and next to your arm in the rear seat (for vehicles equipped with a rear seat). Grab the latch plate and pull out the seat belt. Slide the latch plate up the webbing as far as necessary to allow the seat belt to go around your lap.



**Pulling Out The Latch Plate**

3. When the seat belt is long enough to fit, insert the latch plate into the buckle until you hear a "click".



**Inserting Latch Plate Into Buckle**

4. Position the lap belt so that it is snug and lies low across your hips, below your abdomen. To remove slack in the lap belt portion, pull up on the shoulder belt. To loosen the lap belt if it is too tight, tilt the latch plate and pull on the lap belt. A snug seat belt reduces the risk of sliding under the seat belt in a collision.



**Positioning The Lap Belt**

- Position the shoulder belt across the shoulder and chest with minimal, if any slack so that it is comfortable and not resting on your neck. The retractor will withdraw any slack in the shoulder belt.
- To release the seat belt, push the red button on the buckle. The seat belt will automatically retract to its stowed position. If necessary, slide the latch plate down the webbing to allow the seat belt to retract fully.

### Lap/Shoulder Belt Untwisting Procedure

Use the following procedure to untwist a twisted lap/shoulder belt.

- Position the latch plate as close as possible to the anchor point.
- At about 6 to 12 inches (15 to 30 cm) above the latch plate, grab and twist the seat belt webbing 180 degrees to create a fold that begins immediately above the latch plate.
- Slide the latch plate upward over the folded webbing. The folded webbing must enter the slot at the top of the latch plate.
- Continue to slide the latch plate up until it clears the folded webbing and the seat belt is no longer twisted.

### Adjustable Upper Shoulder Belt Anchorage

In the driver and outboard front passenger seats, the top of the shoulder belt can be adjusted upward or downward to position the seat belt away from your neck. Push or squeeze the anchorage button to release the anchorage, and move it up or down to the position that serves you best.



**Adjustable Anchorage**

As a guide, if you are shorter than average, you will prefer the shoulder belt anchorage in a lower position, and if you are taller than average, you will prefer the shoulder belt anchorage in a higher position. After you release the anchorage button, try to move it up or down to make sure that it is locked in position.

#### NOTE:

The adjustable upper shoulder belt anchorage is equipped with an Easy Up feature. This feature allows the shoulder belt anchorage to be adjusted in the upward position without pushing or squeezing the release button. To verify the shoulder belt anchorage is latched, pull downward on the shoulder belt anchorage until it is locked into position.

#### WARNING!

- Wearing your seat belt incorrectly could make your injuries in a collision much worse. You might suffer internal injuries, or you could even slide out of the seat belt. Follow these instructions to wear your seat belt safely and to keep your passengers safe, too.
- Position the shoulder belt across the shoulder and chest with minimal, if any slack so that it is comfortable and not resting on your neck. The retractor will withdraw any slack in the shoulder belt.
- Misadjustment of the seat belt could reduce the effectiveness of the safety belt in a crash.
- Always make all seat belt height adjustments when the vehicle is stationary.

### Second Row Center Seat Belt Operating Instructions

The second row center seat belt may feature a seat belt with a mini-latch plate and buckle. The mini-latch plate and buckle (if equipped) should remain connected at all times. If the mini-latch plate and buckle become disconnected, they must be properly reconnected prior to the rear center seat belt being used by an occupant.

1. Grab the mini-latch plate and pull the seat belt over the seat.



**Pulling Out The Latch Plate**

2. When the seat belt is long enough to fit, insert the mini-latch plate into the mini-buckle until you hear a “click.”



**Inserting Mini-Latch Plate Into Mini-Buckle**

3. Sit back in seat. Slide the regular latch plate up the webbing as far as necessary to allow the seat belt to go around your lap.
4. When the seat belt is long enough to fit, insert the latch plate into the buckle until you hear a “click.”

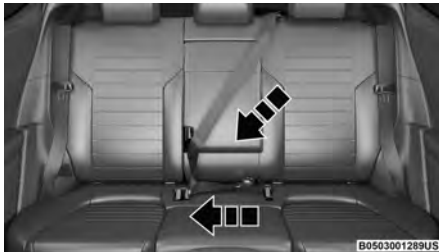

**Inserting Latch Plate Into Buckle**

5. Position the lap belt so that it is snug and lies low across your hips, below your abdomen. To remove slack in the lap belt portion, pull up on the shoulder belt. To loosen the lap belt if it is too tight, pull on the lap belt. A snug seat belt reduces the risk of sliding under the seat belt in a collision.
6. Position the shoulder belt on your chest so that it is comfortable and not resting on your neck. The retractor will withdraw any slack in the seat belt.
7. To release the seat belt, push the red button on the buckle.
8. To disengage the mini-latch plate from the mini-buckle, insert the regular latch plate into the center red slot on the mini-buckle.

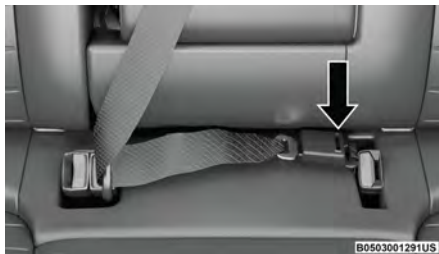

**Detaching Mini-Buckle With Seat Belt Tongue**

**WARNING!**

- If the mini-latch plate and mini-buckle are not properly connected when the seat belt is used by an occupant, the seat belt will not be able to provide proper restraint and will increase the risk of injury in a collision.
- When reattaching the mini-latch plate and mini-buckle, ensure the seat belt webbing is not twisted. If the webbing is twisted, follow the preceding procedure to detach the mini-latch plate and mini-buckle, untwist the webbing, and reattach the mini-latch plate and mini-buckle.

## Seat Belts And Pregnant Women



Seat Belts And Pregnant Women

Seat belts must be worn by all occupants including pregnant women: the risk of injury in the event of an accident is reduced for the mother and the unborn child if they are wearing a seat belt.

Position the lap belt snug and low below the abdomen and across the strong bones of the hips. Place the shoulder belt across the chest and away from the neck. Never place the shoulder belt behind the back or under the arm.

## Seat Belt Extender

If a seat belt is not long enough to fit properly, even when the webbing is fully extended and the adjustable upper shoulder belt anchorage (if equipped) is in its lowest position, an authorized dealer can provide you with a Seat Belt Extender. The Seat Belt Extender should be used only if the existing seat belt is not long enough. When the Seat Belt Extender is not required for a different occupant, it must be removed.

### WARNING!

- ONLY use a Seat Belt Extender if it is physically required in order to properly fit the original seat belt system. DO NOT USE the Seat Belt Extender if, when worn, the distance between the front edge of the Seat Belt Extender buckle and the center of the occupant's body is LESS than 6 inches.
- Using a Seat Belt Extender when not needed can increase the risk of serious injury or death in a collision. Only use the Seat Belt Extender when the lap belt is not long enough and only use in the recommended seating positions. Remove and store the Seat Belt Extender when not needed.

## Seat Belt Pretensioner

The front outboard seat belt system is equipped with pretensioning devices that are designed to remove slack from the seat belt in the event of a collision. These devices may improve the performance of the seat belt by removing slack from the seat belt early in a collision. Pretensioners work for all size occupants, including those in child restraints.

### NOTE:

These devices are not a substitute for proper seat belt placement by the occupant. The seat belt still must be worn snugly and positioned properly.

The pretensioners are triggered by the Occupant Restraint Controller (ORC). Like the air bags, the pretensioners are single use items. A deployed pretensioner or a deployed air bag must be replaced immediately.

## Energy Management Feature

The front outboard seat belt system is equipped with an Energy Management feature that may help further reduce the risk of injury in the event of a collision. The seat belt system has a retractor assembly that is designed to release webbing in a controlled manner.

## Switchable Automatic Locking Retractors (ALR)

The seat belts in the passenger seating positions are equipped with a Switchable Automatic Locking Retractor (ALR) which is used to secure a child restraint system → page 205.

The figure provided illustrates the locking feature for each seating position.



Switchable Automatic Locking Retractor (ALR) Locations

If the passenger seating position is equipped with an ALR and is being used for normal usage, only pull the seat belt webbing out far enough to comfortably wrap around the occupant's mid-section so as to not activate the ALR. If the ALR is activated, you will hear a clicking sound as the seat belt retracts. Allow the webbing to retract completely in this case and then carefully pull out only the amount of webbing necessary to comfortably wrap around the occupant's mid-section. Slide the latch plate into the buckle until you hear a "click."

In Automatic Locking Mode, the shoulder belt is automatically pre-locked. The seat belt will still retract to remove any slack in the shoulder belt. Use the Automatic Locking Mode anytime a child restraint is installed in a seating position that has a seat belt with this feature. Children 12 years old and under should always be properly restrained in the rear seat of a vehicle with a rear seat.

#### WARNING!

- Never place a rear-facing child restraint in front of an air bag. A deploying passenger front air bag can cause death or serious injury to a child 12 years or younger, including a child in a rear-facing child restraint.
- Never install a rear-facing child restraint in the front seat of a vehicle. Only use a rear-facing child restraint in the rear seat. If the vehicle does not have a rear seat, do not transport a rear-facing child restraint in that vehicle.

#### How To Engage The Automatic Locking Mode

1. Buckle the combination lap and shoulder belt.
2. Grab the shoulder portion and pull downward until the entire seat belt is extracted.
3. Allow the seat belt to retract. As the seat belt retracts, you will hear a clicking sound. This indicates the seat belt is now in the Automatic Locking Mode.

#### How To Disengage The Automatic Locking Mode

Unbuckle the combination lap/shoulder belt and allow it to retract completely to disengage the Automatic Locking Mode and activate the vehicle sensitive (emergency) locking mode.

#### WARNING!

- The seat belt assembly must be replaced if the switchable Automatic Locking Retractor (ALR) feature or any other seat belt function is not working properly when checked according to the procedures in the Service Manual.
- Failure to replace the seat belt assembly could increase the risk of injury in collisions.
- Do not use the Automatic Locking Mode to restrain occupants who are wearing the seat belt or children who are using booster seats. The locked mode is only used to install rear-facing or forward-facing child restraints that have a harness for restraining the child.

## SUPPLEMENTAL RESTRAINT SYSTEMS (SRS)

Some of the safety features described in this section may be standard equipment on some models, or may be optional equipment on others. If you are not sure, ask an authorized dealer.

The air bag system must be ready to protect you in a collision. The Occupant Restraint Controller (ORC) monitors the internal circuits and interconnecting wiring associated with the electrical Air Bag System Components. Your vehicle may be equipped with the following Air Bag System Components:

### Air Bag System Components

- Occupant Restraint Controller (ORC)
- Air Bag Warning Light 
- Steering Wheel and Column
- Instrument Panel
- Knee Impact Bolsters
- Driver and Front Passenger Air Bags
- Seat Belt Buckle Switch
- Supplemental Side Air Bags
- Supplemental Knee Air Bags
- Front and Side Impact Sensors
- Seat Belt Pretensioners
- Seat Track Position Sensors
- Occupant Classification System

## Air Bag Warning Light



The Occupant Restraint Controller (ORC) monitors the readiness of the electronic parts of the air bag system whenever the ignition switch is in the START or ON/RUN position. If the ignition switch is in the OFF position, the air bag system is not on and the air bags will not inflate.

The ORC contains a backup power supply system that may deploy the air bag system even if the battery loses power or it becomes disconnected prior to deployment. The ORC turns on the Air Bag Warning Light in the instrument panel for approximately four to eight seconds for a self-check when the ignition switch is first in the ON/RUN position. After the self-check, the Air Bag Warning Light will turn off. If the ORC detects a malfunction in any part of the system, it turns on the Air Bag Warning Light, either momentarily or continuously. A single chime will sound to alert you if the light comes on again after initial startup.

The ORC also includes diagnostics that will illuminate the instrument panel Air Bag Warning Light if a malfunction is detected that could affect the air bag system. The diagnostics also record the nature of the malfunction. While the air bag system is designed to be maintenance free, if any of the following occurs, have an authorized dealer service the air bag system immediately.

- The Air Bag Warning Light does not come on during the four to eight seconds when the ignition switch is first in the ON/RUN position.
- The Air Bag Warning Light remains on after the four to eight-second interval.
- The Air Bag Warning Light comes on intermittently or remains on while driving.

### NOTE:

If the speedometer, tachometer, or any engine related gauges are not working, the Occupant Restraint Controller (ORC) may also be disabled. In this condition the air bags may not be ready to inflate for your protection. Have an authorized dealer service the air bag system immediately.

### WARNING!

Ignoring the Air Bag Warning Light in your instrument panel could mean you won't have the air bag system to protect you in a collision. If the light does not come on as a bulb check when the ignition is first turned on, stays on after you start the vehicle, or if it comes on as you drive, have an authorized dealer service the air bag system immediately.

## Redundant Air Bag Warning Light



If a fault with the Air Bag Warning Light is detected, which could affect the Supplemental Restraint System (SRS), the Redundant Air Bag Warning Light will illuminate on the instrument panel. The Redundant Air Bag Warning Light will stay on until the fault is cleared. In addition, a single chime will sound to alert you that the Redundant Air Bag Warning Light has come on and a fault has been detected. If the Redundant Air Bag Warning Light comes on intermittently or remains on while driving have an authorized dealer service the vehicle immediately → page 87.

## Front Air Bags

This vehicle has front air bags and lap/shoulder belts for both the driver and front passenger. The front air bags are a supplement to the seat belt restraint systems. The driver front air bag is mounted in the center of the steering wheel. The passenger front air bag is mounted in the instrument panel, above the glove compartment. The words "SRS AIRBAG" or "AIRBAG" are embossed on the air bag covers.



Front Air Bag/Knee Bolster Locations

- 1 — Driver And Passenger Front Air Bags
- 2 — Driver Knee Impact Bolster/Supplemental Driver Knee Air Bag
- 3 — Passenger Knee Impact Bolster

**WARNING!**

- Being too close to the steering wheel or instrument panel during front air bag deployment could cause serious injury, including death. Air bags need room to inflate. Sit back, comfortably extending your arms to reach the steering wheel or instrument panel.
- Never place a rear-facing child restraint in front of an air bag. A deploying passenger front air bag can cause death or serious injury to a child 12 years or younger, including a child in a rear-facing child restraint.
- Never install a rear-facing child restraint in the front seat of a vehicle. Only use a rear-facing child restraint in the rear seat. If the vehicle does not have a rear seat, do not transport a rear-facing child restraint in that vehicle.

## Driver And Passenger Front Air Bag Features

The Advanced Front Air Bag system has multistage driver and front passenger air bags. This system provides output appropriate to the severity and type of collision as determined by the Occupant Restraint Controller (ORC), which may receive information from the front impact sensors (if equipped) or other system components.

The first stage inflator is triggered immediately during an impact that requires air bag deployment. A low energy output is used in less severe collisions. A higher energy output is used for more severe collisions.

This vehicle may be equipped with a driver and/or front passenger seat belt buckle switch that detects whether the driver or front passenger seat belt is buckled. The seat belt buckle switch may adjust the inflation rate of the Advanced Front Air Bags.

This vehicle may be equipped with driver and/or front passenger seat track position sensors that may adjust the inflation rate of the Advanced Front Air Bags based upon seat position.

This vehicle is equipped with a right front passenger Occupant Classification System (OCS) that is designed to provide Passenger Advanced Front Air Bag output appropriate to the occupant's seated weight input, as determined by the OCS.

**WARNING!**

- No objects should be placed over or near the air bag on the instrument panel or steering wheel because any such objects could cause harm if the vehicle is in a collision severe enough to cause the air bag to inflate.
- Do not put anything on or around the air bag covers or attempt to open them manually. You may damage the air bags and you could be injured because the air bags may no longer be functional. The protective covers for the air bag cushions are designed to open only when the air bags are inflated.
- Relying on the air bags alone could lead to more severe injuries in a collision. The air bags work with your seat belt to restrain you properly. In some collisions, air bags won't deploy at all. Always wear your seat belts even though you have air bags.

## Front Air Bag Operation

Front Air Bags are designed to provide additional protection by supplementing the seat belts. Front air bags are not expected to reduce the risk of injury in rear, side, or rollover collisions. The front air bags will not deploy in all frontal collisions, including some that may produce substantial vehicle damage — for example, some pole collisions, truck underrides, and angle offset collisions.

On the other hand, depending on the type and location of impact, front air bags may deploy in crashes with little vehicle front-end damage but that produce a severe initial deceleration.

Because air bag sensors measure vehicle deceleration over time, vehicle speed and damage by themselves are not good indicators of whether or not an air bag should have deployed.

Seat belts are necessary for your protection in all collisions, and also are needed to help keep you in position, away from an inflating air bag.

When the Occupant Restraint Controller (ORC) detects a collision requiring the front air bags, it signals the inflator units. A large quantity of non-toxic gas is generated to inflate the front air bags.

The steering wheel hub trim cover and the upper passenger side of the instrument panel separate and fold out of the way as the air bags inflate to their full size. The front air bags fully inflate in less time than it takes to blink your eyes. The front air bags then quickly deflate while helping to restrain the driver and front passenger.



## Occupant Classification System (OCS) — Front Passenger Seat

The Occupant Classification System (OCS) is part of a Federally regulated safety system for this vehicle. It is designed to provide Passenger Advanced Front Air Bag output appropriate to the occupant's seated weight, as determined by the OCS.

The Occupant Classification System (OCS) consists of the following:

- Occupant Restraint Controller (ORC)
- Occupant Classification Module (OCM) and Sensor located in the front passenger seat
- Air Bag Warning Light 

### Occupant Classification Module (OCM) And Sensor

The Occupant Classification Module (OCM) is located underneath the front passenger seat. The Sensor is located beneath the passenger seat cushion foam. Any weight on the seat will be sensed by the Sensor. The OCM uses input from the Sensor to determine the front passenger's most probable classification. The OCM communicates this information to the ORC. The ORC may reduce the inflation rate of the Passenger Advanced Front Air Bag deployment based on occupant classification. In order for the OCS to operate as designed, it is important for the front passenger to be seated properly and properly wearing the seat belt.

The OCS will NOT prevent deployment of the Passenger Advanced Front Air Bag. The OCS may reduce the inflation rate of the Passenger Advanced Front Air Bag if the OCS estimates that:

- The front passenger seat is unoccupied or has very light objects on it; or
- The front passenger seat is occupied by a small passenger, including a child; or

- The front passenger seat is occupied by a rear-facing child restraint; or
- The front passenger is not properly seated or his or her weight is taken off of the seat for a period of time.

Front Passenger Seat Occupant Status	Front Passenger Air Bag Output
Rear-facing child restraint	Reduced-power deployment
Child, including a child in a forward-facing child restraint or booster seat*	Reduced-power deployment OR Full-power deployment
Properly seated adult	Full-power deployment OR reduced-power deployment
Unoccupied seat	Reduced-power deployment

\* It is possible for a child to be classified as an adult, allowing a full-power Passenger Advanced Front Air Bag deployment. Never allow children to ride in the front passenger seat and never install a child restraint system, including a rear-facing child restraint, in the front passenger seat.

WARNING!
<ul style="list-style-type: none"> <li>• Never place a rear-facing child restraint in front of an air bag. A deploying passenger front air bag can cause death or serious injury to a child 12 years or younger, including a child in a rear-facing child restraint.</li> </ul>

(Continued)

### WARNING!

- Never install a rear-facing child restraint in the front seat of a vehicle. Only use a rear-facing child restraint in the rear seat. If the vehicle does not have a rear seat, do not transport a rear-facing child restraint in that vehicle.
- Children 12 years or younger should always ride buckled up in the rear seat of a vehicle with a rear seat.

The OCS determines the front passenger's most probable classification. The OCS estimates the seated weight on the front passenger seat and where that weight is located. The OCS communicates the classification status to the ORC. The ORC uses the classification to determine whether the Passenger Advanced Front Air Bag inflation rate should be adjusted.

In order for the OCS to operate as designed, it is important for the front passenger to be seated properly and properly wearing the seat belt. Properly seated passengers are:

- Sitting upright
- Facing forward
- Sitting in the center of the seat with their feet comfortably on or near the floor
- Sitting with their back against the seatback and the seatback in an upright position

**Seated Properly****Lighter Weight Passengers (Including Small Adults)**

When a lighter weight passenger, including a small adult, occupies the front passenger seat, the OCS may reduce the inflation rate of the Passenger Advanced Front Air Bag. This does not mean that the OCS is working improperly.

**Do not decrease OR increase the front passenger's seated weight on the front passenger seat**

The front passenger's seated weight must be properly positioned on the front passenger seat. Failure to do so may result in serious injury or death. The OCS determines the most probable classification of the occupant that it detects. The OCS will detect the front passenger's decreased or increased seated weight, which may result in an adjusted inflation rate of the Passenger Advanced Front Air Bag in a collision. This does not mean that the OCS is working improperly. Decreasing the front passenger's seated weight on the front passenger seat may result in a reduced-power deployment of the Passenger Advanced Front Air Bag. Increasing the front passenger's seated weight on the front passenger seat may result in a full-power deployment of the Passenger Advanced Front Air Bag.

Examples of improper front passenger seating include:

- The front passenger's weight is transferred to another part of the vehicle (like the door, arm rest or instrument panel).
- The front passenger leans forward, sideways, or turns to face the rear of the vehicle.
- The front passenger's seatback is not in the full upright position.
- The front passenger carries or holds an object while seated (e.g., backpack, box, etc.).
- Objects are lodged under the front passenger seat.
- Objects are lodged between the front passenger seat and center console.
- Accessories that may change the seated weight on the front passenger seat are attached to the front passenger seat.
- Anything that may decrease or increase the front passenger's seated weight.

The OCS determines the front passenger's most probable classification. If an occupant in the front passenger seat is seated improperly, the occupant may provide an output signal to the OCS that is different from the occupant's properly seated weight input, for example:

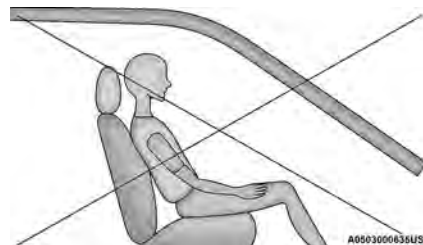
**Not Seated Properly****Not Seated Properly**

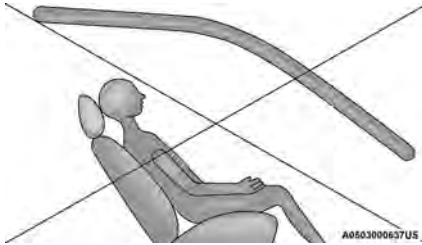

Not Seated Properly



Not Seated Properly

**WARNING!**

- If a child restraint system, child, small teenager or adult in the front passenger seat is seated improperly, the occupant may provide an output signal to the OCS that is different from the occupant's properly seated weight input. This may result in serious injury or death in a collision.

(Continued)

**WARNING!**

- Always wear your seat belt and sit properly, with the seatback in an upright position, your back against the seatback, sitting upright, facing forward, in the center of the seat, with your feet comfortably on or near the floor.
- Do not carry or hold any objects (e.g., backpacks, boxes, etc.) while seated in the front passenger seat. Holding an object may provide an output signal to the OCS that is different than the occupant's properly seated weight input, which may result in serious injury or death in a collision.
- Placing an object on the floor under the front passenger seat may prevent the OCS from working properly, which may result in serious injury or death in a collision. Do not place any objects on the floor under the front passenger seat.

 The Air Bag Warning Light in the instrument panel will turn on whenever the OCS is unable to classify the front passenger seat status. A malfunction in the OCS may affect the operation of the air bag system.

 If the Air Bag Warning Light does not come on, or stays on after you start the vehicle, or it comes on as you drive, take the vehicle to an authorized dealer for service immediately.

The passenger seat assembly contains critical OCS components that may affect the Passenger Advanced Front Air Bag inflation. In order for the OCS to properly classify the seated weight of a front seat passenger, the OCS components must function as designed. Do not make any modifications to the front passenger seat components, assembly, or to the seat cover. If the seat,

trim cover, or cushion needs service for any reason, take the vehicle to an authorized dealer. Only FCA US LLC approved seat accessories may be used.

The following requirements must be strictly followed:

- Do not modify the front passenger seat assembly or components in any way.
- Do not use prior or future model year seat covers or cushions not designated by FCA US LLC for the specific model being repaired. Always use the correct seat cover and cushion specified for the vehicle.
- Do not replace the seat cover or cushion with an aftermarket seat cover or cushion.
- Do not add a secondary seat cover or mat.
- At no time should any Supplemental Restraint System (SRS) component or SRS related component or fastener be modified or replaced with any part except those which are approved by FCA US LLC.

**WARNING!**

- Unapproved modifications or service procedures to the passenger seat assembly, its related components, seat cover or cushion may inadvertently change the air bag deployment in case of a frontal collision. This could result in death or serious injury to the front passenger if the vehicle is involved in a collision. A modified vehicle may not comply with required Federal Motor Vehicle Safety Standards (FMVSS) and/or Canadian Motor Vehicle Safety Standards (CMVSS).
- If it is necessary to modify the air bag system for persons with disabilities, contact an authorized dealer.

## Knee Impact Bolsters

The Knee Impact Bolsters help protect the knees of the driver and front passenger, and position the front occupants for improved interaction with the front air bags.

### WARNING!

- Do not drill, cut, or tamper with the knee impact bolsters in any way.
- Do not mount any accessories to the knee impact bolsters such as alarm lights, stereos, citizen band radios, etc.

## Supplemental Driver Knee Air Bag

This vehicle is equipped with a Supplemental Driver Knee Air Bag mounted in the instrument panel below the steering column. The Supplemental Driver Knee Air Bag provides enhanced protection during a frontal impact by working together with the seat belts, pretensioners, and front air bags.

## Supplemental Side Air Bags

### Supplemental Seat-Mounted Side Air Bags (SABs)

This vehicle is equipped with Supplemental Seat-Mounted Side Air Bags (SABs).

Supplemental Seat-Mounted Side Air Bags (SABs) are located in the outboard side of the front seats. The SABs are marked with “SRS AIRBAG” or “AIRBAG” on a label or on the seat trim on the outboard side of the seats.

The SABs may help to reduce the risk of occupant injury during certain side impacts, in addition to the injury reduction potential provided by the seat belts and body structure.



**Front Supplemental Seat-Mounted Side Air Bag**

When the SAB deploys, it opens the seam on the outboard side of the seatback's trim cover. The inflating SAB deploys through the seat seam into the space between the occupant and the door. The SAB moves at a very high speed and with such a high force that it could injure occupants if they are not seated properly, or if items are positioned in the area where the SAB inflates. Children are at an even greater risk of injury from a deploying air bag.

### WARNING!

Do not use accessory seat covers or place objects between you and the Side Air Bags; the performance could be adversely affected and/or objects could be pushed into you, causing serious injury.

## Supplemental Side Air Bag Inflatable Curtains (SABICs)

This vehicle is equipped with Supplemental Side Air Bag Inflatable Curtains (SABICs).

Supplemental Side Air Bag Inflatable Curtains (SABICs) are located above the side windows. The trim covering the SABICs is labeled “SRS AIRBAG” or “AIRBAG.”



**Supplemental Side Air Bag Inflatable Curtain (SABIC)  
Label Location**

SABICs may help reduce the risk of head and other injuries to front and rear seat outboard occupants in certain side impacts, in addition to the injury reduction potential provided by the seat belts and body structure.

The SABIC deploys downward, covering the side windows. An inflating SABIC pushes the outside edge of the headliner out of the way and covers the window. The SABICs inflate with enough force to injure occupants if they are not belted and seated properly, or if items are positioned in the area where the SABICs inflate. Children are at an even greater risk of injury from a deploying air bag.

The SABICs may help reduce the risk of partial or complete ejection of vehicle occupants through side windows in certain side impact events.

#### WARNING!

- Do not mount equipment, or stack luggage or other cargo up high enough to block the deployment of the SABICs. The trim covering above the side windows where the SABIC and its deployment path are located should remain free from any obstructions.
- In order for the SABICs to work as intended, do not install any accessory items in your vehicle which could alter the roof. Do not add an aftermarket sunroof to your vehicle. Do not add roof racks that require permanent attachments (bolts or screws) for installation on the vehicle roof. Do not drill into the roof of the vehicle for any reason.

#### Side Impacts

The Side Air Bags are designed to activate in certain side impacts. The Occupant Restraint Controller (ORC) determines whether the deployment of the Side Air Bags in a particular impact event is appropriate, based on the severity and type of collision. The side impact sensors aid the ORC in determining the appropriate response to impact events. The system is calibrated to deploy the Side Air Bags on the impact side of the vehicle during impacts that require Side Air Bag occupant protection. In side impacts, the Side Air Bags deploy independently; a left side impact deploys the left Side Air Bags only and a right-side impact deploys the right Side Air Bags only. Vehicle damage by itself is not a good indicator of whether or not Side Air Bags should have deployed.

The Side Air Bags will not deploy in all side collisions, including some collisions at certain angles, or some side collisions that do not impact the area of the passenger compartment. The Side Air Bags may deploy during angled or offset frontal collisions where the front air bags deploy.

Side Air Bags are a supplement to the seat belt restraint system. Side Air Bags deploy in less time than it takes to blink your eyes.

#### WARNING!

- Occupants, including children, who are up against or very close to Side Air Bags can be seriously injured or killed. Occupants, including children, should never lean on or sleep against the door, side windows, or area where the side air bags inflate, even if they are in an infant or child restraint.
- Seat belts (and child restraints where appropriate) are necessary for your protection in all collisions. They also help keep you in position, away from an inflating Side Air Bag. To get the best protection from the Side Air Bags, occupants must wear their seat belts properly and sit upright with their backs against the seats. Children must be properly restrained in a child restraint or booster seat that is appropriate for the size of the child.

#### WARNING!

- Side Air Bags need room to inflate. Do not lean against the door or window. Sit upright in the center of the seat.

(Continued)

#### WARNING!

- Being too close to the Side Air Bags during deployment could cause you to be severely injured or killed.
- Relying on the Side Air Bags alone could lead to more severe injuries in a collision. The Side Air Bags work with your seat belt to restrain you properly. In some collisions, Side Air Bags won't deploy at all. Always wear your seat belt even though you have Side Air Bags.

#### NOTE:

Air bag covers may not be obvious in the interior trim, but they will open during air bag deployment.

#### Rollover Events

Side Air Bags and seat belt pretensioners are designed to activate in certain rollover events. The Occupant Restraint Controller (ORC) determines whether deployment in a particular rollover event is appropriate, based on the severity and type of collision. Vehicle damage by itself is not a good indicator of whether or not Side Air Bags and seat belt pretensioners should have deployed.

The Side Air Bags and seat belt pretensioners will not deploy in all rollover events. The rollover sensing system determines if a rollover event may be in progress and whether deployment is appropriate. In the event the vehicle experiences a rollover or near rollover event, and deployment is appropriate, the rollover sensing system will deploy the side air bags and seat belt pretensioners on both sides of the vehicle.

The SABICs may help reduce the risk of partial or complete ejection of vehicle occupants through side windows in certain rollover or side impact events.

## Air Bag System Components

### NOTE:

The Occupant Restraint Controller (ORC) monitors the internal circuits and interconnecting wiring associated with electrical Air Bag System Components provided:

- Occupant Restraint Controller (ORC)
- Air Bag Warning Light 
- Steering Wheel and Column
- Instrument Panel
- Knee Impact Bolsters
- Driver and Front Passenger Air Bags
- Seat Belt Buckle Switch
- Supplemental Side Air Bags
- Supplemental Knee Air Bags
- Front and Side Impact Sensors
- Seat Belt Pretensioners
- Seat Track Position Sensors
- Occupant Classification System

## If A Deployment Occurs

The front air bags are designed to deflate immediately after deployment.

### NOTE:

Front and/or side air bags will not deploy in all collisions. This does not mean something is wrong with the air bag system.

If you do have a collision which deploys the air bags, any or all of the following may occur:

- The air bag material may sometimes cause abrasions and/or skin reddening to the occupants as the air bags deploy and unfold. The abrasions are simi-

lar to friction rope burns or those you might get sliding along a carpet or gymnasium floor. They are not caused by contact with chemicals. They are not permanent and normally heal quickly. However, if you haven't healed significantly within a few days, or if you have any blistering, see your doctor immediately.

- As the air bags deflate, you may see some smoke-like particles. The particles are a normal by-product of the process that generates the non-toxic gas used for air bag inflation. These airborne particles may irritate the skin, eyes, nose, or throat. If you have skin or eye irritation, rinse the area with cool water. For nose or throat irritation, move to fresh air. If the irritation continues, see your doctor. If these particles settle on your clothing, follow the garment manufacturer's instructions for cleaning.

Do not drive your vehicle after the air bags have deployed. If you are involved in another collision, the air bags will not be in place to protect you.

### WARNING!

Deployed air bags and seat belt pretensioners cannot protect you in another collision. Have the air bags, seat belt pretensioners, and the seat belt retractor assemblies replaced by an authorized dealer immediately. Also, have the Occupant Restraint Controller System serviced as well.

### NOTE:

- Air bag covers may not be obvious in the interior trim, but they will open during air bag deployment.
- After any collision, the vehicle should be taken to an authorized dealer immediately.

## Enhanced Accident Response System

In the event of an impact, if the communication network remains intact, and the power remains intact, depending on the nature of the event, the Occupant Restraint Controller (ORC) will determine whether to have the Enhanced Accident Response System perform the provided functions:

- Cut off fuel to the engine (if equipped)
- Cut off battery power to the electric motor (if equipped)
- Flash hazard lights as long as the battery has power
- Turn on the interior lights, which remain on as long as the battery has power or for 15 minutes from the intervention of the Enhanced Accident Response System
- Unlock the power door locks

Your vehicle may also be designed to perform any of these other functions in response to the Enhanced Accident Response System:

- Turn off the Fuel Filter Heater, Turn off the HVAC Blower Motor, Close the HVAC Circulation Door
- Cut off battery power to the:
  - Engine
  - Electric Motor (if equipped)
  - Electric power steering
  - Brake booster
  - Electric park brake
  - Automatic transmission gear selector
  - Horn
  - Front wiper

**NOTE:**

After an accident, place the ignition in the STOP (OFF) position to avoid draining the battery. Carefully check the vehicle for fuel leaks in the engine compartment and on the ground near the engine compartment and fuel tank before resetting the system and starting the engine. If there are no fuel leaks or damage to the vehicle electrical devices (e.g. headlights) after an accident, reset the system by following the procedure provided. If you have any doubt, contact an authorized dealer.

### Enhanced Accident Response System Reset Procedure

After an event occurs requiring activation of the Enhanced Accident Response System, when the system is active, a "Service Hybrid Electric Vehicle System" message will be displayed on the instrument cluster. The vehicle is not drivable in this state.

In order to reset the high voltage battery and engine, the vehicle must be towed to an authorized dealer immediately to be inspected and have the Enhanced Accident Response System reset.

In order to immediately reset the hazard flashers, interior lights, power door locks, or the HVAC blower motor, the ignition switch must be changed from START or ON/RUN to ignition OFF.

After the event occurs, when the system is active, a message regarding fuel cutoff is displayed. Turn the ignition switch from ignition AVV/START or MAR/ON/RUN to ignition STOP/OFF/LOCK. Carefully check the vehicle for fuel leaks in the engine compartment and on the ground near the engine compartment and fuel tank before resetting the system and starting the engine.

Depending on the nature of the event the left and right turn signal lights, located in the instrument panel, may both be blinking and will continue to blink. In order to move your vehicle to the side of the road, you must follow the system reset procedure.

Customer Action	Customer Will See
<b>NOTE:</b> Each step <b>MUST BE</b> held for at least two seconds	
1. Place the ignition OFF. (Turn Signal Switch Must be placed in Neutral State).	
2. Place the ignition ON/RUN.	Right turn light BLINKS. Left turn light is OFF.
3. Turn right turn signal switch ON.	Right turn light is ON SOLID. Left turn light BLINKS.
4. Place turn signal in neutral state.	Right turn light is OFF. Left turn light BLINKS.
5. Turn left turn signal switch ON.	Right turn light BLINKS. Left turn light is ON SOLID.
6. Place turn signal in neutral state.	Right turn light BLINKS. Left turn light is OFF.
7. Turn right turn signal switch ON.	Right turn light is ON SOLID. Left turn light BLINKS.

Customer Action	Customer Will See
<b>NOTE:</b> <b>Each step MUST BE held for at least two seconds</b>	
8. Place turn signal in neutral state.	Right turn light is OFF. Left turn light BLINKS.
9. Turn left turn signal switch ON.	Right turn light is ON SOLID. Left turn light is ON SOLID.
10. Turn left turn signal switch OFF. (Turn Signal Switch Must be placed in Neutral State).	Right turn light is OFF. Left turn light is OFF.
11. Place the ignition OFF.	
12. Please the ignition ON/RUN. (Entire sequence needs to be completed within one minute or sequence will need to be repeated).	System is now reset and the engine may be started.
Turn hazard flashers OFF (Manually).	

If a reset procedure step is not completed within 60 seconds, then the turn signal lights will blink and the reset procedure must be performed again in order to be successful.

## Maintaining Your Air Bag System

### WARNING!

- Modifications to any part of the air bag system could cause it to fail when you need it. You could be injured if the air bag system is not there to protect you. Do not modify the components or wiring, including adding any kind of badges or stickers to the steering wheel hub trim cover or the upper passenger side of the instrument panel. Do not modify the front fascia/bumper, vehicle body structure, or add aftermarket side steps or running boards.
- It is dangerous to try to repair any part of the air bag system yourself. Be sure to tell anyone who works on your vehicle that it has an air bag system.
- Do not attempt to modify any part of your air bag system. The air bag may inflate accidentally or may not function properly if modifications are made. Take your vehicle to an authorized dealer for any air bag system service. If your seat, including your trim cover and cushion, needs to be serviced in any way (including removal or loosening/tightening of seat attachment bolts), take the vehicle to an authorized dealer. Only manufacturer approved seat accessories may be used. If it is necessary to modify the air bag system for persons with disabilities, contact an authorized dealer.



## Event Data Recorder (EDR)

This vehicle is equipped with an event data recorder (EDR). The main purpose of an EDR is to record, in certain crash or near crash-like situations, such as an air bag deployment or hitting a road obstacle, data that will assist in understanding how a vehicle's systems performed. The EDR is designed to record data related to vehicle dynamics and safety systems for a short period of time, typically 30 seconds or less. The EDR in this vehicle is designed to record such data as:

- How various systems in your vehicle were operating;
- Whether or not the driver and passenger safety belts were buckled/fastened;
- How far (if at all) the driver was depressing the accelerator and/or brake pedal; and,
- How fast the vehicle was traveling.

These data can help provide a better understanding of the circumstances in which crashes and injuries occur.

### NOTE:

EDR data are recorded by your vehicle only if a non-trivial crash situation occurs; no data are recorded by the EDR under normal driving conditions and no personal data (e.g., name, gender, age, and crash location) are recorded. However, other parties, such as law enforcement, could combine the EDR data with the type of personally identifying data routinely acquired during a crash investigation.

To read data recorded by an EDR, special equipment is required, and access to the vehicle or the EDR is needed. In addition to the vehicle manufacturer, other parties, such as law enforcement, that have the special equipment, can read the information if they have access to the vehicle or the EDR.

## CHILD RESTRAINTS

Everyone in your vehicle needs to be buckled up at all times, including babies and children. Every state in the United States, and every Canadian province, requires that small children ride in proper restraint systems. This is the law, and you can be prosecuted for ignoring it.

Children 12 years or younger should ride properly buckled up in a rear seat, if available. According to crash statistics, children are safer when properly restrained in the rear seats rather than in the front.

### WARNING!

In a collision, an unrestrained child can become a projectile inside the vehicle. The force required to hold even an infant on your lap could become so great that you could not hold the child, no matter how strong you are. The child and others could be badly injured or killed. Any child riding in your vehicle should be in a proper restraint for the child's size.

There are different sizes and types of restraints for children from newborn size to the child almost large enough for an adult safety belt. Always check the child seat Owner's Manual to make sure you have the correct seat for your child. Carefully read and follow all the instructions and warnings in the child restraint Owner's Manual and on all the labels attached to the child restraint.

Before buying any restraint system, make sure that it has a label certifying that it meets all applicable Safety Standards. You should also make sure that you can install it in the vehicle where you will use it.

### NOTE:

- For additional information, refer to <http://www.nhtsa.gov/parents-and-caregivers> or call: 1-888-327-4236
- Canadian residents should refer to Transport Canada's website for additional information: <https://www.tc.gc.ca/en/services/road/child-car-seat-safety.html>

## Summary Of Recommendations For Restraining Children In Vehicles

	Child Size, Height, Weight Or Age	Recommended Type Of Child Restraint
Infants and Toddlers	Children who are two years old or younger and who have not reached the height or weight limits of their child restraint	Either an Infant Carrier or a Convertible Child Restraint, facing rearward in a rear seat of the vehicle
Small Children	Children who are at least two years old or who have outgrown the height or weight limit of their rear-facing child restraint	Forward-Facing Child Restraint with a five-point Harness, facing forward in a rear seat of the vehicle
Larger Children	Children who have outgrown their forward-facing child restraint, but are too small to properly fit the vehicle's seat belt	Belt Positioning Booster Seat and the vehicle seat belt, seated in a rear seat of the vehicle
Children Too Large for Child Restraints	Children 12 years old or younger, who have outgrown the height or weight limit of their booster seat	Vehicle Seat Belt, seated in a rear seat of the vehicle

### Infant And Child Restraints

Safety experts recommend that children ride rear-facing in the vehicle until they are two years old or until they reach either the height or weight limit of their rear-facing child restraint. Two types of child restraints can be used rear-facing: infant carriers and convertible child seats.

The infant carrier is only used rear-facing in the vehicle. It is recommended for children from birth until they reach the weight or height limit of the infant carrier. Convertible child seats can be used either rear-facing or forward-facing in the vehicle. Convertible child seats often have a higher weight limit in the rear-facing direction than infant carriers do, so they can be used rear-facing by children who have outgrown their infant carrier but are still less than at least two years old. Children should remain rear-facing until they reach the highest weight or height allowed by their convertible child seat.

#### WARNING!

- Never place a rear-facing child restraint in front of an air bag. A deploying passenger front air bag can cause death or serious injury to a child 12 years or younger, including a child in a rear-facing child restraint.
- Never install a rear-facing child restraint in the front seat of a vehicle. Only use a rear-facing child restraint in the rear seat. If the vehicle does not have a rear seat, do not transport a rear-facing child restraint in that vehicle.

### Older Children And Child Restraints

Children who are two years old or who have outgrown their rear-facing convertible child seat can ride forward-facing in the vehicle. Forward-facing child seats and convertible child seats used in the forward-facing direction are for children who are over two years old or who have outgrown the rear-facing weight or height limit of their rear-facing convertible child seat. Children should remain in a forward-facing child seat with a harness for as long as possible, up to the highest weight or height allowed by the child seat.

All children whose weight or height is above the forward-facing limit for the child seat should use a belt-positioning booster seat until the vehicle's seat belts fit properly. If the child cannot sit with knees bent over the vehicle's seat cushion while the child's back is against the seatback, they should use a belt-positioning booster seat. The child and belt-positioning booster seat are held in the vehicle by the seat belt.

**WARNING!**

- Improper installation can lead to failure of an infant or child restraint. It could come loose in a collision. The child could be badly injured or killed. Follow the child restraint manufacturer's directions exactly when installing an infant or child restraint.
- After a child restraint is installed in the vehicle, do not move the vehicle seat forward or rearward because it can loosen the child restraint attachments. Remove the child restraint before adjusting the vehicle seat position. When the vehicle seat has been adjusted, reinstall the child restraint.
- When your child restraint is not in use, secure it in the vehicle with the seat belt or LATCH anchorages, or remove it from the vehicle. Do not leave it loose in the vehicle. In a sudden stop or accident, it could strike the occupants or seatbacks and cause serious personal injury.

**Children Too Large For Booster Seats**

Children who are large enough to wear the shoulder belt comfortably, and whose legs are long enough to bend over the front of the seat when their back is against the seatback, should use the seat belt in a rear seat. Use this simple 5-step test to decide whether the child can use the vehicle's seat belt alone:

1. Can the child sit all the way back against the back of the vehicle seat?
2. Do the child's knees bend comfortably over the front of the vehicle seat while the child is still sitting all the way back?
3. Does the shoulder belt cross the child's shoulder between the neck and arm?
4. Is the lap part of the belt as low as possible, touching the child's thighs and not the stomach?
5. Can the child stay seated like this for the whole trip?

If the answer to any of these questions was "no," then the child still needs to use a booster seat in this vehicle. If the child is using the lap/shoulder belt, check seat belt fit periodically and make sure the seat belt buckle is latched. A child's squirming or slouching can move the belt out of position. If the shoulder belt contacts the face or neck, move the child closer to the center of the vehicle, or use a booster seat to position the seat belt on the child correctly.

**WARNING!**

Never allow a child to put the shoulder belt under an arm or behind their back. In a crash, the shoulder belt will not protect a child properly, which may result in serious injury or death. A child must always wear both the lap and shoulder portions of the seat belt correctly.

**Recommendations For Attaching Child Restraints**

Restraint Type	Combined Weight of the Child + Child Restraint	Use Any Attachment Method Shown With An "X" Below			
		LATCH - Lower Anchors Only	Seat Belt Only	LATCH - Lower Anchors + Top Tether Anchor	Seat Belt + Top Tether Anchor
Rear-Facing Child Restraint	Up to 65 lb (29.5 kg)	X	X		
Rear-Facing Child Restraint	More than 65 lb (29.5 kg)		X		
Forward-Facing Child Restraint	Up to 65 lb (29.5 kg)			X	X
Forward-Facing Child Restraint	More than 65 lb (29.5 kg)				X

## Lower Anchors And Tethers For Children (LATCH) Restraint System



022668173

**LATCH Label**

Your vehicle is equipped with the child restraint anchorage system called LATCH, which stands for Lower Anchors and Tethers for Children. The LATCH system has three vehicle anchor points for installing LATCH-equipped child seats. There are two lower anchorages located at the back of the seat cushion where it meets the seatback and one top tether anchorage located behind the seating position. These anchorages are used to install LATCH-equipped child seats without using the vehicle's seat belts. Some seating positions may have a top tether anchorage but no lower anchorages. In these seating positions, the seat belt must be used with the top tether anchorage to install the child restraint. Please see the following table for more information.

## LATCH Positions For Installing Child Restraints In This Vehicle



B0503001268US

**LATCH Positions**

 Lower Anchorage Symbol (2 Anchorages Per Seating Position)

 Top Tether Anchorage Symbol

### Frequently Asked Questions About Installing Child Restraints With LATCH

What is the weight limit (child's weight + weight of the child restraint) for using the LATCH anchorage system to attach the child restraint?	65 lb (29.5 kg)	Use the LATCH anchorage system until the combined weight of the child and the child restraint is 65 lb (29.5 kg). Use the seat belt and tether anchor instead of the LATCH system once the combined weight is more than 65 lb (29.5 kg).
Can the LATCH anchorages and the seat belt be used together to attach a rear-facing or forward-facing child restraint?	No	Do not use the seat belt when you use the LATCH anchorage system to attach a rear-facing or forward-facing child restraint. Booster seats may be attached to the LATCH anchorages if allowed by the booster seat manufacturer. See your booster seat owner's manual for more information.
Can a child seat be installed in the center position using the inner LATCH lower anchorages from the outboard seating positions?	No	
Can two child restraints be attached using a common lower LATCH anchorage?	No	Never "share" a LATCH anchorage with two or more child restraints. If the center position does not have dedicated LATCH lower anchorages, use the seat belt to install a child seat in the center position next to a child seat using the LATCH anchorages in an outboard position.
Can the rear-facing child restraint touch the back of the front passenger seat?	Yes	The child seat may touch the back of the front passenger seat if the child restraint manufacturer also allows contact. See your child restraint owner's manual for more information.
Can the rear head restraints be removed?	Yes	Only the outboard head restraints are removable.

## Locating The LATCH Anchorages



The lower anchorages are round bars that are found at the rear of the seat cushion where it meets the seatback, below the anchorage symbols on the seatback. They are just visible when you lean into the rear seat to install the child restraint. You will easily feel them if you run your finger along the gap between the seatback and seat cushion.

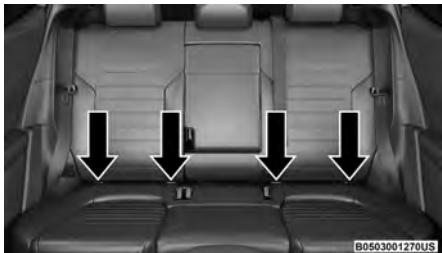

Lower Anchorage Location

## Locating The Upper Tether Anchorages



There are tether strap anchorages behind each rear seating position located on the back of the seat.

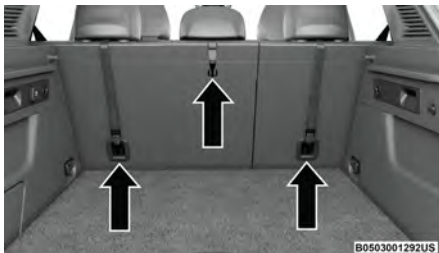

Tether Anchorage Locations

LATCH-compatible child restraint systems will be equipped with a rigid bar or a flexible strap on each side. Each will have a hook or connector to attach to the lower anchorage and a way to tighten the connection to the anchorage. Forward-facing child restraints and some rear-facing child restraints will also be equipped with a tether strap. The tether strap will have a hook at the end to attach to the top tether anchorage and a way to tighten the strap after it is attached to the anchorage.

## Center Seat LATCH

### WARNING!

Do not install a child restraint in the center position using the LATCH system. This position is not approved for installing child seats using the LATCH attachments. You must use the seat belt and tether anchor to install a child seat in the center seating position.

(Continued)

### WARNING!

Never use the same lower anchorage to attach more than one child restraint.

Please see page 204 for typical installation instructions.

Always follow the directions of the child restraint manufacturer when installing your child restraint. Not all child restraint systems will be installed as described here.

## To Install A LATCH-Compatible Child Restraint

If the selected seating position has a Switchable Automatic Locking Retractor (ALR) seat belt, stow the seat belt, following the instructions provided. See page 205 to check what type of seat belt each seating position has.

1. Loosen the adjusters on the lower straps and on the tether strap of the child seat so that you can more easily attach the hooks or connectors to the vehicle anchorages.
2. Place the child seat between the lower anchorages for that seating position. If the second row seat can be reclined, you may recline the seat and/or raise the head restraint (if adjustable) to get a better fit. If the rear seat can be moved forward and rearward in the vehicle, you may wish to move it to its rear-most position to make room for the child seat. You may also move the front seat forward to allow more room for the child seat.
3. Attach the lower hooks or connectors of the child restraint to the lower anchorages in the selected seating position.

- If the child restraint has a tether strap, connect it to the top tether anchorage. See  page 207 for directions to attach a tether anchor.
- Tighten all of the straps as you push the child restraint rearward and downward into the seat. Remove slack in the straps according to the child restraint manufacturer's instructions.
- Test that the child restraint is installed tightly by pulling back and forth on the child seat at the belt path. It should not move more than 1 inch (25.4 mm) in any direction.

### How To Stow An Unused Switchable-ALR (ALR) Seat Belt:

When using the LATCH attaching system to install a child restraint, stow all ALR seat belts that are not being used by other occupants or being used to secure child restraints. An unused belt could injure a child if they play with it and accidentally lock the seat belt retractor. Before installing a child restraint using the LATCH system, buckle the seat belt behind the child restraint and out of the child's reach. If the buckled seat belt interferes with the child restraint installation, instead of buckling it behind the child restraint, route the seat belt through the child restraint belt path and then buckle it. Do not lock the seat belt. Remind all children in the vehicle that the seat belts are not toys and that they should not play with them.

#### WARNING!

- Improper installation of a child restraint to the LATCH anchorages can lead to failure of the restraint. The child could be badly injured or killed. Follow the child restraint manufacturer's directions exactly when installing an infant or child restraint.
- Child restraint anchorages are designed to withstand only those loads imposed by correctly-fitted child restraints. Under no circumstances are they to be used for adult seat belts, harnesses, or for attaching other items or equipment to the vehicle.

### Installing Child Restraints Using The Vehicle Seat Belt

Child restraint systems are designed to be secured in vehicle seats by lap belts or the lap belt portion of a lap/shoulder belt.

#### WARNING!

- Improper installation or failure to properly secure a child restraint can lead to failure of the restraint. The child could be badly injured or killed.
- Follow the child restraint manufacturer's directions exactly when installing an infant or child restraint.

The seat belts in the passenger seating positions are equipped with a Switchable Automatic Locking Retractor (ALR) that is designed to keep the lap portion of the seat belt tight around the child restraint so that it is not necessary to use a locking clip. The ALR retractor can be "switched" into a locked mode by pulling all of the webbing out of the retractor and then letting the web-

bing retract back into the retractor. If it is locked, the ALR will make a clicking noise while the webbing is pulled back into the retractor.

See the "Automatic Locking Mode" description  page 187 for additional information on ALR.

Please see the table in the following sections for more information.

### Lap/Shoulder Belt Systems For Installing Child Restraints In This Vehicle



B0503001266US

#### Automatic Locking Retractor (ALR) Locations

ALR – Switchable Automatic Locking Retractor  
 Top Tether Anchorage Symbol

### Frequently Asked Questions About Installing Child Restraints With Seat Belts

What is the weight limit (child's weight + weight of the child restraint) for using the Tether Anchor with the seat belt to attach a forward-facing child restraint?	Weight limit of the Child Restraint	Always use the tether anchor when using the seat belt to install a forward-facing child restraint, up to the recommended weight limit of the child restraint.
Can the rear-facing child restraint touch the back of the front passenger seat?	Yes	Contact between the front passenger seat and the child restraint is allowed, if the child restraint manufacturer also allows contact.
Can the rear head restraints be removed?	Yes	The rear outboard head restraints can be removed if they interfere with the installation of the child restraint.
Can the buckle stalk be twisted to tighten the seat belt against the belt path of the child restraint?	No	Do not twist the buckle stalk in a seating position with an ALR retractor.

## Installing A Child Restraint With A Switchable Automatic Locking Retractor (ALR):

Child restraint systems are designed to be secured in vehicle seats by lap belts or the lap belt portion of a lap/shoulder belt.

### WARNING!

- Improper installation or failure to properly secure a child restraint can lead to failure of the restraint. The child could be badly injured or killed.
- Follow the child restraint manufacturer's directions exactly when installing an infant or child restraint.

1. Place the child seat in the center of the seating position. If the second row seat can be reclined, you may recline the seat and/or raise the head restraint (if adjustable) to get a better fit. If the rear seat can be moved forward and rearward in the vehicle, you may

wish to move it to its rear-most position to make room for the child seat. You may also move the front seat forward to allow more room for the child seat.

2. Pull enough of the seat belt webbing from the retractor to pass it through the belt path of the child restraint. Do not twist the belt webbing in the belt path.
3. Slide the latch plate into the buckle until you hear a "click."
4. Pull on the webbing to make the lap portion tight against the child seat.
5. To lock the seat belt, pull down on the shoulder part of the belt until you have pulled all the seat belt webbing out of the retractor. Then, allow the webbing to retract back into the retractor. As the webbing retracts, you will hear a clicking sound. This means the seat belt is now in the Automatic Locking mode.

6. Try to pull the webbing out of the retractor. If it is locked, you should not be able to pull out any webbing. If the retractor is not locked, repeat step 5.
7. Finally, pull up on any excess webbing to tighten the lap portion around the child restraint while you push the child restraint rearward and downward into the vehicle seat.
8. If the child restraint has a top tether strap and the seating position has a top tether anchorage, connect the tether strap to the anchorage and tighten the tether strap. See  page 207 for directions to attach a tether anchor.
9. Test that the child restraint is installed tightly by pulling back and forth on the child seat at the belt path. It should not move more than 1 inch (25.4 mm) in any direction.

Any seat belt system will loosen with time, so check the belt occasionally, and pull it tight if necessary.



## Installing Child Restraints Using The Top Tether Anchorage:

### WARNING!

Do not attach a tether strap for a rear-facing car seat to any location in front of the car seat, including the seat frame or a tether anchorage. Only attach the tether strap of a rear-facing car seat to the tether anchorage that is approved for that seating position, located behind the top of the vehicle seat. See [page 202](#) for the location of approved tether anchorages in your vehicle.



1. Look behind the seating position where you plan to install the child restraint to find the tether anchorage. You may need to move the seat forward to provide better access to the tether anchorage. If there is no top tether anchorage for that seating position, move the child restraint to another position in the vehicle if one is available.
2. Route the tether strap to provide the most direct path for the strap between the anchor and the child seat. If your vehicle is equipped with adjustable rear head restraints, raise the head restraint, and where possible, route the tether strap under the head

restraint and between the two posts. If not possible, lower the head restraint and pass the tether strap around the outboard side of the head restraint.

3. Attach the tether strap hook of the child restraint to the top tether anchorage as shown in the diagram.
4. Remove slack in the tether strap according to the child restraint manufacturer's instructions.

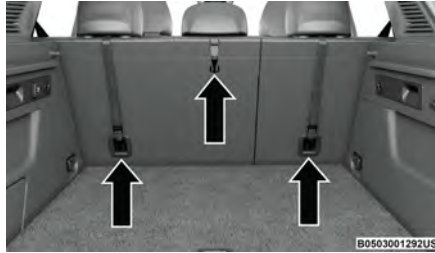

Rear Seat Tether Anchors

### WARNING!

- An incorrectly anchored tether strap could lead to increased head motion and possible injury to the child. Use only the anchorage position directly behind the child seat to secure a child restraint top tether strap.
- If your vehicle is equipped with a split rear seat, make sure the tether strap does not slip into the opening between the seatbacks as you remove slack in the strap.

## SAFETY TIPS

### TRANSPORTING PASSENGERS

NEVER TRANSPORT PASSENGERS IN THE CARGO AREA.

### WARNING!

- Do not leave children or animals inside parked vehicles in hot weather. Interior heat buildup may cause serious injury or death.
- It is extremely dangerous to ride in a cargo area, inside or outside of a vehicle. In a collision, people riding in these areas are more likely to be seriously injured or killed.
- Do not allow people to ride in any area of your vehicle that is not equipped with seats and seat belts.
- Be sure everyone in your vehicle is in a seat and using a seat belt properly.

### TRANSPORTING PETS

Air Bags deploying in the front seat could harm your pet. An unrestrained pet will be thrown about and possibly injured, or injure a passenger during panic braking or in a collision.

Pets should be restrained in the rear seat (if equipped) in pet harnesses or pet carriers that are secured by seat belts.

## CONNECTED VEHICLES

Privacy of any wireless and wired communications cannot be assured. Third parties may unlawfully intercept information and private communications without your consent. For further information, refer to "Data Collection & Privacy" in your Uconnect Radio Instruction Manual or ↩ page 96.

### WARNING!

It is not possible to know or to predict all of the possible outcomes if your vehicle's systems are breached. It may be possible that vehicle systems, including safety related systems, could be impaired or a loss of vehicle control could occur that may result in an accident involving serious injury or death.

## SAFETY CHECKS YOU SHOULD MAKE INSIDE THE VEHICLE

### Seat Belts

Inspect the seat belt system periodically, checking for cuts, frays, and loose parts. Damaged parts must be replaced immediately. Do not disassemble or modify the system.

If your vehicle is involved in a collision, or if you have questions regarding the seat belt or retractor conditions, take your vehicle to an authorized FCA dealer or authorized FCA Certified Collision Care Program facility for inspection.

## Air Bag Warning Light



The Air Bag Warning Light will turn on for four to eight seconds as a bulb check when the ignition switch is first placed in the ON/RUN position. If the light is either not on during starting, stays on, or turns on while driving, have the system inspected at an authorized dealer as soon as possible. After the bulb check, this light will illuminate with a single chime when a fault with the Air Bag System has been detected. It will stay on until the fault is removed. If the light comes on intermittently or remains on while driving, have an authorized dealer service the vehicle immediately ↩ page 182.

### Defroster

Check operation by selecting the defrost mode and place the blower control on high speed. You should be able to feel the air directed against the windshield. See an authorized dealer for service if your defroster is inoperable.



### Floor Mat Safety Information

Always use floor mats designed to fit your vehicle. Only use a floor mat that does not interfere with the operation of the accelerator, brake or clutch pedals. Only use a floor mat that is securely attached using the floor mat fasteners so it cannot slip out of position and interfere with the accelerator, brake or clutch pedals or impair safe operation of your vehicle in other ways.

### WARNING!

An improperly attached, damaged, folded, or stacked floor mat, or damaged floor mat fasteners may cause your floor mat to interfere with the accelerator, brake, or clutch pedals and cause a loss of vehicle control.

To prevent SERIOUS INJURY or DEATH:

- ALWAYS securely attach your floor mat using the floor mat fasteners. DO NOT install your floor mat upside down or turn your floor mat over. Lightly pull to confirm mat is secured using the floor mat fasteners on a regular basis. 
- ALWAYS REMOVE THE EXISTING FLOOR MAT FROM THE VEHICLE before installing any other floor mat. NEVER install or stack an additional floor mat on top of an existing floor mat. 
- ONLY install floor mats designed to fit your vehicle. NEVER install a floor mat that cannot be properly attached and secured to your vehicle. If a floor mat needs to be replaced, only use a FCA approved floor mat for the specific make, model, and year of your vehicle.
- ONLY use the driver's side floor mat on the driver's side floor area. To check for interference, with the vehicle properly parked with the engine off, fully depress the accelerator, the brake, and the clutch pedal (if present) to check for interference. If your floor mat interferes with the operation of any pedal, or is not secure to the floor, remove the floor mat from the vehicle and place the floor mat in your trunk.
- ONLY use the passenger's side floor mat on the passenger's side floor area.

(Continued)

**WARNING!**

- ALWAYS make sure objects cannot fall or slide into the driver's side floor area when the vehicle is moving. Objects can become trapped under accelerator, brake, or clutch pedals and could cause a loss of vehicle control.
- NEVER place any objects under the floor mat (e.g., towels, keys, etc.). These objects could change the position of the floor mat and may cause interference with the accelerator, brake, or clutch pedals.
- If the vehicle carpet has been removed and re-installed, always properly attach carpet to the floor and check the floor mat fasteners are secure to the vehicle carpet. Fully depress each pedal to check for interference with the accelerator, brake, or clutch pedals then re-install the floor mats.
- It is recommended to only use mild soap and water to clean your floor mats. After cleaning, always check your floor mat has been properly installed and is secured to your vehicle using the floor mat fasteners by lightly pulling mat.

## PERIODIC SAFETY CHECKS YOU SHOULD MAKE OUTSIDE THE VEHICLE

### Tires

Examine tires for excessive tread wear and uneven wear patterns. Check for stones, nails, glass, or other objects lodged in the tread or sidewall. Inspect the tread for cuts and cracks. Inspect sidewalls for cuts, cracks, and bulges. Check the lug nut/bolt torque for tightness. Check the tires (including spare) for proper cold inflation pressure.

### Lights

Have someone observe the operation of brake lights and exterior lights while you work the controls. Check turn signal and high beam indicator lights on the instrument panel.

### Door Latches

Check for proper closing, latching, and locking.

### Fluid Leaks

Check area under the vehicle after overnight parking for fuel, coolant, oil, or other fluid leaks. Also, if gasoline fumes are detected or if fuel or brake fluid leaks are suspected, the cause should be located and corrected immediately.

## EXHAUST GAS

**WARNING!**

Exhaust gases can injure or kill. They contain carbon monoxide (CO), which is colorless and odorless. Breathing it can make you unconscious and can eventually poison you. To avoid breathing (CO), follow these safety tips:

- Do not run the engine in a closed garage or in confined areas any longer than needed to move your vehicle in or out of the area.
- If you are required to drive with the trunk/liftgate/rear doors open, make sure that all windows are closed and the climate control BLOWER switch is set at high speed. DO NOT use the recirculation mode.
- If it is necessary to sit in a parked vehicle with the engine running, adjust your heating or cooling controls to force outside air into the vehicle. Set the blower at high speed.

The best protection against carbon monoxide entry into the vehicle body is a properly maintained engine exhaust system.

Whenever a change is noticed in the sound of the exhaust system, when exhaust fumes can be detected inside the vehicle, or when the underside or rear of the vehicle is damaged, have an authorized dealer inspect the complete exhaust system and adjacent body areas for broken, damaged, deteriorated, or mispositioned parts. Open seams or loose connections could permit exhaust fumes to seep into the passenger compartment. In addition, inspect the exhaust system each time the vehicle is raised for lubrication or oil change. Replace as required.

## CARBON MONOXIDE WARNINGS

**WARNING!**

Carbon monoxide (CO) in exhaust gases is deadly. Follow the precautions provided to prevent carbon monoxide poisoning:

- Do not inhale exhaust gases. They contain carbon monoxide, a colorless and odorless gas, which can kill. Never run the engine in a closed area, such as a garage, and never sit in a parked vehicle with the engine running for an extended period. If the vehicle is stopped in an open area with the engine running for more than a short period, adjust the ventilation system to force fresh, outside air into the vehicle.
- Guard against carbon monoxide with proper maintenance. Have the exhaust system inspected every time the vehicle is raised. Have any abnormal conditions repaired promptly. Until repaired, drive with all side windows fully open.

# IN CASE OF EMERGENCY

## HAZARD WARNING FLASHERS

The Hazard Warning Flashers button is located on the switch bank just below the radio screen.

### NOTE:

Your vehicle may be equipped with an Emergency Stop Signal (ESS) ↩ page 172.



**Hazard Warning Flashers Button**

Push the button to turn on the Hazard Warning Flashers. When the button is activated, all directional turn signals will flash on and off to warn oncoming traffic of an emergency. Push the button a second time to turn off the Hazard Warning Flashers.

This is an emergency warning system and it should not be used when the vehicle is in motion. Use it only when your vehicle is disabled or signaling a safety hazard warning for other motorists.

When you must leave the vehicle to seek assistance, the Hazard Warning Flashers will continue to operate even though the ignition is placed in the OFF position.

### NOTE:

With extended use, the Hazard Warning Flashers may wear down your battery.

## SOS SYSTEM — IF EQUIPPED

### WARNING!

ALWAYS obey traffic laws and pay attention to the road. ALWAYS drive safely with your hands on the steering wheel. You have full responsibility and assume all risks related to the use of the features and applications in this vehicle. Only use the features and applications when it is safe to do so. Failure to do so may result in an accident involving serious injury or death.

If equipped, the overhead console contains an SOS button.



**SOS Button Location**

### NOTE:

- Your vehicle may be transmitting data as authorized by the subscriber ↩ page 282.
- The SOS button will only function if you are connected to an operable LTE (voice/data) or 4G (data) network, which comes as a built in function. Other services will only be operable if your Alfa Connected services is active and you are connected to an operable LTE (voice/data) or 4G (data) network.

**SOS Call**

1. Press or hold the SOS Call button on the overhead console.

**NOTE:**

In case the SOS Call button is pushed in error, there will be a 10 second delay before the SOS Call system initiates a call to an SOS operator. To cancel the SOS Call connection, push the SOS call button on the overhead console or press the cancellation button on the Device Screen. Termination of the SOS Call will turn off the green LED light on the overhead console.

2. The LED light located next to the SOS button on the overhead console will turn green once a connection to a SOS operator has been made.
3. Once a connection between the vehicle and an SOS operator is made, the SOS Call system may transmit the following important vehicle information to a SOS operator:
  - Indication that the occupant placed an SOS Call
  - The vehicle brand
  - The last known GPS coordinates of the vehicle
4. You should be able to speak with the SOS operator through the vehicle audio system to determine if additional assistance is needed.

**WARNING!**

ALWAYS obey traffic laws and pay attention to the road. ALWAYS drive safely with your hands on the steering wheel. You have full responsibility and assume all risks related to the use of the features and applications in this vehicle. Only use the features and applications when it is safe to do so. Failure to do so may result in an accident involving serious injury or death.

**NOTE:**

- Your vehicle may be transmitting data as authorized by the subscriber.
  - Once a connection is made between the vehicle's SOS Call system and the SOS operator, the SOS operator may be able to open a voice connection with the vehicle to determine if additional assistance is needed. Once the SOS operator opens a voice connection with the vehicle's SOS Call system, the operator should be able to speak with you or other vehicle occupants and hear sounds occurring in the vehicle. The vehicle's SOS Call system will attempt to remain connected with the SOS operator until the SOS operator terminates the connection.
5. The SOS operator may attempt to contact appropriate emergency responders and provide them with important vehicle information and GPS coordinates.

**WARNING!**

- If anyone in the vehicle could be in danger (e.g., fire or smoke is visible, dangerous road conditions or location), do not wait for voice contact from an Emergency Services Agent. All occupants should exit the vehicle immediately and move to a safe location.
- Never place anything on or near the vehicle's operable network and GPS antennas. You could prevent operable network and GPS signal reception, which can prevent your vehicle from placing an emergency call. An operable network and GPS signal reception is required for the SOS Call system to function properly.
- The SOS Call system is embedded into the vehicle's electrical system. Do not add aftermarket electrical equipment to the vehicle's electrical system. This may prevent your vehicle from sending a signal to initiate an emergency call. To avoid interference that can cause the SOS Call system to fail, never add aftermarket equipment (e.g., two-way mobile radio, CB radio, data recorder, etc.) to your vehicle's electrical system or modify the antennas on your vehicle. IF YOUR VEHICLE LOSES BATTERY POWER FOR ANY REASON (INCLUDING DURING OR AFTER AN ACCIDENT), THE ALFA CONNECT FEATURES, APPS AND SERVICES, AMONG OTHERS, WILL NOT OPERATE.
- Modifications to any part of the SOS Call system could cause the air bag system to fail when you need it. You could be injured if the air bag system is not there to help protect you.

**SOS Call System Limitations**

Vehicles sold in Mexico **DO NOT** have SOS Call system capabilities.

SOS or other emergency line operators in Mexico may not answer or respond to SOS system calls.

If the SOS Call system detects a malfunction, any of the following may occur at the time the malfunction is detected, and at the beginning of each ignition cycle:

- The light located next to the SOS button will continuously illuminate red.
- The Device Screen will display the following message “Vehicle Device Requires Service. Please Contact An Authorized Dealer.”
- An In-Vehicle Audio message will state “Vehicle device requires service. Please contact an authorized dealer.”

**WARNING!**

- Ignoring the overhead console light could mean you will not have SOS Call services. If the overhead console light is illuminated, have an authorized dealer service the SOS Call system immediately.
- The Occupant Restraint Control module turns on the air bag Warning Light on the instrument panel if a malfunction in any part of the system is detected. If the Air Bag Warning Light is illuminated, have an authorized dealer service the Occupant Restraint Control system immediately.

Even if the SOS Call system is fully functional, factors beyond FCA US LLC’s control may prevent or stop the SOS Call system operation. These include, but are not limited to, the following factors:

- The ignition is in the OFF position
- The vehicle’s electrical systems are not intact
- The SOS Call system software and/or hardware are damaged during a crash
- The vehicle battery loses power or becomes disconnected during a vehicle crash
- LTE (voice/data) or 4G (data) network and/or Global Positioning Satellite signals are unavailable or obstructed
- Equipment malfunction at the SOS operator facility
- Operator error by the SOS operator
- LTE (voice/data) or 4G (data) network congestion
- Weather
- Buildings, structures, geographic terrain, or tunnels

**WARNING!**

ALWAYS obey traffic laws and pay attention to the road. ALWAYS drive safely with your hands on the steering wheel. You have full responsibility and assume all risks related to the use of the features and applications in this vehicle. Only use the features and applications when it is safe to do so. Failure to do so may result in an accident involving serious injury or death.

**NOTE:**

- Your vehicle may be transmitting data as authorized by the subscriber ↪ page 282.

- Never place anything on or near the vehicle’s LTE (voice/data) or 4G (data) and GPS antennas. You could prevent LTE (voice/data) or 4G (data) and GPS signal reception, which can prevent your vehicle from placing an emergency call. An operable LTE (voice/data) or 4G (data) network connection and a GPS signal is required for the SOS Call system to function properly.
- Changes or modifications not expressly approved by the party responsible for compliance could void the user’s authority to operate the equipment.

**Automatic SOS — If Equipped**

Automatic SOS is a hands-free safety service that can immediately connect you with help in the event that your vehicle’s airbags deploy. Please refer to your provided radio supplement for complete information.

**ASSIST Call**

The vehicle is equipped with an on-board assist, which is located within the Uconnect system. The ASSIST feature is used to automatically connect you to any one of the following support centers:

- Roadside Assistance – If you get a flat tire, or need a tow, just push the ASSIST button to connect to someone who can help. Roadside Assistance will know what vehicle you’re driving and its location. Additional fees may apply for roadside assistance.
- Vehicle Customer Care – Total support for all other vehicle issues.
- Alfa Connect Customer Care - Total support for Radio, Phone and NAV issues.

For further information, refer to the vehicles radio supplement.

## JACKING AND TIRE CHANGING — IF EQUIPPED

Use this QR code to access your digital experience.



### WARNING!

- Do not attempt to change a tire on the side of the vehicle close to moving traffic. Pull far enough off the road to avoid the danger of being hit when operating the jack or changing the wheel.
- Being under a jacked-up vehicle is dangerous. The vehicle could slip off the jack and fall on you. You could be crushed. Never put any part of your body under a vehicle that is on a jack. If you need to get under a raised vehicle, take it to a service center where it can be raised on a lift.
- Never start or run the engine while the vehicle is on a jack.
- The jack is designed to be used as a tool for changing tires only. The jack should not be used to lift the vehicle for service purposes. The vehicle should be jacked on a firm level surface only. Avoid ice or slippery areas.

## PREPARATIONS FOR JACKING

1. Park the vehicle on a firm level surface as far from the edge of the roadway as possible. Avoid icy or slippery areas.

### WARNING!

Do not attempt to change a tire on the side of the vehicle close to moving traffic. Pull far enough off the road to avoid being hit when operating the jack or changing the wheel.

2. Turn on the Hazard Warning Flashers.
3. Apply the parking brake.
4. Place the gear selector into PARK (P).
5. Place the ignition in the OFF position.
6. Block both the front and rear of the wheel diagonally opposite of the jacking position. For example, if the driver's front wheel is being changed, block the passenger's rear wheel.

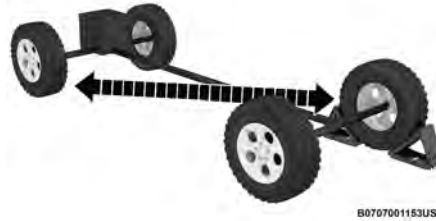

Wheel Blocked Example

### NOTE:

Passengers should not remain in the vehicle when the vehicle is being lifted or raised.

## JACK AND TOOLS LOCATION/SPARE TIRE STOWAGE — IF EQUIPPED

If equipped, the jack, tools and spare tire are located under the load floor in the rear cargo compartment.



Jack, Tools And Spare Tire Location

To access the jack, tools and spare tire proceed as follows:

1. Open the liftgate.
2. Locate and lift up on the load floor handle.



**Load Floor Handle**



**Spare Tire**

3. Remove the fastener securing the spare tire by turning it counterclockwise.



**Spare Tire Fastener**

4. Pull upward to remove the jack and tools tray to gain access to the spare tire.

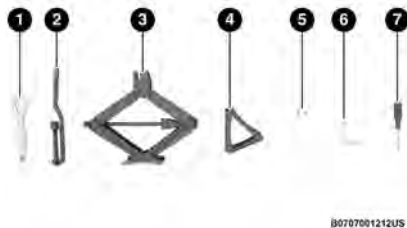

**Jack And Tools**

- 1 – Tow Eye
- 2 – Wheel Bolt Wrench
- 3 – Jack
- 4 – Wheel Chock
- 5 – Fuel Funnel
- 6 – Unlocking Tool (If Equipped)
- 7 – Screwdriver (If Equipped)

## JACKING INSTRUCTIONS

### WARNING!

Carefully follow these tire changing warnings to help prevent personal injury or damage to your vehicle:

- Always park on a firm, level surface as far from the edge of the roadway as possible before raising the vehicle.
- Turn on the Hazard Warning Flashers.
- Apply the parking brake firmly and set the transmission in PARK.
- Block the wheel diagonally opposite the wheel to be raised.
- Never start or run the engine with the vehicle on a jack.
- Do not let anyone sit in the vehicle when it is on a jack.
- Do not get under the vehicle when it is on a jack. If you need to get under a raised vehicle, take it to a service center where it can be raised on a lift.
- Only use the jack in the positions indicated and for lifting this vehicle during a tire change.
- If working on or near a roadway, be extremely careful of motor traffic.
- To ensure that spare tires, flat or inflated, are securely stowed, spares must be stowed with the valve stem facing the ground.





090600714

### Jack Warning Label

1. Remove the jack, wheel bolt wrench and spare tire.
2. Before raising the vehicle, use the wheel bolt wrench to loosen, but not remove, the wheel bolts on the wheel with the flat tire. Turn the wheel bolts counterclockwise one turn while the wheel is still on the ground.



### Loosening The Wheel Bolts

### NOTE:

Placement for the front and rear jack locations are critical. See the following images for proper jacking locations.



B0707001199US

### Jacking Locations

### CAUTION!

Do not attempt to raise the vehicle by jacking on locations other than those indicated in the Jacking Instructions for this vehicle.

3. Jack lifting points can be identified by an opening under an access panel that exposes the steel lifting flange. Before positioning the jack, remove the access panel with the provided screwdriver or similar tool. Place the jack underneath the lifting area that is closest to the flat tire. Turn the jack screw clockwise to securely engage the jack saddle to the lifting area of the sill flange, centering the jack saddle within the notch of the sill trim.

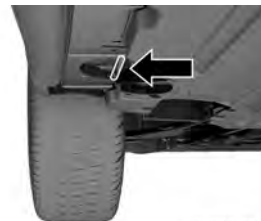

B0707001201US

### Front Lifting Point



B0707001203US

### Front Jacking Location

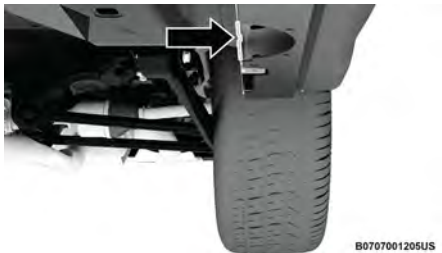

Rear Lifting Point

B0707001206US



Rear Jacking Location

B0707001206US

4. Raise the vehicle just enough to remove the flat tire.

**WARNING!**

Raising the vehicle higher than necessary can make the vehicle less stable. It could slip off the jack and hurt someone near it. Raise the vehicle only enough to remove the tire.

5. Remove the wheel bolts and tire.
6. Mount the spare tire.

**CAUTION!**

Be sure to mount the spare tire with the valve stem facing outward. The vehicle could be damaged if the spare tire is mounted incorrectly.



Mounting Spare Tire

B0707001216US

**NOTE:**

- For vehicles equipped, do not attempt to install a center cap or wheel cover on the compact spare.
- For additional warnings, cautions, and information about the spare tire, its use, and operation → page 257.

7. Install and lightly tighten the wheel bolts.

**WARNING!**

To avoid the risk of forcing the vehicle off the jack, do not tighten the wheel nuts fully until the vehicle has been lowered. Failure to follow this warning may result in serious injury.

8. Lower the vehicle to the ground by turning the jack handle counterclockwise.
9. Finish tightening the wheel bolts. Push down on the wrench while at the end of the handle for increased leverage. Tighten the wheel bolts in a star pattern until each wheel bolt has been tightened twice → page 273. If in doubt about the correct tightness, have them checked with a torque wrench by an authorized dealer or at a service station.
10. Lower the jack until it is free. Remove the wheel blocks. Stow the wheel bolt wrench, jack assembly and wheel blocks in the provided storage. Secure the assembly using the means provided. Release the parking brake before driving the vehicle.

**Damaged Tire Storage**

11. After 25 miles (40 km), check the wheel bolt torque with a torque wrench to ensure that all wheel bolts are properly seated against the wheel.

**WARNING!**

A loose tire or jack thrown forward in a collision or hard stop could endanger the occupants of the vehicle. Always stow the jack parts and the spare tire in the places provided. Have the deflated (flat) tire repaired or replaced immediately.

**TIRE INFLATOR KIT — IF EQUIPPED**

Use this QR code to access your digital experience.

**DESCRIPTION**

If a tire is punctured, you can make an emergency repair using the Tire Inflator Kit located beneath the load floor in the rear cargo area.

**Tire Inflator Kit Storage**

The Tire Inflator Kit includes:

- Power Cord.
- Sealant cartridge containing the sealing fluid.
- Filler tube.
- Adhesive label with the writing "Max. 50 mph (80 km/h)", to be attached in a position easily visible to the driver (e.g. on the dashboard) after repairing the tire.
- Air compressor, complete with pressure gauge and connectors.
- A pair of protective gloves (if equipped).
- Adapters for inflating different elements.

**Tire Inflator Kit Components**

- 1 — Adhesive Label  
2 — Sealant Cartridge  
3 — Filler Tube  
4 — Power Cord  
5 — Air Compressor

**INFLATION PROCEDURE****WARNING!**

- The information required by current legislation is shown on the kit cartridge label. Read the cartridge label before use, avoid improper use.
- Do not attempt to seal a tire on the side of the vehicle closest to traffic. Pull far enough off the road to avoid the danger of being hit when using the Tire Service Kit.
- Do not remove foreign bodies from the tire.
- Do not leave the compressor running for more than 20 minutes, this may cause overheating.

(Continued)

**WARNING!**

- Do not use the Tire Service Kit or drive the vehicle under the following circumstances:
  - If the puncture in the tire tread is approximately 1/4 inch (6 mm) or larger.
  - If the tire has any sidewall damage.
  - If the tire has any damage from driving with extremely low tire pressure.
  - If the tire has any damage from driving on a flat tire.
  - If the wheel has any damage.
  - If you are unsure of the condition of the tire or the wheel.
- Keep the Tire Service Kit away from open flames or heat sources.
- A loose Tire Service Kit thrown forward in a collision or hard stop could endanger the occupants of the vehicle. Always stow the Tire Service Kit in the place provided. Failure to follow these warnings can result in injuries that are serious or fatal to you, your passengers, and others around you.
- Take care not to allow the contents of the Tire Service Kit to come in contact with hair, eyes, or clothing. Tire Service Kit sealant is harmful if inhaled, swallowed, or absorbed through the skin. It causes skin, eye, and respiratory irritation. Flush immediately with plenty of water if there is any contact with eyes or skin. Change clothing as soon as possible, if there is any contact with clothing.
- Tire Service Kit sealant solution contains latex. In case of an allergic reaction or rash, consult a physician immediately. Keep the Tire Service Kit out of reach of children. If swallowed, rinse mouth immediately with plenty of water and drink plenty of water. Do not induce vomiting! Consult a physician immediately.

**NOTE:**

Always follow applicable state and provincial laws. Contact state and provincial Highway Safety offices for additional details.

To use your Tire Inflator Kit, proceed as follows:

1. Stop the vehicle in a position where you can repair the tire safely. Activate the Hazard Warning Flashers to make other drivers aware of your presence.
2. If equipped, use all available safety equipment required by law.
3. Verify that the valve stem (on the wheel with the deflated tire) is in a position that is near to the ground. This will allow the Tire Inflator Kit hoses to reach the valve stem and keep the tire repair kit flat on the ground.
4. Place the gear selector to PARK (P).
5. Apply the Electric Park Brake and cycle the engine OFF.
6. Insert the sealant cartridge containing the sealing fluid in the proper compressor holder, pushing down hard. Unscrew the tire valve cap, take out the filler tube and tighten the fitting on the tire valve.

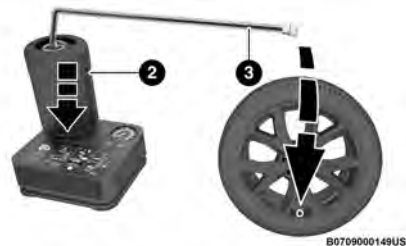

**Attaching Filler Tube To Deflated Tire**

- 2 — Sealant Cartridge  
3 — Filler Tube

7. Make sure the compressor is switched off.
8. Insert the plug into the vehicle's center console power outlet, then start the engine.



**Power Outlet Location**

9. Switch the compressor on.

10. Inflate the tire to the pressure indicated on the tire placard, located on the driver's side B-pillar or the rear edge of the driver's side door → page 260. In order to obtain a more precise reading, check the pressure value on pressure gauge with the compressor off.

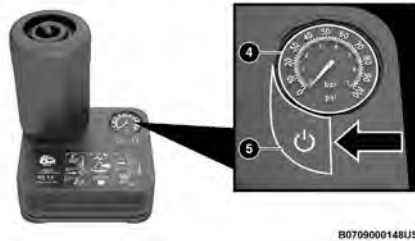

Air Compressor

- 4 – Pressure Gauge  
5 – Power Switch

11. If the pressure is not at least 26.1 psi (1.8 bar) after 15 minutes, disengage the compressor from the valve and power outlet. Then, move the vehicle forwards approximately 33 ft (10 m) in order to distribute the sealant inside the tire evenly, and then repeat the inflation operation.
12. If you still cannot obtain a pressure of at least 26 psi (1.8 bar) within 15 minutes of turning the compressor on, do not drive the vehicle, and contact an authorized dealer.
13. Drive the vehicle for about 5 miles (8 km), stop, apply the Electric Park Brake, and recheck the tire pressure.
14. If the pressure is less than 26 psi (1.8 bar), **DO NOT** drive the vehicle, and see an authorized dealer.
15. If a pressure value of at least 26 psi (1.8 bar) is detected, restore the correct pressure (with engine running and Electric Park Brake applied), and drive immediately with great care to an authorized dealer.

**WARNING!**

The Tire Service Kit is not a permanent flat tire repair. Have the tire inspected and repaired or replaced after using the Tire Service Kit. Do not exceed 50 mph (80 km/h) until the tire is repaired or replaced. Failure to follow this warning can result in injuries that are serious or fatal to you, your passengers, and others around you. Have the tire checked as soon as possible at an authorized dealer.

16. Apply the adhesive label from the sealant bottle where it can be easily seen by the driver as a reminder that the tire has been treated with a Tire Inflator Kit, as well as not to exceed the speed restriction for the treated tire.

**WARNING!**

Do not adhere the speed restriction sticker to the padded area on the steering wheel. Adhering the speed restriction sticker to the padded area on the steering wheel is dangerous because the air bag may not operate (deploy) normally resulting in serious injury. In addition, do not adhere the sticker to areas where warning lights or the speedometer cannot be viewed.

## CHECKING AND RESTORING TIRE PRESSURE

The compressor can also be used to check and, if necessary, restore the tire pressure.

Proceed as follows:

1. Plug the power cord in the vehicle's power outlet.
2. Release the quick connector and connect it directly to the valve of the tire to be inflated.
3. Push the air release button.

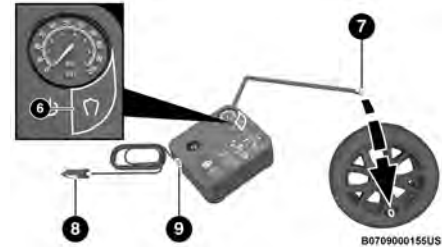

Air Compressor Components

- 6 – Air Release Button  
7 – Quick Connector  
8 – Power Cord  
9 – Release Button

## SEALANT CARTRIDGE REPLACEMENT

The sealant liquid is subject to expiration and must be replaced periodically.

- Use only original cartridges, which can be purchased at an authorized dealer.
- Show the cartridge and label to the staff who will have to handle the tire treated with the kit.
- The sealant is effective with external temperatures of between -40 °F (-40 °C) and 122 °F (50 °C). The sealant has an expiration date.

To replace the sealant cartridge, proceed as follows:

1. Remove the sealant cartridge by pushing the release button located on the side of the compressor.
2. Insert the new sealant cartridge by pushing downward firmly.



B0709000150US

**Sealant Cartridge Replacement**

- 2 — Sealant Cartridge  
9 — Release Button

## JUMP STARTING — GAS MODELS

If your vehicle has a discharged battery, it can be jump started using a set of jumper cables and a battery in another vehicle or by using a portable battery booster pack. Jump starting can be dangerous if done improperly, so please follow the procedures in this section carefully.

### NOTE:

When using a portable battery booster pack, follow the manufacturer's operating instructions and precautions.

### NOTE:

A battery replacement or disruption of power may cause loss of Steering Angle Calibration and an error message to occur ⇨ page 84. Performing a Lock-to-Lock Steering Angle Calibration may correct this condition.

### WARNING!

Do not attempt jump starting if the battery is frozen. It could rupture or explode and cause personal injury.

### CAUTION!

Do not use a portable battery booster pack or any other booster source with a system voltage greater than 12 Volts or damage to the battery, starter motor, alternator or electrical system may occur.

## PREPARATIONS FOR JUMP START — GAS MODELS

The battery in your vehicle is located in the rear of the engine compartment, behind the left headlight assembly.



B0710000203US

**Positive (+) Battery Post**

See the following steps to prepare for jump starting:

1. Apply the parking brake, shift the automatic transmission into PARK (P) and turn the ignition to OFF.
2. Turn off the heater, radio, and all electrical accessories.
3. Pull upward and remove the protective cover over the positive (+) battery post.
4. If using another vehicle to jump start the battery, park the vehicle within the jumper cables reach, set the parking brake and make sure the ignition is OFF.

**WARNING!**

- Do not allow vehicles to touch each other as this could establish a ground connection and personal injury could result.
- Take care to avoid the radiator cooling fan whenever the hood is raised. It can start anytime the ignition switch is ON. You can be injured by moving fan blades.
- Remove any metal jewelry such as rings, watch bands and bracelets that could make an inadvertent electrical contact. You could be seriously injured.
- Batteries contain sulfuric acid that can burn your skin or eyes and generate hydrogen gas which is flammable and explosive. Keep open flames or sparks away from the battery.

## JUMP STARTING PROCEDURE — GAS MODELS

**WARNING!**

Failure to follow this jump starting procedure could result in personal injury or property damage due to battery explosion.

**CAUTION!**

Failure to follow these procedures could result in damage to the charging system of the booster vehicle or the discharged vehicle.

**Connecting The Jumper Cables**

1. Connect the positive (+) end of the jumper cable to the positive (+) post of the discharged vehicle.
2. Connect the opposite end of the positive (+) jumper cable to the positive (+) post of the booster battery.
3. Connect the negative (-) end of the jumper cable to the negative (-) post of the booster battery.
4. Connect the opposite end of the negative (-) jumper cable to a good engine ground. A "ground" is an exposed metallic/unpainted part of the engine, frame or chassis, such as an accessory bracket or large bolt. The ground must be away from the battery and the fuel injection system.

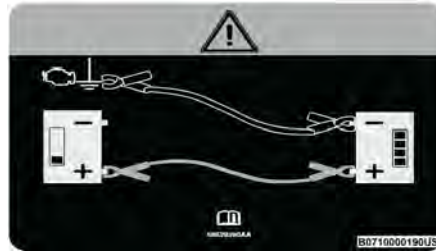

**Jump Starting Procedure**

**WARNING!**

Do not connect the jumper cable to the negative (-) post of the discharged battery. The resulting electrical spark could cause the battery to explode and could result in personal injury.

5. Start the engine in the vehicle that has the booster battery, let the engine idle for a few minutes, and then start the engine in the vehicle with the discharged battery.
6. Once the engine is started, follow the disconnecting procedure.

**Disconnecting The Jumper Cables**

1. Disconnect the negative (-) end of the jumper cable from the engine ground of the vehicle with the discharged battery.
2. Disconnect the opposite end of the negative (-) jumper cable from the negative (-) post of the booster battery.
3. Disconnect the positive (+) end of the jumper cable from the positive (+) post of the booster battery.
4. Disconnect the opposite end of the positive (+) jumper cable from the positive (+) post of the vehicle with the discharged battery, and reinstall the protective cover.

If frequent jump starting is required to start your vehicle, you should have the battery and charging system inspected at an authorized dealer.

**For the Plug-in Hybrid version:** If both the traditional battery and the high-voltage battery are flat, charge the traditional battery first, in order to start the system and allow the heat engine to start in order to move the car. We suggest then, to also charge the high-voltage battery.

**CAUTION!**

Accessories plugged into the vehicle power outlets draw power from the vehicle's battery, even when not in use (i.e., cellular devices, etc.). Eventually, if plugged in long enough without engine operation, the vehicle's battery will discharge sufficiently to degrade battery life and/or prevent the engine from starting.

**JUMP STARTING — HYBRID MODELS**

If your vehicle has a discharged battery, it can be jump started using a set of jumper cables and a battery in another vehicle or by using a portable battery booster pack. Jump starting can be dangerous if done improperly, so please follow the procedures in this section carefully.

**NOTE:**

When using a portable battery booster pack, follow the manufacturer's operating instructions and precautions. The vehicle requires its 12 Volt battery power to turn-on the vehicle's high voltage battery. The high voltage battery is used to charge the 12 Volt battery, provide electric vehicle operation, and to start the vehicle's gas engine. If the 12 Volt battery has been discharged, the vehicle can be jump started using a set of jumper cables and a battery in another vehicle or by using a portable battery booster pack.

If the vehicle's high voltage battery has also been discharged, it will need to be recharged to a minimum operating State Of Charge (SOC) before the vehicle can be started:

- If the vehicle can be connected to a Level 1 or Level 2 charger where it is currently parked, the vehicle will still require a jump start to allow the vehicle to begin the battery charging process. Once the vehicle charging has begun (indicated by the charge status indicator on top of the vehicle's instrument panel), the jumper cables can be removed from the vehicle jump posts.
- If the vehicle cannot be connected to a Level 1 or Level 2 charger where it is currently parked, the vehicle can be moved by connecting 12 Volt power to the vehicle's jump posts and then shifting the transmission from PARK (P) into NEUTRAL (N). Power provided by the jumper cables will also allow the Electric Park Brake to be released. Carefully move the vehicle to a Level 1 or Level 2 charge location. While the vehicle is being moved, the external 12 Volt power must remain connected to the vehicle jump posts.

**NOTE:**

Be careful when moving the vehicle - ensure that control of the vehicle is maintained. Also, ensure that vehicle is secured to prevent unintentional movement during and after moving the vehicle. If the external 12 Volt power becomes disconnected from the vehicle jump posts or there is an interruption of the 12 Volt power while moving the vehicle, the vehicle's transmission may engage PARK. Do not allow the jumper cables to come in contact with each other or to the vehicle, this will result in a short.

When the vehicle is at the charging location, shift the transmission back to PARK, apply the Electric Park Brake, and start the high voltage battery charging. Once the vehicle has been secured against unintentional movement and high voltage battery charging has been initiated, the jumper cables can be removed from the vehicle jump posts.

**NOTE:**

A battery replacement or disruption of power may cause loss of Steering Angle Calibration and an error message to occur → page 84. Performing a Lock-to-Lock Steering Angle Calibration may correct this condition.

**WARNING!**

Do not attempt jump starting if the battery is frozen. It could rupture or explode and cause personal injury.

**CAUTION!**

Do not use a portable battery booster pack or any other booster source with a system voltage greater than 12 Volts or damage to the battery, starter motor, alternator or electrical system may occur.



## PREPARATIONS FOR JUMP START — HYBRID MODELS

The battery in your vehicle is located in the rear of the engine compartment, behind the left headlight assembly.



**Positive (+) Battery Post**

See the following steps to prepare for jump starting:

1. Apply the parking brake, shift the automatic transmission into PARK (P) and turn the ignition to OFF.
2. Turn off the heater, radio, and all electrical accessories.
3. Pull upward and remove the protective cover over the positive (+) battery post.
4. If using another vehicle to jump start the battery, park the vehicle within the jumper cables reach, set the parking brake and make sure the ignition is OFF.

### WARNING!

- Do not allow vehicles to touch each other as this could establish a ground connection and personal injury could result.
- Take care to avoid the radiator cooling fan whenever the hood is raised. It can start anytime the ignition switch is ON. You can be injured by moving fan blades.
- Remove any metal jewelry such as rings, watch bands and bracelets that could make an inadvertent electrical contact. You could be seriously injured.
- Batteries contain sulfuric acid that can burn your skin or eyes and generate hydrogen gas which is flammable and explosive. Keep open flames or sparks away from the battery.

## JUMP STARTING PROCEDURE — HYBRID MODELS

### WARNING!

Failure to follow this jump starting procedure could result in personal injury or property damage due to battery explosion.

### CAUTION!

Failure to follow these procedures could result in damage to the charging system of the booster vehicle or the discharged vehicle.

### Connecting The Jumper Cables

1. Connect the positive (+) end of the jumper cable to the positive (+) post of the discharged vehicle.
2. Connect the opposite end of the positive (+) jumper cable to the positive (+) post of the booster battery.
3. Connect the negative (-) end of the jumper cable to the negative (-) post of the booster battery.
4. Connect the opposite end of the negative (-) jumper cable to a good engine ground. A "ground" is an exposed metallic/unpainted part of the engine, frame or chassis, such as an accessory bracket or large bolt. The ground must be away from the battery and the fuel injection system.

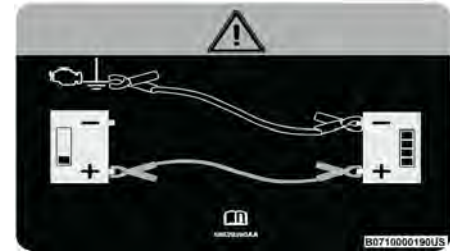

**Jump Starting Procedure**

### WARNING!

Do not connect the jumper cable to the negative (-) post of the discharged battery. The resulting electrical spark could cause the battery to explode and could result in personal injury.

- Start the engine in the vehicle that has the booster battery, let the engine idle for a few minutes, and then cycle the ignition to ON/RUN in the vehicle with the discharged battery.
- After a couple minutes (depending on the level of 12 Volt battery discharge), attempt to start the vehicle. Once the engine is started, follow the disconnecting procedure.

#### Disconnecting The Jumper Cables

- Disconnect the negative (-) end of the jumper cable from the engine ground of the vehicle with the discharged battery.
- Disconnect the opposite end of the negative (-) jumper cable from the negative (-) post of the booster battery.
- Disconnect the positive (+) end of the jumper cable from the positive (+) post of the booster battery.
- Disconnect the opposite end of the positive (+) jumper cable from the positive (+) post of the vehicle with the discharged battery, and reinstall the protective cover.

If frequent jump starting is required to start your vehicle, you should have the battery and charging system inspected at an authorized dealer.

**For the Plug-in Hybrid version:** If both the traditional battery and the high-voltage battery are flat, charge the traditional battery first, in order to start the system and allow the heat engine to start in order to move the car. We suggest then, to also charge the high-voltage battery.

#### CAUTION!

Accessories plugged into the vehicle power outlets draw power from the vehicle's battery, even when not in use (i.e., cellular devices, etc.). Eventually, if plugged in long enough without engine operation, the vehicle's battery will discharge sufficiently to degrade battery life and/or prevent the engine from starting.

## REFUELING IN EMERGENCY

The vehicle is equipped with a refueling funnel for a capless fuel system. The refueling funnel is located under the load floor in the rear cargo area. If refueling is necessary, while using an approved gas can, insert the refueling funnel into the filler neck opening. Take care to open both flapper doors with the funnel to avoid spills.

#### NOTE:

In certain cold conditions, ice may prevent the fuel door from opening. If this occurs, lightly push on the outside center of the fuel door to break the ice buildup. Do not pry on the door.

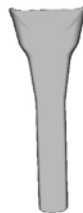

B0711000049US

Fuel Funnel

#### Emergency Gas Can Refueling

Most gas cans will not open the flapper doors. A funnel is provided to allow emergency refueling with a gas can. See the following steps for refueling:

- Retrieve funnel from the spare tire storage area.
- Insert funnel into same filler pipe opening as the fuel nozzle.



B0711000050US

Inserting Funnel

3. Ensure funnel is inserted fully to hold flapper doors open.
4. Pour fuel into funnel opening.

**CAUTION!**

To avoid fuel spillage and overfilling, do not “top off” the fuel tank after filling.

5. Remove funnel from filler pipe, clean off prior to putting back in the spare tire storage area.

**WARNING!**

- Never have any smoking materials lit in or near the vehicle when the fuel door is open or the tank is being filled.
- Never add fuel when the engine is running. This is in violation of most state and federal fire regulations and may cause the Malfunction Indicator Light to turn on.
- A fire may result if fuel is pumped into a portable container that is inside of a vehicle. You could be burned. Always place fuel containers on the ground while filling.

**IF YOUR ENGINE OVERHEATS**

If the vehicle is overheating, it will need to be serviced by an authorized dealer.

Potential signs of vehicle overheating:

- Temperature gauge is at HOT (H)
- Strong smell of coolant
- White smoke coming from engine or exhaust
- Coolant bottle coolant has bubbles present

**WARNING!**

You or others can be badly burned by hot engine coolant (antifreeze) or steam from your radiator. If you see or hear steam coming from under the hood, do not open the hood until the radiator has had time to cool. Never try to open a cooling system pressure cap when the radiator or coolant bottle is hot.

If the temperature gauge is moving towards or close to the HOT (H) position, you can reduce the potential for overheating by taking the appropriate action.

- On highways — slow down.
- In city traffic — while stopped, place the transmission in NEUTRAL (N), but do not increase the engine idle speed while preventing vehicle motion with the brakes.
- If your Air Conditioner (A/C) is on, turn it off. The A/C system adds heat to the engine cooling system and turning the A/C off can help remove this heat.

- You can also turn the temperature control to maximum heat, the mode control to floor and the blower control to high. This allows the heater core to act as a supplement to the radiator and aids in removing heat from the engine cooling system.

**CAUTION!**

Driving with a hot cooling system could damage your vehicle. If the temperature gauge reads “H,” pull over and stop the vehicle. Idle the vehicle with the air conditioner turned off until the pointer drops back into the normal range. If the pointer remains on the “H” and you hear continuous chimes, turn the engine off immediately and call for service.

**GEAR SELECTOR OVERRIDE**

If a malfunction occurs, and the gear selector cannot be moved out of the PARK position, you can use the following procedure to temporarily move the gear selector:

1. First turn the engine OFF.
2. Apply the parking brake.
3. Grab the boot material of the gear selector and pull up to carefully separate the gear selector bezel and boot assembly from the center console.



Gear Selector Bezel

4. Press and maintain firm pressure on the brake pedal.
5. Locate the gear selector override access (at the right rear corner of the gear selector assembly). Using a small screwdriver or similar tool, push and hold the override release lever down.



Gear Selector Override Access Location

6. Move the gear selector to the NEUTRAL (N) position.
7. The vehicle may then be started in NEUTRAL.
8. Reinstall the gear selector boot.

## FREING A STUCK VEHICLE

If your vehicle becomes stuck in mud, sand or snow, it can often be moved using a rocking motion. Turn the steering wheel right and left to clear the area around the front wheels. Push and hold the button on the gear selector. Then shift back and forth between DRIVE (D) and REVERSE (R) while gently pressing the accelerator.

### NOTE:

Shifts between DRIVE (D) and REVERSE (R) can only be achieved at wheel speeds of 5 mph (8 km/h) or less. Whenever the transmission remains in NEUTRAL (N) for more than two seconds, you must press the brake pedal to engage DRIVE (D) or REVERSE (R).

Use the least amount of accelerator pedal pressure that will maintain the rocking motion without spinning the wheels or racing the engine.

### WARNING!

Fast spinning tires can be dangerous. Forces generated by excessive wheel speeds may cause damage, or even failure, of the axle and tires. A tire could explode and injure someone. Do not spin your vehicle's wheels faster than 30 mph (48 km/h) or for longer than 30 seconds continuously without stopping when you are stuck and do not let anyone near a spinning wheel, no matter what the speed.

### NOTE:

Using the DNA selector, rotate to the OFF position to place the system in "Full Off" mode, before rocking the vehicle ↩ page 171. Once the vehicle has been freed, deactivate the "Full Off" mode by rotating the DNA selector back to the OFF position.

### CAUTION!

- Racing the engine or spinning the wheels may lead to transmission overheating and failure. Allow the engine to idle with the transmission in NEUTRAL for at least one minute after every five rocking-motion cycles. This will minimize overheating and reduce the risk of clutch or transmission failure during prolonged efforts to free a stuck vehicle.
- When "rocking" a stuck vehicle by shifting between DRIVE gear and REVERSE, do not spin the wheels faster than 15 mph (24 km/h), or drivetrain damage may result.
- Revving the engine or spinning the wheels too fast may lead to transmission overheating and failure. It can also damage the tires. Do not spin the wheels above 30 mph (48 km/h) while in gear (no transmission shifting occurring).

## TOWING A DISABLED VEHICLE

This section describes procedures for towing a disabled vehicle using a commercial towing service.

TOWING CONDITION	WHEELS OFF THE GROUND	ALL-WHEEL DRIVE (AWD)
Flat Tow	NONE	NOT ALLOWED
Dolly Tow	REAR	NOT ALLOWED
	FRONT	NOT ALLOWED
On Trailer	ALL	BEST METHOD
When towing your vehicle, always follow applicable state and provincial laws. Contact state and provincial Highway Safety offices for additional details.		

Proper towing or lifting equipment is required to prevent damage to your vehicle. Use only tow bars and other equipment designed for this purpose, following equipment manufacturer's instructions. Use of safety chains is mandatory. Attach a tow bar or other towing devices to main structural members of the vehicle, not to fascia/bumper or associated brackets. State and local laws regarding vehicles under tow must be observed.

### NOTE:

- You must ensure that the Auto Park Brake feature is disabled before towing this vehicle to avoid inadvertent Electric Park Brake engagement. The Auto Park Brake feature is enabled or disabled via the customer programmable features in the Uconnect Settings.
- Vehicles with a discharged battery, or total electrical failure when the Electric Park Brake (EPB) is engaged, will need a wheel dolly or jack to raise the rear wheels off the ground when moving the vehicle onto a flatbed.

If you must use the accessories (wipers, defrosters, etc.) while being towed, the ignition must be in the ON/RUN mode.

Note that the Safehold feature will engage the Electric Park Brake whenever the driver's door is opened (if the battery is connected, ignition is ON, transmission is not in PARK, and brake pedal is released). If you are towing this vehicle with the ignition in the ON/RUN mode, you must manually disable the Electric Park Brake each time the driver's door is opened by pressing the brake pedal and then releasing the EPB.

If the vehicle's battery is discharged, instructions on shifting the automatic transmission out of PARK so that the vehicle can be moved → page 225.

### CAUTION!

- Do not use sling-type equipment when towing. Vehicle damage may occur.
- When securing the vehicle to a flatbed truck, do not attach to front or rear suspension components. Damage to your vehicle may result from improper towing.
- Ensure that the Electric Park Brake is released, and remains released, while being towed.
- Do not use a fascia/bumper mounted clamp-on tow bar on your vehicle. The fascia/bumper face bar will be damaged.

## WITHOUT THE KEY FOB

Special care must be taken when the vehicle is towed with the ignition in the OFF mode. The only approved method of towing without the key fob is with a flatbed truck. Proper towing equipment is necessary to prevent damage to the vehicle.

## ALL-WHEEL DRIVE (AWD) MODELS

FCA US LLC recommends towing your vehicle with all four wheels **OFF** the ground using a flatbed.

### CAUTION!

- Towing this vehicle using any other method can cause severe transmission and/or transfer case damage.
- Damage from improper towing is not covered under the New Vehicle Limited Warranty.

## TOW EYE — IF EQUIPPED

Your vehicle may be equipped with tow eyes that can be used to move a disabled vehicle. When using tow eyes, see the following precautions.



B0717000141US

Tow Eye

### Tow Eye Usage Precautions

#### CAUTION!

- The tow eye must only be used for roadside emergencies. Use with an appropriate device in accordance with highway code (a rigid bar or rope) to maneuver the vehicle in preparation for transport via a tow truck.
- The tow eye must not be used to move the vehicle off the road or where there are obstacles.
- Do not use the tow eyes for tow truck hookup or highway towing.
- Do not use the tow eye to free a stuck vehicle  
➔ page 226.
- Damage to your vehicle may occur if these guidelines are not followed.



0614050352

Tow Eye Warning Label

#### WARNING!

Stand clear of vehicles when pulling with tow eyes.

- Do not use a chain with a tow eye. Chains may break, causing serious injury or death.
- Do not use a tow strap with a tow eye. Tow straps may break or become disengaged, causing serious injury or death.
- Failure to follow proper tow eye usage may cause components to break resulting in serious injury or death.

## Tow Eye Installation

The rear tow eye receptacle is located behind an access door on the passenger's side of the rear fascia/bumper.

To install the tow eye, open the access door using a small screwdriver or similar tool. Thread the tow eye into the receptacle, making sure it is fully tightened.

The tow eye must be securely seated to the attaching bracket through the rear fascia/bumper. If the tow eye is not securely seated to the attaching bracket, the vehicle should not be moved.



Rear Tow Eye Access Door



Rear Tow Eye Installed

## ENHANCED ACCIDENT RESPONSE SYSTEM (EARS)

This vehicle is equipped with an Enhanced Accident Response System.

This feature is a communication network that takes effect in the event of an impact.

## EVENT DATA RECORDER (EDR)

This vehicle is equipped with an event data recorder (EDR). The main purpose of an EDR is to record data that will assist in understanding how a vehicle's systems performed under certain crash or near crash-like situations, such as an air bag deployment or hitting a road obstacle → page 199.

# SERVICING AND MAINTENANCE

## SCHEDULED SERVICING

Your vehicle is equipped with an automatic oil change indicator system. The oil change indicator system will remind you that it is time to take your vehicle in for scheduled maintenance.

Based on engine operation conditions, the oil change indicator message will illuminate in the instrument cluster. This means that service is required for your vehicle. Operating conditions such as frequent short-trips, trailer towing, and extremely hot or cold ambient temperatures will influence when the “Change Oil” or “Oil Change Required” message is displayed. Have your vehicle serviced as soon as possible, within the next 500 miles (805 km).

## MAINTENANCE PLAN

Refer to the Maintenance Plan for the required maintenance intervals.

<b>At Every Oil Change Interval As Indicated By Oil Change Indicator System</b>
Change oil and filter.
Rotate the tires at the first sign of irregular wear, even if it occurs before the oil indicator system turns on.
Inspect battery and clean and tighten terminals as required.
Inspect the CV/Universal joints.
Inspect brake pads, shoes, rotors, drums, and hoses.
Inspect engine cooling system protection and hoses.
Inspect exhaust system.
Inspect engine air cleaner filter if using in dusty or off-road conditions, replace the engine air cleaner filter if necessary.

### NOTE:

Using white lithium grease, lubricate the door hinge roller pivot joints twice a year to prevent premature wear.

An authorized dealer will reset the oil change indicator message after completing the scheduled oil change. If a scheduled oil change is performed by someone other than an authorized dealer, the message can be reset by referring to the steps described under Instrument Cluster Display → page 80.

### NOTE:

Under no circumstances should oil change intervals exceed 10,000 miles (16,000 km), one year or 350 hours of engine run time, whichever comes first. The 350 hours of engine run or idle time is generally only a concern for fleet customers.

### Once A Month Or Before A Long Trip:

- Check engine oil level.
- Check windshield washer fluid level.
- Check the tire inflation pressures and look for unusual wear or damage. Rotate tires at the first sign of irregular wear, even if it occurs before the oil indicator system turns on.
- Check the fluid levels of the coolant reservoir, and brake master cylinder reservoir, and fill as needed.
- Check function of all interior and exterior lights.



Mileage Or Time Passed (Whichever Comes First)	20,000	30,000	40,000	50,000	60,000	70,000	80,000	90,000	100,000	110,000	120,000	130,000	140,000	150,000
	Or Years:	2	3	4	5	6	7	8	9	10	11	12	13	14
Or Kilometers:	32,000	48,000	64,000	80,000	96,000	112,000	128,000	144,000	160,000	176,000	192,000	208,000	224,000	240,000
Inspect the brake linings, replace if necessary.	X		X		X		X		X		X		X	
Inspect the front suspension, tie rod ends and boot seals, replace if necessary.	X		X		X		X		X		X		X	
Inspect the CV/Universal joints.	X	X	X	X	X	X	X	X	X	X	X	X	X	X
Inspect the PTU fluid level.			X				X				X			
Inspect the rear differential fluid level.			X				X				X			
Inspect front accessory drive belt, tensioner, idler pulley, and replace if necessary.														X
Replace engine air cleaner filter.		X			X			X			X			X
Replace brake fluid every two years, regardless of mileage.	X		X		X		X		X		X		X	
Replace the cabin air filter.	To be replaced every 12,000 miles (19,000 km).													
Replace spark plugs – 2.0L.*					X						X			
Replace spark plugs – 1.3L.*			X				X				X			
Flush and replace the engine, power electronics, and battery coolant at 10 years or 150,000 miles (240,000 km) whichever comes first.									X					X
Inspect and replace PCV valve if necessary.													X	

\* The spark plug change interval is mileage based only; yearly intervals do not apply.

### WARNING!

- You can be badly injured working on or around a motor vehicle. Do only service work for which you have the knowledge and the right equipment. If you have any doubt about your ability to perform a service job, take your vehicle to a competent mechanic.
- Failure to properly inspect and maintain your vehicle could result in a component malfunction and affect vehicle handling and performance. This could cause an accident.

## ENGINE COMPARTMENT

### 1.3L PHEV ENGINE

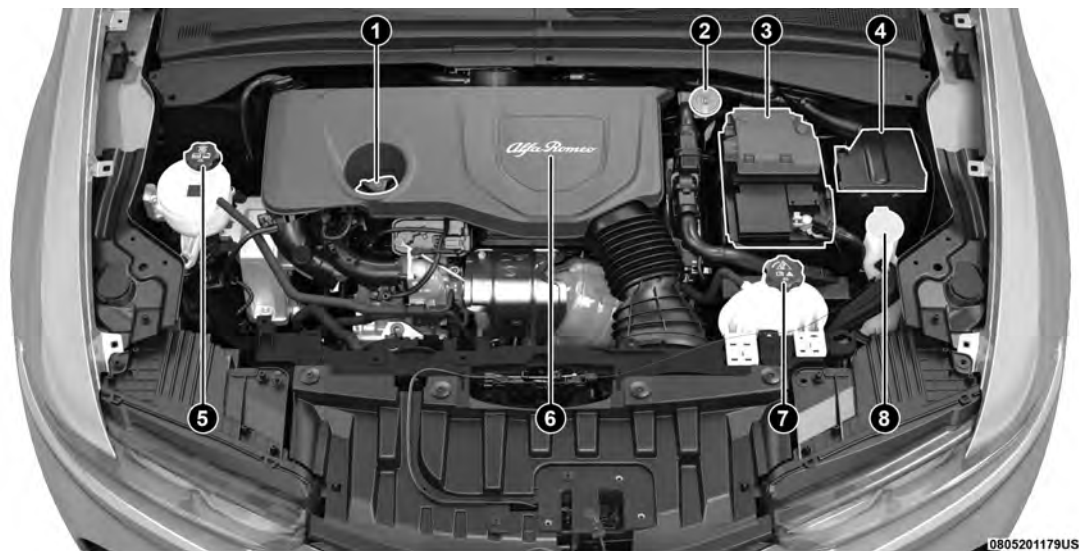

- 1 – Oil Fill Cap/Engine Oil Dipstick
- 2 – Brake Fluid Reservoir Cap
- 3 – Battery
- 4 – Power Distribution Center (Fuses)

- 5 – Battery/Power Electronics Coolant Reservoir Cap
  - 6 – Engine Air Cleaner Filter (Located Under Engine Cover)
  - 7 – Coolant Pressure Bottle Cap
  - 8 – Washer Fluid Reservoir Cap
-

## 2.0L ENGINE

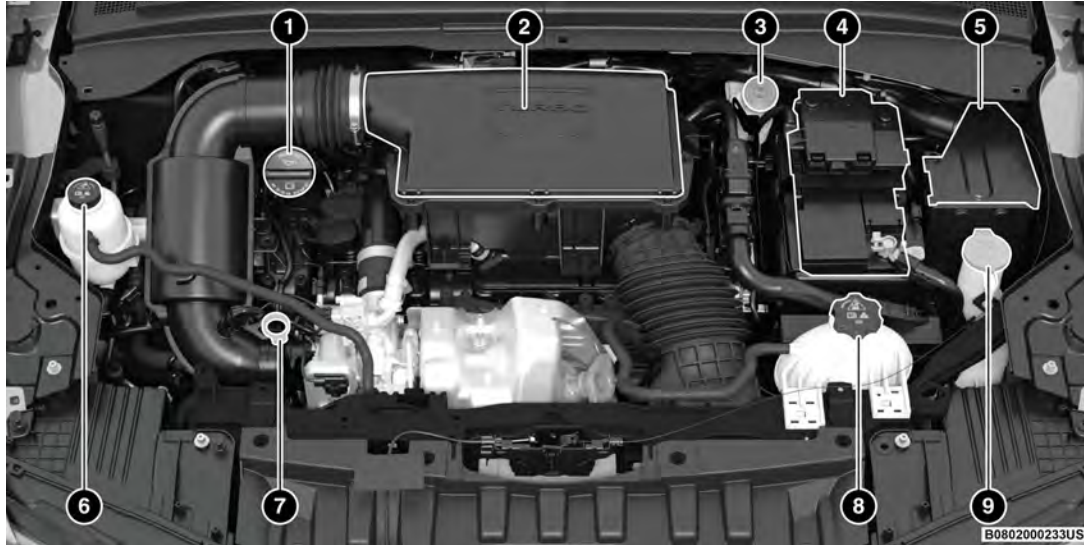

- 1 – Engine Oil Fill
- 2 – Engine Air Cleaner Filter
- 3 – Brake Fluid Reservoir Cap
- 4 – Battery
- 5 – Power Distribution Center (Fuses)

- 6 – Intercooler Coolant Reservoir Cap
- 7 – Engine Oil Dipstick
- 8 – Engine Coolant Pressure Cap
- 9 – Washer Fluid Reservoir Cap

## CHECKING OIL LEVEL

To ensure proper engine lubrication, the engine oil must be maintained at the correct level. Check the oil level at regular intervals, such as every fuel stop. The best time to check the engine oil level is about five minutes after a fully warmed up engine is shut off.

Checking the oil while the vehicle is on level ground will improve the accuracy of the oil level readings.

There are four possible dipstick types:

- Crosshatched zone.
- Crosshatched zone marked SAFE.
- Crosshatched zone marked with MIN at the low end of the range and MAX at the high end of the range.
- Crosshatched zone marked with dimples at the MIN and the MAX ends of the range.

### NOTE:

Always maintain the oil level within the crosshatch markings on the dipstick.

Adding 1 qt (1 L) of oil when the reading is at the low end of the dipstick range will raise the oil level to the high end of the range marking.

### CAUTION!

Overfilling or underfilling the engine oil will cause aeration or loss of oil pressure. This could damage your engine.

### Engine Oil Cap/Dipstick Installation — PHEV

Install the oil cap/dipstick aligning arrow on the cap with arrow on the engine cover.



Oil Cap

1 — Oil Cap/Dipstick Arrow

2 — Engine Cover Arrow

## ADDING WASHER FLUID

The fluid reservoir is located in the front of the engine compartment. Be sure to check the fluid level in the reservoir at regular intervals. Fill the reservoir with windshield washer solvent (not radiator antifreeze) and operate the system for a few seconds to flush out the residual washer fluid.

When refilling the washer fluid reservoir, take some washer fluid, apply it to a cloth or towel, and wipe clean the wiper blades; this will help blade performance.

To prevent freeze-up of your windshield washer system in cold weather, select a solution or mixture that meets or exceeds the temperature range of your climate. This rating information can be found on most washer fluid containers.

### WARNING!

Commercially available windshield washer solvents are flammable. They could ignite and burn you. Care must be exercised when filling or working around the washer solution.

## MAINTENANCE-FREE BATTERY

Your vehicle is equipped with a maintenance-free battery. You will never have to add water, and periodic maintenance is not required.

### NOTE:

A battery replacement or disruption of power may cause loss of Steering Angle Calibration and an error message to occur  page 84. Performing a Lock-to-Lock Steering Angle Calibration may correct this condition.

### WARNING!

- Battery fluid is a corrosive acid solution and can burn or even blind you. Do not allow battery fluid to contact your eyes, skin, or clothing. Do not lean over a battery when attaching clamps. If acid splashes in eyes or on skin, flush the area immediately with large amounts of water.
- Battery gas is flammable and explosive. Keep flame or sparks away from the battery. Do not use a booster battery or any other booster source with an output greater than 12 Volts. Do not allow cable clamps to touch each other.
- Battery posts, terminals, and related accessories contain lead and lead compounds. Wash hands after handling.

**CAUTION!**

- It is essential when replacing the cables on the battery that the positive cable is attached to the positive post and the negative cable is attached to the negative post. Battery posts are marked positive (+) and negative (-) and are identified on the battery case. Cable clamps should be tight on the terminal posts and free of corrosion.
- If a "fast charger" is used while the battery is in the vehicle, disconnect both vehicle battery cables before connecting the charger to the battery. Do not use a "fast charger" to provide starting voltage.

**PRESSURE WASHING**

Cleaning the engine compartment with a high pressure washer is not recommended.

**CAUTION!**

Precautions have been taken to safeguard all parts and connections however, the pressures generated by high pressure washers are such that complete protection against water ingress cannot be guaranteed.

**VEHICLE MAINTENANCE**

An authorized dealer has the qualified service personnel, special tools, and equipment to perform all service operations in an expert manner. Service Manuals are available which include detailed service information for your vehicle. Refer to these Service Manuals before attempting any procedure yourself.

**NOTE:**

Intentional tampering with emissions control systems may void your warranty and could result in civil penalties being assessed against you.

**WARNING!**

You can be badly injured working on or around a motor vehicle. Only do service work for which you have the knowledge and the proper equipment. If you have any doubt about your ability to perform a service job, take your vehicle to a competent mechanic.

**ENGINE OIL****Engine Oil Selection**

For engine oil selection ↗ page 277.

**American Petroleum Institute (API) Approved Engine Oil**

These symbols mean that the oil has been certified by the API. The manufacturer only recommends API trademark oils.



The API Starburst trademark certifies OW-20, OW-30 and 5W-30 engine oils.



The API Donut trademark certifies OW-40 and 5W-40 engine oil.

**CAUTION!**

Do not use chemical flushes in your engine oil as the chemicals can damage your engine. Such damage is not covered by the New Vehicle Limited Warranty.

**Synthetic Engine Oils**

Your engine was designed for synthetic engine oils, only use synthetic API approved engine oils.

Synthetic engine oils which do not have both the correct API trademark and the correct SAE viscosity grade numbers should not be used.

**Materials Added To Engine Oil**

The manufacturer strongly recommends against the addition of any additives (other than leak detection dyes) to the engine oil. Engine oil is an engineered product and its performance may be impaired by supplemental additives.

**Disposing Of Used Engine Oil And Oil Filters**

Care should be taken in disposing of used engine oil and oil filters from your vehicle. Used oil and oil filters, indiscriminately discarded, can present a problem to the environment. Contact an authorized dealer, service station or governmental agency for advice on how and where used oil and oil filters can be safely discarded in your area.

## ENGINE OIL FILTER

The engine oil filter should be replaced with a new filter at every engine oil change.

### Engine Oil Filter Selection

A full-flow type disposable oil filter should be used for replacement. The quality of replacement filters varies considerably. Only high quality Mopar® certified filters should be used. If a Mopar® Engine Oil Filter is unavailable, only use filters that meet or exceed SAE/USCAR-36 Filter Performance Requirements.

## ENGINE AIR CLEANER FILTER

For the proper maintenance intervals ↪ page 230.

### WARNING!

The air induction system (air cleaner, hoses, etc.) can provide a measure of protection in the case of engine backfire. Do not remove the air induction system (air cleaner, hoses, etc.) unless such removal is necessary for repair or maintenance. Make sure that no one is near the engine compartment before starting the vehicle with the air induction system (air cleaner, hoses, etc.) removed. Failure to do so can result in serious personal injury.

### Engine Air Cleaner Filter Selection

The quality of replacement filters varies considerably. Only high quality Mopar® certified filters should be used.

## Engine Air Cleaner Filter Inspection and Replacement — Gas

Follow the recommended maintenance intervals as shown in the Maintenance Plan in this section.

### Engine Air Cleaner Filter Removal

1. Loosen the fasteners from the engine air cleaner filter cover using a suitable tool.

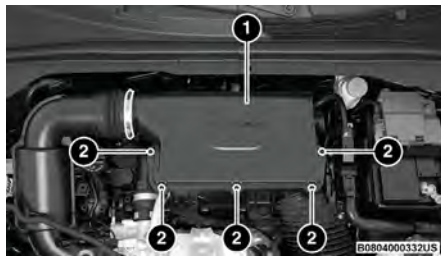

Engine Air Cleaner Filter Cover

- 1 — Engine Air Cleaner Filter Cover
- 2 — Fasteners

2. Lift the engine air cleaner filter cover to access the engine air cleaner filter by rotating at the hinge and pulling the cover away from the engine.
3. Remove the engine air cleaner filter from the housing assembly.

### Engine Air Cleaner Filter Installation

#### NOTE:

Inspect and clean the housing if significant dirt or debris is present before replacing the engine air cleaner filter.

1. Install the engine air cleaner filter into the housing assembly with the engine air cleaner filter inspection surface facing downward.
2. Tighten engine air cleaner filter cover fasteners using a suitable tool.

### CAUTION!

Do not overtighten the engine air cleaner filter cover lid screws or damage may result.

## Engine Air Cleaner Filter Inspection and Replacement — PHEV

Follow the recommended maintenance intervals as shown in the Maintenance Plan in this section.

### Engine Air Cleaner Filter Removal

1. Remove the engine cover.
2. Loosen the fasteners from the engine air cleaner filter cover using a suitable tool.

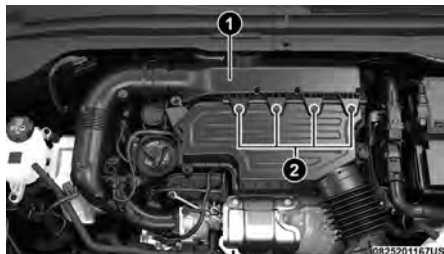

**Engine Air Cleaner Filter Cover**

- 1 — Engine Air Cleaner Filter Cover  
2 — Fasteners

3. Lift and remove the engine air cleaner filter cover to access the engine air cleaner filter.
4. Remove the engine air cleaner filter from the housing assembly.

#### Engine Air Cleaner Filter Installation

##### NOTE:

Inspect and clean the housing if significant dirt or debris is present before replacing the engine air cleaner filter.

1. Install the engine air cleaner filter into the housing assembly with the engine air cleaner filter inspection surface facing downward.
2. Install the engine air cleaner filter cover.
3. Tighten engine air cleaner filter cover fasteners using a suitable tool.

##### CAUTION!

Do not overtighten the engine air cleaner filter cover lid screws or damage may result.

4. Reinstall the engine cover.

## AIR CONDITIONER MAINTENANCE

For best possible performance, your air conditioner should be checked and serviced by an authorized dealer at the start of each warm season. This service should include cleaning of the condenser fins and a performance test. Drive belt tension should also be checked at this time.

##### WARNING!

- Use only refrigerants and compressor lubricants approved by the manufacturer for your air conditioning system. Some unapproved refrigerants are flammable and can explode, injuring you. Other unapproved refrigerants or lubricants can cause the system to fail, requiring costly repairs. Refer to Warranty Information Book, located in your owner's information kit, for further warranty information.
- The air conditioning system contains refrigerant under high pressure. To avoid risk of personal injury or damage to the system, adding refrigerant or any repair requiring lines to be disconnected should be done by an experienced technician.

##### CAUTION!

Do not use chemical flushes in your air conditioning system as the chemicals can damage your air conditioning components. Such damage is not covered by the New Vehicle Limited Warranty.

## Refrigerant Recovery And Recycling R-1234yf

R-1234yf Air Conditioning Refrigerant is a Hydrofluoroolefin (HFO) that is endorsed by the Environmental Protection Agency and is an ozone-friendly substance with a low global-warming potential. It is recommended that air conditioning service be performed by an authorized dealer using recovery and recycling equipment.

##### NOTE:

Use only the manufacturer approved A/C system compressor oil, and refrigerants. **Refer to underhood label for oil type.**

## Cabin Air Filter

See an authorized dealer for service.

## BODY LUBRICATION

Locks and all body pivot points, including such items as seat tracks, door hinge pivot points and rollers, liftgate, tailgate, decklid, sliding doors and hood hinges, should be lubricated periodically with a lithium-based grease, such as Mopar® Spray White Lube to ensure quiet, easy operation and to protect against rust and wear.

Prior to the application of any lubricant, the parts concerned should be wiped clean to remove dust and grit; after lubricating, excess oil and grease should be removed. Particular attention should also be given to hood latching components to ensure proper function. When performing other underhood services, the hood latch, release mechanism and safety catch should be cleaned and lubricated.

The external lock cylinders should be lubricated twice a year, preferably in the Autumn and Spring. Apply a small amount of a high quality lubricant, such as Mopar® Lock Cylinder Lubricant directly into the lock cylinder.

## WIPER BLADES

Clean the rubber edges of the wiper blades and the windshield and rear window periodically with a sponge or soft cloth and a mild nonabrasive cleaner. This will remove accumulations of salt, waxes, or road film, and help reduce streaking and smearing.

Operation of the wipers on dry glass for long periods may cause deterioration of the wiper blades. Always use washer fluid when using the wipers to remove salt or dirt from a dry windshield or rear window.

Avoid using the wiper blades to remove frost or ice from the windshield or rear window. Make sure that they are not frozen to the glass before turning them on to avoid damaging the blade. Keep the wiper blade out of contact with petroleum products such as engine oil, gasoline, etc.

### NOTE:

Life expectancy of wiper blades varies depending on geographical area and frequency of use. If chattering, marks, water lines or wet spots are present, clean the wiper blades or replace as necessary.

## Service Position Strategy

The Service Position Strategy places the wiper blades in a position that allows them to be easily changed.

To enable the Service Position Strategy, the wipers must be in the park position before placing the ignition in the OFF position. The Service Position Strategy must be activated within two minutes after the ignition is placed in the OFF position. To correctly activate the Service Position command, move the wiper lever upward for at least half a second. At every valid activation of the Service Position command, the wiper blades are activated for 250 ms. The Service Position command can be repeated several times to bring the blades into the desired position, up to a maximum of three times. After three subsequent activations the strategy is disabled.

### Function Deactivation And Reset:

- The ignition is placed in the ON/RUN position.
- There are three subsequent activations.
- The two minute timer has expired after turning the ignition OFF.

### NOTE:

When turning the ignition ON, the blades go into the park position.

## Front Wiper Blade Removal/Installation

### CAUTION!

Do not allow the wiper arm to spring back against the glass without the wiper blade in place or the glass may be damaged.

1. Place the wiper blades in the service position strategy.
2. Lift the front wiper arm upward to raise the wiper blade off of the windshield.
3. Push the release button on the arm of the wiper blade.
4. Push the wiper blade up and remove it.

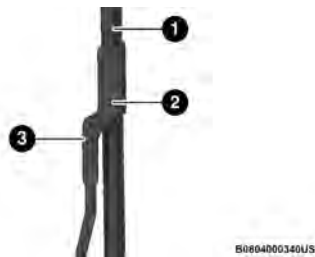

Wiper Arm And Blade

- 1 – Wiper Blade
- 2 – Release Button
- 3 – Wiper Arm

5. Install the wiper blade and firmly push the wiper blade until it snaps into place.



## Rear Wiper Blade Removal/Installation

1. Lift the rear wiper arm pivot cap away from the glass.

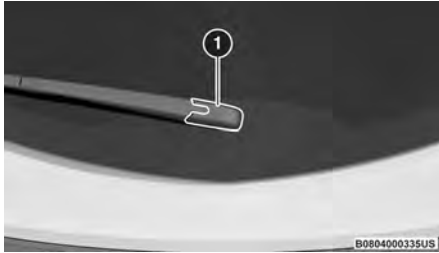

**Wiper Pivot Cap**

- 1 – Wiper Arm Pivot Cap

2. Remove the nut and remove the wiper arm from the vehicle.

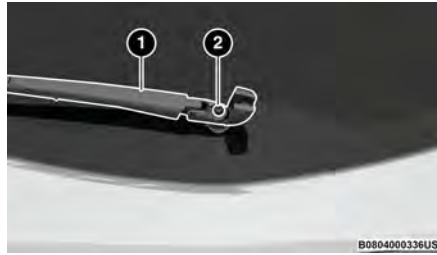

**Wiper Pivot Cap In Unlocked Position**

- 1 – Wiper Arm
- 2 – Wiper Arm Nut

3. Install a new wiper arm, securely tighten the nut and put the cap back in place.

## EXHAUST SYSTEM

The best protection against carbon monoxide entry into the vehicle body is a properly maintained engine exhaust system.

If you notice a change in the sound of the exhaust system; or if exhaust fumes can be detected inside the vehicle; or when the underside or rear of the vehicle is damaged; have an authorized technician inspect the complete exhaust system and adjacent body areas for broken, damaged, deteriorated, or mispositioned parts. Open seams or loose connections could permit exhaust fumes to seep into the passenger compartment. In addition, have the exhaust system inspected each time the vehicle is raised for lubrication or oil changes. Replace as required.

### WARNING!

- Exhaust gases can injure or kill. They contain carbon monoxide (CO), which is colorless and odorless. Breathing it can make you unconscious and can eventually poison you → page 207.
- A hot exhaust system can start a fire if you park over materials that can burn, such materials might be grass or leaves, and those items that come into contact with your exhaust system. Do not park or operate your vehicle in areas where your exhaust system can contact anything that can burn.

### CAUTION!

- The catalytic converter requires the use of unleaded fuel only. Leaded gasoline will destroy the effectiveness of the catalyst as an emissions control device and may seriously reduce engine performance and cause serious damage to the engine.
- Damage to the catalytic converter can result if your vehicle is not kept in proper operating condition. In the event of engine malfunction, particularly involving engine misfire or other apparent loss of performance, have your vehicle serviced promptly. Continued operation of your vehicle with a severe malfunction could cause the converter to overheat, resulting in possible damage to the converter and vehicle.

Under normal operating conditions, the catalytic converter will not require maintenance. However, it is important to keep the engine properly tuned to ensure proper catalyst operation and prevent possible catalyst damage.

#### NOTE:

Intentional tampering with emissions control systems can result in civil penalties being assessed against you. In unusual situations involving grossly malfunctioning engine operation, a scorching odor may suggest severe and abnormal catalyst overheating. If this occurs, stop the vehicle, turn off the engine and allow it to cool. Service, including a tune-up to manufacturer specifications, should be obtained immediately.

To minimize the possibility of catalytic converter damage:

- Do not interrupt the ignition when the transmission is in gear and the vehicle is in motion.
- Do not try to start the vehicle by pushing or towing the vehicle.
- Do not idle the engine with any ignition components disconnected or removed, such as during diagnostic testing, or for prolonged periods during very rough idle or malfunctioning operating conditions.

## COOLING SYSTEM

### WARNING!

- You or others can be badly burned by hot engine coolant (antifreeze) or steam from your radiator. If you see or hear steam coming from under the hood, do not open the hood until the radiator has had time to cool. Never open a cooling system pressure cap when the radiator or coolant bottle is hot.
- Keep hands, tools, clothing, and jewelry away from the radiator cooling fan when the hood is raised. The fan starts automatically and may start at any time, whether the engine is running or not.
- When working near the radiator cooling fan, disconnect the fan motor lead or turn the ignition to the OFF mode. The fan is temperature controlled and can start at any time the ignition is in the ON mode.

### Coolant Checks

Check engine coolant (antifreeze) protection every 12 months (before the onset of freezing weather, where applicable). If the engine coolant is dirty or rusty in appearance, the system should be drained, flushed and refilled with fresh engine coolant. Check the front of the A/C condenser for any accumulation of bugs, leaves, etc. If dirty, clean by gently spraying water from a garden hose vertically down the face of the condenser.

### Cooling System — Drain, Flush And Refill

Some vehicles require special tools to add coolant properly. Failure to fill these systems properly could lead to severe internal engine damage. If any coolant is needed to be added to the system please contact an authorized dealer.

If the engine coolant (antifreeze) is dirty or contains visible sediment, have an authorized dealer clean and flush with OAT coolant (conforming to MS.90032).

Refer to the Maintenance Plan for the proper maintenance intervals ↩ page 230.

### Electric/Battery Coolant System — PHEV (If Equipped)

These coolant systems must be serviced by an authorized dealer. If the coolant level is below what is specified on the reservoir, contact an authorized dealer for service.

These systems require the use of high purity water, such as deionized, or distilled water, when mixing the water and coolant (antifreeze) solution. The use of lower quality water will reduce the amount of corrosion protection in the cooling systems. If the coolant level of the battery coolant system is low, the Hybrid Electric Vehicle System Service Light will be illuminated on the instrument cluster.

## Selection Of Coolant

For further information ↗ page 277.

### NOTE:

- Mixing of engine coolant (antifreeze) other than specified Organic Additive Technology (OAT) engine coolant, may result in engine damage and may decrease corrosion protection. OAT engine coolant is different and should not be mixed with Hybrid Organic Additive Technology (HOAT) engine coolant or any "globally compatible" coolant. If a non-OAT engine coolant is introduced into the cooling system in an emergency, the cooling system will need to be drained, flushed, and refilled with fresh OAT coolant (conforming to MS.90032), by an authorized dealer as soon as possible.
- Do not use water alone or alcohol-based engine coolant products. Do not use additional rust inhibitors or anti-rust products, as they may not be compatible with the radiator engine coolant and may plug the radiator.
- This vehicle has not been designed for use with propylene glycol-based engine coolant. Use of propylene glycol-based engine coolant is not recommended.
- Some vehicles require special tools to add coolant properly. Failure to fill these systems properly could lead to severe internal engine damage. If any coolant is needed to be added to the system please contact an authorized dealer.

## Adding Coolant

Your vehicle has been built with an improved engine coolant (OAT coolant conforming to MS.90032) that allows extended maintenance intervals. This engine coolant (antifreeze) can be used up to 10 years or 150,000 miles (240,000 km) before replacement. To prevent reducing this extended maintenance period, it is important to use the same engine coolant (OAT coolant conforming to MS.90032) throughout the life of your vehicle.

Please review these recommendations for using OAT engine coolant that meets the requirements of the manufacturer Material Standard MS.90032. When adding engine coolant:

- We recommend using Mopar® Antifreeze/Coolant 10 Year/150,000 Mile (240,000 km) Formula OAT that meets the requirements of the manufacturer Material Standard MS.90032.
- Mix a minimum solution of 50% OAT engine coolant that meets the requirements of the manufacturer Material Standard MS.90032 and distilled water. Use higher concentrations (not to exceed 70%) if temperatures below  $-34^{\circ}\text{F}$  ( $-37^{\circ}\text{C}$ ) are anticipated. Please contact an authorized dealer for assistance.
- Use only high purity water such as distilled or deionized water when mixing the water/engine coolant solution. The use of lower quality water will reduce the amount of corrosion protection in the engine cooling system.

### NOTE:

- It is the owner's responsibility to maintain the proper level of protection against freezing according to the temperatures occurring in the area where the vehicle is operated.

- Some vehicles require special tools to add coolant properly. Failure to fill these systems properly could lead to severe internal engine damage. If any coolant is needed to be added to the system, please contact an authorized dealer.
- Mixing engine coolant types is not recommended and can result in cooling system damage. If HOAT and OAT coolant are mixed in an emergency, have an authorized dealer drain, flush, and refill with OAT coolant (conforming to MS.90032) as soon as possible.

## Cooling System Pressure Cap

The cap must be fully tightened to prevent loss of engine coolant (antifreeze), and to ensure that engine coolant will return to the radiator from the coolant expansion bottle/recovery tank (if equipped).

The cap should be inspected and cleaned if there is any accumulation of foreign material on the sealing surfaces.

### WARNING!

- Do not open a hot engine cooling system. Never add engine coolant (antifreeze) when the engine is overheated. Do not loosen or remove the cap to cool an overheated engine. Heat causes pressure to build up in the cooling system. To prevent scalding or injury, do not remove the pressure cap while the system is hot or under pressure.
- Do not use a pressure cap other than the one specified for your vehicle. Personal injury or engine damage may result.

## Disposal Of Used Coolant

Used ethylene glycol-based coolant (antifreeze) is a regulated substance requiring proper disposal. Check with your local authorities to determine the disposal rules for your community. To prevent ingestion by animals or children, do not store ethylene glycol-based coolant in open containers or allow it to remain in puddles on the ground. If ingested by a child or pet, seek emergency assistance immediately. Clean up any ground spills immediately.

## Coolant Level

The coolant expansion bottle provides a quick visual method for determining that the coolant level is adequate. With the engine off and cold, the level of the engine coolant (antifreeze) in the bottle should be between the "MIN" and "MAX" marks.

As long as the engine operating temperature is satisfactory, the coolant bottle need only be checked once a month.

When additional engine coolant is needed to maintain the proper level, it should be added to the coolant bottle. Do not overfill.

## Engine Coolant Level — 2.0L

### WARNING!

- Do not open a hot engine cooling system. Never add engine coolant (antifreeze) when the engine is overheated. Do not loosen or remove the cap to cool an overheated engine. Heat causes pressure to build up in the cooling system. To prevent scalding or injury, do not remove the pressure cap while the system is hot or under pressure.

(Continued)

### WARNING!

- Do not use a pressure cap other than the one specified for your vehicle. Personal injury or engine damage may result.

With the engine OFF and cold, the level of the engine coolant should be within the OK range between the ADD and FULL range on the dipstick.

- Remove the cap with level dipstick from the engine coolant bottle.
- Clean off the coolant from the dipstick.
- Rest the cap on the opening of the coolant bottle without tightening the cap.
- Remove the cap with dipstick and check the coolant level on the dipstick.

The radiator normally remains completely full, so there is no need to remove the radiator/coolant pressure cap unless checking for engine coolant freeze point or replacing coolant. Advise your service attendant of this. As long as the engine operating temperature is satisfactory, the coolant bottle need only be checked once a month.

When additional engine coolant is needed to maintain the proper level, only OAT coolant that meets the requirements of the manufacturer Material Standard MS.90032 should be added to the coolant bottle. Do not overfill.

## Cooling System Notes

### NOTE:

When the vehicle is stopped after a few miles/kilometers of operation, you may observe vapor coming from the front of the engine compartment. This is normally a result of moisture from rain, snow, or high humidity accumulating on the radiator and being vaporized when the thermostat opens, allowing hot engine coolant (antifreeze) to enter the radiator.

If an examination of your engine compartment shows no evidence of radiator or hose leaks, the vehicle may be safely driven. The vapor will soon dissipate.

- Do not overfill the coolant expansion bottle.
- Check the coolant freeze point in the radiator and in the coolant expansion bottle. If engine coolant needs to be added, the contents of the coolant expansion bottle must also be protected against freezing.
- If frequent engine coolant additions are required, the cooling system should be pressure tested for leaks.
- Maintain engine coolant concentration at a minimum of 50% OAT coolant (conforming to MS.90032) and distilled water for proper corrosion protection of your engine which contains aluminum components.
- Make sure that the coolant expansion bottle overflow hoses are not kinked or obstructed.
- Keep the front of the radiator clean. If your vehicle is equipped with air conditioning, keep the front of the condenser clean.

- Do not change the thermostat for Summer or Winter operation. If replacement is ever necessary, install **ONLY** the correct type thermostat. Other designs may result in unsatisfactory engine cooling performance, poor gas mileage, and increased emissions.

## BRAKE SYSTEM

In order to ensure brake system performance, all brake system components should be inspected periodically. For the proper maintenance intervals ↪ page 230.

### WARNING!

Riding the brakes can lead to brake failure and possibly a collision. Driving with your foot resting or riding on the brake pedal can result in abnormally high brake temperatures, excessive lining wear, and possible brake damage. You would not have your full braking capacity in an emergency.

## Brake Master Cylinder

The fluid in the master cylinder should be checked when performing under hood services or immediately if the Brake Warning Light is illuminated.

Be sure to clean the top of the master cylinder area before removing the cap. If necessary, add fluid to bring the fluid level up to the requirements described on the brake fluid reservoir. With disc brakes, fluid level can be expected to fall as the brake pads wear. Brake fluid level should be checked when pads are replaced. However, low fluid level may be caused by a leak and a checkup may be needed.

Use only the manufacturer recommended brake fluid ↪ page 277.

### WARNING!

- Use only the manufacturer recommended brake fluid ↪ page 277. Using the wrong type of brake fluid can severely damage your brake system and/or impair its performance. The proper type of brake fluid for your vehicle is also identified on the original factory installed hydraulic master cylinder reservoir.
- To avoid contamination from foreign matter or moisture, use only new brake fluid or fluid that has been in a tightly closed container. Keep the master cylinder reservoir cap secured at all times. Brake fluid in an open container absorbs moisture from the air resulting in a lower boiling point. This may cause it to boil unexpectedly during hard or prolonged braking, resulting in sudden brake failure. This could result in a collision.
- Overfilling the brake fluid reservoir can result in spilling brake fluid on hot engine parts, causing the brake fluid to catch fire. Brake fluid can also damage painted and vinyl surfaces, care should be taken to avoid its contact with these surfaces.
- Do not allow petroleum-based fluid to contaminate the brake fluid. Brake seal components could be damaged, causing partial or complete brake failure. This could result in a collision.

## AUTOMATIC TRANSMISSION

### Special Additives

It is strongly recommended against using any special additives in the transmission. Automatic Transmission Fluid (ATF) is an engineered product and its performance may be impaired by supplemental additives. Therefore, do not add any fluid additives to the transmission. The only exception to this policy is the use of special dyes for diagnosing fluid leaks in 6-speed transmissions. Avoid using transmission sealers as they may adversely affect seals.

### CAUTION!

Do not use chemical flushes in your transmission as the chemicals can damage your transmission components. Such damage is not covered by the New Vehicle Limited Warranty.

### Fluid Level Check

The fluid level is preset at the factory and does not require adjustment under normal operating conditions. Routine fluid level checks are not required; therefore the transmission has no dipstick. An authorized dealer can check your transmission fluid level using special service tools. If you notice fluid leakage or transmission malfunction, visit an authorized dealer immediately to have the transmission fluid level checked. Operating the vehicle with an improper fluid level can cause severe transmission damage.

**CAUTION!**

If a transmission fluid leak occurs, visit an authorized dealer immediately. Severe transmission damage may occur. An authorized dealer has the proper tools to adjust the fluid level accurately.

**Fluid And Filter Changes**

Under normal operating conditions, the fluid installed at the factory will provide satisfactory lubrication for the life of the vehicle.

Routine fluid and filter changes are not required. However, change the fluid and filter if the fluid becomes contaminated (with water, etc.), or if the transmission is disassembled for any reason.

**Selection Of Lubricant**

It is important to use the proper transmission fluid to ensure optimum transmission performance and life. Use only the manufacturer specified transmission fluid  page 277. It is important to maintain the transmission fluid at the correct level using the recommended fluid.

**NOTE:**

No chemical flushes should be used in any transmission; only the approved lubricant should be used.

**CAUTION!**

Using a transmission fluid other than the manufacturer recommended fluid may cause deterioration in transmission shift quality and/or torque converter shudder. For fluid specifications  page 277.

**FUSES****General Information****WARNING!**

- When replacing a blown fuse, always use an appropriate replacement fuse with the same amp rating as the original fuse. Never replace a fuse with another fuse of higher amp rating. Never replace a blown fuse with metal wires or any other material. Do not place a fuse inside a circuit breaker cavity or vice versa. Failure to use proper fuses may result in serious personal injury, fire and/or property damage.
- Before replacing a fuse, make sure that the ignition is off and that all the other services are switched off and/or disengaged.
- If the replaced fuse blows again, contact an authorized dealer.
- If a general protection fuse for safety systems (air bag system, braking system), power unit systems (engine system, transmission system) or steering system blows, contact an authorized dealer.

The fuses protect electrical systems against excessive current.

When a device does not work, you must check the fuse element inside the blade fuse for a break/melt.

Also, please be aware that using power outlets for extended periods of time with the engine off may result in vehicle battery discharge.

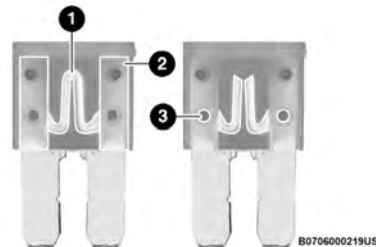
**Blade Fuses**

- 1 — Fuse Element
- 2 — Blade Fuse with a good/functional fuse element
- 3 — Blade Fuse with a bad/not functional fuse element (blown fuse)

**Power Distribution Center/Fuses And Relays**

The Front Power Distribution Center is located in the engine compartment. This module contains fuses and relays. Fuse cavity locations are printed on the inside of the power distribution center cover.

**CAUTION!**

When installing the power distribution center cover, it is important to ensure the cover is properly positioned and fully latched. Failure to do so may allow water to get into the power distribution center and possibly result in an electrical system failure.



**Underhood Power Distribution Location**



0827201186US

**Underhood Power Distribution Location**



The fuse box screw and cover must be removed to gain access to the fuses.



#### Fuse Box Cover And Locking Screw Removal

- 1 – Fuse Cover
- 2 – Locking Screw

For fuse box access, proceed as follows:

1. Turn the locking screw counterclockwise.
2. Slowly release the screw.
3. Remove the fuse box cover by sliding it upward.
4. Reverse the procedure to reinstall.

## Main Fuse Block — Gasoline Engine

Cavity	Cartridge Fuse	Maxi Fuse	Mini Fuse	Description
<b>* If Equipped</b>				
F01	-	70 Amp Tan	-	BCM1
F02	-	70 Amp Tan	-	BCM2 / RDU
F03	20 Amp Blue	-	-	BCM3
F04	40 Amp Green	-	-	BCM Valves
F05	-	40 Amp Orange	-	PTC 1
F06	-	20 Amp Yellow	-	Front Wiper Motor
F07	-	20 Amp Yellow	-	DTCM
F08	30 Amp Pink	-	-	Power Supply F24 - F87 - Fxx
F09	-	-	7.5 Amp Brown	ECM T09
F10	-	-	15 Amp Blue	Horn
F11	-	-	5 Amp Tan	Engine Secondary Loads
F14	-	-	7.5 Amp Brown	LTR
F15	-	40 Amp Orange	-	BSM Pump
F16	-	-	10 Amp Red	ECM / TCM / AGSM
F17	-	-	10 Amp Red	ECM
F18	-	-	-	Spare
F19	-	-	7.5 Amp Brown	A/C Compressor
F20	-	-	15 Amp Blue	RR Cargo Power Outlet
F21	-	-	20 Amp Yellow	Fuel Pump
F22	-	-	15 Amp Blue	ECM
F23	-	-	5 Amp Tan	USB / Aux Outlet
F24	-	-	10 Amp Red	DTCM
F30	-	-	5 Amp Tan	AWD DTCM
F81	-	30 Amp Green	-	Brake Booster Vacuum Pump
F82	-	-	-	Spare

Cavity	Cartridge Fuse	Maxi Fuse	Mini Fuse	Description
<b>* If Equipped</b>				
F83	40 Amp Green	-	-	HVAC Fan
F84	-	-	7.5 Amp Brown	Rad Fan Enable
F87	-	-	5 Amp Tan	AGSM
F88	-	-	7.5 Amp Brown	Heated Mirrors & Washer Nozzle
F89	30 Amp Pink	-	-	Rear Window Defrost
F90	-	-	5 Amp Tan	Intelligent Battery Sensor

**Main Fuse Block — Hybrid**

Cavity	Cartridge Fuse	Maxi Fuse	Mini Fuse	Description
<b>* If Equipped</b>				
F01	-	70 Amp Tan	-	BCM1
F02	-	70 Amp Tan	-	BCM2 / RDU
F03	20 Amp Blue	-	-	BMC3
F04	40 Amp Green	-	-	BCM Valves
F05	-	40 Amp Orange	-	PTC 1
F06	-	20 Amp Yellow	-	Front Wiper Motor
F07	-	50 Amp Red	-	AUX 1 RDU
F08	30 Amp Pink	-	-	Power Supply F24 - F87 - Fxx
F09	-	-	7.5 Amp Brown	ECM T09
F10	-	-	15 Amp Blue	Horn
F11	-	-	5 Amp Tan	Engine Secondary Loads
F14	-	-	-	Spare
F15	-	70 Amp Tan	-	BSM Pump
F16	-	-	10 Amp Red	ECM / TCM / AGSM

Cavity	Cartridge Fuse	Maxi Fuse	Mini Fuse	Description
<b>* If Equipped</b>				
F17	-	-	10 Amp Red	GPF - HV Fuel lid - HV Fuel Tank Isolation Valve
F19	-	-	7.5 Amp Brown	A/C Compressor
F20	-	-	15 Amp Blue	RR Cargo Power Outlet
F21	-	-	20 Amp Yellow	Fuel Pump
F22	-	-	20 Amp Yellow	Engine Primary Loads
F23	-	-	5 Amp Tan	AGS/ USB / Aux Outlet
F24	-	-	10 Amp Red	TCM
F30	-	-	-	Spare
F81	-	40 Amp Orange	-	AUX 2 RDU
F82	40 Amp Green	-	-	External Oil Pump (AT)
F83	40 Amp Green	-	-	HVAC Fan
F84	-	-	-	Spare
F87	-	-	5 Amp Tan	AGSM
F88	-	-	7.5 Amp Brown	Heated Mirrors & Washer Nozzle
F89	30 Amp Pink	-	-	Rear Window Defrost
F90	-	-	5 Amp Tan	Intelligent Battery Sensor
Fxx	-	-	25 Amp Clear	EPT_PIM_Feed_2



B0706000244US

Supplemental Fuse Box Location

## Relays — Gasoline Engine

Cavity	Maxi Fuse	Mini Fuse	Description
T02	-	-	Not Used
T03	-	30 Amp	Horn
T05	-	30 Amp	A/C Compressor
T06	-	30 Amp	Rad Fan Enable
T08	-	30 Amp	HVAC Fan
T10	-	-	Not Used
T14	-	30 Amp	RR Cargo Power Outlet
T19	-	-	Not Used
T20	-	30 Amp	Starter Relay R1
T31	-	30 Amp	Fuel Pump
T89	-	-	Not Used
T90	-	30 Amp	Brake Booster Vacuum Pump

## Relays — Hybrid

Cavity	Maxi Fuse	Mini Fuse	Description
T02	-	-	Not Used
T03	-	30 Amp	Horn
T05	-	30 Amp	A/C Compressor
T06	-	30 Amp	Rad Fan Enable
T07	50 Amp	-	Aux.1
T08	-	30 Amp	HVAC Fan
T09	-	30 Amp	Engine Main Relay
T10	-	-	Not Used
T14	-	30 Amp	Rear Cargo Power Outlet
T17	-	30 Amp	Rear Window Defrost/Heated Mirrors

Cavity	Maxi Fuse	Mini Fuse	Description
T19	–	30 Amp	External Oil Pump
T20	–	30 Amp	Starter Relay R1
T31	–	30 Amp	Fuel Pump
T89	–	–	Not Used
T90	–	30 Amp	Brake Booster Vacuum Pump

#### Supplemental Fuse Box – Hybrid

Cavity	Mini Fuse	Description
F01	5 Amp Tan	Electric Air Heater (EAH)
F02	7.5 Amp Brown	Electric Air Compressor (EAC)
F03	5 Amp Tan	Integrated Dual Charge Module (IDCM)
F04	5 Amp Tan	Charge Port Indicator Module (CPIM)
F05	15 Amp Blue	Power Electronic Coolant Pump 2 (PECP2)
F06	15 Amp Blue	Power Electronic Coolant Pump (PECP)
F07	5 Amp Tan	Aux Heater Pump (AHP)
F08	5 Amp Tan	PIM Feed 1
F09	10 Amp Red	BPCM Feed 1
F10	5 Amp Tan	PIM Feed 3
F11	10 Amp Red	BPCM Feed 2
F12	5 Amp Tan	Electronic Pedestrian Protection Module (EPPM)

## Interior Fuses

The interior fuse panel is located under the driver's side lower instrument panel.



**Interior Fuse Box Location**

Cavity	Mini Fuse	Description
<b>*If Equipped</b>		
F31	7.5 Amp Brown	HVAC relay coil / Power Outlet / Seats Movement Relay Coil
F33	20 Amp Yellow	Front Passenger Window Lifter
F34	20 Amp Yellow	Front Driver Window Lifter
F36	15 Amp Blue	HVAC / VTA / External Mirror / Ceiling Light / CVPM / Radio Mod / USB / AUX/ DCSD / Electric Steering Lock
F37	10 Amp Red	Brake Switch / DASM / IPC
F38	20 Amp Yellow	Central Door Lock / Doors Unlock / Decklid / Liftgate
F42	7.5 Amp Brown	BSM / EPS
F43	20 Amp Yellow	Bi-Directional Washer Pump
F47	20 Amp Yellow	Rear Left Window Lifter
F48	20 Amp Yellow	Rear Right Window Lifter
F49	7.5 Amp Brown	PAM / RLS / Power Internal Mirror / Heated Seats Relay Coil / USB Charger / WCPM / DTV / ESL / HCPM
F50	7.5 Amp Brown	ORC



Cavity	Mini Fuse	Description
<b>*If Equipped</b>		
F51	7.5 Amp Brown	HCP / Reverse Gear / Filter Diesel SNSR / A/C Compressor / HVAC / Defrosting / Right Head lamp Leveling / Left Headlamp Leveling / LDW / Alarm Mod / Airbag Psg / PIM / Trailer Tow Mod / AFLM / Air Quality Sensor / ASBM / Headlamp Leveling
F53	7.5 Amp Brown	ALU / EPB / BrakePedalSW NO / EMCM / TBM / DSCM / IPC
F94	15 Amp Blue	Power Outlet

### Rear Cargo Fuse/Relay Distribution Unit — If Equipped

To access the fuses, remove the access door from the left rear panel in the rear cargo area.



**Rear Fuse Access Door Location**

The fuses may be contained in two units. Fuse Holder No. 1 is located closest to the rear of the vehicle and Fuse Holder No. 2 (If equipped with trailer towing) is located closest to the front of the vehicle.

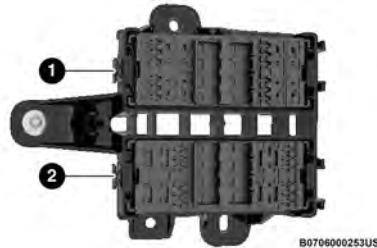

**Rear Cargo Fuse Cavity Example**

- 1 – Fuse Holder No. 1
- 2 – Fuse Holder No. 2

**Fuse Holder No. 1**

<b>Cavity</b>	<b>Mini Fuse</b>	<b>Description</b>
<b>* If Equipped</b>		
F1	20 Amp Yellow	Sunroof*
F2	-	-
F3	30 Amp Green	Power Liftgate Module (PLGM)
F4	5 Amp Tan	Driver And Passenger Ventilated Seats (HMSM*)
F5	25 Amp Clear	Heating And Memory Drive Seat Module 1
F6	10 Amp Red	Heating And Memory Drive Seat Module 2
F7	7.5 Amp Brown	Driver And Passenger Lumbar Regulator (Without HMSM)
F8	20 Amp Yellow	Passenger Seat SW (HMSM*)

**Fuse Holder No. 2**

<b>Cavity</b>	<b>Mini Fuse</b>	<b>Description</b>
F3	5 Amp Tan	Hands-Free Power Liftgate (HFRM)
F4	7.5 Amp Brown	Damping Control Module
F5	5 Amp Tan	Changeover Valve Feed (ELCM)
F8	7.5 Amp Brown	Damping Control Module

On the Rear Cargo Fuse/Relay Distribution Unit bracket, there is a Maxi Fuse holder for the Amplifier (if equipped).

<b>Cavity</b>	<b>Maxi Fuse</b>	<b>Description</b>
<b>* If Equipped</b>		
F01	30 Amp Green	Amplifier*

## BULB REPLACEMENT

### Replacement Bulbs, Names, And Part Numbers

In the instance a bulb needs to be replaced, this section includes bulb description and replacement part numbers.

#### Interior Bulbs

The Interior lights are LED, for replacement of any LED lamps, see an authorized dealer.

#### Exterior Bulbs

The exterior lights are LED, for replacement of any LED lamps, see an authorized dealer.

## TIRES

### TIRE SAFETY INFORMATION

Tire safety information will cover aspects of the following information: Tire Markings, Tire Identification Numbers, Tire Terminology and Definitions, Tire Pressures, and Tire Loading.

### Tire Markings

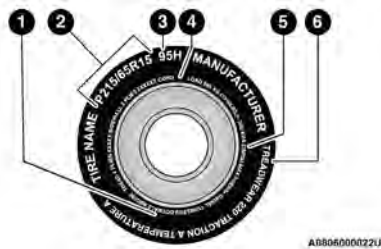

### Tire Markings

1 – US DOT Safety Standards Code

(TIN)

2 – Size Designation

3 – Service Description

4 – Maximum Load

5 – Maximum Pressure

6 – Treadwear, Traction and Temperature Grades

### NOTE:

- P (Passenger) – Metric tire sizing is based on US design standards. P-Metric tires have the letter “P” molded into the sidewall preceding the size designation. Example: P215/65R15 95H.
- European – Metric tire sizing is based on European design standards. Tires designed to this standard have the tire size molded into the sidewall beginning with the section width. The letter “P” is absent from this tire size designation. Example: 215/65R15 96H.
- LT (Light Truck) – Metric tire sizing is based on US design standards. The size designation for LT-Metric tires is the same as for P-Metric tires except for the letters “LT” that are molded into the sidewall preceding the size designation. Example: LT235/85R16.
- Temporary spare tires are designed for temporary emergency use only. Temporary high pressure compact spare tires have the letter “T” or “S” molded into the sidewall preceding the size designation. Example: T145/80D18 103M.
- High flotation tire sizing is based on US design standards and it begins with the tire diameter molded into the sidewall. Example: 31x10.5 R15 LT.

## TIRE SIZING CHART

<b>EXAMPLE:</b>
<b>Example Size Designation:</b> P215/65R15XL 95H, 215/65R15 96H, LT235/85R16C, T145/80D18 103M, 31x10.5 R15 LT
<p><b>P</b> = Passenger car tire size based on US design standards, or  <b>"...blank..."</b> = Passenger car tire based on European design standards, or  <b>LT</b> = Light truck tire based on US design standards, or  <b>T or S</b> = Temporary spare tire or  <b>31</b> = Overall diameter in inches (in)  <b>215, 235, 145</b> = Section width in millimeters (mm)  <b>65, 85, 80</b> = Aspect ratio in percent (%) <ul style="list-style-type: none"> <li>● Ratio of section height to section width of tire, or</li> </ul> <b>10.5</b> = Section width in inches (in)</p>
<p><b>R</b> = Construction code <ul style="list-style-type: none"> <li>● "R" means radial construction, or</li> <li>● "D" means diagonal or bias construction</li> </ul> </p>
<b>15, 16, 18</b> = Rim diameter in inches (in)
<b>Service Description:</b>
<p><b>95</b> = Load Index <ul style="list-style-type: none"> <li>● A numerical code associated with the maximum load a tire can carry</li> </ul> </p>
<p><b>H</b> = Speed Symbol <ul style="list-style-type: none"> <li>● A symbol indicating the range of speeds at which a tire can carry a load corresponding to its load index under certain operating conditions</li> <li>● The maximum speed corresponding to the speed symbol should only be achieved under specified operating conditions (i.e., tire pressure, vehicle loading, road conditions, and posted speed limits)</li> </ul> </p>
<p><b>Load Identification:</b>  Absence of the following load identification symbols on the sidewall of the tire indicates a Standard Load (SL) tire: <ul style="list-style-type: none"> <li>● <b>XL</b> = Extra load (or reinforced) tire, or</li> <li>● <b>LL</b> = Light load tire or</li> <li>● <b>C, D, E, F, G</b> = Load range associated with the maximum load a tire can carry at a specified pressure</li> </ul> </p>
<b>Maximum Load</b> - Maximum load indicates the maximum load this tire is designed to carry
<b>Maximum Pressure</b> - Maximum pressure indicates the maximum permissible cold tire inflation pressure for this tire

## Tire Identification Number (TIN)

The TIN may be found on one or both sides of the tire; however, the date code may only be on one side. Tires with white sidewalls will have the full TIN, including the date code, located on the white sidewall side of the tire. Look for the TIN on the outboard side of black sidewall tires as mounted on the vehicle. If the TIN is not found on the outboard side, then you will find it on the inboard side of the tire.

<b>EXAMPLE:</b>
DOT MA L9 ABCD 0301
<b>DOT</b> = Department of Transportation <ul style="list-style-type: none"> <li>This symbol certifies that the tire is in compliance with the US Department of Transportation tire safety standards and is approved for highway use</li> </ul>
<b>MA</b> = Code representing the tire manufacturing location (two digits)
<b>L9</b> = Code representing the tire size (two digits)
<b>ABCD</b> = Code used by the tire manufacturer (one to four digits)
<b>03</b> = Number representing the week in which the tire was manufactured (two digits) <ul style="list-style-type: none"> <li>03 means the 3rd week</li> </ul>
<b>01</b> = Number representing the year in which the tire was manufactured (two digits) <ul style="list-style-type: none"> <li>01 means the year 2001</li> <li>Prior to July 2000, tire manufacturers were only required to have one number to represent the year in which the tire was manufactured. Example: 031 could represent the 3rd week of 1981 or 1991</li> </ul>

## Tire Terminology And Definitions

Term	Definition
<b>B-pillar</b>	The vehicle B-pillar is the structural member of the body located behind the front door.
<b>Cold Tire Inflation Pressure</b>	Cold tire inflation pressure is defined as the tire pressure after the vehicle has not been driven for at least three hours, or driven less than 1 mile (1.6 km) after sitting for a minimum of three hours. Inflation pressure is measured in units of psi (pounds per square inch) or kPa (kilopascals).
<b>Maximum Inflation Pressure</b>	The maximum inflation pressure is the maximum permissible cold tire inflation pressure for this tire. The maximum inflation pressure is molded into the sidewall.
<b>Recommended Cold Tire Inflation Pressure</b>	Manufacturer recommended cold tire inflation pressure as shown on the tire placard.
<b>Tire Placard</b>	A label permanently attached to the vehicle describing the vehicle's loading capacity, the original equipment tire sizes and the recommended cold tire inflation pressures.

## Tire Loading And Tire Pressure

### NOTE:

The proper cold tire inflation pressure is listed on the driver's side B-pillar or the rear edge of the driver's side door.

Check the inflation pressure of each tire, including the spare tire (if equipped), at least monthly and inflate to the recommended pressure for your vehicle.



Example Tire Placard Location (Door)



Example Tire Placard Location (B-pillar)

### Tire And Loading Information Placard

TIRE AND LOADING INFORMATION			
SEATING CAPACITY - TOTAL 5 FRONT 2 REAR 3			
THE COMBINED WEIGHT OF OCCUPANTS AND CARGO SHOULD NEVER EXCEED XXX KG OR XXX LBS			
TIRE	FRONT	REAR	SPARE
ORIGINAL TIRE SIZE	P195/70R14	P195/70R14	T125/70D15
COLD TIRE INFLATION PRESSURE	200kPa, 29PSI	200kPa, 29PSI	420kPa, 60PSI
SEE OWNER'S MANUAL FOR ADDITIONAL INFORMATION			4N109298

Tire And Loading Information Placard

This placard tells you important information about the:

1. Number of people that can be carried in the vehicle.
2. Total weight your vehicle can carry.
3. Tire size designed for your vehicle.
4. Cold tire inflation pressures for the front, rear, and spare tires.

### LOADING

The vehicle maximum load on the tire must not exceed the load carrying capacity of the tire on your vehicle. You will not exceed the tire's load carrying capacity if you adhere to the loading conditions, tire size, and cold tire inflation pressures specified on the Tire And Loading Information Placard ↪ page 141.

### NOTE:

Under a maximum loaded vehicle condition, Gross Axle Weight Ratings (GAWR) for the front and rear axles must not be exceeded ↪ page 141.

To determine the maximum loading conditions of your vehicle, locate the statement "The combined weight of occupants and cargo should never exceed XXX kg or XXX lbs" on the Tire And Loading Information Placard. The combined weight of occupants, cargo/luggage and trailer tongue weight (if applicable) should never exceed the weight referenced here.

## Steps For Determining Correct Load Limit—

- (1) Locate the statement “The combined weight of occupants and cargo should never exceed XXX kg or XXX lbs.” on your vehicle’s placard.
- (2) Determine the combined weight of the driver and passengers that will be riding in your vehicle.
- (3) Subtract the combined weight of the driver and passengers from XXX kg or XXX lbs.
- (4) The resulting figure equals the available amount of cargo and luggage load capacity. For example, if “XXX” amount equals 1400 lbs. and there will be five 150 lb passengers in your vehicle, the amount of available cargo and luggage load capacity is 650 lbs. (1400-750 (5x150) = 650 lbs.)

(5) Determine the combined weight of luggage and cargo being loaded on the vehicle. That weight may not safely exceed the available cargo and luggage load capacity calculated in Step 4.

(6) If your vehicle will be towing a trailer, load from your trailer will be transferred to your vehicle. Consult this manual to determine how this reduces the available cargo and luggage load capacity of your vehicle.

### Metric Example For Load Limit

For example, if “XXX” amount equals 635 kg and there will be five 68 kg passengers in your vehicle, the amount of available cargo and luggage load capacity is 295 kg (635-340 (5x68) = 295 kg) as shown in step 4.

### NOTE:

- If your vehicle will be towing a trailer, load from your trailer will be transferred to your vehicle. The following table shows examples on how to calculate total load, cargo/luggage, and towing capacities of your vehicle with varying seating configurations and number and size of occupants. This table is for illustration purposes only and may not be accurate for the seating and load carry capacity of your vehicle.
- For the following example, the combined weight of occupants and cargo should never exceed 865 lbs (392 kg).

Occupants			Combined weight of occupants and cargo from Tire Placard	MINUS	Combined Occupant's weight	=	AVAILABLE Cargo/Luggage and Trailer Tongue Weight
TOTAL	FRONT	REAR					
<b>EXAMPLE 1</b>			865 lbs	minus	670 lbs	=	195 lbs
5	2	3					
<b>EXAMPLE 2</b>			865 lbs	minus	540 lbs	=	325 lbs
3	2	1					
<b>EXAMPLE 3</b>			865 lbs	minus	400 lbs	=	465 lbs
2	2	0					

811a4d11

**WARNING!**

Overloading of your tires is dangerous. Overloading can cause tire failure, affect vehicle handling, and increase your stopping distance. Use tires of the recommended load capacity for your vehicle. Never overload them.



## TIRES — GENERAL INFORMATION

### Tire Pressure

Proper tire inflation pressure is essential to the safe and satisfactory operation of your vehicle. Four primary areas are affected by improper tire pressure:

- Safety
- Fuel Economy
- Tread Wear
- Ride Comfort and Vehicle Stability

### Safety

#### WARNING!

- Improperly inflated tires are dangerous and can cause collisions.
- Underinflation increases tire flexing and can result in overheating and tire failure.
- Overinflation reduces a tire's ability to cushion shock. Objects on the road and chuckholes can cause damage that result in tire failure.
- Overinflated or underinflated tires can affect vehicle handling and can fail suddenly, resulting in loss of vehicle control.
- Unequal tire pressures can cause steering problems. You could lose control of your vehicle.
- Unequal tire pressures from one side of the vehicle to the other can cause the vehicle to drift to the right or left.
- Always drive with each tire inflated to the recommended cold tire inflation pressure.

Both underinflation and overinflation affect the stability of the vehicle and can produce a feeling of sluggish response or over responsiveness in the steering.

#### NOTE:

- Unequal tire pressures from side to side may cause erratic and unpredictable steering response.
- Unequal tire pressure from side to side may cause the vehicle to drift left or right.

#### Fuel Economy

Underinflated tires will increase tire rolling resistance resulting in higher fuel consumption.

#### Tread Wear

Improper cold tire inflation pressures can cause abnormal wear patterns and reduced tread life, resulting in the need for earlier tire replacement.

#### Ride Comfort And Vehicle Stability

Proper tire inflation contributes to a comfortable ride. Overinflation produces a jarring and uncomfortable ride.

### Tire Inflation Pressures

The proper cold tire inflation pressure is listed on the driver's side B-pillar or rear edge of the driver's side door.

At least once a month:

- Check and adjust tire pressure with a good quality pocket-type pressure gauge. Do not make a visual judgment when determining proper inflation. Tires may look properly inflated even when they are underinflated.
- Inspect tires for signs of tire wear or visible damage.

#### CAUTION!

After inspecting or adjusting the tire pressure, always reinstall the valve stem cap. This will prevent moisture and dirt from entering the valve stem, which could damage the valve stem.

Inflation pressures specified on the placard are always "cold tire inflation pressure". Cold tire inflation pressure is defined as the tire pressure after the vehicle has not been driven for at least three hours, or driven less than 1 mile (1.6 km) after sitting for a minimum of three hours. The cold tire inflation pressure must not exceed the maximum inflation pressure molded into the tire sidewall.

Check tire pressures more often if subject to a wide range of outdoor temperatures, as tire pressures vary with temperature changes.

Tire pressures change by approximately 1 psi (7 kPa) per 12°F (7°C) of air temperature change. Keep this in mind when checking tire pressure inside a garage, especially in the Winter.

Example: If garage temperature = 68°F (20°C) and the outside temperature = 32°F (0°C) then the cold tire inflation pressure should be increased by 3 psi (21 kPa), which equals 1 psi (7 kPa) for every 12°F (7°C) for this outside temperature condition.

Tire pressure may increase from 2 to 6 psi (13 to 40 kPa) during operation. DO NOT reduce this normal pressure buildup or your tire pressure will be too low.

## Tire Pressures For High Speed Operation

The manufacturer advocates driving at safe speeds and within posted speed limits. Where speed limits or conditions are such that the vehicle can be driven at high speeds, maintaining correct tire inflation pressure is very important. Increased tire pressure and reduced vehicle loading may be required for high-speed vehicle operation. Refer to an authorized tire dealer or original equipment vehicle dealer for recommended safe operating speeds, loading and cold tire inflation pressures.

### WARNING!

High speed driving with your vehicle under maximum load is dangerous. The added strain on your tires could cause them to fail. You could have a serious collision. Do not drive a vehicle loaded to the maximum capacity at continuous speeds above 75 mph (120 km/h).

## Radial Ply Tires

### WARNING!

Combining radial ply tires with other types of tires on your vehicle will cause your vehicle to handle poorly. The instability could cause a collision. Always use radial ply tires in sets of four. Never combine them with other types of tires.

## Tire Repair

If your tire becomes damaged, it may be repaired if it meets the following criteria:

- The tire has not been driven on when flat.

- The damage is only on the tread section of your tire (sidewall damage is not repairable).
- The puncture is no greater than  $\frac{1}{4}$  of an inch (6 mm).

Consult an authorized tire dealer for tire repairs and additional information.

Damaged Run Flat tires, or Run Flat tires that have experienced a loss of pressure should be replaced immediately with another Run Flat tire of identical size and service description (Load Index and Speed Symbol). Replace the tire pressure sensor as well as it is not designed to be reused.

## Run Flat Tires — If Equipped

Run Flat tires allow you the capability to drive 50 miles (80 km) at 50 mph (80 km/h) after a rapid loss of inflation pressure. This rapid loss of inflation is referred to as the Run Flat mode. A Run Flat mode occurs when the tire inflation pressure is at or below 14 psi (96 kPa). Once a Run Flat tire reaches the Run Flat mode it has limited driving capabilities and needs to be replaced immediately. A Run Flat tire is not repairable. When a Run Flat tire is changed after being driven under a Run Flat mode 14 psi (96 kPa) condition, please replace the TPMS sensor as it is not designed to be reused.

### NOTE:

TPMS sensor must be replaced after driving the vehicle on a flat tire condition.

It is not recommended to drive a vehicle loaded at full capacity or to tow a trailer while a tire is in the Run Flat mode.

For more information ↗ page 179.

## Tire Spinning

When stuck in mud, sand, snow, or ice conditions, do not spin your vehicle's wheels above 30 mph (48 km/h) or for longer than 30 seconds continuously without stopping ↗ page 226.

### WARNING!

Fast spinning tires can be dangerous. Forces generated by excessive wheel speeds may cause tire damage or failure. A tire could explode and injure someone. Do not spin your vehicle's wheels faster than 30 mph (48 km/h) for more than 30 seconds continuously when you are stuck, and do not let anyone near a spinning wheel, no matter what the speed.

## Tread Wear Indicators

Tread wear indicators are in the original equipment tires to help you in determining when your tires should be replaced.



Tire Tread

These indicators are molded into the bottom of the tread grooves. They will appear as bands when the tread depth becomes  $\frac{1}{16}$  of an inch (1.6 mm). When the tread is worn to the tread wear indicators, the tire should be replaced ↪ page 265.

## Life Of Tire

The service life of a tire is dependent upon varying factors including, but not limited to:

- Driving style.
- Tire pressure - Improper cold tire inflation pressures can cause uneven wear patterns to develop across the tire tread. These abnormal wear patterns will reduce tread life, resulting in the need for earlier tire replacement.
- Distance driven.
- Performance tires, tires with a speed rating of V or higher, and Summer tires typically have a reduced tread life. Rotation of these tires per the vehicle scheduled maintenance is highly recommended.

### WARNING!

Tires and the spare tire should be replaced after six years, regardless of the remaining tread. Failure to follow this warning can result in sudden tire failure. You could lose control and have a collision resulting in serious injury or death.

### NOTE:

The Wheel Valve Stem must be replaced as well when installing new tires due to wear and tear in existing tires.

Keep dismantled tires in a cool, dry place with as little exposure to light as possible. Protect tires from contact with oil, grease, and gasoline.

## Replacement Tires

The tires on your new vehicle provide a balance of many characteristics. They should be inspected regularly for wear and correct cold tire inflation pressures. The manufacturer strongly recommends using tires equivalent to the originals in size, quality and performance when replacement is needed ↪ page 264. Refer to the Tire And Loading Information Placard or the Vehicle Certification Label for the size designation of your tire. The Load Index and Speed Symbol for your tire will be found on the original equipment tire sidewall.

For more information relating to the Load Index and Speed Symbol of a tire ↪ page 257.

It is recommended to replace the two front tires or two rear tires as a pair. Replacing just one tire can seriously affect your vehicle's handling. If you ever replace a wheel, make sure that the wheel's specifications match those of the original wheels.

It is recommended you contact an authorized tire dealer or original equipment dealer with any questions you may have on tire specifications or capability. Failure to use equivalent replacement tires may adversely affect the safety, handling, and ride of your vehicle.

### WARNING!

- Do not use a tire, wheel size, load rating, or speed rating other than that specified for your vehicle. Some combinations of unapproved tires and wheels may change suspension dimensions and performance characteristics, resulting in changes to steering, handling, and braking of your vehicle. This can cause unpredictable handling and stress to steering and suspension components. You could lose control and have a collision resulting in serious injury or death. Use only the tire and wheel sizes with load ratings approved for your vehicle.
- Never use a tire with a smaller Load Index or capacity other than what was originally equipped on your vehicle. Using a tire with a smaller Load Index could result in tire overloading and failure. You could lose control and have a collision.
- Failure to equip your vehicle with tires having adequate speed capability can result in sudden tire failure and loss of vehicle control.

### CAUTION!

Replacing original tires with tires of a different size may result in false speedometer and odometer readings.

## TIRE TYPES

### All Season Tires — If Equipped

All Season tires provide traction for all seasons (Spring, Summer, Autumn, and Winter). Traction levels may vary between different All Season tires. All Season tires can be identified by the M+S, M&S, M/S or MS designation on the tire sidewall. Use All Season tires only in sets of four; failure to do so may adversely affect the safety and handling of your vehicle.

### Summer Or Three Season Tires — If Equipped

Summer tires provide traction in both wet and dry conditions, and are not intended to be driven in snow or on ice. If your vehicle is equipped with Summer tires, be aware these tires are not designed for Winter or cold driving conditions. Install Winter tires on your vehicle when ambient temperatures are less than 40° F (5° C) or if roads are covered with ice or snow. For more information, contact an authorized dealer.

Summer tires do not contain the all season designation or mountain/snowflake symbol on the tire sidewall. Use Summer tires only in sets of four; failure to do so may adversely affect the safety and handling of your vehicle.

#### WARNING!

Do not use Summer tires in snow/ice conditions. You could lose vehicle control, resulting in severe injury or death. Driving too fast for conditions also creates the possibility of loss of vehicle control.

### Snow Tires



Some areas of the country require the use of snow tires during the Winter. Snow tires can be identified by a mountain/snowflake symbol on the tire sidewall.

If you need snow tires, select tires equivalent in size and type to the original equipment tires. Use snow tires only in sets of four; failure to do so may adversely affect the safety and handling of your vehicle.

Snow tires generally have lower speed ratings than what was originally equipped with your vehicle and should not be operated at sustained speeds over 75 mph (120 km/h). For speeds above 75 mph (120 km/h) refer to original equipment or an authorized tire dealer for recommended safe operating speeds, loading and cold tire inflation pressures.

While studded tires improve performance on ice, skid and traction capability on wet or dry surfaces may be poorer than that of non-studded tires. Some states prohibit studded tires; therefore, local laws should be checked before using these tire types.

## SPARE TIRES — IF EQUIPPED

#### NOTE:

For vehicles equipped with Tire Service Kit instead of a spare tire ↪ page 217.

#### CAUTION!

Because of the reduced ground clearance, do not take your vehicle through an automatic car wash with a compact or limited use temporary spare installed. Damage to the vehicle may result.

For restrictions when towing with a spare tire designated for temporary emergency use ↪ page 145.

### Spare Tire Matching Original Equipped Tire And Wheel — If Equipped

Your vehicle may be equipped with a spare tire and wheel equivalent in look and function to the original equipment tire and wheel found on the front or rear axle of your vehicle. This spare tire may be used in the tire rotation for your vehicle. If your vehicle has this option, refer to an authorized tire dealer for the recommended tire rotation pattern.

### Compact Spare Tire — If Equipped

The compact spare is for temporary emergency use only. You can identify if your vehicle is equipped with a compact spare by looking at the spare tire description on the Tire And Loading Information Placard located on the driver's side door opening or on the sidewall of the tire. Compact spare tire descriptions begin with the letter "T" or "S" preceding the size designation. Example: T145/80D18 103M.

T, S = Temporary Spare Tire

Since this tire has limited tread life, the original equipment tire should be repaired (or replaced) and reinstalled on your vehicle at the first opportunity.

Do not install a wheel cover or attempt to mount a conventional tire on the compact spare wheel, since the wheel is designed specifically for the compact spare tire. Do not install more than one compact spare tire and wheel on the vehicle at any given time.

**WARNING!**

Compact and collapsible spares are for temporary emergency use only. With these spares, do not drive more than 50 mph (80 km/h). Temporary use spares have limited tread life. When the tread is worn to the tread wear indicators, the temporary use spare tire needs to be replaced. Be sure to follow the warnings, which apply to your spare. Failure to do so could result in spare tire failure and loss of vehicle control.

**Full-Size Spare — If Equipped**

The Full-Size spare is for temporary emergency use only. This tire may look like the originally equipped tire on the front or rear axle of your vehicle, but it is not. This spare tire may have limited tread life. When the tread is worn to the tread wear indicators, the temporary use Full-Size spare tire needs to be replaced. Since it is not the same as your original equipment tire, replace (or repair) the original equipment tire and reinstall on the vehicle at the first opportunity.

**Limited Use Spare — If Equipped**

The limited use spare tire is for temporary emergency use only. This tire is identified by a label located on the limited use spare wheel. This label contains the driving limitations for this spare. This tire may look like the original equipped tire on the front or rear axle of your vehicle, but it is not. Installation of this limited use spare tire affects vehicle handling. Since it is not the same as your original equipment tire, replace (or repair) the original equipment tire and reinstall on the vehicle at the first opportunity.

**WARNING!**

Limited use spares are for emergency use only. Installation of this limited use spare tire affects vehicle handling. With this tire, do not drive more than the speed listed on the limited use spare wheel. Keep inflated to the cold tire inflation pressures listed on your Tire And Loading Information Placard located on the driver's side B-pillar or the rear edge of the driver's side door. Replace (or repair) the original equipment tire at the first opportunity and reinstall it on your vehicle. Failure to do so could result in loss of vehicle control.

**TIRE ROTATION RECOMMENDATIONS**

The tires on the front and rear of your vehicle operate at different loads and perform different steering, handling, and braking functions. For these reasons, they wear at unequal rates.

These effects can be reduced by timely rotation of tires. The benefits of rotation are especially worthwhile with aggressive tread designs such as those on On/Off Road type tires. Rotation will increase tread life, help to maintain mud, snow, and wet traction levels, and contribute to a smooth, quiet ride.

For the proper maintenance intervals → page 230. The reasons for any rapid or unusual wear should be corrected prior to rotation being performed.

The suggested rotation method is the "forward cross" shown in the following diagram. This rotation pattern does not apply to some directional tires that must not be reversed.

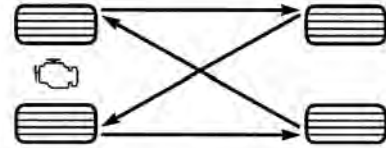

085707130

**Tire Rotation (Forward Cross)****CAUTION!**

Proper operation of four-wheel drive vehicles depends on tires of equal size, type and circumference on each wheel. Any difference in tire size can cause damage to the power transfer unit. Tire rotation schedule should be followed to balance tire wear.

## DEPARTMENT OF TRANSPORTATION UNIFORM TIRE QUALITY GRADES

The following tire grading categories were established by the National Highway Traffic Safety Administration. The specific grade rating assigned by the tire's manufacturer in each category is shown on the sidewall of the tires on your vehicle.

All passenger vehicle tires must conform to Federal safety requirements in addition to these grades.

### TREADWEAR

The Treadwear grade is a comparative rating, based on the wear rate of the tire when tested under controlled conditions on a specified government test course. For example, a tire graded 150 would wear one and one-half times as well on the government course as a tire graded 100. The relative performance of tires depends upon the actual conditions of their use, however, and may depart signifi-

cantly from the norm due to variations in driving habits, service practices, and differences in road characteristics and climate.

### TRACTION GRADES

The Traction grades, from highest to lowest, are AA, A, B, and C. These grades represent the tire's ability to stop on wet pavement, as measured under controlled conditions on specified government test surfaces of asphalt and concrete. A tire marked C may have poor traction performance.

#### WARNING!

The traction grade assigned to this tire is based on straight-ahead braking traction tests, and does not include acceleration, cornering, hydroplaning, or peak traction characteristics.

### TEMPERATURE GRADES

The Temperature grades are A (the highest), B, and C, representing the tire's resistance to the generation of heat and its ability to dissipate heat, when tested under controlled conditions on a specified indoor laboratory test wheel.

Sustained high temperature can cause the material of the tire to degenerate and reduce tire life, and excessive temperature can lead to sudden tire failure. The grade C corresponds to a level of performance, which all passenger vehicle tires must meet under the Federal Motor Vehicle Safety Standard No. 109. Grades B and A represent higher levels of performance on the laboratory test wheel, than the minimum required by law.

**WARNING!**

The temperature grade for this tire is established for a tire that is properly inflated and not overloaded. Excessive speed, underinflation, or excessive loading, either separately or in combination, can cause heat buildup and possible tire failure.

**STORING THE VEHICLE — GAS**

If you are storing your vehicle for more than three weeks, we recommend that you take the following steps to minimize the drain on your vehicle's battery:

- Disconnect the negative cable from battery.
- If your vehicle is equipped with Stop/Start system then disconnect both the main and supplemental negative battery cables.
- Any time you store your vehicle or keep it out of service (i.e., vacation) for two weeks or more, run the air conditioning system at idle for about five minutes in the fresh air and high blower setting. This will ensure adequate system lubrication to minimize the possibility of compressor damage when the system is started again.
- If assistance is needed to disconnect the battery system, see an authorized dealer

**NOTE:**

When the vehicle has not been started or driven for at least 30 days, an "Extended Park Starting Procedure" is required to start the vehicle ↪ page 98.

**CAUTION!**

Before removal of the positive and negative terminals to the battery, wait at least a minute with ignition switch in the OFF position and close the driver's door. When reconnecting the positive and negative terminals to the battery be sure the ignition switch is in the OFF position and the driver's door is closed.

**STORING THE VEHICLE — PHEV**

If the vehicle should remain stationary for more than a month, observe the following precautions:

- Park your vehicle in a covered, dry and possibly airy location with the windows open slightly.
- Check that the parking brake is not engaged.
- Disconnect the negative (-) terminal from the battery post and be sure that the battery is fully charged. During storage check battery charge quarterly.

**NOTE:**

Disconnecting the 12 Volt battery will prevent the High Voltage (HV) battery from accepting a charge from the Electric Vehicle Supply Equipment (EVSE). Also, the vehicle will not condition the HV battery (if needed and connected to a powered EVSE). If the HV battery is not able to condition itself and it becomes cold enough (or hot enough), the vehicle will not start until the HV battery's cell temperatures are between -22°F (-30°C) and 122°F (50°C).

- If you do not disconnect the battery from the electrical system, check the battery charge every 30 days.
- Whenever you leave the vehicle stationary for two weeks or more, idle the vehicle for approximately five minutes, with the air conditioning system on and high fan speed. This will ensure proper lubrication of the system, thus minimizing the possibility of damage to the compressor when the vehicle is put back into operation.
- Plug in the vehicle when not using it whenever possible.

**NOTE:**

The hybrid has a feature of periodic wake-up that occurs every three weeks. This feature charges the 12 Volt battery from the HV battery. This will happen as long as the HV battery remains above the minimum state of charge ↪ page 100.

**CAUTION!**

Before removal of the positive and negative terminals to the battery, wait at least a minute with ignition switch in the OFF position and close the driver's door. When reconnecting the positive and negative terminals to the battery be sure the ignition switch is in the OFF position and the driver's door is closed.

## BODYWORK

### PROTECTION FROM ATMOSPHERIC AGENTS

Vehicle body care requirements vary according to geographic locations and usage. Chemicals that make roads passable in snow and ice and those that are sprayed on trees and road surfaces during other seasons are highly corrosive to the metal in your vehicle. Outside parking, which exposes your vehicle to airborne contaminants, road surfaces on which the vehicle is operated, extreme hot or cold weather and other extreme conditions will have an adverse effect on paint, metal trim, and underbody protection.

The following maintenance recommendations will enable you to obtain maximum benefit from the corrosion resistance built into your vehicle.

#### What Causes Corrosion?

Corrosion is the result of deterioration or removal of paint and protective coatings from your vehicle.

The most common causes are:

- Road salt, dirt and moisture accumulation.
- Stone and gravel impact.
- Insects, tree sap and tar.
- Salt in the air near seacoast localities.
- Atmospheric fallout/industrial pollutants.

## BODY AND UNDERBODY MAINTENANCE

### Wheel And Wheel Trim Care

All wheels and wheel trim, especially aluminum and chrome plated wheels, should be cleaned regularly using mild (neutral Ph) soap and water to maintain their luster and to prevent corrosion. Wash wheels with the same soap solution recommended for the body of the vehicle and remember to always wash when the surfaces are not hot to the touch.

Your wheels are susceptible to deterioration caused by salt, sodium chloride, magnesium chloride, calcium chloride, etc., and other road chemicals used to melt ice or control dust on dirt roads. Use a soft cloth or sponge and mild soap to wipe away promptly. Do not use harsh chemicals or a stiff brush. They can damage the wheel's protective coating that helps keep them from corroding and tarnishing.

#### CAUTION!

Avoid products or automatic car washes that use acidic solutions or strong alkaline additives or harsh brushes. Many aftermarket wheel cleaners and automatic car washes may damage the wheel's protective finish. Such damage is not covered by the New Vehicle Limited Warranty. Only car wash soap is recommended.

When cleaning extremely dirty wheels including excessive brake dust, care must be taken in the selection of tire and wheel cleaning chemicals and equipment to prevent damage to the wheels. Select a non-abrasive, non-acidic cleaner for aluminum or chrome wheels.

#### CAUTION!

Do not use scouring pads, steel wool, a bristle brush, metal polishes or oven cleaner. These products may damage the wheel's protective finish. Such damage is not covered by the New Vehicle Limited Warranty. Only car wash soap is recommended.

#### NOTE:

If you intend parking or storing your vehicle for an extended period after cleaning the wheels with wheel cleaner, drive your vehicle and apply the brakes to remove the water droplets from the brake components. This activity will remove the red rust on the brake rotors and prevent vehicle vibration when braking.

#### Dark Or Low Gloss Wheels

#### CAUTION!

If your vehicle is equipped with these specialty wheels, DO NOT USE wheel cleaners, abrasives, or polishing compounds. They will permanently damage this finish and such damage is not covered by the New Vehicle Limited Warranty. HAND WASH ONLY USING MILD SOAP AND WATER WITH A SOFT CLOTH. Used on a regular basis; this is all that is required to maintain this finish.



## Cleaning Headlights

Your vehicle is equipped with plastic headlights and fog lights that are lighter and less susceptible to stone breakage than glass headlights.

Plastic is not as scratch resistant as glass and therefore different lens cleaning procedures must be followed.

To minimize the possibility of scratching the lenses and reducing light output, avoid wiping with a dry cloth. To remove road dirt, wash with a mild soap solution followed by rinsing.

Do not use abrasive cleaning components, solvents, steel wool or other aggressive material to clean the lenses.

## PRESERVING THE BODYWORK

### Washing

- Wash your vehicle regularly. Always wash your vehicle in the shade using Mopar® Car Wash, or a mild car wash soap, and rinse the panels completely with water.
- If insects, tar, or other similar deposits have accumulated on your vehicle, use Mopar® Super Kleen Bug and Tar Remover to remove.
- Use a high quality cleaner wax, such as Mopar® Cleaner Wax to remove road film, stains and to protect your paint finish. Use precautions to not scratch the paint.
- Avoid using abrasive compounds and power buffing that may diminish the gloss or thin out the paint finish.

### NOTE:

When using an automatic car wash with your hybrid vehicle, do not exceed four passengers plus 88lb (40kg) when you are at full payload, as this could cause interference with the car wash mechanism.

### CAUTION!

- Do not use abrasive or strong cleaning materials such as steel wool or scouring powder that will scratch metal and painted surfaces.
- Use of power washers exceeding 1,200 psi (8,274 kPa) can result in damage or removal of paint and decals.

## Special Care

- If you drive on salted or dusty roads or if you drive near the ocean, hose off the undercarriage at least once a month.
- It is important that the drain holes in the lower edges of the doors, rocker panels, and trunk be kept clear and open.
- If you detect any stone chips or scratches in the paint, touch them up immediately.
- If your vehicle is damaged due to a collision or similar cause that destroys the paint and protective coating, have your vehicle repaired as soon as possible.
- If you carry special cargo such as chemicals, fertilizers, de-icer salt, etc., be sure that such materials are well packaged and sealed.
- If a lot of driving is done on gravel roads, consider mud or stone shields behind each wheel.

- Use Mopar® Touch Up Paint on scratches as soon as possible. An authorized dealer has touch up paint to match the color of your vehicle.

## INTERIORS

### SEATS AND FABRIC PARTS

Use Mopar® Total Clean to clean fabric upholstery and carpeting.

### WARNING!

Do not use volatile solvents for cleaning purposes. Many are potentially flammable, and if used in closed areas they may cause respiratory harm.

### Stain Repel Fabric Cleaning Procedure — If Equipped

Stain Repel seats may be cleaned in the following manner:

- Remove as much of the stain as possible by blotting with a clean, dry towel.
- Blot any remaining stain with a clean, damp towel.
- For tough stains, apply Mopar® Total Clean, or a mild soap solution to a clean, damp cloth and remove stain. Use a fresh, damp towel to remove soap residue.
- For grease stains, apply Mopar® Multi-Purpose Cleaner to a clean, damp cloth and remove stain. Use a fresh, damp towel to remove soap residue.
- Do not use any harsh solvents or any other form of protectants on Stain Repel products.

## Seat Belt Maintenance

Do not bleach, dye or clean the belts with chemical solvents or abrasive cleaners. This will weaken the fabric.

If the belts need cleaning, use a mild soap solution or lukewarm water. Do not remove the belts from the vehicle to wash them. Dry with a soft cloth.

Sun damage can also weaken the fabric. Replace the belts if they appear frayed or worn or if the buckles do not work properly.

### WARNING!

A frayed or torn seat belt could rip apart in a collision and leave you with no protection. Inspect the seat belt system periodically, checking for cuts, frays, or loose parts. Damaged parts must be replaced immediately. Do not disassemble or modify the seat belt system. If your vehicle is involved in a collision, or if you have questions regarding seat belt or retractor conditions, take your vehicle to an authorized FCA dealer or authorized FCA Certified Collision Care Program facility for inspection.

## PLASTIC AND COATED PARTS

Use Mopar® Total Clean to clean vinyl upholstery.

### CAUTION!

- Direct contact of air fresheners, insect repellents, suntan lotions, or hand sanitizers to the plastic, painted, or decorated surfaces of the interior may cause permanent damage. Wipe away immediately.

*(Continued)*

### CAUTION!

- Damage caused by these type of products may not be covered by your New Vehicle Limited Warranty.

## Cleaning Plastic Instrument Cluster Lenses

The lenses in front of the instruments in this vehicle are molded in clear plastic. When cleaning the lenses, care must be taken to avoid scratching the plastic.

Clean with a wet soft cloth. A mild soap solution may be used, but do not use high alcohol content or abrasive cleaners. If soap is used, wipe clean with a clean damp cloth. Dry with a soft cloth.

## LEATHER SURFACES

Mopar® Total Clean is specifically recommended for leather upholstery.

Your leather upholstery can be best preserved by regular cleaning with a damp soft cloth. Small particles of dirt can act as an abrasive and damage the leather upholstery and should be removed promptly with a damp cloth. Stubborn soils can be removed easily with a soft cloth and Mopar® Total Clean. Care should be taken to avoid soaking your leather upholstery with any liquid. Please do not use polishes, oils, cleaning fluids, solvents, detergents, or ammonia-based cleaners to clean your leather upholstery.

### NOTE:

If equipped with light colored leather, it tends to show any foreign material, dirt, and fabric dye transfer more so than darker colors. The leather is designed for easy cleaning, and the manufacturer recommends Mopar® total care leather cleaner applied on a cloth to clean the leather seats as needed.

### CAUTION!

Do not use alcohol and alcohol-based and/or ketone-based cleaning products to clean leather upholstery, as damage to the upholstery may result.

## GLASS SURFACES

All glass surfaces should be cleaned on a regular basis with Mopar® Glass Cleaner, or any commercial household-type glass cleaner. Never use an abrasive type cleaner. Use caution when cleaning the inside rear window equipped with electric defrosters or windows equipped with radio antennas. Do not use scrapers or other sharp instruments that may scratch the elements.

When cleaning the rearview mirror, spray cleaner on the towel or cloth that you are using. Do not spray cleaner directly on the mirror.

# TECHNICAL SPECIFICATIONS

## VEHICLE IDENTIFICATION NUMBER (VIN)

The VIN is found on the left front corner of the windshield and is visible from outside of the vehicle.



B062400003RUS

Vehicle Identification Number

### NOTE:

It is illegal to remove or alter the VIN.

## BRAKE SYSTEM

Your vehicle is equipped with power assisted brakes as standard equipment. In the event power assist is lost for any reason (for example, repeated brake applications with the engine off), the brakes will still function. However, the effort required to brake the vehicle will be much greater than that required with the power system operating.

If either of the two hydraulic systems lose normal capability, the remaining system will still function with some loss of overall braking effectiveness. This will be evident by increased pedal travel during application and greater pedal force required to slow or stop. In addition, if the malfunction is caused by an internal leak, as the brake fluid in the master cylinder drops, the Brake Warning Light will illuminate.

### WARNING!

Driving a vehicle with the Brake Warning Light on is dangerous. A significant decrease in braking performance or vehicle stability during braking may occur. It will take you longer to stop the vehicle or will make your vehicle harder to control. You could have a collision. Have the vehicle checked immediately.

## WHEEL AND TIRE TORQUE SPECIFICATIONS

Proper lug nut/bolt torque is very important to ensure that the wheel is properly mounted to the vehicle. Any time a wheel has been removed and reinstalled on the vehicle, the lug nuts/bolts should be torqued using a properly calibrated torque wrench using a six-sided (hex) deep wall socket.

## TORQUE SPECIFICATIONS

Lug Nut/Bolt Torque	**Lug Nut/Bolt Size	Lug Nut/Bolt Socket Size
88.5 ft-lb (120 N·m)	M12 x 1.25	17 mm

\*\*Use only authorized dealer recommended lug nuts/bolts and clean or remove any dirt or oil before tightening.

Inspect the wheel mounting surface prior to mounting the tire and remove any corrosion or loose particles.



B091000007US

Wheel Mounting Surface

First tighten the lug nuts/bolts in a star pattern until each nut/bolt has been tightened to 14.7 ft-lb (20 N·m). Then repeat the operation until each lug nut/bolt has been tightened to 88.5 ft-lb (120 N·m). Ensure that the socket is fully engaged on the lug nut/bolt (do not insert it halfway).



B0901000080US

**Torque Pattern**

After 25 miles (40 km), check the lug nut/bolt torque to be sure that all the lug nuts/bolts are properly tightened.

**WARNING!**

To avoid the risk of forcing the vehicle off the jack, do not tighten the lug nuts/bolts fully until the vehicle has been lowered. Failure to follow this warning may result in personal injury.

**FUEL REQUIREMENTS**

While operating on gasoline with the required octane number, hearing a light knocking sound from the engine is not a cause for concern. However, if the engine is heard making a heavy knocking sound, see a dealer immediately. Use of gasoline with a lower than recommended octane number can cause engine failure and may void or not be covered by the New Vehicle Limited Warranty.

**1.3L ENGINE**

This engine is designed to meet all emission regulations, and provide satisfactory fuel economy and performance, when using high-quality unleaded regular gasoline having an octane rating of 87, as specified by the (R+M)/2 Method.

The use of a 91 or higher octane premium gasoline will allow these engines to operate to optimal performance. This increase in performance is most noticeable in hot weather or other heavier load conditions, such as towing.

**2.0L ENGINE**

This engine is designed to meet all emissions requirements, and provide satisfactory fuel economy and performance, when using high-quality unleaded regular gasoline having an octane rating of 87, as specified by the (R+M)/2 method. The use of 91 or higher octane premium gasoline will allow these engines to operate to optimal performance. This increase in performance is most noticeable in hot weather or under heavy load conditions such as while towing.

**REFORMULATED GASOLINE**

Many areas of the country require the use of cleaner-burning gasoline referred to as "reformulated gasoline". Reformulated gasoline contains oxygenates and are specifically blended to reduce vehicle emissions and improve air quality.

The use of reformulated gasoline is recommended. Properly blended reformulated gasoline will provide improved performance and durability of engine and fuel system components.

**GASOLINE/OXYGENATE BLENDS**

Some fuel suppliers blend unleaded gasoline with oxygenates such as ethanol.

**CAUTION!**

DO NOT use E-85, gasoline containing methanol, or gasoline containing more than 15% ethanol (E-15). Use of these blends may result in starting and drivability problems, damage critical fuel system components, cause emissions to exceed the applicable standard, and/or cause the Malfunction Indicator Light to illuminate. Please observe pump labels as they should clearly communicate if a fuel contains greater than 15% ethanol (E-15).

Problems that result from using gasoline containing more than 15% ethanol (E-15) or gasoline containing methanol are not the responsibility of the manufacturer and may void the New Vehicle Limited Warranty.

**E-85 USAGE IN NON-FLEX FUEL VEHICLES**

Non-Flex Fuel Vehicles (FFV) are compatible with gasoline containing up to 15% ethanol (E-15). Gasoline with higher ethanol content may void the New Vehicle Limited Warranty.

If a Non-FFV vehicle is inadvertently fueled with E-85 fuel, the engine will have some or all of these symptoms:

- Operate in a lean mode.
- OBD II Malfunction Indicator Light on.
- Poor engine performance.
- Poor cold start and cold drivability.
- Increased risk for fuel system component corrosion.

## CNG AND LP FUEL SYSTEM MODIFICATIONS

Modifications that allow the engine to run on Compressed Natural Gas (CNG) or Liquid Propane (LP) may result in damage to the engine, emissions, and fuel system components. Problems that result from running CNG or LP are not the responsibility of the manufacturer and may void the New Vehicle Limited Warranty.

## METHYLCYCLOPENTADIENYL MANGANESE TRICARBONYL (MMT) IN GASOLINE

MMT is a manganese-containing metallic additive that is blended into some gasolines to increase octane. Gasoline blended with MMT provides no performance advantage beyond gasoline of the same octane number without MMT. Gasoline blended with MMT reduces spark plug life and reduces emissions system performance in some vehicles. The manufacturer recommends that gasoline without MMT be used in your vehicle. The MMT content of gasoline may not be indicated on the gasoline pump, therefore, you should ask the gasoline retailer whether or not his/her gasoline contains MMT. MMT is prohibited in Federal and California reformulated gasoline.

## MATERIALS ADDED TO FUEL

Besides using unleaded gasoline with the proper octane rating, gasolines that contain detergents, corrosion and stability additives are recommended. Using gasolines that have these additives will help improve fuel economy, reduce emissions, and maintain vehicle performance.



Designated TOP TIER Detergent Gasoline contains a higher level of detergents to further aide in minimizing engine and fuel system deposits. When available, the usage of TOP TIER Detergent gasoline is recommended. Visit [www.toptiergas.com](http://www.toptiergas.com) for a list of TOP TIER Detergent Gasoline retailers.

Indiscriminate use of fuel system cleaning agents should be avoided. Many of these materials intended for gum and varnish removal may contain active solvents or similar ingredients. These can harm fuel system gasket and diaphragm materials.

## FUEL SYSTEM CAUTIONS

### CAUTION!

Follow these guidelines to maintain your vehicle's performance:

- The use of leaded gasoline is prohibited by Federal law. Using leaded gasoline can impair engine performance and damage the emissions control system.
- An out-of-tune engine or certain fuel or ignition malfunctions can cause the catalytic converter to overheat. If you notice a pungent burning odor or some light smoke, your engine may be out of tune or malfunctioning and may require immediate service. Contact an authorized dealer for service assistance.
- The use of fuel additives, which are now being sold as octane enhancers, is not recommended. Most of these products contain high concentrations of methanol. Fuel system damage or vehicle performance problems resulting from the use of such fuels or additives is not the responsibility of the manufacturer and may void or not be covered under the New Vehicle Limited Warranty.

### NOTE:

Intentional tampering with the emissions control system can result in civil penalties being assessed against you.

## FLUID CAPACITIES

	US	Metric
<b>Fuel (Approximate)</b>		
2.0L Engine	13.5 gal	51 L
1.3L Engine	11.2 gal	42.5L
<b>Engine Oil With Filter</b>		
1.3L Engine	5 qt	4.74 L
2.0L Engine	5 qt	4.73 L
<b>Cooling System*</b>		
1.3L Engine	5.9 qt	5.6 L
1.3L Battery/Power Electronics Coolant (Contact an authorized dealer for service)	7.4 qt	7.0 L
2.0L Engine	7 qt	6.6 L
2.0L Engine Low Temp	2.3 qt	2.17 L
* Includes heater and coolant recovery bottle filled to MAX level.		

## ENGINE FLUIDS AND LUBRICANTS

Component	Fluid, Lubricant, or Genuine Part
Engine, Battery, and Power Electric Coolant	We recommend using Mopar® Antifreeze/Coolant 10 Year/150,000 Miles (240,000 Kilometers) Formula OAT (Organic Additive Technology) meeting the requirements of the manufacturer Material Standard MS.90032.
Engine Oil – 1.3L Engine	We recommend using Mopar® SAE 0W-30 Full Synthetic Engine Oil which meets the requirements of the manufacturer Material Standard MS-13340. Equivalent full synthetic SAE 0W-30 engine oil can be used but must have the API Starburst trademark ↪ page 235.
Engine Oil – 2.0L Engine	We recommend using Mopar® API SP/GF-6A Certified SAE 5W-30 Full Synthetic Engine Oil which meets the requirements of the manufacturer Material Standard MS-13340. Equivalent full synthetic 5W-30 API SP engine oil can be used but must have the API Donut trademark ↪ page 235.
	<b>CAUTION!</b> <b>Failure to use the recommended API SP/GF-6A or equivalent oil can cause engine damage not covered by the vehicle warranty.</b>
Fuel Selection – 1.3L Engine	87 Octane (R+M)/2 Method, 0-15% ethanol.
Fuel Selection – 2.0L Engine	87 Octane (R+M)/2 Method, 0-15% ethanol.

## CHASSIS FLUIDS AND LUBRICANTS

Component	Fluid, Lubricant, or Genuine Part
6-Speed Automatic Transmission PHEV – If Equipped	Use only Mopar® AW-1 Automatic Transmission Fluid, or equivalent. Failure to use the correct fluid may affect the function or performance of your transmission.
9-Speed Automatic Transmission Gas – If Equipped	Use only Mopar® ZF 8 & 9 Speed ATF Automatic Transmission Fluid, or equivalent. Failure to use the correct fluid may affect the function or performance of your transmission.
Power Transfer Unit (PTU) – If Equipped	We recommend using Mopar® Front Axle/PTU Synthetic Axle Lubricant SAE 75W-90 (API GL-5).
Rear Differential (RDM) – If Equipped	We recommend using Mopar® Rear Axle/RDM Synthetic Axle Lubricant SAE 75W-90 (API GL-5).
Brake Master Cylinder	We recommend using Mopar® DOT 4 (TUTELA TOP EVO).

# CUSTOMER ASSISTANCE

## SUGGESTIONS FOR OBTAINING SERVICE FOR YOUR VEHICLE

### PREPARE FOR THE APPOINTMENT

All work to be performed may not be covered by the warranty. Discuss additional charges with the service manager. Keep a maintenance log of your vehicle's service history. This can often provide a clue to the current problem.

### PREPARE A LIST

Make a written list of your vehicle's problems or the specific work you want done. If you've had an accident or work done that is not on your maintenance log, let the service advisor know.

### BE REASONABLE WITH REQUESTS

If you list a number of items and you must have your vehicle by the end of the day, discuss the situation with the service advisor and list the items in order of priority. At many authorized dealers, you may obtain a rental vehicle (additional charges may apply). If you need a rental, it is advisable to make these arrangements when you call for an appointment.

## IF YOU NEED ASSISTANCE

FCA US LLC and its authorized dealers are vitally interested in your satisfaction. We want you to be happy with our products and services.

Warranty service must be done by an authorized dealer. We strongly recommend that you take the vehicle to an authorized dealer. They know your vehicle the best, and are most concerned that you get prompt and high quality service. FCA US LLC's authorized dealers have the facilities, factory-trained technicians, special tools, and the latest information to ensure the vehicle is fixed correctly and in a timely manner.

This is why you should always talk to an authorized dealer's service manager first. If for some reason you are still not satisfied, talk to the general manager or owner of the authorized dealer. They want to know if you need assistance. If an authorized dealer is unable to resolve the concern, you may contact FCA US LLC's Customer Assistance center.

Any communication to FCA US LLC's customer center should include the following information:

- Owner's name and address
- Owner's telephone number (home, mobile, and office)
- Authorized dealer name
- Vehicle Identification Number (VIN)
- Vehicle delivery date and mileage

## ROADSIDE ASSISTANCE

Available 24 hours, 7 days a week.

Call 1-855-299-1368 or visit [alfaromeo.rsahelp.com](http://alfaromeo.rsahelp.com) (USA)

Call 1-800-363-4869 or visit [fca.roadsideaid.com](http://fca.roadsideaid.com) (Canada)

### Who is Covered

You are covered by Roadside Assistance services if you are a purchaser for use of the vehicle. Roadside Assistance services last for four years, regardless of mileage, calculated from the start date of the Basic Limited Warranty, as set forth in Warranty Information book.<sup>1</sup>

1. Towing services provided through Cross Country Motor Club, Inc., Medford, MA 02155, except in AK, CA, HI, OR, WI, and WY, where services are provided by Cross Country Motor Club of California, Inc., Thousand Oaks, CA 91360.

### What to Do

If your vehicle requires jump start assistance, out of gas/fuel delivery, tire service, lockout service or towing as a result of a mechanical breakdown, dial toll-free: USA: 1-855-299-1368/Canada: 1-800-363-4869. Provide your name, Vehicle Identification Number (VIN) required for covered services, license plate number, and your location, including the telephone number from which you are calling. Briefly describe the nature of the problem and answer a few simple questions. You will be given the name of the service provider and an estimated time of arrival. If you feel you are in an "unsafe situation", please let us know. With your consent, we will contact local police or safety authorities.



**If Unable to Contact Roadside Assistance**

If you are unable to contact Roadside Assistance or unable to provide a valid Vehicle Identification Number (VIN), and you obtain towing services on your own, you may submit your original receipts from the licensed towing or service facility for services rendered within 30 days of the occurrence. Be sure to include your VIN, odometer mileage at the time of service, and current mailing address. We will process the claim based on vehicle and service eligibility. If eligible, we will reimburse you for the reasonable amount actually paid, based on the usual and customary charges for that service in the area where they were provided. FCA US LLC's determination relating to reimbursement is final. Correspondence should be mailed to:

FCA US LLC Customer Assistance

P.O. Box 9145

Medford, MA 02155

Attention Claims Department

FCA US LLC reserves the right to modify the terms or discontinue the Roadside Assistance Program at any time. The Roadside Assistance Program is subject to restrictions and conditions of use, which are determined solely by FCA US LLC.

**Flat Tire Service**

If you are inconvenienced by a flat tire, we will dispatch a service provider to install your vehicle's temporary spare tire (if equipped) as recommended in your Owner's Manual. This is not a permanent flat tire repair.

**Out of Gas/Fuel Delivery**

Drivers cannot always count on a gas station being nearby, especially when traveling away from home. We will dispatch a service provider to deliver a small

amount of fuel (maximum two gallons) to get you to a nearby station. This service is limited to two occurrences in a 12-month period.

**Battery Jump Assistance**

No time is a good time for a depleted battery. With Roadside Assistance, you do not have to worry about being stranded. We will dispatch a service provider to provide you with a battery jump anytime, day or night.

**Lockout Service**

Whether the keys are locked in your vehicle or frozen locks are keeping you from getting on your way, help is just a phone call away. This service is limited to providing access to the vehicle's seating area. It does not cover the cost of replacement keys.

**Towing Service**

Our towing service gives you peace of mind and confidence. If your vehicle becomes disabled as a result of a mechanical breakdown, Roadside Assistance will dispatch a towing service to transport your vehicle to the closest authorized Alfa Romeo dealer.

**FCA US LLC CUSTOMER CENTER**

P.O. Box 21-8004

Auburn Hills, MI 48321-8004

Phone: 1-844-Alfa-USA (1-844-253-2872)

**FCA CANADA INC. CUSTOMER CARE**

P.O. Box 1621

Windsor, Ontario N9A 4H6

Phone: (800) 465-2001 English/(800) 387-9983 French

**ALFA ROMEO CUSTOMER CARE (PUERTO RICO AND US VIRGIN ISLANDS)**

P.O. Box 191857

San Juan, Puerto Rico 00919-1857

Phone: 844-253-2872

**MEXICO**

Av. Prolongacion Paseo de la Reforma, 1240

Sante Fe C.P. 05109

Mexico, CDMX

In Mexico City: (800) 505-1300

Outside Mexico City: +(52) 55 50817568

**PUERTO RICO AND US VIRGIN ISLANDS**

FCA Caribbean LLC

P.O. Box 191857

San Juan, Puerto Rico, 00919-1857

Phone: 1-844-Alfa-USA (1-844-253-2872)

**CUSTOMER ASSISTANCE FOR THE HEARING OR SPEECH IMPAIRED (TDD/TTY)**

To assist customers who have hearing difficulties, FCA US LLC has installed special Telecommunication Devices for the Deaf (TDD) equipment at its customer center. Any hearing or speech impaired customer, who has access to a TDD or a Conventional Teletypewriter (TTY) in the United States, can communicate with FCA US LLC by dialing 1-800-380-2479.

Canadian residents with hearing difficulties that require assistance can use the special needs relay service offered by Bell Canada. For TTY teletypewriter users, dial 711 and for Voice callers, dial 1-800-855-0511 to connect with a Bell Relay Service operator.

## SERVICE CONTRACT

You may have purchased a service contract for a vehicle to help protect you from the high cost of unexpected repairs after FCA US LLC's New Vehicle Limited Warranty expires. The Mopar® Vehicle Protection plans are the ONLY vehicle extended protection plans authorized, endorsed and backed by FCA US LLC to provide additional protection beyond your vehicle's warranty. If you purchased a Mopar® Vehicle Protection Plan, you will receive Plan Provisions and an Owner Identification Card in the mail within three weeks of the vehicle delivery date. If you have any questions about the service contract, call FCA US LLC's Service Contract National Customer Hotline at 1-800-521-9922.

For Canadian residents, you may have purchased additional coverage with an extended service contract. FCA Canada Inc. stands fully behind its service contracts. Be sure that the one you buy is a genuine Canada Inc. service contract. We are not responsible for other companies' contracts. If you purchased a contract other than a genuine FCA Canada Inc. service contract and you have a problem, you will have to contact the administrator of that contract for resolution. If you have any questions about the service contract, call the FCA's Service Contract National Customer Hotline at (800) 465-2001 English / (800) 387-9983 French).

Mopar Vehicle Protection Plans offer valuable protection against repair costs after your vehicle warranties have expired. Mopar Vehicle Protection plans are the

ONLY vehicle extended protection plans authorized, endorsed and backed by FCA US LLC to provide additional protection beyond your vehicle's warranty.

FCA US LLC is not responsible for any service contract you may have purchased from another manufacturer. If you require service after the FCA US LLC New Vehicle Limited Warranty expires, please refer to the contract documents, and contact the person listed in those documents.

We appreciate that you have made a major investment when you purchased the vehicle. An authorized dealer has also made a major investment in facilities, tools, and training to assure that you are absolutely delighted with the ownership experience.

## WARRANTY INFORMATION

See the Warranty Information for the terms and provisions of FCA US LLC warranties applicable to this vehicle and market. Refer to [www.alfaromeousa.com/owners](http://www.alfaromeousa.com/owners) for further information.

In Canada:

See the Warranty Information for the terms and provisions of FCA Canada Inc. warranties applicable to this vehicle and market. Refer to [www.alfaromeo.ca/en/my-alfa](http://www.alfaromeo.ca/en/my-alfa) for further information.

For french-speaking citizens, please refer to [www.alfaromeo.ca/fr/mon-alfa](http://www.alfaromeo.ca/fr/mon-alfa) for further information.

**Use this QR code to access your digital experience.**



## MOPAR® PARTS

Mopar® original equipment parts & accessories and factory filled fluids are available from an authorized dealer. They are recommended for your vehicle to keep it operating at its best and maintain its original condition.

## REPORTING SAFETY DEFECTS

### IN THE 50 UNITED STATES AND WASHINGTON, D.C.

If you believe that your vehicle has a defect that could cause a crash or cause injury or death, you should immediately inform the National Highway Traffic Safety Administration (NHTSA) in addition to notifying FCA US LLC.

If NHTSA receives similar complaints, it may open an investigation, and if it finds that a safety defect exists in a group of vehicles, it may order a recall and remedy campaign. However, NHTSA cannot become involved in individual problems between you, an authorized dealer, or FCA US LLC.

To contact NHTSA, you may call the Vehicle Safety Hotline toll free at 1-888-327-4236 (TTY: 1-800-424-9153); or go to <http://www.safercar.gov>; or write to: Administrator, NHTSA, 1200 New Jersey Avenue, SE., West Building, Washington, D.C. 20590. You can also obtain other information about motor vehicle safety from <http://www.safercar.gov>.

## IN CANADA

If you believe that your vehicle has a safety defect, you should contact the Customer Service Department immediately. Canadian customers who wish to report a safety defect to the Canadian government should contact Transport Canada, Motor Vehicle Defect Investigations and Recalls at 1-800-333-0510 or go to [www.apps.tc.gc.ca/Saf-Sec-Sur/7/PCDB-BDPP](http://www.apps.tc.gc.ca/Saf-Sec-Sur/7/PCDB-BDPP).

## ORDERING AND ACCESSING ADDITIONAL OWNER'S INFORMATION

To order the following manuals, you may use either the website or the phone numbers listed below.

### Service Manuals

These comprehensive Service Manuals provide a complete working knowledge of the vehicle, system, and/or components and is written in straightforward language with illustrations, diagrams, and charts.

### Diagnostic Procedure Manuals

Diagnostic Procedure Manuals are filled with diagrams, charts and detailed illustrations. These manuals make it easy to find and fix problems on computer-controlled vehicle systems and features. They show exactly how to find and correct problems, using step-by-step troubleshooting and drivability procedures, proven diagnostic tests and a complete list of all tools and equipment.

To order a digital copy of your Service or Diagnostic Procedure manuals, visit:

[www.techauthority.com](http://www.techauthority.com) (US and Canada).

### Owner's Manuals

These Owner's Manuals have been prepared with the assistance of service and engineering specialists to acquaint you with specific FCA vehicles.

To access your Owner's Information online, visit [www.alfaromeousa.com/owners/owners-service-manual](http://www.alfaromeousa.com/owners/owners-service-manual) (US) or [www.alfaromeo.ca/en/owners/owners-service-manual](http://www.alfaromeo.ca/en/owners/owners-service-manual) (Canada).

Or visit:

[www.techauthority.com](http://www.techauthority.com) to order physical copies of Owner's Manuals (US).

Owner's Manuals, Radio Manuals and Warranty Information Books can be ordered through Archway at:

- 1-800-387-1143 (Canada)

## CHANGE OF OWNERSHIP OR ADDRESS

\*If you have purchased this vehicle used or have changed your address, please provide the following information and mail to:

### FCA US LLC

P.O. Box 21-8008

Auburn Hills, MI 48321-8004

Make sure to include the following:

- Date of Sale (mm/dd/yy)
- Vehicle Identification Number (17 Character ID located on top left of the instrument panel)
- Exact Odometer Reading
- First and Last Name
- Phone Number
- Street Address, City, State and Zip Code
- Email Address

\*Applies to US residents only.

## GENERAL INFORMATION

The following regulatory statement applies to all Radio Frequency (RF) devices equipped in this vehicle.

### Radio

The following regulatory statement applies to RADIO devices equipped in this vehicle:

FCC ID: 2AHPN-BE2857

ISED ID: 6434C-BE2857

This device complies with Part 15 of the FCC Rules and with Innovation, Science and Economic Development Canada license-exempt RSS standard(s). Operation is subject to the following two conditions:

1. This device may not cause harmful interference, and
2. This device must accept any interference received, including interference that may cause undesired operation.

Le présent appareil est conforme aux CNR d'Innovation, Science and Economic Development applicables aux appareils radio exempts de licence. L'exploitation est autorisée aux deux conditions suivantes:

1. L'appareil ne doit pas produire de brouillage, et
2. L'utilisateur de l'appareil doit accepter tout brouillage radioélectrique subi, même si le brouillage est susceptible d'en compromettre le fonctionnement.

La operación de este equipo está sujeta a las siguientes dos condiciones:

1. Es posible que este equipo o dispositivo no cause interferencia perjudicial y
2. Este equipo o dispositivo debe aceptar cualquier interferencia, incluyendo la que pueda causar su operación no deseada.

### RF Exposure Requirements

To comply with FCC RF exposure compliance requirements, the device must be installed and operated to provide a separation distance of at least 20 cm from all persons.

This equipment complies with Canada radiation exposure limits set forth for an uncontrolled environment. This equipment should be installed and operated with minimum distance 20 cm between the radiator and your body.

### Key Fob Model F17PE

US FCC - 2ADPXF17PE

Canada IC - 12548A-F17PE

This device complies with Part 15 of the FCC Rules and with Innovation, Science and Economic Development Canada license-exempt RSS standard(s). Operation is subject to the following two conditions:

1. This device may not cause harmful interference, and
2. This device must accept any interference received, including interference that may cause undesired operation.

Le présent appareil est conforme aux CNR d'Innovation, Science and Economic Development applicables aux appareils radio exempts de licence. L'exploitation est autorisée aux deux conditions suivantes:

1. L'appareil ne doit pas produire de brouillage, et
2. L'utilisateur de l'appareil doit accepter tout brouillage radioélectrique subi, même si le brouillage est susceptible d'en compromettre le fonctionnement.

La operación de este equipo está sujeta a las siguientes dos condiciones:

1. Es posible que este equipo o dispositivo no cause interferencia perjudicial y
2. Este equipo o dispositivo debe aceptar cualquier interferencia, incluyendo la que pueda causar su operación no deseada.

### RF Exposure Requirements

To comply with FCC RF exposure compliance requirements, the device must be installed and operated to provide a separation distance of at least 20 cm from all persons.

This equipment complies with Canada radiation exposure limits set forth for an uncontrolled environment. This equipment should be installed and operated with minimum distance 20 cm between the radiator and your body.

### NOTE:

Changes or modifications not expressly approved by the party responsible for compliance could void the user's authority to operate the equipment.

### Déclaration d'exposition aux radiations

Cet équipement est conforme aux limites d'exposition aux rayonnements ISED établies pour un environnement non contrôlé. Cet équipement doit être installé et utilisé avec un minimum de 20 cm de distance entre la source de rayonnement et votre corps

**REMARQUE:** Des changements ou des modifications n'ayant pas été expressément approuvés par la partie responsable de la conformité pourraient révoquer l'autorisation d'utilisation de l'équipement.

**DASM****US:**

FCC ID: NF3-FR5CPCCF

HVIN: FR5CPCCF

This device complies with Part 15 of the FCC Rules. Operation is subject to the following two conditions: 1. This device may not cause harmful interference, and 2. This device must accept any interference received, including interference that may cause undesired operation.

Changes or modifications made to this equipment not expressly approved by Robert BOSCH GmbH may void the FCC authorization to operate this equipment. This equipment has been tested and found to comply with the limits for a Class A digital device, pursuant to Part 15 of the FCC Rules. These limits are designed to provide reasonable protection against harmful interference when the equipment is operated in a commercial environment. This equipment generates, uses, and can radiate radio frequency energy and, if not installed and used in accordance with the instruction manual, may cause harmful interference to radio communications. Operation of this equipment in a residential area is likely to cause harmful interference in which case the user will be required to correct the interference at his own expense. Radiofrequency radiation exposure Information: This equipment complies with FCC radiation exposure limits set forth for an uncontrolled environment. This equipment should be installed and operated with minimum distance of 20 cm between the radiator and your body. This transmitter must not be co-located or operating in conjunction with any other antenna or transmitter.

**CANADA**

IC:3387A-FR5CPCCF

HVIN: FR5CPCCF

PMN: Front Radar 5 Car Plus CAN CAN Flexray

This device complies with Industry Canada license-exempt RSS standard(s). Operation is subject to the following two conditions: (1) this device must not cause interference, and (2) this device must accept any interference, including interference that may cause undesired operation of the device. Le présent appareil est conforme aux CNR d'Industrie Canada applicables aux appareils radio exempts de licence. L'exploitation est autorisée aux deux conditions suivantes: (1) l'appareil ne doit pas produire de brouillage, et (2) l'utilisateur de l'appareil doit accepter tout brouillage radioélectrique subi, même si le brouillage est susceptible d'en compromettre le fonctionnement.

**BLIND SPOT MONITORING SYSTEM:****US:**

FCC ID: WU877V12CRN

This device complies with Part 15 of the FCC Rules. Operation is subject to the following two conditions: (1) this device may not cause harmful interference, and (2) this device must accept any interference received, including interference that may cause undesired operation. CAUTION TO USERS Changes or modifications not expressly approved by the party responsible for compliance could void the user's authority to operate the equipment.

**CANADA**

IC: 8436B – 77V12CRN

This device contains license-exempt transmitter(s)/ receiver(s) that comply with Innovation, Science and Economic Development Canada's license-exempt RSS(s). Operation is subject to the following two conditions: (1) This device may not cause interference. (2) This device must accept any interference, including interference that may cause undesired operation of the device. L'émetteur/recepteur exempt de licence contenu dans le présent appareil est conforme aux CNR d'Innovation, Sciences et Développement économique Canada applicables aux appareils radio exempts de licence. L'exploitation est autorisée aux deux conditions suivantes: 1) L'appareil ne doit pas produire de brouillage; 2) L'appareil doit accepter tout brouillage radioélectrique subi, même si le brouillage est susceptible d'en compromettre le fonctionnement.

# INDEX

## A

Active Driving Assist System . . . . .	.122
Active Speed Limiter . . . . .	.113
Adaptive Cruise Control (ACC) . . . . .	.114
Adding Engine Coolant (Antifreeze) . . . . .	.241
Adding Fuel . . . . .	.139
Additives, Fuel . . . . .	.275
Air Bag . . . . .	.189
Air Bag Operation . . . . .	.190
Air Bag Warning Light . . . . .	.189, 191
Driver Knee Air Bag . . . . .	.194
Enhanced Accident Response . . . . .	.196, 229
Event Data Recorder (EDR) . . . . .	.229
Front Air Bag . . . . .	.191
If Deployment Occurs . . . . .	.196
Knee Impact Bolsters . . . . .	.194
Maintaining Your Air Bag System . . . . .	.198
Maintenance . . . . .	.198
Redundant Air Bag Warning Light . . . . .	.189
Side Air Bags . . . . .	.194
Transporting Pets . . . . .	.207
Air Bag Light . . . . .	.189, 208
Air Cleaner, Engine (Engine Air Cleaner Filter) . . . . .	.236
Air Conditioner Maintenance . . . . .	.237
Air Conditioner Refrigerant . . . . .	.237
Air Conditioner System . . . . .	.237
Air Conditioning . . . . .	.62
Air Conditioning Filter . . . . .	.65, 237
Air Conditioning, Operating Tips . . . . .	.65
Air Filter . . . . .	.236
Air Pressure . . . . .	
Tires . . . . .	.263
Alarm . . . . .	
Panic . . . . .	.32

Security Alarm . . . . .	.90
Alfa Active Suspension (AAS) . . . . .	.111
Alfa DNA System . . . . .	.109
Alfa DNA System (Dynamic Car Control System) . . . . .	.110
All Wheel Drive . . . . .	
Towing . . . . .	.228
All Wheel Drive (AWD) . . . . .	.108, 228
Alterations/Modifications . . . . .	
Vehicle . . . . .	.9
Antifreeze (Engine Coolant) . . . . .	.241, 276
Disposal . . . . .	.242
Anti-Lock Brake System (ABS) . . . . .	.169
Anti-Lock Warning Light . . . . .	.91
Assist, Hill Start . . . . .	.172
Audio Systems (Radio) . . . . .	.149
Auto Down Power Windows . . . . .	.70
Auto Hold . . . . .	.103
Auto Liftgate Fault Warning Light . . . . .	.90
Automatic Dimming Mirror . . . . .	.51
Automatic Door Locks . . . . .	.43
Automatic Headlights . . . . .	.57
Automatic High Beams . . . . .	.57
Automatic Temperature Control (ATC) . . . . .	.65
Automatic Transaxle . . . . .	.104
Automatic Transmission . . . . .	.105
Adding Fluid . . . . .	.244, 277
Fluid And Filter Change . . . . .	.244
Fluid Change . . . . .	.244
Fluid Level Check . . . . .	.243
Fluid Type . . . . .	.244, 277
Special Additives . . . . .	.243
Auxiliary Electrical Outlet (Power Outlet) . . . . .	.68
Axle Fluid . . . . .	.277
Axle Lubrication . . . . .	.277

## B

Battery . . . . .	.15, 234
Charging . . . . .	.18
Charging System Light . . . . .	.88
Keyless Key Fob Replacement . . . . .	.33
Battery Saver Feature . . . . .	.86
Belts, Seat . . . . .	.208
Blind Spot Monitoring . . . . .	.173
Body Mechanism Lubrication . . . . .	.238
B-Pillar Location . . . . .	.260
Brake Assist System . . . . .	.170
Brake Control System, Electronic . . . . .	.169
Brake Fluid . . . . .	.277
Brake System . . . . .	.243, 273
Anti-Lock (ABS) . . . . .	.273
Fluid Check . . . . .	.243, 277
Master Cylinder . . . . .	.243
Parking . . . . .	.101
Warning Light . . . . .	.88
Brake/Transmission Interlock . . . . .	.105
Brightness, Interior Lights . . . . .	.59, 60
Bulb Replacement . . . . .	.257
Bulbs, Light . . . . .	.209

## C

Camera, Rear . . . . .	.135
Capacities, Fuel . . . . .	.276
Caps, Filler . . . . .	
Fuel . . . . .	.138
Oil (Engine) . . . . .	.232
Radiator (Coolant Pressure) . . . . .	.241
Carbon Monoxide Warning . . . . .	.209
Cargo Tie-Downs . . . . .	.78

- Car Washes . . . . .271  
 Cellular Phone . . . . .168  
 Certification Label . . . . .141  
 Change Oil Indicator . . . . .82  
 Changing A Flat Tire . . . . .213  
 Charging . . . . .18  
 Chart, Tire Sizing . . . . .258  
 Check Engine Light (Malfunction Indicator Light) . . .96  
 Checking Your Vehicle For Safety . . . . .207  
 Checks, Safety . . . . .207  
 Child Restraint . . . . .199  
 Child Restraints  
   Booster Seats . . . . .201  
   Child Seat Installation . . . . .206  
   How To Stow An unused ALR Seat Belt . . . . .205  
   Infant And Child Restraints . . . . .200  
   Lower Anchors And Tethers For Children . . . . .202  
   Older Children And Child Restraints . . . . .200  
   Seating Positions . . . . .201  
 Child Safety Locks . . . . .44  
 Clean Air Gasoline . . . . .274  
 Cleaning  
   Wheels . . . . .270  
   Windshield Wiper Blades . . . . .238  
 Climate Control . . . . .62  
   Automatic . . . . .62  
 Compact Spare Tire . . . . .266  
 Connector  
   Universal Consumer Interface (UCI) . . . . .67  
 Console . . . . .66  
   Floor . . . . .66  
 Contract, Service . . . . .280  
 Cooling Pressure Cap (Radiator Cap) . . . . .241  
 Cooling System . . . . .240  
   Adding Coolant (Antifreeze) . . . . .241  
   Coolant Level . . . . .240, 242  
   Cooling Capacity . . . . .276  
   Disposal Of Used Coolant . . . . .242  
   Drain, Flush, And Refill . . . . .240  
   Inspection . . . . .242  
   Points To Remember . . . . .242  
   Pressure Cap . . . . .241  
   Radiator Cap . . . . .241  
   Selection Of Coolant (Antifreeze) . . . . .241, 276, 277  
 Cornering Lights . . . . .58  
 Corrosion Protection . . . . .270  
 Cruise Light . . . . .94  
 Customer Assistance . . . . .278  
 Cybersecurity . . . . .149
- D**  
 Daytime Running Lights . . . . .57  
 Defroster, Windshield . . . . .208  
 Dipsticks  
   Oil (Engine) . . . . .234  
 Disabled Vehicle Towing . . . . .227  
 Disposal  
   Antifreeze (Engine Coolant) . . . . .242  
 Door Ajar . . . . .88, 89  
 Door Ajar Light . . . . .88, 89  
 Door Locks . . . . .40  
   Dead Lock Device . . . . .43  
   Passive Entry . . . . .41  
 Driving  
   Through Flowing, Rising, Or Shallow Standing  
   Water . . . . .147
- E**  
 Electrical Power Outlets . . . . .68  
 Electric Brake Control System . . . . .169  
   Anti-Lock Brake System . . . . .169  
   Traction Control System . . . . .172, 173  
 Electric Parking Brake . . . . .101  
 Electronic Stability Control (ESC) . . . . .171  
 Electronic Throttle Control Warning Light . . . . .89  
 Emergency Braking . . . . .178  
 Emergency Gas Can Refueling . . . . .224  
 Emergency, In Case Of  
   Hazard Warning Flasher . . . . .210  
   Jacking . . . . .213  
   Jump Starting . . . . .220, 222  
   Towing . . . . .227  
 Emission Control System Maintenance . . . . .96  
 Engine . . . . .232  
   Air Cleaner . . . . .236  
   Break-In Recommendations . . . . .101  
   Checking Oil Level . . . . .234  
   Compartment . . . . .233  
   Compartment Identification . . . . .233  
   Coolant (Antifreeze) . . . . .277  
   Cooling . . . . .240  
   Exhaust Gas Caution . . . . .209  
   Fails To Start . . . . .99  
   Flooded, Starting . . . . .99  
   Fuel Requirements . . . . .274  
   Jump Starting . . . . .220, 222  
   Oil . . . . .235, 276, 277  
   Oil Filler Cap . . . . .232  
   Oil Filter . . . . .236  
   Oil Selection . . . . .235, 276  
   Oil Synthetic . . . . .235  
   Overheating . . . . .225  
   Starting . . . . .98, 100  
 Enhanced Accident Response Feature . . . . .196, 229  
 Ethanol . . . . .274  
 Exhaust Gas Cautions . . . . .209  
 Exhaust System . . . . .209, 239  
 Exterior Lighting . . . . .56  
 Exterior Lights . . . . .56, 209

<b>F</b>	
Filters	
Air Cleaner . . . . .	.236
Air Conditioning . . . . .	.65, 237
Engine Oil . . . . .	.236
Engine Oil Disposal . . . . .	.235
Flashers	
Hazard Warning . . . . .	.210
Turn Signals . . . . .	.58, 95, 209
Flash-To-Pass . . . . .	.57
Flat Tire Changing . . . . .	.257, 266
Flat Tire Stowage . . . . .	.257, 266
Flooded Engine Starting . . . . .	.99
Floor Console . . . . .	.66
Fluid, Brake . . . . .	.277
Fluid Capacities . . . . .	.276
Fluid Leaks . . . . .	.209
Fluid Level Checks	
Brake . . . . .	.243
Engine Oil . . . . .	.234
Fold-Flat Seats . . . . .	.46
Folding Rear Seats . . . . .	.46
Forward Collision Warning . . . . .	.176
Freeing A Stuck Vehicle . . . . .	.226
Fuel . . . . .	.274
Adding . . . . .	.139
Additives . . . . .	.275
Clean Air . . . . .	.274
Ethanol . . . . .	.274
Filler Cap (Gas Cap) . . . . .	.138
Gasoline . . . . .	.274
Light . . . . .	.92
Materials Added . . . . .	.275
Methanol . . . . .	.274
Octane Rating . . . . .	.274, 277
Specifications . . . . .	.277
Tank Capacity . . . . .	.276
Fueling . . . . .	.139
Fuses . . . . .	.244
<b>G</b>	
Garage Door Opener (HomeLink®) . . . . .	.53
Gas Cap (Fuel Filler Cap) . . . . .	.138
Gasoline, Clean Air . . . . .	.274
Gasoline, (Fuel) . . . . .	.274
Gasoline, Reformulated . . . . .	.274
Gear Ranges . . . . .	.105
Gear Selector Override . . . . .	.225
Gear Shift Indicator . . . . .	.84
Glass Cleaning . . . . .	.272
Gross Axle Weight Rating . . . . .	.142
Gross Vehicle Weight Rating . . . . .	.142
GVWR . . . . .	.141
<b>H</b>	
Hazard	
Driving Through Flowing, Rising, Or Shallow Standing Water . . . . .	.147
Hazard Warning Flashers . . . . .	.210
Headlights . . . . .	.56
Automatic . . . . .	.57
Cleaning . . . . .	.271
Delay . . . . .	.58
High Beam/Low Beam Select Switch . . . . .	.57
Lights On Reminder . . . . .	.58
On With Wipers . . . . .	.57
Passing . . . . .	.57
Switch . . . . .	.56
Time Delay . . . . .	.58
Head Restraints . . . . .	.49
Head Rests . . . . .	.49
Heated Mirrors . . . . .	.51, 53

Heated Seats . . . . .	.47
High Beam/Low Beam Select (Dimmer) Switch . . . . .	.57
High Voltage Battery . . . . .	.15
Hill Start Assist . . . . .	.172
HomeLink® (Garage Door Opener) . . . . .	.53
Hood Release . . . . .	.73

<b>I</b>	
Idle Coasting . . . . .	.95
Ignition . . . . .	.35
Switch . . . . .	.35
Inside Rearview Mirror . . . . .	.210
Instrument Cluster . . . . .	.79, 80, 82
Descriptions . . . . .	.80
Display . . . . .	.80
Driver Assist . . . . .	.85
Menu Items . . . . .	.84
Messages . . . . .	.86
Instrument Cluster Display	
Locations and Controls . . . . .	.80
Navigation . . . . .	.85
Instrument Panel Lens Cleaning . . . . .	.272
Intelligent Adaptive Cruise Control System . . . . .	.121
Intelligent Speed Assist System . . . . .	.114
Interior Appearance Care . . . . .	.271
Interior Fuses . . . . .	.254
Interior Lights . . . . .	.59
iPod/USB/MP3 Control . . . . .	.67

<b>J</b>	
Jacking And Tire Changing If Equipped  . . . . .	.213
Jacking Instructions . . . . .	.214
Jack Location . . . . .	.213
Jack Operation . . . . .	.213, 214
Jump Starting . . . . .	.220, 222



**K**

Key Fob	
Programming Additional Key Fobs . . . . .	.34
Remote Keyless Entry . . . . .	.31
Key Fob Battery Service (Remote Keyless Entry) . . . . .	.33
Key Fob Programming (Remote Keyless Entry) . . . . .	.34
Keyless Enter 'n Go™ . . . . .	.31, 41
Keys . . . . .	.31

**L**

Lane Change And Turn Signals . . . . .	.58
Lane Change Assist . . . . .	.58
LaneSense . . . . .	.133
Lap/Shoulder Belts . . . . .	.183
Latches . . . . .	.209
Hood . . . . .	.73
Leaks, Fluid . . . . .	.209
Life Of Tires . . . . .	.265
Liftgate . . . . .	.74
Hands-Free . . . . .	.76
Liftgate Window Wiper/Washer . . . . .	.62
Light Bulbs . . . . .	.209
Lights . . . . .	.209
Active Speed Limiter Fault . . . . .	.91
Active Speed Limiter SET . . . . .	.94
Air Bag . . . . .	.87, 189, 208
Anti Lock Brake System . . . . .	.91
Automatic Headlights . . . . .	.57
Automatic High Beam . . . . .	.57, 94, 95
Battery Charge . . . . .	.88
Battery Saver . . . . .	.58, 60
Brake Assist Warning . . . . .	.172
Brake Warning . . . . .	.88
Bulb Replacement . . . . .	.257
Cornering . . . . .	.58
Cruise . . . . .	.94

Daytime Running . . . . .	.57
Dimmer Switch, Headlight . . . . .	.59
Door Open . . . . .	.88
Drowsiness Detected . . . . .	.88
Electric Power Steering Fault . . . . .	.88
Electronic Park Brake . . . . .	.91
Electronic Stability Control . . . . .	.91
Electronic Throttle Control . . . . .	.89
Engine Temperature . . . . .	.89
Exterior . . . . .	.209
Fog . . . . .	.58
Forward Collision Warning . . . . .	.94
Fuel Cutoff . . . . .	.91
Fuel Level Sensor Fail . . . . .	.91
Headlights . . . . .	.56
Headlights On With Wipers . . . . .	.57
Headlight Switch . . . . .	.56
High Beam . . . . .	.57, 95
High Beam/Low Beam Select . . . . .	.57
Hood Open . . . . .	.89
Icy Road Condition . . . . .	.94
Intensity Control . . . . .	.59, 60
Interior . . . . .	.59
LaneSense . . . . .	.91, 92
Liftgate Open . . . . .	.89
Lights On Reminder . . . . .	.58
Low Fuel . . . . .	.92
Malfunction Indicator (Check Engine) . . . . .	.92
Oil Pressure . . . . .	.89
Oil Temperature . . . . .	.89
Park . . . . .	.94, 95
Passing . . . . .	.57
Seat Belt Reminder . . . . .	.90
Security Alarm . . . . .	.90
Service . . . . .	.257
Service Forward Collision Warning . . . . .	.92
Service Stop Start . . . . .	.92
Stop Start Active . . . . .	.95

Tire Pressure Monitoring (TPMS) . . . . .	.92, 179
Towing Hook Breakdown . . . . .	.93
Traction Control . . . . .	.172
Transmission Temperature . . . . .	.93
Turn Signals . . . . .	.56, 58, 95, 209
Vanity Mirror . . . . .	.51
Loading Vehicle . . . . .	.141
Tires . . . . .	.260
Locks	
Auto Unlock . . . . .	.43
Child Protection . . . . .	.44
Power Door . . . . .	.41
Low Tire Pressure System . . . . .	.179
Lubrication, Body . . . . .	.238
Lug Nuts/Bolts . . . . .	.273

**M**

Maintenance . . . . .	.73
Maintenance Free Battery . . . . .	.234
Maintenance Schedule . . . . .	.230
Malfunction Indicator Light (Check Engine) . . . . .	.92
Manual	
Service . . . . .	.281
Memory Feature (Memory Seats) . . . . .	.45
Memory Seat . . . . .	.45
Memory Settings . . . . .	.45
Methanol . . . . .	.274
Mirrors . . . . .	.51
Automatic Dimming . . . . .	.51
Heated . . . . .	.51, 53
Outside . . . . .	.51
Rearview . . . . .	.51, 210
Vanity . . . . .	.51
Modifications/Alterations	
Vehicle . . . . .	.9
Monitor, Tire Pressure System . . . . .	.179

Mopar Parts . . . . .	.280		
Multi-Function Control Lever . . . . .	.56		
<b>N</b>			
New Vehicle Break-In Period . . . . .	.101		
<b>O</b>			
Occupant Restraints . . . . .	.182		
Octane Rating, Gasoline (Fuel) . . . . .	.274, 277		
Oil, Engine . . . . .	.235, 277		
Capacity . . . . .	.276		
Checking . . . . .	.234		
Dipstick . . . . .	.234		
Disposal . . . . .	.235		
Filter . . . . .	.236		
Filter Disposal . . . . .	.235		
Identification Logo . . . . .	.235		
Materials Added To . . . . .	.235		
Pressure Warning Light . . . . .	.89		
Recommendation . . . . .	.235, 276		
Synthetic . . . . .	.235		
Viscosity . . . . .	.276		
Oil Filter, Change . . . . .	.236		
Oil Filter, Selection . . . . .	.236		
Oil Pressure Light . . . . .	.89		
Onboard Diagnostic System . . . . .	.96		
Operator Manual . . . . .			
Owner's Manual . . . . .	.281		
Outlet . . . . .			
Power . . . . .	.68		
Outside Rearview Mirrors . . . . .	.51		
Overheating, Engine . . . . .	.225		
<b>P</b>			
Paddle Shifters . . . . .	.107		
Paint Care . . . . .	.270		
Panic Alarm . . . . .	.32		
Parking Brake . . . . .	.101		
ParkSense . . . . .			
Front And Rear . . . . .	.125		
ParkSense Active Park Assist . . . . .	.129		
ParkSense System . . . . .	.125		
Pedestrian Warning System . . . . .	.178		
Performance . . . . .	.85, 167		
Pets . . . . .	.207		
Placard, Tire And Loading Information . . . . .	.260		
Power . . . . .			
Door Locks . . . . .	.41		
Liftgate . . . . .	.75		
Outlet (Auxiliary Electrical Outlet) . . . . .	.68		
Outside Mirrors . . . . .	.52		
Seats . . . . .	.46		
Sunroof . . . . .	.71		
Windows . . . . .	.70		
Pregnant Women And Seat Belts . . . . .	.187		
Premium Instrument Cluster  . . . . .	.80		
Preparation For Jacking . . . . .	.213		
Pretensioners . . . . .			
Seat Belts . . . . .	.187		
Profile Settings . . . . .	.151		
Programmable Features . . . . .	.149		
<b>R</b>			
Radial Ply Tires . . . . .	.264		
Radiator Cap (Coolant Pressure Cap) . . . . .	.241		
Radio . . . . .			
Settings . . . . .	.149		
Sound Setting . . . . .	.161		
Radio Operation . . . . .	.168		
Radio Remote Controls . . . . .	.166		
Rain Sensitive Wiper System . . . . .	.61		
Rear Camera . . . . .	.135		
Rear Cross Path . . . . .	.175		
Rear Seats, Folding . . . . .	.46		
Rear Wiper/Washer . . . . .	.62		
Recreational Towing . . . . .	.146		
Reformulated Gasoline . . . . .	.274		
Refrigerant . . . . .	.237		
Release, Hood . . . . .	.73		
Reminder, Lights On . . . . .	.58		
Reminder, Seat Belt . . . . .	.182		
Remote Control . . . . .			
Starting System . . . . .	.37		
Remote Keyless Entry . . . . .	.31		
Programming Additional Key Fobs . . . . .	.34		
Remote Sound System (Radio) Control . . . . .	.166		
Remote Starting . . . . .			
Exit Remote Start Mode . . . . .	.38		
Uconnect Customer Programmable Features . . . . .	.39		
Uconnect Settings . . . . .	.39		
Remote Starting System . . . . .	.37		
Removable Rear Shelf . . . . .	.77		
Replacement Tires . . . . .	.265		
Reporting Safety Defects . . . . .	.280		
Restraints, Child . . . . .	.199		
Restraints, Head . . . . .	.49		
Roll Over Warning . . . . .	.8		
Rotation, Tires . . . . .	.267		
<b>S</b>			
Safety Checks Inside Vehicle . . . . .	.208		
Safety Checks Outside Vehicle . . . . .	.209		
Safety Defects, Reporting . . . . .	.280		
Safety, Exhaust Gas . . . . .	.209		
Safety Information, Tire . . . . .	.257		

- Safety Tips . . . . .207
- Scheduled Cabin Conditioning . . . . .39
- Schedule, Maintenance . . . . .230
- Seat Belt Reminder . . . . .90
- Seat Belts . . . . .182, 208
- Adjustable Shoulder Belt . . . . .185
- Adjustable Upper Shoulder Anchorage . . . . .185
- Adjustable Upper Shoulder Belt Anchorage . . . . .185
- Child Restraints . . . . .199
- Energy Management Feature . . . . .187
- Extender . . . . .187
- Front Seat . . . . .182, 183, 184
- Inspection . . . . .208
- Lap/Shoulder Belt Operation . . . . .184
- Lap/Shoulder Belts . . . . .183
- Lap/Shoulder Belt Untwisting . . . . .185
- Operating Instructions . . . . .184
- Pregnant Women . . . . .187
- Pretensioners . . . . .187
- Rear Seat . . . . .183
- Reminder . . . . .182
- Seat Belt Extender . . . . .187
- Seat Belt Pretensioner . . . . .187
- Untwisting Procedure . . . . .185
- Seat Belts Maintenance . . . . .272
- Seats . . . . .46
- Head Restraints . . . . .49
- Heated . . . . .47
- Memory . . . . .45
- Power . . . . .46
- Rear Folding . . . . .46
- Seatback Release . . . . .46
- Tilting . . . . .46
- Ventilated . . . . .48
- Security Alarm . . . . .90
- Selection Of Coolant (Antifreeze) . . . . .277
- Sentry Key (Immobilizer) . . . . .34
- Service Assistance . . . . .278
- Service Contract . . . . .280
- Service Manuals . . . . .281
- Shifting
- Automatic Transmission . . . . .105
- Shift Lever Override . . . . .225
- Shoulder Belts . . . . .183
- Side Distance Warning . . . . .127
- Side View Mirror Adjustment . . . . .51
- Signals, Turn . . . . .58, 95, 209
- Snow Tires . . . . .266
- Spare Tires . . . . .266, 267
- Specifications
- Fuel (Gasoline) . . . . .277
- Oil . . . . .277
- Speedometer . . . . .85
- Starting . . . . .37, 98, 100
- Automatic Transmission . . . . .98
- Button . . . . .35
- Engine Fails To Start . . . . .99
- Remote . . . . .37
- Starting And Operating . . . . .98, 100
- Starting Procedures . . . . .98, 100
- Steering
- Tilt Column . . . . .44
- Wheel, Heated . . . . .44, 45
- Wheel, Tilt . . . . .44
- Steering Wheel Audio Controls . . . . .166
- Steering Wheel Mounted Sound System Controls . . . . .166
- Storage . . . . .66
- Storage, Vehicle . . . . .65, 269
- Storing Your Vehicle . . . . .269
- Stuck, Freeing . . . . .226
- Sun Roof . . . . .71, 73
- Sun Visor . . . . .51
- Supplemental Restraint System – Air Bag . . . . .189
- Surround View Camera System . . . . .136
- Synthetic Engine Oil . . . . .235
- System, Remote Starting . . . . .37
- T**
- Telescoping Steering Column . . . . .44
- Temperature Control, Automatic (ATC) . . . . .65
- Tie Down Hooks, Cargo . . . . .78
- Tilt Steering Column . . . . .44
- Time Delay
- Headlight . . . . .58
- Tire And Loading Information Placard . . . . .260
- Tire Inflator Kit – If Equipped  . . . . .217
- Tire Markings . . . . .257
- Tires . . . . .209, 263, 266, 268
- Aging (Life Of Tires) . . . . .265
- Air Pressure . . . . .263
- Changing . . . . .213
- Compact Spare . . . . .266
- General Information . . . . .263, 266
- High Speed . . . . .264
- Inflation Pressure . . . . .263
- Jacking . . . . .213
- Life Of Tires . . . . .265
- Load Capacity . . . . .260
- Pressure Monitoring System (TPMS) . . . . .92, 179
- Quality Grading . . . . .268
- Radial . . . . .264
- Replacement . . . . .265
- Rotation . . . . .267
- Safety . . . . .257, 263
- Sizes . . . . .258
- Snow Tires . . . . .266
- Spare Tires . . . . .266, 267
- Spinning . . . . .264
- Trailer Towing . . . . .145
- Tread Wear Indicators . . . . .264
- Wheel Nut Torque . . . . .273
- Tire Safety Information . . . . .257
- Tire Service Kit . . . . .217
- Tongue Weight/Trailer Weight . . . . .144

To Open Hood . . . . .	.73
Towing . . . . .	.142
Disabled Vehicle . . . . .	.227
Guide . . . . .	.143
Recreational . . . . .	.146
Weight . . . . .	.143
Towing Behind A Motorhome . . . . .	.146
Towing Eyes . . . . .	.228
Traction . . . . .	.147
Traction Control . . . . .	.172, 173
Traffic Sign Recognition System . . . . .	.93, 120
Trailer Towing . . . . .	.142
Minimum Requirements . . . . .	.144
Tips . . . . .	.146
Trailer And Tongue Weight . . . . .	.144
Wiring . . . . .	.145
Trailer Towing Guide . . . . .	.143
Trailer Weight . . . . .	.143
Transaxle . . . . .	
Automatic . . . . .	.104
Operation . . . . .	.104
Transfer Case . . . . .	
Fluid . . . . .	.277
Transmission . . . . .	.105
Automatic . . . . .	.105, 243
Fluid . . . . .	.277
Maintenance . . . . .	.243
Transporting Pets . . . . .	.207
Tread Wear Indicators . . . . .	.264
Turn Signals . . . . .	.58, 95

**U**

Uconnect Settings . . . . .	.149
Uniform Tire Quality Grades . . . . .	.268
Universal Consumer Interface (UCI) Connector . . . . .	.67

Universal Garage Door Opener (HomeLink®) If Equipped  . . . . .	.53
Untwisting Procedure, Seat Belt . . . . .	.185

**V**

Vanity Mirrors . . . . .	.51
Vehicle Loading . . . . .	.141, 260
Vehicle Maintenance . . . . .	.235
Vehicle Modifications/Alterations . . . . .	.9
Vehicle Settings . . . . .	.149
Vehicle Storage . . . . .	.65, 269
Ventilated Seats . . . . .	.48
Voice Command . . . . .	.50
Voice Recognition System (VR) . . . . .	.50

**W**

Warnings, Roll Over . . . . .	.8
Warranty Information  . . . . .	.280
Washers, Windshield . . . . .	.60, 234
Washing Vehicle . . . . .	.271
Water . . . . .	
Driving Through . . . . .	.147
Wheel And Wheel Tire Care . . . . .	.270
Wheel And Wheel Tire Trim . . . . .	.270
Wind Buffeting . . . . .	.71
Window Fogging . . . . .	.65
Windows . . . . .	.70
Close . . . . .	.70
Down . . . . .	.70
Open . . . . .	.70
Power . . . . .	.70
Up . . . . .	.70
Windshield Defroster . . . . .	.208
Windshield Washers . . . . .	.60, 234
Fluid . . . . .	.234

Windshield Wiper Blades . . . . .	.238
Windshield Wipers . . . . .	.60
Wipers Blade Replacement . . . . .	.238
Wipers, Rain Sensitive . . . . .	.61
Wireless Charging Pad . . . . .	.69





The driver's primary responsibility is the safe operation of the vehicle. Driving while distracted can result in loss of vehicle control, resulting in an accident and personal injury. FCA US LLC strongly recommends that the driver use extreme caution when using any device or feature that may take their attention off the road. Use of any electrical devices, such as cellular telephones, computers, portable radios, vehicle navigation or other devices, by the driver while the vehicle is moving is dangerous and could lead to a serious accident. Texting while driving is also dangerous and should never be done while the vehicle is moving. If you find yourself unable to devote your full attention to vehicle operation, pull off the road to a safe location and stop your vehicle. Some states or provinces prohibit the use of cellular telephones or texting while driving. It is always the driver's responsibility to comply with all local laws.

This Owner's Manual has been prepared to help you get acquainted with your new Alfa Romeo brand vehicle and to provide a convenient reference source for common questions.

Not all features shown in this manual may apply to your vehicle. For additional information, visit [www.alfaromeousa.com](http://www.alfaromeousa.com) (USA), [www.alfaromeo.ca](http://www.alfaromeo.ca) (Canada) or your local Alfa Romeo brand dealer.

This Owner's Manual is intended to familiarize you with the important features of your vehicle. Your most up-to-date Owner's Manual, Owner Handbook, Radio Instruction Manual and Warranty Booklet can be found by visiting the website on the back cover.

**U.S. Residents:** If you are the first registered retail owner of your vehicle, you may obtain a complimentary printed copy of the Warranty Booklet by calling **844-253-2872** or by contacting your dealer. Replacement kits can be purchased by visiting [www.techauthority.com](http://www.techauthority.com).

**Canadian Residents:** If you are the first registered retail owner of your vehicle, you may obtain a complimentary printed copy of the Warranty Booklet or purchase a replacement kit by calling **1-800-387-1143** or by contacting your dealer.

## DRIVING AND ALCOHOL

Drunk driving is one of the most frequent causes of accidents. Your driving ability can be seriously impaired with blood alcohol levels far below the legal minimum. If you are drinking, don't drive. Ride with a designated non-drinking driver, call a cab, a rideshare, a friend, or use public transportation.

## WARNING

Driving after drinking can lead to an accident. Your perceptions are less sharp, your reflexes are slower and your judgment is impaired when you have been drinking. Never drink and then drive.



Whether it's providing information about specific product features, taking a tour through your vehicle's heritage, knowing what steps to take following an accident or scheduling your next appointment, we know you'll find the app an important extension of your Alfa Romeo brand vehicle. Simply download the app, select your make and model and enjoy the ride. To get this app, go directly to the App Store® or Google Play® Store and enter the search keyword "Alfa Romeo" (U.S. residents only).

USA



[alfaromeousa.com/  
owners/owners-service-manual](https://alfaromeousa.com/owners/owners-service-manual)

**DOWNLOAD THE MOST UP-TO-DATE OWNER'S MANUAL,  
RADIO AND WARRANTY BOOKS**

Canada



[alfaromeo.ca/en/  
owners/owners-service-manual](https://alfaromeo.ca/en/owners/owners-service-manual)