

Field-Adjustable, Edge-Lit Wafer



Round Smooth



Round Baffle



Shallow Baffle



Square Smooth



Square Baffle

PROJECT: _____

DATE: _____

TYPE: _____

PREPARED BY: _____



KEY FEATURES

- 5 color temperatures in 1 SKU (2700K, 3000K, 3500K, 4000K, 5000K)
- Super-slim, edge-lit fixture
- No recessed housing or j-box required
- New construction or retrofit applications
- Dimmable down to 10% on compatible dimmers
- Spring-loaded retention clips

Field-Adjustable, Edge-Lit Wafer, 90 CRI



PERFORMANCE

Catalog Number	Size	Shape	Trim	Equivalency	Wattage	CRI	Color Temperature	L70 Lifetime
WFRL3R69CCT120WB	3"	Round	Baffle	25W Incandescent	6	90	Field Adjustable 2700/3000/3500/4000/5000K	50,000
WFRL3R69CCT120WS		Round	Smooth	25W Incandescent	6			
WFRL4R10.59FA120WB	4"	Round	Baffle	60W Incandescent	10.5			
WFRL4R10.59FA120WS		Round	Smooth	60W Incandescent	10.5			
WFRL4R99FA120WB		Round	Baffle	60W Incandescent	9			
WFRL4R99FA120WBS		Round	Shallow Baffle	60W Incandescent	9			
WFRL4R99FA120WS		Round	Smooth	60W Incandescent	9			
WFRL4S99FA120WB		Square	Baffle	60W Incandescent	9			
WFRL4S99FA120WS		Square	Smooth	60W Incandescent	9			
WFRL5R129CCT120WB		5"	Round	Baffle	75W Incandescent			
WFRL5R129CCT120WS	Round		Smooth	75W Incandescent	12			
WFRL6R139FA120WB	6"	Round	Baffle	75W Incandescent	13			
WFRL6R139FA120WBS		Round	Shallow Baffle	75W Incandescent	13			
WFRL6R139FA120WS		Round	Smooth	75W Incandescent	13			
WFRL6R139FADWB		Round	Baffle	75W Incandescent	13			
WFRL6R139FADWS		Round	Smooth	75W Incandescent	13			
WFRL6R149FA120WB		Round	Baffle	75W Incandescent	14			
WFRL6R149FA120WS		Round	Smooth	75W Incandescent	14			
WFRL6S139FA120WB		Square	Baffle	75W Incandescent	13			
WFRL6S139FA120WS		Square	Smooth	75W Incandescent	13			
WFRL8R239FA120WB		8"	Round	Baffle	100W Incandescent			
WFRL8R239FA120WS	Round		Smooth	100W Incandescent	23			
WFRL8R239FADWB	Round		Baffle	100W Incandescent	23			
WFRL8R239FADWS	Round		Smooth	100W Incandescent	23			

Field-Adjustable, Edge-Lit Wafer



3" Edge-lit wafer

Catalog Number	Wattage	CCT	Efficacy	Lumens	Equivalency Wattage
WFRL3R69CCT120WS	6W	2700K	70 Lm/W	420 Lm	25W Incandescent
		3000K	73 Lm/W	435 Lm	
		3500K	74 Lm/W	445 Lm	
		4000K	75 Lm/W	450 Lm	
		5000K	74 Lm/W	445 Lm	

Catalog Number	Wattage	CCT	Efficacy	Lumens	Equivalency Wattage
WFRL3R69CCT120WB	6W	2700K	67 Lm/W	400 Lm	25W Incandescent
		3000K	71 Lm/W	424 Lm	
		3500K	74 Lm/W	446 Lm	
		4000K	75 Lm/W	449 Lm	
		5000K	74 Lm/W	443 Lm	

4" Edge-lit wafer

Catalog Number	Wattage	CCT	Efficacy	Lumens	Equivalency Wattage
WFRL4R10.59FA120WS	10.5W	2700K	76 Lm/W	800 Lm	60W Incandescent
		3000K	79 Lm/W	825 Lm	
		3500K	81 Lm/W	855 Lm	
		4000K	83 Lm/W	870 Lm	
		5000K	82 Lm/W	860 Lm	

Catalog Number	Wattage	CCT	Efficacy	Lumens	Equivalency Wattage
WFRL4R10.59FA120WB	10.5W	2700K	71 Lm/W	750 Lm	60W Incandescent
		3000K	73 Lm/W	770 Lm	
		3500K	76 Lm/W	795 Lm	
		4000K	77 Lm/W	810 Lm	
		5000K	76 Lm/W	800 Lm	

Catalog Number	Wattage	CCT	Efficacy	Lumens	Equivalency Wattage
WFRL4R99FA120WS	9W	2700K	72 Lm/W	650 Lm	60W Incandescent
		3000K	75 Lm/W	675 Lm	
		3500K	79 Lm/W	710 Lm	
		4000K	81 Lm/W	730 Lm	
		5000K	81 Lm/W	730 Lm	

Catalog Number	Wattage	CCT	Efficacy	Lumens	Equivalency Wattage
WFRL4R99FA120WBS	9W	2700K	72 Lm/W	650 Lm	60W Incandescent
		3000K	74 Lm/W	665 Lm	
		3500K	75 Lm/W	675 Lm	
		4000K	76 Lm/W	680 Lm	
		5000K	75 Lm/W	675 Lm	

Field-Adjustable, Edge-Lit Wafer



4" Edge-lit wafer

Catalog Number	Wattage	CCT	Efficacy	Lumens	Equivalency Wattage
WFRL4R99FA120WB	9W	2700K	67 Lm/W	600 Lm	60W Incandescent
		3000K	69 Lm/W	625 Lm	
		3500K	73 Lm/W	660 Lm	
		4000K	76 Lm/W	680 Lm	
		5000K	76 Lm/W	680 Lm	

Catalog Number	Wattage	CCT	Efficacy	Lumens	Equivalency Wattage
WFRL4S99FA120WS WFRL4S99FA120WB	9W	2700K	61 Lm/W	550 Lm	60W Incandescent
		3000K	64 Lm/W	580 Lm	
		3500K	68 Lm/W	615 Lm	
		4000K	69 Lm/W	625 Lm	
		5000K	68 Lm/W	615 Lm	

5" Edge-lit wafer

Catalog Number	Wattage	CCT	Efficacy	Lumens	Equivalency Wattage
WFRL5R129CCT120WS WFRL5R129CCT120WB	12W	2700K	75 Lm/W	900 Lm	75W Incandescent
		3000K	78 Lm/W	935 Lm	
		3500K	80 Lm/W	970 Lm	
		4000K	82 Lm/W	980 Lm	
		5000K	81 Lm/W	975 Lm	

6" Edge-lit wafer

Catalog Number	Wattage	CCT	Efficacy	Lumens	Equivalency Wattage
WFRL6R139FA120WS	13W	2700K	81 Lm/W	1050 Lm	75W Incandescent
		3000K	85 Lm/W	1100 Lm	
		3500K	88 Lm/W	1150 Lm	
		4000K	92 Lm/W	1190 Lm	
		5000K	92 Lm/W	1190 Lm	

Catalog Number	Wattage	CCT	Efficacy	Lumens	Equivalency Wattage
WFRL6R139FA120WBS WFRL6R139FADWS	13W	2700K	77 Lm/W	1000 Lm	75W Incandescent
		3000K	79 Lm/W	1030 Lm	
		3500K	82 Lm/W	1065 Lm	
		4000K	83 Lm/W	1080 Lm	
		5000K	82 Lm/W	1070 Lm	

Catalog Number	Wattage	CCT	Efficacy	Lumens	Equivalency Wattage
WFRL6R139FA120WB	13W	2700K	77 Lm/W	1000 Lm	75W Incandescent
		3000K	81 Lm/W	1050 Lm	
		3500K	85 Lm/W	1100 Lm	
		4000K	88 Lm/W	1150 Lm	
		5000K	88 Lm/W	1150 Lm	

Field-Adjustable, Edge-Lit Wafer



6" Edge-lit wafer

Catalog Number	Wattage	CCT	Efficacy	Lumens	Equivalency Wattage
WFRL6R139FADWB	13W	2700K	73 Lm/W	950 Lm	75W Incandescent
		3000K	75 Lm/W	980 Lm	
		3500K	78 Lm/W	1010 Lm	
		4000K	79 Lm/W	1030 Lm	
		5000K	78 Lm/W	1015 Lm	

Catalog Number	Wattage	CCT	Efficacy	Lumens	Equivalency Wattage
WFRL6R149FA120WS	14W	2700K	86 Lm/W	1200 Lm	75W Incandescent
		3000K	88 Lm/W	1230 Lm	
		3500K	91 Lm/W	1270 Lm	
		4000K	92 Lm/W	1290 Lm	
		5000K	91 Lm/W	1275 Lm	

Catalog Number	Wattage	CCT	Efficacy	Lumens	Equivalency Wattage
WFRL6R149FA120WB	14W	2700K	82 Lm/W	1150 Lm	75W Incandescent
		3000K	84 Lm/W	1175 Lm	
		3500K	86 Lm/W	1200 Lm	
		4000K	87 Lm/W	1220 Lm	
		5000K	86 Lm/W	1205 Lm	

Catalog Number	Wattage	CCT	Efficacy	Lumens	Equivalency Wattage
WFRL6S139FA120WS	13W	2700K	65 Lm/W	850 Lm	75W Incandescent
		3000K	68 Lm/W	890 Lm	
		3500K	73 Lm/W	945 Lm	
		4000K	74 Lm/W	965 Lm	
		5000K	74 Lm/W	960 Lm	

Catalog Number	Wattage	CCT	Efficacy	Lumens	Equivalency Wattage
WFRL6S139FA120WB	13W	2700K	62 Lm/W	800 Lm	75W Incandescent
		3000K	66 Lm/W	855 Lm	
		3500K	70 Lm/W	910 Lm	
		4000K	71 Lm/W	925 Lm	
		5000K	71 Lm/W	920 Lm	

8" Edge-lit wafer

Catalog Number	Wattage	CCT	Efficacy	Lumens	Equivalency Wattage
WFRL8R239FA120WS WFRL8R239FA120WB WFRL8R239FADWS WFRL8R239FADWB	23W	2700K	78 Lm/W	1800 Lm	100W Incandescent
		3000K	80 Lm/W	1850 Lm	
		3500K	83 Lm/W	1920 Lm	
		4000K	85 Lm/W	1960 Lm	
		5000K	84 Lm/W	1925 Lm	

TECHNICAL SPECIFICATIONS

CONSTRUCTION

Product Type

Edge-lit wafer

Housing Material

Plastic

Housing Finish

White

Trim Style

Smooth or baffle

LED

Edge-lit LED

Beam Angle

110°

Lens

Acrylic light guide distributes light evenly and smoothly for general lighting applications

Gaskets

Gasket included can achieve restrictive airflow and wet location without any additional gasket or caulk

Mounting

Tall retention clips allow for installation in ceilings up to 5/8" thick

Remote Driver/Junction Box

Die cast metal driver / junction box with hinged junction box cover

CCT Selectable dip-switch

Junction box fill capacity (6) #12 AWG 90° C conductors

(4) ½" knock-outs

(3) Push-in connectors for quick and reliable line voltage connections

Integral mounting facilitates direct mounting to building structure or mounting frame

COMPLIANCE

Safety Listing

UL Listed

Environment/Fixture Rating

Wet Location, Enclosed fixture rating

T24 JA8 Compliant

Yes

Lawful for sale in California

Yes

IC Rated

Yes

Energy Star Compliant

Yes

Air Tight

Yes

FCC

Complies with Part 15 of the FCC Rules.

RoHS

Mercury and UV free. RoHS-compliant components.

ELECTRICAL

THD

≤20%

Power Factor

≥0.9

Input Voltage

120V and 120-277V*

Operating Frequency

60Hz

Operating Temperature

-4°F to 104°F (-20°C to 40°C) or -22°F to 104°F (-30°C to 40°C)

See individual spec sheets for operating temperatures

Dimming

Select models with 0-10V or TRIAC/ELV dimming compatibility.

See Dimmer Compatibility List.

Note

All values are typical (tolerance +/- 10%)

OTHER

Color Stability

LED color temperature is warranted to shift no more than 200K in color temperature over a 5-year period.

Color Uniformity

RAB's range of Correlated Color Temperature follows the guidelines of the American National Standard for Specifications for the Chromaticity of Solid State Lighting (SSL) Products, ANSI C78.377-2017.

Warranty

RAB warrants that our LED products will be free from defects in materials and workmanship for a period of five (5) years from the date of delivery to the end user, including coverage of light output, color stability, driver performance and fixture finish.

RAB warranty is subject to all terms and conditions found at: rablighting.com

**Select models only*

Field-Adjustable, Edge-Lit Wafer



DIMENSIONS

Baffle, Round

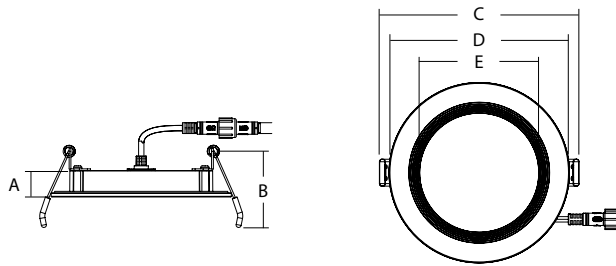

Size	A	B	C	D	E
3"	11/16"	2"	4 5/16"	3 5/8"	2"
4"	11/16"	2"	5 1/4"	4 3/4"	3 1/8"
5"	11/16"	2"	6 5/16"	5 3/4"	4 1/16"
6"	11/16"	2"	7 3/8"	6 13/16"	5"
8"	11/16"	2"	9 9/16"	8 7/8"	6 15/16"

Smooth, Round

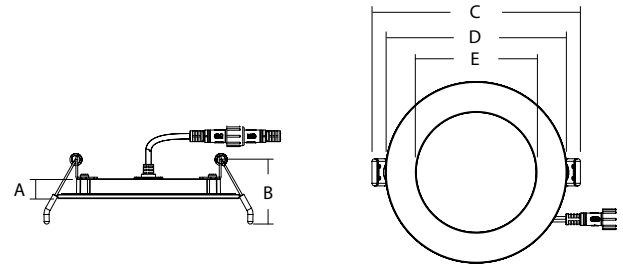

Size	A	B	C	D	E
3"	1/2"	1 3/4"	4 1/4"	3 5/8"	2"
4"	1/2"	1 3/4"	5 1/4"	4 3/4"	3 1/8"
5"	1/2"	1 3/4"	6 3/8"	5 3/4"	4 1/16"
6"	1/2"	1 3/4"	7 3/8"	6 13/16"	5"
8"	1/2"	1 3/4"	9 9/16"	8 7/8"	6 15/16"

Baffle, Square

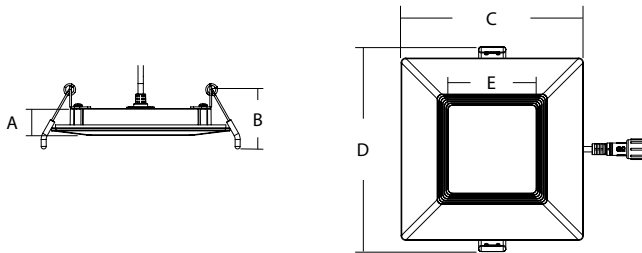

Size	A	B	C	D	E
4"	11/16"	1 9/16"	4 3/4"	5 3/8"	2 5/16"
6"	11/16"	1 5/8"	6 13/16"	7 3/8"	3 5/8"

Smooth, Square

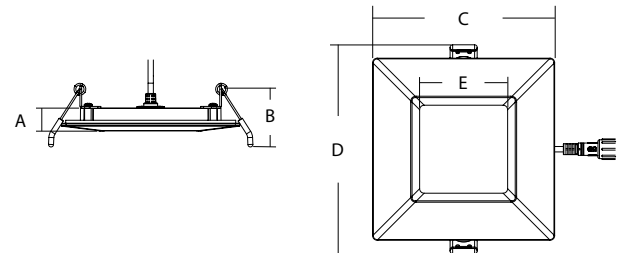

Size	A	B	C	D	E
4"	5/8"	1 9/16"	4 3/4"	5 7/16"	2 5/16"
6"	5/8"	1 5/8"	6 13/16"	7 7/16"	3 5/8"

Shallow Baffle, Round

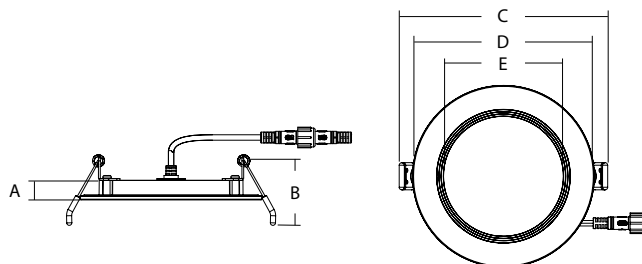

Size	A	B	C	D	E
4"	1/2"	1 3/4"	5 5/16"	4 3/4"	3 1/8"
6"	1/2"	1 3/4"	7 7/16"	6 13/16"	5"

Driver/Junction Box

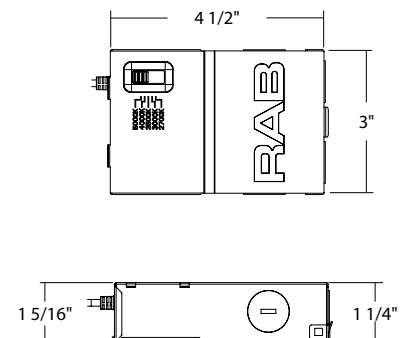

ACCESSORIES

Goof Rings



Catalog Number	UPC	Description
WFRL-GOOF-4R-6R-W	192552013604	For extending 4" wafer to 6"
WFRL-GOOF-6R-8R-W	192552013611	For extending 6" wafer to 8"

Color Trims

3" Round Smooth



Catalog Number	UPC	Description
WFRL-TRIM-3R-BS	192552013628	3" Round Trim, Black
WFRL-TRIM-3R-BRS	192552013635	3" Round Trim, Bronze
WFRL-TRIM-3R-BNS	192552013642	3" Round Trim, Brushed Nickel

4" Round Smooth



Catalog Number	UPC	Description
WFRL-TRIM-4R-BS	192552013659	4" Round Trim, Black
WFRL-TRIM-4R-BRS	192552013666	4" Round Trim, Bronze
WFRL-TRIM-4R-BNS	192552013673	4" Round Trim, Brushed Nickel

4" Square Smooth



Catalog Number	UPC	Description
DLTRIM/WFRL4S-BS	192552023931	4" Square Trim, Smooth, Black
DLTRIM/WFRL4S-BRS	192552023955	4" Square Trim, Smooth, Bronze
DLTRIM/WFRL4S-BNS	192552023948	4" Square Trim, Smooth, Brushed Nickel

4" Square Baffle

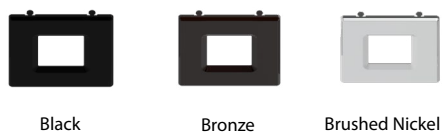

Catalog Number	UPC	Description
DLTRIM/WFRL4S-BB	192552023962	4" Square, Baffle, Trim, Black
DLTRIM/WFRL4S-BRB	192552023986	4" Square Trim, Baffle, Bronze
DLTRIM/WFRL4S-BNB	192552023979	4" Square Trim, Baffle, Brushed Nickel

6" Round Smooth



Catalog Number	UPC	Description
WFRL-TRIM-6R-BS	192552013680	6" Round Trim, Black
WFRL-TRIM-6R-BRS	192552013697	6" Round Trim, Bronze
WFRL-TRIM-6R-BNS	192552013703	6" Round Trim, Brushed Nickel

ACCESSORIES (CONT.)

6" Square Smooth



Black

Bronze

Brushed Nickel

Catalog Number	UPC	Description
DLTRIM/WFRL6S-BS	192552023993	6" Square Trim, Smooth, Black
DLTRIM/WFRL6S-BRS	192552024013	6" Square Trim, Smooth, Bronze
DLTRIM/WFRL6S-BNS	192552024006	6" Square Trim, Smooth, Brushed Nickel

6" Square Baffle



Black

Bronze

Brushed Nickel

Catalog Number	UPC	Description
DLTRIM/WFRL6S-BB	192552024020	6" Square, Baffle, Trim, Black
DLTRIM/WFRL6S-BRB	192552024044	6" Square Trim, Baffle, Bronze
DLTRIM/WFRL6S-BNB	192552024037	6" Square Trim, Baffle, Brushed Nickel

Universal Voltage Driver



Catalog Number	UPC	Description
HAD4/D10	192552025379	Driver 120-277V, 0-10V & TRIAC

Extension Cables



Catalog Number	UPC	Description
EXTCBL-FA-6	019813908502	6' Extension Cable for Wafer FA
EXTCBL-FA-12	019813908519	12' Extension Cable for Wafer FA
EXTCBL-FA-20	019813908526	20' Extension Cable for Wafer FA
EXTCBL-CCT-6	019813908533	6' Extension Cable for Wafer CCT
EXTCBL-CCT-12	019813908540	12' Extension Cable for Wafer CCT
EXTCBL-CCT-20	019813908557	20' Extension Cable for Wafer CCT

Mounting Plate

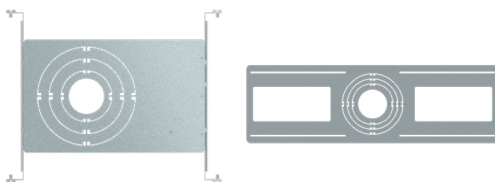

DLPLATE/WFR3468/NB

DLPLATE/WFR3456

Catalog Number	UPC	Description
DLPLATE/WFR3468/NB	192552000673	Mounting plate with nailer bar for 3"/4"/6"/8" Wafers
DLPLATE/WFR3456	192552025584	Mounting plate for 3"/4"/6"/8" Wafers

Note: Not all accessories are compatible with all wafers, see product compatibility list.

Field-Adjustable, Edge-Lit Wafer



ORDERING INFO

Catalog Number	Model Number (Energy Star)	UPC	Case Pack
WFRL3R69CCT120WB	DLW0084(WFRL3R69CCT120WB)	192552018753	6
WFRL3R69CCT120WS	DLW0059(WFRL3R69CCT120WS)	192552013390	6
WFRL4R10.59FA120WB	DLW0075(WFRL4R10.59FA120WB)	192552013451	6
WFRL4R10.59FA120WS	DLW0074(WFRL4R10.59FA120WS)	192552013444	6
WFRL4R99FA120WB	DLW0054(WFRL4R99FA120WB)	019813682464	6
WFRL4R99FA120WBS	DLW0094(WFRL4R99FA120WBS)	192552024266	6
WFRL4R99FA120WS	DLW0053(WFRL4R99FA120WS)	019813682457	6
WFRL4S99FA120WB	DLW0089(WFRL4S99FA120WB)	192552018791	8
WFRL4S99FA120WS	DLW0088(WFRL4S99FA120WS)	192552018784	8
WFRL5R129CCT120WB	DLW0093(WFRL5R129CCT120WB)	192552022316	6
WFRL5R129CCT120WS	DLW0092(WFRL5R129CCT120WS)	192552022309	6
WFRL6R139FA120WB	DLW0056(WFRL6R139FA120WB)	019813682488	6
WFRL6R139FA120WBS	DLW0095(WFRL6R139FA120WBS)	192552024273	6
WFRL6R139FA120WS	DLW0055(WFRL6R139FA120WS)	019813682471	6
WFRL6R139FADWB	DLW0066(WFRL6R139FADWB)	192552013505	6
WFRL6R139FADWS	DLW0067(WFRL6R139FADWS)	192552013512	6
WFRL6R149FA120WB	DLW0077(WFRL6R149FA120WB)	192552013475	6
WFRL6R149FA120WS	DLW0076(WFRL6R149FA120WS)	192552013468	6
WFRL6S139FA120WB	DLW0091(WFRL6S139FA120WB)	192552018814	8
WFRL6S139FA120WS	DLW0090(WFRL6S139FA120WS)	192552018807	8
WFRL8R239FA120WB	DLW0064(WFRL8R239FA120WB)	192552013482	6
WFRL8R239FA120WS	DLW0065(WFRL8R239FA120WS)	192552013499	6
WFRL8R239FADWB	DLW0069(WFRL8R239FADWB)	192552013529	6
WFRL8R239FADWS	DLW0070(WFRL8R239FADWS)	192552013536	6

Field-Adjustable, Edge-Lit Wafer



ORDERING MATRIX

Family	Size	Shape	Wattage	CRI/Color Temp	Voltage	Finish	Trim	Trim Depth
3 INCH								
WFRL	3	R	6	9CCT	120	W		
	3 3"	R Round	6 6W	9CCT 90CRI, 5000K/4000K/3500K/3000K/2700K Field Adjustable	120 120V	W White	B S Baffle Smooth	
4 INCH								
WFRL	4			9FA	120	W		
	4 4"	R Round S Square	9 9W 10.5 10.5W	9FA 90CRI, 5000K/4000K/3500K/3000K/2700K Field Adjustable	120 120V	W White	B S Baffle Smooth	Blank S Standard Shallow*
<i>* Only available with round, baffle trim</i>								
5 INCH								
WFRL	5	R	12	9CCT	120	W		
	5 5"	R Round	12 12W	9CCT 90CRI, 5000K/4000K/3500K/3000K/2700K Field Adjustable	120 120V	W White	B S Baffle Smooth	
6 INCH								
WFRL	6			9FA		W		
	6 6"	R Round S Square	13 13W 14 14W	9FA 90CRI, 5000K/4000K/3500K/3000K/2700K Field Adjustable	120 120V D 120-277V	W White	B S Baffle Smooth	Blank S Standard Shallow*
<i>* Only available with round, baffle trim</i>								
8 INCH								
WFRL	8	R	23	9FA		W		
	8 8"	R Round	23 23W	9FA 90CRI, 5000K/4000K/3500K/3000K/2700K Field Adjustable	120 120V D 120-277V	W White	B S Baffle Smooth	