



# FCC PART 15C TEST REPORT

## BLUETOOTH LOW ENERGY (BLE) PART

No. I21Z62218-IOT02

for

**vivo Mobile Communication Co., Ltd.**

**Mobile Phone**

**Model Name: V2127**

**FCC ID: 2AUCY-V2127V**

with

**Hardware Version: MP\_0.1**

**Software Version: PD2166EF\_EX\_A\_3.6.0**

**Issued Date: 2022-2-15**

**Note:**

The test results in this test report relate only to the devices specified in this report. This report shall not be reproduced except in full without the written approval of CTTL.

The report must not be used by the client to claim product certification, approval, or endorsement by NVLAP, NIST, or any agency of the U.S. Government.

**Test Laboratory:**

**CTTL, Telecommunication Technology Labs, CAICT**

No.52, HuayuanNorth Road, Haidian District, Beijing, P. R. China 100191.

Tel:+86(0)10-62304633-2512,Fax:+86(0)10-62304633-2504

Email:[cttl\\_terminals@caict.ac.cn](mailto:cttl_terminals@caict.ac.cn), website: [www.chinattl.com](http://www.chinattl.com)



## **REPORT HISTORY**

<b>Report Number</b>	<b>Revision</b>	<b>Description</b>	<b>Issue Date</b>
I21Z62218-IOT02	Rev.0	1st edition	2022-2-15

## **CONTENTS**

<b>1. TEST LABORATORY .....</b>	<b>5</b>
1.1. INTRODUCTION & ACCREDITATION .....	5
1.2. TESTING LOCATION .....	5
1.3. TESTING ENVIRONMENT .....	6
1.4. PROJECT DATA .....	6
1.5. SIGNATURE .....	6
<b>2. CLIENT INFORMATION .....</b>	<b>7</b>
2.1. APPLICANT INFORMATION .....	7
2.2. MANUFACTURER INFORMATION .....	7
<b>3. EQUIPMENT UNDER TEST (EUT) AND ANCILLARY EQUIPMENT (AE) .....</b>	<b>8</b>
3.1. ABOUT EUT .....	8
3.2. INTERNAL IDENTIFICATION OF EUT .....	8
3.3. INTERNAL IDENTIFICATION OF AE .....	8
3.4. NORMAL ACCESSORY SETTING .....	9
3.5. GENERAL DESCRIPTION .....	9
<b>4. REFERENCE DOCUMENTS .....</b>	<b>10</b>
4.1. DOCUMENTS SUPPLIED BY APPLICANT .....	10
4.2. REFERENCE DOCUMENTS FOR TESTING .....	10
<b>5. TEST RESULTS .....</b>	<b>11</b>
5.1. SUMMARY OF EUT MODE .....	11
5.2. SUMMARY OF TEST RESULTS .....	11
5.3. STATEMENTS .....	11
5.4. EXPLANATION OF RE-USE OF TEST DATA .....	11
<b>6. TEST FACILITIES UTILIZED .....</b>	<b>12</b>
<b>7. MEASUREMENT UNCERTAINTY .....</b>	<b>13</b>
7.1. PEAK OUTPUT POWER - CONDUCTED .....	13
7.2. FREQUENCY BAND EDGES - CONDUCTED .....	13
7.3. FREQUENCY BAND EDGES - RADIATED .....	13
7.4. TRANSMITTER SPURIOUS EMISSION - CONDUCTED .....	13
7.5. TRANSMITTER SPURIOUS EMISSION - RADIATED .....	13
7.6. 6dB BANDWIDTH .....	13
7.7. MAXIMUM POWER SPECTRAL DENSITY LEVEL .....	14
7.8. AC POWERLINE CONDUCTED EMISSION .....	14
<b>ANNEX A: EUT PARAMETERS .....</b>	<b>15</b>
<b>ANNEX B: DETAILED TEST RESULTS .....</b>	<b>16</b>
B.1. MEASUREMENT METHOD .....	16



B.2. PEAK OUTPUT POWER..... 17

B.3. FREQUENCY BAND EDGES - CONDUCTED ..... 21

B.4. FREQUENCY BAND EDGES –RADIATED..... 23

B.5. TRANSMITTER SPURIOUS EMISSION - CONDUCTED ..... 28

B.6. TRANSMITTER SPURIOUS EMISSION - RADIATED ..... 37

B.7. 6dB BANDWIDTH..... 44

B.8. MAXIMUM POWER SPECTRAL DENSITY LEVEL ..... 47

B.9. AC POWERLINE CONDUCTED EMISSION ..... 50

**ANNEX C: ACCREDITATION CERTIFICATE ..... 57**



## **1. Test Laboratory**

### **1.1. Introduction & Accreditation**

**Telecommunication Technology Labs, CAICT** is an ISO/IEC 17025:2017 accredited test laboratory under NATIONAL VOLUNTARY LABORATORY ACCREDITATION PROGRAM (NVLAP) with lab code 600118-0, and is also an FCC accredited test laboratory (CN5017), and ISED accredited test laboratory (ISED#: 24849). The detail accreditation scope can be found on NVLAP website.

### **1.2. Testing Location**

Conducted testing Location: CTTL(huayuan North Road)

Address: No. 52, Huayuan North Road, Haidian District, Beijing,  
P. R. China100191

Radiated testing Location: CTTL(huayuan North Road)

Address: No. 52, Huayuan North Road, Haidian District, Beijing,  
P. R. China100191

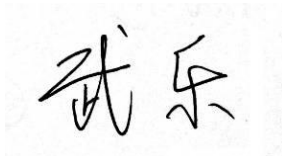
### 1.3. Testing Environment

Normal Temperature: 20-27°C  
Relative Humidity: 20-50%

### 1.4. Project data

Testing Start Date: 2021-12-7  
Testing End Date: 2022-2-15

### 1.5. Signature



---

Wu Le  
(Prepared this test report)



---

Sun Zhenyu  
(Reviewed this test report)



---

Zhu Liang  
(Approved this test report)

## **2. Client Information**

### **2.1. Applicant Information**

Company Name: vivo Mobile Communication Co., Ltd.  
Address /Post: No.1, vivo Road, Chang'an, Dongguan, Guangdong, China  
City: Dongguan  
Postal Code: /  
Country: China  
Telephone: /  
Fax: /

### **2.2. Manufacturer Information**

Company Name: vivo Mobile Communication Co., Ltd.  
Address /Post: No.1, vivo Road, Chang'an, Dongguan, Guangdong, China  
City: Dongguan  
Postal Code: /  
Country: China  
Telephone: /  
Fax: /

### 3. Equipment Under Test (EUT) and Ancillary Equipment (AE)

#### 3.1. About EUT

Description	Mobile Phone
Model Name	V2127
FCC ID	2AUCY-V2127V
Frequency Band	ISM 2400MHz~2483.5MHz
Type of Modulation(LE mode)	GFSK (Bluetooth Low Energy)
Number of Channels(LE mode)	40
Power Supply	3.87V DC by Battery
Antenna gain	-3.0dBi

#### 3.2. Internal Identification of EUT

EUT ID*	SN or IMEI	HW Version	SW Version	Date of receipt
EUT1	861904059951245/ 861904059951252	MP_0.1	PD2166EF_EX_A_3.6.0	2021-12-7
EUT2	861904059966789/ 861904059966797	MP_0.1	PD2166EF_EX_A_3.6.0	2021-12-7

\*EUT ID: is used to identify the test sample in the lab internally.

#### 3.3. Internal Identification of AE

AE ID*	Description		
AE1	Charger	/	/
AE2	Charger	/	/
AE3	Charger	/	/
AE4	Charger	/	/
AE5	Battery	/	Inbuilt
AE7	USB Cable	/	/
AE1			
Model	V1820L0B1-EU		
Manufacturer	Dongguan Aohai Technology Co.,Ltd		
AE2			
Model	V1820L0B1-UK		
Manufacturer	Dongguan Aohai Technology Co.,Ltd.		
AE3			
Model	V1820L0B1-AU		
Manufacturer	Dongguan Aohai Technology Co.,Ltd.		
AE4			
Model	V1820L0B1-US		





Manufacturer	Dongguan Aohai Technology Co.,Ltd
AE5	
Model	B-T6
Manufacturer	Dongguan NVT Technology Co.,Ltd
AE7	
Model	BK-C-32
Manufacturer	vivo

\*AE ID: is used to identify the test sample in the lab internally.

### **3.4. Normal Accessory setting**

Fully charged battery is used during the test.

### **3.5. General Description**

The Equipment Under Test (EUT) is a model of Mobile Phone with integrated antenna. It consists of normal options: lithium battery, charger. Manual and specifications of the EUT were provided to fulfill the test. Samples undergoing test were selected by the Client.

## 4. Reference Documents

### 4.1. Documents supplied by applicant

EUT parameters, referring to Annex A for detailed information, is supplied by the client or manufacturer, which is the basis of testing.

### 4.2. Reference Documents for testing

The following documents listed in this section are referred for testing.

Reference	Title	Version
FCC Part15	FCC CFR 47, Part 15, Subpart C: 15.205 Restricted bands of operation; 15.209 Radiated emission limits, general requirements;	2019
ANSI C63.10	15.247 Operation within the bands 902–928MHz, 2400–2483.5 MHz, and 5725–5850 MHz. American National Standard of Procedures for Compliance Testing of Unlicensed Wireless Devices	June,2013

## 5. Test Results

### 5.1. Summary of EUT Mode

Two modes are provided:

Mode	Conditions
Mode A	1Mbps
Mode B	2Mbps

\*For the test results, the EUT had been tested all conditions. But only the worst case (Mode A) was shown in test report except the "Peak Output Power" test was shown all conditions.

### 5.2. Summary of Test Results

Abbreviations used in this clause:

- P** Pass, The EUT complies with the essential requirements in the standard.
- F** Fail, The EUT does not comply with the essential requirements in the standard
- NA** Not Applicable, The test was not applicable
- NP** Not Performed, The test was not performed by CTTL

SUMMARY OF MEASUREMENT RESULTS	Sub-clause	Verdict
Peak Output Power	15.247 (b)(1)	<b>P</b>
Frequency Band Edges- Conducted	15.247 (d)	<b>P</b>
Frequency Band Edges- Radiated	15.247, 15.205, 15.209	<b>P</b>
Transmitter Spurious Emission - Conducted	15.247 (d)	<b>P</b>
Transmitter Spurious Emission - Radiated	15.247, 15.205, 15.209	<b>P</b>
6dB Bandwidth	15.247 (a)(2)	<b>P</b>
Maximum Power Spectral Density Level	15.247(e)	<b>P</b>
AC Powerline Conducted Emission	15.107, 15.207	<b>P</b>

Please refer to **ANNEX A** for detail.

The measurement is made according to ANSI C63.10.

### 5.3. Statements

CTTL has evaluated the test cases requested by the applicant /manufacturer as listed in section 5.1 of this report for the EUT specified in section 3 according to the standards or reference documents listed in section 4.2

### 5.4. Explanation of re-use of test data

The Equipment Under Test (EUT) model V2127 (FCC ID: 2AUCY-V2127V) is variant product of V2127 (FCC ID: 2AUCY-V2127), according to the declaration of changes provided by the applicant and FCC KDB publication 484596 D01, all test case were performed on this device, (Frequency Band Edges- Radiated, Transmitter Spurious Emission – Radiated and AC Powerline Conducted Emission for BLE 2Mbps results are derived from test report No. I21Z62219-IOT05). For detail differences between two models please refer the Declaration of Changes document.

## 6. Test Facilities Utilized

### Conducted test system

No.	Equipment	Model	Serial Number	Manufacturer	Calibration Period	Calibration Due date
1	Vector Signal Analyzer	FSQ26	100024	R&S	1 year	2022-03-25
2	LISN	ENV216	101200	R&S	1 year	2022-05-30
3	Test Receiver	ESCI 7	100344	R&S	1 year	2022-02-23
4	Shielding Room	S81	/	ETS-Lindgren	/	/

### Radiated emission test system

No.	Equipment	Model	Serial Number	Manufacturer	Calibration Period	Calibration Due date
1	Test Receiver	ESU26	100235	R&S	1 year	2022-02-23
2	BiLog Antenna	VULB9163	01223	Schwarzbeck	1 year	2022-03-22
3	Dual-Ridge Waveguide Horn Antenna	3115	00167250	ETS-Lindgren	1 year	2022-07-11
4	EMI Antenna	3116	2663	ETS-Lindgren	1 year	2022-08-11

## 7. Measurement Uncertainty

### 7.1. Peak Output Power - Conducted

Measurement Uncertainty:

Measurement Uncertainty (k=2)	0.66dB
-------------------------------	--------

### 7.2. Frequency Band Edges - Conducted

Measurement Uncertainty:

Measurement Uncertainty (k=2)	0.66dB
-------------------------------	--------

### 7.3. Frequency Band Edges - Radiated

Measurement Uncertainty:

Measurement Uncertainty (k=2)	/
-------------------------------	---

### 7.4. Transmitter Spurious Emission - Conducted

Measurement Uncertainty:

Frequency Range	Uncertainty (k=2)
30 MHz ~ 8 GHz	1.22dB
8 GHz ~ 12.75 GHz	1.51dB
12.7GHz ~ 26 GHz	1.51dB

### 7.5. Transmitter Spurious Emission - Radiated

Measurement Uncertainty:

Frequency Range	Uncertainty(dBm) (k=2)
9kHz-30MHz	4.92
30MHz ≤ f ≤ 1GHz	5.18
1GHz ≤ f ≤ 18GHz	5.54
18GHz ≤ f ≤ 40GHz	5.26

### 7.6. 6dB Bandwidth

Measurement Uncertainty:

Measurement Uncertainty (k=2)	61.936Hz
-------------------------------	----------



### 7.7. Maximum Power Spectral Density Level

**Measurement Uncertainty:**

Measurement Uncertainty (k=2)	0.66dB
-------------------------------	--------

### 7.8. AC Powerline Conducted Emission

**Measurement Uncertainty:**

Measurement Uncertainty (k=2)	3.08dB
-------------------------------	--------



## **ANNEX A: EUT parameters**

Disclaimer: The antenna gain provided by the client may affect the validity of the measurement results in this report, and the client shall bear the impact and consequences arising therefrom.

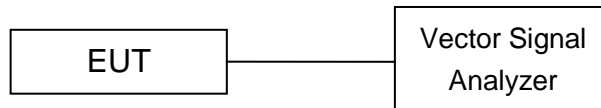
## **ANNEX B: Detailed Test Results**

### **B.1. Measurement Method**

#### **B.1.1. Conducted Measurements**

The measurement is made according to ANSI C63.10.

- 1). Connect the EUT to the test system correctly.
- 2). Set the EUT to the required work mode (Transmitter, receiver or transmitter & receiver).
- 3). Set the EUT to the required channel.
- 4). Set the EUT hopping mode (hopping or hopping off).
- 5). Set the spectrum analyzer to start measurement.
- 6). Record the values. Vector Signal Analyzer



#### **B.1.2. Radiated Emission Measurements**

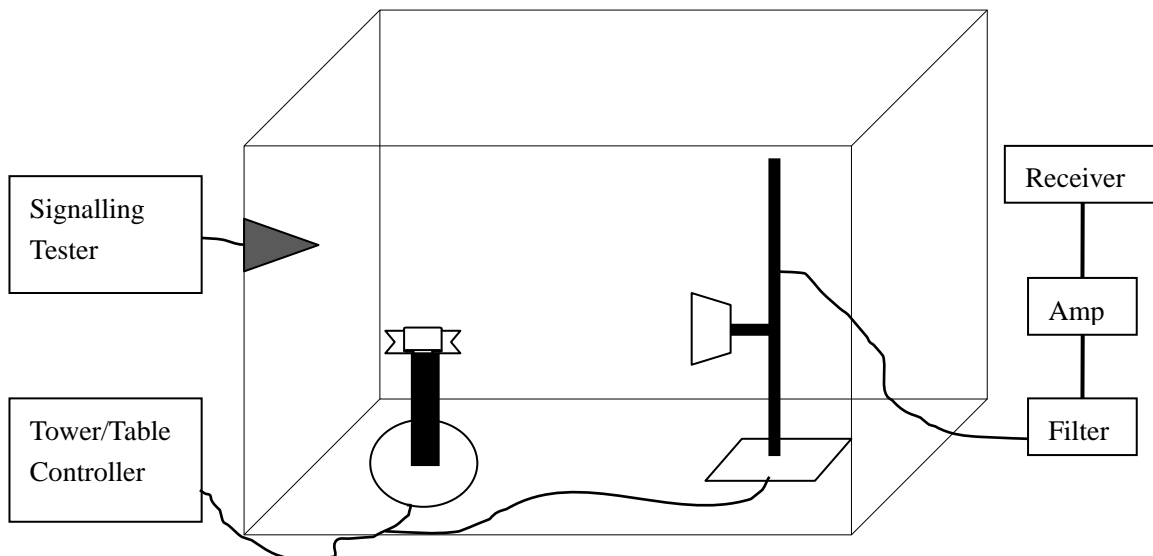
The measurement is made according to ANSI C63.10.

The radiated emission test is performed in semi-anechoic chamber. The distance from the EUT to the reference point of measurement antenna is 3m. The test is carried out on both vertical and horizontal polarization and only maximization result of both polarizations is kept. During the test, the turntable is rotated 360° and the measurement antenna is moved from 1m to 4m to get the maximization result.

In the case of radiated emission, the used settings are as follows,

Sweep frequency from 30 MHz to 1GHz, RBW = 100 kHz, VBW = 300 kHz;

Sweep frequency from 1 GHz to 26GHz, RBW = 1MHz, VBW = 1MHz;





## B.2. Peak Output Power

### B.2.1. Peak Output Power - Conducted

**Method of Measurement: See ANSI C63.10-clause 11.9.1.1**

- a) Set the RBW = 3 MHz.
- b) Set VBW = 10 MHz.
- c) Set span = 10 MHz.
- d) Sweep time = auto couple.
- e) Detector = peak.
- f) Trace mode = max hold.
- g) Allow trace to fully stabilize.
- h) Use peak marker function to determine the peak amplitude level.

#### Measurement Limit:

Standard	Limit (dBm)
FCC Part 15.247(b)(3)	< 30

#### Measurement Results:

##### For GFSK

Sample Rate	Channel No.	Frequency (MHz)	Peak Conducted Output Power (dBm)		Conclusion
1Mbps	0	2402	Fig.1	-3.57	P
	19	2440	Fig.2	-2.37	P
	39	2480	Fig.3	-2.97	P
2Mbps	0	2402	Fig.4	-3.57	P
	19	2440	Fig.5	-2.38	P
	39	2480	Fig.6	-2.98	P

**Conclusion: PASS**

### B.2.2. E.I.R.P.

The radiated E.I.R.P. is listed below:

Antenna gain = -3.0dBi

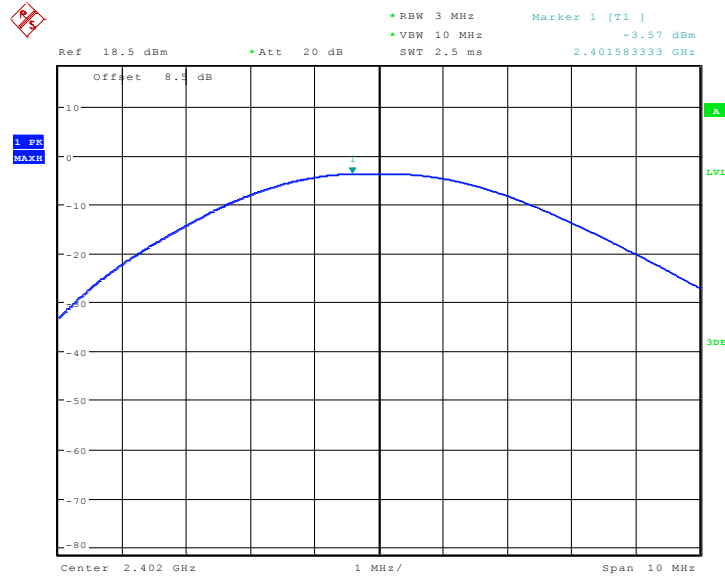
##### For GFSK

Sample Rate	Channel No.	Frequency (MHz)	E.I.R.P. (dBm)	Conclusion
1Mbps	0	2402	-6.57	P
	19	2440	-5.37	P
	39	2480	-5.97	P
2Mbps	0	2402	-6.57	P
	19	2440	-5.38	P
	39	2480	-5.98	P

Note: E.I.R.P. are calculated with the antenna gain.

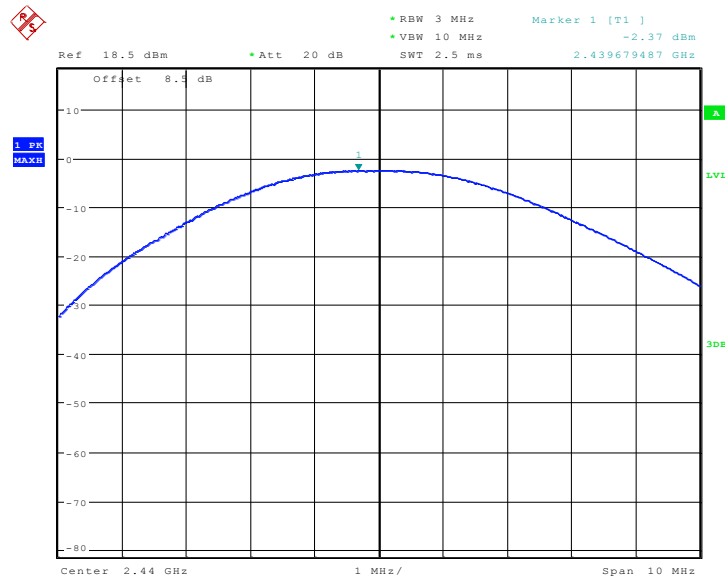
**Conclusion: PASS**

Test graphs as below



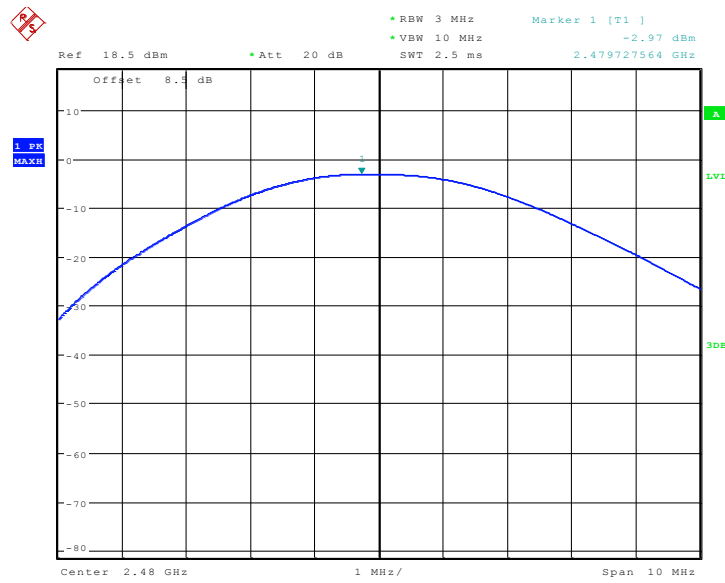
Date: 1..JAN.2000 08:13:34

**Fig.1.** Peak Conducted Output Power: BLE, 1Mbps, Channel 0,



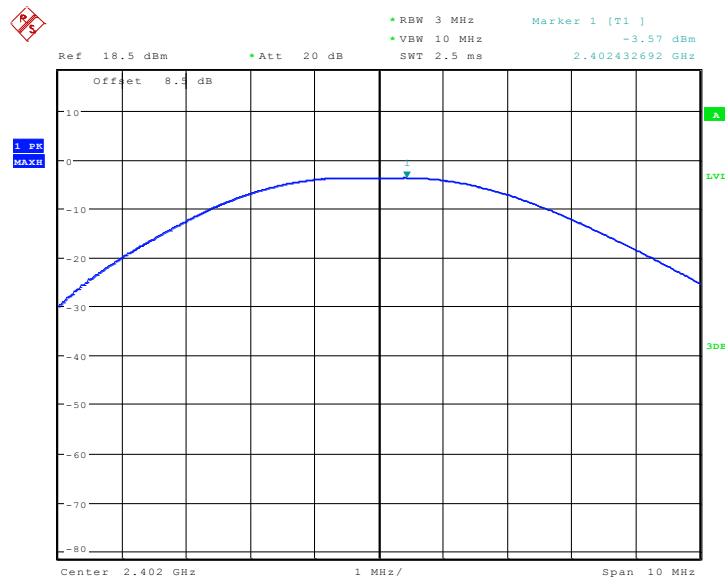
Date: 1..JAN.2000 08:14:23

**Fig.2.** Peak Conducted Output Power: BLE, 1Mbps, Channel 19,



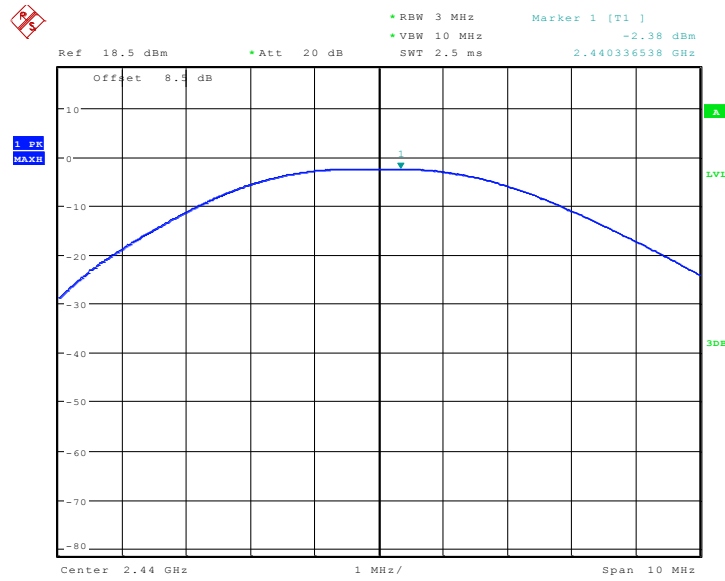
Date: 1.JAN.2000 08:17:05

**Fig.3.** Peak Conducted Output Power: BLE, 1Mbps, Channel 39,



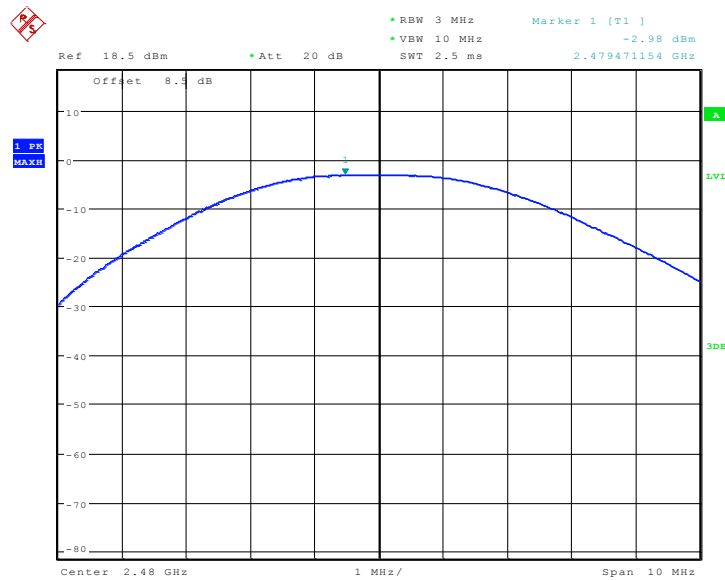
Date: 1.JAN.2000 08:09:39

**Fig.4.** Peak Conducted Output Power: BLE, 2Mbps, Channel 0,



Date: 1.JAN.2000 08:10:33

**Fig.5.** Peak Conducted Output Power: BLE, 2Mbps, Channel 19,



Date: 1.JAN.2000 08:11:04

**Fig.6.** Peak Conducted Output Power: BLE, 2Mbps, Channel 39,

### B.3. Frequency Band Edges - Conducted

**Method of Measurement: See ANSI C63.10-clause 6.10.4**

Connect the spectrum analyzer to the EUT using an appropriate RF cable connected to the EUT output. Configure the spectrum analyzer settings as described below.

- a) Set Span = 8MHz
- b) Sweep Time: Auto
- c) Set the RBW= 100 kHz
- c) Set the VBW= 300 kHz
- d) Detector: Peak
- e) Trace: Max hold

Observe the stored trace and measure the amplitude delta between the peak of the fundamental and the peak of the band-edge emission. This is not an absolute field strength measurement; it is only a relative measurement to determine the amount by which the emission drops at the band edge relative to the highest fundamental emission level.

**Measurement Limit:**

Standard	Limit (dBc)
FCC 47 CFR Part 15.247 (d)	< -20

**Measurement Result:**

**For GFSK**

Channel No.	Frequency (MHz)	Hopping	Band Edge Power ( dBc)		Conclusion
0	2402	Hopping OFF	Fig.7	-51.48	P
39	2480	Hopping OFF	Fig.8	-51.76	P

**Conclusion: PASS**

Test graphs as below

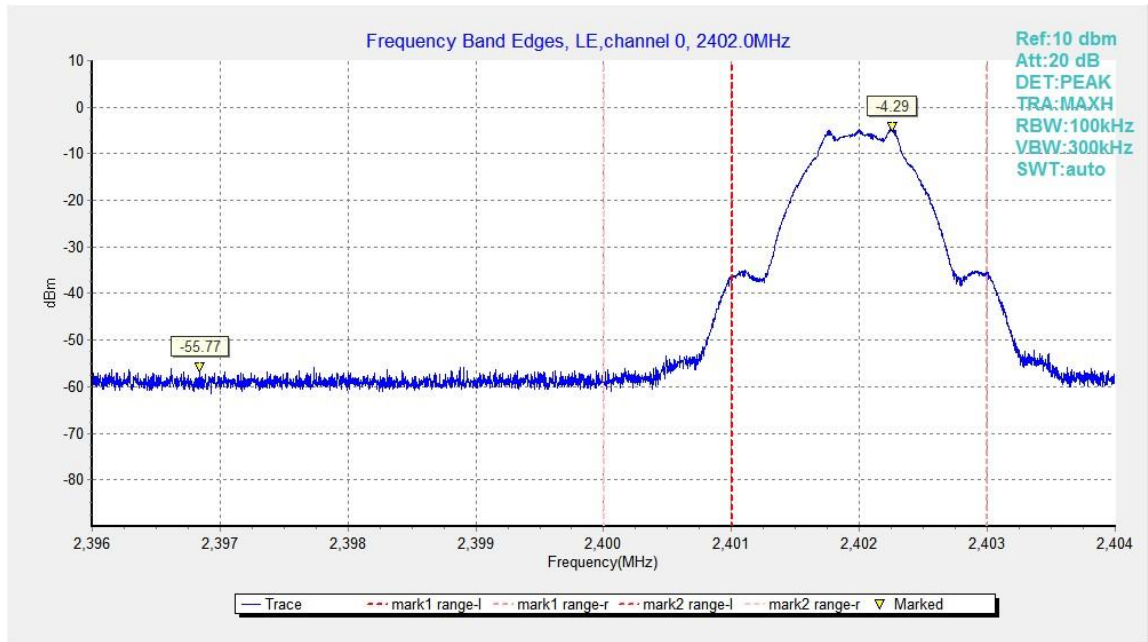


Fig.7. Frequency Band Edges: GFSK, 2402 MHz, Hopping Off

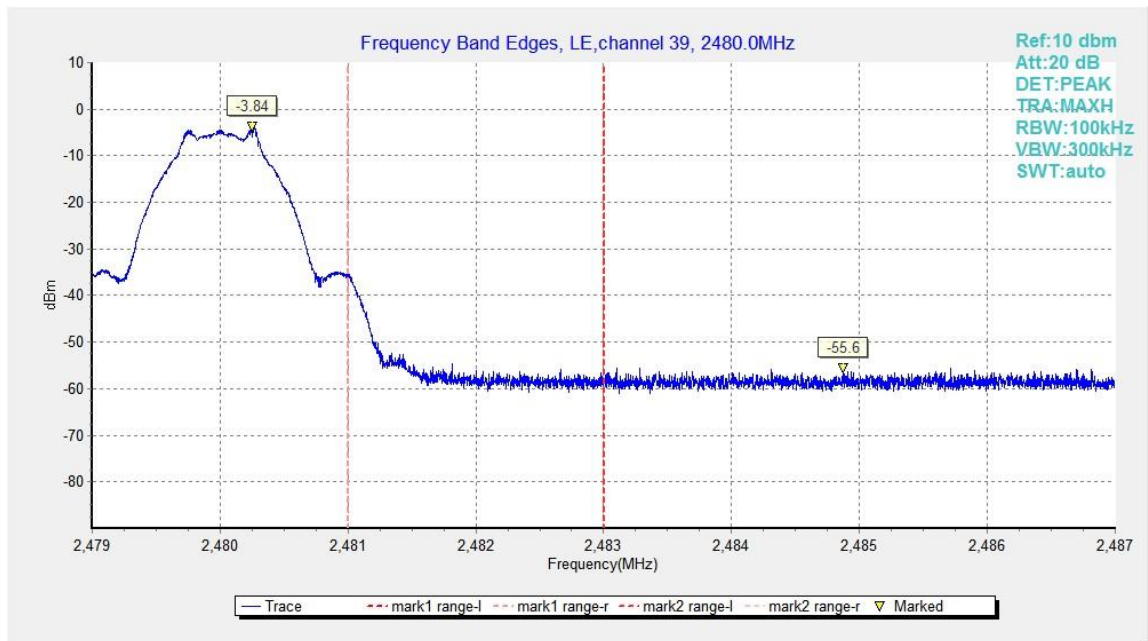


Fig.8. Frequency Band Edges: GFSK, 2480 MHz, Hopping Off

## B.4. Frequency Band Edges –Radiated

**Method of Measurement:** See ANSI C63.10-2013-clause 6.4 &6.5 & 6.6

**Measurement Limit:**

Standard	Limit
FCC 47 CFR Part 15.247, 15.205, 15.209	20dB below peak output power

radiated emissions which fall in the restricted bands, as defined in § 15.205(a), must also comply with the radiated emission limits specified in § 15.209(a) (see § 15.205(c)).

**Limit in restricted band:**

Frequency (MHz)	Field strength( $\mu$ V/m)	Measurement distance (m)
0.009 - 0.490	2400/F(kHz)	300
0.490 - 1.705	24000/F(kHz)	30
1.705 – 30.0	30	30

Frequency of emission (MHz)	Field strength(uV/m)	Field strength(dBuV/m)
30-88	100	40
88-216	150	43.5
216-960	200	46
Above 960	500	54

**Set up:**

Tabletop devices shall be placed on a nonconducting platform with nominal top surface dimensions 1 m by 1.5 m and the table height shall be 1.5 m.

The EUT and transmitting antenna shall be centered on the turntable.

**Test Condition**

The EUT shall be tested 1 near top, 1 near middle, and 1 near bottom. Set the unlicensed wireless device to operate in continuous transmit mode. For unlicensed wireless devices unable to be configured for 100% duty cycle even in test mode, configure the system for the maximum duty cycle supported.

When required for unlicensed wireless devices, measurements of the variation of the input power or the radiated signal level of the fundamental frequency component of the emission, as appropriate, shall be performed with the supply voltage varied between 85% and 115% of the nominal rated supply voltage.

**Exploratory radiated emissions measurements**

Exploratory radiated measurements shall be performed at the measurement distance or at a closer distance than that specified for compliance to determine the emission characteristics of the EUT and, if applicable, the EUT configuration that produces the maximum level of emissions. The frequencies of maximum emission may be determined by manually positioning the antenna close

to the EUT, and then moving the antenna over all sides of the EUT while observing a spectral display. It is advantageous to have prior knowledge of the frequencies of emissions, although this may be determined from such a near-field scan. The near-field scan shall only be used to determine the frequency but not the amplitude of the emissions. Where exploratory measurements are not adequate to determine the worst-case operating modes and are used only to identify the frequencies of the highest emissions, additional preliminary tests can be required.

For emissions from the EUT, the maximum level shall be determined by rotating the EUT and its antenna through 0° to 360°. For each mode of operation required to be tested, the frequency spectrum (based on findings from exploratory measurements) shall be monitored.

Broadband antennas and a spectrum analyzer or a radio-noise meter with a panoramic display are often useful in this type of test. If either antenna height or EUT azimuth are not fully measured during exploratory testing, then complete testing can be required at the OATS or semi-anechoic chamber when the final full spectrum testing is performed.

#### **Final radiated emissions measurements**

The final measurements are using the orientation and equipment arrangement of the EUT based on the measurement results found during the preliminary (exploratory) measurements, the EUT arrangement, appropriate modulation, and modes of operation that produce the emissions that have the highest amplitude relative to the limit shall be selected for the final measurement.

For emissions from the EUT, the maximum level shall be determined by rotating the EUT and its antenna through 0° to 360°. Final measurements for the EUT require a measurement antenna height scan of 1 m to 4 m and the antenna rotated to repeat the measurements for both the horizontal and vertical antenna polarizations. For each mode of operation required to be tested, the frequency spectrum (based on findings from exploratory measurements) shall be monitored.

For each mode selected, record the frequency and amplitude of the highest fundamental emission (if applicable), as well as the frequency and amplitude of the six highest spurious emissions relative to the limit. Emissions more than 20 dB below the limit do not need to be reported.

This maximization process was repeated with the EUT positioned in each of its three orthogonal orientations.

#### **The receiver references:**

Frequency of emission (MHz)	RBW/VBW	Sweep Time(s)
30-1000	100KHz/300KHz	5
1000-4000	1MHz/3MHz	15
4000-18000	1MHz/3MHz	40
18000-26500	1MHz/3MHz	20



EUT ID: EUT1

Measurement Results:

BLE 1Mbps

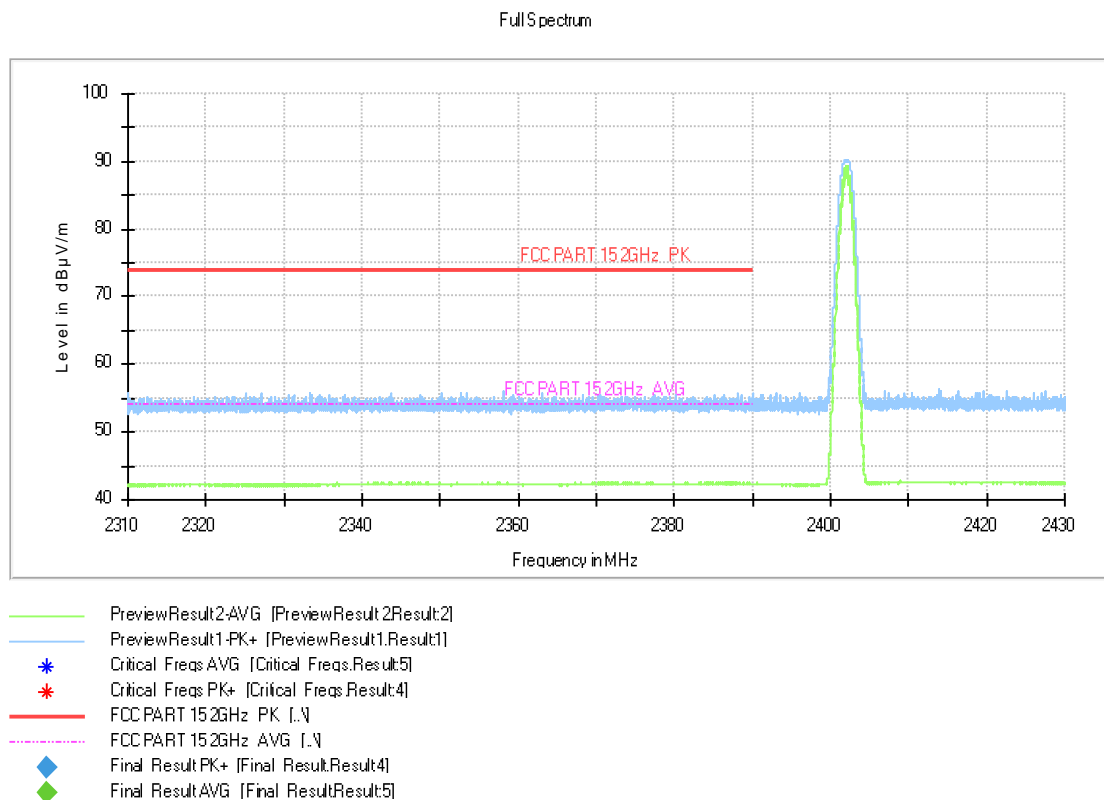
Mode	Channel	Frequency Range	Test Results	Conclusion
GFSK	0	2.38GHz ~2.45GHz	Fig.9	P
	39	2.45GHz ~2.5GHz	Fig.10	P

BLE 2Mbps

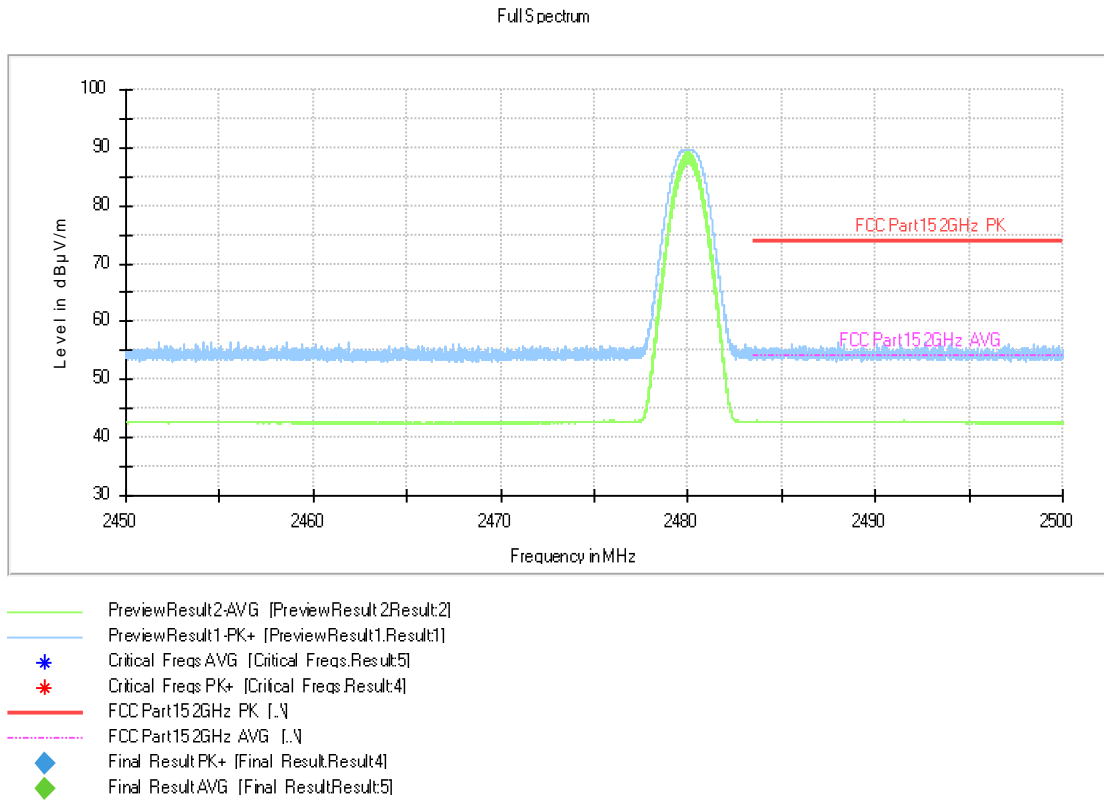
Mode	Channel	Frequency Range	Test Results	Conclusion
GFSK	0	2.38GHz ~2.45GHz	Fig.11	P
	39	2.45GHz ~2.5GHz	Fig.12	P

Conclusion: PASS

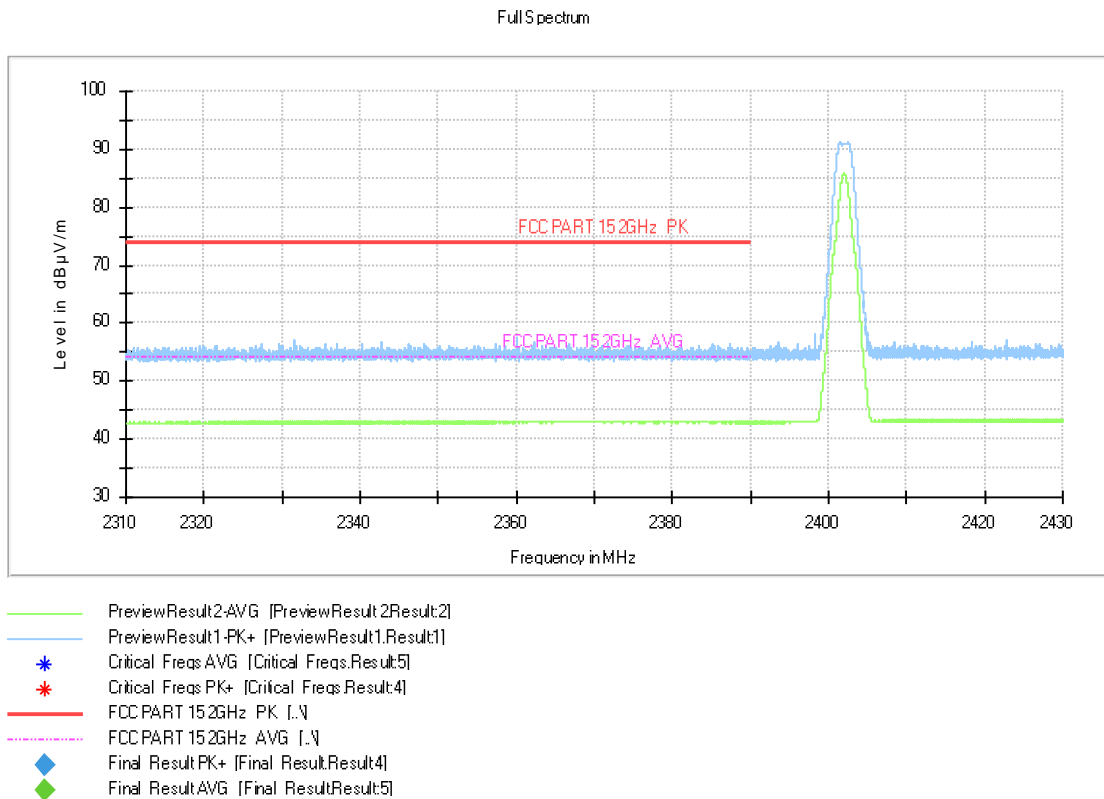
Test graphs as below



**Fig.9. Frequency Band Edges: BLE 1Mbps, GFSK, 2402 MHz, Hopping Off, 2.38 GHz – 2.45GHz**

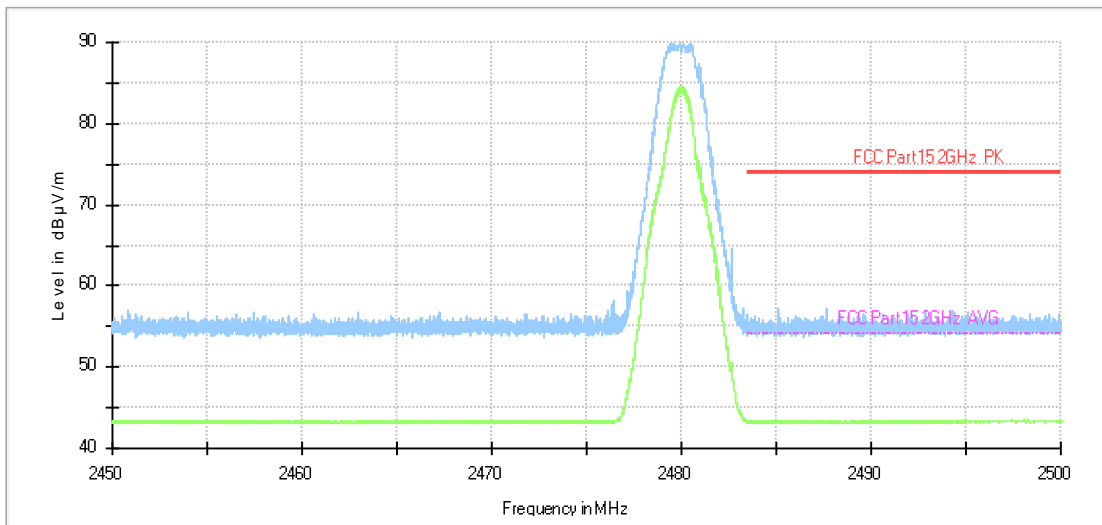


**Fig.10. Frequency Band Edges: BLE 1Mbps GFSK, 2480 MHz, Hopping Off , 2.45 GHz - 2.50GHz**



**Fig.11. Frequency Band Edges: BLE 2Mbps, GFSK, 2402 MHz, Hopping Off, 2.38 GHz - 2.45GHz**

Full Spectrum



- PreviewResult2-AVG [PreviewResult2Result:2]
- PreviewResult1-PK+ [PreviewResult1.Result:1]
- \* Critical Freqs AVG [Critical Freqs.Result:5]
- \* Critical Freqs PK+ [Critical Freqs.Result:4]
- FCC Part15.2GHz PK [..]
- FCC Part15.2GHz AVG [..]
- ◆ Final Result PK+ [Final Result.Result:4]
- ◆ Final Result AVG [Final Result.Result:5]

**Fig.12. Frequency Band Edges: BLE 2Mbps GFSK, 2480 MHz, Hopping Off , 2.45 GHz - 2.50GHz**

## B.5. Transmitter Spurious Emission - Conducted

**Method of Measurement: See ANSI C63.10-clause 11.11.2 and clause 11.11.3**

### Measurement Procedure – Reference Level

1. Set the RBW = 100 kHz.
2. Set the VBW = 300 kHz.
3. Set the span to  $\geq 1.5$  times the DTS bandwidth.
4. Detector = peak.
5. Sweep time = auto couple.
6. Trace mode = max hold.
7. Allow trace to fully stabilize.
8. Use the peak marker function to determine the maximum PSD level. Next, determine the power in 100 kHz band segments outside of the authorized frequency band using the following measurement:

### Measurement Procedure - Unwanted Emissions

1. Set RBW = 100 kHz.
  2. Set VBW = 300 kHz.
  3. Set span to encompass the spectrum to be examined.
  4. Detector = peak.
  5. Trace Mode = max hold.
  6. Sweep = auto couple.
  7. Allow the trace to stabilize (this may take some time, depending on the extent of the span).
- Ensure that the amplitude of all unwanted emissions outside of the authorized frequency band (excluding restricted frequency bands) is attenuated by at least the minimum requirements specified above.

### Measurement Limit:

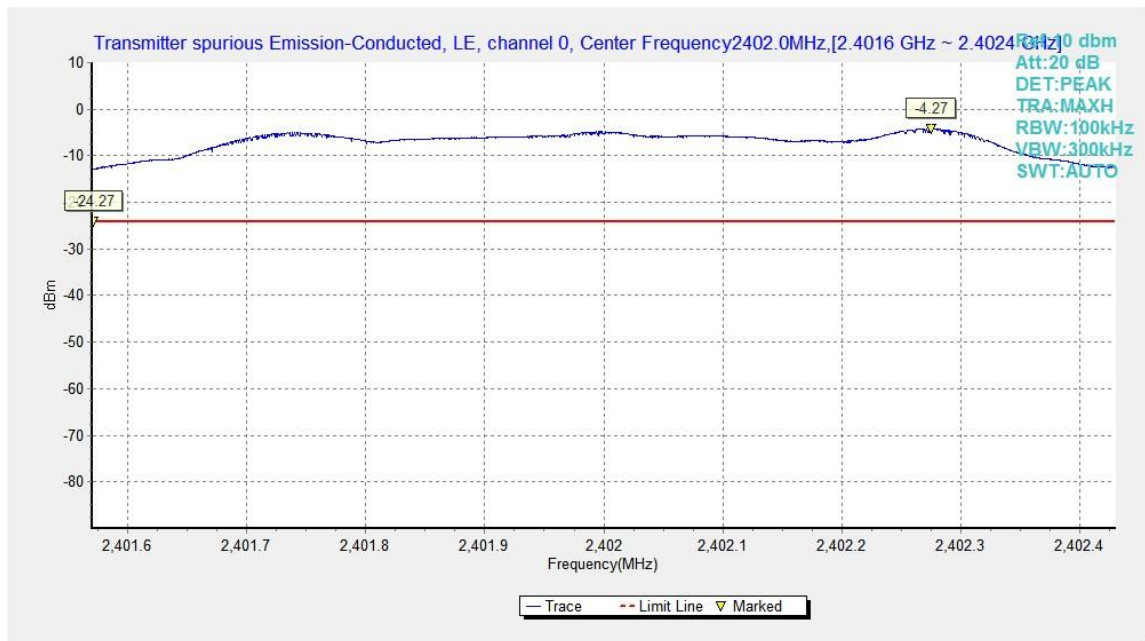
Standard	Limit
FCC 47 CFR Part 15.247 (d)	20dB below peak output power in 100 kHz bandwidth

**Measurement Results:  
For GFSK**

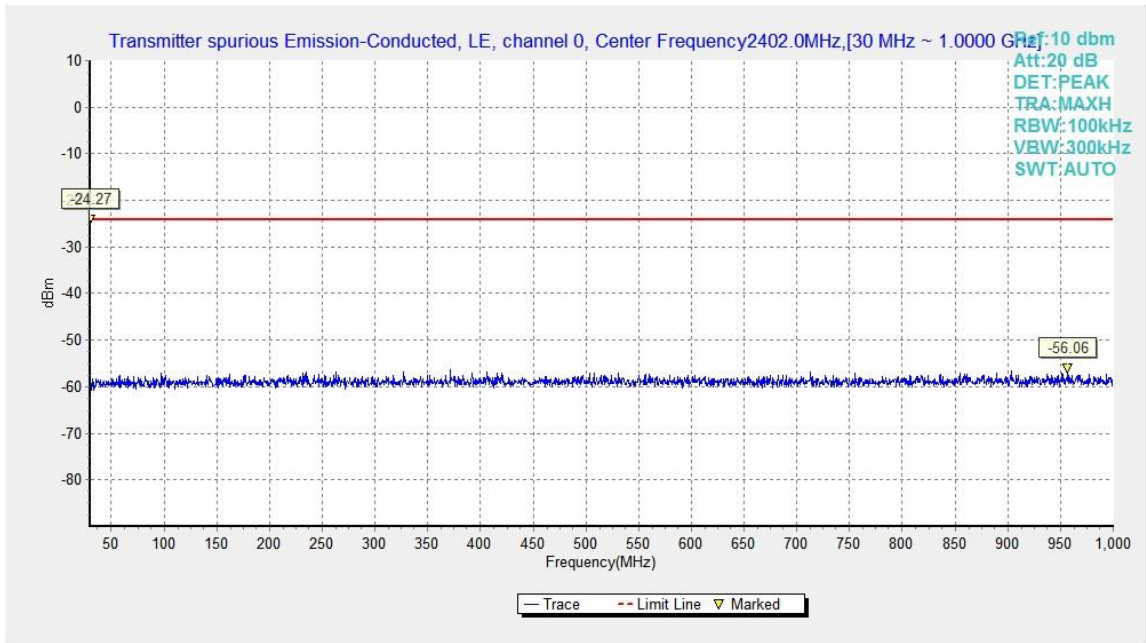
Channel No.	Frequency (MHz)	Frequency Range	Test Results	Conclusion
0	2402	Center Frequency	Fig.13	P
		30 MHz ~ 1 GHz	Fig.14	P
		1 GHz ~ 3 GHz	Fig.15	P
		3 GHz ~ 10 GHz	Fig.16	P
		10GHz ~ 26 GHz	Fig.17	P
19	2440	Center Frequency	Fig.18	P
		30 MHz ~ 1 GHz	Fig.19	P
		1 GHz ~ 3 GHz	Fig.20	P
		3 GHz ~ 10 GHz	Fig.21	P
		10GHz ~ 26 GHz	Fig.22	P
39	2480	Center Frequency	Fig.23	P
		30 MHz ~ 1 GHz	Fig.24	P
		1 GHz ~ 3GHz	Fig.25	P
		3 GHz ~ 10 GHz	Fig.26	P
		10 GHz ~ 26 GHz	Fig.27	P

**Conclusion: PASS**

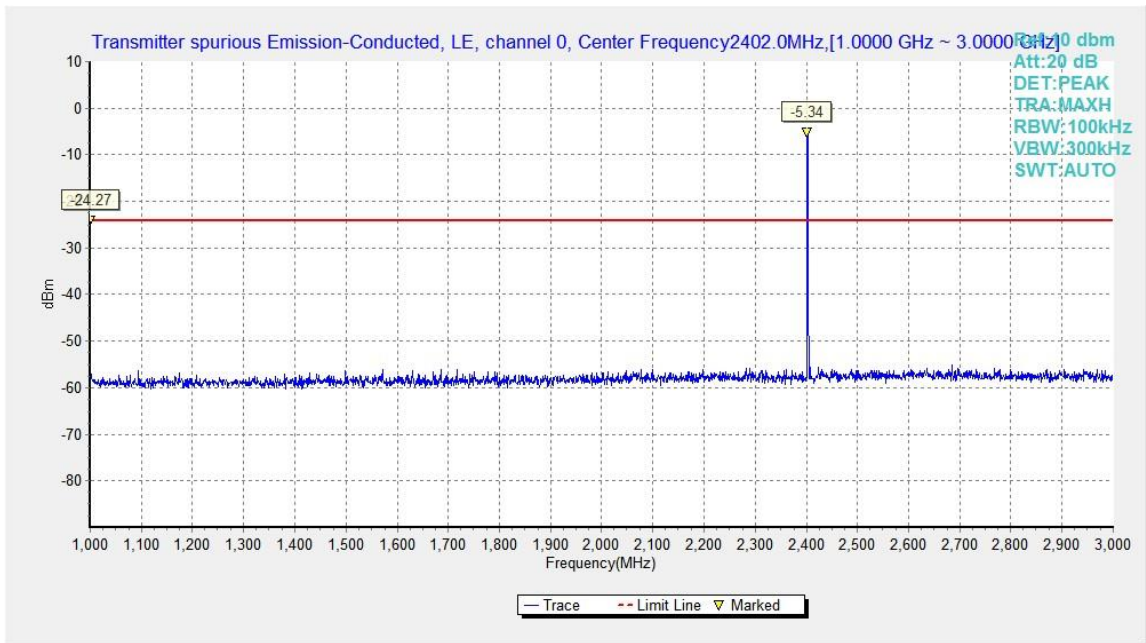
**Test graphs as below**



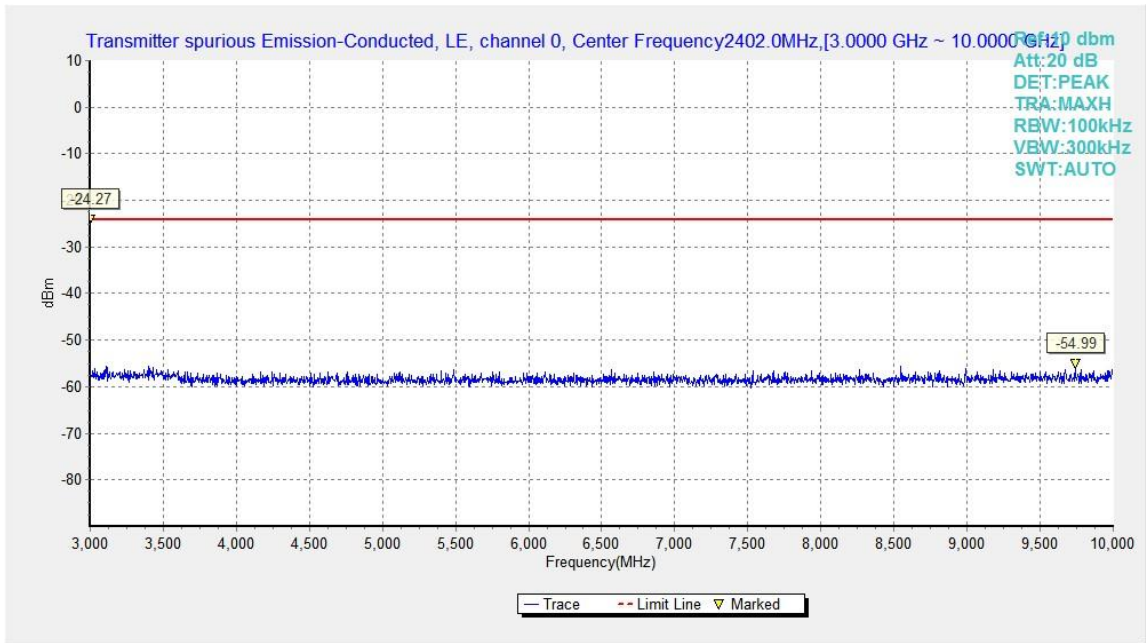
**Fig.13.** Transmitter Spurious Emission - Conducted: GFSK,2402MHz



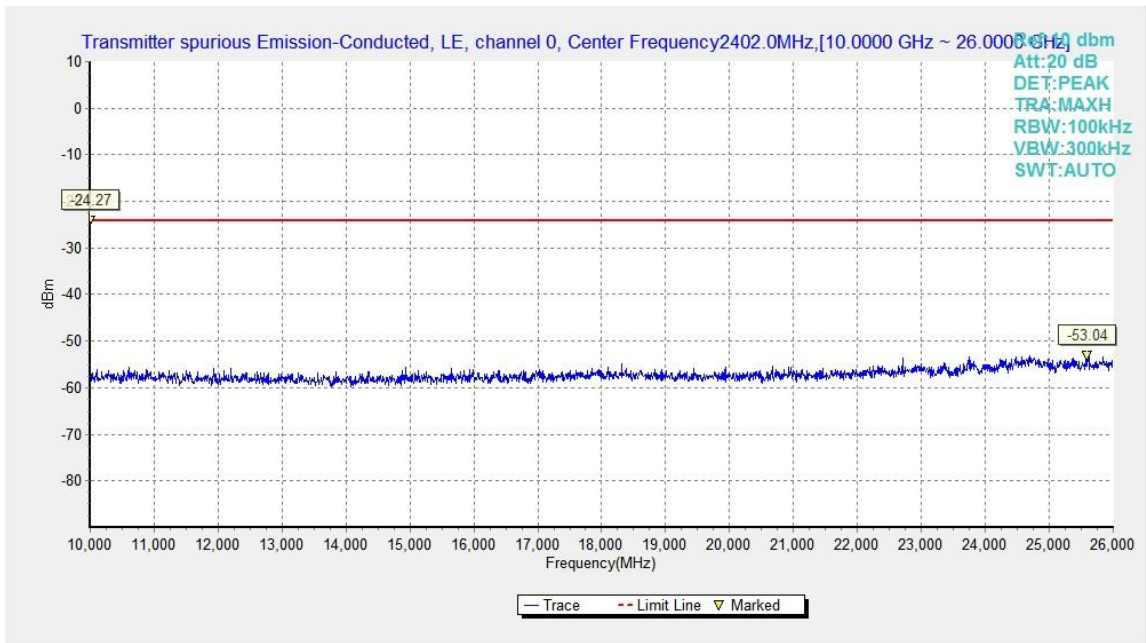
**Fig.14.** Transmitter Spurious Emission - Conducted: GFSK, 2402 MHz, 30MHz - 1GHz



**Fig.15.** Transmitter Spurious Emission - Conducted: GFSK, 2402 MHz, 1GHz - 3GHz

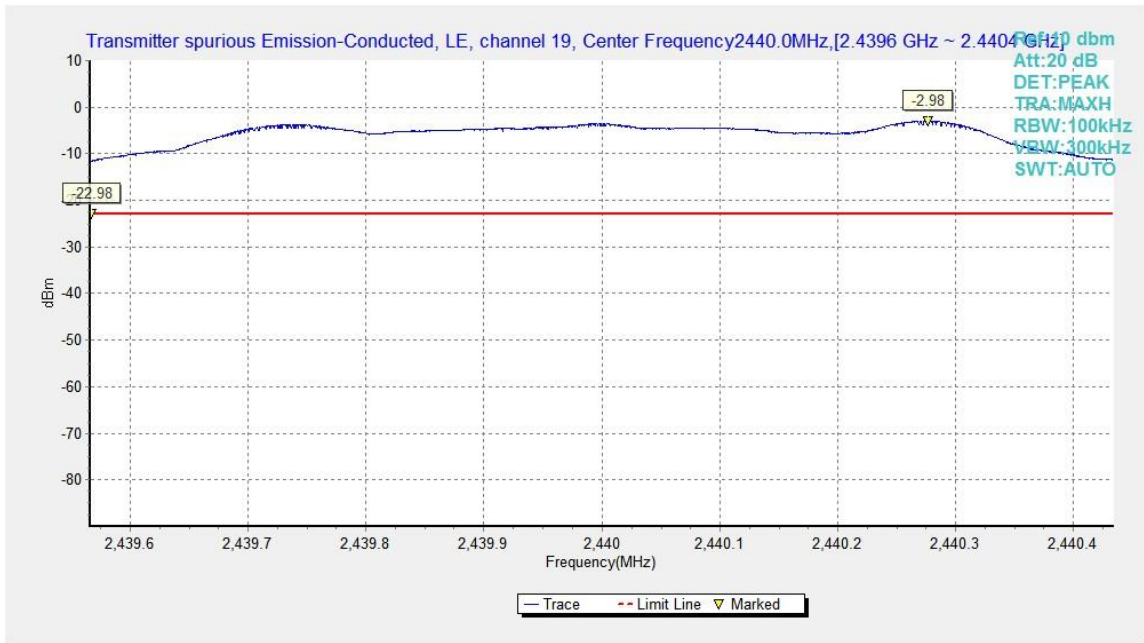


**Fig.16.** Transmitter Spurious Emission - Conducted: GFSK, 2402 MHz,3GHz - 10GHz

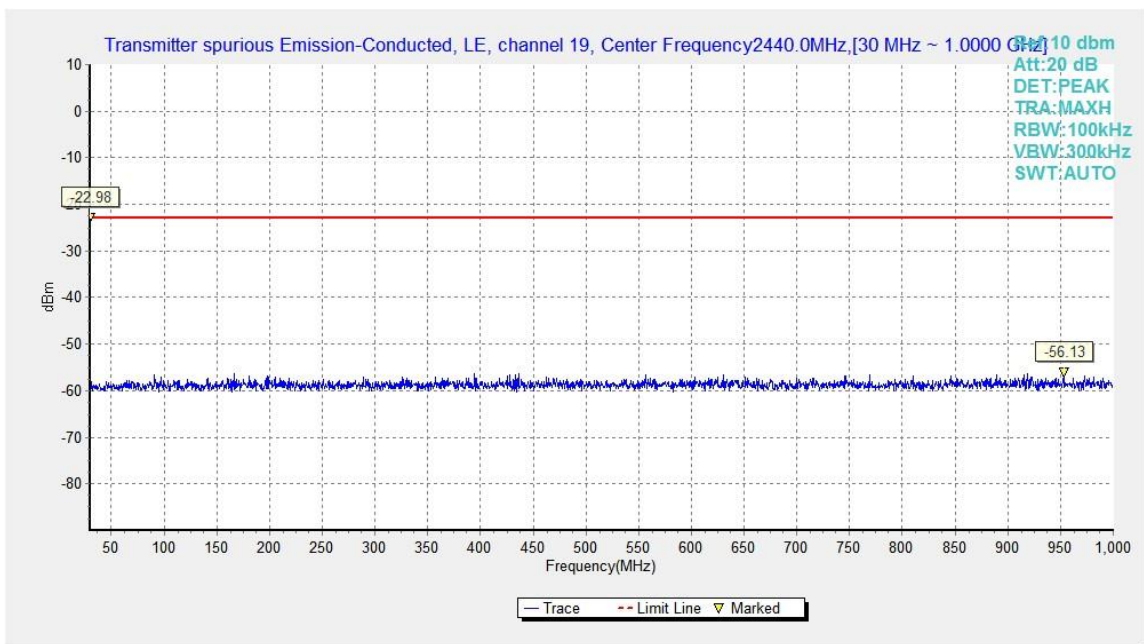


**Fig.17.** Transmitter Spurious Emission - Conducted: GFSK, 2402 MHz,10GHz - 26GHz



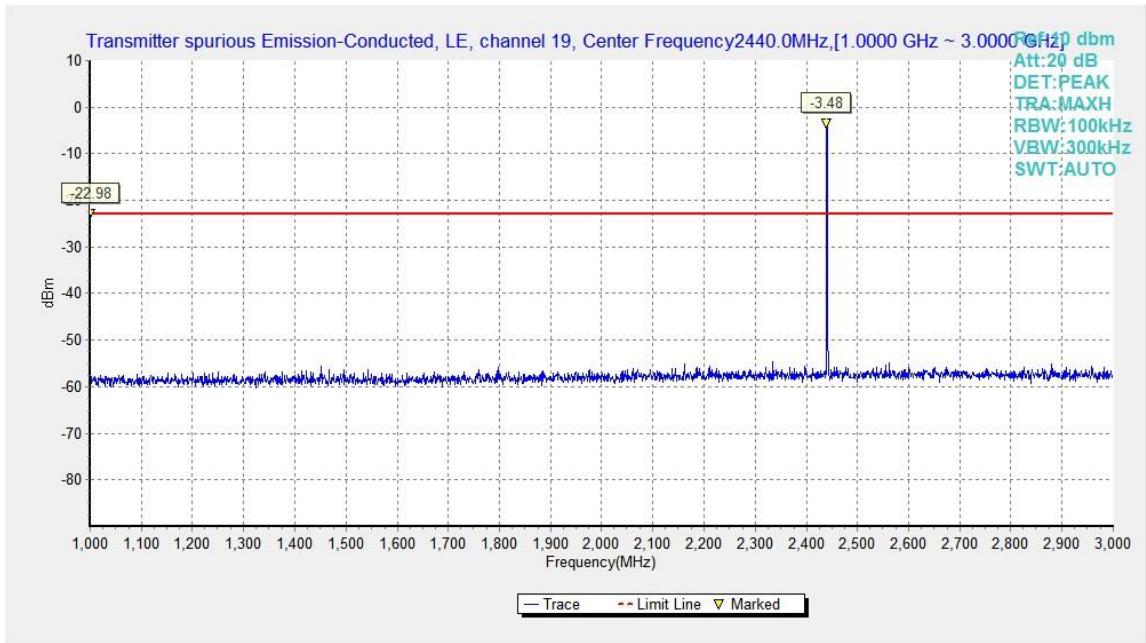


**Fig.18.** Transmitter Spurious Emission - Conducted: GFSK, 2440MHz

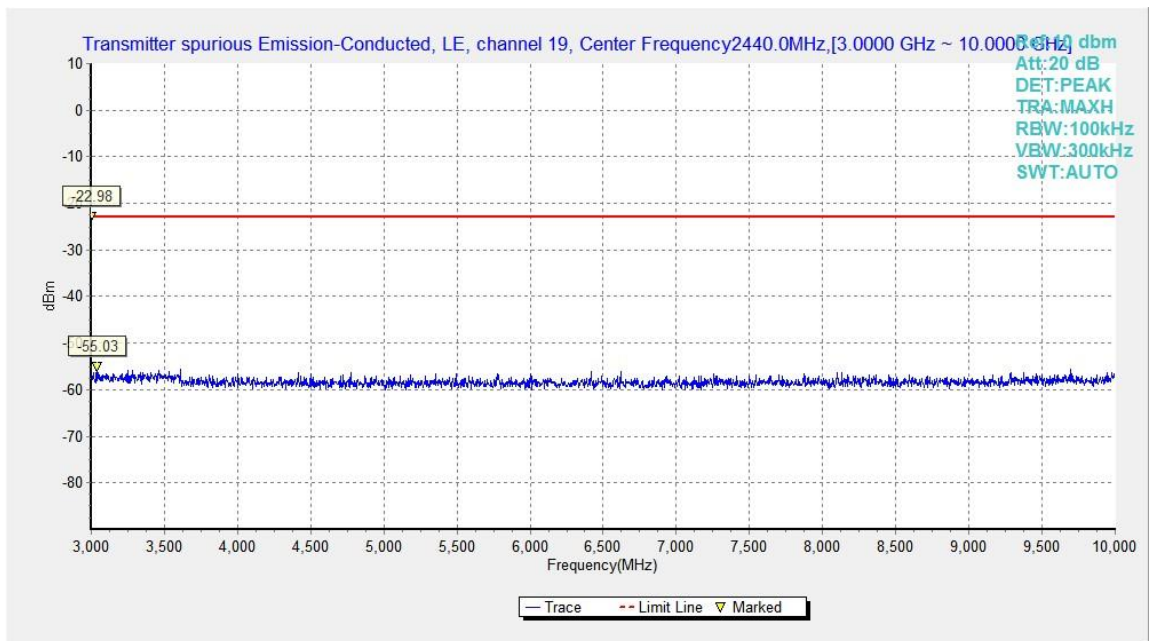


**Fig.19.** Transmitter Spurious Emission - Conducted: GFSK, 2440 MHz, 30MHz - 1GHz

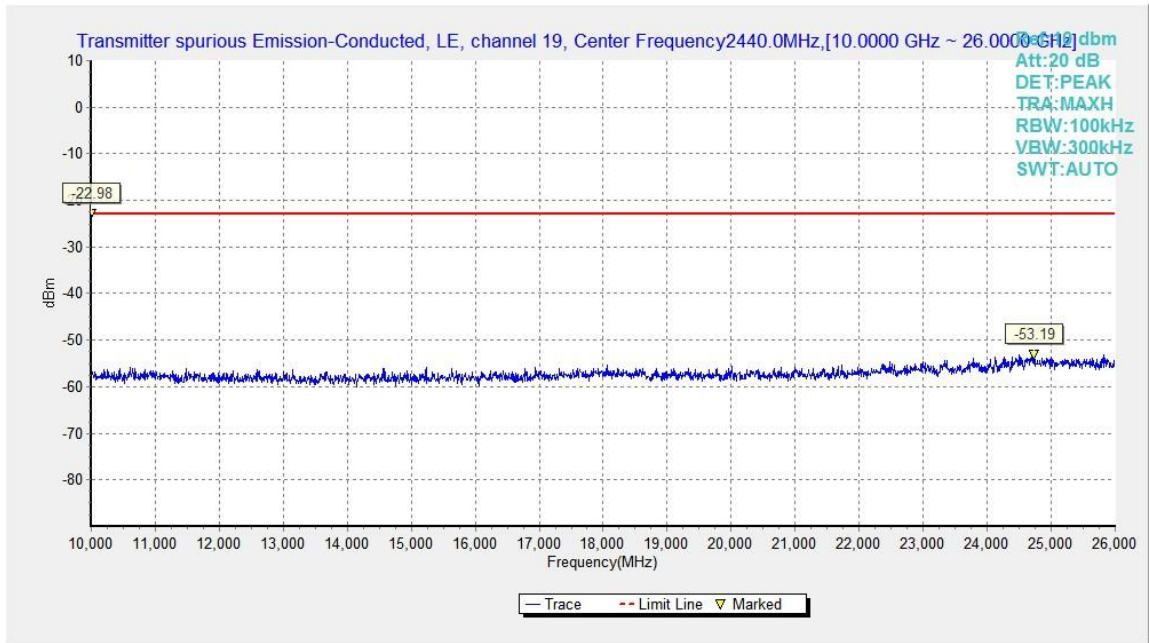




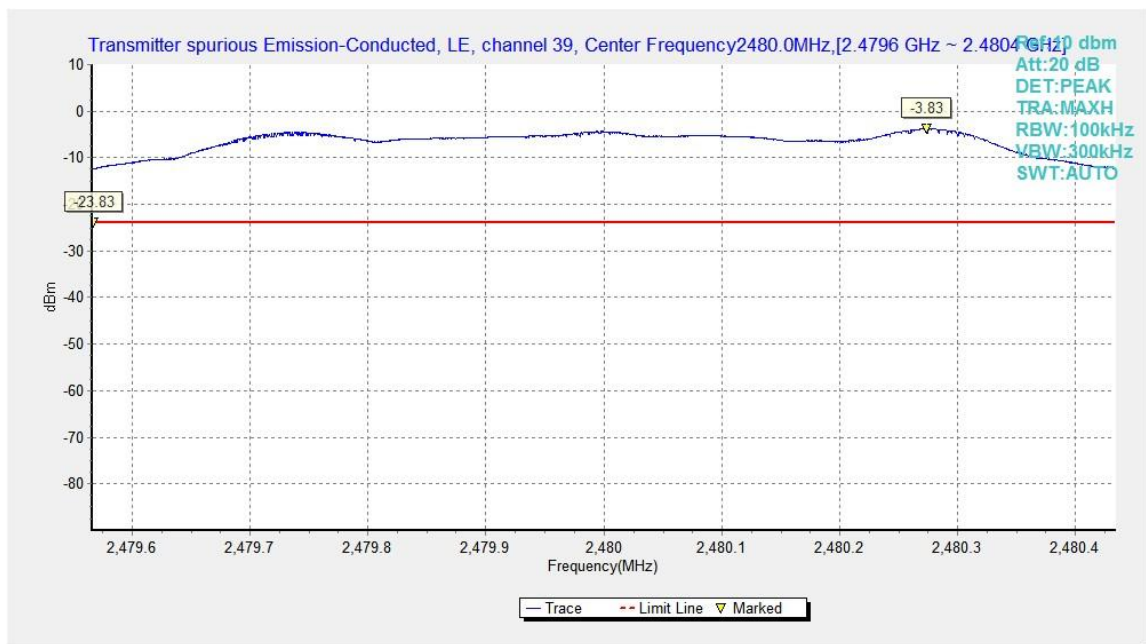
**Fig.20.** Transmitter Spurious Emission - Conducted: GFSK, 2440 MHz, 1GHz – 3GHz



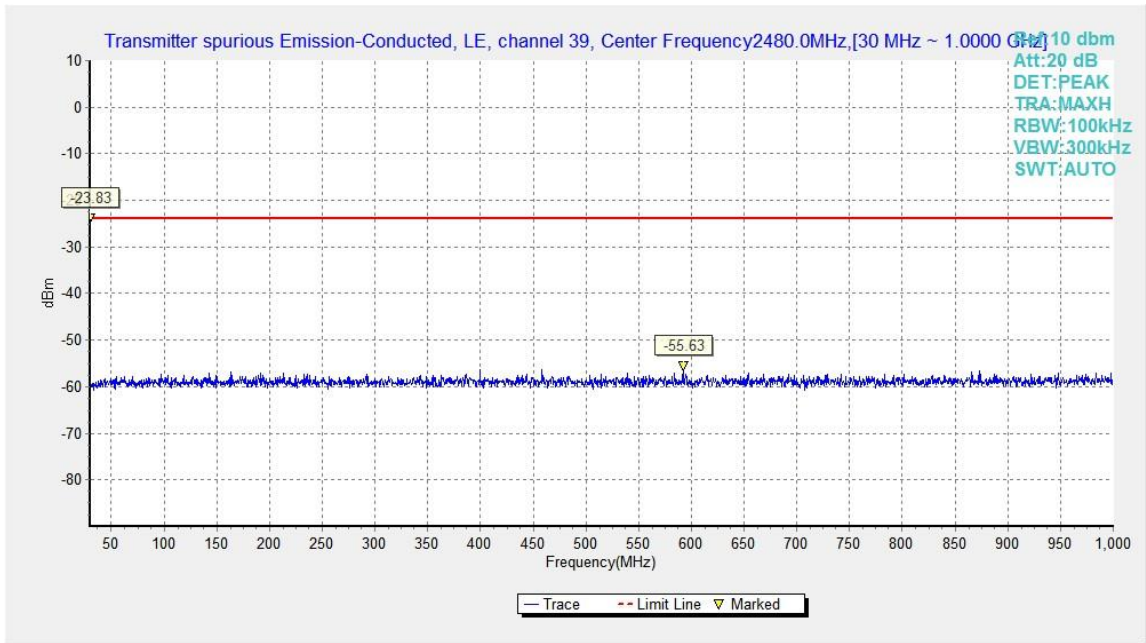
**Fig.21.** Transmitter Spurious Emission - Conducted: GFSK, 2440 MHz, 3GHz – 10GHz



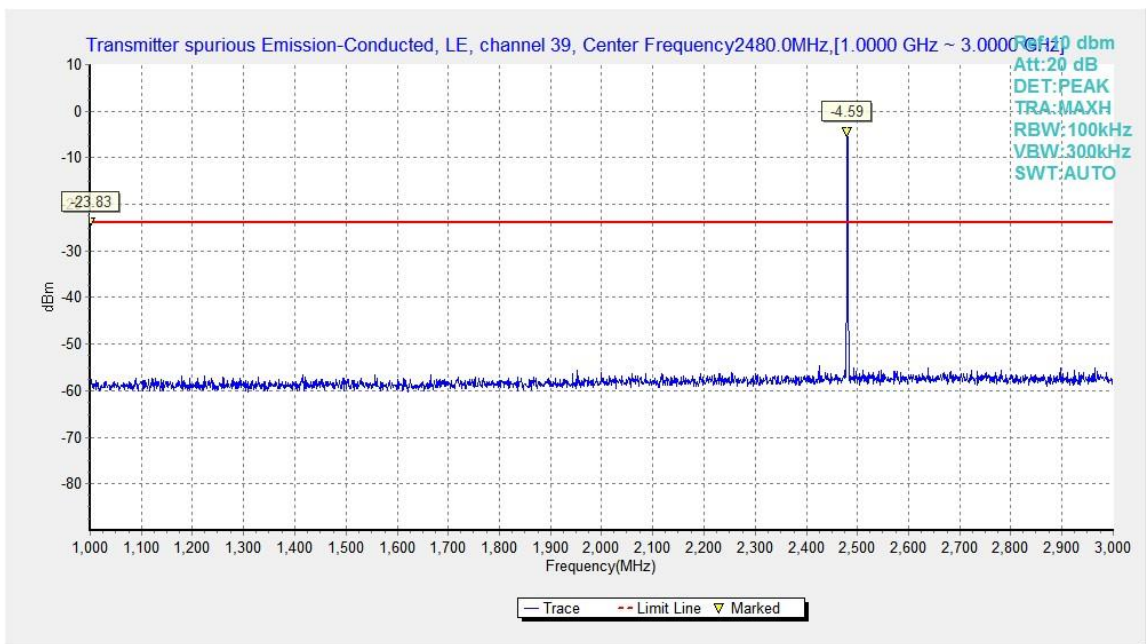
**Fig.22.** Transmitter Spurious Emission - Conducted: GFSK, 2440 MHz, 10GHz – 26GHz



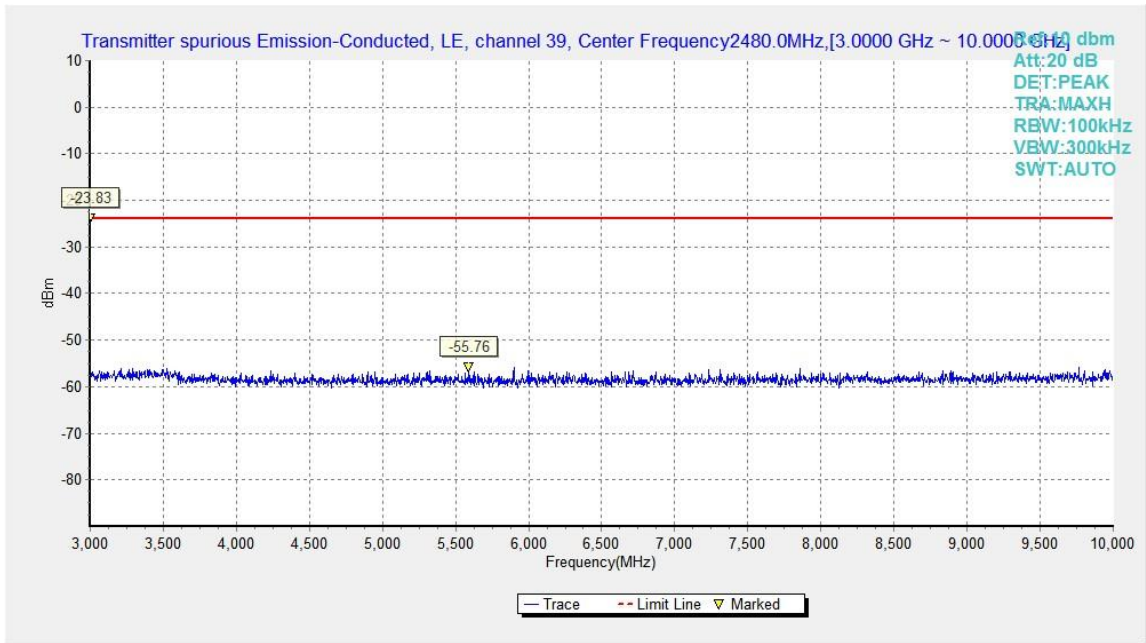
**Fig.23.** Transmitter Spurious Emission - Conducted: GFSK, 2480 MHz



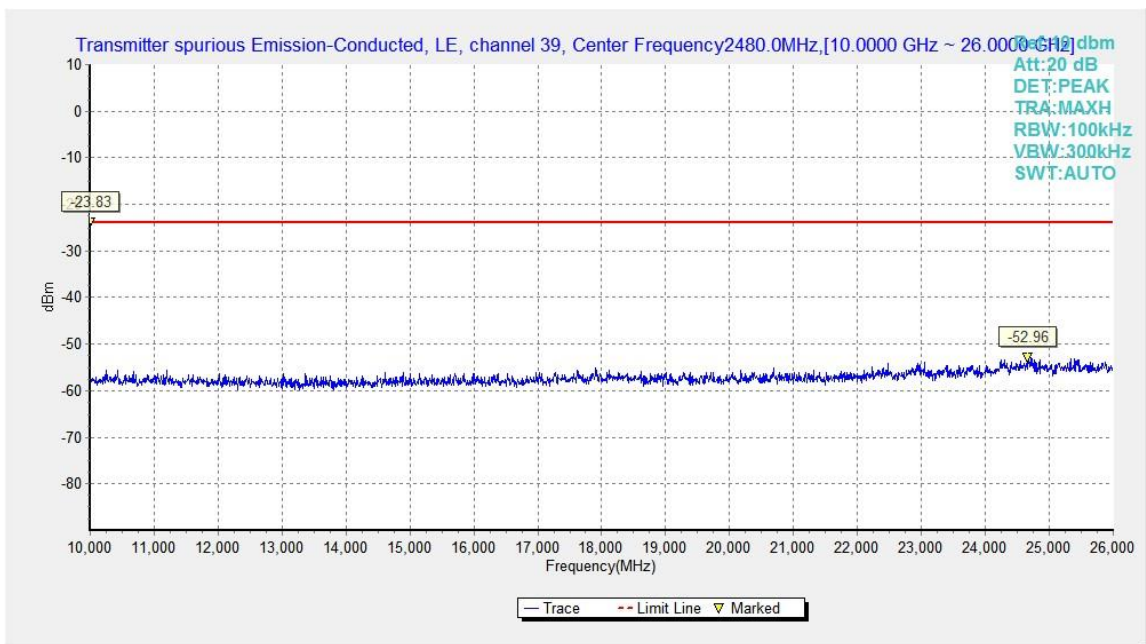
**Fig.24.** Transmitter Spurious Emission - Conducted: GFSK, 2480 MHz, 30MHz - 1GHz



**Fig.25.** Transmitter Spurious Emission - Conducted: GFSK, 2480 MHz, 1GHz - 3GHz



**Fig.26.** Transmitter Spurious Emission - Conducted: GFSK, 2480 MHz, 3GHz - 10GHz



**Fig.27.** Transmitter Spurious Emission - Conducted: GFSK, 2480 MHz, 10GHz - 26GHz

## B.6. Transmitter Spurious Emission - Radiated

**Method of Measurement:** See ANSI C63.10-2013-clause 6.4 & 6.5 & 6.6

**Measurement Limit:**

Standard	Limit
FCC 47 CFR Part 15.247, 15.205, 15.209	20dB below peak output power

radiated emissions which fall in the restricted bands, as defined in § 15.205(a), must also comply with the radiated emission limits specified in § 15.209(a) (see § 15.205(c)).

**Limit in restricted band:**

Frequency (MHz)	Field strength( $\mu$ V/m)	Measurement distance (m)
0.009 - 0.490	2400/F(kHz)	300
0.490 - 1.705	24000/F(kHz)	30
1.705 – 30.0	30	30

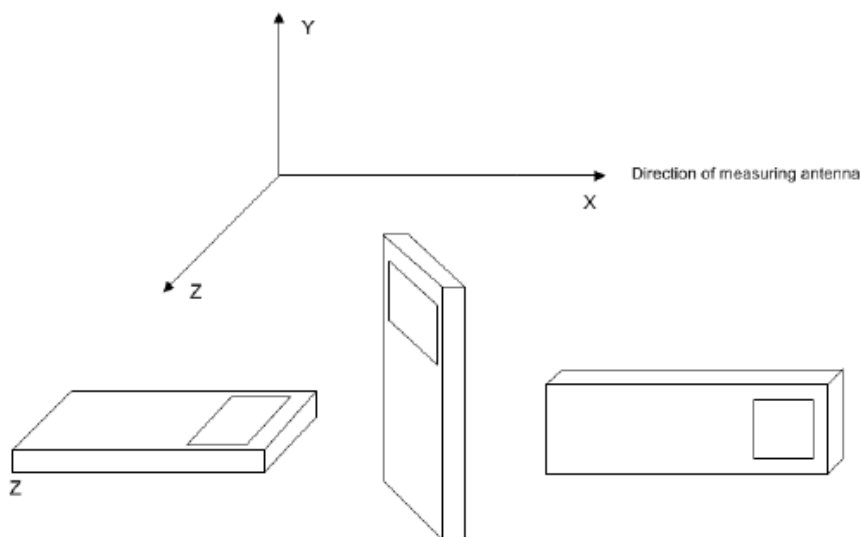
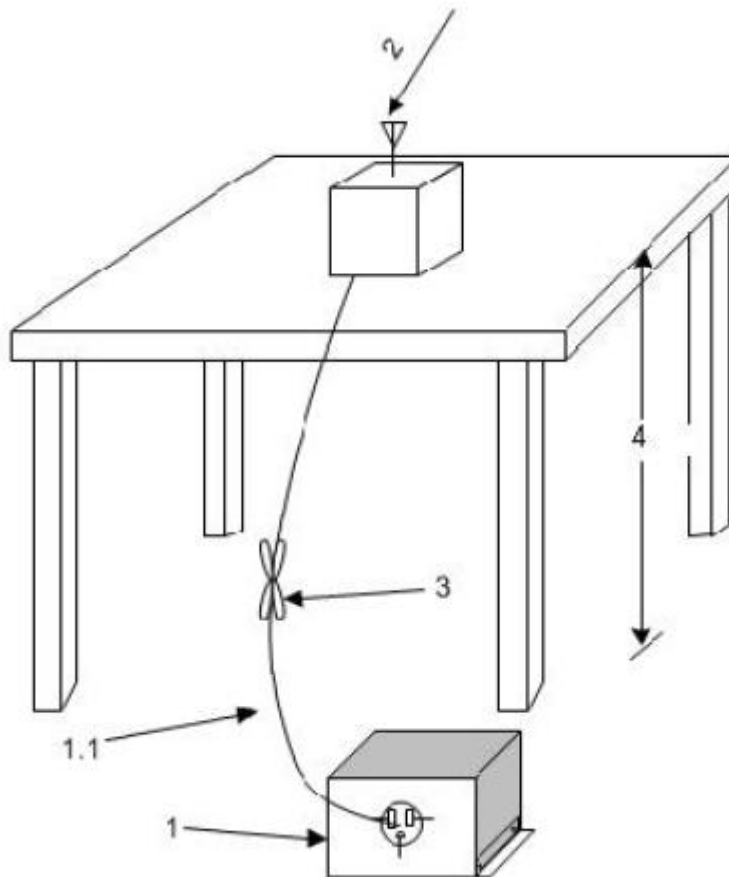
Frequency of emission (MHz)	Field strength( $\mu$ V/m)	Field strength(dBuV/m)
30-88	100	40
88-216	150	43.5
216-960	200	46
Above 960	500	54

**Set up:**

Tabletop devices shall be placed on a nonconducting platform with nominal top surface dimensions 1 m by 1.5 m. For emissions testing at or below 1 GHz, the table height shall be 80 cm above the reference ground plane. For emission measurements above 1 GHz, the table height shall be 1.5 m

The EUT and transmitting antenna shall be centered on the turntable.





**Test Condition**

The EUT shall be tested 1 near top, 1 near middle, and 1 near bottom. Set the unlicensed wireless device to operate in continuous transmit mode. For unlicensed wireless devices unable to be configured for 100% duty cycle even in test mode, configure the system for the maximum duty cycle supported.

When required for unlicensed wireless devices, measurements of the variation of the input power or the radiated signal level of the fundamental frequency component of the emission, as appropriate, shall be performed with the supply voltage varied between 85% and 115% of the

nominal rated supply voltage.

### Exploratory radiated emissions measurements

Exploratory radiated measurements shall be performed at the measurement distance or at a closer distance than that specified for compliance to determine the emission characteristics of the EUT and, if applicable, the EUT configuration that produces the maximum level of emissions. The frequencies of maximum emission may be determined by manually positioning the antenna close to the EUT, and then moving the antenna over all sides of the EUT while observing a spectral display. It is advantageous to have prior knowledge of the frequencies of emissions, although this may be determined from such a near-field scan. The near-field scan shall only be used to determine the frequency but not the amplitude of the emissions. Where exploratory measurements are not adequate to determine the worst-case operating modes and are used only to identify the frequencies of the highest emissions, additional preliminary tests can be required.

For emissions from the EUT, the maximum level shall be determined by rotating the EUT and its antenna through  $0^{\circ}$  to  $360^{\circ}$ . For each mode of operation required to be tested, the frequency spectrum (based on findings from exploratory measurements) shall be monitored.

Broadband antennas and a spectrum analyzer or a radio-noise meter with a panoramic display are often useful in this type of test. If either antenna height or EUT azimuth are not fully measured during exploratory testing, then complete testing can be required at the OATS or semi-anechoic chamber when the final full spectrum testing is performed.

### Final radiated emissions measurements

The final measurements are using the orientation and equipment arrangement of the EUT based on the measurement results found during the preliminary (exploratory) measurements, the EUT arrangement, appropriate modulation, and modes of operation that produce the emissions that have the highest amplitude relative to the limit shall be selected for the final measurement.

For each mode of operation required to be tested, the frequency spectrum (based on findings from exploratory measurements) shall be monitored. The highest signal levels relative to the limit shall be determined by rotating the EUT from  $0^{\circ}$  to  $360^{\circ}$  and with varying the measurement antenna height between 1 m and 4 m in vertical and horizontal polarizations.

For each mode selected, record the frequency and amplitude of the highest fundamental emission (if applicable), as well as the frequency and amplitude of the six highest spurious emissions relative to the limit. Emissions more than 20 dB below the limit do not need to be reported.

This maximization process was repeated with the EUT positioned in each of its three orthogonal orientations.

#### The receiver references:

Frequency of emission (MHz)	RBW/VBW	Sweep Time(s)
30-1000	100KHz/300KHz	5
1000-4000	1MHz/3MHz	15
4000-18000	1MHz/3MHz	40
18000-26500	1MHz/3MHz	20

$P_{Mea}$  is the field strength recorded from the instrument.

The measurement results are obtained as described below:

Result=  $P_{Mea}$  + Cable Loss + Antenna Factor

Where:

$P_{Mea}$  field strength recorded from the instrument

### Average Measurement results

#### BLE 1Mbps GFSK 2402MHz

Frequency (MHz)	Meas. Result (dB $\mu$ V/m)	Cable loss (dB)	Antenna Factor (dB/m)	Receiver Reading (dB $\mu$ V)	Limit (dB $\mu$ V/m)	Margin (dB)	Antenna Pol. (H/V)
17606.000	42.56	-25.70	46.00	22.36	54.00	11.44	H
14181.000	39.11	-29.00	42.00	26.11	54.00	14.89	H
12842.000	37.42	-30.70	39.10	28.92	54.00	16.58	H
9730.500	35.06	-33.00	38.00	30.06	54.00	18.94	H
7993.000	34.18	-34.80	37.10	31.88	54.00	19.82	V
2374.200	42.53	-20.10	28.00	34.53	54.00	11.47	H

#### BLE 1Mbps GFSK 2440MHz

Frequency (MHz)	Meas. Result (dB $\mu$ V/m)	Cable loss (dB)	Antenna Factor (dB/m)	Receiver Reading (dB $\mu$ V)	Limit (dB $\mu$ V/m)	Margin (dB)	Antenna Pol. (H/V)
17918.000	42.54	-25.50	46.70	21.34	54.00	11.46	V
14165.500	38.98	-29.00	42.00	25.98	54.00	15.02	H
12761.000	37.43	-30.50	39.10	28.83	54.00	16.57	V
9098.000	34.79	-33.80	38.10	30.39	54.00	19.21	H
7994.000	34.05	-34.80	37.10	31.75	54.00	19.95	H
4927.500	29.98	-37.10	33.30	33.78	54.00	24.02	H

#### BLE 1Mbps GFSK 2480MHz

Frequency (MHz)	Meas. Result (dB $\mu$ V/m)	Cable loss (dB)	Antenna Factor (dB/m)	Receiver Reading (dB $\mu$ V)	Limit (dB $\mu$ V/m)	Margin (dB)	Antenna Pol. (H/V)
17990.500	42.35	-25.50	46.70	21.15	54.00	11.65	H
13660.000	39.06	-29.50	40.40	28.16	54.00	14.94	V
12857.000	37.65	-30.70	39.10	29.15	54.00	16.35	H
9733.000	34.94	-33.00	38.00	29.94	54.00	19.06	V
7974.000	34.01	-34.80	37.10	31.71	54.00	19.99	H
2492.500	42.86	-20.00	28.30	34.56	54.00	11.14	V



**BLE 2Mbps GFSK 2402MHz**

Frequency (MHz)	Meas. Result (dB $\mu$ V/m)	Cable loss (dB)	Antenna Factor (dB/m)	Receiver Reading (dB $\mu$ V)	Limit (dB $\mu$ V/m)	Margin (dB)	Antenna Pol. (H/V)
17992.50	42.12	-25.50	46.70	20.92	54.00	11.88	H
14180.50	38.88	-29.00	42.00	25.88	54.00	15.12	V
12853.50	37.03	-30.70	39.10	28.53	54.00	16.97	H
9116.00	34.94	-33.80	38.10	30.74	54.00	19.06	H
7987.00	33.77	-34.80	37.10	31.47	54.00	20.23	H
2372.80	43.18	-20.10	28.00	35.18	54.00	10.82	V

**BLE 2Mbps GFSK 2440MHz**

Frequency (MHz)	Meas. Result (dB $\mu$ V/m)	Cable loss (dB)	Antenna Factor (dB/m)	Receiver Reading (dB $\mu$ V)	Limit (dB $\mu$ V/m)	Margin (dB)	Antenna Pol. (H/V)
17999.00	42.14	-25.50	46.70	20.94	54.00	11.86	H
14193.00	38.86	-29.00	42.00	25.86	54.00	15.14	H
12862.50	37.13	-30.70	39.10	28.63	54.00	16.87	H
8991.50	34.81	-33.30	38.20	29.91	54.00	19.19	V
7999.00	33.77	-34.80	37.10	31.47	54.00	20.23	V
4943.00	28.99	-37.10	33.30	32.79	54.00	25.01	H

**BLE 2Mbps GFSK 2480MHz**

Frequency (MHz)	Meas. Result (dB $\mu$ V/m)	Cable loss (dB)	Antenna Factor (dB/m)	Receiver Reading (dB $\mu$ V)	Limit (dB $\mu$ V/m)	Margin (dB)	Antenna Pol. (H/V)
17401.50	42.19	-26.90	45.20	23.79	54.00	11.81	H
13633.00	40.23	-29.50	40.40	29.33	54.00	13.77	H
12874.00	36.98	-30.70	39.10	28.48	54.00	17.02	V
8996.00	34.66	-33.30	38.20	29.76	54.00	19.34	H
7995.50	33.86	-34.80	37.10	31.56	54.00	20.14	H
2499.70	43.48	-20.00	28.40	35.08	54.00	10.52	V

**Peak Measurement results**
**BLE 1Mbps GFSK 2402MHz**

Frequency (MHz)	Meas. Result (dB $\mu$ V/m)	Cable loss (dB)	Antenna Factor (dB/m)	Receiver Reading (dB $\mu$ V)	Limit (dB $\mu$ V/m)	Margin (dB)	Antenna Pol. (H/V)
17970.000	54.05	-25.50	46.70	32.85	74.00	19.95	H
13676.500	50.96	-29.50	40.40	40.06	74.00	23.04	H
12347.500	48.89	-31.10	38.90	41.09	74.00	25.11	H
9195.000	46.96	-33.80	38.10	42.76	74.00	27.04	V
7211.000	45.52	-35.50	36.40	44.62	74.00	28.48	H
2358.200	56.08	-20.10	28.00	48.08	74.00	17.92	V

**BLE 1Mbps GFSK 2440MHz**

Frequency (MHz)	Meas. Result (dB $\mu$ V/m)	Cable loss (dB)	Antenna Factor (dB/m)	Receiver Reading (dB $\mu$ V)	Limit (dB $\mu$ V/m)	Margin (dB)	Antenna Pol. (H/V)
17574.000	53.75	-25.70	46.00	33.55	74.00	20.25	V
14172.000	50.40	-29.00	42.00	37.40	74.00	23.60	H
12929.000	49.30	-30.50	39.20	40.60	74.00	24.70	V
8817.500	46.35	-33.90	38.10	42.15	74.00	27.65	V
7975.000	45.56	-34.80	37.10	43.26	74.00	28.44	V
4988.500	40.56	-36.60	33.40	43.76	74.00	33.44	H

**BLE 1Mbps GFSK 2480MHz**

Frequency (MHz)	Meas. Result (dB $\mu$ V/m)	Cable loss (dB)	Antenna Factor (dB/m)	Receiver Reading (dB $\mu$ V)	Limit (dB $\mu$ V/m)	Margin (dB)	Antenna Pol. (H/V)
17969.500	54.01	-25.50	46.70	32.81	74.00	19.99	H
13828.500	50.63	-29.10	40.90	38.83	74.00	23.37	H
12840.000	49.42	-30.70	39.10	40.92	74.00	24.58	H
9122.000	46.36	-33.80	38.10	42.16	74.00	27.64	H
7886.500	45.78	-34.90	37.10	43.58	74.00	28.22	V
2492.700	56.45	-20.00	28.30	48.15	74.00	17.55	H

**BLE 2Mbps GFSK 2402MHz**

Frequency (MHz)	Meas. Result (dB $\mu$ V/m)	Cable loss (dB)	Antenna Factor (dB/m)	Receiver Reading (dB $\mu$ V)	Limit (dB $\mu$ V/m)	Margin (dB)	Antenna Pol. (H/V)
17225.50	54.74	-25.90	44.40	36.34	74.00	19.26	H
14191.50	51.60	-29.00	42.00	38.60	74.00	22.40	H
12918.50	49.18	-30.50	39.20	40.48	74.00	24.82	H
9819.00	47.82	-33.50	38.00	43.32	74.00	26.18	H
7400.00	47.25	-35.20	36.70	45.65	74.00	26.75	V
2360.50	57.06	-20.10	28.00	49.06	74.00	16.94	V

**BLE 2Mbps GFSK 2440MHz**

Frequency (MHz)	Meas. Result (dB $\mu$ V/m)	Cable loss (dB)	Antenna Factor (dB/m)	Receiver Reading (dB $\mu$ V)	Limit (dB $\mu$ V/m)	Margin (dB)	Antenna Pol. (H/V)
17577.50	54.78	-25.70	46.00	34.58	74.00	19.22	V
14187.50	51.05	-29.00	42.00	38.05	74.00	22.95	V
12870.50	49.61	-30.70	39.10	41.11	74.00	24.39	H
9134.50	48.12	-33.80	38.10	43.92	74.00	25.88	H
7688.00	46.54	-34.70	36.90	44.24	74.00	27.46	H
4787.00	42.01	-37.30	33.00	46.21	74.00	31.99	V

**BLE 2Mbps GFSK 2480MHz**

Frequency (MHz)	Meas. Result (dB $\mu$ V/m)	Cable loss (dB)	Antenna Factor (dB/m)	Receiver Reading (dB $\mu$ V)	Limit (dB $\mu$ V/m)	Margin (dB)	Antenna Pol. (H/V)
17937.00	54.68	-25.50	46.70	33.48	74.00	19.32	V
13741.50	51.17	-29.10	40.90	39.37	74.00	22.83	H
12930.50	49.52	-30.50	39.20	40.82	74.00	24.48	V
9091.50	48.24	-33.80	38.10	43.84	74.00	25.76	V
7857.00	46.14	-34.90	37.10	43.94	74.00	27.86	H
2487.40	57.02	-20.00	28.30	48.72	74.00	16.98	H

**Conclusion: PASS**

**Sample:** 17937.00MHz

Result(54.68 dB $\mu$ V/m)= P<sub>Mea</sub> (33.48dB $\mu$ V/m)+Cable Loss(-25.5 dB) + Antenna Factor(46.7 dB/m)

## B.7. 6dB Bandwidth

### Method of Measurement:

The measurement is made according to ANSI C63.10 clause 11.8.1

1. Set RBW = 100 kHz.
2. Set the video bandwidth (VBW) = 300 kHz.
3. Detector = Peak.
4. Trace mode = max hold.
5. Sweep = auto couple.
6. Allow the trace to stabilize.
7. Measure the maximum width of the emission that is constrained by the frequencies associated with the two outermost amplitude points (upper and lower frequencies) that are attenuated by 6 dB relative to the maximum level measured in the fundamental emission.

### Measurement Limit:

Standard	Limit
FCC 47 CFR Part 15.247(a)(2)	$\geq 500\text{KHz}$

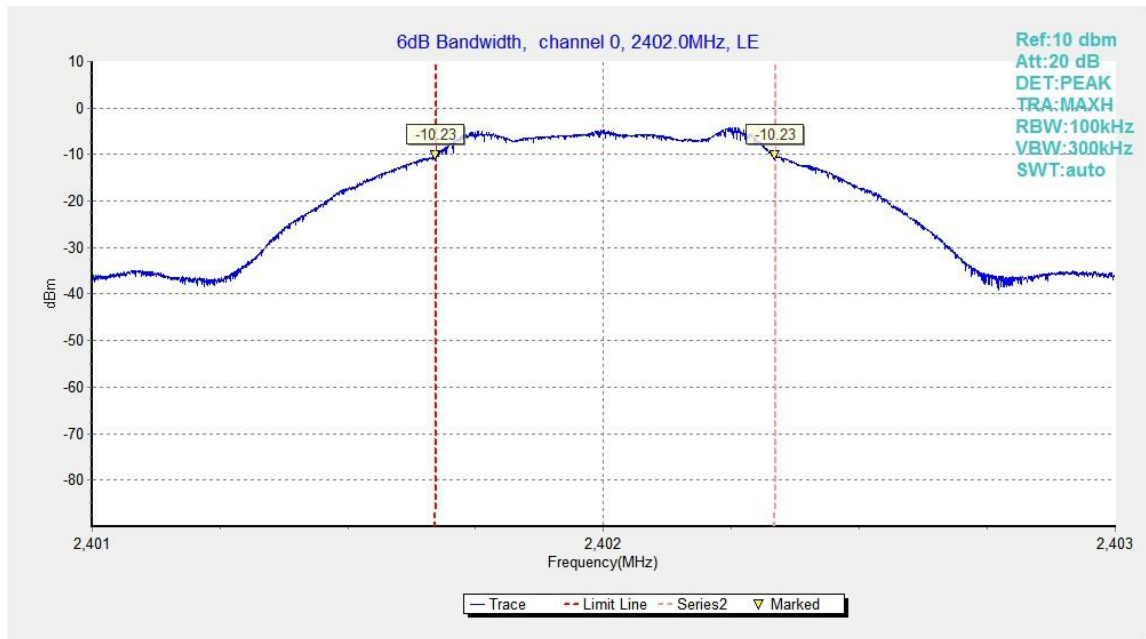
### Measurement Results:

#### For GFSK

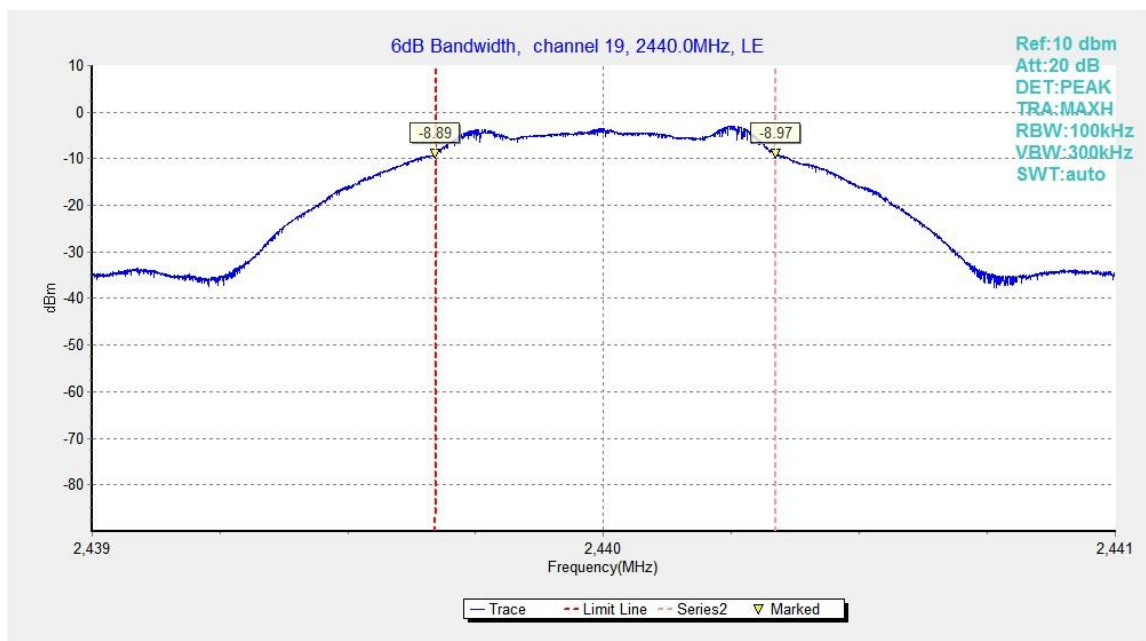
Channel No.	Frequency (MHz)	6dB Bandwidth (kHz)		Conclusion
0	2402	Fig.28	663.50	P
19	2440	Fig.29	665.00	P
39	2480	Fig.30	665.00	P

**Conclusion: PASS**

**Test graphs as below:**



**Fig.28.** 6dB Bandwidth: GFSK, 2402 MHz



**Fig.29.** 6dB Bandwidth: GFSK, 2440 MHz

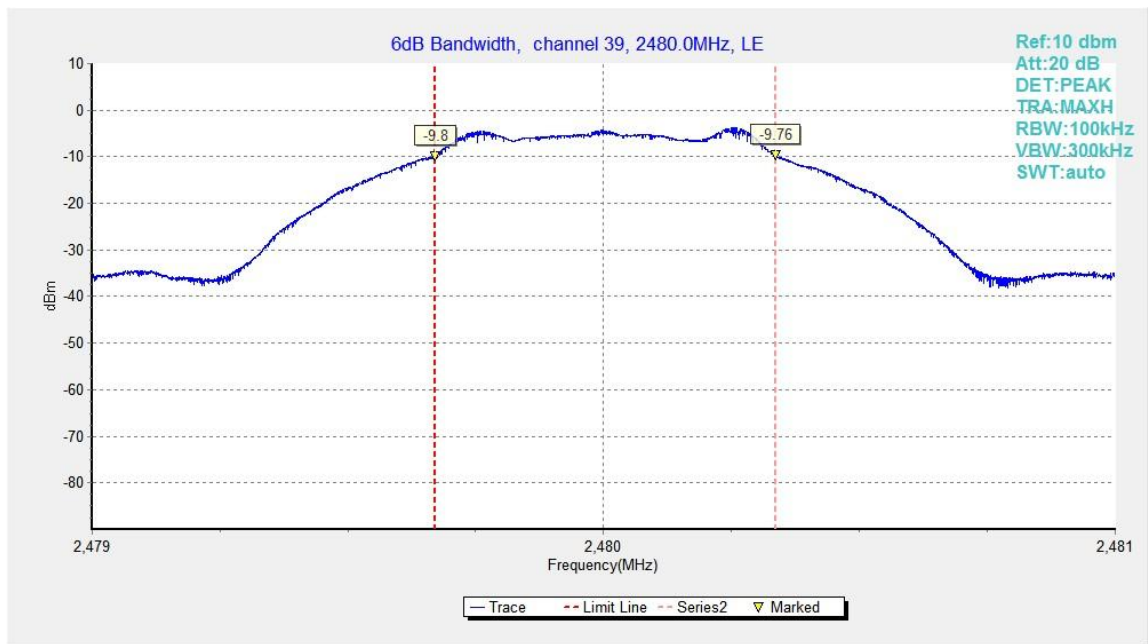


Fig.30. 6dB Bandwidth: GFSK, 2480 MHz

## B.8. Maximum Power Spectral Density Level

### Method of Measurement:

The measurement is made according to ANSI C63.10 clause 11.10.2

1. Set the RBW = 3 kHz.
2. Set the VBW = 10 kHz.
3. Set the span to 2 times the DTS bandwidth.
4. Detector = peak.
5. Sweep time = auto couple.
6. Trace mode = max hold.
7. Allow trace to fully stabilize.
8. Use the peak marker function to determine the maximum amplitude level within the RBW.

### Measurement Limit:

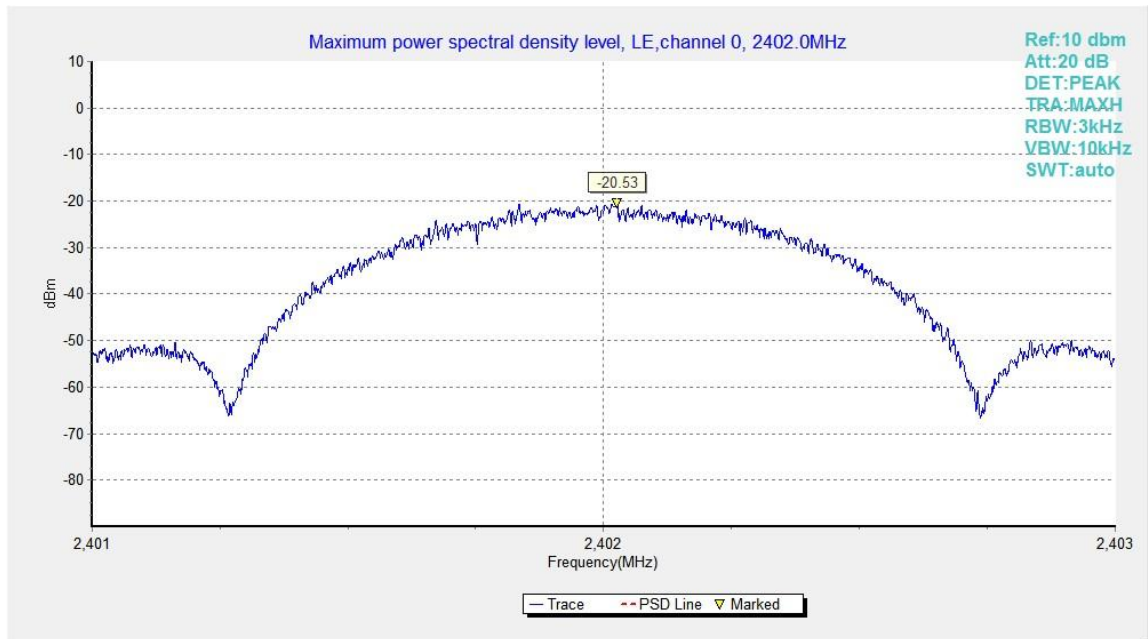
Standard	Limit
FCC 47 CFR Part 15.247(e)	$\leq 8.0\text{dBm}/3\text{kHz}$

### Measurement Results:

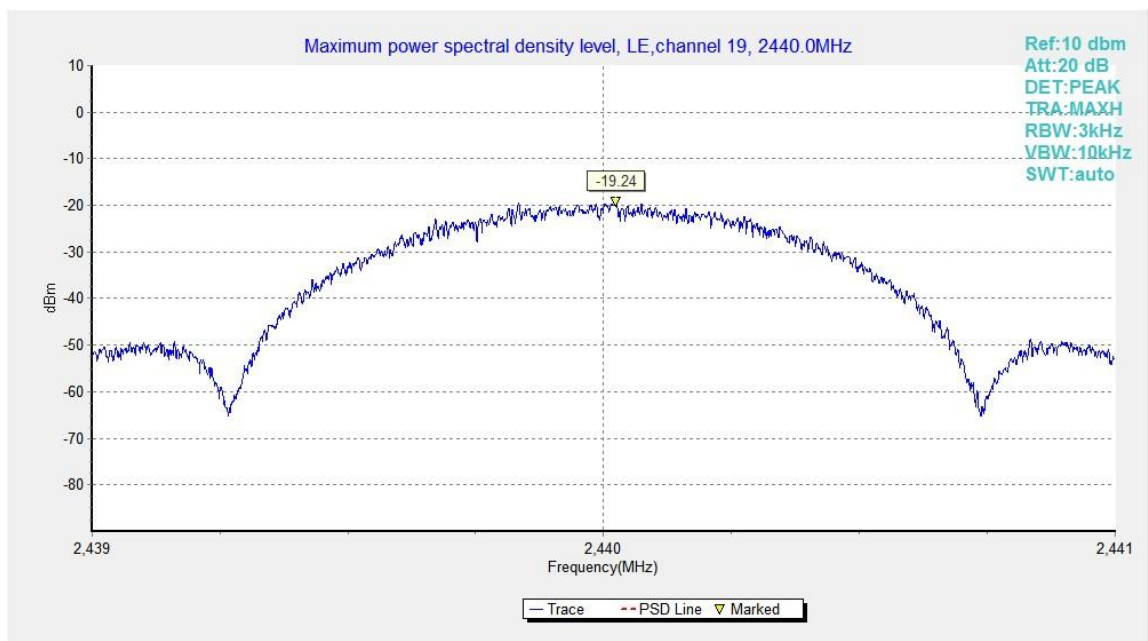
#### For GFSK

Channel No.	Frequency (MHz)	Maximum Power Spectral Density Level(dBm/3kHz)		Conclusion
		Fig.	Level	
0	2402	Fig.31	-20.53	P
19	2440	Fig.32	-19.24	P
39	2480	Fig.33	-20.25	P

Test graphs as below:

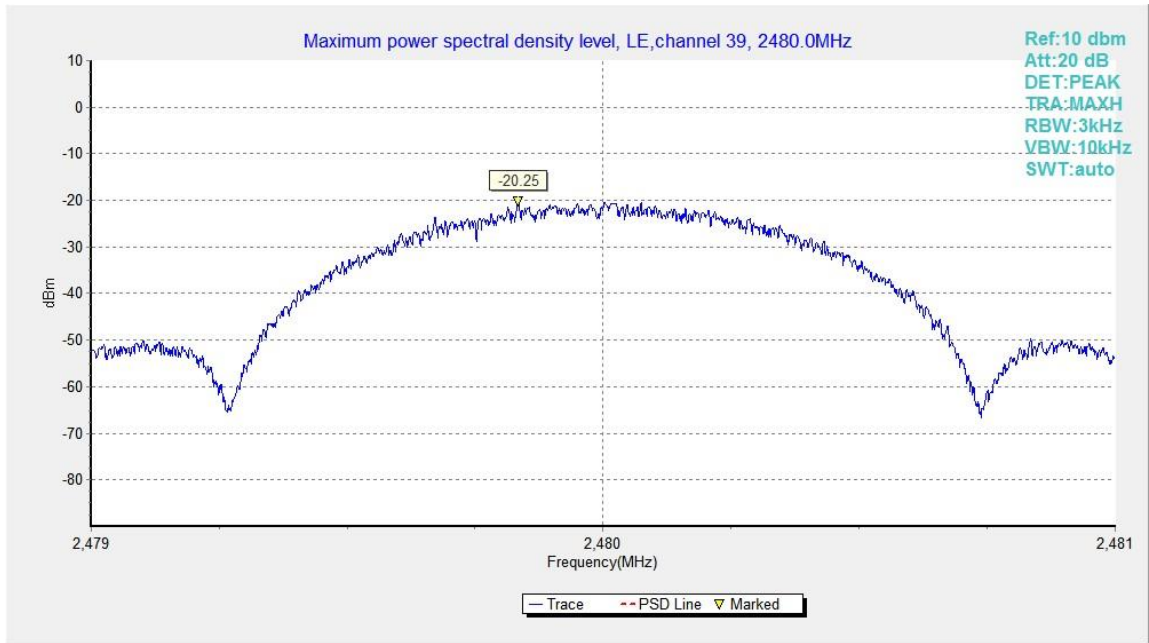


**Fig.31.** Maximum Power Spectral Density Level Function: GFSK, 2402 MHz



**Fig.32.** Maximum Power Spectral Density Level Function: GFSK, 2440 MHz





**Fig.33.** Maximum Power Spectral Density Level Function: GFSK, 2480 MHz

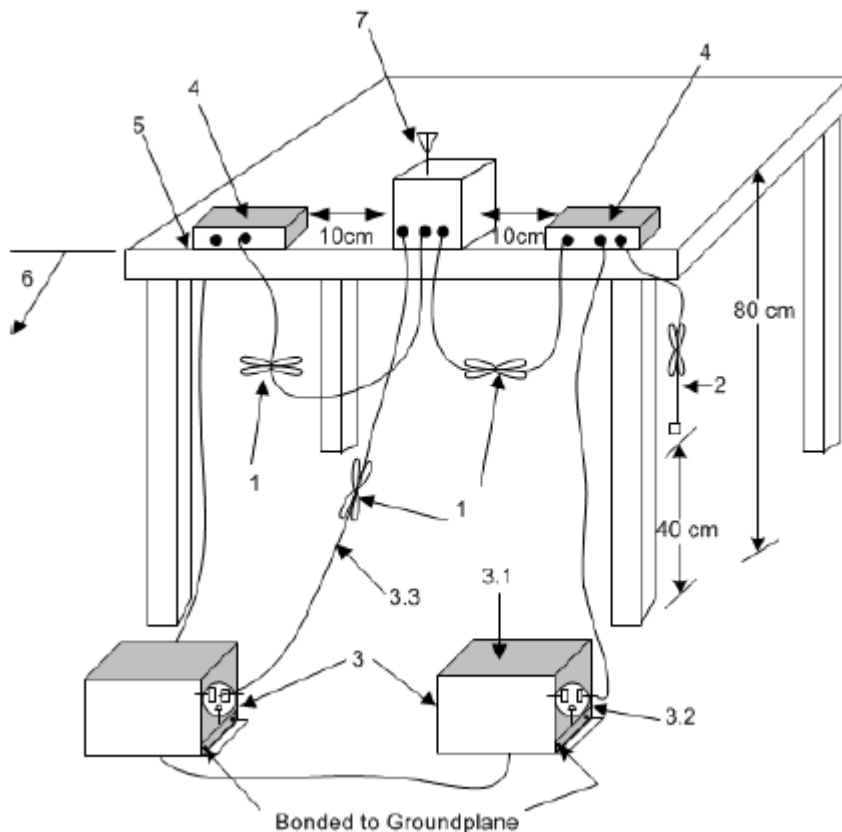
## B.9. AC Powerline Conducted Emission

**Method of Measurement: See ANSI C63.10-clause 6.2**

### Setup:

A stand-alone EUT shall be placed in the center along the back edge of the tabletop. For multiunit tabletop systems, the EUT shall be centered laterally (left to right facing the tabletop) on the tabletop and its rear shall be flush with the rear of the table.

Accessories that are part of an EUT system tested on a tabletop shall be placed in a test arrangement on one or both sides of the host with a 10 cm separation between the nearest points of the cabinets. The rear of the host and accessories shall be flush with the back of the supporting tabletop unless that would not be typical of normal use. If more than two accessories are present, then an equipment test arrangement shall be chosen that maintains 10 cm spacing between cabinets unless the equipment is normally located closer together.



### Exploratory ac power-line conducted emission measurements

Exploratory measurements shall be used to identify the frequency of the emission that has the highest amplitude relative to the limit by operating the EUT in a range of typical modes of operation, cable positions, and with a typical system equipment configuration and arrangement. For each mode of operation and for each ac power current-carrying conductor, cable manipulation shall be performed within the range of likely configurations. For this measurement or series of measurements, the frequency spectrum of interest shall be monitored looking for the emission that has the highest amplitude relative to the limit. Once that emission is found for each current-carrying conductor of each power cord associated with the EUT (but not the cords

associated with non-EUT equipment in the overall system), the one configuration and arrangement and mode of operation that produces the emission closest to the limit over all of the measured conductors shall be recorded.

### Final ac power-line conducted emission measurements

Based on the exploratory tests of the EUT, the one EUT cable configuration and arrangement and mode of operation that produced the emission with the highest amplitude relative to the limit is selected for the final measurement, while applying the appropriate modulating signal to the EUT. If the EUT is relocated from an exploratory test site to a final test site, the highest emissions shall be remaximized at the final test location before final ac power-line conducted emission measurements are performed. The final test on all current-carrying conductors of all of the power cords to the equipment that comprises the EUT (but not the cords associated with other non-EUT equipment in the system) is then performed for the full frequency range for which the EUT is being tested for compliance without further variation of the EUT arrangement, cable positions, or EUT mode of operation. If the EUT is composed of equipment units that have their own separate ac power connections (e.g., floor-standing equipment with independent power cords for each shelf that are able to connect directly to the ac power network), then each current-carrying conductor of one unit is measured while the other units are connected to a second (or more) LISN(s). All units shall be measured separately. If a power strip is provided by the manufacturer, to supply all of the units making up the EUT, only the conductors in the power cord of the power strip shall be measured.

### Test Condition:

Voltage (V)	Frequency (Hz)
120	60

### Measurement Result and limit:

EUT ID: EUT1

Bluetooth (Quasi-peak Limit)

Frequency range (MHz)	Quasi-peak Limit (dB $\mu$ V)	Result (dB $\mu$ V)		Conclusion
		With charger		
		Bluetooth BLE 1Mbps	Idle	
0.15 to 0.5	66 to 56	Fig.B.9.1	Fig.B.9.2	<b>P</b>
0.5 to 5	56			
5 to 30	60			

NOTE: The limit decreases linearly with the logarithm of the frequency in the range 0.15 MHz to 0.5 MHz.

Bluetooth (Average Limit)

Frequency range (MHz)	Average Limit (dB $\mu$ V)	Result (dB $\mu$ V)		Conclusion
		With charger		
		Bluetooth BLE 1Mbps	Idle	
0.15 to 0.5	56 to 46	Fig.B.9.1	Fig.B.9.2	<b>P</b>
0.5 to 5	46			
5 to 30	50			

NOTE: The limit decreases linearly with the logarithm of the frequency in the range 0.15 MHz to 0.5 MHz.

Bluetooth (Quasi-peak Limit)

Frequency range (MHz)	Quasi-peak Limit (dB $\mu$ V)	Result (dB $\mu$ V)		Conclusion
		With charger		
		Bluetooth BLE 2Mbps	Idle	
0.15 to 0.5	67 to 56	Fig.B.9.3	Fig.B.9.4	<b>P</b>
0.5 to 5	56			
5 to 30	60			

NOTE: The limit decreases linearly with the logarithm of the frequency in the range 0.15 MHz to 0.5 MHz.

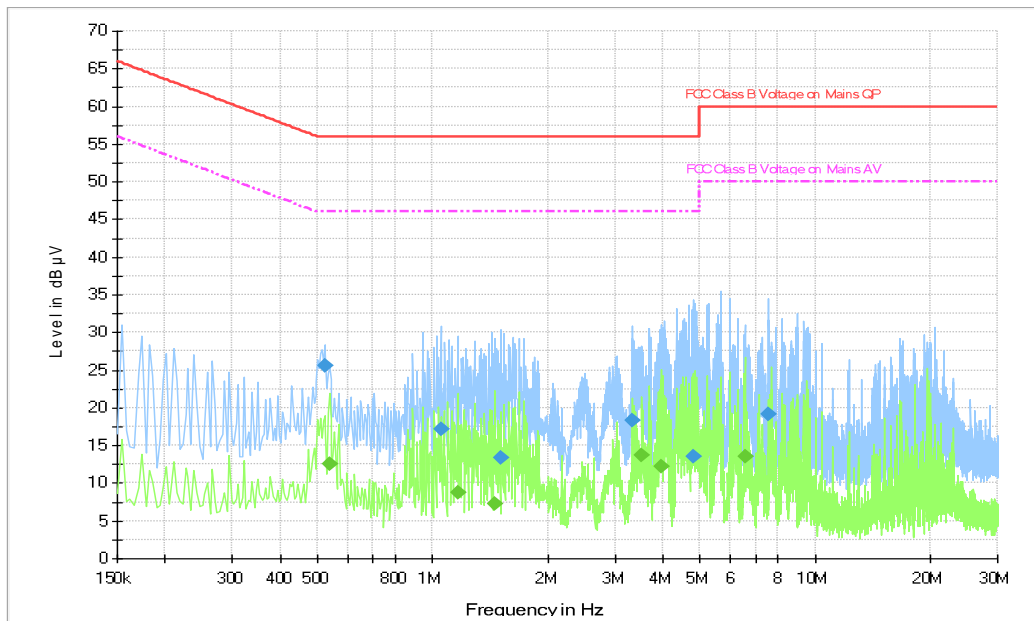
Bluetooth (Average Limit)

Frequency range (MHz)	Average Limit (dB $\mu$ V)	Result (dB $\mu$ V)		Conclusion
		With charger		
		Bluetooth BLE 2Mbps	Idle	
0.15 to 0.5	56 to 46	Fig.B.9.3	Fig.B.9.4	<b>P</b>
0.5 to 5	46			
5 to 30	50			

NOTE: The limit decreases linearly with the logarithm of the frequency in the range 0.15 MHz to 0.5 MHz.

**Conclusion: Pass**

Test graphs as below:



**Fig.B.9.1 AC Powerline Conducted Emission- Bluetooth BLE 1Mbps**

Note: The graphic result above is the maximum of the measurements for both phase line and  
 ©Copyright. All rights reserved by CTTL. Page 52 of 57.

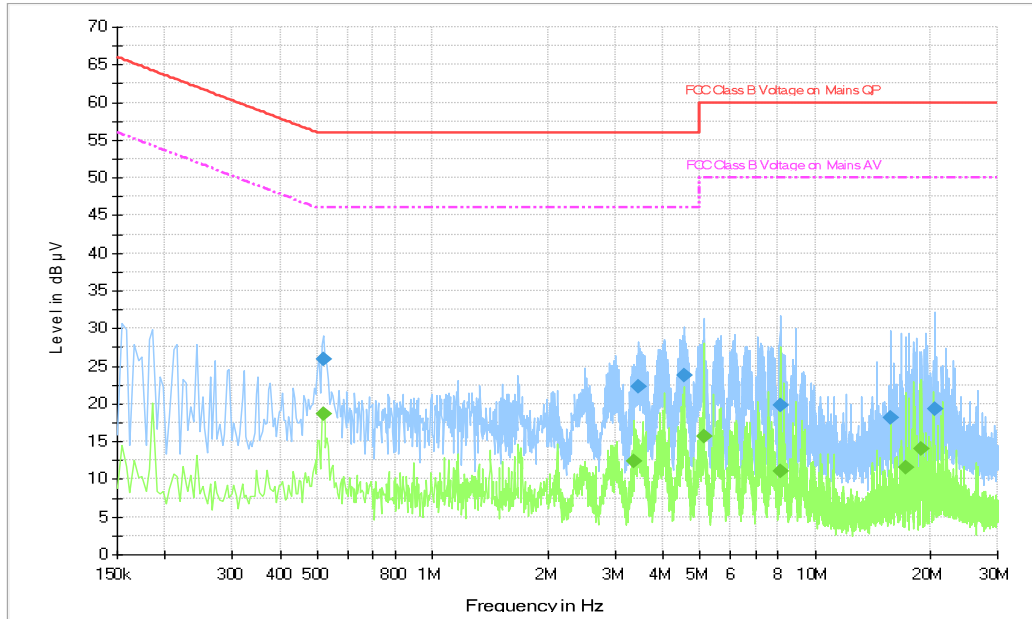
neutral line.

### Final Result 1

Frequency (MHz)	QuasiPeak (dB $\mu$ V)	Line	Corr. (dB)	Margin (dB)	Limit (dB $\mu$ V)
0.522000	25.7	L1	19.9	30.3	56.0
1.050000	17.2	N	19.8	38.8	56.0
1.510000	13.4	N	19.8	42.6	56.0
3.330000	18.3	N	19.7	37.7	56.0
4.806000	13.6	N	19.8	42.4	56.0
7.570000	19.2	N	19.7	40.8	60.0

### Final Result 2

Frequency (MHz)	Average (dB $\mu$ V)	Line	Corr. (dB)	Margin (dB)	Limit (dB $\mu$ V)
0.538000	12.5	L1	19.9	33.5	46.0
1.162000	8.7	N	19.8	37.3	46.0
1.454000	7.3	N	19.8	38.7	46.0
3.522000	13.6	L1	19.5	32.4	46.0
3.978000	12.2	N	19.7	33.8	46.0
6.546000	13.5	L1	19.5	36.5	50.0



**Fig.B.9.2 AC Powerline Conducted Emission-Idle**

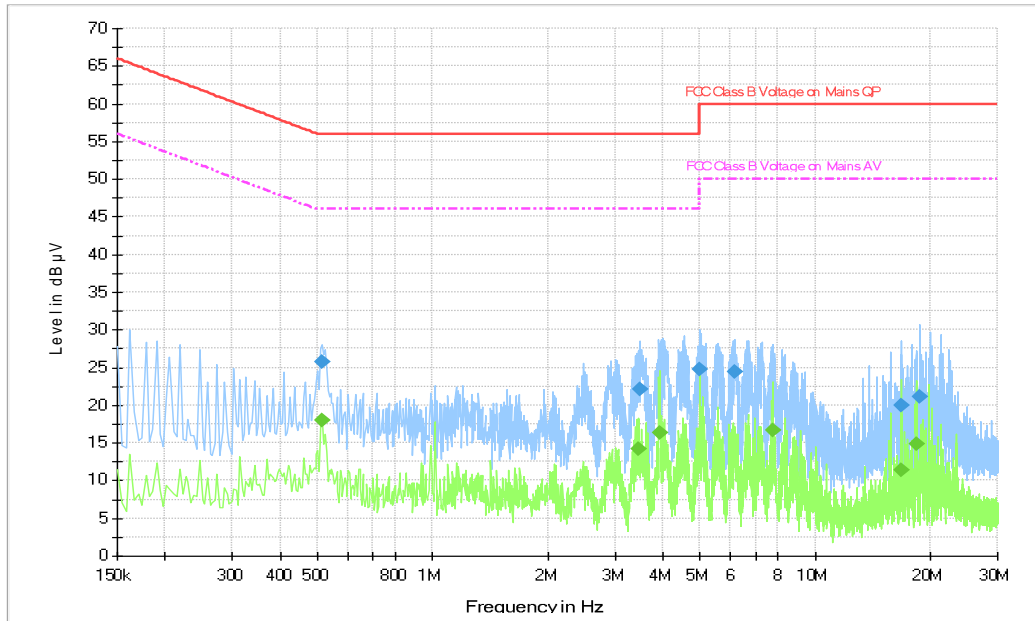
Note: The graphic result above is the maximum of the measurements for both phase line and neutral line.

**Final Result 1**

Frequency (MHz)	QuasiPeak (dBµV)	Line	Corr. (dB)	Margin (dB)	Limit (dBµV)
0.518000	25.9	L1	19.9	30.1	56.0
3.454000	22.3	N	19.7	33.7	56.0
4.550000	23.7	N	19.7	32.3	56.0
8.102000	19.8	L1	19.5	40.2	60.0
15.714000	18.1	L1	19.9	41.9	60.0
20.522000	19.4	L1	19.9	40.6	60.0

**Final Result 2**

Frequency (MHz)	Average (dBµV)	Line	Corr. (dB)	Margin (dB)	Limit (dBµV)
0.518000	18.7	L1	19.9	27.3	46.0
3.366000	12.4	L1	19.5	33.6	46.0
5.110000	15.7	L1	19.6	34.3	50.0
8.102000	11.1	L1	19.5	38.9	50.0
17.270000	11.6	L1	19.9	38.4	50.0
18.934000	14.1	L1	19.9	35.9	50.0



**Fig.B.9.3 AC Powerline Conducted Emission- Bluetooth BLE 2Mbps**

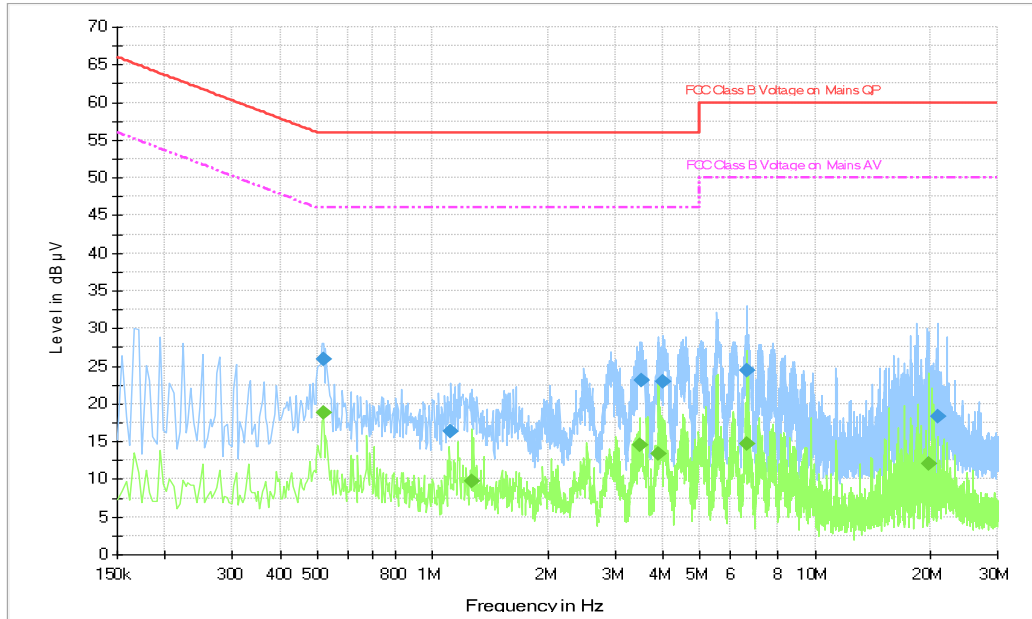
Note: The graphic result above is the maximum of the measurements for both phase line and neutral line.

**Final Result 1**

Frequency (MHz)	QuasiPeak (dBµV)	Line	Corr. (dB)	Margin (dB)	Limit (dBµV)
0.514000	25.7	L1	19.9	30.3	56.0
3.474000	22.1	N	19.7	33.9	56.0
4.990000	24.7	L1	19.6	31.3	56.0
6.142000	24.5	N	19.7	35.5	60.0
16.762000	19.9	L1	19.9	40.1	60.0
18.834000	21.2	L1	19.9	38.8	60.0

**Final Result 2**

Frequency (MHz)	Average (dBµV)	Line	Corr. (dB)	Margin (dB)	Limit (dBµV)
0.514000	18.0	L1	19.9	28.0	46.0
3.442000	14.1	L1	19.5	31.9	46.0
3.934000	16.3	L1	19.6	29.7	46.0
7.746000	16.7	L1	19.6	33.3	50.0
16.762000	11.4	L1	19.9	38.6	50.0
18.358000	14.9	L1	19.9	35.1	50.0



**Fig.B.9.4 AC Powerline Conducted Emission-Idle**

Note: The graphic result above is the maximum of the measurements for both phase line and neutral line.

**Final Result 1**

Frequency (MHz)	QuasiPeak (dBµV)	Line	Corr. (dB)	Margin (dB)	Limit (dBµV)
0.518000	26.0	L1	19.9	30.0	56.0
1.118000	16.4	N	19.8	39.6	56.0
3.534000	23.0	N	19.7	33.0	56.0
4.014000	23.0	N	19.7	33.0	56.0
6.646000	24.4	L1	19.5	35.6	60.0
20.950000	18.4	L1	19.9	41.6	60.0

**Final Result 2**

Frequency (MHz)	Average (dBµV)	Line	Corr. (dB)	Margin (dB)	Limit (dBµV)
0.518000	18.8	L1	19.9	27.2	46.0
1.266000	9.8	L1	19.5	36.2	46.0
3.478000	14.5	L1	19.5	31.5	46.0
3.898000	13.4	L1	19.5	32.6	46.0
6.658000	14.7	L1	19.5	35.3	50.0
19.818000	12.0	L1	19.9	38.0	50.0



## ANNEX C: Accreditation Certificate

<p>United States Department of Commerce National Institute of Standards and Technology</p> <div style="display: flex; justify-content: space-around; align-items: center;"><div style="font-size: 2em; font-weight: bold; letter-spacing: 0.5em;">NVLAP<sup>®</sup></div><div style="text-align: center;"></div></div> <hr/> <p style="font-size: 1.2em; font-weight: bold; text-align: center;">Certificate of Accreditation to ISO/IEC 17025:2017</p> <hr/> <p style="text-align: center;">NVLAP LAB CODE: 600118-0</p> <p style="text-align: center; font-weight: bold;">Telecommunication Technology Labs, CAICT</p> <p style="text-align: center;">Beijing China</p> <p style="text-align: center; font-size: 0.8em;"><i>is accredited by the National Voluntary Laboratory Accreditation Program for specific services, listed on the Scope of Accreditation, for:</i></p> <p style="text-align: center; font-weight: bold;">Electromagnetic Compatibility &amp; Telecommunications</p> <p style="text-align: center; font-size: 0.8em;"><i>This laboratory is accredited in accordance with the recognized International Standard ISO/IEC 17025:2017. This accreditation demonstrates technical competence for a defined scope and the operation of a laboratory quality management system (refer to joint ISO-ILAC-IAF Communique dated January 2009).</i></p> <div style="display: flex; justify-content: space-between; align-items: center; margin-top: 20px;"><div style="text-align: center;"><hr/><p style="font-size: 0.8em;">2021-09-29 through 2022-09-30 <i>Effective Dates</i></p></div><div style="text-align: center;"></div><div style="text-align: center;"><hr/> <i>For the National Voluntary Laboratory Accreditation Program</i></div></div>	
--	--

**\*\*\*END OF REPORT\*\*\***