

Breville®

Breville®

Breville Customer Service Centre

Australian Customers

Mail: PO Box 22
Botany NSW 2019
AUSTRALIA

Phone: 1300 139 798

Fax: (02) 9384 9601

Email: Customer Service:
askus@breville.com.au

New Zealand Customers

Mail: Private Bag 94411
Botany Manukau 2163
Auckland NEW ZEALAND

Phone: 0800 273 845

Fax: 0800 288 513

Email: Customer Service:
askus@breville.co.nz

www.breville.com.au

www.breville.co.nz

Breville is a registered trademark of Breville Pty. Ltd. A.B.N. 98 000 092 928.
Copyright Breville Pty. Ltd. 2014.

Due to continued product improvement, the products illustrated/photographed
in this brochure may vary slightly from the actual product.

BCG600 ANZ A14

the Dose Control™ Pro

Instruction Booklet



Suits all BCG600 models

CONGRATULATIONS

on the purchase of your new
Breville product

CONTENTS

- 4** Breville recommends safety first
- 7** Know your Breville product
- 10** Operating your Breville product
- 16** Care, cleaning & storage
- 17** Coffee tips
- 18** Troubleshooting

At Breville we are very safety conscious. We design and manufacture consumer products with the safety of you, our valued customer, foremost in mind. In addition we ask that you exercise a degree of care when using any electrical appliance and adhere to the following precautions.

IMPORTANT SAFEGUARDS

FOR ALL ELECTRICAL APPLIANCES

- Remove and safely discard any packaging material and promotional labels before using the Breville Dose Control™ Pro for the first time.
- To eliminate a choking hazard for young children, remove and safely discard the protective cover fitted to the power plug of the Breville Dose Control™ Pro.
- Do not place the Breville Dose Control™ Pro near the edge of a bench or table during operation.
- Do not place the Breville Dose Control™ Pro on or near a hot gas burner, electric element or where it could touch a heated oven.
- Do not operate the Breville Dose Control™ Pro on a sink drain board.
- Ensure that the surface is level, clean and free of water.
- The Breville Dose Control™ Pro is not intended to be operated by means of an external timer or separate remote control system.
- To protect against electric shock, do not immerse the grinder base, power cord or power plug in water or allow moisture to come in contact with these parts.
- Always switch the Breville Dose Control™ Pro off at the power outlet and unplug if Breville Dose Control™ Pro is to be left unattended, if not in use, before cleaning, before attempting to move, disassembling, assembling and when storing.
- Do not use attachments other than those provided with the Breville Dose Control™ Pro.
- Do not operate the Breville Dose Control™ Pro without locking the bean hopper lid in position. Keep fingers, hands, hair, clothing and utensils away from the bean hopper during operation.

- The coffee grinder should not be switched on until the bean hopper and hopper lid are locked into position in the grinding chamber.
- Do not operate the Breville Dose Control™ Pro, continuously for longer than 2 minutes as this could cause overheating. Allow the Breville Dose Control™ Pro to cool down for 20 minutes after long operation.
- Do not use the Breville Dose Control™ Pro for any other purpose than grinding coffee beans.
- Do not use pre ground coffee in bean hopper. The Breville Dose Control™ Pro will not grind food that is sticky, or extremely hard, or make pastes of any fruits, seeds or herbs i.e. curry pastes, nut butters.
- Keep the Breville Dose Control™ Pro and accessories clean. Follow the Care and Cleaning instructions provided on page 20.
- The installation of a residual current device (safety switch) is recommended to provide additional safety protection when using electrical appliances. It is advisable that a safety switch with a rated current not exceeding 30mA be installed in the electrical circuit supplying the appliance. See your electrician for professional advice.
- This appliance shall not be used by children. Keep the appliance and its cord out of reach of children.
- Appliances can be used by persons with reduced physical, sensory or mental capabilities or lack of experience and knowledge if they have been given supervision or instruction concerning use of the appliance in a safe way and if they understand the hazards involved.
- Children should be supervised to ensure that they do not play with the appliance.

IMPORTANT SAFEGUARDS FOR ALL ELECTRICAL APPLIANCES

- Unwind the power cord fully before use.
- Do not let the power cord hang over the edge of a bench or table or, touch hot surfaces or become knotted.
- To protect against electric shock, do not immerse the appliance, power cord or power plug in water or any other liquid.
- It is recommended to regularly inspect the appliance. Do not use the appliance if the power cord, power plug or appliance becomes damaged in any way. Return the entire appliance to the nearest authorised Breville Service Centre for examination and/or repair.
- Any maintenance, other than cleaning, should be performed at an authorised Breville Service Centre.
- This appliance is for household use only. Do not use this appliance for anything other than its intended use. Do not use in moving vehicles or boats. Do not use outdoors. Misuse may cause injury.
- The installation of a residual current device (safety switch) is recommended to provide additional safety protection when using electrical appliances. It is advisable that a safety switch with a rated residual operating current not exceeding 30mA be installed in the electrical circuit supplying the appliance. See your electrician for professional advice.
- The appliance is not intended to be operated by means of an external timer or separate remote control system.
- Connect only to a 220-240V power outlet.

SAVE THESE INSTRUCTIONS FOR HOUSEHOLD USE ONLY

KNOW

your Breville product

KNOW YOUR BREVILLE PRODUCT

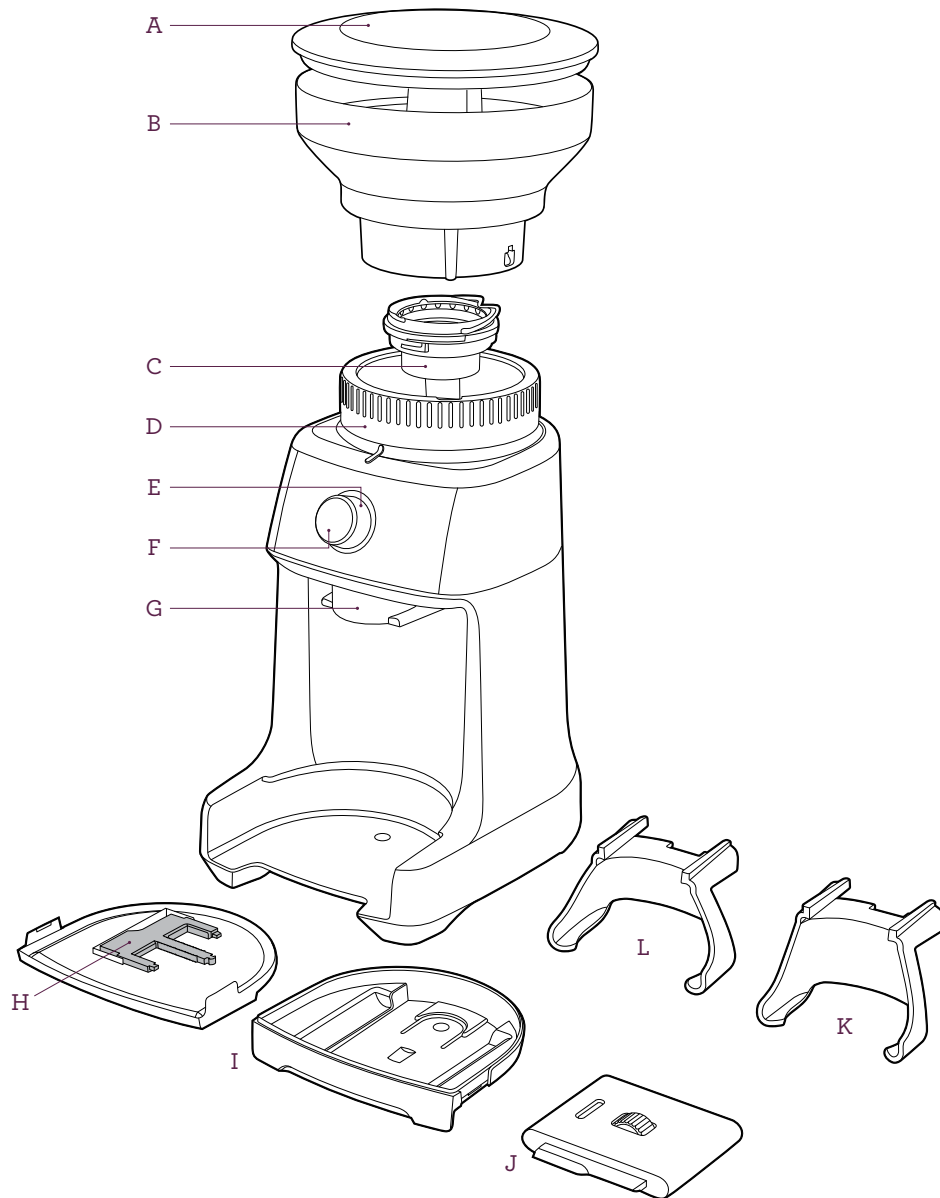

KNOW YOUR BREVILLE PRODUCT

- A. **Bean Hopper Lid**
Air tight seal to maximise bean freshness.
- B. **Bean Hopper**
340g bean hopper with locking system for easy removal and bean transfer.
- C. **Hardened Stainless Steel Conical Burrs**
Maximise particle size for full flavour potential.
- Removable and Adjustable Upper Burr
- D. **Grind Size Collar**
60 grind settings, from espresso to plunger.
- E. **GRIND TIME Dial**
Adjusts amount to increase or decrease dose.
- F. **START|CANCEL Button**
Starts, pauses and cancels operation.
- G. **Grind Outlet**
- H. **50mm blade**
- I. **Grind Tray**
Catches grind overflow. Removable for easy cleaning and accessing the Razor™ Dose Trimming Tool.

ACCESSORIES

- J. **Adjustable Razor™ Dose Trimming Tool**
Trims the puck to the right level for a consistent extraction.
- K. **Portafilter Cradle 50–54mm**
- L. **Portafilter Cradle 58mm**

NOT SHOWN

- Grinding Chamber**
Minimises static before dispensing.
- Automatic Thermal Safety Shut Off**
Protects motor from overheating.
- Power Saving/Sleep Mode**
Unit powers down to standby after 5 minutes of non use.

GRINDER OVERVIEW

Your Dose Control™ Pro uses hardened stainless steel Conical Burrs and can grind whole bean coffee suitable for a range of brewing methods, from the finest setting for Espresso to the coarsest setting for Plunger.

The grind amount (dose) for all coffee types is controlled by an electronic timer. The dose for each brew method can be adjusted by rotating the GRIND TIME dial and changing the time the grinder will run. You can grind directly into a Portafilter, Container or Drip Coffee filter basket.

Within each brew method, Espresso, Percolator, Drip or Plunger, there is a range of grind size settings; the grind settings will differ between each brew method. This is because each method requires different grind sizes for optimum extraction. Experiment with different grind size settings until you achieve the brew that best suits your taste.

Rotating the Bean Hopper will turn the Grind Size Collar to adjust grind size.

BEFORE FIRST USE

Remove and safely discard all promotional labels and packing materials attached to your Breville product. Wash hopper, and cradles in warm soapy water and dry thoroughly. Wipe exterior of grinder with a soft damp cloth and dry thoroughly. Place grinder on flat level surface and plug power cord into 220-240V outlet and switch Power 'ON'.

ASSEMBLING YOUR BREVILLE CONTROL DOSE™ PRO

Bean Hopper

Align tabs on the base of the bean hopper and insert hopper into position. Holding the hopper, press down firmly and turn the bean hopper dial 45° to lock into position.

A "click" sound will be heard when the hopper is properly locked in place.

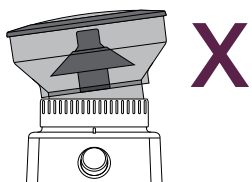
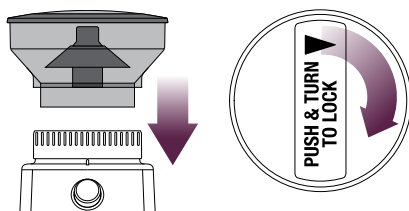

Ensure the hopper and the Grind Size Collar is aligned properly.

Fill with fresh coffee beans and secure lid on top of bean hopper.

NOTE

If the bean hopper has not been locked into position, the GRIND TIME dial will not be illuminated. This is to disable grinder operation for safety reasons.

The bean hopper can be removed by holding the hopper and turning the Dial anti-clockwise and lifting hopper to remove. The locking system allows you to remove and transfer beans in the hopper to a storage container safely.

GRINDING FOR ESPRESSO COFFEE

Use single wall filter baskets when grinding fresh coffee beans. Use the finer 1-25 settings in the ESPRESSO range.

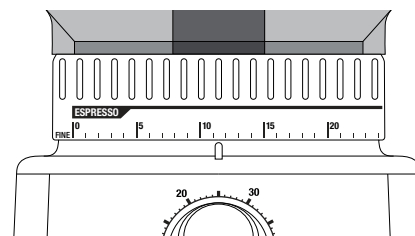

Step 1:

Insert the appropriate portafilter cradle size. Insert your portafilter into the cradle.

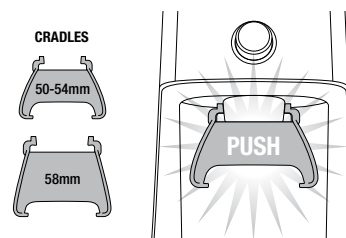

Step 2:

Selecting Grind Amount

Select the desired amount of ground coffee required by turning the GRIND TIME dial.

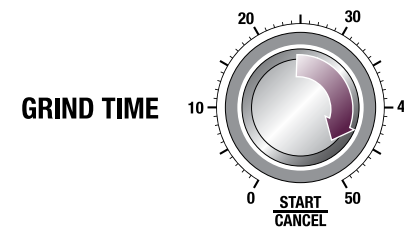

As a guide, start with 5 secs for a single shot filter basket or 9 secs for a double shot filter basket. This will vary depending on the individual size of your filter basket. Refer to the Coffee Chart on page 14 as a guide. Rotate the GRIND TIME dial to adjust the grind time until the correct dose is achieved. Increasing the time will increase the dose and decreasing the time will decrease the dose.

Step 3:

Tamping the Ground Coffee

After dosing the portafilter with freshly ground coffee, tamp down with between 15-20kg of pressure. The amount of pressure is not as important as consistent pressure every time.

OPERATING YOUR BREVILLE PRODUCT

Step 4:

Trimming the Dose

The adjustable Razor™ Dose Trimming Tool allows you to trim the puck to the right level for a consistent extraction.

Select the correct width blade of the Razor™ to match the diameter of your filter basket. The Razor™ has three blades of varying widths: 58mm, 54mm and 50mm. The 58mm and 54mm are already fitted within the Razor™ body. The 50mm is separate.

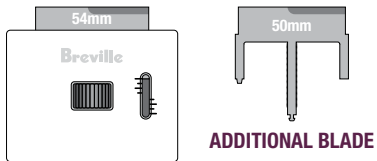

If you require the 50mm blade, turn the Adjustable Dial past #1 until the 54mm blade is fully extended and able to be pulled from the body.

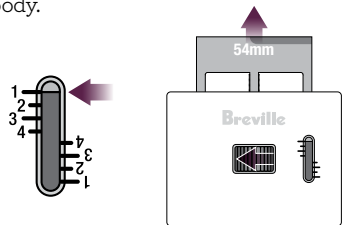

NOTE

The Adjustable Dial may feel tight as you continue to wind it towards the end of its travel.

Insert the 50mm blade into the body. Wind the Adjustable Dial until the blade is retracted past #4. Press the 50mm and 58mm blades at the same time, towards the centre of the body until a “click” sound can be heard.

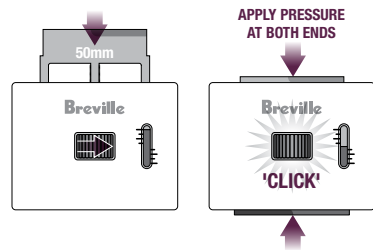

Adjust the Razor™ to the setting in the table below for your Breville espresso machine. This is a starting point for your dose height.

Breville Espresso Machine	Portafilter Size	Dose Height
BES900/BES920	58mm	2
BES870	54mm	2.5
BES840	54mm	2.5
BES810BSS	54mm	2.5
800ES	50mm	3
BES250	50mm	3

After tamping the coffee, insert the Razor™ into the filter basket until it rests on the rim of the basket. The blade of the dosing tool should penetrate the surface of the tamped coffee.

If the blade does not penetrate the surface of the tamped coffee, your coffee is under dosed. Increase the amount of dosed coffee by adjusting the GRIND TIME dial.

Rotate the Razor™ back and forth while holding the portafilter on an angle over the knock box to trim off a little excess coffee.

OPERATING YOUR BREVILLE PRODUCT

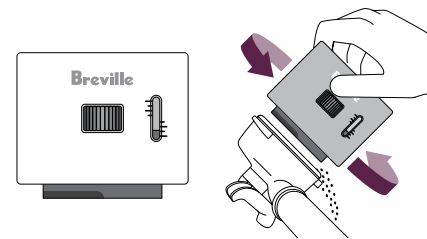

Your filter basket is now dosed with the correct amount of coffee for your Breville espresso machine.

If using the Razor™ with a non Breville espresso machine, you will need to adjust the depth of the trimmed coffee by trial and error until you achieve approximately a 1mm gap between the group head dispersion screen and the surface of the trimmed coffee. Start with a dose that is too high, i.e. the dispersion screen leaves an imprint on the surface of the trimmed coffee when inserted and removed from the group head WITHOUT extracting. Adjust the height of the dose in small steps until you achieve this clearance. You will then have the correct dose height for your espresso machine. Adjust grind size only until you get the right rate of espresso flow, while keeping the Razor™ dose height and tamp pressure consistent.

Step 5:

Select Your Grind Size

For espresso, we recommend starting with grind size setting 10 and rotating the Hopper (to adjust the Grind Size Collar) either coarser or finer until your preferred flavour profile is achieved. This should be done in conjunction with setting the grind amount (dose).

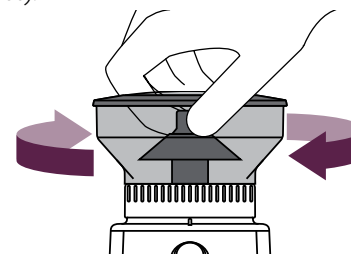

Refer to the Coffee Chart on page 14 for approximate grind size guide.

You will need to extract a shot of espresso to determine if a change in grind size and/or grind amount is necessary to achieve the correct rate of flow. Traditionally, a single shot of espresso is defined as ~ 30mls in 30 seconds and a double shot of espresso as ~ 60mls in 30 seconds.

NOTE

If the Grind Size Collar is tight, run the grinder by pressing the START|CANCEL button while turning the Hopper. This will release coffee grounds caught between the burrs.

GRINDING INTO A GRINDS CONTAINER OR COFFEE FILTER

Step 1:

Remove cradle by sliding out from under the grind outlet.

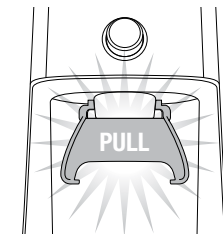

Place your container or coffee filter directly under grind outlet.

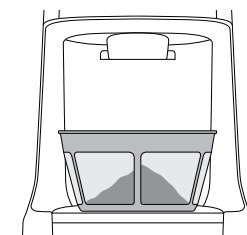

Step 2:

Select the required amount of ground coffee by rotating the GRIND TIME dial.

Refer to Coffee Chart on page 14 for approximate grind amount guide for various brew methods.

Step 3:

Select Your Grind Size

Rotate the Hopper to adjust the Grind Size Collar until it reaches the required brewing method range. Within each brew method, Percolator, Filter or Plunger, there is a range of grind size settings. We recommend you start in the centre of each range, then experiment with grind size within each range until you get the flavour balance that suits you.

FEATURES OF YOUR BREVILLE DOSE CONTROL™ PRO

Pause Function

You can pause the grinder during operation, allowing you to collapse or settle the coffee in the Portafilter.

- Press the START|CANCEL button to start the grinding operation.
- During grinding, press the START|CANCEL button to pause the grinding operation for up to 10 seconds.

The START|CANCEL button will slowly flash while paused.

- Press START|CANCEL again within this time to resume grinding the remaining dose. Or press and hold the START|CANCEL button for 1 second to cancel.

Manual

Grinding manually allows you to have complete control over how much coffee is dispensed. Press and hold the START|CANCEL button to grind for as long as you require.

- Release START|CANCEL button to stop grinding.

COFFEE CHART

Brewing Method	Espresso	Percolator	Drip	French Press or Plunger
Grind Size	Fine	Medium	Medium Coarse	Coarse
Grind Setting	1-25	26-34	35-45	46-55
Amount (Shot/Cup)	58mm Portafilter 8 secs per shot 12 secs per 2 shots	2 secs per cup	2 secs per cup	2 secs per cup
	54mm Portafilter 5 secs per shot 9 secs per 2 shots			

ADJUSTING CONICAL BURRS

Some types of coffee may require a wider grind range to achieve an ideal extraction or brew. A feature of your Dose Control™ Pro is the ability to extend this range with an adjustable upper burr. We recommend making only one adjustment at a time.

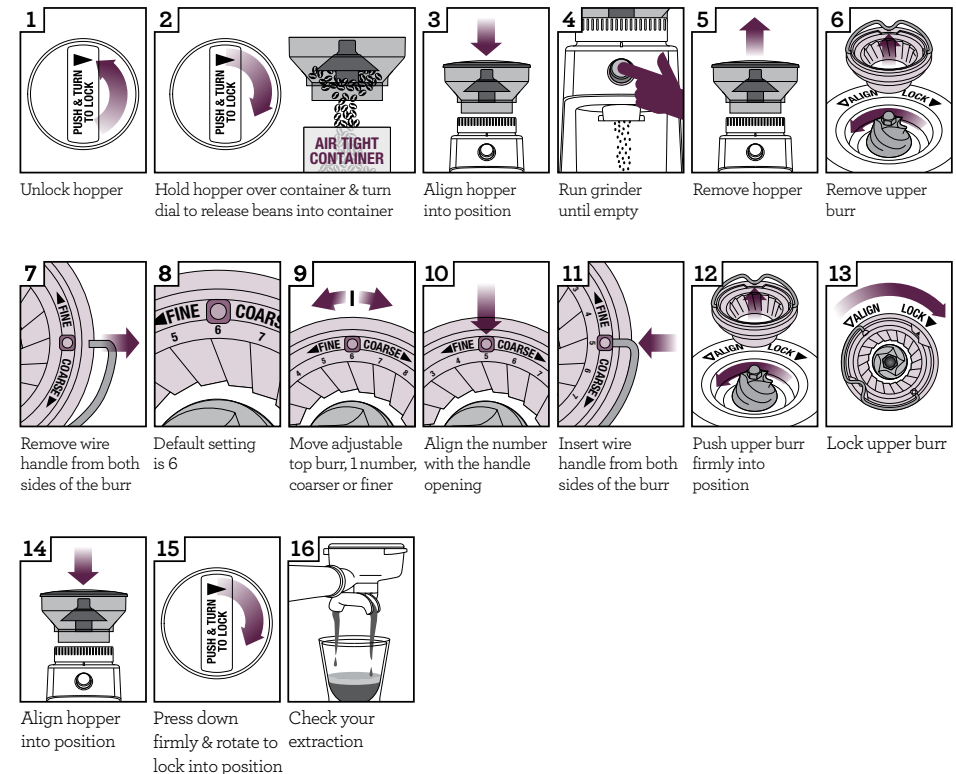

CARE, CLEANING & STORAGE

CARE, CLEANING & STORAGE

1. Empty beans from the hopper and grind out any excess beans (see below).
2. Unplug power cord from power outlet before cleaning.
3. Wash the hopper lid and bean hopper in warm soapy water, rinse and dry thoroughly.
4. Wipe and polish exterior of appliance with a soft damp cloth.

NOTE

Do not use alkaline or abrasive cleaning agents, steel wool or scouring pads, as these can damage the surface.

NOTE

Please do not clean any grinder parts or accessories in the dishwasher.

CLEANING CONICAL BURRS

Regular cleaning helps the burrs achieve consistent grinding results which is especially important when grinding for espresso coffee.

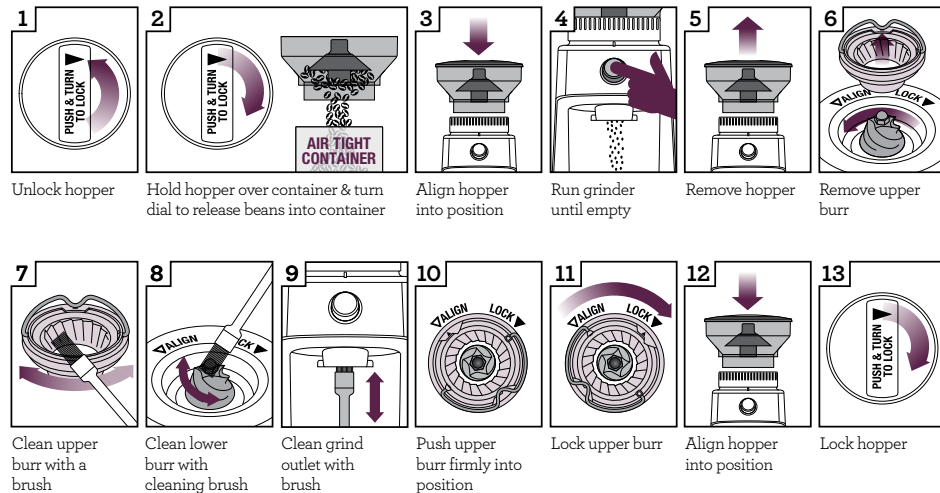

COFFEE MAKING TIPS

MAKING BETTER QUALITY COFFEE

- Freshly ground coffee is the key to making coffee with more flavour and body.
- Coffee flavour and strength is a personal preference. Vary the type of coffee beans, amount of coffee and grind size to achieve the flavour you prefer.
- Use freshly roasted coffee beans with a 'roasted on' date to maximise flavour, not a use-by or best before date.
- Use coffee beans between 5 and 20 days after the 'roasted on' date for optimal freshness.
- Store coffee beans in a dark, cool and dry place. Vacuum seal if possible.
- Buy in small batches to reduce the storage time.
- Once coffee is ground, it quickly loses its flavour and aroma. For the best results, grind beans immediately before brewing.
- Do not store beans in the bean hopper. Place them back in an airtight container.
- When storing the appliance, run grinder empty to clear ground beans left in chamber.
- Run grinder for 2 seconds to purge some coffee before each use, for maximum freshness.
- Clean the bean hopper and conical burrs regularly.

FRENCH PRESS/PLUNGER

Follow these easy steps for a great cup:

1. Using a variable temperature kettle, heat the appropriate volume of water to 93°C. This is an ideal temperature for brewing coffee. Do not use boiling water.
2. Select grind size setting 50.
3. Select the Grind Amount for the number of cups you are brewing. Refer to Coffee Chart on page 14.
4. Place the ground coffee in the plunger vessel.
5. Pour the heated water into the plunger in a swirling manner to ensure all the ground coffee is soaked and the plunger vessel is full. The 'bloom' (expanding coffee and gases) should reach the top of the plunger.
6. Using a timer, wait 4 minutes.
7. Using a spoon, break the 'crust' (the bloom becomes dense and a bit hard).
8. Insert the plunger and carefully press down.
9. Do not press too hard. Gently release pressure by pulling up slightly and press down again if you have pressed too hard.

TROUBLESHOOTING

PROBLEM	POSSIBLE CAUSE	WHAT TO DO
Grinder does not start after pressing START CANCEL button	<ul style="list-style-type: none"> • Grinder not plugged in. • Bean hopper not attached correctly. • Grinder has overheated. 	<ul style="list-style-type: none"> • Plug power cord into power outlet. • Lock bean hopper into position. Refer to the Bean Hopper section on page 10. • Remove power plug from power outlet. Leave for 20 minutes to cool down before using again.
Motor starts but no ground coffee coming from grind outlet	<ul style="list-style-type: none"> • No coffee beans in bean hopper. • Grinder/bean hopper is blocked. 	<ul style="list-style-type: none"> • Fill bean hopper with fresh coffee beans. • Remove bean hopper. Inspect bean hopper and burrs for blockage. Refer to the Cleaning Conical Burrs section on page 16.
Can't adjust the Grind Size Collar	<ul style="list-style-type: none"> • Grind Size Collar too tight. • Coffee beans and grinds caught in the burrs • Hopper not installed correctly. 	<ul style="list-style-type: none"> • Rotate the Bean Hopper to turn the Grind Size Collar to adjust grind settings. • Run the grinder by pressing the START CANCEL button while turning the Hopper. • Unlock the hopper and install as per instruction. Refer to the Bean Hopper section on page 10.
Unable to lock bean hopper into position	<ul style="list-style-type: none"> • Coffee beans obstructing bean hopper locking device. 	<ul style="list-style-type: none"> • Remove bean hopper. Clear coffee beans from top of burrs. Re-lock the hopper into position & try again.
Not enough/ too much coffee grind	<ul style="list-style-type: none"> • Grind amount requires adjustment. 	<ul style="list-style-type: none"> • Use GRIND TIME dial to fine tune the amount more or less.
Portafilter overfills		<ul style="list-style-type: none"> • It is normal for the correct amount of coffee to appear overfilled in your portafilter. Untamped coffee has approximately three times the volume of tamped coffee.
Emergency stop?		<ul style="list-style-type: none"> • Press the START CANCEL button to pause operation. • Unplug power cord from power outlet.

NOTES