

FCC Report (Bluetooth)

Applicant: AOC

Address of Applicant: 8F-3, No. 166, Jian 1 Road, Zhonghe Dist., New Taipei City
23511, Taiwan

Equipment Under Test (EUT)

Product Name: Feature Phone

Model No.: A17

FCC ID: 2AEB5-A17

Applicable standards: FCC CFR Title 47 Part 15 Subpart C Section 15.247:2013

Date of sample receipt: March 27, 2015

Date of Test: March 30-April 07, 2015

Date of report issued: April 08, 2015

Test Result : PASS *

* In the configuration tested, the EUT complied with the standards specified above.

Authorized Signature:



Robinson Lo

Laboratory Manager

This report details the results of the testing carried out on one sample. The results contained in this test report do not relate to other samples of the same product and does not permit the use of the GTS product certification mark. The manufacturer should ensure that all products in series production are in conformity with the product sample detailed in this report.

This report may only be reproduced and distributed in full. If the product in this report is used in any configuration other than that detailed in the report, the manufacturer must ensure the new system complies with all relevant standards. Any mention of GTS or testing done by GTS in connection with, distribution or use of the product described in this report must be approved by GTS in writing.

This document cannot be reproduced except in full, without prior written approval of the Company. Any unauthorized alteration, forgery or falsification of the content or appearance of this document is unlawful and offenders may be prosecuted to the fullest extent of the law. Unless otherwise stated the results shown in this test report refer only to the sample(s) tested and such sample(s) are retained for 90 days only.

2 Version

Version No.	Date	Description
00	April 08, 2015	Original

Prepared By:

Sam. Gao

Date:

April 08, 2015

Project Engineer

Check By:

hank. yan

Date:

April 08, 2015

Reviewer

3 Contents

	Page
1 COVER PAGE	1
2 VERSION	2
3 CONTENTS	3
4 TEST SUMMARY	4
5 GENERAL INFORMATION	5
5.1 CLIENT INFORMATION.....	5
5.2 GENERAL DESCRIPTION OF EUT	5
5.3 TEST MODE	7
5.4 TEST FACILITY	7
5.5 TEST LOCATION.....	7
5.6 OTHER INFORMATION REQUESTED BY THE CUSTOMER	7
5.7 DESCRIPTION OF SUPPORT UNITS	7
6 TEST INSTRUMENTS LIST	8
7 TEST RESULTS AND MEASUREMENT DATA	9
7.1 ANTENNA REQUIREMENT	9
7.2 CONDUCTED EMISSIONS	10
7.3 CONDUCTED PEAK OUTPUT POWER	13
7.4 20dB EMISSION BANDWIDTH.....	15
7.5 CARRIER FREQUENCIES SEPARATION	17
7.6 HOPPING CHANNEL NUMBER.....	19
7.7 DWELL TIME	20
7.8 PSEUDORANDOM FREQUENCY HOPPING SEQUENCE	22
7.9 BAND EDGE.....	23
7.9.1 <i>Conducted Emission Method</i>	23
7.9.2 <i>Radiated Emission Method</i>	25
7.10 SPURIOUS EMISSION.....	27
7.10.1 <i>Conducted Emission Method</i>	27
7.10.2 <i>Radiated Emission Method</i>	29
8 TEST SETUP PHOTO	35
9 EUT CONSTRUCTIONAL DETAILS	36

4 Test Summary

Test Item	Section in CFR 47	Result
Antenna Requirement	15.203/15.247 (c)	Pass
AC Power Line Conducted Emission	15.207	Pass
Conducted Peak Output Power	15.247 (b)(1)	Pass
20dB Occupied Bandwidth	15.247 (a)(1)	Pass
Carrier Frequencies Separation	15.247 (a)(1)	Pass
Hopping Channel Number	15.247 (a)(1)	Pass
Dwell Time	15.247 (a)(1)	Pass
Pseudorandom Frequency Hopping Sequence	15.247(b)(4)&TCB Exclusion List (7 July 2002)	Pass
Radiated Emission	15.205/15.209	Pass
Band Edge	15.247(d)	Pass

Pass: The EUT complies with the essential requirements in the standard.

5 General Information

5.1 Client Information

Applicant:	AOC
Address of Applicant:	8F-3, No. 166, Jian 1 Road, Zhonghe Dist., New Taipei City 23511, Taiwan
Manufacturer:	New Flying
Address of Manufacturer:	10/F Block C, Tairan Building, Tairan 8 Road, Chegongmiao, District, Shenzhen City, Guangdong Province, China

5.2 General Description of EUT

Product Name:	Feature Phone
Model No.:	A17
Operation Frequency:	2402MHz~2480MHz
Channel numbers:	79
Channel separation:	1MHz
Modulation type:	GFSK
Antenna Type:	Monopole antenna
Antenna gain:	1dBi (declare by Applicant)
Power supply:	Model No.: A17 Input: AC 100-240V, 50/60Hz, 0.3A Output: DC 5.0V, 0.4A DC 3.7V Li-ion Battery

Operation Frequency each of channel							
Channel	Frequency	Channel	Frequency	Channel	Frequency	Channel	Frequency
1	2402MHz	21	2422MHz	41	2442MHz	61	2462MHz
2	2403MHz	22	2423MHz	42	2443MHz	62	2463MHz
3	2404MHz	23	2424MHz	43	2444MHz	63	2464MHz
4	2405MHz	24	2425MHz	44	2445MHz	64	2465MHz
5	2406MHz	25	2426MHz	45	2446MHz	65	2466MHz
6	2407MHz	26	2427MHz	46	2447MHz	66	2467MHz
7	2408MHz	27	2428MHz	47	2448MHz	67	2468MHz
8	2409MHz	28	2429MHz	48	2449MHz	68	2469MHz
9	2410MHz	29	2430MHz	49	2450MHz	69	2470MHz
10	2411MHz	30	2431MHz	50	2451MHz	70	2471MHz
11	2412MHz	31	2432MHz	51	2452MHz	71	2472MHz
12	2413MHz	32	2433MHz	52	2453MHz	72	2473MHz
13	2414MHz	33	2434MHz	53	2454MHz	73	2474MHz
14	2415MHz	34	2435MHz	54	2455MHz	74	2475MHz
15	2416MHz	35	2436MHz	55	2456MHz	75	2476MHz
16	2417MHz	36	2437MHz	56	2457MHz	76	2477MHz
17	2418MHz	37	2438MHz	57	2458MHz	77	2478MHz
18	2419MHz	38	2439MHz	58	2459MHz	78	2479MHz
19	2420MHz	39	2440MHz	59	2460MHz	79	2480MHz
20	2421MHz	40	2441MHz	60	2461MHz		

Note:

In section 15.31(m), regards to the operating frequency range over 10 MHz, the Lowest frequency, the middle frequency, and the highest frequency of channel were selected to perform the test, and the selected channel see below:

Channel	Frequency
The lowest channel	2402MHz
The middle channel	2441MHz
The Highest channel	2480MHz

5.3 Test mode

Transmitting mode	Turn off the WiFi and keep the Bluetooth in continuously transmitting mode
-------------------	--

5.4 Test Facility

The test facility is recognized, certified, or accredited by the following organizations:

● **CNAS —Registration No.: CNAS L5775**

CNAS has accredited Global United Technology Services Co., Ltd. To ISO/IEC 17025 General Requirements for the competence of testing and calibration laboratories (CNAS-CL01 Accreditation Criteria for the Competence of Testing and Calibration Laboratories) for the competence in the field of testing.

● **FCC —Registration No.: 600491**

Global United Technology Services Co., Ltd., Shenzhen EMC Laboratory has been registered and fully described in a report filed with the (FCC) Federal Communications Commission. The acceptance letter from the FCC is maintained in files. Registration 600491, June 28, 2013.

● **Industry Canada (IC) —Registration No.: 9079A-2**

The 3m Semi-anechoic chamber of Global United Technology Services Co., Ltd. has been registered by Certification and Engineering Bureau of Industry Canada for radio equipment testing with Registration No.: 9079A-2, June 26, 2013.

5.5 Test Location

All tests were performed at:

Global United Technology Services Co., Ltd.

Address: Room 301-309, 3th Floor, Block A, Huafeng Jinyuan Business Building, No. 300 Laodong Industrial Zone, Xixiang Road, Baoan District, Shenzhen 518102

Tel: 0755-27798480

Fax: 0755-27798960

5.6 Other Information Requested by the Customer

None.

5.7 Description of Support Units

None.

6 Test Instruments list

Radiated Emission:						
Item	Test Equipment	Manufacturer	Model No.	Inventory No.	Cal.Date (mm-dd-yy)	Cal.Due date (mm-dd-yy)
1	3m Semi- Anechoic Chamber	ZhongYu Electron	9.2(L)*6.2(W)* 6.4(H)	GTS250	Mar. 27 2015	Mar. 26 2016
2	Control Room	ZhongYu Electron	6.2(L)*2.5(W)* 2.4(H)	GTS251	N/A	N/A
3	Spectrum Analyzer	Agilent	E4440A	GTS533	Dec. 4 2014	Dec. 3 2015
4	EMI Test Receiver	Rohde & Schwarz	ESU26	GTS203	July 01 2014	June 30 2015
5	BiConiLog Antenna	SCHWARZBECK MESS-ELEKTRONIK	VULB9163	GTS214	July 01 2014	June 30 2015
6	Double -ridged waveguide horn	SCHWARZBECK MESS-ELEKTRONIK	9120D-829	GTS208	June 27 2014	June 26 2015
7	Horn Antenna	ETS-LINDGREN	3160	GTS217	Mar. 28 2014	Mar. 27 2015
8	EMI Test Software	AUDIX	E3	N/A	N/A	N/A
9	Coaxial Cable	GTS	N/A	GTS213	Mar. 27 2015	Mar. 26 2016
10	Coaxial Cable	GTS	N/A	GTS211	Mar. 28 2015	Mar. 27 2016
11	Coaxial cable	GTS	N/A	GTS210	Mar. 28 2015	Mar. 27 2016
12	Coaxial Cable	GTS	N/A	GTS212	Mar. 28 2015	Mar. 27 2016
13	Amplifier(100kHz-3GHz)	HP	8347A	GTS204	July 01 2014	June 30 2015
14	Amplifier(2GHz-20GHz)	HP	8349B	GTS206	July 01 2014	June 30 2015
15	Amplifier (18-26GHz)	Rohde & Schwarz	AFS33-18002 650-30-8P-44	GTS218	June 27 2014	June 26 2015
16	Band filter	Amindeon	82346	GTS219	Mar. 28 2015	Mar. 27 2016

Conducted Emission:						
Item	Test Equipment	Manufacturer	Model No.	Inventory No.	Cal.Date (mm-dd-yy)	Cal.Due date (mm-dd-yy)
1	Shielding Room	ZhongYu Electron	7.0(L)x3.0(W)x3.0(H)	GTS264	Sep. 07 2013	Sep. 06 2015
2	EMI Test Receiver	Rohde & Schwarz	ESCS30	GTS223	July 01 2014	June 30 2015
3	10dB Pulse Limita	Rohde & Schwarz	N/A	GTS224	July 01 2014	June 30 2015
4	Coaxial Switch	ANRITSU CORP	MP59B	GTS225	July 01 2014	June 30 2015
5	LISN	SCHWARZBECK MESS-ELEKTRONIK	NSLK 8127	GTS226	July 01 2014	June 30 2015
6	Coaxial Cable	GTS	N/A	GTS227	July 01 2014	June 30 2015
7	EMI Test Software	AUDIX	E3	N/A	N/A	N/A

General used equipment:						
Item	Test Equipment	Manufacturer	Model No.	Inventory No.	Cal.Date (mm-dd-yy)	Cal.Due date (mm-dd-yy)
1	Barometer	ChangChun	DYM3	GTS257	July 08 2014	July 07 2015

7 Test results and Measurement Data

7.1 Antenna requirement

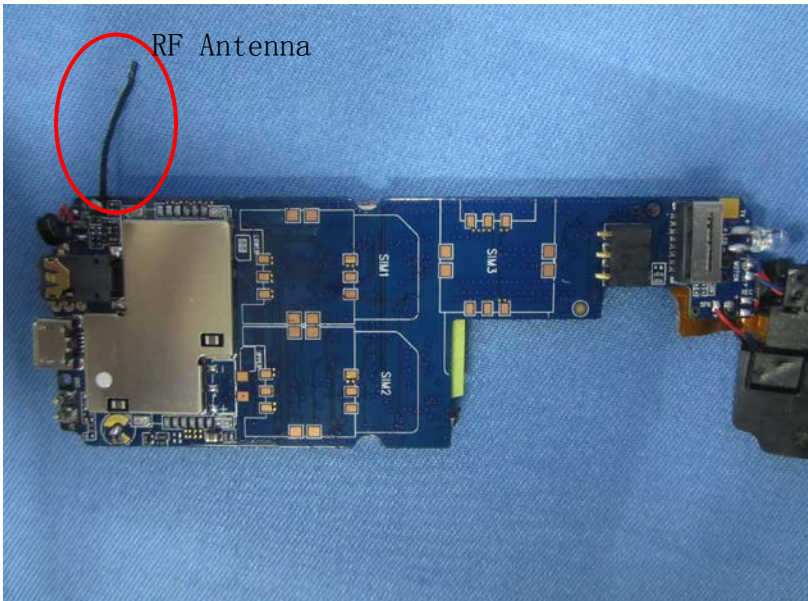
Standard requirement:	FCC Part15 C Section 15.203 /247(c)
<p>15.203 requirement:</p> <p>An intentional radiator shall be designed to ensure that no antenna other than that furnished by the responsible party shall be used with the device. The use of a permanently attached antenna or of an antenna that uses a unique coupling to the intentional radiator, the manufacturer may design the unit so that a broken antenna can be replaced by the user, but the use of a standard antenna jack or electrical connector is prohibited.</p> <p>15.247(c) (1)(i) requirement:</p> <p>(i) Systems operating in the 2400-2483.5 MHz band that is used exclusively for fixed. Point-to-point operations may employ transmitting antennas with directional gain greater than 6dBi provided the maximum conducted output power of the intentional radiator is reduced by 1 dB for every 3 dB that the directional gain of the antenna exceeds 6dBi.</p>	
E.U.T Antenna:	
<p><i>The antenna is PIFA antenna, the best case gain of the antenna is 1dBi</i></p> 	

7.2 Conducted Emissions

Test Requirement:	FCC Part15 C Section 15.207														
Test Method:	ANSI C63.4:2009														
Test Frequency Range:	150KHz to 30MHz														
Class / Severity:	Class B														
Receiver setup:	RBW=9KHz, VBW=30KHz, Sweep time=auto														
Limit:	<table border="1"> <thead> <tr> <th rowspan="2">Frequency range (MHz)</th> <th colspan="2">Limit (dBuV)</th> </tr> <tr> <th>Quasi-peak</th> <th>Average</th> </tr> </thead> <tbody> <tr> <td>0.15-0.5</td> <td>66 to 56*</td> <td>56 to 46*</td> </tr> <tr> <td>0.5-5</td> <td>56</td> <td>46</td> </tr> <tr> <td>5-30</td> <td>60</td> <td>50</td> </tr> </tbody> </table> <p>* Decreases with the logarithm of the frequency.</p>	Frequency range (MHz)	Limit (dBuV)		Quasi-peak	Average	0.15-0.5	66 to 56*	56 to 46*	0.5-5	56	46	5-30	60	50
Frequency range (MHz)	Limit (dBuV)														
	Quasi-peak	Average													
0.15-0.5	66 to 56*	56 to 46*													
0.5-5	56	46													
5-30	60	50													
Test setup:	<p><i>Remark</i> E.U.T: Equipment Under Test LISN: Line Impedance Stabilization Network Test table height=0.8m</p>														
Test procedure:	<ol style="list-style-type: none"> 1. The E.U.T and simulators are connected to the main power through a line impedance stabilization network (L.I.S.N.). This provides a 50ohm/50uH coupling impedance for the measuring equipment. 2. The peripheral devices are also connected to the main power through a LISN that provides a 50ohm/50uH coupling impedance with 50ohm termination. (Please refer to the block diagram of the test setup and photographs). 3. Both sides of A.C. line are checked for maximum conducted interference. In order to find the maximum emission, the relative positions of equipment and all of the interface cables must be changed according to ANSI C63.4: 2009 on conducted measurement. 														
Test Instruments:	Refer to section 6.0 for details														
Test mode:	Refer to section 5.3 for details														
Test results:	Pass														

Measurement data:

Line:

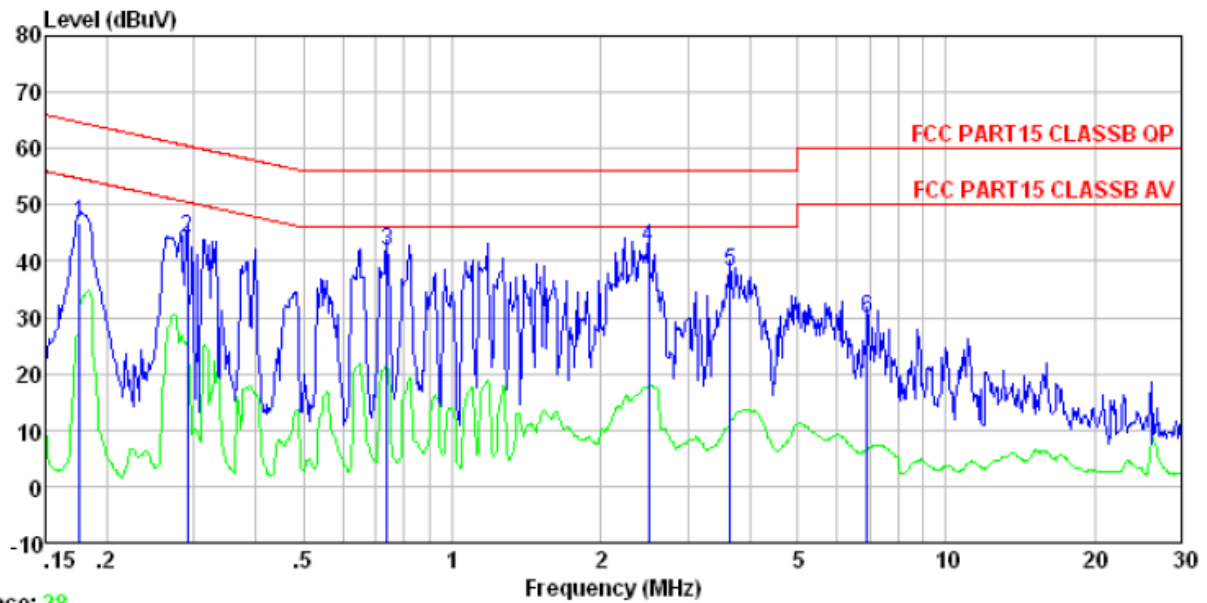

Site : Shielded room
 Condition : FCC PART15 CLASSB QP LISN-2013 LINE
 Job No. : 0320RF
 Test mode : Bluetooth mode
 Test Engineer: Mike

	Read Freq	LISN Level	Cable Factor	Cable Loss	Level	Limit Line	Over Limit	Remark
	MHz	dBuV	dB	dB	dBuV	dBuV	dB	
1	0.176	46.56	0.14	0.13	46.83	64.68	-17.85	QP
2	0.291	43.89	0.11	0.10	44.10	60.50	-16.40	QP
3	0.739	41.48	0.14	0.13	41.75	56.00	-14.25	QP
4	2.500	42.07	0.13	0.15	42.35	56.00	-13.65	QP
5	3.661	37.87	0.19	0.15	38.21	56.00	-17.79	QP
6	6.914	29.57	0.24	0.17	29.98	60.00	-30.02	QP

Neutral:

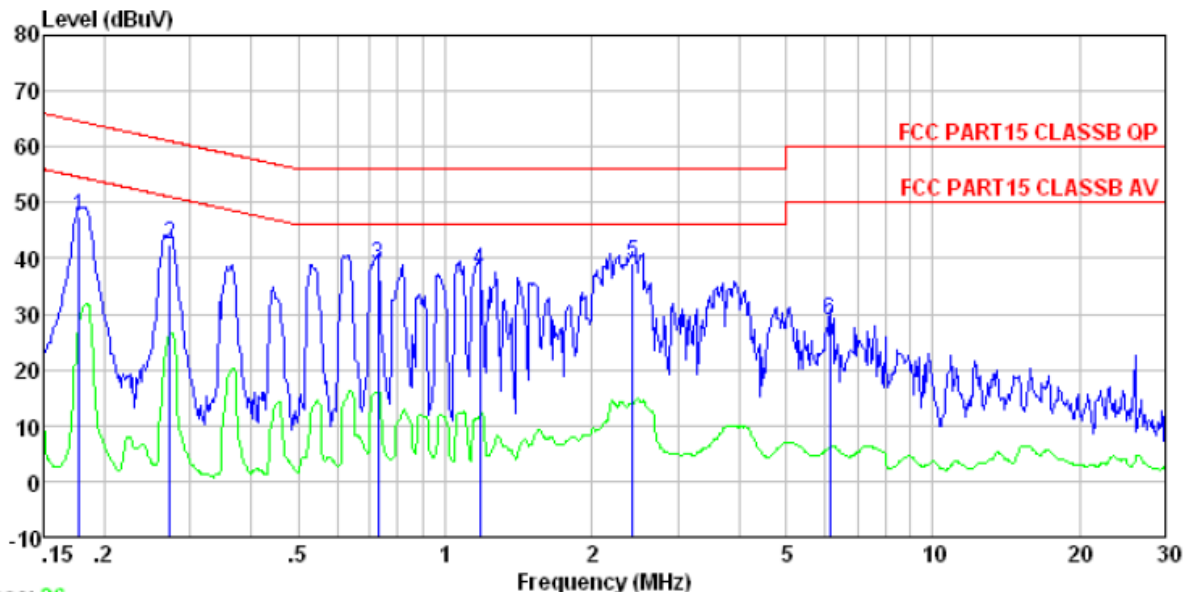

Trace: 26

Site : Shielded room
 Condition : FCC PART15 CLASSB QP LISN-2013 NEUTRAL
 Job No. : 0320RF
 Test mode : Bluetooth mode
 Test Engineer: Mike

	Freq	Read Level	LISN Factor	Cable Loss	Level	Limit Line	Over Limit	Remark
	MHz	dBuV	dB	dB	dBuV	dBuV	dB	
1	0.178	47.37	0.07	0.13	47.57	64.59	-17.02	QP
2	0.273	42.38	0.06	0.10	42.54	61.03	-18.49	QP
3	0.727	38.60	0.07	0.13	38.80	56.00	-17.20	QP
4	1.178	37.65	0.08	0.13	37.86	56.00	-18.14	QP
5	2.422	38.87	0.10	0.15	39.12	56.00	-16.88	QP
6	6.153	28.38	0.17	0.16	28.71	60.00	-31.29	QP

Notes:

1. An initial pre-scan was performed on the line and neutral lines with peak detector.
2. Quasi-Peak and Average measurement were performed at the frequencies with maximized peak emission.
3. Final Level = Receiver Read level + LISN Factor + Cable Loss

7.3 Conducted Peak Output Power

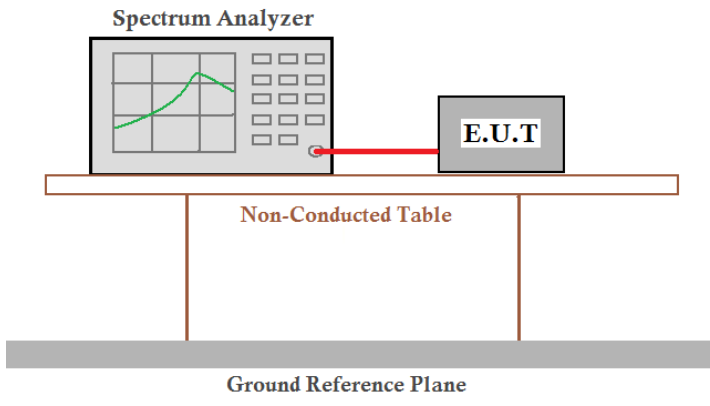
Test Requirement:	FCC Part15 C Section 15.247 (b)(3)
Test Method:	ANSI C63.4:2009
Limit:	30dBm
Test setup:	 <p>The diagram illustrates the test setup. A Spectrum Analyzer is connected to an E.U.T. (Equipment Under Test) via a red cable. Both are placed on a Non-Conducted Table, which is supported by a Ground Reference Plane.</p>
Test Instruments:	Refer to section 6.0 for details
Test mode:	Refer to section 5.3 for details
Test results:	Pass

Measurement Data

Mode	Test channel	Peak Output Power (dBm)	Limit (dBm)	Result
GFSK	Lowest	5.03	30.00	Pass
	Middle	5.20		
	Highest	5.22		

Test plot as follows:

Test mode:	GFSK mode
------------	-----------

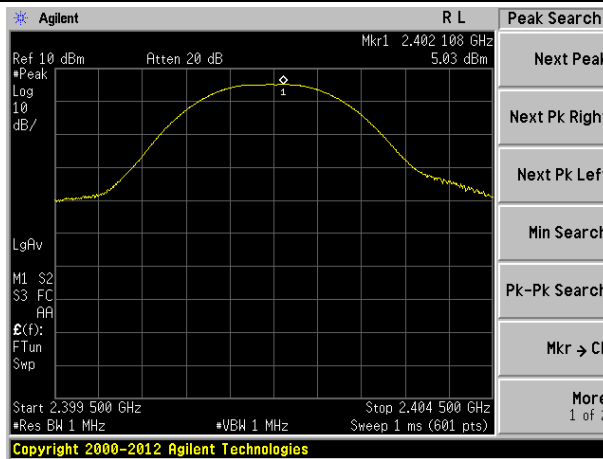

Lowest channel

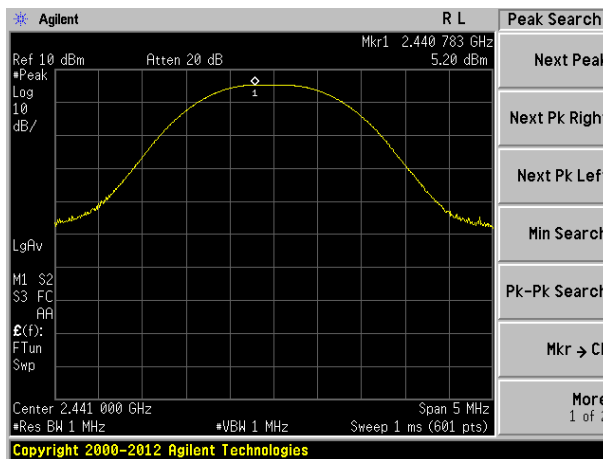

Middle channel

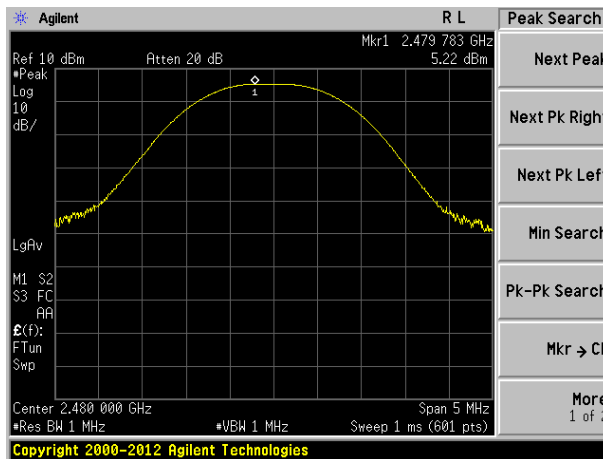

Highest channel

7.4 20dB Emission Bandwidth

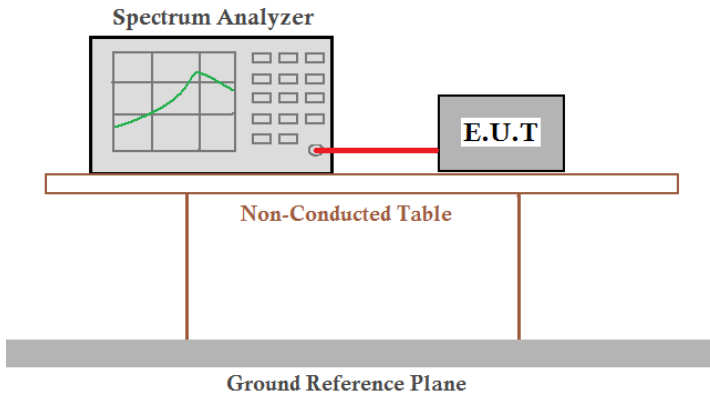
Test Requirement:	FCC Part15 C Section 15.247 (a)(2)
Test Method:	ANSI C63.4:2009
Limit:	N/A
Test setup:	 <p>The diagram illustrates the test setup. A Spectrum Analyzer is connected to an E.U.T. (Equipment Under Test) via a red cable. Both are placed on a Non-Conducted Table, which is supported by a Ground Reference Plane.</p>
Test Instruments:	Refer to section 6.0 for details
Test mode:	Refer to section 5.3 for details
Test results:	Pass

Measurement Data

Mode	Test channel	20dB Emission Bandwidth (MHz)	Result
GFSK	Lowest	0.837	Pass
	Middle	0.838	
	Highest	0.836	

Test plot as follows:

Test mode:	GFSK mode
------------	-----------

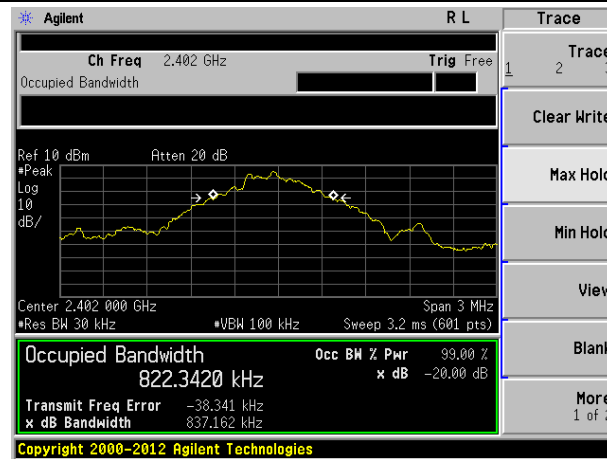

Lowest channel

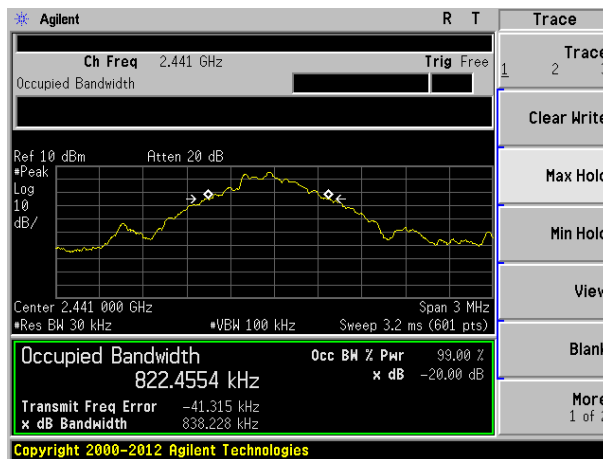

Middle channel

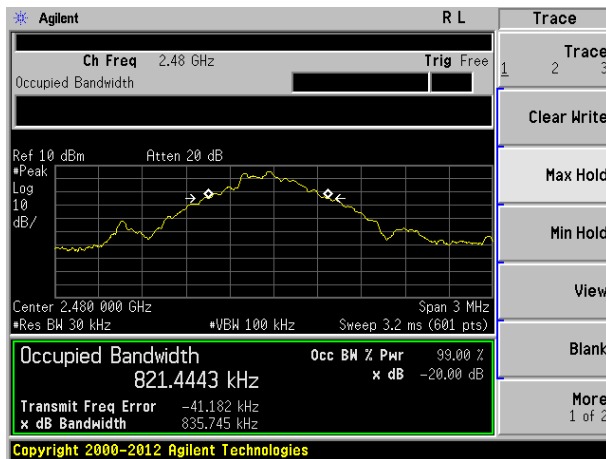

Highest channel

7.5 Carrier Frequencies Separation

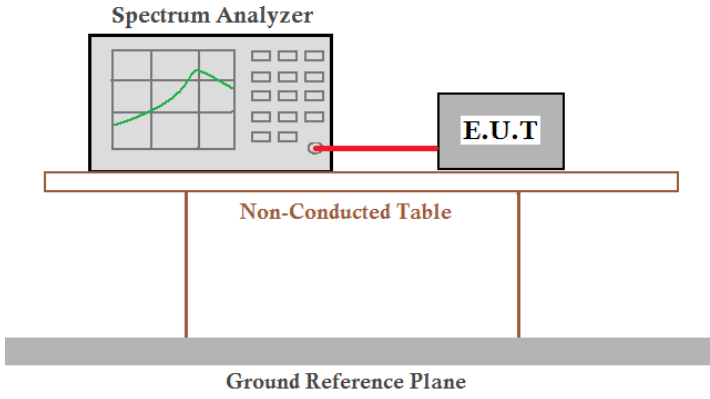
Test Requirement:	FCC Part15 C Section 15.247 (a)(1)
Test Method:	ANSI C63.4:2009
Receiver setup:	RBW=100KHz, VBW=300KHz, detector=Peak
Limit:	0.025MHz or 2/3 of the 20dB bandwidth (whichever is greater)
Test setup:	 <p>The diagram illustrates the test setup. A Spectrum Analyzer is connected to an E.U.T. (Equipment Under Test) via a red cable. Both are placed on a Non-Conducted Table, which is supported by a Ground Reference Plane.</p>
Test Instruments:	Refer to section 6.0 for details
Test mode:	Refer to section 5.3 for details
Test results:	Pass

Measurement Data

Mode	Test channel	Carrier Frequencies Separation (kHz)	Limit (kHz)	Result
GFSK	Lowest	1000	559	Pass
	Middle	1000	559	Pass
	Highest	1000	559	Pass

Note: According to section 7.4

Mode	20dB bandwidth (kHz) (worse case)	Limit (kHz) (Carrier Frequencies Separation)
GFSK	838	559

Test plot as follows:

Modulation mode:	GFSK
------------------	------

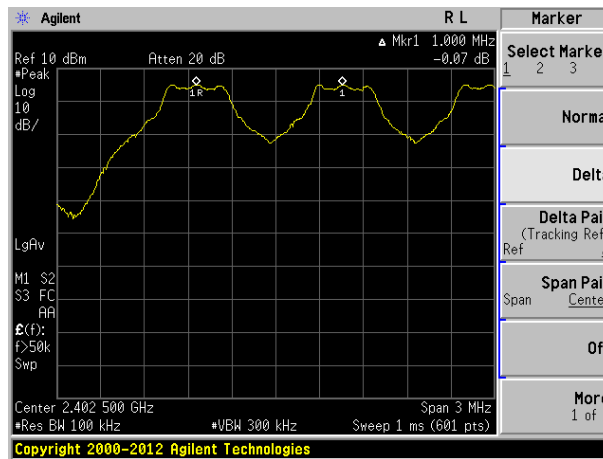

Lowest channel

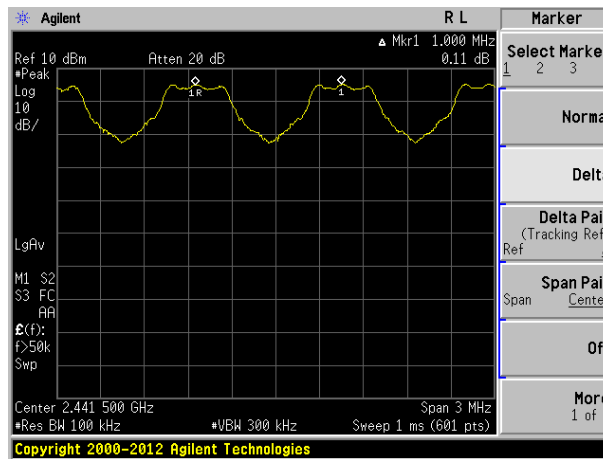

Middle channel

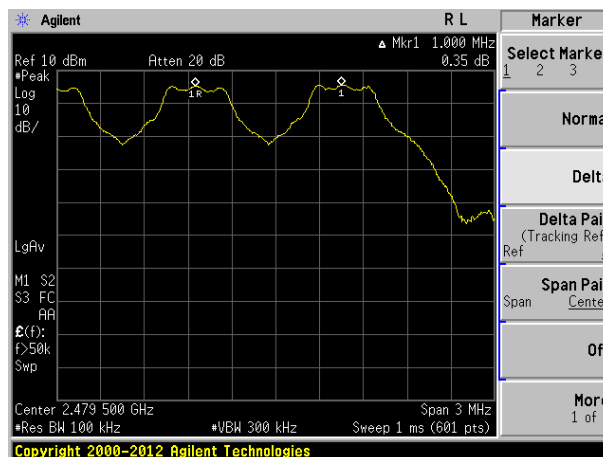

Highest channel

7.6 Hopping Channel Number

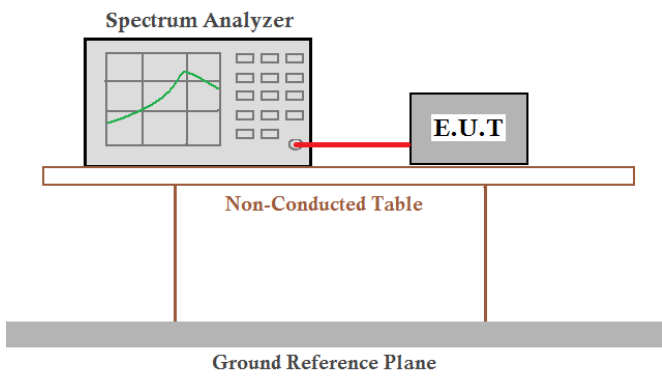
Test Requirement:	FCC Part15 C Section 15.247 (a)(1)
Test Method:	ANSI C63.4:2009
Receiver setup:	RBW=100kHz, VBW=300kHz, Frequency range=2400MHz-2483.5MHz, Detector=Peak
Limit:	15 channels
Test setup:	 <p>The diagram illustrates the test setup. A Spectrum Analyzer is connected via a red cable to an E.U.T. (Equipment Under Test). Both are placed on a Non-Conducted Table. Below the table is a Ground Reference Plane.</p>
Test Instruments:	Refer to section 6.0 for details
Test mode:	Refer to section 5.3 for details
Test results:	Pass

Measurement Data:

Mode	Hopping channel numbers	Limit	Result
GFSK	79	15	Pass

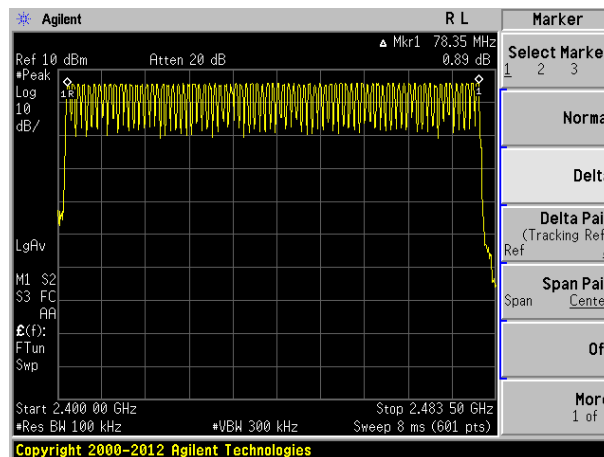

7.7 Dwell Time

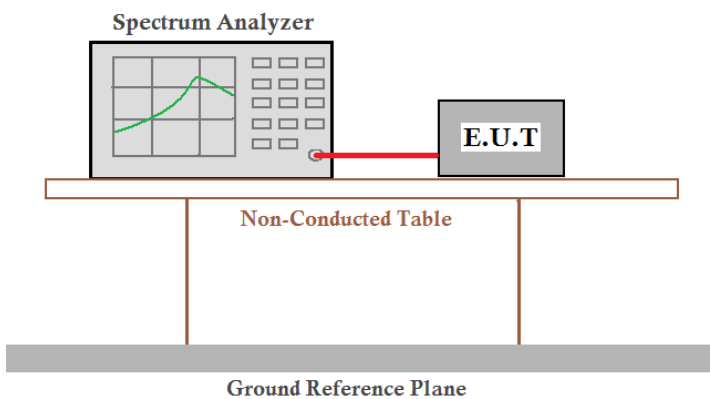
Test Requirement:	FCC Part15 C Section 15.247 (a)(1)
Test Method:	ANSI C63.4:2009
Receiver setup:	RBW=1MHz, VBW=1MHz, Span=0Hz, Detector=Peak
Limit:	0.4 Second
Test setup:	 <p>The diagram illustrates the test setup. A Spectrum Analyzer is connected via a red cable to an E.U.T. (Equipment Under Test). Both are placed on a Non-Conducted Table. Below the table is a Ground Reference Plane.</p>
Test Instruments:	Refer to section 6.0 for details
Test mode:	Refer to section 5.3 for details
Test results:	Pass

Measurement Data

Frequency	Packet	Dwell time(ms)	Limit(ms)	Result
2402MHz	DH1/2-DH1/3-DH1	128.00	400	Pass
2441MHz	DH3/2-DH3/3-DH3	265.60	400	Pass
2480MHz	DH5/2-DH5/3-DH5	310.19	400	Pass

The test period: $T = 0.4 \text{ Second/Channel} \times 79 \text{ Channel} = 31.6 \text{ s}$

Test channel: 2402MHz/2441MHz/2480MHz as blow

DH1/2-DH1/3-DH1 time slot = $0.40(\text{ms}) \times (1600 / (2 \times 79)) \times 31.6 = 128.00\text{ms}$

DH3/2-DH3/3-DH3 time slot = $1.66(\text{ms}) \times (1600 / (4 \times 79)) \times 31.6 = 265.600\text{ms}$

DH5/2-DH5/3-DH5 time slot = $2.908(\text{ms}) \times (1600 / (6 \times 79)) \times 31.6 = 310.19\text{ms}$

Test plot as follows:

Test channel:	2402MHz/2441MHz/2480MHz
---------------	-------------------------

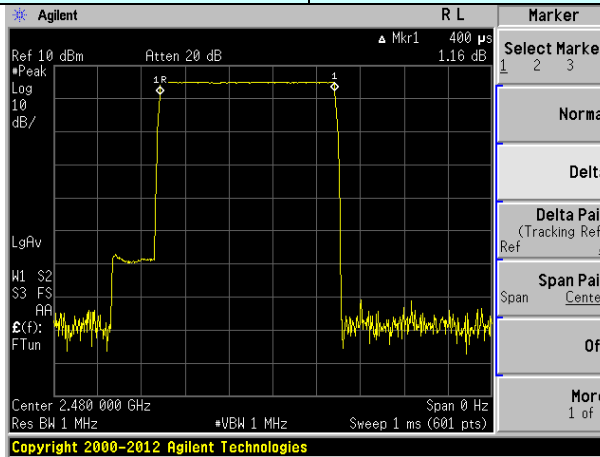

DH1/2-DH1/3-DH1

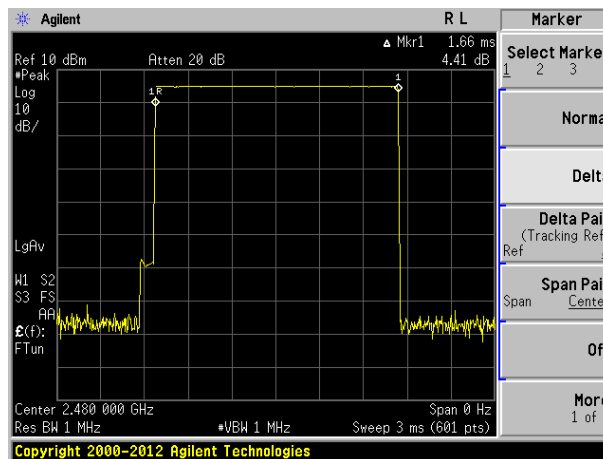

DH3/2-DH3/3-DH3

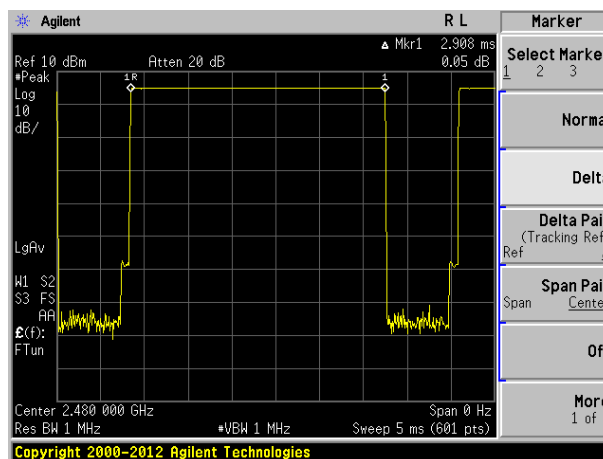

DH5/2-DH5/3-DH5

7.8 Pseudorandom Frequency Hopping Sequence

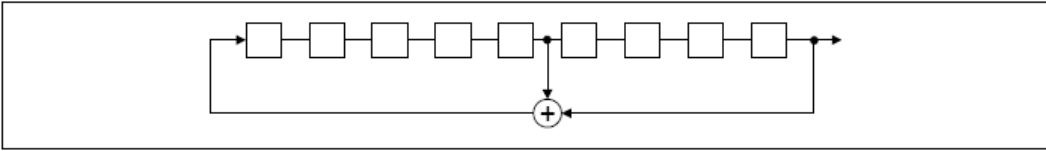
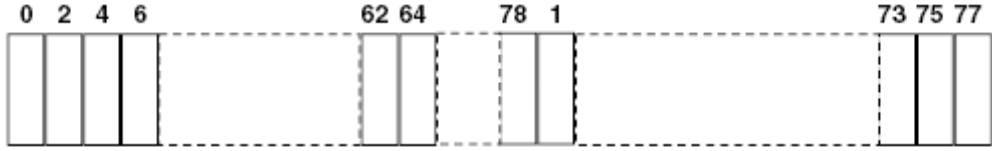
Test Requirement:	FCC Part15 C Section 15.247 (a)(1) requirement:
<p><i>Frequency hopping systems shall have hopping channel carrier frequencies separated by a minimum of 25 kHz or the 20 dB bandwidth of the hopping channel, whichever is greater.</i></p> <p><i>Alternatively. Frequency hopping systems operating in the 2400-2483.5 MHz band may have hopping channel carrier frequencies that are separated by 25 kHz or two-thirds of the 20 dB bandwidth of the hopping channel, whichever is greater, provided the systems operate with an output power no greater than 125 mW. The system shall hop to channel frequencies that are selected at the system hopping rate from a Pseudorandom ordered list of hopping frequencies. Each frequency must be used equally on the average by each transmitter. The system receivers shall have input bandwidths that match the hopping channel bandwidths of their corresponding transmitters and shall shift frequencies in synchronization with the transmitted signals.</i></p>	
EUT Pseudorandom Frequency Hopping Sequence	
<p><i>The pseudorandom sequence may be generated in a nine-stage shift register whose 5th and 9th stage outputs are added in a modulo-two addition stage. And the result is fed back to the input of the first stage. The sequence begins with the first ONE of 9 consecutive ONES; i.e. the shift register is initialized with nine ones.</i></p> <ul style="list-style-type: none"> • Number of shift register stages: 9 • Length of pseudo-random sequence: $2^9 - 1 = 511$ bits • Longest sequence of zeros: 8 (non-inverted signal) 	
	
<p><i>Linear Feedback Shift Register for Generation of the PRBS sequence</i></p>	
<p><i>An example of Pseudorandom Frequency Hopping Sequence as follow:</i></p>	
	
<p><i>Each frequency used equally on the average by each transmitter.</i></p> <p><i>The system receivers have input bandwidths that match the hopping channel bandwidths of their corresponding transmitters and shift frequencies in synchronization with the transmitted signals.</i></p>	

7.9 Band Edge

7.9.1 Conducted Emission Method

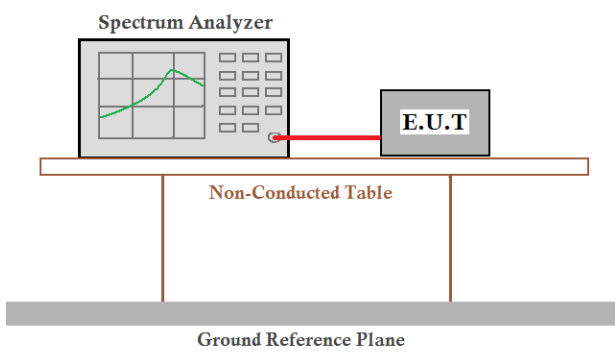
Test Requirement:	FCC Part15 C Section 15.247 (d)
Test Method:	ANSI C63.4:2009
Receiver setup:	RBW=100kHz, VBW=300kHz, Detector=Peak
Limit:	In any 100 kHz bandwidth outside the frequency band in which the spread spectrum intentional radiator is operating, the radio frequency power that is produced by the intentional radiator shall be at least 20 dB below that in the 100 kHz bandwidth within the band that contains the highest level of the desired power, based on either an RF conducted or a radiated measurement.
Test setup:	 <p>The diagram illustrates the test setup. A Spectrum Analyzer is connected to an E.U.T. (Equipment Under Test) via a red cable. Both are placed on a Non-Conducted Table, which is supported by a Ground Reference Plane.</p>
Test Instruments:	Refer to section 6.0 for details
Test mode:	Refer to section 5.3 for details
Test results:	Pass

Test plot as follows:

GFSK Mode:

Test channel: Lowest channel

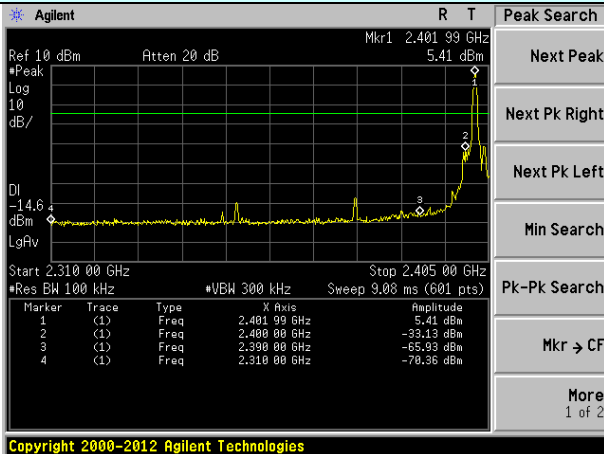

No-hopping mode

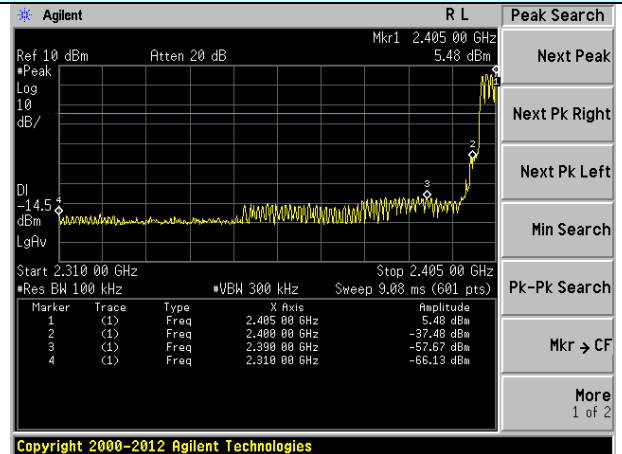

Hopping mode

Test channel: Highest channel

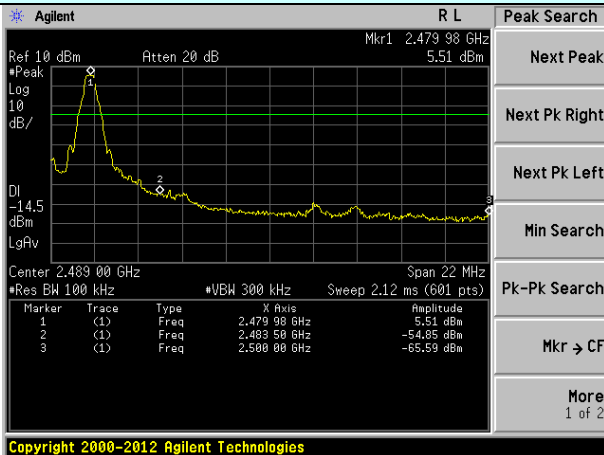

No-hopping mode

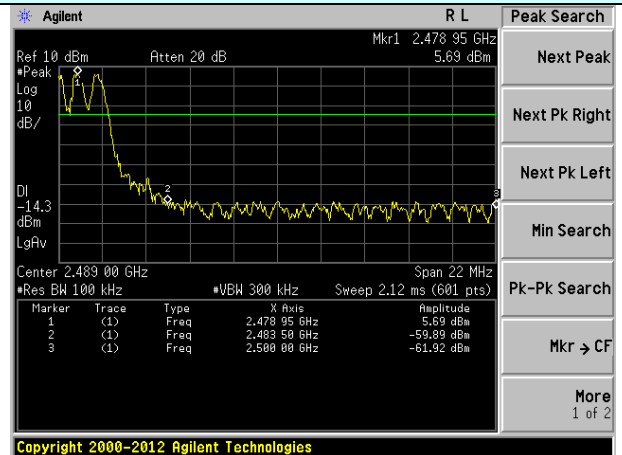

Hopping mode

7.9.2 Radiated Emission Method

Test Requirement:	FCC Part15 C Section 15.209 and 15.205				
Test Method:	ANSI C63.4: 2009				
Test Frequency Range:	All restriction band have been tested, and 2.3GHz to 2.5GHz band is the worse case				
Test site:	Measurement Distance: 3m				
Receiver setup:	Frequency	Detector	RBW	VBW	Remark
	Above 1GHz	Peak	1MHz	3MHz	Peak Value
		Peak	1MHz	10Hz	Average Value
Limit:	Frequency		Limit (dBuV/m @3m)		Remark
	Above 1GHz		54.00		Average Value
			74.00		Peak Value
Test setup:					
Test Procedure:	<ol style="list-style-type: none"> 1. The EUT was placed on the top of a rotating table 0.8 meters above the ground at a 3 meter camber. The table was rotated 360 degrees to determine the position of the highest radiation. 2. The EUT was set 3 meters away from the interference-receiving antenna, which was mounted on the top of a variable-height antenna tower. 3. The antenna height is varied from one meter to four meters above the ground to determine the maximum value of the field strength. Both horizontal and vertical polarizations of the antenna are set to make the measurement. 4. For each suspected emission, the EUT was arranged to its worst case and then the antenna was tuned to heights from 1 meter to 4 meters and the rota table was turned from 0 degrees to 360 degrees to find the maximum reading. 5. The test-receiver system was set to Peak Detect Function and Specified Bandwidth with Maximum Hold Mode. 6. If the emission level of the EUT in peak mode was 10dB lower than the limit specified, then testing could be stopped and the peak values of the EUT would be reported. Otherwise the emissions that did not have 10dB margin would be re-tested one by one using peak, quasi-peak or average method as specified and then reported in a data sheet. 				
Test Instruments:	Refer to section 6.0 for details				
Test mode:	Refer to section 5.3 for details				
Test results:	Pass				

Remark:

1. Pre-scan all kind of the place mode (X-axis, Y-axis, Z-axis), and found the Y-axis which it is worse case.

Test channel:	Lowest
---------------	--------

Peak value:

Frequency (MHz)	Read Level (dBuV)	Antenna Factor (dB/m)	Cable Loss (dB)	Preamp Factor (dB)	Level (dBuV/m)	Limit Line (dBuV/m)	Over Limit (dB)	Polarization
2310.00	45.18	27.59	5.38	30.18	47.97	74.00	-26.03	Horizontal
2390.00	56.84	27.58	5.39	30.18	59.63	74.00	-14.37	Horizontal
2310.00	45.95	27.59	5.38	30.18	48.74	74.00	-25.26	Vertical
2390.00	58.33	27.58	5.39	30.18	61.12	74.00	-12.88	Vertical

Average value:

Frequency (MHz)	Read Level (dBuV)	Antenna Factor (dB/m)	Cable Loss (dB)	Preamp Factor (dB)	Level (dBuV/m)	Limit Line (dBuV/m)	Over Limit (dB)	Polarization
2310.00	35.21	27.59	5.38	30.18	38.00	54.00	-16.00	Horizontal
2390.00	40.33	27.58	5.39	30.18	43.12	54.00	-10.88	Horizontal
2310.00	35.32	27.59	5.38	30.18	38.11	54.00	-15.89	Vertical
2390.00	41.20	27.58	5.39	30.18	43.99	54.00	-10.01	Vertical

Test channel:	Highest
---------------	---------

Peak value:

Frequency (MHz)	Read Level (dBuV)	Antenna Factor (dB/m)	Cable Loss (dB)	Preamp Factor (dB)	Level (dBuV/m)	Limit Line (dBuV/m)	Over Limit (dB)	Polarization
2483.50	47.56	27.53	5.47	29.93	50.63	74.00	-23.37	Horizontal
2500.00	46.29	27.55	5.49	29.93	49.40	74.00	-24.60	Horizontal
2483.50	48.79	27.53	5.47	29.93	51.86	74.00	-22.14	Vertical
2500.00	47.51	27.55	5.49	29.93	50.62	74.00	-23.38	Vertical

Average value:

Frequency (MHz)	Read Level (dBuV)	Antenna Factor (dB/m)	Cable Loss (dB)	Preamp Factor (dB)	Level (dBuV/m)	Limit Line (dBuV/m)	Over Limit (dB)	Polarization
2483.50	38.07	27.53	5.47	29.93	41.14	54.00	-12.86	Horizontal
2500.00	35.74	27.55	5.49	29.93	38.85	54.00	-15.15	Horizontal
2483.50	39.47	27.53	5.47	29.93	42.54	54.00	-11.46	Vertical
2500.00	35.85	27.55	5.49	29.93	38.96	54.00	-15.04	Vertical

Remark:

1. Final Level = Receiver Read level + Antenna Factor + Cable Loss – Preamplifier Factor
2. The emission levels of other frequencies are very lower than the limit and not show in test report.

7.10 Spurious Emission

7.10.1 Conducted Emission Method

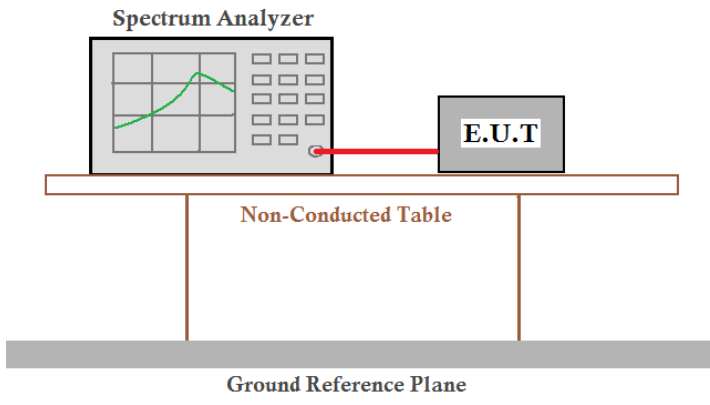
Test Requirement:	FCC Part15 C Section 15.247 (d)
Test Method:	ANSI C63.4:2009 and KDB558074 D01 Meas Guidance
Limit:	In any 100 kHz bandwidth outside the frequency band in which the spread spectrum intentional radiator is operating, the radio frequency power that is produced by the intentional radiator shall be at least 20 dB below that in the 100 kHz bandwidth within the band that contains the highest level of the desired power, based on either an RF conducted or a radiated measurement.
Test setup:	 <p>The diagram illustrates the test setup. A Spectrum Analyzer is connected to an E.U.T. (Equipment Under Test) via a red cable. Both are placed on a Non-Conducted Table, which is supported by two legs. Below the table is a Ground Reference Plane.</p>
Test Instruments:	Refer to section 6.0 for details
Test mode:	Refer to section 5.3 for details
Test results:	Pass

Test channel: **Lowest channel**

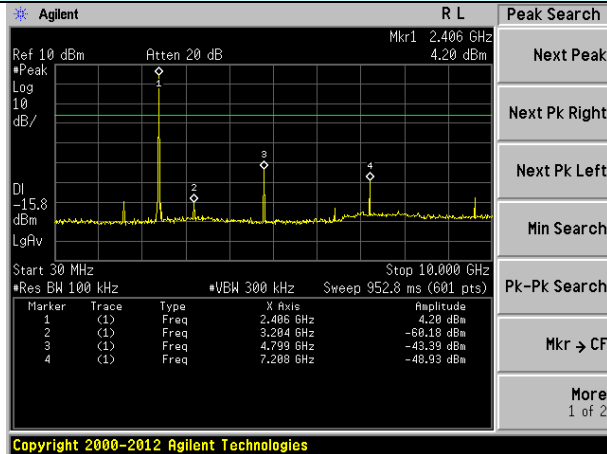

30MHz~10GHz

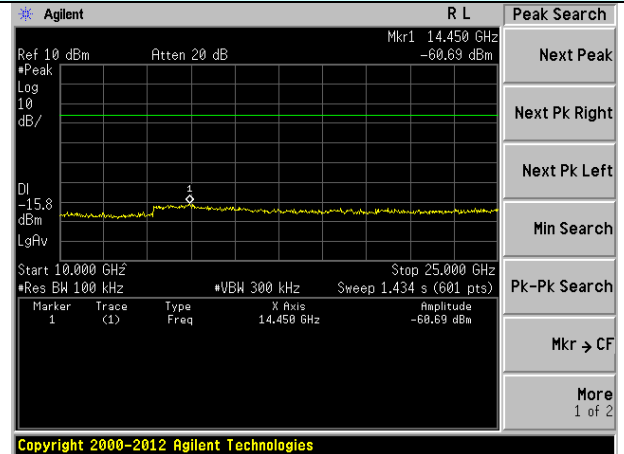

10GHz~25GHz

Test channel: **Middle channel**

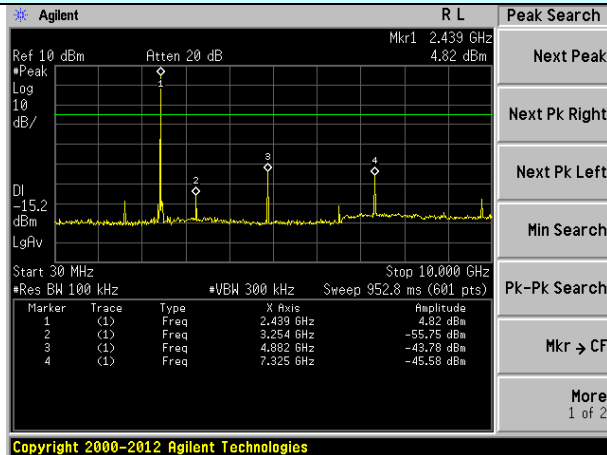

30MHz~10GHz

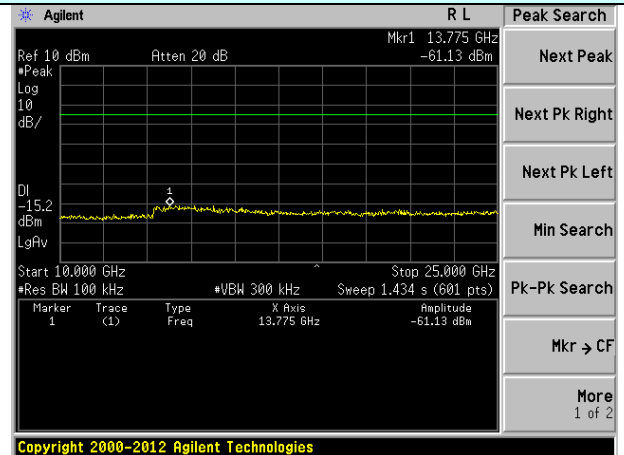

10GHz~25GHz

Test channel: **Highest channel**

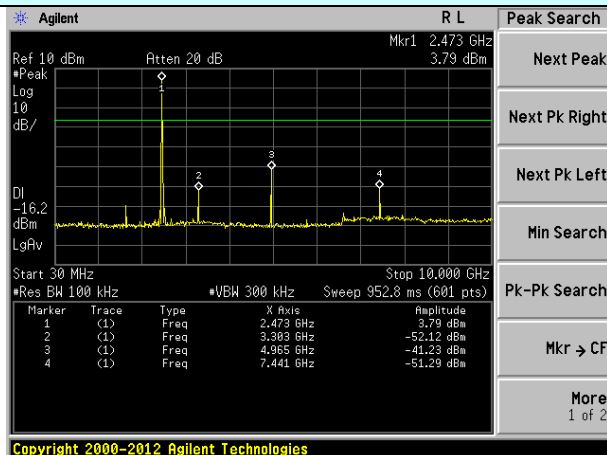

30MHz~10GHz

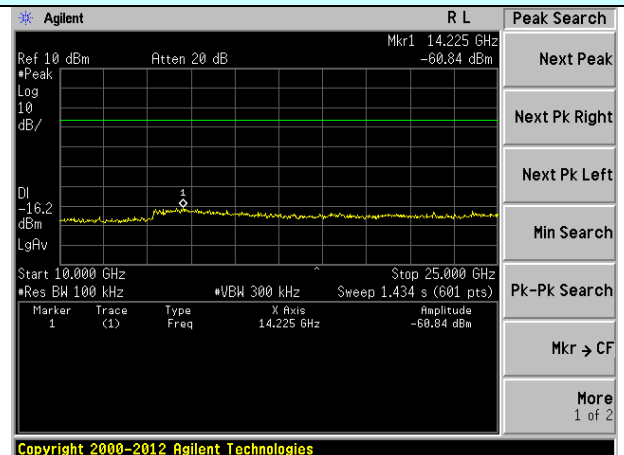

10GHz~25GHz

7.10.2 Radiated Emission Method

Test Requirement:	FCC Part15 C Section 15.209				
Test Method:	ANSI C63.4: 2009				
Test Frequency Range:	30MHz to 25GHz				
Test site:	Measurement Distance: 3m				
Receiver setup:	Frequency	Detector	RBW	VBW	Remark
	30MHz-1GHz	Quasi-peak	120KHz	300KHz	Quasi-peak Value
	Above 1GHz	Peak	1MHz	3MHz	Peak Value
		Peak	1MHz	10Hz	Average Value
Limit:	Frequency	Limit (dBuV/m @3m)		Remark	
	30MHz-88MHz	40.0		Quasi-peak Value	
	88MHz-216MHz	43.5		Quasi-peak Value	
	216MHz-960MHz	46.0		Quasi-peak Value	
	960MHz-1GHz	54.0		Quasi-peak Value	
	Above 1GHz	54.0		Average Value	
74.0		Peak Value			
Test setup:	Below 1GHz				
Test setup:	Above 1GHz				

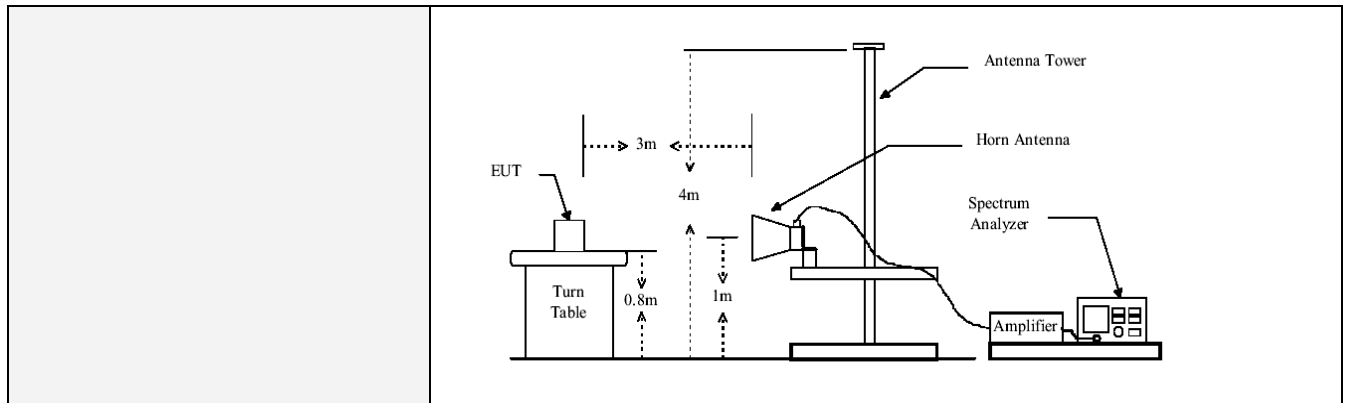

Test Procedure:

1. The EUT was placed on the top of a rotating table 0.8 meters above the ground at a 3 meter camber. The table was rotated 360 degrees to determine the position of the highest radiation.
2. The EUT was set 3 meters away from the interference-receiving antenna, which was mounted on the top of a variable-height antenna tower.
3. The antenna height is varied from one meter to four meters above the ground to determine the maximum value of the field strength. Both horizontal and vertical polarizations of the antenna are set to make the measurement.
4. For each suspected emission, the EUT was arranged to its worst case and then the antenna was tuned to heights from 1 meter to 4 meters and the rota table was turned from 0 degrees to 360 degrees to find the maximum reading.
5. The test-receiver system was set to Peak Detect Function and Specified Bandwidth with Maximum Hold Mode.
6. If the emission level of the EUT in peak mode was 10dB lower than the limit specified, then testing could be stopped and the peak values of the EUT would be reported. Otherwise the emissions that did not have 10dB margin would be re-tested one by one using peak, quasi-peak or average method as specified and then reported in a data sheet.

Test Instruments: Refer to section 6.0 for details

Test mode: Refer to section 5.3 for details

Test results: Pass

Remark:

1. Pre-scan all kind of the place mode (X-axis, Y-axis, Z-axis), and found the Y-axis which it is worse case.

Measurement data:

■ **Below 1GHz**

Frequency (MHz)	Read Level (dBuV)	Antenna Factor (dB/m)	Cable Loss (dB)	Preamplifier Factor (dB)	Level (dBuV/m)	Limit Line (dBuV/m)	Over Limit (dB)	polarization
31.40	42.10	14.32	0.57	30.09	26.90	40.00	-13.10	Vertical
94.10	41.00	14.67	1.14	29.73	27.08	43.50	-16.42	Vertical
132.69	43.88	10.72	1.45	29.50	26.55	43.50	-16.95	Vertical
243.38	47.23	14.08	2.09	29.59	33.81	46.00	-12.19	Vertical
468.88	40.28	17.83	3.18	29.36	31.93	46.00	-14.07	Vertical
547.10	35.74	19.51	3.51	29.30	29.46	46.00	-16.54	Vertical
61.56	33.19	14.03	0.87	29.91	18.18	40.00	-21.82	Horizontal
83.82	46.24	11.87	1.06	29.78	29.39	40.00	-10.61	Horizontal
131.76	47.47	10.82	1.45	29.50	30.24	43.50	-13.26	Horizontal
204.96	53.14	12.74	1.87	29.26	38.49	43.50	-5.01	Horizontal
478.85	39.89	18.07	3.22	29.34	31.84	46.00	-14.16	Horizontal
793.40	40.17	21.96	4.43	29.20	37.36	46.00	-8.64	Horizontal

■ Above 1GHz

Test channel:	Lowest
---------------	--------

Peak value:

Frequency (MHz)	Read Level (dBuV)	Antenna Factor (dB/m)	Cable Loss (dB)	Preamplifier Factor (dB)	Level (dBuV/m)	Limit Line (dBuV/m)	Over Limit (dB)	Polarization
4804.00	37.60	31.78	8.60	32.09	45.89	74.00	-28.11	Vertical
7206.00	32.03	36.15	11.65	32.00	47.83	74.00	-26.17	Vertical
9608.00	31.64	37.95	14.14	31.62	52.11	74.00	-21.89	Vertical
12010.00	*					74.00		Vertical
14412.00	*					74.00		Vertical
4804.00	41.95	31.78	8.60	32.09	50.24	74.00	-23.76	Horizontal
7206.00	33.81	36.15	11.65	32.00	49.61	74.00	-24.39	Horizontal
9608.00	31.10	37.95	14.14	31.62	51.57	74.00	-22.43	Horizontal
12010.00	*					74.00		Horizontal
14412.00	*					74.00		Horizontal

Average value:

Frequency (MHz)	Read Level (dBuV)	Antenna Factor (dB/m)	Cable Loss (dB)	Preamplifier Factor (dB)	Level (dBuV/m)	Limit Line (dBuV/m)	Over Limit (dB)	Polarization
4804.00	26.36	31.78	8.60	32.09	34.65	54.00	-19.35	Vertical
7206.00	20.68	36.15	11.65	32.00	36.48	54.00	-17.52	Vertical
9608.00	19.74	37.95	14.14	31.62	40.21	54.00	-13.79	Vertical
12010.00	*					54.00		Vertical
14412.00	*					54.00		Vertical
4804.00	30.62	31.78	8.60	32.09	38.91	54.00	-15.09	Horizontal
7206.00	22.87	36.15	11.65	32.00	38.67	54.00	-15.33	Horizontal
9608.00	19.49	37.95	14.14	31.62	39.96	54.00	-14.04	Horizontal
12010.00	*					54.00		Horizontal
14412.00	*					54.00		Horizontal

Remark:

1. *Final Level = Receiver Read level + Antenna Factor + Cable Loss – Preamplifier Factor*
2. *“*” , means this data is the too weak instrument of signal is unable to test.*
3. *The emission levels of other frequencies are very lower than the limit and not show in test report.*

Test channel:	Middle
---------------	--------

Peak value:

Frequency (MHz)	Read Level (dBuV)	Antenna Factor (dB/m)	Cable Loss (dB)	Preamp Factor (dB)	Level (dBuV/m)	Limit Line (dBuV/m)	Over Limit (dB)	Polarization
4882.00	36.40	31.85	8.67	32.12	44.80	74.00	-29.20	Vertical
7323.00	31.23	36.37	11.72	31.89	47.43	74.00	-26.57	Vertical
9764.00	30.93	38.35	14.25	31.62	51.91	74.00	-22.09	Vertical
12205.00	*					74.00		Vertical
14646.00	*					74.00		Vertical
4882.00	40.50	31.85	8.67	32.12	48.90	74.00	-25.10	Horizontal
7323.00	32.91	36.37	11.72	31.89	49.11	74.00	-24.89	Horizontal
9764.00	30.27	38.35	14.25	31.62	51.25	74.00	-22.75	Horizontal
12205.00	*					74.00		Horizontal
14646.00	*					74.00		Horizontal

Average value:

Frequency (MHz)	Read Level (dBuV)	Antenna Factor (dB/m)	Cable Loss (dB)	Preamp Factor (dB)	Level (dBuV/m)	Limit Line (dBuV/m)	Over Limit (dB)	Polarization
4882.00	25.40	31.85	8.67	32.12	33.80	54.00	-20.20	Vertical
7323.00	20.02	36.37	11.72	31.89	36.22	54.00	-17.78	Vertical
9764.00	19.16	38.35	14.25	31.62	40.14	54.00	-13.86	Vertical
12205.00	*					54.00		Vertical
14646.00	*					54.00		Vertical
4882.00	29.52	31.85	8.67	32.12	37.92	54.00	-16.08	Horizontal
7323.00	22.14	36.37	11.72	31.89	38.34	54.00	-15.66	Horizontal
9764.00	18.81	38.35	14.25	31.62	39.79	54.00	-14.21	Horizontal
12205.00	*					54.00		Horizontal
14646.00	*					54.00		Horizontal

Remark:

1. *Final Level = Receiver Read level + Antenna Factor + Cable Loss – Preamplifier Factor*
2. *“*”*, means this data is the too weak instrument of signal is unable to test.
3. *The emission levels of other frequencies are very lower than the limit and not show in test report.*

Test channel:	Highest
---------------	---------

Peak value:

Frequency (MHz)	Read Level (dBuV)	Antenna Factor (dB/m)	Cable Loss (dB)	Preamp Factor (dB)	Level (dBuV/m)	Limit Line (dBuV/m)	Over Limit (dB)	Polarization
4960.00	36.90	31.93	8.73	32.16	45.40	74.00	-28.60	Vertical
7440.00	31.56	36.59	11.79	31.78	48.16	74.00	-25.84	Vertical
9920.00	31.23	38.81	14.38	31.88	52.54	74.00	-21.46	Vertical
12400.00	*					74.00		Vertical
14880.00	*					74.00		Vertical
4960.00	41.11	31.93	8.73	32.16	49.61	74.00	-24.39	Horizontal
7440.00	33.28	36.59	11.79	31.78	49.88	74.00	-24.12	Horizontal
9920.00	30.62	38.81	14.38	31.88	51.93	74.00	-22.07	Horizontal
12400.00	*					74.00		Horizontal
14880.00	*					74.00		Horizontal

Average value:

Frequency (MHz)	Read Level (dBuV)	Antenna Factor (dB/m)	Cable Loss (dB)	Preamp Factor (dB)	Level (dBuV/m)	Limit Line (dBuV/m)	Over Limit (dB)	Polarization
4960.00	25.87	31.93	8.73	32.16	34.37	54.00	-19.63	Vertical
7440.00	20.35	36.59	11.79	31.78	36.95	54.00	-17.05	Vertical
9920.00	19.44	38.81	14.38	31.88	40.75	54.00	-13.25	Vertical
12400.00	*					54.00		Vertical
14880.00	*					54.00		Vertical
4960.00	30.06	31.93	8.73	32.16	38.56	54.00	-15.44	Horizontal
7440.00	22.50	36.59	11.79	31.78	39.10	54.00	-14.90	Horizontal
9920.00	19.15	38.81	14.38	31.88	40.46	54.00	-13.54	Horizontal
12400.00	*					54.00		Horizontal
14880.00	*					54.00		Horizontal

Remark:

1. *Final Level = Receiver Read level + Antenna Factor + Cable Loss – Pre-amplifier Factor*
2. *“*” means this data is too weak instrument of signal is unable to test.*
3. *The emission levels of other frequencies are very lower than the limit and not show in test report.*

8 Test Setup Photo

Radiated Emission

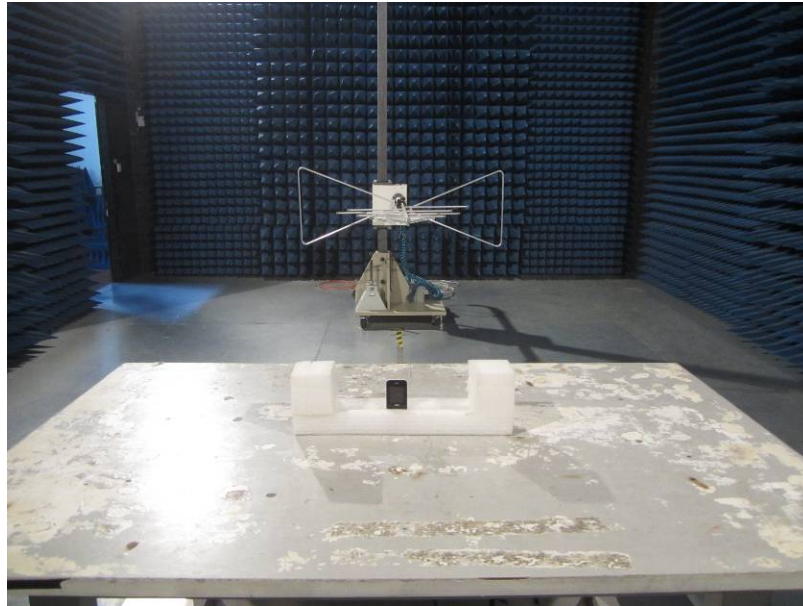

Conducted Emission



9 EUT Constructional Details

Reference to the test report No. GTSE15030032001

-----end-----