

INSTRUCTION MANUAL

DAVINCI

with a Genesis Control



TRUST YOUR KILN
hotkilns.com

Manufactured in Swedesboro, NJ
800-750-8350 • sales@hotkilns.com

INSTRUCTIONS: Davinci REV: 0



DAVINCI INSTRUCTION MANUAL

QUICK START

INSTALLERS

1. If you need to assembly the kiln read the ASSEMBLY section. See hotkilns.com/assemble-davinci-kiln-video
2. If you need to hook up the kiln red the INSTALLATION section. The Wriing diagram is located in the WIRING section.
3. Read the CAUTION section for installation cautions.

USERS

1. Read and understand the CAUTIONS section
2. Read the Operation section. This is all you need to know to operate the kiln.
3. If you want to know more about how to operate the control read the CONTROL section. This is very detailed and can be overwhelming. Use it as a reference and for more sophisticated programming and configuration instructions.
4. For ongoing routine kiln maintenance read the MAINTENANCE section. This is something that the kiln operator is responsible for.
5. For more background information on Ceramics process, Cones, and a Log Sheet see the LOG, CONES, TIPS, CERAMIC PROCESS section.

MAINTAINERS

1. Read the TROUBLESHOOTING section, the WIRING section, the PARTS section and the SERVICE & WARRANTY section.

ADMINISTRATORS

1. See the Safety Data Sheet section if you have any questions about materials used in the kiln.



L&L Kiln's patented hard ceramic element holders protect your kiln.

CAUTION INSTRUCTIONS FOR L&L KILNS

CAUTION INSTRUCTIONS	1
KILNS THESE CAUTIONS APPLIES TO.....	1
RESELLERS ARE NOT AUTHORIZED TO MODIFY THESE CAUTION INSTRUCTIONS.....	1
DATED INFORMATION.....	1
SAFETY NOTICE.....	2
ELECTRICAL SAFETY	2
GENERAL.....	2
ELECTRICAL HAZARDS	2
SHOCK.....	2
ARC-FLASH.....	2
ARC-BLAST.....	2
SAFETY PRINCIPLES	2
INSTALLATION CAUTIONS	3
USE A QUALIFIED ELECTRICIAN.....	3
CLEARANCES AND FLAMMABLE SURFACES.....	3
CHECK TEMPERATURES AROUND KILN.....	3
LEVELING THE KILN.....	3
ADJUSTING THE HINGE PROPERLY.....	3
THERMOCOUPLES.....	4
USE THE SUPPLIED KILN STAND.....	4
DON'T USE AN EXTENSION CORD.....	4
POWER CORD MUST BE PROPERLY RATED.....	4
USE COPPER WIRE FOR HOOK UP.....	4
PROTECT POWER CORD FROM KILN CASE.....	4
KEEP KILN DRY & IN PROTECTED SPACE.....	5
KEEP A FIRE EXTINGUISHER NEAR KILN.....	5
SPRINKLER CAUTIONS.....	5
GENERAL ENVIRONMENT CAUTIONS	5
VENTILATION IS ESSENTIAL.....	5
AMBIENT TEMPERATURES.....	6
SURFACE IS HOT AND CAN CAUSE BURNS.....	6
KEEP CHILDREN/ANIMALS AWAY FROM KILN.....	6
KEEP FLAMMABLES AWAY FROM KILN.....	6
PRACTICE GOOD HYGIENE.....	6
PROPER USE OF KILN WASH.....	6
6. Clean off the old wash and reapply new wash each time you fire or when it begins to chip away.....	6
TRIPPING HAZARDS.....	7
CLOTHING TO AVOID.....	7
PREFIRING CAUTIONS	7
KILN WASH CONTAINS SILICA.....	7
DO NOT USE SILICA SAND.....	7
NEVER FIRE MOIST GREENWARE.....	7
CAUTION WITH USE OF WAX.....	7
DO NOT FIRE TEMPERED GLASS.....	7
STORE SHELVES IN A DRY LOCATION.....	7
DO NOT USE CRACKED SHELVES.....	7
DO NOT FIRE TOXIC, FLAMMABLE, OR UNKNOWN MATERIALS.....	7
LOADING & UNLOADING CAUTIONS	8
TURN OFF POWER WHILE LOADING.....	8
KEEP LID CLOSED WHEN KILN IS NOT IN USE.....	8
DO NOT STORE ANYTHING ON LID.....	8
DO NOT OPEN THE DOOR ABOVE 250° F.....	8
DO NOT UNLOAD KILN WHILE HOT.....	9
BE CAREFUL OF SHARP OBJECTS & GLAZE.....	9
SECURE LID WHILE LOADING OR UNLOADING IF YOU HAVE A SPRING-LOADED EASY-LIFT HINGE.....	9
IF YOU HAVE A DAVINCI COUNTERBALANCED LID.....	9
IF YOU HAVE A BASIC HINGE WITH CHAIN SUPPORTS.....	9
VIEWING INTO THE KILN.....	9
FIRING CAUTIONS	10
ATTEND THE FIRING.....	10
MAKE SURE YOUR KILN SITTER IS ADJUSTED.....	10
USE KILN WASH ON THE CONE SUPPORTS.....	10
UNDERSTAND YOUR CONTROL.....	10
PROGRAM REVIEW ON AUTOMATIC KILNS.....	10
DO NOT CONFUSE CONE NUMBERS.....	10
USE THE PROPER THERMOCOUPLE.....	10
CHECK THERMOCOUPLE CALIBRATION.....	11
SHUT OFF KILN AT DISCONNECT OR CIRCUIT BREAKER.....	11
DO NOT FIRE KILN ABOVE 2350° F (1290° C, Cone 10).....	11
POST FIRING CAUTIONS	11
CHECK FOR GLAZE AND CERAMIC CHIPS.....	11
GENERAL MAINTENANCE CAUTIONS	12
ELECTRICAL SAFETY.....	12
CHECK WIRES & TERMINALS.....	12
CHECK TEMPERATURE OF CORD.....	12
CHECK FOR CORRODED CONNECTIONS.....	12
THE WRONG PARTS CAN BE HAZARDOUS.....	12
VIDEO ABOUT GENERAL MAINTENANCE.....	12
KILN MODIFICATIONS CAUTIONS	13
COATINGS.....	13
OTHER MODIFICATIONS.....	13
DO NOT OVERINSULATE KILN.....	13

CAUTION INSTRUCTIONS

KILNS THESE CAUTIONS APPLIES TO CURRENT PRODUCTION KILNS

- Easy-Fire Kilns (e Series)
- School-Master Kilns (SM Series)
- Jupiter Automatic Kilns (JD Series)
- eQuad-Pro Production Kilns (eQ Series)
- JH Crystalline Kilns (JH Series)
- Easy-Load Front-Loading Kilns (EL Series)
- DaVinci Automatic Kilns (X and T Series)
- Doll/Test Kilns (DL and DLH Series)
- Fuego Kilns

OBSOLETE MODELS

- Easy-Fire XT Kilns (eXT Series)
- Liberty-Belle Kilns (LB Series)
- Jupiter Manual Kilns (J Series)
- Econo Kilns (K Series and J Series)
- Programmatic Kilns (B Series)
- Robin Kilns
- Dyna-Kilns (C & H Series)
- Dyna-Kilns (SQ Series)
- Dura-Fire Kilns (D Series)
- Enameling Kilns (E48, E49, R Series)
- Oval Kilns (OV Series)
- Genesis Kilns (G Series)
- Most other L&L kilns

RESELLERS ARE NOT AUTHORIZED TO MODIFY CAUTION INSTRUCTIONS

Distributors and installers of L&L kilns are not authorized by L&L to make modifications or contradict these Caution Instructions (or our Installation Instructions). If L&L's instructions are not followed, L&L specifically disavows responsibility for any injury or damage that may result.

DATED INFORMATION

The information in these Caution Instructions is believed to be correct to the best of our knowledge at the time of publication (see the date at the bottom of this sheet). You can view the most recent update from our web site at hotkilns.com/cautions at any time.

CAUTION INSTRUCTIONS FOR L&L KILNS

SAFETY NOTICE

1. All cautions and requirements recommended by L&L Kiln Mfg. Inc. are meant to assist users to properly and safely operate their kilns. Many of these cautions apply to kilns and ceramic processes in general. Other process and materials are outside the scope of these Cautions. If you are firing other materials than ceramics there may be issues such as outgassing or explosive hazards that you need to carefully investigate before firing in a kiln.

2. By making use of, and/or downloading from, this web site, user acknowledges that process and manufacturing systems improperly installed, maintained, or operated can pose serious and dangerous threats to worker safety, environmental integrity, and product/process quality.

3. Kilns operate at high temperatures and make use of high voltages/amperages and if improperly installed, maintained, or used, can cause serious personal or property damages.

4. Commercial kilns are provided with various safety, performance, and operating limits, designs and devices which, if disconnected, altered, tampered with, or changed by user, user's employees, user's agents, or others acting on user's behalf or with user's knowledge, will become user's sole risk and responsibility.

5. User also has the sole responsibility for assigning properly trained persons to operate the kilns who have demonstrated common sense and a general aptitude for such work.

6. It is user's sole responsibility to understand and assure adherence to all safety notices and installation, operating, and maintenance instructions provided by L&L Kiln Mfg., Inc.

ELECTRICAL SAFETY

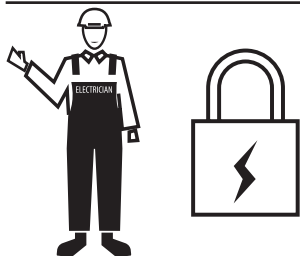

GENERAL

Electricity can be dangerous if not approached carefully. There are three basic hazards that cause injury or death – shock, arc-flash, and arc-blast. It is important to remember that even a small amount of current passing through the

chest can cause death. Most deaths occurring for circuits of less than 600 volts happen when people are working on “hot,” energized equipment – **PLEASE DISCONNECT AND LOCK OUT ALL ELECTRICAL POWER BEFORE ATTEMPTING KILN REPAIRS!**

ELECTRICAL HAZARDS



SHOCK

An electrical shock is a current that passes through the human body. Any electrical current flows through the path of least resistance towards ground; if an external voltage contacts a human body, e.g. by touching a live wire with the hand, the voltage will try to find a ground, and a current will develop that flows through the body's nervous system or vascular system, and exit through the closest part of the body to ground (e.g., the other hand which may be touching a metal pipe.) Nerve shock disrupts the body's normal electrical functions, and can stop the heart or the lungs, or both, causing severe injury or death.

ARC-FLASH

An arc-flash is an extremely high temperature conductive mixture of plasma and gases, which causes very serious burns when it comes into contact with the body, and can ignite flammable clothing. Arc temperatures reach up to 35,000°F – which is 4X the temperature of the sun's surface.

ARC-BLAST

Arc-blast is a pressure wave resulting from arcing, which can carry molten metal fragments and plasma gasses at very high speeds and distances. This can not only carry very hot shrapnel to injure a person, but can actually be strong enough to destroy structures or knock workers off ladders.

SAFETY PRINCIPLES

Be safe! Make sure any equipment that is being installed or serviced is disconnected from all sources of power. In industry, it is important to have 'Lockout and tagout' procedures in place to make sure that power stays

CAUTION INSTRUCTIONS FOR L&L KILNS

disconnected while people are servicing equipment. It is just as important in residential and commercial sites – **DO NOT WORK ON LIVE EQUIPMENT UNLESS ABSOLUTELY NECESSARY!**

Use the right tools for the job – do not improvise. For instance, use a proper fuse puller; don't use a screwdriver to pry out an open fuse.

Protect the person; use proper gloves, shoes, and clothing. In industry it is recommended to wear safety goggles or face shields to prevent arc-flash or arc-blast injuries. Wear rubber soled shoes.

Make sure the environment around the equipment being serviced is safe. For instance, when working around electricity, **it always very dangerous for the floor to be wet.** Make sure there is adequate space to work safely.

Be aware that current flow across your chest can be fatal. If possible, use only one hand to manipulate test leads when conducting any necessary measurements on live equipment. Use a clamp for one lead, and use one hand to guide the other test lead. Keep the other hand as far as possible from the live circuit components.

INSTALLATION CAUTIONS

USE A QUALIFIED ELECTRICIAN

1. Have electrical installation performed by an licensed electrician or other qualified technician.
2. There is danger of electric shock.
3. There is danger that an improperly sized or installed circuit could cause a fire.

CLEARANCES AND FLAMMABLE SURFACES



1. Make certain floor is not flammable.
2. **Install kiln so that the hot surface of the kiln is no closer than 12" (30 cm) to any wall. 18" (46 cm) is preferable.**
3. Be careful about enclosed spaces: In general, it is not a good idea to install a kiln in a small confined space (such as a closet).
4. Maintain a minimum of 36" (91 cm) between the hot surfaces of two adjacent kilns, especially if they are going

to be used at the same time. (The kilns will heat each other).

5. The essential issue with kiln clearance is to keep excessive heat from flammable surfaces. Remember, even when you follow clearance and ventilation recommendations, the kiln is giving off heat. Try not to place the kiln near things that can be affected by elevated temperatures. An example would be an electrical fuse panel which you do not want to overheat.

CHECK TEMPERATURES AROUND KILN

1. Check temperatures around the kiln when it is at high fire to be sure that you are not creating an unsafe condition.
2. Combustible surfaces that stay below 71°C (160°F) are generally considered safe from the point of view of starting a fire.

LEVELING THE KILN

1. Level the kiln while you are installing it.
2. Use thin metal shims under the legs to accomplish the leveling (never wood or other combustible materials).
3. Make sure that the base will not wobble.
4. Leveling is important because the kiln sitter (in older manual kilns) is affected by gravity. If the kiln is not properly leveled the kiln sitter might be either too reactive or too sluggish.
5. You do not want your ware to be unstable in the kiln. It might fall over.
6. If kiln is not leveled this could lead to the cracking of the bottom and the top. In particular, the bottom could easily crack when you first set the weight of the kiln on the bottom while setting up the kiln for the first time.

ADJUSTING THE HINGE PROPERLY

1. See the assembly instructions for your specific kiln. (Assembly instructions are available at hotkilns.com/assembly-instructions)
2. **CAUTION: DO NOT attempt to disengage the spring hinge without first reading the detailed assembly instructions.** The spring is under great pressure and could cause severe injury if it is removed under pressure. **RELIEVE ALL SPRING TENSION BEFORE REMOVING! OPEN LID COMPLETELY!**
3. The hinge of any kiln must be adjusted so that expansion caused by the heating process has room to expand up and down. (L&L includes expansion slots in the hinges.)

CAUTION INSTRUCTIONS FOR L&L KILNS

4. An improperly adjusted hinge can damage the top kiln rim and/or lid by compressing and breaking the brick near the hinge.

5. CAUTION: It is critical that the hinge bar sits in the bottom of slot. This is to allow the lid to rise and fall slightly as the kiln heats and expands without putting stress on the lids connection points and potentially damaging the lid.

IMPORTANT CAUTION:

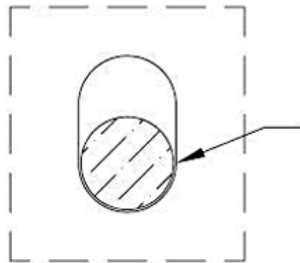

Loosen the screws and adjust the hinge bracket so that the lid lays flat on the top ring and the middle rod rests on the bottom of the elongated holes in the bracket. (As Shown)

THERMOCOUPLES

1. Thermocouples (in automatic kilns) must be inserted into the kiln at least 1" (2.5 cm) in from the inside surface of the kiln.

2. They must protrude into the kiln itself because, if the measuring tip of the thermocouple is buried inside the insulation, the thermocouple will measure a lower temperature than the actual temperature in the kiln.

3. This could cause an overfire of the kiln.

4. Replace thermocouples once they are no longer reasonably accurate. (Note: Type K thermocouples last about the same as kiln elements so it is recommended to change thermocouples when you change elements.)

USE THE SUPPLIED KILN STAND

1. Do not use kiln without the factory supplied stand.

2. Never set a kiln on a floor without significant air space circulating under the kiln.

3. L&L stands typically raise the floor of the kiln by 8" (20 cm).

4. If you have a Rolling Stand do not remove the casters because that will lower the stand to below 8" (20 cm).

5. Using a proper stand is critical because, without a kiln stand that moves the radiant heat of the kiln away from the floor, some flooring could catch on fire. For instance,

over time the radiant heat from the kiln can cause wood to lose its moisture and lower the auto ignition temperature. (The auto ignition temperature is the specific temperature at which a substance ignites and causes a fire.)

DON'T USE AN EXTENSION CORD

1. Never use an extension cord with your kiln. The extra length of the wire could cause the cord to overheat and catch on fire.

2. Extension cords, with their multiple connections and potentially mismatched wire gauge for the load, could cause a fire when used with a continuous resistive load like a kiln.

3. Locate the outlet close enough to the kiln to plug directly into it with the kiln's supplied power cord.

4. Kilns that pull over 48 amps and some three phase kilns generally will not have a power cord. These kilns need to be direct-wired in to the power supply.

POWER CORD MUST BE PROPERLY RATED

1. All L&L power cords are rated for 105°C (221°F).

2. Any cord temperature rating less than 105°C can cause a malfunction and possible fire where the power leads connect to the control box.

3. It is OK, and will not void the warranty, to remove the plug that comes with the kiln and direct wire the kiln. However, the connection wires must be rated for a minimum of 105°C (221°F).

USE COPPER WIRE FOR HOOK UP

1. Do not use aluminum wire on the final connection to the kiln.

2. The specific reason particular to kilns is that the wire tends to get hotter near the kiln than it might going into some other types of appliance.

3. Being a resistive load, there is constant heat being generated by the conductors for quite a few hours. When aluminum wire gets hot it accelerates oxidation. Aluminum oxide is a resistor; copper oxide is not as much. If the connection at the terminal board gets oxidized it will really heat up - to the point where it could cause a fire.

4. Note: Depending on local codes it may be OK to use aluminum wire to your sub panel - as long as that wire is not exceeding its temperature rating while kiln is firing on full power for an extended period of time.

CAUTION INSTRUCTIONS FOR L&L KILNS

PROTECT POWER CORD FROM KILN CASE

1. Route Power Cord (or electrical connection wires) away from kiln in such a way that the wires can not touch the hot case of the kiln.
2. Secure the cord so it can not move.
3. If the cord touches the hot case it could melt and cause a short circuit and/or fire.

KEEP KILN DRY & IN PROTECTED SPACE

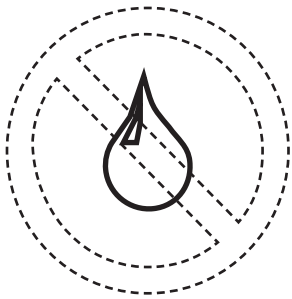

1. The kiln must be kept dry.
2. It is best to keep it in an enclosed room away from inclement weather. See specific details in the INSTALLATION INSTRUCTION section of your instruction manual or on-line at: hotkilns.com/easy-school-install or: hotkilns.com/general-installation-instructions.
3. Note that warranty does not cover damage from corrosion and electrical damage caused by inclement weather.
4. Water in contact with a kiln can cause an electrocution hazard.
5. If you keep a kiln outside (even in a very dry environment) and cover it with a tarp to protect it from rain you could still cause corrosion from the dew that forms on the cold metal surface of the kiln in the morning.

KEEP A FIRE EXTINGUISHER NEAR KILN

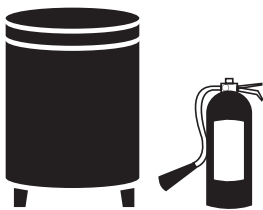

1. Keep an adequate fire extinguisher near the kiln and check it on a regular basis.

2. Check with your local fire authorities to see if there are any specific requirements concerning sprinkler systems, automatic foam extinguishers, etc.

3. Use a fire extinguisher that is rated for electrical fires (ABC rating is recommended).

SPRINKLER CAUTIONS

1. If you have a sprinkler system be careful to check the temperature rating and location of the heads so that you do not inadvertently cause them to actuate under normal firing conditions.



2. Be sure to monitor temperature while the kiln is at its highest firing temperature and conditions are at their worse (for instance when the door to the kiln room is closed or the ventilation fan is turned off). **Serious damage to the kiln and your premises can take place if the sprinkler system goes off when the kiln is at high temperature** - especially if no one is in the building when it happens.

3. See the following web page for guidance on how to calculate ventilation requirements for a kiln room: hotkilns.com/calculate-kiln-room-ventilation

GENERAL ENVIRONMENT CAUTIONS

VENTILATION IS ESSENTIAL

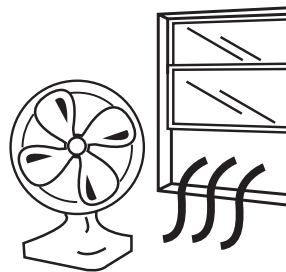

1. Kilns generate harmful fumes when firing ceramics.

CAUTION INSTRUCTIONS FOR L&L KILNS

2. Fumes include carbon monoxide, sulfur oxides, hydrogen fluoride and metal vapors (all of which can be very toxic).
3. Install kiln in well-ventilated area.
4. Never operate in an enclosed space such as a closet unless you have good ventilation in that space. See the following web page for guidance on how to calculate ventilation requirements for a kiln room: hotkilns.com/calculate-kiln-room-ventilation
5. Aside from issues of ventilating the fumes from the firing, the heat build up in an enclosed room could present a significant fire hazard. See the INSTALLATION cautions.
6. Severe corrosion can be caused by kiln fumes, salt air or other environmental conditions.
7. Good venting can minimize these problems.
8. Ventilation must be to the outside.
9. Be careful not to locate the outlet of the vent near an open window.

AMBIENT TEMPERATURES

1. The kiln should operate in an environment that is between -18°C (0°F) and 38°C (100°F).
2. Note that the control, if set up for degrees centigrade, may give you an error code if room temperature drops below 0°C (32°F). The DynaTrol and most other controls do not handle negative numbers.

SURFACE IS HOT AND CAN CAUSE BURNS



1. Kiln surface can be extremely hot: up to 260°C (500°F).
2. You can be severely burned if you touch the hot surface.
3. Display a sign near the kiln that specifically warns everyone of how hot the kiln is.

KEEP CHILDREN/ANIMALS AWAY FROM KILN

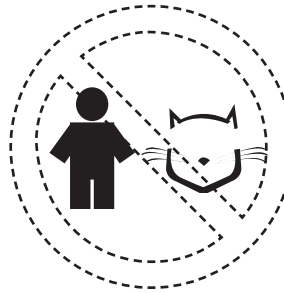

1. Protect any children, animals, and unqualified adults (anyone who is not able to understand these cautions) that may be near the kiln.
2. Aside from fumes that must be ventilated, and flammability concerns, they must be protected from the heat of the kiln and the electrical dangers.
3. Ideally, the kiln should be secured in a space away from any children (especially in a schoolroom situation where children might not always follow safety precautions).

KEEP FLAMMABLES AWAY FROM KILN



1. Do not put sealed containers or combustible materials such as solvents, paper, rags, kerosene, paints, cesium, magnesium, aluminum powder, calcium, sawdust, plastic dust, coal, flour and powdered metal, in or near kiln. An explosion or fire could result.
2. The kiln elements could act as an ignitor of flammable fumes when hot.

PRACTICE GOOD HYGIENE

1. Clay contains silica dust which can be harmful (see silica caution) and some glazes contain heavy metals such as lead, cadmium and copper.
2. While this caution is outside the scope of kiln safety it is worth mentioning here.
3. Keep your room clean and your kiln clean.

PROPER USE OF KILN WASH

1. Make sure the floor of the kiln and the tops of the shelves are coated with kiln wash.

CAUTION INSTRUCTIONS FOR L&L KILNS

2. This will protect these surfaces from melting glaze and ceramics.
3. Do not coat the undersides or sides of the shelves.
4. Do not apply kiln wash to the brick sides or element holders. (Damage to the elements could result).
5. If you have a kiln sitter, put kiln wash on the cone supports (not the sensing rod) for accurate cone action.
6. Clean off the old wash and reapply new wash each time you fire or when it begins to chip away.
7. Be aware of any hazardous warnings on your kiln wash. Most kiln wash contains silica.

TRIPPING HAZARDS

1. Be sure to remove tripping hazards near the kiln.
2. In particular be sure to keep the kiln cord out of traffic areas.

CLOTHING TO AVOID

1. When working around a hot kiln be careful of the kinds of clothes you are wearing.
2. Some clothes could potentially catch on fire if they touch the hot surface of a kiln.
3. Also avoid loose fitting clothes that could catch on the kiln.

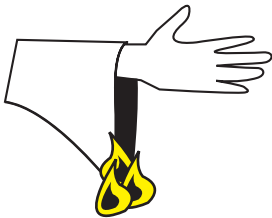

PREFIRING CAUTIONS

KILN WASH CONTAINS SILICA

1. Long term exposure to silica dust could cause lung damage.
2. Exercise proper caution when mixing the dry powder and when removing it from your shelves.
4. Use a NIOSH approved particulate respirator for dust and use proper ventilation. You can buy these from safety supply houses. (NIOSH_approval #TC-21C-132 is an example).
5. L&L does not sell kiln wash but you can obtain it from your ceramic distributor where you buy clay.

DO NOT USE SILICA SAND

1. Do not use silica sand in the kiln.
2. Some people like to use this as a work support medium.
3. The silica sand will attack the elements and thermocouples.
4. It can migrate in the kiln from expansion and movement due to heat.
5. If you must use sand to support or stabilize your load try alumina oxide or zirconia oxide sand.

NEVER FIRE MOIST GREENWARE

1. Never load moist greenware or pots in your kiln.
2. The expanding water vapor in the ware could cause the ware to explode, damaging your kiln interior.
3. We recommend using a dry out segment in your bisque program at 66°C (150°F). (Note that, because of the thermocouple offset programmed into our DynaTrol when we use the ceramic protection tubes, the display temperature will read 93°C (200°F) when the real temperature is 66°C (150°F)).
4. Remember that there may be water trapped in the work even if you can't always see it. If you place a piece of greenware next to your wrist and it feels cool to the touch it probably has too much moisture in it to fire.

CAUTION WITH USE OF WAX

1. When you heat wax (in wax resist and lost wax processes) it will volatilize and potentially condense in the cooler ventilation ducts.
2. Over time this can cause a fire hazard because the wax is flammable.
3. Depending on how the vent motor is mounted, the wax can also gum up the vent motor.
4. If you use these processes it is entirely up to you to engineer and monitor the safety of the installation.
5. The use of wax will void the warranty of the vent system.

DO NOT FIRE TEMPERED GLASS

1. Tempered glass can explode when fired.

STORE SHELVES IN A DRY LOCATION

1. Shelves can absorb moisture.
2. This can cause them to explode when fired. (This is especially true of nitride bonded silicon carbide shelves).

CAUTION INSTRUCTIONS FOR L&L KILNS

DO NOT USE CRACKED SHELVES

1. Cracked shelves can fail in the middle of a firing causing the whole load in your kiln to collapse.

DO NOT FIRE TOXIC, FLAMMABLE, OR UNKNOWN MATERIALS

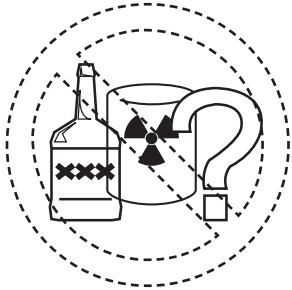

1. Plastics, organic materials, bakeable modeling clay, mothballs and a large variety of materials can decompose under heat causing the release of highly toxic fumes or rapid uncontrollable combustion.
2. Rocks, marbles, cement and other materials may explode under high temperatures.
3. Before firing anything but ceramics, glass and metal (obtained from a known reputable source) in a kiln carefully investigate what happens under heat.
4. This is the sole responsibility of the user.
5. The kiln is not designed to be used for firing hazardous materials. Doing so will void kiln warranty.
6. Adding propane, wood, charcoal or other materials intended to produce a reduction atmosphere can be hazardous if the volume is sufficient. Note that these materials can cause an explosion under certain conditions (just the right amount of air and flammable gasses at just the right temperature) which could cause injury or death. Moreover, a reducing atmosphere can cause premature element failure by reducing the protective oxide coating on the elements. Also note that carbonaceous materials will produce poisonous carbon monoxide and highly flammable hydrogen as they decompose at high temperatures. Also note that the "auto-ignition" temperature of flammable gasses is generally above 1400° F.

LOADING & UNLOADING CAUTIONS

TURN OFF POWER WHILE LOADING



1. Turn off power to the kiln when loading or servicing.
2. If power is on when you are loading or unloading the kiln it is possible to touch the elements and get electrocuted.
3. We recommend having the kiln attached to a fused disconnect switch with a lockout device (in any institutional or industrial installations where someone could turn on the kiln while someone else was working on it).

KEEP LID CLOSED WHEN KILN IS NOT IN USE

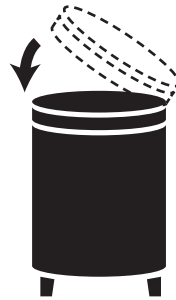

1. Keep lid closed when not operating the kiln.
2. Otherwise the weight of the lid over time may force the hinge and stainless wrap to move down.
3. This will affect the way the lid closes and may cause the lid to crack.
4. It will also keep the kiln cleaner by keeping dust out.
5. In addition, if the kiln somehow gets turned on accidentally, an open kiln could present a fire hazard.

CAUTION INSTRUCTIONS FOR L&L KILNS

DO NOT STORE ANYTHING ON LID

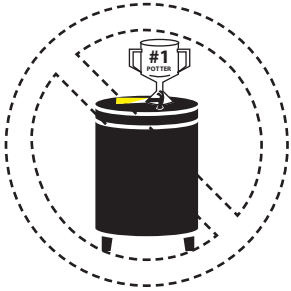

1. Do not use the lid as a storage shelf.
2. The lid could crack.
3. Also - this practice could lead to a fire if you accidentally leave combustible materials on the lid.

DO NOT OPEN THE DOOR ABOVE 250°F

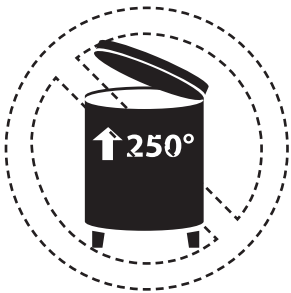

1. Do not open the kiln door until the kiln has cooled down to 250°F (120°C).
2. You could burn your hand on the handle and/or the radiant heat from the kiln.
3. Be careful when you do open the door at this temperature because you can still get burned.
4. Use heat resistant gloves when opening the door. (These are available from L&L).
5. For ventilation purposes, some people fire with the lid slightly propped open 1" to 3" during the beginning phase of the firing (if they do not have a downdraft vent system).
Be aware of the potential dangers of doing this (heat, live electricity, fumes and potentially cracking the lid) and take appropriate measures to protect yourself, the kiln, and the kiln room.

DO NOT UNLOAD KILN WHILE HOT

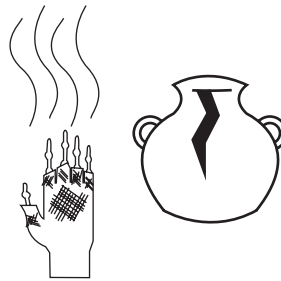

1. You may burn yourself
2. You may harm your work.

BE CAREFUL OF SHARP OBJECTS & GLAZE

1. Stilt marks and other sharp protrusions can cut you.
2. Remember that glaze is like glass.
3. Wear safety glasses while grinding or knocking of stilt marks.
4. Check the shelves for broken bits of glaze which may have attached to the shelves. These can be like shards of glass that can cause a serious cut.

SECURE LID WHILE LOADING OR UNLOADING IF YOU HAVE A SPRING-LOADED EASY-LIFT HINGE

1. Be sure to LOCK THE LID IN PLACE with the spring-loaded plunger pin located on the side of the hinge.

IF YOU HAVE A DAVINCI COUNTERBALANCED LID

1. Be sure to LOCK THE LID IN PLACE with the safety hooks when in the up position.
2. There is one on each side of a DaVinci kiln. Use both chains.

IF YOU HAVE A BASIC HINGE WITH CHAIN SUPPORTS

1. A special safety system is supplied with your Fuego, e18S-3, e18M-3, e18T-3, J18-3, or J18X-3 kiln (and some other older models). This is a door safety chain.
2. It secures the lid in an open position when you are loading or unloading the kiln and ensures that the lid can not accidentally come down on you. You must install and use this for your safety's sake.

CAUTION INSTRUCTIONS FOR L&L KILNS

This drawing shows the safety chain installation and use for the standard older Jupiter hinges.

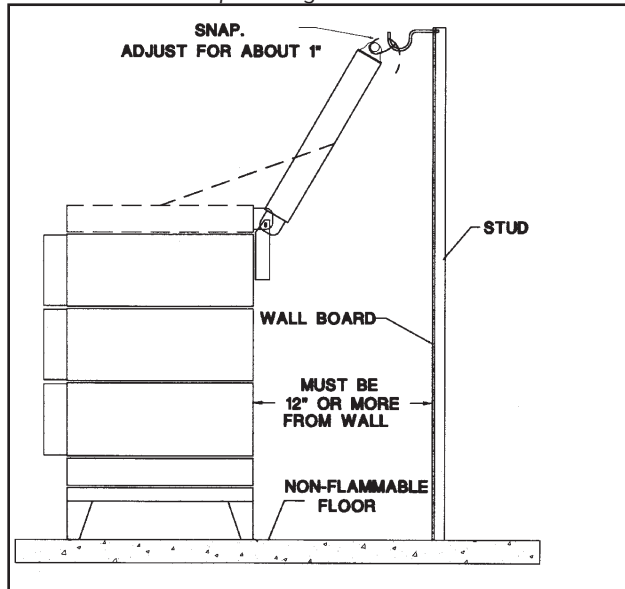

VIEWING INTO THE KILN

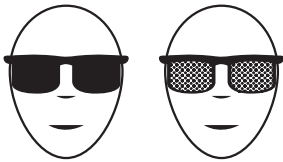

1. Use dark glasses (shade number 1.7 to 3.0) to view inside the kiln through the peepholes when firing. These will protect you from the radiant infrared radiation and will also protect your eyes in case the ceramic ware explodes. Do not use regular sunglasses for this - they are not designed to protect your eyes from this type of radiation.
2. Use heat resistant gloves when opening peephole plugs. They are very hot and can burn you.
3. Do not open the kiln lid unless the kiln is turned off (except for carefully controlled troubleshooting tests). There is danger from electrocution. Cracks caused by propping open the lid are not covered by the warranty.
4. Use heat resistant gloves when opening a hot lid.
5. Do not open the lid when the kiln is above 121°C (250°F).

FIRING CAUTIONS

ATTEND THE FIRING

1. We recommend attending the kiln while firing.
2. **NO AUTOMATIC SAFETY DEVICE IS FOOLPROOF!** Be especially careful about attending the kiln when it is supposed to shut off. (The Delay feature in automatic kilns gives you control over this).
3. If you have a manual kiln with a Kiln Sitter PLEASE BE EXTRA CAREFUL! Kiln sitters can be very unreliable because of the moving parts, dirt or clay that can get into the tube, the way cones are placed on the tube, corrosion, etc. **DO NOT FIRE THIS KILN UNATTENDED WHEN THE KILN IS SUPPOSED TO TURN OFF AND LEARN HOW TO USE THE TIMER BACK UP.** Neither L&L Kiln Mfg., Inc. nor Edward Orton Jr. Ceramic Foundation warranty the kiln or kiln sitter against damage caused by overfiring. **We highly recommend firing all manual kilns with witness cones that you can see through the peephole and/or a pyrometer so you have some idea of what is happening inside the kiln.**
4. The controller is used to control temperature; it is not a safety device.
5. For industrial applications, or for situations where firing high value loads, we recommend the use of a high limit back up control with back up contactors. This available as an option on certain model kilns.

MAKE SURE YOUR KILN SITTER IS ADJUSTED

1. If you have a manual kiln (or the Kiln Sitter backup on an automatic kiln) be sure it is properly adjusted.
2. See the Kiln Sitter instructions.
3. Overfiring could result.
4. Note that the kiln sitter could have gone out of adjustment during shipment. Do NOT assume that it is adjusted when first firing the kiln.
5. The tube assembly should be replaced if gets overly corroded or contaminated with condensed glaze or other materials. Dawson recommended checking the pivot point for corrosion and sluggishness every 6 to 12 months.

USE KILN WASH ON THE CONE SUPPORTS

1. If you have a kiln sitter, put kiln wash on the cone support (but not the sensing rod) for accurate cone action.
2. This will keep the cones from sticking when they bend.

CAUTION INSTRUCTIONS FOR L&L KILNS

POST FIRING CAUTIONS

CHECK FOR GLAZE AND CERAMIC CHIPS

1. Check element holders and walls for glaze, clay chips or anything that could melt at a high temperature.
2. If melted clay or glaze comes in contact with an element, a rapid failure could result. The molten material traps the heat radiating from the element and subsequently raises the surface temperature of the wire. The temperature will quickly pass the maximum recommended temperature for the wire and burn it.
3. To clean holders, a good shop vacuum **with a HEPA filter** will handle dust and loose crumbs. A very gentle chisel or grinder may help with glaze contamination on element holders, but remember that the elements themselves are quite brittle when they are cool.

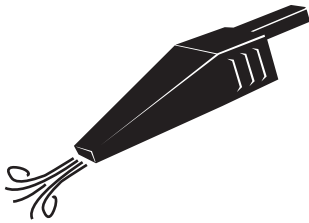

4. Replace the contaminated holder if you can not clean it.
5. Remove any glaze that has splattered on the firebrick or shelves. **(USE SAFETY GLASSES WHEN DOING THIS BECAUSE GLAZE CAN BE LIKE BROKEN GLASS).** Vacuum afterward. Note about vacuuming: it is possible to build up a strong static electricity charge when you are vacuuming. If this somehow manages to discharge into the control it can ruin the electronic circuit. Make sure vacuum is grounded and periodically touch some grounded metal surface away from the kiln to discharge the energy.

GENERAL MAINTENANCE CAUTIONS

ELECTRICAL SAFETY

1. Shut off kiln when servicing it. Use an approved lock out/tag out procedure to make sure that no one servicing the kiln gets injured or killed.
2. **The elements carry high voltage and can electrocute you.** Many of the tests described in the troubleshooting manual are performed under power. They should be done **ONLY** by someone who is familiar with electrical safety such as an electrician or trained maintenance person.
3. As long as the kiln is unplugged or turned off at the fused disconnect switch or circuit breaker (and checked with a reliable meter to be sure) you are safe.
4. **When checking element resistance, disconnect kiln from power by unplugging kiln or turning off at the fused disconnect switch or circuit breaker. Lock out if appropriate.**

CHECK WIRES & TERMINALS

1. Check wires for deterioration or oxidation or burns.
2. Replace any that seem brittle or where the wire insulation has deteriorated, fallen off or burned off.
3. Check terminals for oxidation (discoloration).
4. If you are near salt air or if you notice corrosion on the stainless exterior of the kiln for whatever reason (like certain fumes generated by your work) then do this far more frequently.
5. Check power connection terminals in the kiln and control box for tightness. Be sure to do this with the power disconnected (unplugged) for the kiln. If these terminal connections get loose heat can be generated (because the electrical resistance gets greater) and this can cause a fire.
6. Check thermocouple connections for corrosion, tightness and oxidation as well. A bad thermocouple connection can change the accuracy of the temperature reading which could cause an overfiring.

CHECK TEMPERATURE OF CORD

1. Occasionally check temperatures of the main power cord at the main receptacle and the main kiln breaker while the kiln is at its hottest.
2. If these are hotter than normal, it could be a sign of a loose or corroded connection, or possibly the wire gauge used in the power hook-up is the wrong size for the amount of current being drawn by the kiln.

CAUTION INSTRUCTIONS FOR L&L KILNS

3. Immediately diagnose and fix this because it could cause a fire.
4. Also check temperature of any other cords on the kilns (such as element jumper cords).

CHECK FOR CORRODED CONNECTIONS

1. When replacing infinite zone switches (and other electrical components), replace the electrical connectors.
2. At the very least check for discoloration (an indication of oxidation).
3. Electrical connectors will typically oxidize over time where there is heat and this can cause further overheating of the part at the connection point. This can in turn lead to early failure of the part, wire and connector.
4. Make certain that the new connectors are firmly crimped onto the wire.

THE WRONG PARTS CAN BE HAZARDOUS

1. Non-L&L elements can present a potential hazard to the kiln or cause a fire (by drawing too much amperage).
2. The wrong type of fuse, relay, switch or other component can cause a fire or other hazardous condition.
3. An improperly rated cord can cause a fire.

VIDEO ABOUT GENERAL MAINTENANCE

See this video for some general maintenance tips:
hotkilns.com/maintaining-kiln

KILN MODIFICATIONS CAUTIONS

COATINGS

1. We can not at this time recommend any coatings for the elements.
2. Use of ceramic coatings will void the warranty on the elements and potentially the firebrick or element holders if it contaminates them.
3. Some people have reported success with ITC coating and some people seemed to have caused problems with this coating.
4. We have not adequately tested these coatings so we can only say, at this time, that any trouble that results from the use of ITC and other coatings must be at the risk of the user.
5. We do use a proprietary coating on all our firebrick that improves firebrick life and reduces dusting.

OTHER MODIFICATIONS

1. All customer modification is made solely at the risk of the customer.
2. Modifications will void the warranty.
3. L&L takes no responsibility for hazardous conditions created by unauthorized modifications.
4. Any authorization for an engineering change must be in writing from the factory.

DO NOT OVERINSULATE KILN

1. You may add insulation to the bottom, and to some extent the top.
2. If you put too much insulation on a lid it may weaken because it relies on the cooling of the lid to maintain its structural strength. This could lead to cracking or potentially a collapse of the lid.
3. See the various troubleshooting guides for information about this.
4. However, never wrap insulation around the perimeter of a typical sectional kiln.
5. You could trap heat in the wiring boxes and cause an electrical fire.
6. Also the stainless steel wrap that hold the kiln together will expand and loosen the structure of the kiln.

CAUTION INSTRUCTIONS FOR L&L KILNS

3. We recommend cleaning off the old wash and reapply new wash each time you fire.

UNDERSTAND YOUR CONTROL

1. Become familiar with either the control (if you have an automatic kiln) or the Kiln Sitter (if you have a manual control or have that as your backup control).
2. Do this before operating the kiln.

PROGRAM REVIEW ON AUTOMATIC KILNS

1. Review the current program before firing to ensure the correct profile is programmed.
2. You may pick up an important mistake and save a whole load.
3. Hit **Review Prog** after you have done your programming and the control display will scroll through the program. It only takes a minute or less.

DO NOT CONFUSE CONE NUMBERS

1. Cone ratings are not intuitive. Cones with an "0" in front of them (like cone 05) are lower in temperature rating and the higher the number the lower the temperature rating. On the other hand cones with no "0" in front (like Cone 5) raise in temperature as the number gets higher.
2. For instance, Cone 05 is a much lower temperature than Cone 5 for instance. If you fire Cone 05 clay to Cone 5 you could cause a serious overfiring of the material which could melt in your kiln and cause severe damage to the kiln interior.
3. See the Orton cone chart. (hotkilns.com/orton-cone-chart)

USE THE PROPER THERMOCOUPLE

1. Never use a different type of thermocouple with your controller unless it has been set up from the factory (or unless you carefully go through the process of changing from one type to another).
2. For instance if you used a Type S thermocouple on a control set up for Type K you would overfire your kiln.
3. On some controls (like the newer DynaTrols) it is possible to change thermocouple types. However, this involves both a programming change and a jumper change on the control. It also requires you to change out all the thermocouple lead wire to properly calibrated wire for the new thermocouple type. (See: hotkilns.com/change-thermocouple-type)

CHECK THERMOCOUPLE CALIBRATION

1. Thermocouples will drift in reading over time.
2. This could potentially lead to an overfiring before the thermocouple actually fails.
3. Although you can not easily check thermocouple calibration, the general accuracy of the entire kiln system can be checked by firing with witness cones. See the LOG, CONES & CERAMIC FIRING section or hotkilns.com/troubleshooting-cones. Also see this video: hotkilns.com/firing-kiln-witness-cones.

4. L&L recommends changing your Type K thermocouples when you change your elements.

SHUT OFF KILN AT DISCONNECT OR CIRCUIT BREAKER

1. It is possible for electrical contacts on contactor relays to fuse together.
2. If this happens power will continue to flow to the elements and your kilns could overfire even though everything on the kiln is shut off.
3. You should turn kiln off from the circuit breaker or fused disconnect switch after turning off the kiln itself.

DO NOT FIRE KILN ABOVE 2350°F (1290°C, Cone 10)

1. Most L&L kilns are rated for use to 2350°F (1290°C, Cone 10).
2. The rating of the kiln is listed on its data nameplate normally affixed to the control panel.
3. **DO NOT FIRE ANY HIGHER THAN THIS** or hold for extended periods of time at those temperatures.
4. The elements, element holders and firebrick could melt.

DAVINCI INSTRUCTION MANUAL

OPERATION



L&L Kiln's patented hard ceramic element holders protect your kiln.

FIRST FIRING FOR L&L KILNS WITH A DYNATROL OR GENESIS

WHEN TO DO A FIRST TEST FIRING?

Once your kiln is set up, leveled properly (very important), control panel hooked up to the kiln correctly, and all the power wired properly, you are ready for your first firing. Read these instructions and plan your time accordingly.

VIDEO ON HOW TO PROGRAM

See this video for help in programming your DynaTrol for the first firing:

hotkilns.com/programming-first-firing

WHY DO A TEST FIRING?

The test firing is done very slowly, about 16 to 19 hours total to minimize the inner and outer surface temperature differences in the kiln while it goes through its maiden firing. Also this will slowly steam off any moisture absorbed by the firebrick during construction, shipping, and storage.

The test firing is done to cone 5 (about 2167°F) to vitrify the special coating on the inside on the firebrick and to allow an "aluminum oxide" coating to form on the element's surfaces.

The coating on the top and bottom helps to strengthen the surface of the firebrick, and helps prevent dusting in the kiln.

The oxide layer on the elements helps to protect them from the many contaminants found in many materials fired in a kiln. This aluminum oxide layer will rejuvenate itself every time there is an oxygen rich firing to a high temperature. Going to cone 5 may also point out any problems with your electrical service - like low or incorrect voltage or wrong supply line wire size.

The elements will also seat themselves in the ceramic holders - and any springiness you see when you first get your kiln will be alleviated. **But be sure that no segment of the elements are hanging out of the holders** - they should all be seated as much as possible in the holders.

NOTE: Normally bisquing is done to cone 05. Do not be confused by how the test firing uses **SLOW BISQUE** to cone 5, even though normally you would use a **SLOW BISQUE** to cone 05. The Slow Bisque program is used for the test firing BECAUSE it is a long program. We want this to be slow.

The test firing is done with the operator present as much as possible, but especially above 1500 degrees F (and definitely for the end of the firing). This is to be sure the

kiln is heating up safely, shuts off when it's supposed to, and that the heating kiln affects nothing else in the room or the room itself. As for the operator being present, this may be difficult as the test fire is designed to take about 16 to 19 hours.

To deal with this a "Delayed Start" can be added to the test fire program, allowing you to press **START** at say 5PM, the kiln to start at say 8PM in order to turn off at 3PM the following day while you are there. More detail on this a little further on. You can also split it into two firings (see instructions at the end of this sheet).

NOTE: We highly recommend including kiln furniture in the first firing because firing an empty kiln can sometimes lead to an error code (E-D) on multi-zone kilns. The shelves may be newly coated with kiln wash. Anything else in the kiln (clay) will produce contaminants, and the elements in the kiln have not yet achieved the all-important aluminum oxide coating before being subjected to these contaminants.

VENTING

Leave the Vent-Sure downdraft vent system on while the kiln is heating and cooling. Keep the peephole plugs in and the lid closed. If you have no vent system then leave the top peephole plug out during the first test firing.

NOTE: it is best for the evenness and speed of the firing to keep all the peepholes closed. However, for longevity of things like the elements, and thermocouples, as well as for better colors in clays and glazes, it is best to have as much air as possible moving through the kiln, without compromising the speed and evenness of the firing (this is a trade-off). Open peepholes can be an OK way to vent, except that uneven drafts through the kiln can affect thermocouple readings, or "freeze" cones, leading to uneven or slow firings.

WHAT TO EXPECT

ELEMENT SMOKING

Brand new elements may have lubricant still on them and may smoke a little initially the first time they are heated. A fan in a window is more than adequate to deal with

FIRST FIRING FOR L&L KILNS WITH A DYNATROL OR GENESIS

this. If you have the Vent-Sure vent on this should also be adequate.

NOISES IN AN AUTOMATIC KILN

A **Beep** when you press a button on the DynaTrol keypad.

Clicking noises from inside the control box as the unit heats. This will happen throughout the firing until it shuts off. Sometimes it will happen more frequently than other times. It is the result of the relays opening and closing as the control tells them to, turning the electricity on or off to the elements, working to heat the kiln evenly. (On manual kilns with contactors you will also hear contactors clicking).

Hum. Whenever kiln elements come on they are accompanied by a humming sound from electricity in the elements. This is normal. The natural properties of electricity and the dynamics of the shape of the element combine to create a slight vibration in the element.

WHAT HAPPENS AS THE KILN HEATS UP

All the materials used in the kiln's construction expand incrementally as they are heated. First the inside materials- i.e. the elements, holders, and inside surfaces of the walls, floor, and lid heat and expand slightly. Then, the heat moves slowly through the walls, lid and floor until it begins to heat the outer surface of the kiln. The greater the difference in temperature is between the inside surface vs. outside surface, the more stress there is on the material itself.

Walls, lids and floors can sometimes develop hairline-cracks on the surface or in the some cases, all the way through. Really this is normal and to be expected sooner or later to some degree. If you tighten the stainless steel bands that surround the floor, lid, and walls of the kiln every so often, the fact that the firebrick expands as it heats will mean that the cracks are actually closing up while the kiln is heating, expanding against the cooler outer shell. The geometry of the kiln and the tightness of the stainless steel bands are what holds everything together, whether the brick is in a few pieces or all one piece should not matter a whole lot, although cracked floors should be fully supported as they are with our full-support stands.

See the [maintain.pdf](#) and [troubleshoot-brick.pdf](#) for more information. See this for how to repair hairline cracks: hotkilns.com/repairing-hairline-cracks-firebrick-video).

VISIBLE RED HEAT

Another thing to expect is to see the "red heat" through the seams, between the sections of the kiln, beginning around 1000°F. This is normal. The seam between the lid and the top section will probably appear the largest. This is

partly because, when the top heats up, it becomes slightly concave and the edge lifts up.

IMPORTANT NOTE: It is important for this gap between the lid and the rest of the kiln to be even all the way around throughout the firing. If it is more open in the front when hot, then the hinge is out of adjustment and must be raised up. Your kiln's Assembly instructions detail the hinge adjustment. The danger of this condition is that all the weight of the lid is now resting on the inner upper edge of the back firebricks on the top section. They will crack off in a firing or so and probably damage the lid too.

CAUTION: The outer metal and brick surfaces of the kiln will get very hot, as hot as 450°F - easily hot enough to burn you.

The interior of the kiln will look white hot at the highest temperatures.

CAUTION: Be sure to always use rated dark safety glasses when looking through the peepholes to protect your eyes from infrared radiation. See **Kiln Cautions** for details.

CONTROL DISPLAY ON DYNATROL

Acronyms on the DynaTrol's display screen stand for important messages, they are its way of communicating with the user. The DynaTrol display is limited to four letters or numbers at a time. So for example, **TCOS** is the acronym the DynaTrol uses for "thermocouple offset".

Once it hits its target temperature, it will shut off with a **CPLT** (complete) message. Once this message is seen the kiln is no longer running. It is safe to shut off the power to it. If no controlled cool-down was programmed, the kiln will cool quickly at first, then more and more slowly. As it is cooling it will display the **CPLT**, the **amount of time it took to complete the firing**, the **TC2**, and the **current temperature** over and over again.

The temperature will normally be displayed from **TC2**, which is thermocouple number two. Press **1** to see the temperature in the top section- **TC1**. Press **3** to see the temperature in the bottom section of a three or more section kiln. The DynaTrol is checking all three thermocouples every eight seconds even though just one thermocouple's temperature is displayed. The displayed temperature will rise as the kiln heats up, cycling from **TC2** to current temperature inside the kiln over and over again. (A kiln with just one thermocouple will just show the temperature reading, no **TC number**).

FIRST FIRING FOR L&L KILNS WITH A DYNATROL OR GENESIS

DYNATROL CONTROL: STEP BY STEP

- 1) Turn on power to the kiln with the toggle switch. Display reads **WAIT** then **IDLE**.
- 2) Press **ENTER** and wait until you see **IDLE**, **TC2**, and the **current temperature** cycling over and over again.
- 3) Press **SLOW BISQUE** and see **S-bC**.
- 4) Press **ENTER** and see **CONE**, and a number (which represents the cone number currently programmed in the control) flashing back and forth.
- 5) Press **5**, and see the number **5** in the display. .
- 6) Press **ENTER** and see **HLd**, **00.00** flashing back and forth.
- 7) Press **ENTER** and see **IDLE**, **TC2**, and the **current temperature** cycling over and over.
- 8) Press the **Preheat** button in the **Easy-Fire Options** section.
- 9) See **HLd**, **00.00** flashing back and forth.
- 10) Press **300** so the display reads **3.00**.
- 11) Press **ENTER** and see **IDLE**.
- 12) Press **START/STOP** to begin the test firing.

You have just entered an "Easy-Fire Slow Bisque" Program to cone 5 with a three hour preheat, the combined total of which will take roughly 16-19 hours. The preheat part increases the heat in the kiln at 60°F per hour from room temperature up to 200°F where the hold time comes on, the timer appears, and it holds at 200F for the set amount of time. Once the timer runs out, the rest of the program follows.

Now you must figure out how to be around for the end of the 16-19 hour firing. This is where the Delay Start feature may come in handy. It is a digital hours and minutes timer you can add to the beginning of any program. You tell the timer how many hours and minutes to count down before the DynaTrol turns up the kiln and runs the rest of the program.

NOTE: It is critical for someone to be present for, and especially at the end of, each firing. This is particularly true for this first firing. Even if you have a high limit control - no safety device is entirely foolproof.

DO YOU NEED A DELAYED START?

Picture a clock-face and count forward 16 hours from when you planned to press **START/STOP** to begin this program. Will you be present for at least the last few hours? If "YES" then you do not need a delayed start time and you can start the firing when you planned to, skip the rest of step 6 and step 7. If "NO" then you do need a delayed start time, continue on here.

CALCULATING THE DELAY START

Picture the same clock-face, and see when the firing would have ended if you had pressed **START/STOP** when you planned (i.e. 16 hours from when you want the firing to begin). Now picture how many hours later the firing would have to end, in order to have someone there for the last few hours of this 16-19-hour firing. That "number of hours later" is what to program in for the **Delay Start**.

An example

You are planning to start the program at 7 pm. Your program is going to take minimum 16 hours. 16 hours from 7 pm is 11 am the following day. You plan to get into the kiln room at 9 am. 9 am to 11 am is only two hours. You would need to get there one hour earlier to be there for the last three hours, OR start the program one hour later than 7 pm so that the program completes at 12 pm the following day. You will need to program a one hour delayed start. First you will enter the program, then the preheat, then the delayed start. You will press **START/STOP** at 7 pm, but now a timer will appear and count down the one hour before the rest of the program begins.

ADDING A DELAYED START

- 1) Press **DELAY** and see **dELA**, **0.00** flashing over and over.
- 2) Enter the number of hours and minutes to delay the start for. For example: For a two hour delay press **2, 0, 0** so it says **2.00**. For a 1 hour and thirty minute delay press **1, 3, 0** so it says **01.30**. Numbers in the display to the right of the decimal represent minutes. Numbers to the left of the decimal represent hours.
- 3) When the correct number of hours and minutes has been keyed in, press **ENTER**, see **IDLE**

START FIRING

When the correct time to begin the firing arrives, press **START/STOP**. The display will say **-ON-**, then it will cycle through a sequence showing **TC2**, and the **current temperature** in the kiln over and over as it heats. Here is what to expect the kiln will do based on what you have programmed, after you press **START/STOP**.

FIRST FIRING FOR L&L KILNS WITH A DYNATROL OR GENESIS

If you programmed a delayed start, there will be an hours and minutes timer displayed along with the **TC2, current temperature** message. It will be displayed until the timer runs out.

It will climb at about 60°F per hour until it reaches 200°F, then the timer will appear again and the three hour preheat will begin counting down on the display with the **TC2, current temperature** message. It will sit around 200°F until the timer runs out.

Now it will begin to climb at about 80°F per hour up to 250°F

Once the hottest thermocouple reading reaches 250°F, the kiln will begin climbing at 200°F per hour until it reaches 1000°F

Once the hottest thermocouple reading reaches 1000°F, the kiln will begin climbing at 100°F per hour until it reaches 1100°F

Once the hottest thermocouple reading reaches 1100F, the kiln will begin climbing at 180°F per hour until it reaches 1915°F

Once the hottest thermocouple reading reaches 1915°F, the kiln will begin climbing at 80°F per hour until it reaches somewhere between 2100-2190°F

Once the hottest thermocouple reading reaches around 2165°F, the kiln display will say **CPL T**, a time like **17.47**, the **TC2**, and the current temperature in the kiln as it is cooling.

Once **CPL T** is seen the firing is complete. We recommend shutting all power to the kiln off.

You can also leave the display on with the current messages cycling over and over, or you can press **START/STOP** to get back to **IdLE, TC2, current temperature** and leave it there.

NOTE: If the first firing ended in an error code please make note of which one it was; i.e. **E-1** or **E-d** etc. See this first:

hotkilns.com/list-all-error-codes-dynatrol

GENESIS CONTROL

Refer to the instructions in the Genesis Control Manual on page 5 and 6. However instead of firing to Cone 04 fire the kiln to Cone 5 on a Slow speed.

Now you must figure out how to be around for the end of the 16-19 hour firing. This is where the Delay Start feature may come in handy. It is a digital hours and minutes timer you can add to the beginning of any program. You tell the timer how many hours and minutes to count down before the DynaTrol turns up the kiln and runs the rest of the program.

NOTE: It is critical for someone to be present for, and especially at the end of, each firing. This is particularly true for this first firing. Even if you have a High Limit Back-up - no safety device is entirely foolproof.

DO YOU NEED A DELAYED START?

Picture a clock-face and count forward 16 hours from when you planned to press **STRT** to begin this program. Will you be present for at least the last few hours? If "YES" then you do not need a delayed start time and you can start the firing when you planned to, skip the rest of step 6 and step 7. If "NO" then you do need a delayed start time, continue on here.

CALCULATING THE DELAY START

Picture the same clock-face, and see when the firing would have ended if you had pressed **START/STOP** when you planned (i.e. 16 hours from when you want the firing to begin). Now picture how many hours later the firing would have to end, in order to have someone there for the last few hours of this 16-19-hour firing. That "number of hours later" is what to program in for the **Delay Start**.

An example

You are planning to start the program at 7 pm. Your program is going to take minimum 16 hours. 16 hours from 7 pm is 11 am the following day. You plan to get into the kiln room at 9 am. 9 am to 11 am is only two hours. You would need to get there one hour earlier to be there for the last three hours, OR start the program one hour later than 7 pm so that the program completes at 12 pm the following day. You will need to program a one hour delayed start. First you will enter the program, then the preheat, then the delayed start. You will press **START/STOP** at 7 pm, but now a timer will appear and count down the one hour before the rest of the program begins.

FIRST FIRING FOR L&L KILNS WITH A DYNATROL OR GENESIS

ADDING A DELAYED START

- 1) Press **DELAY** and see dELA, 0.00 flashing over and over.
- 2) Enter the number of hours and minutes to delay the start for. For example: For a two hour delay press **2, 0, 0** so it says **2.00**. For a 1 hour and thirty minute delay press **1, 3, 0** so it says **01.30**. Numbers in the display to the right of the decimal represent minutes. Numbers to the left of the decimal represent hours.
- 3) When the correct number of hours and minutes has been keyed in, press **ENTER**, see **IDLE**

START FIRING

When the correct time to begin the firing arrives, press **START/STOP**. The display will say -0N-, then it will cycle through a sequence showing TC2, and the **current temperature** in the kiln over and over as it heats. Here is what to expect the kiln will do based on what you have programmed, after you press **START/STOP**.

If you programmed a delayed start, there will be an hours and minutes timer displayed along with the TC2, **current temperature** message. It will be displayed until the timer runs out.

It will climb at about 60°F per hour until it reaches 200°F, then the timer will appear again and the three hour preheat will begin counting down on the display with the TC2, **current temperature** message. It will sit around 200°F until the timer runs out.

Now it will begin to climb at about 80°F per hour up to 250°F

Once the hottest thermocouple reading reaches 250°F, the kiln will begin climbing at 200°F per hour until it reaches 1000°F

Once the hottest thermocouple reading reaches 1000°F, the kiln will begin climbing at 100°F per hour until it reaches 1100°F

Once the hottest thermocouple reading reaches 1100F, the kiln will begin climbing at 180°F per hour until it reaches 1915°F

Once the hottest thermocouple reading reaches 1915°F, the kiln will begin climbing at 80°F per hour until it reaches somewhere between 2100-2190°F

Once the hottest thermocouple reading reaches around 2165°F, the kiln display will say CPLT, a time like 17.47, the **TC2**, and the **current temperature** in the kiln as it is cooling.

Once CPLT is seen the firing is complete. We recommend shutting all power to the kiln off.

You can also leave the display on with the current messages cycling over and over, or you can press **START/STOP** to get back to IdLE, TC2, **current temperature** and leave it there.

SPLITTING TEST FIRING INTO TWO FIRINGS

This is done by entering in the standard program for the test fire on Day 1, first thing in the morning. Turn this on as early on Day 1 as possible and let it run all day until you go home in the afternoon. Before you go home Press **START/STOP**, then turn off the kiln.

On day 2, first thing in the morning, program in a **SLOW GLAZE** to cone 5, no hold or preheat is necessary. Regardless of how hot it still may be in the kiln, turn this program on as early as possible in the morning on Day 2. It will run up to somewhere between 2100°F and 2190°F in about 7-8 hours. If it is still not done when you go home, as long as 8 hours have passed since you turned it on, you can press **START/STOP** and turn the toggle switch off and go home. Otherwise when it is done it will give the CPLT message and it is then safe to Press **START/STOP**, turn the toggle switch off and go home.

FREQUENTLY ASKED QUESTIONS

There are ceramic washers in between the elements and the element holders in the corners of my kiln - what are these for?

1. This is done on some kilns - particularly DaVinci kilns. The discs are placed in the element holders to keep the elements from coming out during shipment.
2. It is a good idea to keep them in place during at least the first firing.
3. Once the elements heat up they will seat themselves in the element holders properly and they can be removed.

Can you fire to a higher cone than cone 5 on the first firing?

The Cone 5 temperature target is somewhat arbitrary. We want to accomplish three things with the first firing:

1. Fuse the hardening coating we apply to the surface of the tops and bottoms
2. Seat the elements in the holders
3. Put an initial oxide coating on the elements (which protects them from contaminants in the atmosphere form clay and glazes). A higher temperature is not a problem.

DAVINCI INSTRUCTION MANUAL

CONTROL



L&L Kiln's patented hard ceramic element holders protect your kiln.

BASIC OPERATION OF L&L KILNS WITH A DYNATROL 700

Press the **START/STOP** Button to start firing the program you have selected. You can also stop a program from firing.

The **Vary-Fire** section is for advanced users.

Press **Review Prog** to see what program you are running and to make sure you have entered the proper cone number.

Review Seg allows you see what segment of the program you are on.

The **Other** section is for entering options such as cone offsets, thermocouple offsets, etc.

Delay allows you to enter a countdown time to start the program automatically.



The display area provides lots of information such as temperatures, program prompts, etc.

Enter the cone number and other numeric information like delay time using the number keypad.

Choose one of the four Easy-Fire programs. The control will prompt you for cone number and hold time.

Preheat allows you to enter a set time for the kiln to fire at 150°F to dry out your work

Alarm sounds an audible signal at whatever temperature you set. The normal setting of 9999 means it will not go off. Hit **ENTER** to turn off buzzer.

INSTRUCTIONS

DOWNLOAD PDF

Scan QR or visit:

hotkilns.com/support/pdfs/basic-operation-ll-kilns-dynatrol-700





TRUST YOUR KILN

L&L Kiln Mfg. Inc. ♦ 505 Sharptown Rd.♦ Swedesboro, NJ 08085

Phone: 856.294.0077 ♦ Fax: 856.294.0070 ♦ Email: sales@hotkilns.com ♦ Web: hotkilns.com

BEFORE YOU BEGIN USING THE GENESIS CONTROL

1. Watch all videos on the Genesis control at :
<https://hotkilns.com/support/videos> in the “Genesis Control” category.
2. Look through the Genesis instruction manual.
3. Get familiar with the control by using the menus.
4. Set up WiFi (see “Setting Up WIFI on the Genesis Control” video on the above link).
5. **Update to the latest firmware.** This changes from time to time with no set schedule. We have found that issues that customers have are fixed by new software updates: Menu > Configuration > Communications > Update Firmware.

Tips:

In case you need to get into the Factory Configuration menu (to change the number of zones for instance, or to change offset) use the code: 443

When updating firmware, you may get a blank screen due to a weak signal. Simply go back, reconnect to WiFi and select Update Firmware again. This may happen more than once, depending on your WiFi strength.

You may get a pop-up that says “Latest Firmware is Already Installed.” You can then select cancel to skip redownloading the same update.

Operation Manual

Genesis Model LT3140 Controller

Genesis 2.0

BARTLETT

—INSTRUMENT COMPANY—

1032 Avenue H
Fort Madison, IA 52627

319-372-8366

www.bartinst.com

Table of Contents

Introduction	2
Precautions	2
Home Screen Overview.....	3
Quick Start.....	4
First Firing of the Kiln	5
Ceramics Programming (Bisc or Glaze)	5
Glass Programming	7
Custom Programming	9
Calculating Ramp Rates for Custom Firing.....	11
Custom Ceramics Program.....	11
Start A Firing.....	11
Operation of the Controller During A Firing	12
Adjustments During a Firing.....	14
End of Firing – COMPLETE.....	15
Care of Thermocouple	15
Menu Screen	15
Data Menu	16
Diagnostics	16
Adjustments	17
Configuration	18
Restore Presets	20
Customization	21
Factory Configuration	21
Appendix A: Error Codes	22
Full Power Test.....	23
Appendix B: Cone Fire Temperature Profiles.....	24
Appendix C: Custom Firing Default Programs.....	25
Appendix D: Blank Firing Program	28
Appendix E: Common Questions and Situations	29
Appendix F: Zone Control	30
1. Features and Enhancements.....	30
2. General Description	30
3. Automatic Lag Function	30
4. Thermocouple Offsets.....	30
5. Three Thermocouples.....	31
Appendix G: Genesis Connection Diagram	32
Appendix H: Genesis Mini Connection Diagram	33

Introduction

This manual covers the operation of the Genesis 3140 & Genesis 1120 kiln controllers. The Genesis is a versatile touch screen controller that regulates the temperature in your kiln so you can fire a variety of products like ceramics, glass, jewelry, and more. The Genesis has preset ceramic programs with cone fire programming, preset glass firing profiles, and 30 custom programs, along with Wi-Fi capabilities for software updating, built in diagnostics, and maintenance logging among other new features.

Precautions

- The controller is used to control temperature; it is not a safety device.
- Do not operate the controller in temperatures above 160° F.
- Always supervise your kiln during a firing.
- The controller contains electronic components which are sensitive to static electricity. Before handling the controller dissipate any static charge you may have by touching metal or a screw on the controller panel, the electrical box, the kiln lid, or some other grounded object.
- Always check the position of the thermocouple probe before starting a firing. The current temperature displayed on the controller is measured at the end of the thermocouple which must be in the firing chamber about 1" to 1-1/2". Seal the opening around the thermocouple with kaowool or similar material if necessary.
- Always review the current program before firing to ensure the correct profile is programmed.
- Ensure the kiln and the areas around the kiln are clear of combustible material. See kiln manufacturer's recommendation on required clearances.

Home Screen Overview

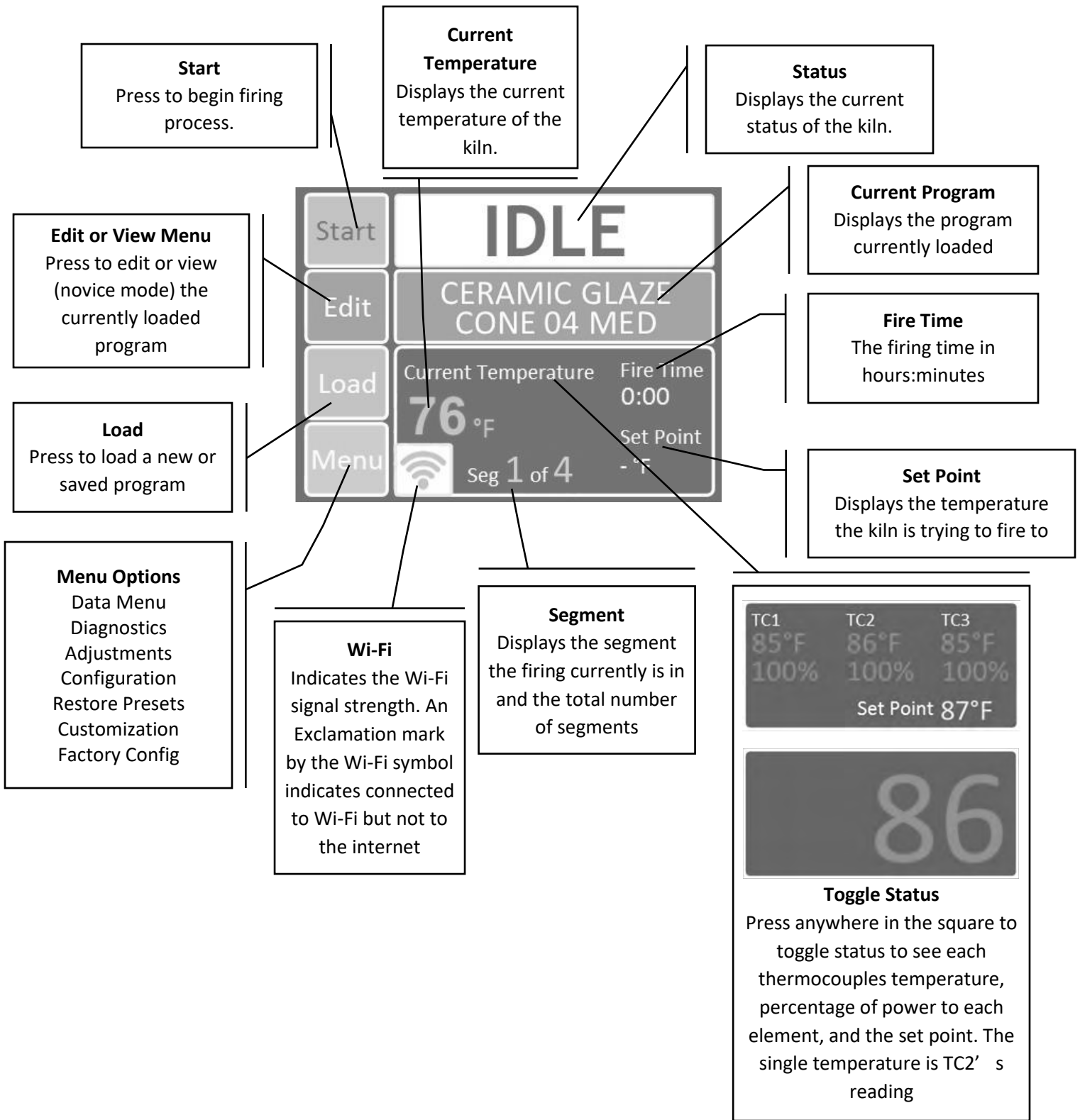

Figure 1: Home Screen Overview

Quick Start

Step 1: Load A Program (See Pages 7-13)

- Press the **Load** button.
- Select the type of program.
 - Ceramic (Bisc or Glaze)
 - Glass
 - Custom

Step 2: Review or Edit the Program (See Pages 7-13)

- Press the **Edit** or **View** button.
- Review and confirm the program selection.

Step 3: Start the Firing (See Page 13)

- Press the **Start** button.
- Enter the start code.
- Press **Start**.

First Firing of the Kiln

The purpose of the first firing is to put a protective oxide layer on the elements and thermocouple. The first firing is done without ware in the kiln that might give off fumes that contaminate the elements. Fire to Cone 5 with a Slow Speed.

Ceramics Programming (Bisc or Glaze)

Programming in Novice mode is the easiest method to program the controller to fire ceramics. Programming consists of choosing a cone number, firing speed, and a preheat time. The firing speed is chosen by the type of firing and thickness of the clay used. All 4 speeds below will calculate the firing rate at the end of a firing and adjust the final temperature for correct heat-work.

Ceramics Programming – Novice Mode ON:

Step	Display Shows	Key Press	What This Selection Means
1	Home Screen	Load	You're ready to load a different program into the controller memory.
2	What are you firing?	Ceramics	Choose from Ceramics, Glass, and Other. Choose Ceramics for a bisc or glaze firing.
3	Cone Number XX Temperature XXXX	Next	Use the scroll bar to choose the desired cone number for the firing. Remember, cone numbers starting with a 0 are a lower temperature than cone numbers not starting with a 0. For example, don't mistake a cone 6 for a cone 06!
4	What speed?		Choose the firing speed either Fast, Medium, MedSlo, or Slow.
		Fast	Fast is the fastest firing speed and is used for glaze firings on thin ware, china paint firings, and decal firings. Firing times range from 4 to 5 hours.
		Or Medium	Medium is used for firing glaze on thicker ware or for bisque firing very thin ware. Typical firing time is 6-8 hours depending on the cone number.
		Or MedSlo	MedSlo is used to bisque medium pieces or thinner ware that requires less time for water smoking and carbon burn-out. Typical firing time is 9-11 hours, depending on cone number.
		Or Slow	Slow is used to bisc thicker, hand thrown ware. The slow speed gives extra time for release of water and carbon burn-out. Typical firing times range from 13-17 hours depending on the cone number. Hand built pieces may need a preheat stage.
5	Preheat Time?		Choose the preheat time, either None, 4 Hr, 8 Hr, or 12 Hr.
		None	No preheat time is needed when the pieces are a thin, bone dry bisc or glaze.
		Or 4 Hr	Use a 4 hour preheat time for thicker, slightly wet pieces.

		Or 8 Hr	Use an 8 hour preheat time for thick, wet pieces.
		Or 12 Hr	Use a 12 hour preheat time for hand built, kids pieces.
6	Program Loaded:	OK	Return to Home Screen at IDLE.

Ceramics Programming - Novice Mode Off:

Step	Display Shows	Key Press	What This Selection Means
1	Home Screen	Load	You're ready to load a different program into the controller memory.
2	Load Program		Choose between 1-Bisc, 2-Glaze, 3-Glass, or 4-Custom
		1-Bisc	The default bisc program will be loaded to the controller. Any saved changes made to the bisc program will overwrite the default program.
		Or 2-Glaze	The default glaze program will be loaded to the controller. Any saved changes made to the glaze program will overwrite the default program.
3	Program Loaded:	OK	Returns to Home Screen. To make changes to the loaded program, go into the edit menu.
4	Home Screen	Edit	Displays the current settings for the firing. To change the settings, press the setting to be changed and select the new

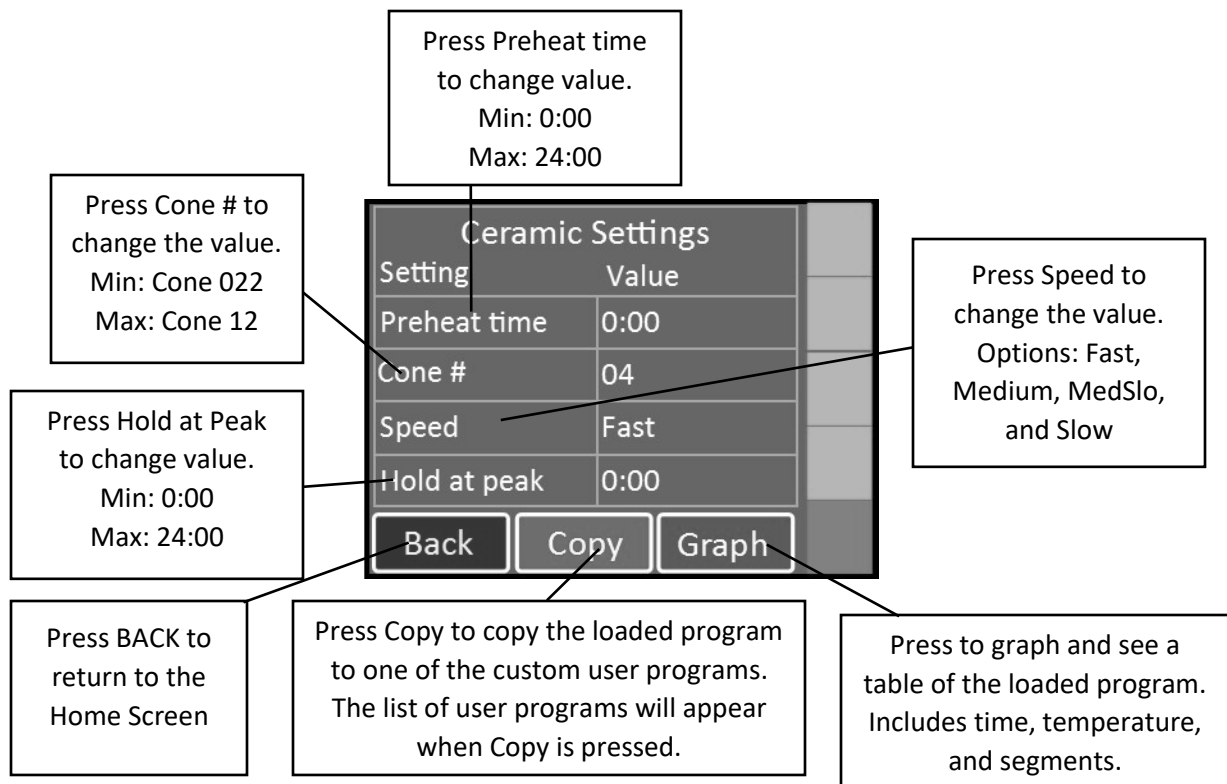

Figure 2: Ceramics programming sample.

			setting. For example: To change the preheat time, press Preheat Time, type in the new preheat time, and press str.
5	Ceramics Settings Preheat Time Cone # Speed Hold at Peak Cooling	Back	Returns to Home Screen at IDLE.

Note: When a preheat is selected, the temperature ramps up at 60°F/hour (33°C/hr) to 200°F (93°C) for the amount of time programmed.

When the copy function is used and Copy is selected, the controller will return to the IDLE screen. The loaded program will become the copied program in its new user location.

Notes for Cooling (Not Pictured): Scroll down to select Cooling. Cooling is set to Off unless changed by the user. With cooling turned on, it adds 2 segments on to the end of the firing. The first segment cools the kiln from the top temperature down to 1900°F at a rate of 9999 (As fast as possible). The 2nd and final segment cools the kiln from 1900°F down to 1500°F at a rate of 150°F per hour.

Glass Programming

Programming in Novice mode is the easiest method to program the controller for glass firings. Programming consists of choosing the type of firing, firing speed, and COE (Coefficient of Expansion). The firing speed is chosen by the size of the glass being fired.

Glass Programming – Novice Mode ON:

Step	Display Shows	Key Press	What This Selection Means
1	Home Screen	Load	You're ready to load a different program into the controller memory.
2	What are you firing?	Glass	Choose from Ceramics, Glass, and Other. Choose Glass for slumping, fusing, or casting glass.
3	What type of firing?		Choose the type of firing, either Slump, Tac Fuse, Full Fuse, or Cast.
		Slump	Slump is used for firing glass pieces that you want to conform to a mold.
		Tac Fuse	Tac Fuse is used for fusing glass that result in softened edges
		Full Fuse	Full Fuse is used for fusing glass that result in soft, round edges
		Cast	Cast is used for melting glass pieces together.
4	What speed?		Choose the firing speed, either Fast, Medium, MedSlo, or Slow.
		Fast	Fast is the fastest firing speed and is used for glass pieces that are either under 2in. x 2in. or very thin
		Medium	Medium is used for glass pieces that are under 4in. x 4in. or very thick.
		MedSlo	MedSlo is used for glass pieces that are under 8in. x 8 in. or 2 to 3 layers thick.

		Slow	Slow is the slowest firing speed and is used for glass pieces that are over 8in. x 8in. or multiple sheets thick.
5	Program Loaded:	OK	Return to Home Screen at IDLE.

Glass Programming – Novice Mode OFF:

Step	Display Shows	Key Press	What This Selection Means
1	Home Screen	Load	You're ready to load a different program into the controller memory.
2	Load Program	3-Glass	Choose between 1-Bisc, 2-Glaze, 3-Glass, or 4-Custom
3	Glass		Choose the type of glass firing, either Slump, Tac Fuse, Full Fuse, or Cast.
		Slump	Slump is used for firing glass pieces that you want to conform to a mold.
		Tac Fuse	Tac Fuse is used for fusing glass that result in softened edges
		Full Fuse	Full Fuse is used for fusing glass that result in soft, round edges
		Cast	Cast is used for melting glass pieces together.
4	Program Loaded:	OK	Returns to Home Screen. To make changes to the loaded program, go into the edit menu.
5	Home Screen	Edit	Displays the current settings for the firing. To change the settings, press the setting to be changed and select the new setting. For example: To change the speed, press Speed, select the desired speed, and press Save.
6	Glass Settings Temperature Hold Time Speed Glass COE	Graph	Press to graph the currently loaded program.
7	Graph	Table	Press TABLE to view and edit each individual segment of the firing. Use the scroll bar at the right side of the screen to view each segment in the loaded program. Displays the current settings for each segment of the firing (rate, temperature, and hold time for each segment). To change the settings, press the setting to be changed and select the new setting. For example: To change the rate for Segment 1, press the temperature listed under Segment 1's rate, type in the new temperature, and press Save. Any saved changes made to the Custom user program will overwrite the default program.
8		Back	Returns to Home Screen at IDLE.

Custom Programming

The default custom programs are listed in Appendix C: Custom Firing Default Programs. The Genesis has 30 Custom user programs to store and reuse. User programs 1-12 have 32 segments each, while 13-30 have 8 segments each. Each segment has a firing rate, a soak temperature and a hold time. Custom programs can only be edited with Novice Mode set to OFF. See page 19 for more information.

Custom Programming – Novice Mode ON:

Step	Display Shows	Key Press	What This Selection Means
1	Home Screen	Load	You're ready to load a different program into the controller memory.
2	What are you Firing?	3 - Other	Choose from Ceramics, Glass, and Other. Choose Other for custom firings
3	Other User1- User2- User3-	UserX -	Using the scroll bar on the right side of the screen, scroll until the desired program is displayed. For a complete list of the default programs, see Appendix C: Custom Firing Default Programs.
4	Program Loaded: CUSTOM UserX	OK	The selected custom program has been loaded.
5	Home Screen	View	Use the scroll bar at the right side of the screen to view each segment in the loaded program. There is specific rate, temperature, and hold time for each segment. You cannot add, delete, or change segments when Novice Mode is activated.
6	UserX – #, Rate, Temp, Hold, F	Back	Returns to Home Screen at IDLE.

Custom Programming – Novice Mode OFF:

Step	Display Shows	Key Press	What This Selection Means
1	Home Screen	Load	You're ready to load a different program into the controller memory.
2	Load Program	4-Custom	Choose between 1-Bisc, 2-Glaze, 3-Glass, or 4-Custom
3	Custom	UserX -	Using the scroll bar on the right side of the screen, scroll until the desired program is displayed. For a complete list of the default programs, see Appendix C: Custom Firing Default Programs.
4	Program Loaded: CUSTOM UserX	OK	The selected custom program has been loaded.

5	Home Screen	Edit	To make changes to the loaded program, go into the edit menu. Use the scroll bar at the right side of the screen to view each segment in the loaded program. Displays the current settings for each segment of the firing (rate, temperature, and hold time for each segment). To change the settings, press the setting to be changed and select the new setting. For example: To change the rate for Segment 1, press the temperature listed under Segment 1's rate, type in the new temperature, and press Save. Any saved changes made to the Custom user program will overwrite the default program.
6	UserX- #, Rate, Temp, Hold, F	Back	Returns to Home Screen at IDLE.

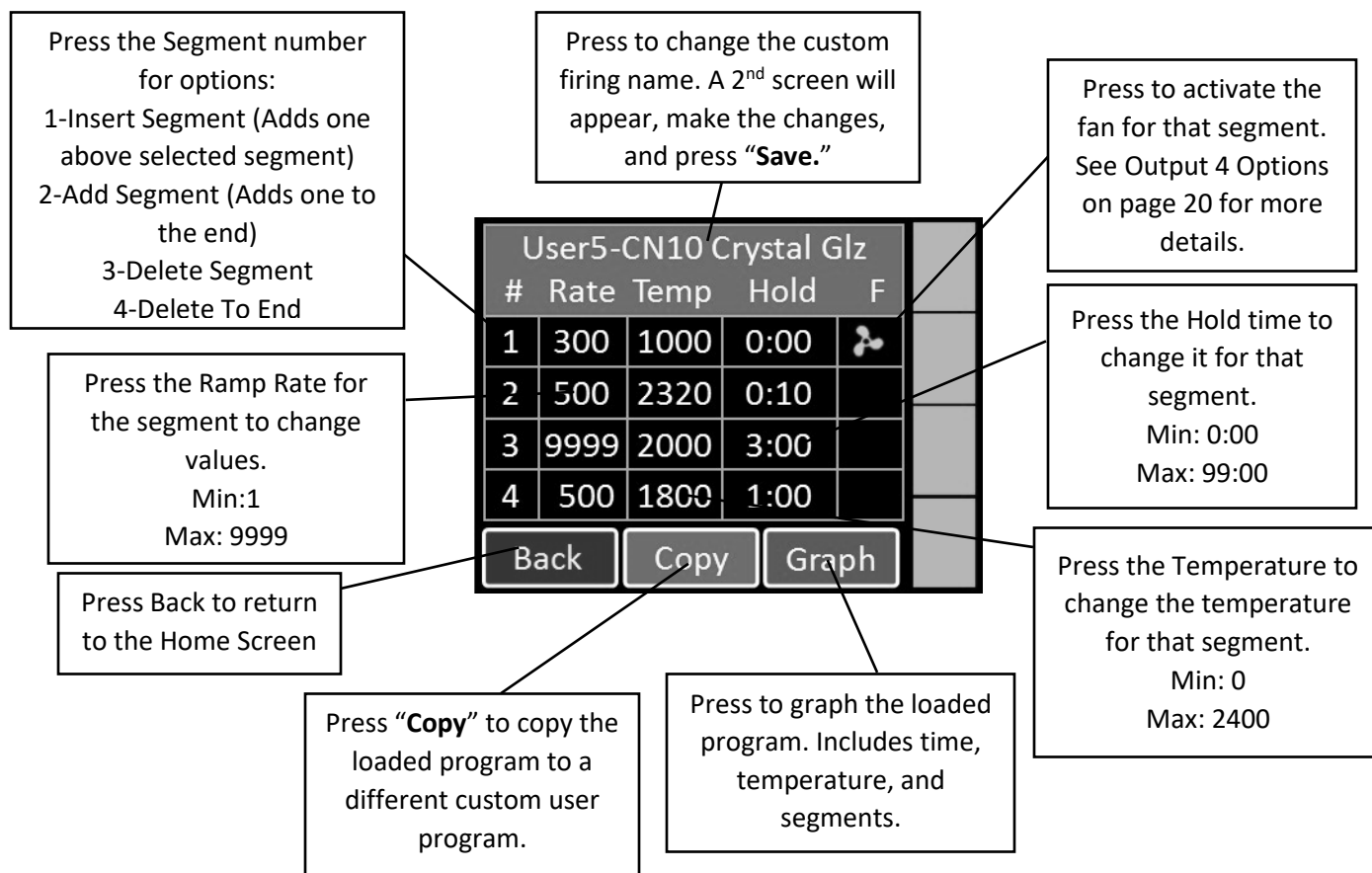

Figure 3: Sample of a Custom Program.

Notes For Custom Programming:

1. A firing will start in the earliest segment that has a soak temperature greater than the current kiln temperature. If the current kiln temperature is above all soak temperatures, the controller will go directly to complete.

2. To ramp up or down at the maximum rate, enter a rate of 9999.
3. To program a down ramp, enter the rate/hour then a temperature below the previous segment's temperature.
4. It is best to write out the firing profile that you plan to program before you begin programming. A blank form for writing your firing programs can be found in **Appendix D: Blank Firing Program**. Photo-copy as needed.

Calculating Ramp Rates for Custom Firing

If you want to go from room temperature to 750°F in 3 hours, use this method to calculate the ramp rate. Take the temperature that you want to go to (750°F) minus the starting temperature (70°F – approximate room temperature) to get the number of degrees you want to increase in 3 hours (750 – 70 = 680). Divide this number by the time you want to get to 750 to give you the ramp rate (680°F ÷ 3 hrs = 227°F/hr). If you want to add another segment to go from 750°F to 1000°F in 4 hours, the same procedure is used. Take the end temperature minus the starting temperature (1000 – 750 = 250) and divide this number by the number of hours to reach 1000°F (250°F ÷ 4 hrs = 63°F/hr).

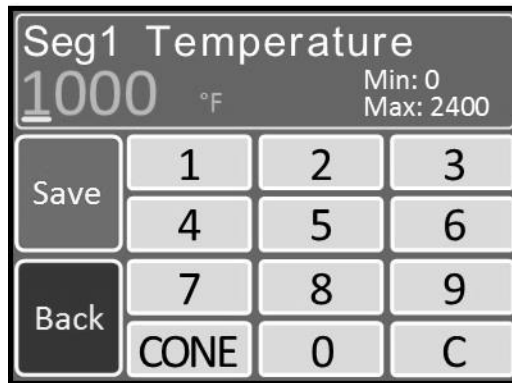

Figure 4: During a Custom Firing, you can enter the desired temperature or press CONE. Choose the desired Cone Number and the controller will enter the corresponding temperature.

Custom Ceramics Program

Writing your own ceramics program combines the versatility of the Custom program and the heat-work calculation of a ceramics firing. It is a great way to get custom heating and cooling rates and still have the controller do the heat-work calculation to get the correct cone bend regardless of firing rate. The steps to write your own cone fire are the same as entering a Custom program except when programming the top temperatures, press the **“CONE”** button, scroll until the desired cone number is displayed, and press **“SAVE”**. The selected cone's top temperature will be displayed under Temp for that segment. The cone temperature can be entered into any segment so you can also have cool down segments in the program.

Start A Firing

Press **“Start”** to open the Start Firing Screen. There are 3 options as to how you'd like to begin the firing. To start the kiln immediately, press **“1-Start Now”**, enter the start code (Default = 1), and press **“Start”**. To program the kiln to start in a set amount of time press **“2-Start Later”**, enter the start code, press **“Start”**, enter a delay start time of up to 4 hours, and press **“SAVE”**. **CAUTION: Make sure the kiln area will stay clear and safe throughout the delay time and firing time.** To arm the controller

for a remote start via the KISS program, press **“3-Remote Start”**, enter the start code, and press **“Start”**. The controller will now read **“REMOTE”** at the top. This means the area around the kiln is clear, it’s loaded, and it can be fired at any time from the KISS program.

Operation of the Controller During A Firing

The Genesis controller eliminates much of the “babysitting” that is required with a manual kiln. To ensure the most consistent results from one firing to the next, you should understand how the controller operates and monitor the firing to ensure proper operation. The following diagram and flow chart show the basic components of a kiln’s control system.

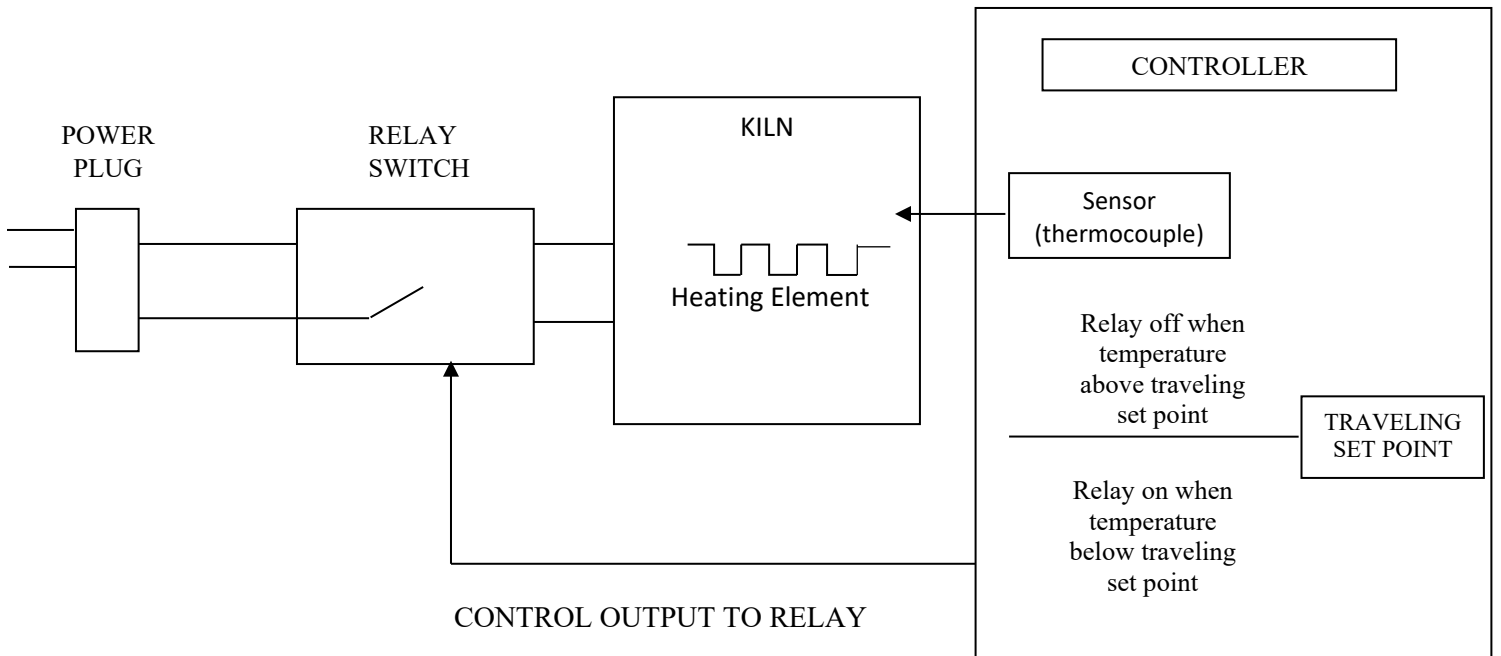

Figure 5: Kiln Operation

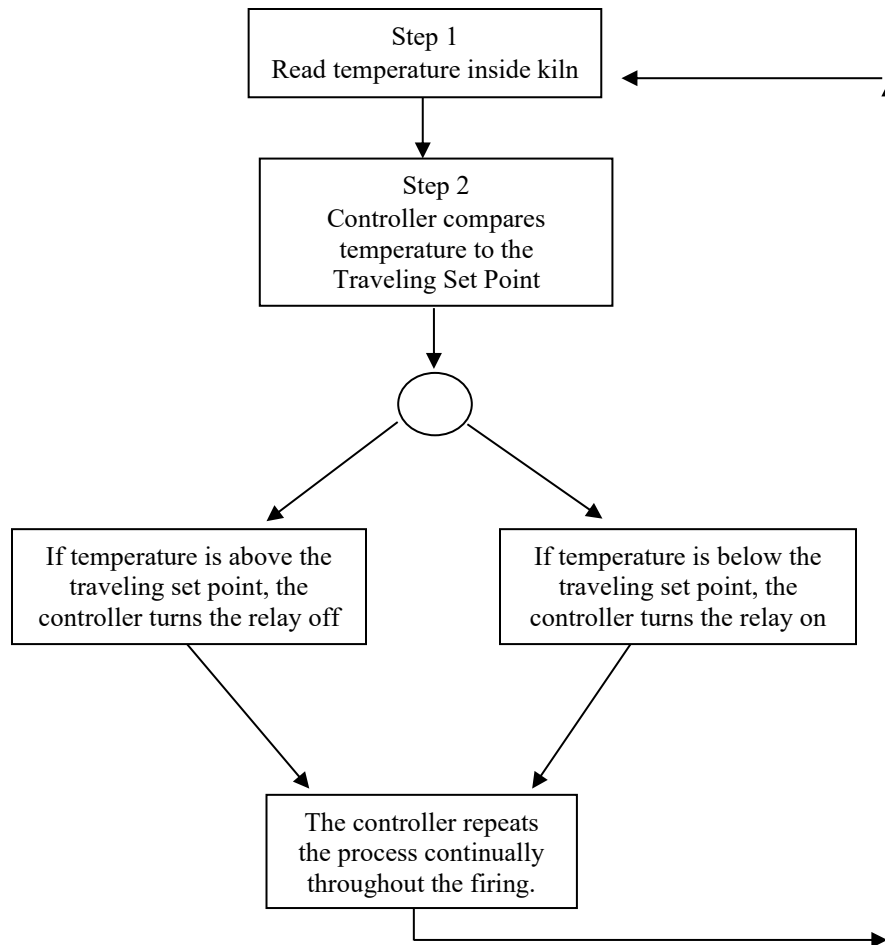

Figure 6: Shows a flow chart of the control algorithm in its simplest form. Like your home thermostat.

The diagram and flow chart show that the kiln control system, in its simplest form, works like your thermostat at home – when the temperature is too cool the heater comes on; when the temperature is too hot the heater turns off. The major components of the control system are the Genesis controller, thermocouple temperature sensor, relay switch, power source, and heating elements. The controller is the brain of the operation; the controller adjusts the traveling set point according to your program, reads the temperature in the kiln, cycles the relay on or off and determines when to end the program.

The thermocouple (T/C) sensor is the first part to inspect when loading the kiln. The tip of the T/C should protrude approximately 1- 1/2" into the firing chamber. Next, "START" is pressed, the controller reads the kiln temperature and uses that temperature as a starting point for a traveling set-point (also called the local set point). The displayed temperature is the temperature inside the kiln. You should then hear the relay(s) start cycling on and off to keep the temperature near the traveling set point. As the firing progresses the controller moves the traveling set-point according to the programmed firing rate. The displayed temperature should increase with the traveling set-point and the relay will be "on" longer. This sequence continues until the final temperature is reached and the controller turns off the kiln. The display reads "COMPLETE".

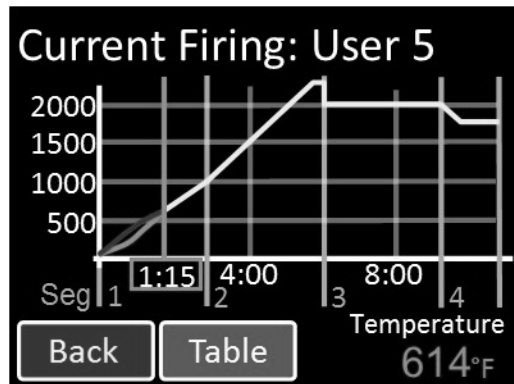

Figure 7: Sample graph of program during a firing.

Adjustments During a Firing

Once a firing has been started, the screen will change to the Firing Screen, as seen on page 6. You can still view the program and make adjustments to the firing.

Stop

Press STOP at any point in the firing to immediately stop the firing. The controller will return to the Home Screen. To start the program again, simply restart the kiln. The controller will start in the segment with an up-ramp equal to the kiln's current temperature. If the kiln does not restart in the segment it was stopped in, press the Adjust button and skip to the desired segment.

View (Applies to Novice Mode)

View the setting for the firing. For a ceramic firing, the preheat time, cone #, speed, and hold time will be displayed. Press the "Graph" button to view the firing as a graph. This includes time, temperature, and segments. To see each individual segment, press the "TABLE" button. Changes or adjustments to the firing can't be made here once the firing has started. To make adjustments, press the Adjust button.

Graphing Key:

Item On Graph	Meaning
Orange Vertical Line W/ Number	Segment of the firing
Green Vertical Line W/ Time	Current firing time. Represents where the firing is currently, compared to the graph
Gray Vertical Line W/ Time Below	Time at various points throughout the firing
Yellow Graphing Line	Projected path of the firing
Green Graphing Line	Firing's actual path
Red Graphing Line	Firing's supposed path (Shown only when actual path and supposed path are not the same)
Horizontal Gray Line W/ Temperature	Kiln Temperature

Edit (Applies to when Novice Mode is Off)

“Edit-on-the-fly”. Pressing the Edit key while firing a custom program will present the table view. Gray segments have already been fired and cannot be changed. All edit features listed on page 12 are available to segments that have not been completed.

Adjust

Press Adjust to make adjustments to the firing while a firing is in progress. Pressing “**Add Time**” during a hold segment of the firing will add 5 minutes to the hold. It has no effect if the firing is not in a hold when pressed. Pressing “**Add Temperature**” during a hold segment will increase the hold temperature by 5°F. It has no effect if the firing is not in a hold when pressed. Pressing “**Skip Step**” will skip the current segment and move to the next in the firing. This feature is used when enough heat work has been done at the current segment and you want to immediately go to the next ramp rate. Pressing “**Alarm Temp.**” allows you to adjust the alarm temperature for the firing. A temperature of 9999 shuts the alarm off.

Menu

The firing menu allows for viewing of statistics and mid-firing diagnostics. By pressing “**Diagnostics**”, the controller runs a manual diagnostics test during the firing. Pressing “**TC Offsets**” allows the user to change the temperature offsets for each thermocouple. Minimum: -99°F Maximum: 99°F. For more information see **TC Offsets** under the **Adjustment Menu** on page 19.

End of Firing – COMPLETE

When the firing is complete, an alarm will sound and the controller will display COMPLETE with the current temperature and firing time. To return to IDLE, press “**Clear**”. You may open the kiln when the temperature has cooled to 150°F.

Care of Thermocouple

The small metal rod protruding into the firing chamber is the temperature sensor, or thermocouple. Do not let shelves, posts, or ware touch the thermocouple; this could affect the temperature reading.

Bumping the thermocouple during loading can damage it or push it out of the firing chamber. It should protrude into the firing chamber about 1 -1/2”. Check the kiln manufacturer’s placement instructions. Also, avoid firing clay with high sulfur content. The sulfur erodes the thermocouple making it brittle and easy to break.

Menu Screen

By pressing the Menu button on the Home Screen, you’ll be taken to the Menu Screen. The Menu Screen is a list of various options from checking your last firing status, diagnostics, offsets, and controller configuration among other things. To navigate through the Menu options, press and hold the green slider on the right side of the screen and slide up or down for more options. For more information on each component of the Menu, see the descriptions below:

Data Menu

The Data Menu holds 3 types of lists of information: diagnostic information, status information, and kiln information.

Last Firing Status

Contains diagnostics information specific to the last firing of the kiln.

Last Error Status

Contains diagnostic information specific to the last error that was encountered by the controller when firing.

Factory Diagnostics

Contains diagnostic information from factory. This includes amperage readings for each section, line voltage readings, and board output. This information can be used for comparison when a manual diagnostic test is run.

Last Element Change

Contains diagnostic information from the last new elements diagnostics. This includes amperage readings for each section, line voltage readings, and board output.

Last Manual Diagnostics

Contains diagnostic information from the last manual diagnostics test. This includes amperage readings for each section, line voltage readings, and board output.

Graph Past Firing

Contains the graphs from the last 10 firings. Use the scroll bar to find the desired firing to graph and select it. If WiFi is connected during the firing, the month and day will be displayed next to the firing. If WiFi is not connected, it will read 0/0 after the name of the firing.

Kiln Info

Contains the firmware version plus the serial number and mac address for registering and viewing your kiln at www.bartinst.com. Updating firmware will **NOT** affect the firing programs.

Diagnostics

Board Temperature

Displays the current board temperature. Displaying the board temperature is a diagnostics function to check the operation of the board. The safe range for board temperature is between 0°F - 160°F. Any temperatures below or above that range may cause damage to the controller.

Run Manual Diagnostics

This is used to manually begin a diagnostics test. It turns on each section of elements to read amperages and voltage. The results are stored under Data Menu – Last Manual Diagnostics.

New Element Diagnostics

Run New Element Diagnostics when the elements have been changed to record amperages and voltages for the new element. The results are stored under Data Menu – Last Element Change.

Relay Health

Keep track of the number of on/off cycles of the relays on your kiln. An on/off cycle will be counted as one. When a relay is replaced, press the corresponding zone and press the RESET button to set the number of cycles back to 0.

Adjustments

Adjustments allows you to change the Cone and Thermocouple offsets as well as the Alarm temperature and Output 4 Percentage On for the controller.

Cone Offset

Cone offset is used to raise or lower the final cone temperature. The final cone temperature can be raised or lowered a maximum of 99°F (37°C). To correct an under-firing set a positive cone offset. To correct an over-firing, set a negative (-) cone offset. To change the Cone Offset, press “**Cone Offset**”, and use the scroll bar to select the cone offset. When the correct cone is displayed, press “**Edit**”, enter the desired offset and press “**Save**”.

Cone Offset Example		
Degrees	Meaning	Effect
20°	Raise the final cone temperature by 20°F	Increases heat work
45°	Raise the final cone temperature by 45°F	Increases heat work
-15°	Lower the final cone temperature by -15°F	Decreases heat work
-35°	Lower the final cone temperature by -35°F	Decreases heat work

Thermocouple Offset

Thermocouple offset is used to raise or lower the temperature indicated by the thermocouples. This is generally used to balance the heat-work in a zone controller kiln. The maximum TC Offset is 99°F (37°C). To correct an under-firing set a negative TC Offset. To correct an over-firing, set a positive TC Offset. To change the TC Offset for thermocouple 1, press “**TC Offsets**”, press “**TC1 Offset**”, enter the desired number and press “**Save**”. Repeat for TC2 Offset and TC3 Offset if needed.

Alarm Temperature

Set the alarm temperature for the kiln. To set the alarm before the firing, press “**Set Alarm**”, type the desired alarm temperature, and press “**SAVE**”. The default alarm temperature is 9999°F (Off). The alarm setting will change as you change the loaded program. For example, the USER1 program is loaded and the user sets the alarm to 2400°F. The user then loads the USER2 program and sets the alarm to 1700°F. If the user loads USER1 again, the alarm temperature will change back to 2400°F automatically.

Out 4 Percent On

Sets the “on time” Output 4 as a percent of output three’s “on time”. Only used when enabled by the kiln manufacturer.

End of Hold Alarm

When enabled, the alarm will sound when a hold has come to an end. To stop the alarm, simply tap anywhere on the screen. To enable the End of Hold Alarm, press “**Enable**” and press “**SAVE**”.

Start of Hold Alarm

When enabled, the alarm will sound when a hold has started. To stop the alarm, simply tap anywhere on the screen. To enable the End of Hold Alarm, press “**Enable**” and press “**SAVE**”.

PID Gain

Check with your kiln manufacturer before making changes to this setting.

Configuration

Novice Mode

The Genesis may come set in Novice Mode depending on the kiln manufacturer’s preference. Novice Mode is meant for beginner users to make programming easier. For more advanced programming, Novice Mode can be turned off. To turn Novice Mode off, select “**Off**” and press “**Save**”.

Communications

Set up Wi-Fi for Firmware download and KISS ID for monitoring firings from your PC. (Additional computer software required for PC monitoring)

Kiss ID – Each controller to be monitored must have a unique KISS ID number ranging from 1 to 50. See KISS manual for details.

Enable Wi-Fi – Enable or disable the Wi-Fi feature. **Off** turns Wi-Fi capabilities off at all times. **On When Firing** enables Wi-Fi only when a firing is in progress. **Always On** turns the Wi-Fi on anytime it is within range of a setup Wi-Fi connection.

Wi-Fi Setup – To set up Wi-Fi for the Genesis, press “**Wi-Fi Setup**” and the controller will scan for nearby networks. Select your desired network and enter the password (if required) and press “**Save**”.

*****For security reasons, we highly recommend that the user place all controllers into a separate logical network or VLAN, separate from other networks, routers, and hardware.**

Download Firmware – If your controller is connected to the internet through the WiFi module, by pressing Download Firmware, you will connect to www.bartinst.com to see if any updates are available. Once it has found the firmware, you have the option to update your controller. Updating firmware will **NOT** affect the firing programs.

Reset WiFi – Press Reset WiFi when having trouble with the WiFi connection. The controller will reset the WiFi connection and attempt to reconnect to your currently saved connection.

Export Log File – Used to activate Server Mode. This allows the controller to “serve” a file to a computer/phone that is on the same access point as the controller. When “**Export Log File**” is pressed, the controller will list an IP address and a code. Type the address listed on the controller into your internet browser and then enter the code when prompted.

The last 10 firings will be listed and each firing has 2 files – the temperature data and the event file. The temperature file collects data every 30 seconds. The event file collects data any time an “event” occurs such as a hold or an error occurs. Click on the file to be observed to download it.

Manual WiFi Setup – Used to manually set up a WiFi network that is hidden or otherwise not found when running WiFi Setup. Enter the network name under SSID and press “**Save**”. Under password, enter the network password at press “**Save**”.

Temperature F/C

Choose which temperature scale to use with your kiln, Fahrenheit or Celsius. To change the temperature scale, press “**Temperature F/C**”, press the desired temperature scale, either “**Fahrenheit**” or “**Celsius**”, and press “**Save**”.

Error Codes

Turn the error codes on or off for the kiln. The default setting for the controller is On. We recommend you keep the error codes on to protect your firings. They can be turned Off, in special cases, such as jewelry or glass firings where the kiln is left open. They may also be turned off when troubleshooting kiln problems.

Number of Zones

Change the number of zones (Thermocouples) the Genesis will control. For 3140 model choose: 1, 2, or 3. The Model 1120 can only be set for 1 zone.

Output 4 Options – (Usually set as a factory option)

Output 4 has 3 modes for running vent fans (Options A, B, & C), one mode that uses Output 4 to indicate the alarm has triggered (Alarm), and one mode for running elements in the lid or floor of the kiln (Percent).

Option A – Used to control a vent. Output 4 can be programmed to be on or off during each segment of a Custom program. During a Ceramic or Glass program, output 4 come on at the beginning of the firing and turns off after the kiln has cooled to 150°F.

Option B – Used to control a vent. Output 4 can be programmed to be on or off during each segment of a Custom program. Output 4 comes on at the beginning of a Ceramic or Glass program, off at 1450°F, back on after the firing is complete and the kiln has cooled to 1000°F and finally off again when the temperature is below 150°F.

Option C – Used to control a vent, an alarm, or other atmospheric control. Output 4 can be programmed to be on or off during each segment of a Custom program. Output 4 is off during Ceramic and Glass programs.

Alarm – When this option is selected, Output 4 comes on when the alarm is triggered or an error code is encountered.

Percent – Output 4 can be programmed to be on for a percent of the time Output 3 is on. This option is used when Output 4 controls floor or lid elements. To ensure Output 4 stays off at all times, use this option and set the percentage to zero.

Start Code

The Start Code is entered to start a firing. Enter any 4 number combination and press “**Save**”. Default = 1. This will be entered anytime the kiln is fired.

Calibrate Touch

Used to re-calibrate the touch screen if buttons aren’t working properly. Press the “**Calibrate Touch**” button and follow the onscreen instruction to re-calibrate.

Cost Setup

Enter the cost per kilowatt hour and the wattage for each zone in the kiln. The cost per kilowatt hour has a minimum of \$0.001 (1/10th of a penny) and a maximum of \$9.999. This information can be acquired from your electric company. The zone wattage has a minimum of 0 and a maximum of 50,000 Watts. This information can be acquired from the kiln manufacturer or consult your kiln’s manual. If it a multi-zone kiln, you can enter the kiln’s wattage in Zone 2, or divide the kiln’s wattage and split evenly between the 3 zones.

Example: The cost per kilowatt hour is 16 cents and the kiln is a single zone with a wattage of 16,000. Press **Cost/KWH**, type in 0.16 and press **SAVE**. Press **Zone1 Watts**, type in 0, and press **SAVE**. Press **Zone2 Watts**, type in 16,000, and press **SAVE**. Press **Zone 3 Watts**, type in 0, and press **SAVE**.

Indefinite Hold

Turn to ON to activate the Indefinite Hold feature. Once turned on, a user can program an indefinite hold by entering 9999 into a hold time of a segment of a user program. Once set, the controller will hold at that temperature indefinitely until the user stops the program.

Restore Presets

Restore all preset programs and offsets to factory settings.

Restore User Programs

Restore individual User Programs 1-12 back to factory setting. Select the User Program to be restored and press “**RESTORE**”. This will clear any changes made to that user program from factory settings. Once you press “**RESTORE**” this cannot be undone. The restored default program will be loaded into the controller upon pressing “**RESTORE**”.

Reset TC Offsets

Reset thermocouple offsets to factory settings. Default TC Offset = 0 for all thermocouples. To reset: Press “**2-Reset TC Offsets**” and press “**RESTORE**”.

Restore Cone Offsets

Reset cone offsets to factory settings. Default Cone Offset = 0 for all cones. To reset: Press “**3-Reset Cone Offs**” and press “**RESTORE**”.

Restore Glass

Restore the Glass firing setting back to factory. Once “**RESTORE**” is pressed, any changes made to the Glass profiles will be restored back to factory and cannot be undone.

Customization

Customization allows you to change what program menus are available and which set of custom User profiles to be loaded into the controller either a Mix, Heat Treat, or PMC.

Ceramic Menus

Allows the user to enable or disable the ceramic programming menus. When disabled, the Bisc and Glaze programs will be removed under “**Load Program**”.

Glass Menus

Allows the user to enable or disable the glass programming menus. When disabled, the glass programs will be removed under “**Load Program**”.

User Library

Allows the user to change which customizable user programs are to be loaded into the controller. Options for programs include “**Mix**”, “**Heat Treat**”, and “**PMC**”. For a list of the User Libraries, see **Appendix C**.

Factory Configuration

Factory configuration is used by the kiln manufacturer to set kiln specific parameters for the controller such as thermocouple type, top temperature, and board temperature. For more information, see the technical manual online. Contact the kiln manufacturer before making any changes that might damage the kiln.

Appendix A: Error Codes

If you get an error code, it is important to note the error letter or number. It will help you in diagnosing any problem with the kiln. When an error code is displayed, it will give a short description of the error. Press “Clear” to clear an error code.

The list of error codes follows:

NOTE: THESE ERRORS WILL ONLY BE DETECTED IF THE ERROR CODES ARE TURNED ON:

Error Code	Description	Possible Causes
ERROR 1	Kiln temperature increasing slower than 12°F per hour when ramping up	This is a kiln heating problem, not a controller problem. Do the Full Power Test to check elements and relays. Low or dropping voltage to the kiln could also be the cause. A thermocouple reading incorrectly or improperly placed may also be the cause.
ERROR 2	Kiln temperature 50°F above hold temperature	A relay latched in the “on” position may cause this error. Another possible cause is if the kiln lid is opened for rapid cooling, then closed, such as for glass firings.
ERROR 3	Kiln temperature 50°F below hold temperature	Relay failure.
ERROR 4	Kiln temperature 50°F above previous hold when ramping down	Same causes as for E-2.
ERROR 5	Kiln temperature 50°F below traveling set point when ramping down.	Relay failure.
ERROR D	Kiln temperature 50°F above traveling set point	Stuck relay or stuck output. If using zone control, then the outputs or t/c’s may be in the wrong zones.

NOTE: THE ERROR CODE SETTING DOES NOT AFFECT THESE ERRORS:

Error Code	Description	Possible Causes and/or Corrections
ERROR 0	Software error	Check the selected program and reprogram, if necessary. If error persists or program does not hold in memory, controller may need to be returned to factory for service.
ERROR 6	Problem with thermocouple leads	This generally indicates the thermocouple is connected incorrectly, possibly reversed. Ensure the thermocouple extension wires are connected correctly to the controller and at all connection blocks back to the thermocouple.
ERROR 8	In cone fire mode, temperature decreasing in last segment	If the kiln has a kiln-sitter, it may have turned the kiln off before the controller did. Other possible causes are broken element or relay failure.
ERROR 9	Software thermocouple selection does not match the hardware thermocouple jumper selection	The jumper on the circuit board and the setting for thermocouple TYPE in the software do not match.
E--	Power loss during EEPROM write	Turn the controller off and back on. Recheck the selected program and reprogram, if necessary.

ERROR A	Invalid program variable	Reprogram all segments of the program being fired. If error persists, controller may need to be returned to factory for service.
ERROR bd	Board temperature too high	The control box temperature may be too hot or the limit temperature may need to be reset. If the room temperature is very hot, aiming a fan at the control box may decrease the temperature.
ERROR E	Hardware error	Controller will need to be returned to the factory for service.
ERROR R	Microprocessor memory does not match program storage memory (EEprom)	Reprogram and try to fire again. If error persists, controller may need to be returned to factory for service.
ERRP	ERRP will display. To clear the display, press "Clear". The firing in progress will continue.	Power outage; kiln is still firing.
Thermocouple FAIL	Thermocouple FAIL indicates one or more t/c's have failed. If more than one thermocouple is connected, the controller will indicate which thermocouple has failed.	Check the board temperature under Diagnostics under Menu. If the board temperature is approximately room temperature, then the t/c is defective. If the board temperature shows a high temperature the circuit board is defective.
PF	Power failure. Firing has stopped.	Power was lost during a firing and the kiln temperature was below 140°F or the kiln temperature dropped more than 250 degrees during the power outage.

Full Power Test

The full power test is used to check the relays and elements of the kiln. To set the controller for a full power test, simply load the User12 program and turn the alarm to 9999. With the kiln empty and the lid open, start the firing. Visually inspect the elements after the kiln has fired for 20 – 25 minutes. Observe each element from where it comes into the kiln all the way around to see that it is equally bright throughout. The following observations are possible:

One section of the kiln is dark and not coming on. – This could indicate a defective relay since there is usually one relay per section.

One element is not glowing at all. – This indicates a broken or bad element.

There are darker (Cool) spots along the elements. – This indicates worn elements.

The top and bottom elements appear brighter. – This is normal for many kilns that have hotter elements in the top and bottom.

After you've made your observations, turn off the kiln. Contact your kiln manufacturer for kiln replacement parts (relays and elements). If there is an issue with your controller, please contact us.

Appendix B: Cone Fire Temperature Profiles

Firing Profiles for Cone 04, Temperature 1945°F (1063°C)

Ceramics – Slow (Bisc Hand Thrown)			
Segment	Rate/hr	Temperature	Stage Time
1	80	250	2.25
2	200	1000	3.75
3	100	1100	1.00
4	180	1695	3.31
5	80	1945	3.13
Total Firing Time:		13 hrs. 26 min.	

Ceramics – Medium (Glaze Larger Pieces or Bisc Thin)			
Segment	Rate/hr	Temperature	Stage Time
1	150	250	1.20
2	400	1695	3.61
3	120	1945	2.08
Total Firing Time:		6 hrs. 54 min.	

Ceramics – MedSlo (Bisc Medium Pieces)			
Segment	Rate/hr	Temperature	Stage Time
1	120	250	1.50
2	300	1000	2.50
3	150	1100	0.67
4	180	1695	2.64
5	108	1945	2.31
Total Firing Time:		9 hrs. 38 min.	

Ceramics – Fast (Glaze Thin Pieces)			
Segment	Rate/hr	Temperature	Stage Time
1	570	1695	2.85
2	200	1945	1.25
Total Firing Time:		4 hrs. 6 min.	

Firing Profiles for Cone 6, Temperature 2232°F (1222°C)

Ceramics – Slow (Bisc Hand Thrown)			
Segment	Rate/hr	Temperature	Stage Time
1	80	250	2.25
2	200	1000	3.75
3	100	1100	1.00
4	180	1982	4.90
5	80	2232	3.13
Total Firing Time:		15 hrs. 2 min.	

Ceramics – Medium (Glaze Larger Pieces or Bisc Thin)			
Segment	Rate/hr	Temperature	Stage Time
1	150	250	1.20
2	400	1982	4.33
3	120	2232	2.08
Total Firing Time:		7 hrs. 37 min.	

Ceramics – MedSlo (Bisc Medium Pieces)			
Segment	Rate/hr	Temperature	Stage Time
1	120	250	1.50
2	300	1000	2.50
3	150	1100	0.67
4	180	1982	3.92
5	108	2232	2.31
Total Firing Time:		10 hrs. 54 min.	

Ceramics – Fast (Glaze Thin Pieces)			
Segment	Rate/hr	Temperature	Stage Time
1	570	1982	3.35
2	200	2232	1.25
Total Firing Time:		4 hrs. 36 min.	

Appendix C: Custom Firing Default Programs

The custom firing programs will change based off the users customization settings. If Novice mode is off, you can write over them to create your own programs. See Programming for Custom Firings to make changes to a preloaded program. For all programs, the alarm is set to off (9999). When the alarm temperature is changed, it only changes for the loaded program, not all programs.

Custom Programs: Mix

User 1 – Blank 1			
Seg	Rate	Temperature	Hold
1	100	100	0:01

User 2 – Blank 2			
Seg	Rate	Temperature	Hold
1	200	200	0:02

User 3 – Blank 3			
Seg	Rate	Temperature	Hold
1	300	103	0:00

User 4 – CN6 Crystal Glz			
Seg	Rate	Temperature	Hold
1	300	1000	0:00
2	500	2230	0:15
3	9999	2000	0:00
4	500	1800	4:00

User 5 – CN10 Crystal GLz			
Seg	Rate	Temperature	Hold
1	300	1000	0:00
2	500	2320	0:10
3	9999	2000	3:00
4	500	1800	1:00

User 6 – Bead Annealing			
Seg	Rate	Temperature	Hold
1	9999	960	8:00
2	9999	960	0:45

User 7 – Wine Bottle			
Seg	Rate	Temperature	Hold
1	500	500	0:15
2	500	1000	0:15
3	600	1250	0:20
4	500	1475	0:15
5	9999	1100	0:30
6	200	970	0:30
7	120	750	0:10

User 8 – PMC FAST			
Seg	Rate	Temperature	Hold
1	9999	1650	0:10

User 9 – PMC3 FAST			
Seg	Rate	Temperature	Hold
1	9999	1290	0:10

User 10 – Lost Wax Silver			
Seg	Rate	Temperature	Hold
1	500	300	2:00
2	500	700	1:00
3	500	1350	4:00
4	9999	900	8:00

User 11 – Lost Wax Gold			
Seg	Rate	Temperature	Hold
1	500	300	2:00
2	500	700	1:00
3	500	1350	4:00
4	9999	800	8:00

User 12 – Full Power Test			
Seg	Rate	Temperature	Hold
1	9999	1000	0:40

Custom Programs: Heat Treat

User 1 –154CM ATS34			
Seg	Rate	Temperature	Hold
1	9999	1900	0:30

User 7 – Draw 500			
Seg	Rate	Temperature	Hold
1	9999	500	2:00

User 2 – AISI 0-1			
Seg	Rate	Temperature	Hold
1	9999	1450	0:20

User 8 – Draw 400			
Seg	Rate	Temperature	Hold
1	9999	400	2:00

User 3 – 440C S.S			
Seg	Rate	Temperature	Hold
1	9999	1850	0:25

User 9 – Draw 375			
Seg	Rate	Temperature	Hold
1	9999	375	2:00

User 4 – AISI D-2			
Seg	Rate	Temperature	Hold
1	9999	1850	0:20

User 10 – Draw 300			
Seg	Rate	Temperature	Hold
1	9999	300	2:00

User 5 – AISI A-2			
Seg	Rate	Temperature	Hold
1	9999	1750	0:20

User 11 – Draw 275 X2			
Seg	Rate	Temperature	Hold
1	9999	275	2:00
2	9999	120	0:00
3	9999	275	2:00

User 6 – Draw 900 X2			
Seg	Rate	Temperature	Hold
1	9999	900	2:00
2	9999	125	0:00
3	9999	900	2:00

User 12 – Draw 220/200			
Seg	Rate	Temperature	Hold
1	9999	220	2:00
2	9999	120	0:00
3	9999	200	2:00

Custom Programs: PMC

User 1 –PMC Stand			
Seg	Rate	Temperature	Hold
1	9999	1650	2:00

User 7 – Bronze Clay			
Seg	Rate	Temperature	Hold
1	350	1550	2:30

User 2 – PMC +			
Seg	Rate	Temperature	Hold
1	9999	1650	0:10

User 8 – Bronze Fast Fire			
Seg	Rate	Temperature	Hold
1	1525	1525	1:00

User 3 – PMC 3			
Seg	Rate	Temperature	Hold
1	9999	1290	0:10

User 9 – Copper Clay			
Seg	Rate	Temperature	Hold
1	9999	1750	3:00

User 4 – PMC Gold			
Seg	Rate	Temperature	Hold
1	9999	1650	0:10

User 10 – White Copper			
Seg	Rate	Temperature	Hold
1	9999	1850	2:00

User 5 – ArtClay Silver			
Seg	Rate	Temperature	Hold
1	9999	1436	0:05

User 11 – Burnout Stage			
Seg	Rate	Temperature	Hold
1	600	650	0:30

User 6 – ArtClay Gold			
Seg	Rate	Temperature	Hold
1	9999	1814	1:00

User 12 – Dry			
Seg	Rate	Temperature	Hold
1	9999	120	1:00

Appendix D: Blank Firing Program

Keep this page as a Master and photocopy as needed.

Firing Program Number: _____

Segment	Rate Per Hour	Temperature	Hold
1			
2			
3			
4			
5			
6			
7			
8			

Firing Program Number: _____

Segment	Rate Per Hour	Temperature	Hold
1			
2			
3			
4			
5			
6			
7			
8			

Appendix E: Common Questions and Situations

Q. How do I clear an error message?

A. To stop the sounding alarm, press anywhere on the screen. Then to clear the message, press “**Clear**” and the controller will return to the IDLE screen.

Q. What is a segment?

A. A segment is the basic building block of a program. Each segment consists of a ramp rate in degrees per hour, a temperature you want to achieve, and whether you want to hold there or not. For example, a program for drying ware going at 60°F/hour to 200°F and holding for 2 hours would be a one segment firing, the ramp is 60, the temperature is 200, and the hold is 2.00.

Q. Do I need to use witness cones for each firing?

A. After checking your kiln with witness cones for the first few firings, if you are satisfied with the results you are getting and how even the kiln is from top to bottom, then you do not need to use cones in each firing. It is a good practice to periodically place witness cones in the kiln to check for proper firing. If you suspect a problem or your results have changed, then it is a good idea to check the operation of the kiln with witness cones.

Q. Who do I contact for parts for my kiln?

A. For replacement parts for your kiln (relays, elements, etc.), contact the kiln manufacturer. For any issues with your controller contact us at Bartlett Instrument Co. for a solution.

Appendix F: Zone Control

Your kiln must have multiple thermocouples and be wired for multiple zones to take advantage of these features.

1. Features and Enhancements

- 3 separately controlled zones (3 T/C inputs, 3 outputs)
- Adjustable offsets for each thermocouple (T/C)
- Continues to fire with 1 or 2 failed thermocouples (T/C's)
- Slows ramping when any zone lags the set-point
- Reset function which zeros the TC offsets and turns the errors on

2. General Description

The Genesis advanced 3-zone control system is programmed the same as the single zone control but it ensures an even firing from the top to the bottom of the kiln. A 3-zone control has 3 temperature sensor inputs (thermocouples) and 3 independent outputs so the kiln can have 3 separately controlled sections (zones). The controller senses the temperature in each section of the kiln, compares the temperature to the desired temperature (traveling set-point) and adjusts the power going to each section separately giving each just the right amount of power to keep the temperature at the correct setting. The single zone controller only measures the temperature at the center of the kiln and gives all sections the same amount of power.

3. Automatic Lag Function

Lag refers to when the temperature of a kiln's section "lags" behind the traveling set point because the programmed ramp rate is faster than the kiln's temperature can rise. The Genesis will slow the ramp rate when a section of the kiln lags. The ramp rate determines the amount of "lagging" that is allowed before the firing rate is slowed. Fast ramp rates (>500 °F/hr) will allow the greatest temperature difference between sections. Slow ramp rates (<70 °F/hr) will have the smallest temperature differences between sections. Therefore, when the controller is programmed to go fast it will sacrifice evenness to obtain speed. Likewise, when the controller is programmed to go slow, the controller will maintain tighter control. The controller will try to balance speed and tight control when a medium speed is programmed.

4. Thermocouple Offsets

(See T/C offsets and Cone offsets on page 18 for more information)

Normal variation in thermocouples can cause a section to fire too hot or too cold. The zone control has an offset feature to adjust the reading of each thermocouple to compensate for any error. For example, if shelf cones indicate that the bottom section is under firing, it means that the controller thinks the bottom section actually reached the ending temperature when it really was below the ending temperature. To correct this problem, a negative thermocouple offset is required. This offset will be subtracted from the actual reading and will lower the temperature reading in that section. A negative offset will cause a section to fire to a higher temperature increasing the heat-work for that section. A positive offset will cause a section to fire to a lower temperature decreasing the heat-work for that section. To return all TC offsets to zero, press "**Menu**", scroll down and press "**5-Restore Presets**", press "**2-Reset TC Offsets**", and press "**RESTORE**".

5. Three Thermocouples

Besides better measuring of the temperature, the zone control also offers security through its three thermocouples. With a single zone controller, a firing will be stopped if the thermocouple fails. The zone control with 3 T/C's will continue to fire if one or two of its thermocouples fail during a firing. If the top or bottom thermocouple fails, that section will be controlled by the top T/C. If the controller is at IDLE and a T/C fails, "Error Thermocouple Failed" will appear on the screen.

When using three thermocouples, thermocouple 2's temperature is displayed under current temperature. The temperature of each zone can be viewed during the firing. To view the other thermocouple temperatures, press the screen where the current temperature is displayed. The temperatures for all three T/Cs, percentage of power to the elements, and the current Set Point will appear.

Appendix G: Genesis Connection Diagram

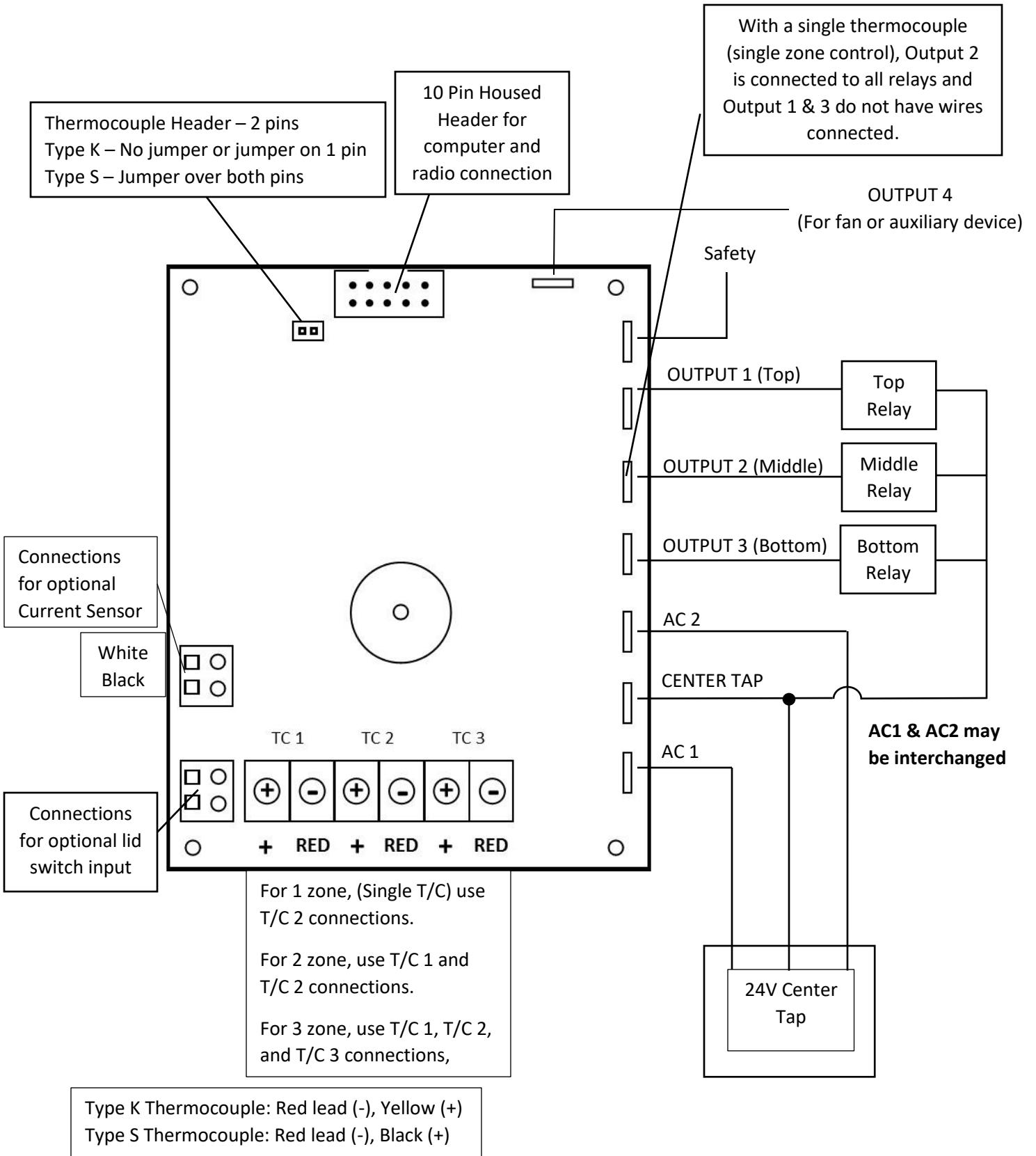

GENESIS (Model LT3140) & Genesis Mini (Model LT1120) Technical Manual

GENERAL DESCRIPTION

The Genesis & Genesis Mini controllers are Bartlett Instrument's 8th generation kiln controller. We've enhanced all the great features from older models and added many new ones. The Genesis & Genesis Mini kiln controllers regulates the temperatures in a kiln according to the program set by the artist. It has two different programming modes, Novice Mode and Advanced Programming. It can control a single zone or multi-zone kiln (Genesis Model LT3140 Only).

POWER SUPPLY

The Genesis LT3140 board requires a 24V center-tap transformer. It connects to the board's bottom three quick connects, labeled AC1, CENTER TAP, and AC2. The VA rating of the transformer is dependent on the electrical load of the board and relays. The board requires approximately 80mA at 12V DC and a relay typically requires approximately 140mA at 12V DC. Therefore, a three-relay system will require a transformer with a minimum rating of 6VA (500mA X 12V DC = 6 VA).

The Genesis Mini LT1120 board requires a 24V center-tap transformer. It connects to the board's 5 pin friction lock connector or to the left three quick connects, labeled AC1, CENTER TAP, and AC2 if the adapter board is installed. The VA rating of the transformer is dependent on the electrical load of the board and relays. The board requires approximately 80mA at 12V DC and a relay typically requires approximately 140mA at 12V DC.

OUTPUTS

The Genesis Model LT3140 board has five 12V DC outputs. Four outputs are given power by a safety transistor, outputs 1, 2, 3, and safety. The safety transistor is capacitor coupled to the microprocessor so it only powers the output transistors when the microprocessor is operating correctly. Outputs 1, 2, and 3 respond to their respective thermocouple inputs. All outputs are capable of driving a 500mA 12 V DC load. Output 4 is an extra output that can be programmed to run a fan, alarm, or extra kiln section. The maximum combined output of all outputs is 1 Amp. The safety output powers on at the beginning of a firing and off at the end of the firing. It is used to drive a safety relay that sends line power to the switching relays on outputs 1, 2, and 3. When using the optional current sensor, wiring one section to each output will give an Amp reading per section for better diagnostics. See Configuration in the controllers Menu for details on the output 4 options.

The Genesis Model LT1120 board has three 12V DC outputs. Two outputs are given power by a safety transistor, outputs 1 and safety. The safety transistor is capacitor coupled to the microprocessor so it only powers the output transistors when the microprocessor is operating correctly. All outputs are capable of driving a 500mA 12 V DC load. The maximum combined output of all outputs is 1 Amp. The safety output powers on at the beginning of a firing and off at the end of the firing. It is used to drive a safety relay that sends line power to the switching relays on output 1. When using the optional current sensor, wiring one section to each output will give an Amp reading per section for better diagnostics. See Configuration in the controllers Menu for details on the output 4 options.

FACTORY CONFIGURATION - "HIDDEN MENU"

The "hidden" menu allows programming of options that are normally set at the factory. The options are listed in the order they appear in the menu with a description. The "hidden" menu can be entered by pressing "MENU", scroll down to "Factory Configuration", and selecting "Factory Configuration". Then, type in the sequence 4, 4, 3, and the Factory Configuration options will be displayed. Use the scroll bar on the right to scroll through the options found below: **TC Type, Max Program Temperature, Max Board Temperature, SSR Mode, Cycle Time, Current Sensor Rating, Run Factory Diag., Rotate Display, Output Config., Mini Version, Lid Switch, and Output 3 Alarm.**

GENESIS (Model LT3140) & Genesis Mini (Model LT1120)

Technical Manual

TC Type

Change the thermocouple type used with the controller from Type K, Type S, or Type R. To change thermocouple type in Factory Configuration, select the thermocouple type being used with the controller and press “**Save**”. When changing from a Type K to a Type S or Type R, you must change the software setting as well as placing a jumper on the circuit board. To change from a Type S or Type R to a Type K requires changing the software setting and removing a jumper from the circuit board.

WARNING: Using a Type S thermocouple and a controller set for Type K will cause serious over-fire. Using a Type K thermocouple and a controller set for Type S will cause an under-fire. Type S thermocouples must use Type S extension wire. Type K thermocouples must use Type K extension wire. If changing thermocouple type be sure to change the extension wire. Make sure the software and jumper settings match the type of thermocouple and extension wire you are using.

Max Program Temperature

Enter the top temperature the kiln is rated for. Set the Max Program Temperature to the maximum temperature rating for the kiln. Check the side of the kiln or the kiln’s manual for its temperature rating. The max setting is 2400°F (1316°C).

Max Board Temperature

Set the maximum temperature the circuit board can reach. Valid temperature are 0 - 250°F. If the board reached a temperature higher than 250°F, it can cause serious damage to the circuit board.

SSR Mode

SSR Mode can be turned on when solid state relays are being used on the kiln. When SSR mode is turned on, it cycles the relays at 500 millisecond intervals. This works the same with either 60hz or 50hz systems.

Cycle Time

Sets the output cycle time. The cycle time is the length of time between an output coming on two consecutive times. If the cycle time is set for 14 seconds the output will come on every 14 seconds as needed. Cycle time can be set from 10 seconds to 60 seconds. To change the cycle time in the Factory Configuration Menu, press “5-Cycle Time”, type in the new time, and press “SAVE”.

Current Sensor Rating

The Current Sensor Rating is used to set the number of Amps that will generate a 5V output from a current sensor. Factory default is 50 Amps.

Run Factory Diag.

This is used by the kiln manufacturer. The factory diagnostics can be used for comparison when future diagnostics tests are ran. To view the amperages and voltages from the Factory Diagnostics test, press the “MENU” button, “1-Data Menu”, then “3-Factory Diagnostic” to view the results.

Rotate Display

When set to on, the display will rotate 180 degrees. To rotate the screen, press “On” and then press “Save”.

GENESIS (Model LT3140) & Genesis Mini (Model LT1120) Technical Manual

Output Config.

This setting should always be set on Standard, unless prior approval from your kiln manufacturer.

Mini Version

Use to switch screen formatting from larger Genesis screen to the smaller Genesis Mini screen. This setting should remain set to off for the LT3140 version.

Lid Switch

The Genesis LT3140 has connections for a lid switch. When a lid is connected and the lid switch setting is set to on, the controller shut power off to the elements, sound an alarm, and give a LID OPEN message when the lid is opened during a firing. When a lid is connected and this is set to off, the controller will continue to fire as scheduled, even when the lid is opened.

Output 3 Alarm

The Genesis Model LT3140, when in single zone mode and Output 3 Alarm is enabled, output 3 will turn on and off with the alarm. It is used by some to run a louder alarm.

PROGRAMMING NUMBER OF THERMOCOUPLES

Selecting the number of thermocouples is set up in the regular Menu. This allows one controller board to be used for single or multi-zone kilns (Genesis Model LT3140 Only). To program the number of thermocouples, press “MENU”, scroll down to “4-Configuration”, and select it. Scroll down to “5-Number of Zones” and select it. The Genesis Mini only has the option to be set to 1 zone. When using the Genesis, type in the desired number of zones (1, 2, or 3) and press “SAVE”. When programmed as a single zone board, TC1, TC2, and TC3 will all read the same temperature on the Home Screen. When in multi-zone mode, they will read the temperature for the corresponding thermocouple.

SINGLE ZONE (NUMBER OF THERMOCOUPLES IS ONE)

On the Genesis LT3140, the input T/C 2 is used when it is programmed for single zone control. All three outputs work in unison so there are two alternatives for connecting the output. All relays can be connected to output 2 or one relay could be connected to each output. The first method allows direct replacement of the current single zone controller without changing wiring. The second method would allow an easy upgrade to a multi-zone kiln in the future by just adding thermocouples and reprogramming the number of T/C's. The second method also allows for better use of the diagnostic routines.

On the Genesis Mini LT1120, there is only one thermocouple input on the controller.

3-ZONE (NUMBER OF THERMOCOUPLES IS THREE) – Genesis LT3140 Only**

T/C 1 is the top thermocouple, T/C 2 is the middle, and T/C3 is the bottom. Likewise, output 1 drives the top relay, output 2 the middle, and output 3 the bottom. For taller kilns, output 2 can control several middle sections.

2-ZONE (NUMBER OF THERMOCOUPLES IS TWO) - Genesis LT3140 Only**

When two thermocouples are selected, use inputs T/C1 and T/C2 and outputs 1 and 2.

GENESIS (Model LT3140) & Genesis Mini (Model LT1120) Technical Manual

FULL DIAGNOSTIC ROUTINE

The full diagnostic routine checks all the output voltages, the amperage or current draw of each section of the kiln, as well as the no load and full load kiln voltages. The amperage or current draw is used to measure the current draw of each section of the kiln. The diagnostic routines can only control each section separately if the outputs are wired for zone control. When checking the output voltages, the controller will turn on each section, starting with the top, for a few seconds. This allows checking to see if all elements are heating. The kiln voltages during load and without load are also measured. This helps to diagnose firing problems when the kiln is not able to reach a programmed temperature. First, it will read the voltages with the elements off, then the elements will come on momentarily and read the voltages again. To run a full diagnostics routine follow these steps:

1. Press the “MENU” button.
2. Press the “2-Diagnostics” button.
3. Press the “2-Run Manual Diag.” button and the controller will begin the diagnostics routine.
4. The controller will flash to the home screen and “CHK ALL” will be displayed across the firing banner. When the test is complete, it will return to IDLE.
5. To view the results, press the “MENU” button.
6. Press the “1-Data Menu” button.
7. Scroll down to “5-Last Manual Diag.” and select it.
8. Use the scroll bar to observe the results. You can use the Factory Diagnostics for comparison with your results. When you are finished press the “BACK” button.
9. To return to the Home Screen, press “HOME”.

VOLTAGE CALIBRATION

To display voltage using the Genesis controller, a calibration must be done. Before calibration, make sure the relays and elements are connected. To run the voltage calibration follow these steps:

1. Press the “MENU” button
2. Scroll down to the “6-Factory Config” button and select it.
3. Type in the sequence “4”, “4”, “0”, and press the “SAVE” button.
4. The screen will read, “Are you sure you want to calibrate the voltages?” If you are ready, press the “START” button to begin or “CANCEL” to return to the menu.
5. After the “START” button has been pushed you’ll be asked to enter the no load voltage. The No Load voltage will need to be measured and entered into the controller. Min: 0 Max: 999.
6. Once you’ve typed in the No Load voltage, press the “SAVE” button and the screen will change to the Full Load voltage screen, and the power to the elements will be turned on.
7. Measure the Full Load voltage and enter the value into the controller and press the “SAVE” button.
8. The screen will read Voltage calibration is complete. Press the “HOME” button to return to the home screen.

GENESIS (Model LT3140) & Genesis Mini (Model LT1120) Technical Manual

TECHNICAL SPECIFICATIONS

THERMOCOUPLE	TYPE K, S, and R (MAXIMUM RESISTANCE 100 OHMS)
ACCURACY	+/- 10°F
COLD JUNCTION COMPENSATION	ELECTRONIC
POWER INPUT	24V CENTER-TAP TRANSFORMER
OUTPUTS 1, 2, 3, 4, AND SAFETY	500 mA AT 12V; FIVE 12V RELAYS WITH 80 OHM COIL
OPERATING TEMPERATURE RANGE	0°F TO 125°F OR 0°C TO 52°C

PRECAUTIONS

This controller contains static sensitive parts, which can be damaged by static electricity. Use ground strap or touch a grounded object when handling this controller. Pack in anti-static treated material or paper. Do not pack in plastic bags or untreated packing.

This controller is a temperature-regulating device not a safety device. You should attend your kiln during firings.

GENESIS (Model LT3140) & Genesis Mini (Model LT1120)

Technical Manual

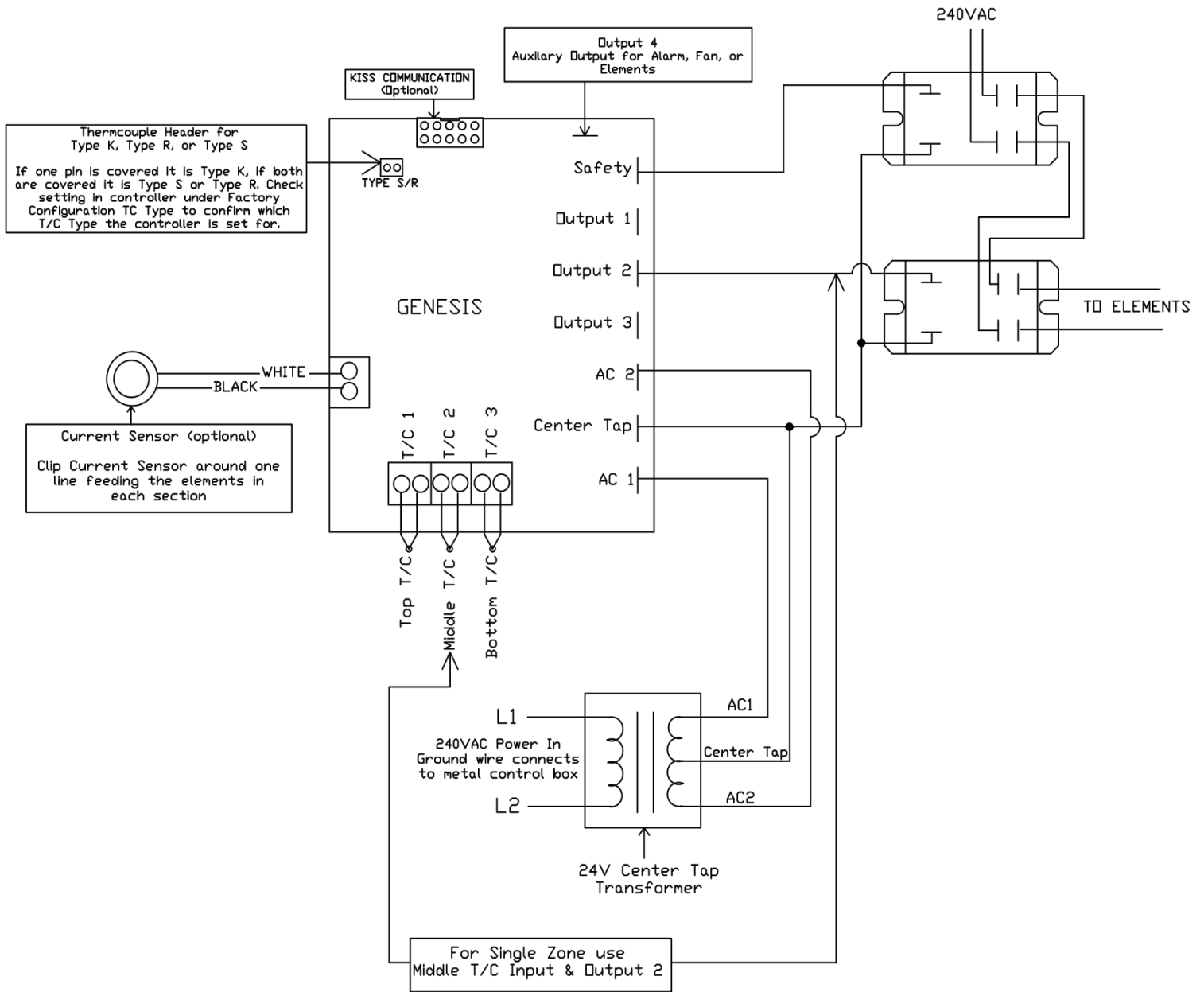

DAVINCI INSTRUCTION MANUAL

MAINTENANCE



L&L Kiln's patented hard ceramic element holders protect your kiln.

REGULAR MAINTENANCE OF YOUR L&L KILN

WATCH THIS VIDEO

This video shows you the basics of how to do routine maintenance on your L&L kiln:

hotkilns.com/maintaining-kiln

REGULAR KILN MAINTENANCE

To keep your kiln in top operating condition, we recommend the following minimum housekeeping:

AFTER EACH FIRING

1) Turn off the kiln at the circuit breaker or fused disconnect switch.

2) Check element holders and walls for glaze, clay chips or anything that could melt at a high temperature. If melted clay or glaze comes in contact with an element, a rapid failure could result. The molten material traps the heat radiating from the element and subsequently raises the surface temperature of the wire. The temperature will quickly pass the maximum recommended for the wire and burn it up. To clean holders, a good shop vacuum with a HEPA filter will handle dust and loose crumbs. A very gentle chisel or grinder may help with glaze contamination on element holders, but remember that the elements themselves are quite brittle when they are cool. Replace the contaminated holder if you can not clean it. Remove any glaze that has splattered on the firebrick or shelves. **(CAUTION: USE SAFETY GLASSES WHEN DOING THIS BECAUSE GLAZE CAN BE LIKE BROKEN GLASS)**. Vacuum afterward.

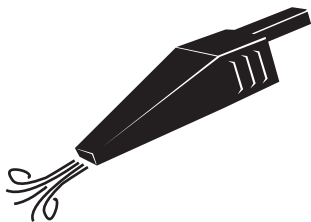

VACUUMING NOTE: It is possible to build up a strong static electricity charge when you are vacuuming. If this somehow manages to discharge into the control it can ruin the electronic circuit. Make sure the vacuum is grounded and periodically touch some grounded metal surface away from the kiln to discharge the energy.

3) Make sure the tops of the shelves are coated with kiln wash as it will keep running glaze from ruining the shelf. Some people also apply the kiln wash to the kiln bottom. Because this has both its benefits and drawbacks, we recommend that it only be done based on the kiln user's

individual preferences. (Do not coat the undersides or the sides of the shelves because you do not want the kiln wash to fall off into the kiln).

4) Keep a kiln log of firings. Tracking the performance of your kiln over time may turn out to be an extremely valuable tool if you ever need to diagnose future problems. Remember that you can easily get the firing time and final temperature at the end of the firing by hitting the Prog Review button if you have a DynaTrol. On the Genesis control you will see COMPLETE with the current temperature and firing time.

CAUTION: KILN WASH AND CLAY CONTAIN SILICA

1. Long term exposure to silica dust could cause lung damage.
2. See the MSDS sheets.
3. Exercise proper caution when mixing the dry powder and when removing it from your shelves.
4. Use a NIOSH approved particulate respirator for dust and use proper ventilation. You can buy these from safety supply houses. (NIOSH_approval #TC-21C-132 is an example).

AFTER 10 FIRINGS

1) Check temperatures of the main power cord at the main receptacle and the main kiln breaker while the kiln is at its hottest. If these are hotter than normal, it could be a sign of a loose or corroded connection, or possibly the wire gauge used in the power hook-up is the wrong size for the amount of current being drawn by the kiln. Immediately diagnose and fix this because it could cause a fire.

2) If you have a plug on your kiln, unplug it from the receptacle and check for oxidation, any burn marks, discoloration, or melted spots on the plug. If you see this replace the plug (and the receptacle) before using the kiln again. Make sure the receptacle feels tight when you press the plug into the outlet. A loose receptacle indicates worn springs, which will lead to overheating.

NOTE: An oxidation inhibitor can be used on the plug's prongs.

3) Check element resistance. You will need a digital multimeter (see the Troubleshooting Guide). Keep track of this information.

REGULAR MAINTENANCE OF YOUR L&L KILN

4) Check tightness of case and retighten if necessary. (the case will expand and contract during each firing and may eventually become loose. Brick also shrinks slightly with use - especially if used at the higher temperatures like cone 10).

5) Repair any firebrick problems.

6) If you have a manual kiln (or the Orton AutoCone backup on an automatic kiln) be sure it is properly adjusted. See the AutoCone instructions. Overfiring could result. The tube assembly should be replaced if it gets overly corroded or contaminated with condensed glaze or other materials. Orton recommends checking the pivot point for corrosion and sluggishness every 6 to 12 months.

AFTER 30 FIRINGS OR ANNUALLY

1) Check wires for deterioration or oxidation. Replace any that seem brittle or where the wire insulation has deteriorated or fallen off.

2) Check terminals for oxidation (discoloration). If you are near salt air or if you notice corrosion on the stainless exterior of the kiln for whatever reason then do this far more frequently.

3) Check power connection terminals in the kiln and control box for tightness. Be sure to do this with the power disconnected (unplugged) for the kiln. If these terminal connections get loose, heat can be generated (because the electrical resistance gets greater) and this can cause a fire.

CHECK THERMOCOUPLE CALIBRATION

Thermocouples will drift in reading over time. This could potentially lead to an overfiring before the thermocouple actually fails. Although you can not easily check thermocouple calibration, the general accuracy of the entire kiln system can be checked by firing with witness cones. See *troubleshoot-cones.pdf*.

Replace thermocouples once they are no longer reasonably accurate. (Note: Type K thermocouples last about the same as kiln elements so it is recommended to change thermocouples when you change elements.)

See hotkilns.com/calibration for more complete step-by-step instructions on how to calibrate your kiln.

DAVINCI INSTRUCTION MANUAL



L&L Kiln's patented hard ceramic element holders protect your kiln.

GENERAL DIMENSION DRAWING

BEFORE YOU START ASSEMBLY

An up-to-date General Dimension Drawing for your specific model can be normally be found on our website. These drawings provide important information on ventilation and installation requirements and will also help you visualize how to assembly your new kiln.

Special Models

Some special or custom models may not have a general dimension drawing but this is rare.

TO FIND YOUR DRAWINGS

1. Find your kiln model on our website (hotkilns.com)
2. Click on the General Dimension Diagram button.

L&L KILN SERIES: Easy-Fire Pottery Kilns



e23T-3 Pottery Kiln

Flagship Multi-Purpose Kiln

KEY SPECS

Polyagonal Kiln
Medium (6.7 cubic feet)
DynaTrol Zone Control
Cone 10, 2350F, 1290C

\$4275

LEAD TIME: 8 to 12 Weeks

WHERE TO BUY

[PDF Brochure](#) [General Dimension Diagram](#)

Model e23T-3 Easy-Fire Automatic Kiln with Multi-Program Three-Zoned DynaTrol mounted in an easy-open cool-firing piggy-back control panel that is angled for easy viewing of control. Kiln comes with hard ceramic element holders, protected thermocouples, strong solid-top stand, easy-lift spring hinge, and solid peephole plugs. 22-3/8" diameter by 27" high (6.7 cubic feet). 3" K23 brick, NEMA 6-50 single phase or 15-50 three phase 6 foot power cord included. C-MET-us listed in the USA & Canada. Cone 10 for all voltages. For export: see Crating Charges and Export Options in the Accessories Tab for crating charges.

AN EXAMPLE (of a typical e23T-3 kiln)

Each model has its own General Dimension Drawing so yours will look different. The format is generally the same as shown below.

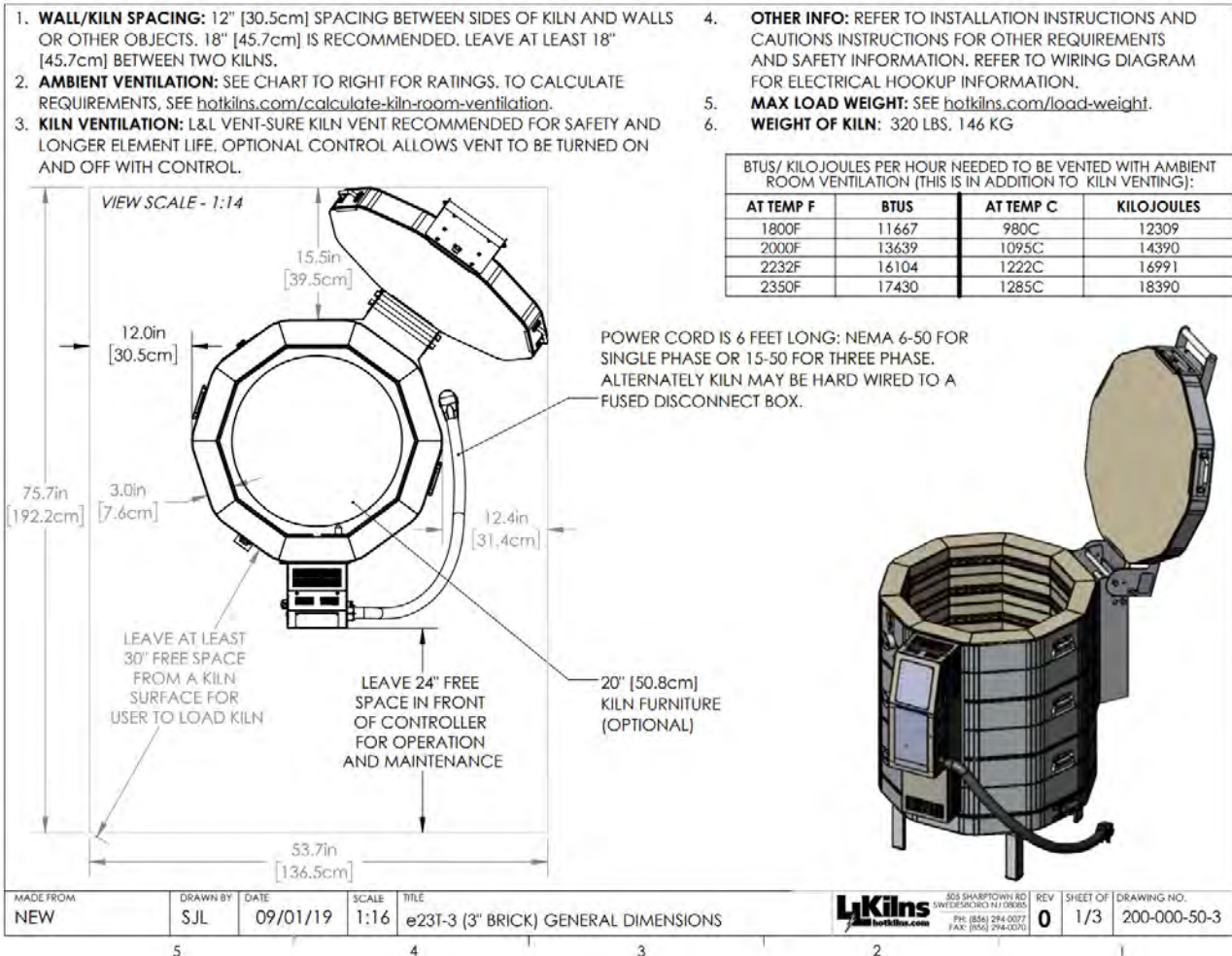

INSTALLING YOUR L&L KILN

TABLE OF CONTENTS

CAUTIONS	1
DATED INFORMATION.....	1
SAFETY APPROVALS & LISTINGS.....	1
LOCAL CODES.....	1
MET LISTING TO UL STANDARDS.....	1
NATIONAL ELECTRICAL CODE.....	1
NATIONAL FIRE PROTECTION ASSOCIATION	1
UNIFORM MECHANICAL CODE	1
CLEARANCES & SURFACES.....	2
CLEARANCES IN KILN ROOM	2
WALL MATERIALS.....	2
FLOORS	2
USE THE SUPPLIED KILN STAND	2
OTHER CLEARANCES.....	2
KILN ROOM ENVIRONMENT.....	3
KEEP KILN DRY & IN PROTECTED SPACE.....	3
AMBIENT TEMPERATURE	3
SURFACE IS HOT AND CAN CAUSE BURNS	3
FIRE EXTINGUISHER.....	3
FIRE SPRINKLERS	3
KILN ADJUSTMENTS.....	3
LEVELING THE KILN.....	3
ADJUST THE HINGE PROPERLY	3
THERMOCOUPLES.....	3
VENTILATION REQUIREMENTS.....	4
VENTILATION IS ESSENTIAL.....	4
VENTILATION FOR THE KILN.....	4
CARBON MONOXIDE MONITORING.....	4
VENTING CODES	4
HVAC AND AIR CONDITIONING ISSUES	4
ELECTRICAL INSTALLATION.....	5
VOLTAGE	5
HOOKING UP TO POWER	5
DIRECT HOOK UP KILNS	5
INSTALLING A PLUG RECEPTACLE	5
PROTECT POWER CORD FROM KILN CASE	5
USE A FUSED DISCONNECT.....	5
LOCATE KILN WITHIN 50 FEET OF BREAKER.....	5
FUSING YOUR CIRCUIT	5
USE PROPER GROUNDING.....	5
USE THE PROPER WIRE GAUGE.....	6
USE COPPER WIRE FOR HOOK UP.....	6
DIRECT HOOK-UP	6
DO NOT USE EXTENSION CORDS.....	6
OFF-PEAK ELECTRICAL USAGE	6
WHERE TO GET MORE INFORMATION.....	6
ELECTRICAL SPECIFICATIONS	6

CAUTIONS

See the CAUTIONS section of the Instruction Manual. (or hotkilns.com/cautions)

DATED INFORMATION

The information in these installation instructions is believed to be correct to the best of our knowledge at the time of publication (see the date at the bottom). You can download the most recent update from our web site at hotkilns.com/install.pdf at any time.

SAFETY APPROVALS & LISTINGS

LOCAL CODES

Local fire and safety codes supersede information that is provided in these installation instructions or in our caution instructions.

MET LISTING TO UL STANDARDS

Many but not all kilns are listed to UL 499 Standards for both the US and Canada by MET (An NRTL - Nationally Recognized Testing Laboratory). The Vent-Sure vent is listed in both the US and Canada for use with L&L listed kilns. UL 499, CSA C22.2, No. 122, CSA C22. Listing No E112742. If your kiln is listed it will have a listing mark on the data nameplate and on the wiring diagram. You can also check hotkilns.com/met.

NATIONAL ELECTRICAL CODE

Be sure your electrician follows the National Electric Code and any other local requirements when hooking up the kiln. **One of the requirements of this code that bears particular mentioning is the fact that you must fuse your kiln appliance for 125% of its rated maximum amperage draw.** This explains why you see fusing requirements in our electrical specifications that is in excess of the amperage draw of the kiln. The fuse for the kiln is either a circuit breaker or a fused disconnect switch.

NATIONAL FIRE PROTECTION ASSOCIATION

To the best of our knowledge, the NFPA has nothing specific about the installation of kilns. The NFPA 86 goes into considerable detail about industrial furnaces and ovens but generally with respect to internal processes and gas-fired equipment. There is one section in the NFPA 86 (Section 2-1.5 concerning Floors and Clearances) that might be construed as applicable to kilns. It requires that temperatures at combustible ceilings and floors be kept below 160°F (71°C). In general the NFPA recommends installing furnaces on noncombustible surfaces and has specific requirements if this is not possible. You can order a copy of this by going to their web site at www.nfpa.org or by calling 617-984-7249.

UNIFORM MECHANICAL CODE

Section 920.0 specifically discusses Small Ceramic Kilns and their installation. Some of the clearance information from this is given further on. However, it is best to refer to this book for complete details. This is published by the International Association of Plumbing and Mechanical Officials and can be purchased online at iapmmembership.org.

INSTALLING YOUR L&L KILN

CLEARANCES & SURFACES

GENERAL DIMENSION DRAWINGS

You should download the General Dimension Drawing for your particular kiln model from our website. There is a button on each kiln model page. This will give you all of the dimensions and clearance information you need as well as BTU ratings for HVAC design.

CLEARANCES IN KILN ROOM

L&L strongly recommends an 18" clearance to all walls.

Make certain floor is not flammable.

The Uniform Mechanical Code 2000 Edition states that "the sides and tops of kilns shall be located a minimum of eighteen (18) inches (457 mm) from any noncombustible wall surface and three (3) feet (914 mm) from any combustible wall surface."

The National Fire Protection Agency states that temperatures at combustible ceilings and floors be kept below 160 Deg F (71 Deg C) near industrial furnaces (which are like kilns).

Note that, when L&L tested kilns for UL, temperatures were measured 12" from the walls of the kiln and found to be safe from a flammability standpoint. However, locating a kiln just 12" from a wall may violate the Uniform Mechanical Code and possibly local fire codes so do this at your own risk.

WALL MATERIALS

Check with local building codes for recommended non-combustible wall materials for walls that are adjacent to the kiln. Cement board, cinder blocks, and masonry tile are possible choices.

FLOORS

The Uniform Mechanical Code 2000 Edition states that "kilns shall be installed on noncombustible flooring consisting of at least two (2) inches (51 mm) of solid masonry or concrete extending at least twelve (12) inches (305 mm) beyond the base or supporting members of the kiln."

Recommended floor surfaces are cement, ceramic tile, stone, slate, cinder blocks or brick. Do not install on a wood floor or on carpet. Vinyl flooring may be combustible. Protect linoleum flooring from discoloration with a noncombustible covering.

BE VERY CAREFUL ABOUT IMPLEMENTING THESE SUGGESTIONS. Remember that the kiln is putting out heat

over a long period of time and that this could very well start a fire under certain conditions. Also, if an overfiring occurs, materials like glass and glazes can be super-heated and electrically conductive, and they can melt right through the kiln floor. If there is a combustible floor, this could cause a fire. Also keep in mind the continued heat of the kiln can dry out combustible surfaces over time and reduce their flash point.

The NFPA 86 (Section 2-1.5 concerning Floors and Clearances) that might be construed as applicable to kilns requires that temperatures at combustible ceilings and floors be kept below 160°F (71°C). In general the NFPA recommends installing furnaces on noncombustible surfaces and has specific requirements if this is not possible.

USE THE SUPPLIED KILN STAND

Do not use kiln without the factory supplied stand.

L&L stands typically raise the floor of the kiln by 8" (20 cm).

It is CRITICAL to have air circulation under the kiln. This prevents heat from being directly conducted to the floor surface. If the floor (or subfloor) is combustible a fire could result. Even if the floor is non-combustible (like solid cement) you would create a very inefficient system by placing the kiln directly on the floor.

Using a proper stand is critical because, without a kiln stand that moves the radiant heat of the kiln away from the floor, some flooring could catch on fire. For instance, over time the radiant heat from the kiln can cause wood to lose its moisture and lower the auto ignition temperature. (The auto ignition temperature is the specific temperature at which a substance ignites and causes a fire.)

OTHER CLEARANCES

Make sure there is adequate clearance in the room for opening the kiln lid, and for periodic maintenance such as opening the element connection boxes, opening the control panel, thermocouple replacement, etc. 18" to 24" clearance around the outside wall of the kiln is usually sufficient.

Combustible surfaces that stay below 71°C (160°F) are generally considered safe from the point of view of starting a fire. However, this is a maximum and we recommend keeping surface temperatures near the kiln under 52°C (125°F).

INSTALLING YOUR L&L KILN

KILN ROOM ENVIRONMENT

KEEP KILN DRY & IN PROTECTED SPACE

The kiln must be kept dry so it must be kept in an enclosed room away from inclement weather. The electrical circuits must not get wet. If for some reason they do get wet they must be thoroughly dried before operating the kiln. Kilns can corrode fairly rapidly if kept in rooms that have no climate control. The constant heating and cooling in an unheated shed, for instance, can cause dew to form on the cold metal and this can cause corrosion. Also exposure to salt air will accelerate corrosion dramatically. Also failure to adequately vent the kiln will allow the corrosive fumes that are generated in the firing process to corrode the metal, the wiring and even the firebrick. This sort of damage is specifically excluded from warranty coverage.

AMBIENT TEMPERATURE

The kiln should operate in an environment that is between 0°F and 100°F. Some people keep their kilns in unheated garages or sheds. This is OK as long as the room is dry. The DynaTrol and Genesis have a specification that says it can work from 32°F to 125°F. These limits can be exceeded on the low end. (The control won't deal with negative numbers so if you go below 32°F you must have the control set up for Deg F - not Deg C) On the low end it has more to do with the accuracy of the control. As the kiln reaches the point where accuracy is an issue then the control will most likely be warmed sufficiently by the kiln to insure that it is operating within specification. However, on the high end, the electronics could degrade if operated for long periods above 125°F.

SURFACE IS HOT AND CAN CAUSE BURNS

Kiln surface can be extremely hot: up to 260°C (500°F). Display a sign near the kiln that warns everyone of how hot the kiln is.

FIRE EXTINGUISHER

We recommend that an adequate fire extinguisher be kept near the kiln and checked on a regular basis. You may want to check with your local fire authorities to see if there are any specific requirements they have such as sprinkler systems, automatic foam extinguishers, etc. **Use a fire extinguisher that is rated for electrical fires. We recommend an ABC fire extinguisher.**

FIRE SPRINKLERS

If you have a sprinkler system be careful to check the temperature rating and location of the heads so that you

do not inadvertently cause them to actuate under normal firing conditions.

Position the sprinkler heads in the ceiling away from the kiln(s). The rising heat from the kiln, under normal operating conditions, could set off the sprinklers which will cause water damage. Use the highest temperature rating on your sprinkler heads that is allowed by code. Or consider using a higher one that is set off by smoke.

Be sure to monitor temperature while the kiln is at its highest firing temperature and conditions are at their worse (for instance when the door to the kiln room is closed or the ventilation fan is turned off).

Serious damage to the kiln and your premises can take place if the sprinkler system goes off when the kiln is at high temperature - especially if no one is in the building when it happens.

KILN ADJUSTMENTS

LEVELING THE KILN

Level the kiln while you are installing it. Use thin metal shims under the legs to accomplish the leveling (never wood or other combustible materials). Some kilns have leveling bolts or pads. Make sure that the base will not wobble.

ADJUST THE HINGE PROPERLY

See the assembly instructions for your specific kiln. (Assembly instructions are available at hotkilns.com/assembly-instructions) The hinge of any kiln must be adjusted so that expansion caused by the heating process has room to expand up and down. (L&L includes expansion slots in the hinges.) (This only applied to top loading kilns.)

THERMOCOUPLES

Thermocouples must be inserted into the kiln at least 1" (2.5 cm) in from the inside surface of the kiln. They must protrude into the kiln itself because, if the measuring tip of the thermocouple is buried inside the insulation, the thermocouple will measure a lower temperature than the actual temperature in the kiln. This could cause an overfire of the kiln.

NOTE: Replace thermocouples once they are no longer reasonably accurate. (Note: Type K thermocouples last about the same as kiln elements so it is recommended to change thermocouples when you change elements.)

If you have taken the kiln apart carefully observe the thermocouple polarity and zone placement. See the

INSTALLING YOUR L&L KILN

DynaTrol instructions in your manual or hotkilns.com/tc-polarity.

VENTILATION REQUIREMENTS

VENTILATION IS ESSENTIAL

Kilns generate harmful fumes when firing ceramics. Fumes can include carbon monoxide, formaldehyde, sulfur dioxide, heavy metal vapors, and fluorides (all of which can be very toxic). Install kiln in well-ventilated area.

Never operate in an enclosed space such as a closet unless you have good ventilation. Aside from issues of ventilating the fumes from the firing, the heat build up in an enclosed room could present a significant fire hazard.

Severe corrosion can be caused by kiln fumes, salt air or other environmental conditions. Good venting can minimize these problems.

Ventilation must be to the outside. We recommend room ventilation of at least 25-50 times the cubic feet of the kiln per minute. For example, if a kiln has 10 cubic feet then 250 to 500 CFM should be adequate. See hotkilns.com/calculate-kiln-room-ventilation for a more precise method of calculating heat removal requirements. Our suggestion is to get a variable speed fan for ambient room ventilation and keep a thermometer on the wall. That way you can vary the ventilation to suit the needs of ambient heat conditions in the room.

VENTILATION FOR THE KILN

In addition, we recommend our VENT-SURE downdraft kiln vent system. This will take care of most of the venting of the fumes of the kiln, will improve uniformity of firing in the kiln, and will help maintain the oxygen level in the kiln (which is important for certain glaze effects as well as good element life). See the separate instructions in this book for the VENT-SURE vent system. Although you can use other kiln venting systems please note that the VENT-SURE is c-UL-us listed for use with L&L listed kilns. If UL listing is an issue then you may want to ensure that another brand of vent will be acceptable to your local authorities. Also if you use another brand of vent be sure to check with the vent manufacturer for specific installation requirements with our specific kiln model. See hotkilns.com/vent-sure for more information

CARBON MONOXIDE MONITORING

We recommend the use of a carbon monoxide monitor in your kiln room.

VENTING CODES

The following information is provided courtesy of The Edward Orton Jr. Ceramic Foundation.

OSHA has set standards for carbon monoxide exposure of 35 ppm (parts per million) for long-term exposure and 200 PPM for short-term exposure. Independent testing has shown that fumes near the kiln can exceed 200 PPM near the kiln during the firing of greenware. This can cause headaches, fatigue, sore throats and nausea. When properly installed and operated, a downdraft vent removes all harmful fumes and provides a safer working environment.

Most states and localities have set venting requirements for firing kilns in public places. Your local and state health board should have this information. The Uniform Mechanical Code says that you must vent ceramic kilns. It says that you can use a canopy-type hood (and gives specific requirements for such use) or that "listed exhaust blowers may be used when marked as being suitable for the kiln and installed in accordance with manufacturer's instructions." Our Vent-Sure vent is UL listed and is appropriate to meet this ventilation requirement. If you decide to use a vent other than the UL listed Vent-Sure vent make sure you check with the manufacturer of the vent to be certain that it is an approved application. L&L takes no responsibility for improperly installed vents or kilns nor do we take responsibility for the use of other vents with our kilns. The manufacturer of the vent must specifically approve it for use with our kiln.

Note about canopy type vent hoods: While canopy type vent hoods can be suitable for venting a kiln from a safety point of view, they will not give you the superior advantages of a downdraft type vent like our Vent-Sure. A downdraft type vent pulls the rising hot air down to the bottom of the kiln which helps even out the firing. In addition it provides uniform distribution of oxygen in the kiln.

HVAC AND AIR CONDITIONING ISSUES

Kilns put out a lot of ambient heat. If you need to size HVAC units to handle this see the chart below. This shows the BTU output if the kiln was held at these temperatures under steady-state conditions (which is rarely the case for a ceramic kiln). Typically it would never be worse than what is shown in the this chart which makes this a safe figure to use for sizing HVAC systems.

You can download charts of BTU outputs for most L&L kilns at hotkilns.com/btu.

Voltage is not an issue with regards to BTU output.

INSTALLING YOUR L&L KILN

ELECTRICAL INSTALLATION

VOLTAGE

L&L makes different configurations for 208 volts, 220 volts, 240 volts, 380 volts and 480 volts.

It is important that the kiln be hooked up to the proper voltage. 208 volt kilns hooked up to 240 volt power supplies will generate too many amps. 240 volt kilns hooked up to a 208 volt power supply will heat up about 25% slower than they should and may not reach the higher temperatures. Although it is possible to hook a single phase kiln to two legs of a three phase supply it will cause an unbalanced load on your electrical supply. **CHECK WITH A QUALIFIED ELECTRICIAN.** It is best to get a three phase kiln for a three phase power supply.

In addition to the power wires there is, on all L&L kilns, a ground wire. The ground wire is not used as a neutral (i.e. no electricity normally flows through the ground). **BE SURE TO GROUND THE KILN PROPERLY USING THE GROUND WIRE. AN UNGROUNDED KILN IS A DANGEROUS KILN.** Also it is important for the control operation to have a good earth ground as well (to get rid of electrical noise).

HOOKING UP TO POWER

Most L&L kilns under 48 amps include either a 6-50P plug (for single phase kilns) or a 15-50P plug (for three phase kilns). See the specification sheet or wiring diagram to be sure.

Have your electrician install the proper receptacle (if you are using a plug) and safety switch at your kiln location. Be sure that your fuse ampere capacity is enough to carry the electrical load required. Also, ensure that your power lines are heavy enough to carry the required electrical load. If this is being used in an industrial or institutional setting be sure to follow lock out/tag out requirements and procedures.

DIRECT HOOK UP KILNS

All kilns over 48 amps are direct hook-up. This means an electrician needs to install a conduit (rigid or flexible) from the fused disconnect or circuit breaker panel to the kiln. Some kilns under 48 amps are also direct hook up.

CHANGING TO DIRECT HOOK-UP

All L&L power cords are rated for 105°C. Anything less than this can cause a malfunction and possible fire where the power leads connect to the control box.

It is OK, and will not void the warranty, to remove the plug that comes with the kiln and direct wire the kiln. However,

the connection wires must be rated for a minimum of 105°C.

INSTALLING A PLUG RECEPTACLE

If your kiln comes with a plug, install the receptacle in such a way that the cord hangs down (not up). Do not place the outlet so close to floor that the kiln cord bends up at a sharp angle. The principle to pay attention to is make sure the plug seats securely in the receptacle. Otherwise it could overheat and corrode which could cause an electrical fire.

PROTECT POWER CORD FROM KILN CASE

If you have a flexible cord, route cord away from kiln in such a way that it can not touch the hot case of the kiln. Secure it so it can not move. If cord touches the hot case it could melt and cause a short circuit and/or fire.

USE A FUSED DISCONNECT

We recommend having a separate fused disconnect box with a lockout provision mounted near the kiln, even if you also have a separate circuit breaker for your kiln. This way you can easily turn off power to the kiln and prevent unauthorized people from turning it on. We recommend this even for kilns with plugs because it makes it so much easier to disconnect all power to the kiln when not using it. Note that if you unplug a kiln frequently the spring tension in the outlet can weaken over time. A Fused Disconnect switch allows you to positively turn off power to the kiln without unplugging it.

LOCATE KILN WITHIN 50 FEET OF BREAKER

Try to locate the kiln within 50 feet of your breaker box. For longer runs you will probably have to increase the size of the hook up wire that we recommend in our literature. In any case, be sure to have a licensed electrician who knows the National Electrical Code hook up the kiln and size the hook up wire.

FUSING YOUR CIRCUIT

Be sure your electrician follows the National Electric Code and any other local requirements when hooking up the kiln. The full load amps is listed on the data nameplate of the kiln. **CHECK WITH A QUALIFIED ELECTRICIAN.**

USE PROPER GROUNDING

Make sure your electrician properly grounds the kiln and then tests for proper grounding after the installation. All electrical appliances should be properly grounded. This can be to either a cold water pipe or proper system ground

INSTALLING YOUR L&L KILN

in your building. If there is ever a short circuit (where the electricity flows through to the case or control panel and where you might touch it) you could be electrocuted if the kiln is not grounded. This is especially important with the high voltage used on kilns. The higher the voltage the more easily it could flow through your body. In addition, because of the heat generated in a kiln, wires are subject to potential deterioration over time and expansion and contraction can move insulators and cause short circuits. **BE SURE TO REPLACE ANY DETERIORATED WIRES!**

USE THE PROPER WIRE GAUGE

Hook-up wire sizes are provided for many of our kilns in the electrical specifications. However, this can vary depending on ambient temperature conditions and length of wire run.

Running power for your kiln over a long distance will result in a drop in voltage. This chart gives some approximate idea of this:

7 volts per 100 feet with 10 awg wire

21 volts per 300 feet with 10 awg wire

6 volts per 100 feet with 6 awg wire

18 volts per 300 feet with 6 awg wire

3 volts per 100 feet with 1 awg wire

9 volts per 300 feet with 1 awg wire

These estimates are dependent on the kiln operating at 50% to 100% of its capacity, with the temperature of the wire no more than 167°F.

USE COPPER WIRE FOR HOOK UP

Don't use aluminum wire. It is cheaper to use aluminum wire and you may be tempted to do so. Many electricians will tell you that, with the new types of connectors, it is OK. However, it is of particular importance with kilns not to use aluminum wire for the hook ups. The specific reason particular to kilns is that the wire tends to get hotter near the kiln than it might going into some other types of appliance. Also, being a resistive load, there is constant heat being generated by the conductors. When aluminum wire gets hot it accelerates oxidation. Aluminum oxide is a resistor; copper oxide is not as much. If the connection at the terminal board gets oxidized it will really heat up - to the point where it could cause a fire. Braided copper wire is preferred.

DO NOT USE EXTENSION CORDS

Extension cords are only OK to use for the 120 volt vent system. Do NOT use an high power extension cord for the kiln.

OFF-PEAK ELECTRICAL USAGE

Some utilities offer special rates for running energy intensive appliances (like kilns) during off-peak hours. Check with local utility. This would require a special time-of-use electrical meter.

WHERE TO GET MORE INFORMATION

See hotkilns.com/volts for a complete description of electrical theory, fusing, hook-up wire sizes, etc. as they apply to kilns or, for a more basic description, at hotkilns.com/basic-electric-kilns.

ELECTRICAL SPECIFICATIONS

See your wiring diagram and data nameplate for voltage and amperage requirements.

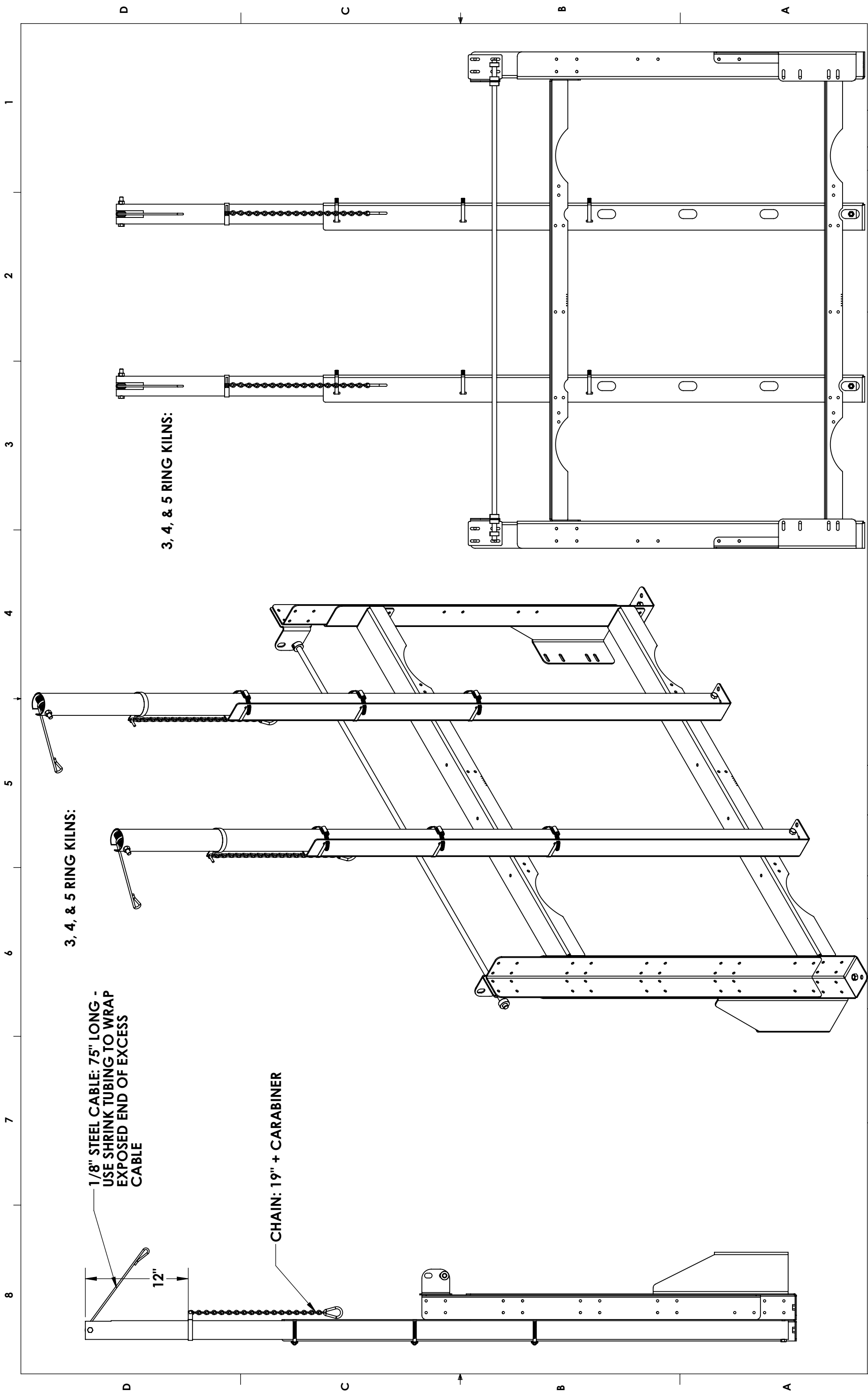

1/8" STEEL CABLE: 75" LONG -
USE SHRINK TUBING TO WRAP
EXPOSED END OF EXCESS
CABLE

CHAIN: 19" + CARABINER

3, 4, & 5 RING KILNS:

3, 4, & 5 RING KILNS:

THE INFORMATION CONTAINED IN THIS DRAWING IS THE SOLE PROPERTY OF
L&L KILN MFG INC. ANY REPRODUCTION IN PART OR AS A WHOLE WITHOUT
THE WRITTEN PERMISSION OF L&L KILN MFG INC. IS PROHIBITED.

FILE NAME
C:\Users\dimit\Kiln
Dropbox\Engineering\AAA -
Dav\Incl

MADE FROM
NEW

DRAWN BY
DSL

DATE
2/11/21

SCALE
1:10

TITLE

DAVINCI T34 COUNTERBALANCE ASSEMBLY

505 SHARPTOWN RD
SWEDSBORO NJ 08085
Lilkins
lilkins.com
PH: (856) 294-0077
FAX: (856) 294-0070

REV SHEET OF DRAWING NO.
B 1/2 300-410-60

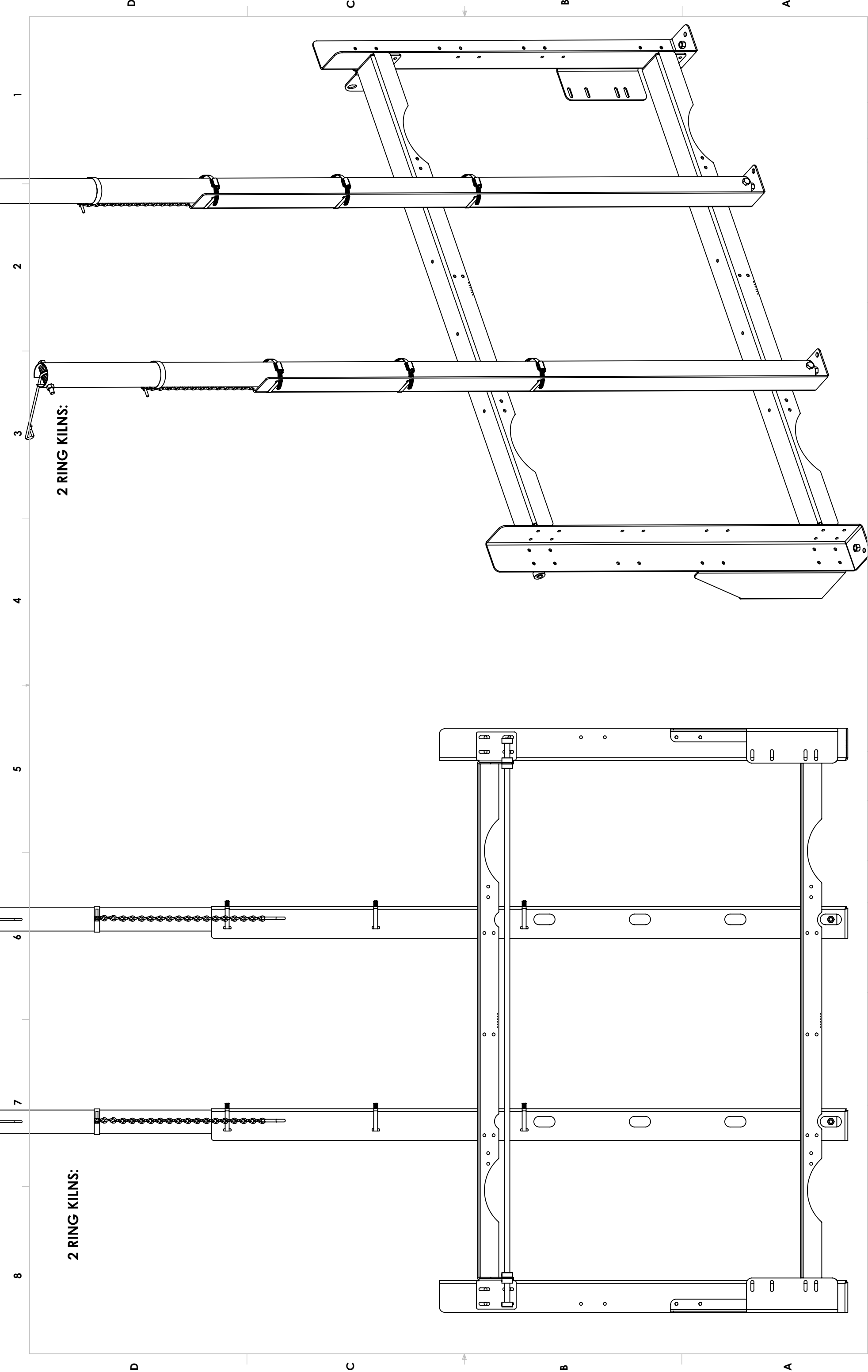

2 RING KILNS:

2 RING KILNS:

THE INFORMATION CONTAINED IN THIS DRAWING IS THE SOLE PROPERTY OF L&L KILN MFG INC. ANY REPRODUCTION IN PART OR AS A WHOLE WITHOUT THE WRITTEN PERMISSION OF L&L KILN MFG INC. IS PROHIBITED.

ALL TOLERANCES
(±0.01in)
UNLESS SPECIFIED

DRAWN BY DATE
DSL 10/21/21

SCALE 1:13

TITLE

DAVINCI T34 COUNTERBALANCE ASSEMBLY

505 SHARPTOWN RD
SWEDESBORO NJ 08085
L&L Kilns
l&lproducts.com
PH: (856) 294-0077
FAX: (856) 294-0070

REV SHEET OF DRAWING NO.
B 2/2 300-410-60

1 2 3 4 5 6 7 8

D

C

B

A

1 2 3 4 5 6 7 8

DAVINCI INSTRUCTION MANUAL



L&L Kiln's patented hard ceramic element holders protect your kiln.

L&L DAVINCI KILN ASSEMBLY INSTRUCTIONS

WHEN YOUR KILN ARRIVES

Depending on the model and accessories, your kiln will arrive on two or three crated skids. If the skids were damaged in transit, you should either refuse shipment or unpack the kiln in the drivers presence in order to file a damage report with the freight company. Call our office. See ship-inspect.pdf in the front of the instruction book. Inspect for damage!

UNPACK THE CRATES

Carefully remove and dispose of the crating boards on the crated skids. One of the crates contains the kiln stand, kiln counterbalance, kiln control panel as well as any additional accessories you may have ordered. The other skid or skids contain the individual kiln sections stacked in reverse order so they can be set up in the proper order, as well as the kiln top or lid, the kiln bottom or floor and the aluminized plate that sits between the floor and the kiln stand.

SET UP THE STAND AND BOTTOM

Remove the kiln stand and place it on the floor in desired location. See CAUTIONS and INSTALLATION in this instruction manual for more detailed information on codes, ventilation requirements, clearances, etc.

Place the flat aluminized plate and the floor of the kiln on top of the kiln stand. Note that the aluminized plate is packed directly under the kiln floor. This enables you to move both pieces to the kiln stand as one unit. Make sure that the plate and the floor sit flush on the stand. Make certain it is centered properly. If a vent is supplied to be mounted to bottom make sure this is attached now.

LEVEL THE KILN! This is important because the Dawson Kiln Sitter is affected by gravity. If the kiln is not properly leveled the Kiln Sitter might be either too reactive or too sluggish. **ALSO IF KILN IS NOT LEVELED THIS COULD LEAD TO THE CRACKING OF THE BOTTOM AND THE TOP**

STACK SECTIONS ON BOTTOM

Notice that each of the two (or more) kiln sections have numbered power cords (referred to as element box jumper cords). The top kiln section will always be # 1. The bottom kiln section will be # 2 on a 2 section kiln, # 3 on a 3 section kiln, etc. Now stack the kiln sections in proper order.

KILN DOOR PLACEMENT

Remove the hinge bar and its hardware and set aside.

Place the kiln door/top squarely on top of the top kiln section. Notice that the door is slightly larger than the kiln section. Space the door as evenly as possible, this will help you later when attaching your counterbalance.

ATTACH COUNTERBALANCE

Remove the sixteen screws that are in the bottom and third from the bottom kiln sections. (These screws are in the top and bottom sections on a two section kiln). These screws will be used to attach the counter-balance arms to the kiln. Maneuver the counter-balance into position lining the holes in the kiln sections up with the holes in the counter-balance arms. If you can not get the holes to line up you must adjust the stacked kiln sections appropriately. Now replace the sixteen screws.

ASSEMBLE DOOR AND HINGE

As gently as possible, position the kiln lid so that the oblong holes in the counter-balance pipe plates line up with the round holes in the lid side channels. The counter-balance pipe is factory set so that the round bar sit at the bottom of the oblong hole of the pipe plate. This is important as it allows the kiln lid to pivot as well as rise as the kiln heats and the brick expands.

ATTACH DOOR TO SPRING CABLE

If necessary, turn the spring tubes so that the opening where the cable comes out at the top of each tube is facing the front of the kiln. Tighten the cable clamps that hold the spring tube to the angle. (These have been loosened for shipping).

If necessary, position the spring tube safety brackets so that they are facing towards the back of the kiln.

Lift the door and attach the safety chains to the eyebolts at each side of the kiln door.

Open the oval connectors and connect the cable from the tubes to the cable adjusters that are already on the eyebolts on the front of the door.

SET UP CONTROL PANEL

Set your control panel on the right side of your kiln.

L&L DAVINCI KILN ASSEMBLY INSTRUCTIONS

ATTACH THERMOCOUPLES

Each of the thermocouple lead wires are numbered to correspond with the location of the thermocouple on the kiln. The number 1 thermocouple lead wire must be attached to the top thermocouple. The number 2 thermocouple wire will attach to the bottom kiln section thermocouple on a two section kiln or the middle kiln section thermocouple on a three or more section kiln. If not done correctly, your kiln will not operate properly.

To attach the thermocouple lead wire, simply screw the red wire to the negative terminal of the thermocouple and the yellow wire to the positive terminal of the thermocouple. (You can see a “-” mark and a “+” mark embedded in the ceramic terminal).

Before firing your kiln, make sure the thermocouple lead wires are not touching the kiln. If these wires burn, your control will not operate properly.

PLUG IN KILN SECTIONS

Now you can plug your element box jumper cords into the appropriate receptacles. Start at the top section. The element box jumper cord should be numbered 1, and plugged into the #1 receptacle. The TC lead wire on the top section of the kiln must be numbered 1. Repeat these steps for the remaining kiln sections.

FINAL STEPS

INSTALL VENT

If your kiln is equipped with a vent fan exhaust tubing to outside. See separate vent instructions in the instruction manual.

HOOK UP ELECTRIC POWER

See the wiring diagram for electrical specifications. All Davinci Kilns are direct wired.

READ CAUTIONS

DO NOT PROCEED WITHOUT READING AND UNDERSTANDING THE CAUTIONS IN THE OPERATIONS SECTION.

VACUUM KILN

Vacuum the kiln before using it (with power disconnected from kiln).

FIRST TEST FIRING

You are now ready for your test firing: See the main instructions in the OPERATION section.

DAVINCI INSTRUCTION MANUAL

VENT



L&L Kiln's patented hard ceramic element holders protect your kiln.

L&L VENT-SURE DOWNDRAFT KILN VENT INSTRUCTIONS

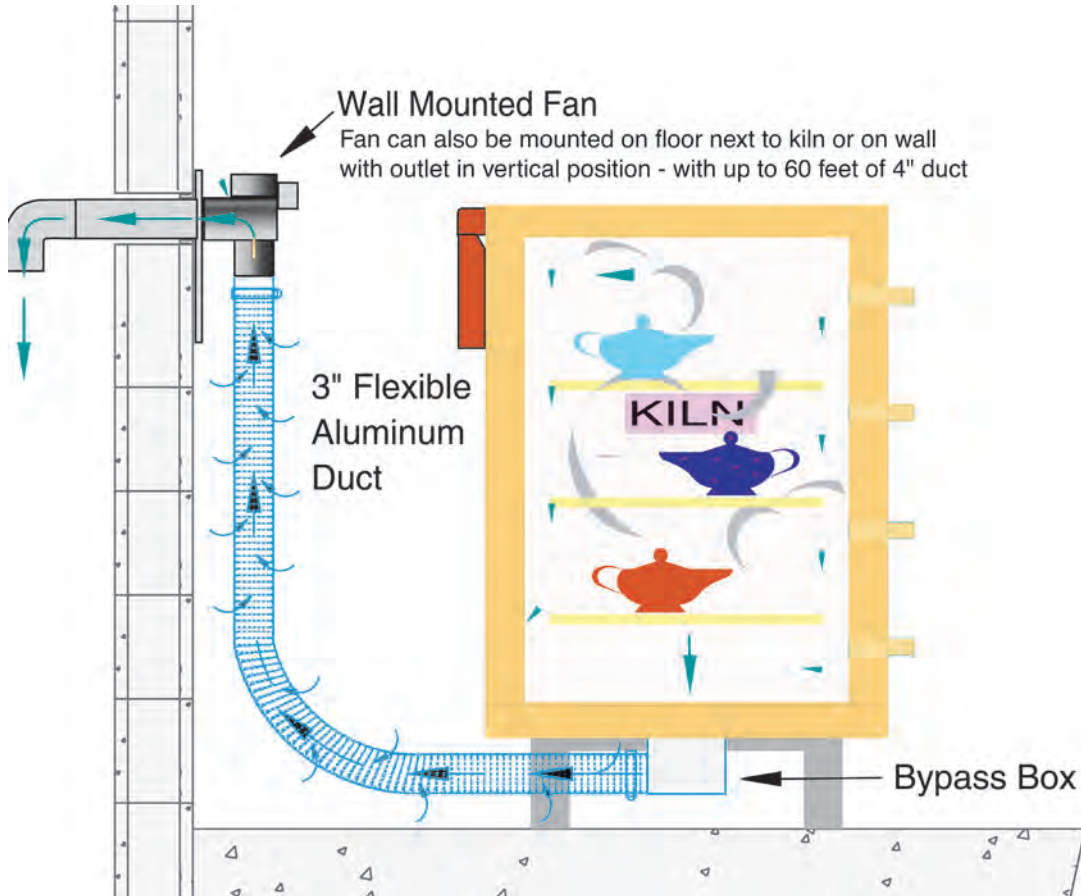

TABLE OF CONTENTS

TABLE OF CONTENTS	1
READ THE INSTRUCTIONS.....	1
USEFUL WEB LINKS	1
CHECKING SHIPMENT	2
WHAT IS INCLUDED WITH VENT	2
IMPORTANT CAUTIONS	2
INSTALLATION TIP BEFORE STARTING.....	2
INTRODUCTION	3
KILN VENTILATION CAUTIONS.....	3
INSTALLATION	3
ROOM AIR REPLACEMENT.....	4
DRILL CHART	5
OPERATION	5
ADJUSTING THE BYPASS SYSTEM	5
VENTING CODES	6
REGULAR MAINTENANCE	6
INSTALLATION OF MULTIPLE VENTS.....	6
OPTIONAL VENT CONTROL.....	7
FREQUENTLY ASKED QUESTIONS.....	7
FEATURES AND SPECIFICATIONS	9
MOTOR SPECIFICATIONS	10
PARTS	10

READ THE INSTRUCTIONS

You are now the proud owner of an L&L “VENT-SURE” kiln ventilation system, engineered to give you the utmost in performance and results. This is an expensive and potentially hazardous appliance (if not used with proper caution). PLEASE TAKE THE TIME TO READ THESE INSTRUCTIONS. There is important information that you need to understand in order to operate your L&L kiln ventilation system safely and effectively.

USEFUL WEB LINKS

See this video on how to install a vent:
hotkilns.com/install-vent-sure

See this video on how to drill holes for a vent:
hotkilns.com/drilling-vent-holes

See this video on how to install a vent control:
hotkilns.com/install-vent-control

See this video on how to program a vent control:
hotkilns.com/program-vent-control

L&L VENT-SURE DOWNDRAFT KILN VENT INSTRUCTIONS

CHECKING SHIPMENT

Your ventilation system was carefully packed and inspected prior to shipment to make sure that all parts were in perfect condition.

When carrier makes delivery, you should immediately unpack your ventilation system and accessories to determine whether or not any damage has occurred in transit.

If damage has occurred, retain all of the packaging material and notify L&L at once. Retain all papers to ensure that a proper claim can be filed.

WHAT IS INCLUDED WITH VENT

One (1) wall-mounted blower mounted on a bracket with vent pipe to go through outside wall and a Motor Inlet Duct. An 8 foot power cord with an attached On/Off switch plugs into a 120 volt standard receptacle. (Note: 220-240 volt models will have a different cord).

One (1) Bypass Collection Box to be mounted to the kiln stand, with mounting hardware.

One (1) length of flexible aluminum ducting (expands to 8 feet) with two (2) hose clamps.

One (1) 4" diameter 90 degree elbow (for outside the building).

One (1) Multi-Mount Bracket

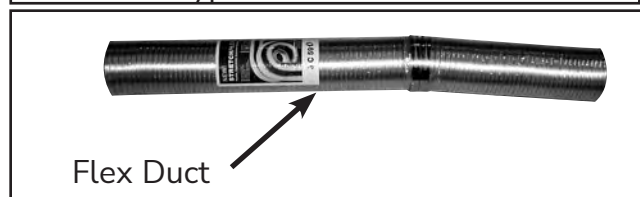
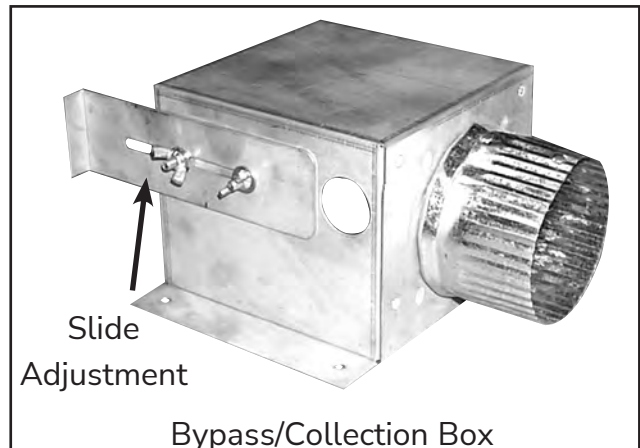
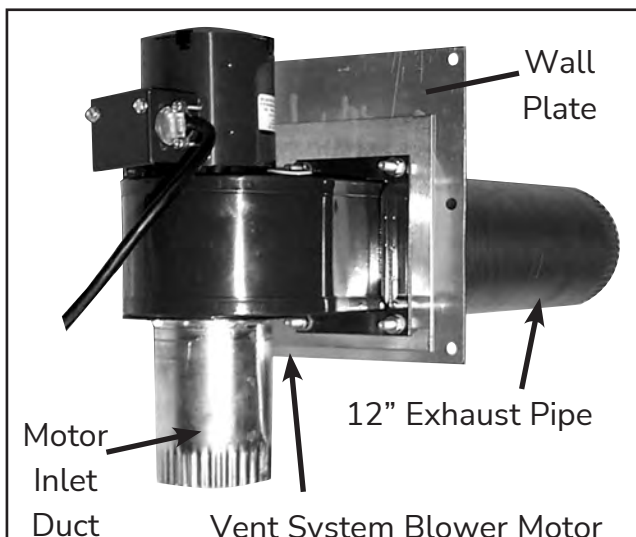

IMPORTANT CAUTIONS

Check duct occasionally to see if there is wax or other residual build up. Wax could condense in the duct, which is a potential fire hazard. This is especially important if you are using a wax resist.

Be sure that the exhaust of the vent is not being brought back into your building. Keep exit of vent at least four feet away from any open windows or doors.

We recommend the use of a carbon monoxide monitor in your kiln room. These are available from good hardware stores for about \$50 (This is another good way to be sure you are getting proper venting).

Disconnect power cord from power source when doing any maintenance on the fan motor. Do not put your fingers inside the blower without disconnecting power. Blower may start unexpectedly because of automatic thermal shut off switch built into the motor.

DO NOT place anything in the blower/motor while powered. Serious injury and/or damage to the motor could result.

INSTALLATION TIP BEFORE STARTING

NOTE: Attach the Bypass Box to the stand and the aluminum duct to the Bypass Box before installing the kiln on the stand because it can be hard to do this when the kiln is on top of the stand.

L&L VENT-SURE DOWNDRAFT KILN VENT INSTRUCTIONS

INTRODUCTION

WHAT DOES THE VENT DO?

The Vent-Sure Kiln Ventilation System is designed to pull air contaminated with carbon monoxide and other fumes including those of volatile metals, decals, sulfur oxide, and others in a down draft fashion out of the kiln and then vent it outside or to a central vent system.

KILN VENTILATION CAUTIONS

VENTILATION IS ESSENTIAL

1. Kilns generate harmful fumes when firing ceramics including: carbon monoxide, sulfur oxides, hydrogen fluoride and metal vapors (all of which can be toxic).
2. Install kiln in a well-ventilated area and never operate in an enclosed space unless you have good airflow.
3. Severe corrosion can be caused by kiln fumes, salt air, or other environmental conditions.

AMBIENT HEAT AND VENTILATION

1. The kiln should operate in an environment that is between -18°C (0°F) and 38°C (100°F).
2. Kiln vents do not take care of ambient ventilation of the kiln room to remove the heat of the kiln.
3. See the following web page for guidance on how to calculate ventilation requirements for a kiln room: hotkilns.com/calculate-kiln-room-ventilation

INSTALLATION

IMPORTANT CAUTION

MAKE CERTAIN KILN POWER IS OFF BEFORE PROCEEDING WITH INSTALLATION.

Step 1. Turn Off Kiln Power

This is critical for safety reasons.

Step 2. Drill Holes (if needed)

Before mounting the Bypass Box, you should drill the vent holes. (Note: if you bought the vent system with a new kiln, it may be pre-drilled) The easiest way to drill the vent holes is to place the stand upside-down on the kiln bottom, center it, and then drill your holes within the large aperture. Otherwise you can measure out the center of your kiln slab and draw a circle in the middle with a radius of 1.5" Then drill your vent holes within that circle.

Step 3. Install Bypass Collection Box

With the vent holes taken care of, you can install the Bypass Collection Box. Just simply use the studs on the bottom of the stand and secure with the provided hardware.

IMPORTANT: Remember to have the outlet pointed towards your fume exhaust location.

The Bypass Collection Box is mounted to the bottom of the stand with provided hardware.

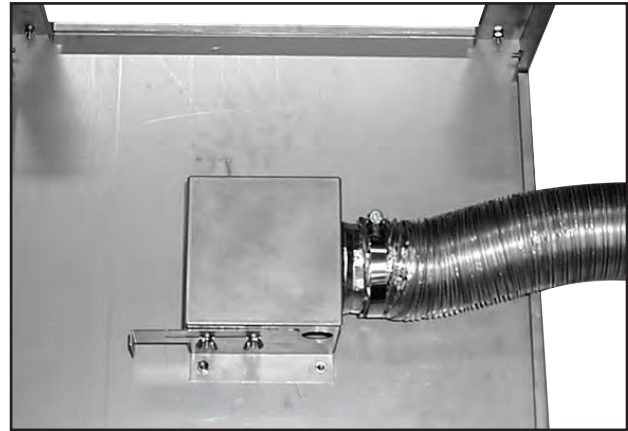

Step 4. Install Blower System

Install blower system by penetrating outside wall or setting into a window with appropriate support. Attach the provided 90 degree elbow to point down on the outside of the building (this is to prevent rain water from getting into the duct). (Note: this procedure will change if you use the Multi-Mount bracket). Mount securely because motor may vibrate over time especially if it builds up any dust in the blower.

The motor assembly comes pre-mounted onto the Wall mount bracket:

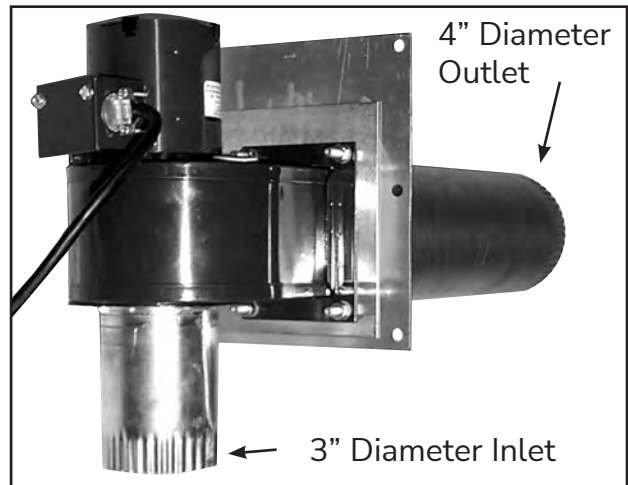

L&L VENT-SURE DOWNDRAFT KILN VENT INSTRUCTIONS

CAUTION: Make sure that the vent outlet is at least four feet from any open windows or doors. This is to make sure fumes do not get back into your building. Also the fumes can be hazardous to plants within a few feet.

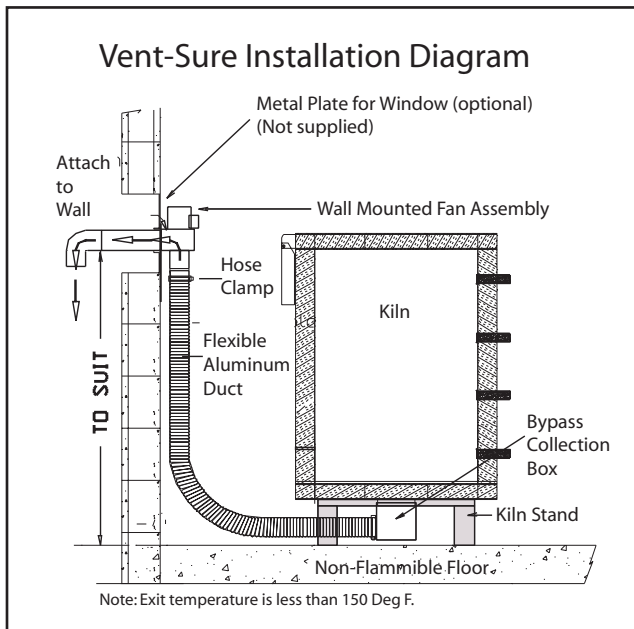

A CAUTION ABOUT MOUNTING VERTICALLY

If the discharge duct of the vent is mounted pointing up (as shown on the photograph to the left), water that condenses in the duct may drop down and rust the motor. We recommend having a water trap in the bottom of a vertical duct run to drain off the water before it runs into the motor. This is not a problem when the vent has been mounted horizontally. The Multi-Mount bracket will allow you to mount the motor horizontally as well. You can then use 90 degree bends or flexible duct to go vertically. Just remember that there is water in the exhaust that will condense somewhere as it cools after it discharges from the vent motor.

A special Multi-Mount bracket is included with each vent system. This will allow you to mount the vent on the floor or wall with the outlet of the vent pointing up. This is useful when you want to use an existing penetration in a wall that won't support the vent (like a window) or when you want to have the vent go out of a roof or into a central vent system.

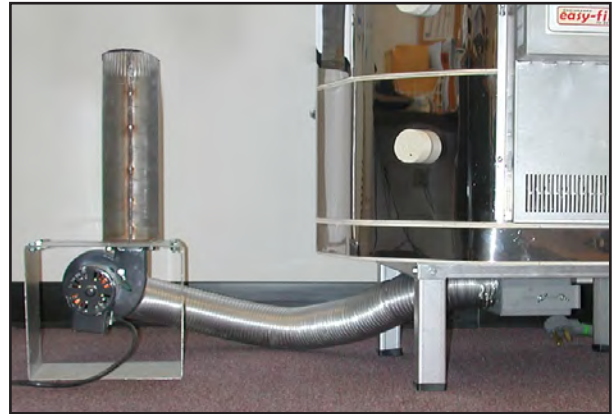

Step 6. Connect Flexible Duct

Attach blower system to bypass/collection box by stretching the flexible aluminum duct carefully (it can extend up to 8 feet) and securing to both the blower housing and the bypass/collection box with the provided hose clamps. **NOTE: You may want to firmly attach this to the Bypass Collection Box before installing the kiln on the stand because it can be hard to maneuver under the kiln.**

Step 7. Plug In Vent

Plug in the switched cord to a standard 120 volt receptacle. **If need be you can safely use a grounded extension cord because of the small amperage required.** Be sure to secure cord away from heat of kiln. Note: On 220-240 volt models this may vary.

ROOM AIR REPLACEMENT

ROOM AIR REPLACEMENT:

The Vent-Sure system moves up to 146 cubic feet of air per minute. We suggest opening a window slightly, or bringing another fresh air source into the room, to replace this room air.

L&L VENT-SURE DOWNDRAFT KILN VENT INSTRUCTIONS

DRILL CHART

MODEL	CUBIC	NO OF	
HOLE	FEET	HOLES	DIA
FUEGO	1.5	1	1/4"
e18S, JD18, LB18	2.6	1	1/4"
e18M	3.2		1/4"
JD18X, e18T	3.9	1	1/4"
e23S, JD18, LB18	4.7	2	1/4"
e23M	5.5	2	1/4"
e23T, SM23T, eQ23T, JD230	7.0	2	1/4"
JD236	9.4	3	1/4"
JD245	11.75	3	1/4"
e28S, J2918	6.9	2	1/4"
e28M	8.6	3	1/4"
e28T, rQ2827, J2927	10.3	3	1/4"
J2936, eQ2836	13.8	4	1/4"
J2945	17.2	5	1/4"
XB2318	5.0	2	1/4"
X2327	8.1	2	1/4"
X2336	10.8	3	1/4"
X2345	13.5	4	1/4"
XB2818	7.8	2	1/4"
X2827	11.7	3	1/4"
X2836	15.6	4	1/4"
X2845	19.5	5	5/16"
XB3218	10.0	3	1/4"
X3227	15.0	4	1/4"
X3236	20.0	5	1/4"
X3245	25.0	6	1/4"
TB2318	9.7	3	1/4"
T2327	14.6	4	1/4"
T2336	19.4	5	5/16"
T2345	24.3	6	5/16"
TB3418	13.8	4	1/4"
T3427	20.7	5	1/4"
T3436 (use 2 vents)	27.6	4/vent	1/4"
T3445 (use 2 vents)	34.5	5/vent	1/4"
eFL1616	4.0	2	1/4"
eFL1626	6.6	2	1/4"
eFL2026	8.6	2	1/4"
eFL2626	10.2	3	1/4"
eFL2635	13.7	4	1/4"
EL2424	8.0	2	1/4"
EL2427	9.0	3	1/4"
EL2436	12.0	3	1/4"
EL2448	16.0	4	1/4"
EL2848	20.0	7	1/4"
EL3048	25.0	8	1/4"

OPERATION

1. Plug blower cord into 120 Volt receptacle. (Note: 220-240 volt models may be different).
2. Close all kiln apertures such as peepholes unless you very specifically want more air vented.
3. Turn on Vent with the in-line switch on the power cord.
4. Close the lid and fire. For heavy loads with lots of fumes you may want to avoid firing faster than 150°F per hour to prevent the generation of more fumes than the system can eliminate.
5. Use the flow control on the Bypass Box to modify the flow of exhaust - a larger flow control opening reduces the flow of exhaust fumes from the kiln, and a smaller flow control opening increases the exhaust.

ADJUSTING THE BYPASS SYSTEM

The sliding adjuster allows you to fine adjust the amount of venting that is done to your kiln. It is easy to adjust but hard to know just how to adjust it. The problem is that there are many factors that contribute to the amount of "pull" required. For instance, the amount of fumes that are being given off by your specific work is one factor. Some clays have a lot of carbon in them; others do not. Depending on the size of the load, and the ingredients in the clay/glaze, there will be more or less fumes generated. Another factor is the "static pressure" in your vent ducts. If you have a lot of curves, 90 degree bends, or long runs of duct this will increase the static pressure (back pressure) and hence increase the need for more venting force. One suggestion is to start with the valve in the half open position and see what happens.

The Smoke Method:

- 1) With the kiln off and with the kiln empty, turn the vent on.
- 2) Start with the bypass valve in the fully closed position. This will give it the maximum suction in the kiln.
- 3) Light a piece of paper on fire or something that will create smoke. Blow it out, and hold it near the cracks around the closed lid.
- 4) If the smoke is being pulled into the kiln around these door cracks, open the Bypass (decreasing flow from the kiln) until the smoke stops being pulled in, then back up the valve slightly, so the draw increases just slightly again. Try this again when kiln is at about 100°F.
- 5) You can do the same test directly at the bottom hole with the kiln open also to test the differential between the pull at the actual suction hole from the kiln and the pull around the lid.

L&L VENT-SURE DOWNDRAFT KILN VENT INSTRUCTIONS

(However, if you do this make sure the kiln is disconnected from the power to avoid the risk of electrocution).

For Gross Adjustment:

Remember that the sliding adjuster is for fine adjustment. Drilling or plugging the holes in the floor (and possibly adding or plugging holes in the top) is how you would dramatically change the amount of air vented.

VENTING CODES

OSHA has set standards for carbon monoxide exposure of 35 ppm (parts per million) for long-term exposure and 200 PPM for short-term exposure. Independent testing has shown that fumes near the kiln can exceed 200 PPM near the kiln during the firing of greenware. This can cause headaches, fatigue, sore throats and nausea. When properly installed and operated, a downdraft vent removes all harmful fumes and provides a safer working environment.

Most states and localities have set venting requirements for firing kilns in public places. Your local and state health board should have this information.

The Uniform Mechanical Code says that you must vent ceramic kilns. It says that you can use a canopy-type hood (and gives specific requirements for such use) or that "listed exhaust blowers may be used when marked as being suitable for the kiln and installed in accordance with manufacturer's instructions."

Our Vent-Sure vent is listed to UL499 standards by MET for L&L Kilns and is appropriate to meet this ventilation requirement. L&L takes no responsibility for improperly installed vents or kilns nor do we take responsibility for the use of other vents with our kilns.

REGULAR MAINTENANCE

Occasionally check for leaks in the aluminum duct. Replace if necessary. Check for corrosion especially if you are using clay with a high content of sulfur, phosphorus or fluorine. Check for wax or carbon build up if you are using a wax resist process or a high carbon content clay.

We recommend unmounting the fan and blowing out the squirrel cage with compressed air every two years or so especially if you are in a very dusty or if you have it mounted on the floor where it is more likely to pick up dust.

If the discharge duct of the vent is mounted pointing up you may get water that condenses in the duct drop down and rust out the motor. Taking it apart and spraying with WD-40 can restore the motor in some cases. We recommend having a

water trap in the bottom of a long vertical duct run to drain off the water before it runs into the motor. This is not a problem when the vent has been mounted horizontally.

INSTALLATION OF MULTIPLE VENTS

For more information see:
hotkilns.com/vent-doubler-system

VENT DOUBLER SYSTEM

This shows a photograph of the Vent Doubler System:



The Vent Doubler system includes an extra Bypass Collection Box, an extra Flexible Aluminum Duct and a "T" Connector with dampers. You can vent two 10 cubic kilns with one Vent-Sure plus this Vent Doubler System.

CENTRAL VENT SYSTEMS

Multiple Vent-Sure systems may be installed individually, or each system may be connected to a central duct. The following information is provided to help the installer make decisions concerning the size and length of the central duct.

CENTRAL DUCT SIZING

QTY OF SYSTEMS SIZE OF CENTRAL DUCT

1	4"
2	6"
3	8"
4	8"
5	10"
6	10"

EXTENDING DUCT LENGTH

The duct may be 60 feet in length, and include up to four 90° bends, without a significant drop in static air flow or a reduction in kiln air pull. You may use any galvanized, stainless or aluminum duct. The outlet duct size (after the motor) is 4" diameter. The inlet duct (before the motor) is 3" diameter.

L&L VENT-SURE DOWNDRAFT KILN VENT INSTRUCTIONS

OPTIONAL VENT CONTROL

For more information see:
hotkilns.com/vent-control

The Vent Control allows you to automatically control the operation of the Vent-Sure kiln vent with one of the outputs from the DynaTrol (or Genesis).



Construction

The Vent Control consists of a relay that is controlled from output #4 on the DynaTrol (or Genesis).

There is a female 120 volt receptacle to plug the vent into and a cord to plug into a 120 volt wall outlet.

There is a 6 foot wire that connects the control box to the kiln control panel. A grommet is included for non-factory installation.

Where It Can Be Used

It is only available for kilns with DynaTrols and Genesis controls.

It may not be used with kilns with powered bottoms (because the same output on the control is used)

Operation

NOTE: These options are set in the "Hidden Menu" of the DynaTrol. (See hotkilns.com/hidden-menu for how to get into the hidden menu on the DynaTrol).

On the Genesis control go to "4-Configuration" on the Main Menu and then to "6-Output 4 Options". The code to get into Factory Configuration, if prompted, is 443.

OPTION A (OP A)

Used to control a vent. Output 4 can be programmed to be on or off during each segment of a Vary-Fire program. During an Easy-Fire program, output 4 comes on at the beginning of the firing and turns off after the kiln has cooled to 150F.

OPTION B (OP B)

Used to control a vent. Output 4 can be programmed to be on or off during each segment of a Vary-Fire program. Output 4 comes on at the beginning of an Easy-Fire program, off at 1450°F, back on after the firing is complete and the kiln has cooled to 1000°F and finally off again when the temperature is below 150°F.

OPTION C (OP C)

Used to control a vent, an alarm, or other atmospheric control. Output 4 can be programmed to be on or off during each segment of a Vary-Fire program. Output 4 is off during Easy-Fire programs.

FREQUENTLY ASKED QUESTIONS

How do I know if the system is working?

See our comments under "Adjusting the Bypass Valve"

How hot does the duct get during the firing?

Not very, for two reasons. One is that the Vent-Sure does not draw out much heat from the kiln. The hotter the kiln gets, the less hot air that is extracted by the vent motor. The other is that the bypass box combines fresh cool air with the hot air from the kiln before passing through the ductwork.

How long can the duct be and how many bends can it have?

Up to 60 feet of ducting containing four 90 degree bends may be safely used with no drop in static air flow at the duct exhaust point or a reduction in draw at the kiln. The ducting can be run either horizontally or vertically. (The Vent-Sure should handle more static pressure than the Orton vent because of the stronger motor. This translates into longer lengths of pipe and more 90 degree bends. If you have a choice run two 45 deg bends rather than one 90 degree bend or use flexible duct which has a gentler bend).

Can I vent through a ceiling and/or roof?

Yes. You will need the multi-mounting bracket (M-V-MULT/00), so that you can position the motor output vertically. Additionally, you need to make sure that you install a water trap. At the bottom of the longest vertical run, install a u-shaped bend to catch any condensation that forms before it enters the motor. Of course if you are going through a roof, you will also need a rain cap and screen.

L&L VENT-SURE DOWNDRAFT KILN VENT INSTRUCTIONS

You do not normally need double wall ducting when going through the roof since the pipe or duct does not reach high temperature. It is always advisable to check your local building codes for their requirements.

How do I determine the size, number, and location of holes in the top and bottom of the kiln?

As a general rule, you should have one 1/4 inch hole for every 4 cubic feet of kiln volume. The holes are normally placed within a 4 inch circle in the center of the kiln floor. Please see our hole chart on page 7. L&L does not normally recommend drilling holes in the top except for certain instances where airflow needs to be increased such as for glazes which need an oxygen rich environment.

Will the fumes coming through the vent damage my plants, the neighborhood pets or disturb the local environment?

For the most part, the fumes have been diluted enough already when they are exhausted, however that depends on how you have your bypass box setup. We do not recommend placing the outlet of the vent below an open window and we have heard of plants near the vent outlet being affected by the vent fumes so keep this in mind when locating vent outlet. Once the fumes are exhausted, they will quickly be diluted by the outside air, so it is only the immediate area around the vent that you need be concerned about.

Will using the vent cause my firing to take longer?

Generally only a little bit longer. The vent system removes only a small amount of heat from the kiln due to the physics of how thin air gets at very high temperatures. (L&L NOTE: We have seen vents overpower smaller kilns - so it is important to adjust the amount of venting in some cases. On the other hand an example of an e23T 7 cubic foot kiln firing an 85 pound load on Fast Glaze program to cone 8 took 7 hours and 4 minutes with a vent on and 6 hours and 24 minutes without a vent. The vent was on the whole time).

What does it cost to operate the vent system?

The vent system should likely cost less than 1 cent/hour to operate (electricity costs). Downdraft vents are still vastly more efficient than hoods which remove tons of air from the kiln room while the Vent-Sure only removes a small amount of air from the kiln. (It does cost more to run the vent because it does take heat out of the kiln. For example an e23T 7 cubic foot kiln firing an 85 pound load on Fast Glaze program to cone 8 took 70 KW hours with a vent on and 62 KW hours without a vent. At 8 cents per KW hour that would be a cost of \$0.64 more for the firing. The vent was on the whole time).

Will the cold air entering the kiln damage the product?

No. The amount of air coming in is too small unless you drill holes in the lid, which is not normally recommended. The air coming in is also distributed throughout the kiln evenly.

Will faster cooling crack the ware if I leave the vent on during the cooling Cycle?

No. Most kilns will cool faster with the vent system, but it is achieved at such an even rate and distribution that there would not be any damage to ware. (L&L NOTE: The vent will remove more molecules of air and hence heat as the kiln cools. This is because the density of the air increases the lower in temperature you go. This is one reason why kiln vents are so efficient - they don't remove too much heat when you don't want them too at the higher temperatures).

What should I do if I still smell fumes?

Check all ductwork for leaks and see our comments on "Adjusting the Bypass System".

If using a hood type vent (like the Vent-a-Kiln) do you need a kiln vent (like the Vent-Sure) also?

You need to vent fumes from the kiln and the room and heat from the room. You must have ambient ventilation in a small room for heat and to remove fumes that may not be fully removed by the kiln vent. If you have a very large room that can dissipate heat and trace fumes than you may not need ambient ventilation.

The Vent-Sure is designed to remove fumes that are generated in the kiln from the kiln and therefore from the room. The Vent-Sure downdraft kiln vent does not remove enough heat from a small room to be used for ambient ventilation.

If you have a good overhead vent hood you may discharge the output of the Vent-Sure into that hood.

At what temperature should you turn off the Vent-Sure kiln vent?

A customer writes: When firing glazes what is a good temp to turn off the vent so kiln can hit target temp in my case 2190 Deg F. Do glazes off-gas after say 2000 degrees? Is there a general temperature to turn off vent?

Answer: Generally speaking it is best for your kiln to leave the Vent-Sure on for the entire time the kiln is heating up. Mostly this is to get all of the corrosive fumes before they get to your elements, wiring, and other metal parts of the kiln.

You can leave it on for the cooling as well if you need it to cool off more quickly.

L&L VENT-SURE DOWNDRAFT KILN VENT INSTRUCTIONS

Usually a slower cool-down is preferred though, so often the fan is turned off for the cool-down.

High-fire clays and glazes out-gas until the kiln begins to cool. Once the glaze has set, and the clay has vitrified no more gasses escape.

The heat in a red-hot kiln is almost all radiant heat. The hotter the kiln gets, the fewer and fewer air molecules are even present inside. Because of this- it is only helping the heating rate a tiny little bit to turn off the vent before the end of the firing.

How long does a Vent-Sure downdraft vent last?

The Vent-Sure downdraft kiln vent is pulling not only air but moisture and the products of hot moisture and the chemicals that are present in the clay. Some of these products are highly acidic (like sulfuric acid, hydrofluoric acid and others). The exact amount and composition of the effluents of your kiln, and hence in the vent, will vary with how dry your work is and what is in the clay to begin with. The Vent life seems to be totally dependent on these conditions. The more moisture and acids created by the materials in the clay and water then the shorter the vent life. If you have good conditions the vent can last for many years - if not - then you will be replacing various parts over the years.

That said - L&L's experience has been very positive. We have sold thousands of Vent-Sures for over 15 years. We sell very few replacement motors and other parts. The most vulnerable part seems to be the thin aluminum flexible duct that goes from the kiln to the vent motor. This is cheap and you can find replacements locally.

The motors hold up very well in terms of lubrication and vibration. The Vent-Sure is warranted for three years.

FEATURES AND SPECIFICATIONS

ADJUSTABLE AMOUNT OF VENTING

A sliding adjuster on the vent Bypass Collection Box adjusts the amount of venting from the system (see photo on page 3). Vent only what you need to vent - don't waste heat and energy by venting more than you need.

EXTERNAL VENTING

External venting is safer and surer than venting to the inside of your kiln room with a filter.

REMOTE MOUNTING OF MOTOR

The vent blower motor is mounted to a wall plate with a 12" length of exhaust pipe that mounts on the wall (see photo). This keeps the heat of the kiln away from the motor (for longer motor life) and keeps the motor vibration away from the kiln. (With the special "Multi-Mounting Bracket" the vent motor may be mounted on the floor or a wall with the outlet pointing up and then connected to an existing vent system or 4" wall outlet. If you decide to mount it this way see the caution on page 5).

MOUNTS ON ANY L&L KILN

The Vent-Sure vent system can be installed on almost any kiln. It requires only that you drill several small vent holes through the kiln floor (note that if mounting the bypass/collection box to the stand, that four studs are factory installed on the bottom of the stand). Mounting hardware is included.

Note: L&L Vent-Sure vent are not c-MET-us listed for use on any kiln except those made by L&L Kiln Mfg., Inc.

POWERFUL VENT MOTOR

The blower vents up to 146 CFM (cubic feet per minute at 0 static pressure and 110 CFM at 0.500-In. static Pressure). Remember - not all of this air comes from the kiln - some comes from the Bypass Collection Box.

OUTLET TEMPERATURE UNDER 150°F

The outlet temperature of the air is less than 150°F as long as you do not exceed the recommended holes in the kiln.

FLEXIBLE DUCT INCLUDED

8 feet of flexible expandable aluminum 3" diameter duct is included along with necessary hose clamps. Longer lengths or lengths of 3" stove pipe can be used as well.

LOW ELECTRICITY USAGE

The Vent-Sure vent System uses only 0.75 amps at 120 volts.

VENTS UP TO 20 CUBIC FEET OR MORE

The Vent-Sure vent System was designed to be used with all L&L model kilns. We recommend one vent system for kilns up to approximately 20 cubic feet. On larger kilns, depending on how much venting you need, you may need more than one vent system. (This really depends on how much venting you need for your situation). Note that you can always add another vent if you find you need more venting.

L&L VENT-SURE DOWNDRAFT KILN VENT INSTRUCTIONS

MOTOR SPECIFICATIONS

120 VOLT MOTOR

PSC Blower, Type:Forward Curve, Direct Drive

Wheel Dia. (In.):3-15/16, Wheel Width (In.):2-1/2

CFM @ 0.000-In. SP:146, CFM @ 0.100-In. SP:140, CFM @ 0.200-In. SP:126, CFM @ 0.300-In. SP:124. CFM @ 0.400-In. SP:120, CFM @ 0.500-In. SP:110,

Voltage:115, Hz:50/60, Phase:1, Full Load Amps:0.75, RPM:3100

Bearing Type:Ball, Motor Type:Permanent Split Capacitor, Motor Enclosure:Open, Motor Insulation:Class B, Thermal Protection:Auto

Lead Length (In.):13, Conduit Box:Yes,

Ambient Temp. (Deg. F):104, Max. Inlet Temp. (Deg. F):104

Inlet Dia. (In.):3-1/8, Outlet Height (In.):2-3/16, Outlet Width (In.):3-1/4, Overall Height (In.):5-3/4, Overall Width (In.):6-5/16, Overall Depth (In.):5-3/8, Mounting:All Position, Housing Finish:Gray Enamel, Housing Material:Rolled Steel

Agency Compliance:UL Recognized US and Canada (E47479)

220-240 VOLT MOTOR

Item-PSC Blower, Type-Forward Curve, Direct Drive

Wheel Dia. (In.):3-3/4, Wheel Width (In.):1-7/8

CFM @ 0.000-In. SP:133, CFM @ 0.100-In. SP:128, CFM @ 0.200-In. SP:126, CFM @ 0.300-In. SP:119, CFM @ 0.400-In. SP:112, CFM @ 0.500-In. SP:105,

Voltage:230, Hz:50/60, Phase:1

Full Load Amps:0.33, RPM:2880

Bearing Type:Ball, Motor Type:Permanent Split Capacitor, Motor Enclosure:Open, Motor Insulation:Class B, Thermal Protection:Auto, Lead Length (In.):13, Conduit Box:Yes, Ambient Temp. (Deg. F):104, Max. Inlet Temp. (Deg. F):104

Inlet Dia. (In.):3-1/4, Outlet Height (In.):2-1/2, Outlet Width (In.):2-9/16, Overall Height (In.):6-9/16, Overall Width (In.):5-5/8, Overall Depth (In.):6-9/16

Mounting:All Position, Housing Finish:Gray Enamel, Housing Material:Rolled Steel

The Vent-Sure vent is c-MET-us listed in both the US and Canada for use with L&L listed kilns. UL 499, CSA C22.2, No. 122, CSA C22. Listing No E112742.

PARTS

Prices of all parts are listed at:
hotkilns.com/parts

Complete Vent-Sure Kiln Vent System

M-V-VENT/00..... (see web)

VENT-SURE Vent. 120 Volt. Complete System as described above and on our separate Vent-Sure brochure. This includes the motor, an 8 foot cord with a rocker type On/Off switch mounted in line in the cord, the inlet duct attached to the motor, the wall mounting bracket, a 90 deg elbow for mounting on the end of the outlet pipe (to keep rain water out), the Bypass Collection Box for attaching to the kiln stand or kiln side along with mounting hardware for mounting to an L&L kiln stand and one section of 8 foot flexible aluminum duct with hose clamps.

M-V-VENT/41..... (see web)

VENT-SURE Vent. 220-240 Volt. Typically used in non-US installations.

You can also purchase individual parts to suit your own configuration or as replacements:

Below shows the vent system blower assembly with the motor, cord and switch set, 3" inlet duct to hold the flexible duct, 12" duct to go through a wall and 90 Degree elbow.

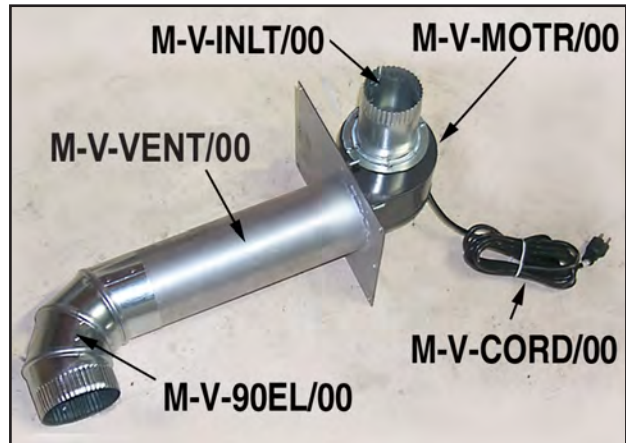

M-V-FANK/00.....(see web)

Complete blower assembly. Pictured above.

M-V-FAN0/00..... (see web)
Fan/Blower Motor for Vent-Sure. 120 Volts. This is just the motor with no attached brackets or inlets. Cord is not included.

M-V-FAN0/41..... (see web)
Fan/Blower Motor for Vent-Sure. 220-240 Volts. This is just the motor with no attached brackets or inlets. Cord is not included.

M-V-BRKT/00..... (see web)
Steel plate onto which the motor mounts. Includes 4" x 12" outlet pipe and output mounting plate.

M-V-INLT/00..... (see web)
Motor Inlet Duct. This is the piece of duct that attaches to the inlet of the motor. The expandable aluminum duct fits onto this.

L&L VENT-SURE DOWNDRAFT KILN VENT INSTRUCTIONS

M-V-OUTT/00..... (see web)
Motor Outlet Duct. This is the piece of duct that attaches to the outlet of the motor.

M-V-90EL/00..... (see web)
90 Deg 4" elbow. Used for attaching to motor mount duct to the outside to prevent water from getting into duct.

M-V-CORD/00..... (see web)
Power Cord for Vent-Sure. Includes a cord mounted on/off switch. (Call factory for non-USA cords)

Power Cord with On/Off switch:



M-V-DUCT/00..... (see web)
Flexible Vent Duct 2-1/2 to 8 Feet Expandable, Flexible Aluminum 3" duct with two hose clamps.

Flexible Aluminum Duct shown with hose clamps:



M-V-BBOX/00..... (see web)
Bypass Collection Box. Includes hardware for mounting and slide control. Note: This has the proper mounting hole configuration to be mounted to any L&L kiln stand. It can also be mounted to the side of other kilns (typically on the bottom section).

Bypass Collection Box:

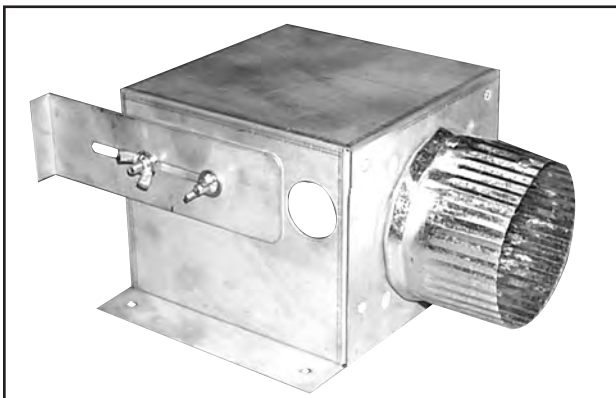

M-V-MULT/00..... (see web)
Multi-Mounting Bracket. Comes with six (6) sets of 1/4-20 bolts, nuts and lock washers for mounting this to the "Wall mount bracket" (M-V-VENT/BK).

This special "Multi-Mounting Bracket" will allow you to mount the vent on the floor or wall with the outlet of the vent pointing up. There are mounting holes on the bottom (for floor mounting) and on the side as well (for wall mounting):



M-V-VENT/DB..... (see web)
Vent Doubler System for Vent-Sure. Includes a "T" duct with dampers, an extra Bypass Collection Box, Extra Flexible Duct.

Vent Doubler System:



M-V-TDUC/00..... (see web)
"T" DUCT to attach two aluminum flexible ducts to. Includes dampers on the two inlets. The outlet fits onto the Motor Inlet Duct of the Vent-Sure and the Flexible Vent Duct(s) fit onto the inlets of this "T" Duct. (NOTE: The Multi-Mounting Bracket is shown in the photograph but NOT included in the system).

Special "T" duct for doubler system:

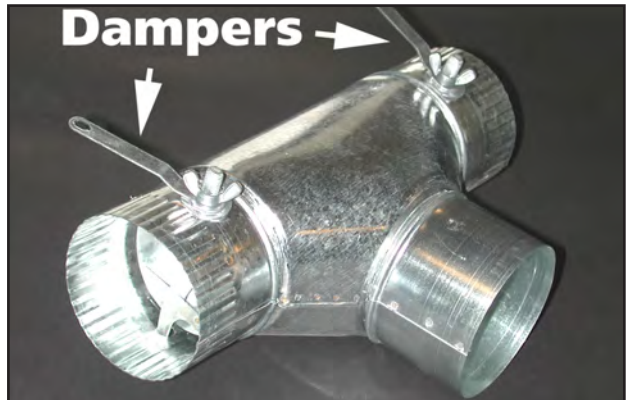

VENT CONTROL INSTRUCTIONS

VENT CONTROL

The Vent Control allows you to automatically control the operation of the Vent-Sure kiln vent with one of the outputs from the DynaTrol (or Genesis). If you have a vent this can be easily retrofitted with a little wiring into your control panel.

Construction

The Vent Control consists of a relay that is controlled from output #4 on the DynaTrol (or Genesis).

There is a female 120 volt receptacle to plug the vent into and a cord to plug into a 120 volt wall outlet.

There is a 6 foot wire that connects the control box to the kiln control panel. A grommet is included for non-factory installation.

Operation

NOTE: These options are set in the "Hidden Menu"

OPTION A (OP A)

Used to control a vent. Output 4 can be programmed to be on or off during each segment of a Vary-Fire program. During an Easy-Fire program, output 4 comes on at the beginning of the firing and turns off after the kiln has cooled to 150F.

OPTION B (OP b)

Used to control a vent. Output 4 can be programmed to be on or off during each segment of a Vary-Fire program. Output 4 comes on at the beginning of an Easy-Fire program, off at 1450°F, back on after the firing is complete and the kiln has cooled to 1000°F and finally off again when the temperature is below 150°F.

OPTION C (OP C)

Used to control a vent, an alarm, or other atmospheric control. Output 4 can be programmed to be on or off during each segment of a Vary-Fire program. Output 4 is off during Easy-Fire programs.

Where It Can Be Used

It is only available for kilns with a DynaTrol or Genesis. (Not available on the One-Touch).

It may not be used with kilns with powered bottoms (because the same output on the control is used)



For more information:

See hotkilns.com/vent-control



LOOKING INSIDE CONTROL PANEL

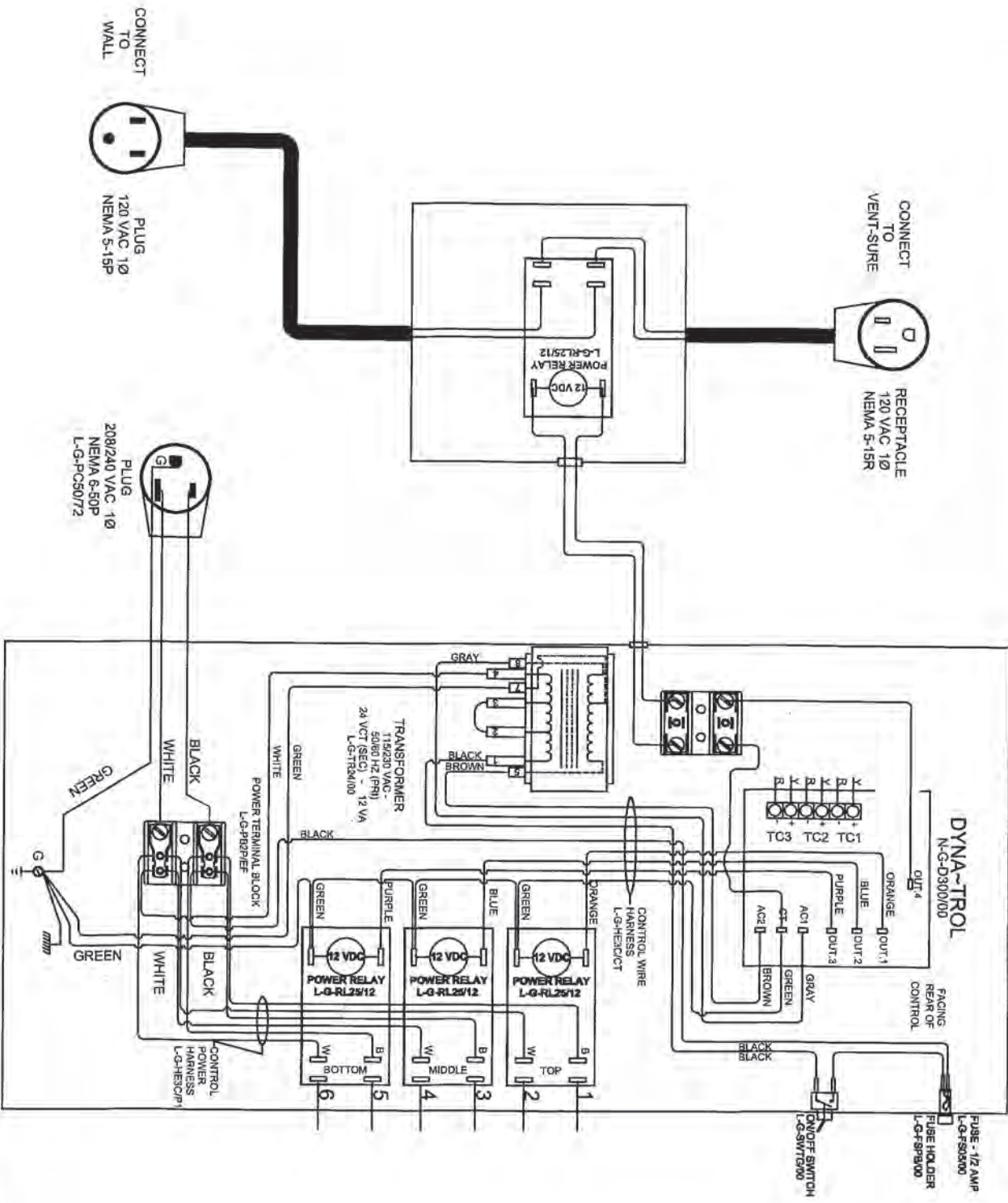

DRAWING NO.	1/1	REV.	0	TITLE	SCALE	DATE	DRAWN BY	FILE NAME	APPROVED	REVISION DESCRIPTION	MADE FROM
AH010716	1/1		0	VENT-SURE CONTROL SYSTEM FOR WIRING TO DYNA-TROL	1 = 8	1/7/2016	AA	AH010716.dwg			K290-151.dwg
<p>800 BLAUGHTOWN RD. BLENHEIMSBORO, NJ 08005 PHONE: (800) 294-4377 FAX: (609) 294-5510</p>											
<p>L & K KILNS</p>											

DAVINCI INSTRUCTION MANUAL

WIRING



L&L Kiln's patented hard ceramic element holders protect your kiln.

DAVINCI INSTRUCTION MANUAL

ACCESSORIES



L&L Kiln's patented hard ceramic element holders protect your kiln.

ACCESSORIES THAT CAN BE ADDED FOR L&L KILNS

ROLLING STANDS

You can add this to most polygonal kilns that is 27" or less in height.



L&L's rolling kiln stand features heavy gauge (14 ga) galvanized steel construction with multiple bends for extra strength, steel swivel locking casters with polypropylene wheels, integrated vent collection box support, and guide rails for the kiln. Each size is fitted to the kiln.

There are three sizes:

Small for an 8 sided kiln like an e18S (22.5" by 22.8")

Medium for a 10 sided kiln like an e23T (28.8" by 30")

Large for a 12 sided kiln like an e28T (34.3" by 34")

NOTE: There are the same height from the floor to the top of the stand as our normal stands.

The vent collection box is not included but, when you order a Vent-Sure vent system the longer duct is included with the system. The Rolling Stand for a 12 Sided kiln uses an 18' long duct and the Rolling Stand for the 8 Sided and 10 Sided kilns use a 12" long duct.

These ship by UPS.

For more information

See hotkilns.com/rolling-stands

Pricing for retrofit stands

hotkilns.com/kiln-parts/rolling-stand-8-sided-kiln

hotkilns.com/kiln-parts/rolling-stand-10-sided-kiln

hotkilns.com/kiln-parts/rolling-stand-12-sided-kiln

PLATINUM TYPE S THERMOCOUPLES

The standard thermocouple used on the DynaTrol or Genesis control is Type K. The most common thermocouple configuration that we use is an 8 gauge exposed Type K thermocouple. This is standard on Easy-Fire, School-Master, Jupiter, eQuad-Pro, Hercules, Easy-Load, DaVinci, Fuego and Doll kilns.

The very best thermocouple for constant high fire applications is a Type S platinum thermocouple with an alumina sheath. This is standard on the JH Series kilns and is recommended for the most extreme conditions (like firing crystalline glazes). If you have a DynaTrol or Genesis control on your kiln, you can order Type S thermocouples. The control is soft and hard programmed for this (to avoid potential misfiring) and special calibrated wire connects the platinum thermocouples with the control.

Below is Type S Platinum Thermocouple:



TECHNICAL INFORMATION

Type S thermocouples are composed of a positive leg which is 90% platinum and 10% Rhodium, and a negative leg which is 100% platinum. It is usable from 32°F to 2700°F. (0°C to 1480°C). It has a different EMF output than Type K thermocouples (meaning the same temperature will produce different voltages to the control which must then be interpreted differently).

At temperatures used in pottery kilns (even the highest 2400°F) these thermocouples can last for a very long time (as long as they are not mechanically broken).

The lead wires that go from the Type S thermocouple to the control are a special grade that is not interchangeable with Type K lead wire.

On DynaTrols used before Jan 1, 2006, or on One-Touch controls, this is not a retrofittable option.

On DynaTrol 700 controls (used after Jan 1, 2006) the control can be easily converted from Type K to Type S in the field. You will still need to change the lead wire. Contact L&L for more information.

ACCESSORIES THAT CAN BE ADDED FOR L&L KILNS

DESCRIPTION

The Type S thermocouples that we provide have a 5/16" OD alumina sheath. They are ungrounded. There are two lengths. The short one used in the Easy-fire, Jupiter, eQuad-Pro, JH Series, DaVinci, and Doll kilns is 120 mm (4.75") long. The medium one used in the Easy-Load front-loading kilns is 160 mm long (6.3").

Polarity

Black Wire = PLUS (+)

Red Wire = MINUS (-)

RETROFITTING CAUTIONS

CHECK THE CONFIGURATION OF ANY REPLACEMENT CONTROL TO MAKE SURE YOU DON'T MELT YOUR KILN! See your control instructions for how to do this.

A replacement control, if ever needed, will typically have our standard configuration for Type K thermocouples with 3 zone control. THIS WILL NOT MATCH YOUR KILN IF YOU HAVE TYPE S THERMOCOUPLES!

This is the MOST IMPORTANT thing to do. If your kiln has Type S thermocouples and the control is set up for type K thermocouples you could overfire the kiln to the point of a complete melt-down.

Type K thermocouple extension wire (the wire that goes from the thermocouple to the control) is either yellow or brown. Type S extension wire is green (in the USA). See this for more information on thermocouple wires and hookup: hotkilns.com/tc-polarity

ORDERING

PART NUMBER: T-G-SXXX/00

Type-S Thermocouple - 120 mm (Standard Length).

Type S Platinum Thermocouple with Alumina Protection Tube and Terminal Block - Unit is 120 mm (4-3/4") Long x 1/4" Diameter. Can be used on any polygonal, square, or rectangular kilns with standard 2-1/2" or 3" brick insulation using a DynaTrol control board. Not for use on any Front-Loading kilns, or custom kilns with more than 3" of insulation.

hotkilns.com/type-s-thermocouple-standard

PART NUMBER: T-G-SXXX/06

Type-S Thermocouple - 160 mm (Medium length). Type S Platinum Thermocouple with Alumina Protection Tube and Terminal Block - Unit is 160 mm (6-5/16") Long x 1/4" Diameter. Used on Easy-Load kilns where wall

thickness is 5".

hotkilns.com/type-s-thermocouple-long

NOTE: Type S thermocouples can be ordered with a kiln as part of the original equipment on all kilns that have a DynaTrol or Genesis Control.

METAL SHEATHED THERMOCOUPLES

An alternative to the standard 8 gauge thermocouple is the Type K industrial Pyrocil metal-sheathed thermocouples.

Below is metallic sheathed Pyrocil thermocouple:



APPLICATION

These thermocouples are useful where greater responsiveness is required than you will get with the 8 gauge inside of a 1/8" wall thickness ceramic protection tube. This is typically for industrial applications. Most ceramic firing does not need quick response.

We do not recommend using these above cone 6 temperatures (2232°F, 1222°C).

DESCRIPTION

Industrial Grade Pyrocil Metal Sheathed Thermocouples are made with a high temperature alloy called Pyrocil.

L&L provides these special thermocouples with a 1/4" diameter sheath. These will last longer than the smaller 1/8" diameter thermocouples that some manufactures use. We use a high quality ceramic terminal block on the end.

The standard Pyrocil thermocouple is 6-1/2" long.

Because the Pyrocil thermocouples are still Type K, no changes need to be made with the control board to use them.

You will need a special ceramic bushing to fill up the hole left by the standard Type K thermocouple.

ACCESSORIES THAT CAN BE ADDED FOR L&L KILNS

ORDERING

PART NUMBER: T-G-E23M/05

Type-K Industrial Grade Pyrocil Sheathed Thermocouples with Ceramic Terminal Block - Unit is 5" Long x 1/4" Diameter. Used on DaVinci, Jupiter, Easy-Fire and other kilns with 2-1/2" or 3" brick walls.

hotkilns.com/type-k-pyrocil-sheathed-thermocouple-5-long

PART NUMBER: T-G-E23M/06

Type-K Industrial Grade Pyrocil Sheathed Thermocouples with Ceramic Terminal Block - Unit is 6-1/2" Long x 1/4" Diameter. Used on Hercules and Easy-Load kilns where the wall has a thickness is 5" of insulation.

hotkilns.com/type-k-pyrocil-sheathed-thermocouple

ELECTRICAL NOISE FILTER AND 120V CONTROL POWER SUPPLY

Electrical Noise Problems

L&L kilns that use the DynaTrol or One-Touch™ electronic control normally get their control voltage transformed from the incoming line voltage that the kiln operates on. This is standard and proper industrial practice. However, in some cases this is not desirable.

If you have problems with short power outages, voltage spikes, voltage drops, or excessive environmental line noise (such as is caused by large 3-phase motors or phase angle fired SCRs), this can cause unpredictable behavior in the electronic control. These are conditions found on overburdened power grids, in some factories, and sometimes in rural areas. It is hard to detect without very specialized equipment (most electricians would not be able to "see" these problems).

How To Solve The Problem

When you have the above conditions we recommend having the control feed by a separate 120 volt line (with a standard 6 foot long cord) and having that voltage filtered though an EMI (Electrical Magnetic Interference) noise filter.

We then recommend plugging the 120 volt cord into a good computer surge protector or better yet a UPS (Uninterruptable Power Supply) power supply with isolation transformer. You can buy a good UPS for at a computer store for less than \$100.

For information and pricing

See hotkilns.com/noise-filter

APM ELEMENTS

Technical Description

APM element wire is a very special sintered alloy that Kanthal makes. It resists grain growth at high temperatures and has a very high hot strength (which keeps the coils from flattening as easily as with Kanthal A1 or equivalent wire). You can get more technical information from the Kanthal web site at kanthal.com.

This is from Kanthal's web site:

Kanthal APM is an advanced powder metallurgical, dispersion strengthened, ferritic iron-chromium-aluminum alloy (FeCrAl alloy) which is used at wire temperatures up to 1425°C (2595°F). Kanthal APM has good hot strength, giving good form stability of the heating elements with less need for element support. It has low tendency to ageing, low resistance change and long element life. Kanthal APM has an excellent surface oxide, which gives good protection in corrosive atmospheres as well as in atmospheres with high carbon potential, and no scaling. The combination of excellent oxidation properties and form stability makes the alloy unique. Typical applications for Kanthal APM are in furnaces for firing of high temperature ceramics, in high temperature heat treatment furnaces, in high temperature laboratory furnaces, in high temperature furnaces in the electronic industries, and in diffusion furnaces.

These elements are recommended for crystalline glaze applications because the same process that causes crystal growth in glazes also causes grain growth in the standard Kanthal A-1 alloy used in electric ceramic pottery kilns.

Pricing of retrofit elements

These typically cost about three times what you would pay for regular replacement elements. For pricing of retrofit elements email service@hotkilns.com

ACCESSORIES THAT CAN BE ADDED FOR L&L KILNS

VENT CONTROL

The Vent Control allows you to automatically control the operation of the Vent-Sure kiln vent with one of the outputs from the DynaTrol (or Genesis). If you have a vent this can be easily retrofitted with a little wiring into your control panel.

Construction

The Vent Control consists of a relay that is controlled from output #4 on the DynaTrol (or Genesis).

There is a female 120 volt receptacle to plug the vent into and a cord to plug into a 120 volt wall outlet.

There is a 6 foot wire that connects the control box to the kiln control panel. A grommet is included for non-factory installation.

Where It Can Be Used

It is only available for kilns with a DynaTrol or Genesis. (Not available on the One-Touch).

It may not be used with kilns with powered bottoms (because the same output on the control is used)



For more information and pricing

See hotkilns.com/vent-control

VENT DOUBLER

Vent Doubler Allows The Use Of One Vent With Two Kilns

You can get a vent doubler options which allow you to vent two kilns that are each up to 10 cubic feet. This can be added to most kilns if you are adding another kiln and want to save money on the extra vent.

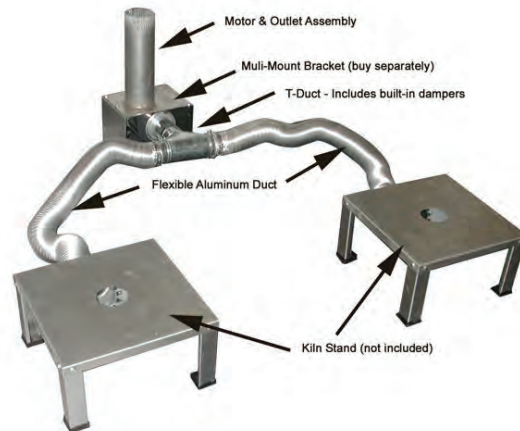

For more information and pricing

See hotkilns.com/vent-doubler

DAVINCI INSTRUCTION MANUAL



L&L Kiln's patented hard ceramic element holders protect your kiln.

FIRING LOG FOR L&L KILNS

DATE	PROGRAM	CONE	TIME	FINAL TEMP	LOAD WEIGHT	CLAY BODY	GLAZE

Temperature Equivalent Chart for Orton Pyrometric Cones (° F) Cone Numbers 022-14



Cone	Self Supporting Cones						Large Cones			Small		
	Regular		Iron Free		Iron Free		Regular	Iron Free	Regular	Iron Free	Regular	Iron Free
	Heating Rate ° F/hour (last 180° F of firing)											
	27	108	270	27	108	270	108	270	108	270	540	
022		1087	1094				N/A	N/A			1166	
021		1112	1143				N/A	N/A			1189	
020		1159	1180				N/A	N/A			1231	
019	1213	1252	1283				1249	1279			1333	
018	1267	1319	1353				1314	1350			1386	
017	1301	1360	1405				1357	1402			1443	
016	1368	1422	1465				1416	1461			1517	
015	1382	1456	1504				1450	1501			1549	
014	1395	1485	1540				1485	1537			1598	
013	1485	1539	1582				1539	1578			1616	
012	1549	1582	1620				1576	1616			1652	
011	1575	1607	1641				1603	1638			1679	
010	1636	1657	1679	1600	1627	1639	1648	1675	1623	1636	1686	
09	1665	1688	1706	1650	1686	1702	1683	1702	1683	1699	1751	
08	1692	1728	1753	1695	1735	1755	1728	1749	1733	1751	1801	
07	1764	1789	1809	1747	1780	1800	1783	1805	1778	1796	1846	
06	1798	1828	1855	1776	1816	1828	1823	1852	1816	1825	1873	
05½	1839	1859	1877	1814	1854	1870	1854	1873	1852	1868	1909	
05	1870	1888	1911	1855	1899	1915	1886	1915	1890	1911	1944	
04	1915	1945	1971	1909	1942	1956	1940	1958	1940	1953	2008	
03	1960	1987	2019	1951	1990	1999	1987	2014	1989	1996	2068	
02	1972	2016	2052	1983	2021	2039	2014	2048	2016	2035	2098	
01	1999	2046	2080	2014	2053	2073	2043	2079	2052	2070	2152	
1	2028	2079	2109	2046	2082	2098	2077	2109	2079	2095	2163	
2	2034	2088	2127				2088	2124			2174	
3	2039	2106	2138	2066	2109	2124	2106	2134	2104	2120	2185	
4	2086	2124	2161				2120	2158			2208	
5	2118	2167	2205				2163	2201			2230	
5½	2133	2197	2237				2194	2233			N/A	
6	2165	2232	2269				2228	2266			2291	
7	2194	2262	2295				2259	2291			2307	
8	2212	2280	2320				2277	2316			2372	
9	2235	2300	2336				2295	2332			2403	
10	2284	2345	2381				2340	2377			2426	
11	2322	2361	2399				2359	2394			2437	
12	2345	2383	2419				2379	2415			2471	
13	2389	2428	2458				2410*	2455*			N/A	
14	2464	2489	2523				2491*	2530*			N/A	

Pyrometric cones have been used to monitor ceramic firings for more than 100 years. They are useful in determining when a firing is complete, if the kiln provided enough heat, if there was a temperature difference in the kiln or if a problem occurred during the firing.

Cones are made from carefully controlled compositions. They bend in a repeatable manner (over a relatively small temperature range - usually less than 40° F). The final bending position is an indication of how much heat was absorbed.

Behavior of Pyrometric Cones

Typically, it takes 15 to 25 minutes for a cone to bend once it starts. This depends on the cone number. The cone bends slowly at first but once it reaches the half way point (3 o'clock), it bends quickly. When the cone tip reaches a point level with the base, it is considered properly fired. This is the point for which temperature equivalents are determined. Differences between a cone touching the shelf and a cone at the 4 o'clock position are small, usually 1 or 2 degrees.

Temperatures shown on the charts were determined under controlled firing conditions in electric kilns and an air atmosphere. Temperatures are shown for specific heating rates. These heating rates are for the last 100° C or 180° F of the firing. Different heating rates will change the equivalent

temperature. The temperature will be higher for faster heating rates and lower for slower heating rates.

Cone bending may also be affected by reducing atmospheres or those containing sulfur oxides. Orton recommends the use of Iron-Free cones for all reduction firings (cones 010-3). If a cone is heated too fast, the cone surface fuses and binders used to make cones form gases that bloat the cone. If cones are to be fired rapidly, they should be calcined (pre-fired) before use. Cones should be calcined to about 850° F (455° C) in an air atmosphere.

If a cone is soaked at a temperature near its equivalent temperature, it will continue to mature, form glass and bend. The time for the cone to bend depends on several factors and as a general rule, a 1 to 2 hour soak is sufficient to deform the next higher cone number. A soak of 4 to 6 hours will be required to deform two higher (hotter) cones.

for more information on pyrometric cones, contact Orton or visit us at www.ortonceramic.com

The Edward Orton Jr. Ceramic Foundation
 P.O. Box 2760 • Westerville, OH 43086-2760
 (614) 895-2663 • (614) 895-5610 fax
info@ortonceramic.com
www.ortonceramic.com

These tables provide a guide for the selection of cones. The actual bending temperature depends on firing conditions. Once the appropriate cones are selected, excellent, reproducible results can be expected. Temperatures shown are for specific mounted height above base. For Self Supporting - 1 3/4"; for Large - 2"; for Small - 1 5/16". For Large Cones mounted at 1 3/4" height, use Self Supporting temperatures. * These Large Cones have different compositions and different temperature equivalents.

Temperature Equivalent Chart for Orton Pyrometric Cones (°C) Cone Numbers 022-14



Cone	Self Supporting Cones						Large Cones			Small	
	Regular			Iron Free			Regular			Iron Free	
	Heating Rate °C/hour (last 100° C of firing)										
	15	60	150	15	60	150	60	150	60	150	300
022		586	590				N/A	N/A			630
021		600	617				N/A	N/A			643
020		626	638				N/A	N/A			666
019	656	678	695				676	693			723
018	686	715	734				712	732			752
017	705	738	763				736	761			784
016	742	772	796				769	794			825
015	750	791	818				788	816			843
014	757	807	838				807	836			870
013	807	837	861				837	859			880
012	843	861	882				858	880			900
011	857	875	894				873	892			915
010	891	903	915	871	886	893	898	913	884	891	919
009	907	920	930	899	919	928	917	928	917	926	955
008	922	942	956	924	946	957	942	954	945	955	983
007	962	976	987	953	971	982	973	985	970	980	1008
006	981	998	1013	969	991	998	995	1011	991	996	1023
05½	1004	1015	1025	990	1012	1021	1012	1023	1011	1020	1043
05	1021	1031	1044	1013	1037	1046	1030	1046	1032	1044	1062
04	1046	1063	1077	1043	1061	1069	1060	1070	1060	1067	1098
03	1071	1086	1104	1066	1088	1093	1086	1101	1087	1091	1131
02	1078	1102	1122	1084	1105	1115	1101	1120	1102	1113	1148
01	1093	1119	1138	1101	1123	1134	1117	1137	1122	1132	1178
1	1109	1137	1154	1119	1139	1148	1136	1154	1137	1146	1184
2	1112	1142	1164				1142	1162			1190
3	1115	1152	1170	1130	1154	1162	1152	1168	1151	1160	1196
4	1141	1162	1183				1160	1181			1209
5	1159	1186	1207				1184	1205			1221
5½	1167	1203	1225				1201	1223			N/A
6	1185	1222	1243				1220	1241			1255
7	1201	1239	1257				1237	1255			1264
8	1211	1249	1271				1247	1269			1300
9	1224	1260	1280				1257	1278			1317
10	1251	1285	1305				1282	1303			1330
11	1272	1294	1315				1293	1312			1336
12	1285	1306	1326				1304	1324			1355
13	1310	1331	1348				1321*	1346*			N/A
14	1351	1365	1384				1366*	1388*			N/A

Pyrometric cones have been used to monitor ceramic firings for more than 100 years. They are useful in determining when a firing is complete, if the kiln provided enough heat, if there was a temperature difference in the kiln or if a problem occurred during the firing.

Cones are made from carefully controlled compositions. They bend in a repeatable manner (over a relatively small temperature range - usually less than 40° F). The final bending position is an indication of how much heat was absorbed.

Behavior of Pyrometric Cones

Typically, it takes 15 to 25 minutes for a cone to bend once it starts. This depends on the cone number. The cone bends slowly at first but once it reaches the half way point (3 o'clock), it bends quickly. When the cone tip reaches a point level with the base, it is considered properly fired. This is the point for which temperature equivalents are determined. Differences between a cone touching the shelf and a cone at the 4 o'clock position are small, usually 1 or 2 degrees.

Temperatures shown on the charts were determined under controlled firing conditions in electric kilns and an air atmosphere. Temperatures are shown for specific heating rates. These heating rates are for the last 100° C or 180° F of the firing. Different heating rates will change the equivalent

temperature. The temperature will be higher for faster heating rates and lower for slower heating rates.

Cone bending may also be affected by reducing atmospheres or those containing sulfur oxides. Orton recommends the use of Iron-Free cones for all reduction firings (cones 010-3). If a cone is heated too fast, the cone surface fuses and binders used to make cones form gases that bloat the cone. If cones are to be fired rapidly, they should be calcined (pre-fired) before use. Cones should be calcined to about 850° F (455° C) in an air atmosphere.

If a cone is soaked at a temperature near its equivalent temperature, it will continue to mature, form glass and bend. The time for the cone to bend depends on several factors and as a general rule, a 1 to 2 hour soak is sufficient to deform the next higher cone number. A soak of 4 to 6 hours will be required to deform two higher (hotter) cones.

For more information on pyrometric cones, contact Orton or visit us at www.ortonceramic.com



The Edward Orton Jr. Ceramic Foundation
 P.O. Box 2760 • Westerville, OH 43086-2760
 (614) 895-2663 • (614) 895-5610 fax
 info@ortonceramic.com
 www.ortonceramic.com

These tables provide a guide for the selection of cones. The actual bending temperature depends on firing conditions. Once the appropriate cones are selected, excellent, reproducible results can be expected. Temperatures shown are for specific mounted height above base. For Self Supporting - 1 3/4"; for Large - 2"; for Small - 1 5/16". For Large Cones mounted at 1 3/4" height, use Self Supporting temperatures. * These Large Cones have different compositions and different temperature equivalents.

TROUBLESHOOTING KILN FIRING WITH CONE PACKS

BASIC CONE INFORMATION

PYROMETRIC CONES

Pyrometric cones are made of clay and other minerals and are precisely formulated to soften when fired in a kiln. They will bend over when they have absorbed a certain amount of heat. The amount of heat is related to both time and temperature. They mirror fairly accurately what goes on in a ceramic body and can be a more reliable guide to firing than a thermocouple instrument.

Differing materials in the cones result in different firing temperatures. The cones you are likely to use in an L&L kiln are numbered from Cone 022 to Cone 10 (coldest to hottest). The number is imprinted on the cone. Usually clay and glaze comes with a recommended cone to fire to. A cone is a tall (about 2-½") pyramid made from specific damp-pressed ceramic materials. Each cone has a slight lean to it when placed on a flat surface. Be careful not to drop cones or expose cones to moisture.

CONES MEASURE HEAT-WORK

Cones are not temperature measuring devices. They measure how much heat has been absorbed by the ware in the kiln, which is the result of the combination of time and temperature. A particular piece of clay needs a certain amount of time at a specific temperature to properly fire it, lower temperature if the time is longer, higher temperature if the time is shorter. An example of this would be if you added about a 20 minute hold to the maximum temperature of a cone 6 firing, you would be able to lower that final temperature by about 20°F. An hour hold time would mean a final temperature of about 40°F lower. A two hour hold time, about 60°F lower.

LARGE SELF SUPPORTING CONES

Although there are various types of cones available we recommend using the "self-supporting large cones". They have a built-in base that allows the cone to sit flat while always placing the pyramid part of it at the proper angle. The angle is there to ensure that the cone bends in the direction you want it to, and doesn't just slump and puddle.

CONE PACKS

The best way to use the cones, especially if they are all you have to tell how hot your kiln is getting, is to use 'cone packs', or the three cone system. The three cones are placed in a line, aimed so that when they fall, they will fall in a line. The first cone to fall should be in the front of the three cone line. This cone should be one cone number lower than the one you wish to fire to. The target cone (the cone you wish to fire to) should be the next one to fall and should be in the middle. The last cone should be one cone number higher than the

target cone. The first cone is to warn you that the firing is almost done. The target cone tells you when to turn off the kiln, and the last cone tells you if the kiln got hotter than you thought it did.



Picture of a "cone pack" (Courtesy of Orton). The ones in the back are before the firing and the ones in the front are after a perfect firing/ These are Self-Supporting Large Cones.

USE CONES TO CONTROL ACCURACY IN AN AUTOMATIC KILN

We recommend checking the accuracy of your control and thermocouples every so often by placing at least one large cone (the target cone or cone number you are firing to) in the top, middle and bottom. Thermocouples will drift in their accuracy, but you can adjust the cone offset or thermocouple offset (or both) to compensate for this. You know how many degrees off the thermocouple reads at the end of the firing. Using a cone near the thermocouple and a "cone to temperature chart" will help to calibrate a thermocouple accurately. Remember though, cone temperatures are affected by their location in the kiln, the angle at which they are held, and the rate at which they are heated. Slight variations throughout the kiln should be expected. You can see a "cone to temperature" chart in the LOG, CONES, TIPS, CERAMIC PROCESS section of your manual or at hotkilns.com/orton-cone-chart.

TROUBLESHOOTING FIRING PROBLEMS

Seems like the kiln is under-firing or over-firing slightly

1) On the next firing make up "cone packs", one for each thermocouple. A cone pack is a set of three cones, standing in a line. The cone the firing should go to is called the target cone, and is in the middle. The one in front of it is one cone number lower, and the one behind it is one cone number

TROUBLESHOOTING KILN FIRING WITH CONE PACKS

higher. Pay attention to how you position the cones as they are designed to only fall in one particular direction if placed on a level surface. You do not want a lower-numbered cone stuck in the cone pack behind a higher-numbered cone because the lower-numbered one will fall first and might lean against or knock over the higher-numbered cone, which will compromise the accuracy of both cones.

2) Once the cone packs are positioned on shelves (or on a post lying on its side) and are visible through the peepholes, fire the kiln to the middle cone's number.

3) Near the end of the firing start watching the cone packs. Look for the first cone to fall over in each pack, not necessarily at the same time, but pretty close, probably in the middle zone first.

4) Now watch for the middle cone in each pack. Keep checking the DynaTrol display to be sure it does not say **CPLt**. The middle cone in each pack should start to fall at pretty much the same time in the top, middle and bottom of the kiln. When the tip of the cone touches the melted cone in front of it note the temperature readout on the display for that zone's thermocouple.

a) If the middle cones did not go down together then immediately note the differences in each thermocouple reading from the one thermocouple in the same zone as the first cone that went down. Later on, use the "thermocouple offset" feature to add or subtract degrees from each thermocouple accordingly. Use the differences between the thermocouple readings as a guide to know how much to offset each thermocouple.

b) If the three thermocouple temperatures are close enough to be reading the same thing (the middle cones did all go over at the same time), then the kiln should say **CPLt** right when the cone tips bend over and touch or just before it. If the kiln is still firing after this point, note how many degrees higher it goes before shutting itself off. Then use the "cone offset" feature to change the temperature equivalent of that cone. Subtract the same amount of degrees from the temperature equivalent that the kiln over-fired the cone by.

c) If the kiln shut itself off before bending the cones properly, you want to reprogram it and then re-start it as quickly as possible. Note the temperature at which the kiln shut down. Get from **CPLt** to **IdLE**, **tC2**, current temperature by pressing either **START/STOP** or **ENTER**. Re-program the same program to one cone number higher, then re-start the firing. Do these steps quickly. Now watch the middle cones again and note at what temperature the cones properly bend. If they bent while you were programming then just offset the temperature by 5 or 6 degrees. Shut the kiln off once you note that temperature. Using the "cone offset" feature, add

the difference of the two readings to that cone's temperature equivalent.

Note: From the factory, the settings that interpret temperature signals in the DynaTrol are hard-programmed; they will not change unless part of the microprocessor has been affected. There is a range of acceptability for the accuracy however and the cone offset feature exists to allow you to fine tune the kiln to particular sized loads. It is best to use all new thermocouples to properly tune the cone offset before individual thermocouples begin to drift. Even keeping one new thermocouple solely for calibrating the individual thermocouples will help to keep the kiln accurate.

CALIBRATING YOUR DYNATROL

This is also covered in the instruction sheet called BASIC OPERATION OF L&L KILNS WITH A DYNATROL 700 in the OPERATION section of your manual or at hotkilns.com/calibrating-kiln.

HELPFUL VIDEOS & LINKS

Calibration

More information on calibrating your kiln:
hotkilns.com/calibrating-kiln

Cone Offset

How to change cone offset in a DynaTrol:
hotkilns.com/change-cone-offset

How to change the thermocouple offset on a DynaTrol. This helps you calibrate the control to match your kiln:
hotkilns.com/change-thermocouple-offset

Firing with Witness Cones

This video shows you how to use witness cones to check the accuracy of the control and your kiln in an L&L Easy-Fire kiln. This video applies to any kiln:
hotkilns.com/firing-kiln-witness-cones

Orton Ceramic Institute

See ortonceramics.com for lots of very helpful information on how to use cones and for many firing tips and great information on firing kilns. See this: ortonceramic.com/Resources/Pyrometric_Cones

Cone Chart

You can see a "cone to temperature" chart in the LOG, CONES, TIPS, CERAMIC PROCESS section of your manual or at hotkilns.com/orton-cone-chart.

The Ceramic Process **Firing Tips**

What happens when you fire clay

LOADING KILN WITH GREENWARE

When placing greenware in a kiln, all pieces may touch each other. To prevent possible distortion, place lids on the pieces they go with when firing to bisque. It is important to place the tallest pieces on the center of the shelf and work outward to the shortest pieces. This will give you the best heat circulation. Be sure the ware is totally dry before firing (unless you use a very long drying cycle). Moisture in the work can cause cracking or even an explosion. We suggest using either the SLOW BISQUE program for heavy loads with a Preheat time of between two to three hours or the FAST BISQUE program for lighter loads (again with a Preheat time of two to three hours). If you want to make up your own program, use the preset program as a guide (see Appendix F in the DynaTrol instructions, hotkilns.com/dynatrol-instruct-blue.pdf, for a description of the segments in the preset programs). It is not a bad idea to Preheat the kiln overnight, as its only purpose is to thoroughly dry and start the expansion of the ware, so that the higher heat will not negatively affect it.

VENTING

If you are using the Vent-Sure automatic vent system, you can turn it on and leave it on during the entire firing. If you use an automatic vent, you do not normally need to prop the lid open or remove peephole plugs. If manually venting (without a powered vent), fire in the beginning with all the peepholes out. Then put bottom peephole plugs into peepholes after the low firing is over (you will know it is over when you start to see red heat through the peepholes). You typically want to leave the top peephole out during the entire firing if you do not have an automatic downdraft vent. NOTE: HEAVY GREENWARE MAY TAKE LONGER TO DRY. Be sure to use the Preheat feature in the DynaTrol for ensuring dry work. NOTE: If you have a lot of moisture in your work you may want to prop open the lid for the first hour of preheat even if you have an automatic vent system. (CAUTION: Propping open a lid in this way can cause the lid to crack if you are not careful. This is not covered in our warranty).

LOADING KILN WITH GLAZE WARE

When placing ware into the kiln to be glaze-fired, we suggest placing the pieces ½" apart so that when they expand there is no danger of them touching each other. If pieces are placed too close together, they may touch and stick to each other, thereby ruining both pieces of ware.



Except for placing ware the proper distance from each other for good heat circulation, follow the instructions for the firing of greenware. Be certain that no piece while expanding can touch the thermocouples. Use either the FAST GLAZE or SLOW GLAZE program depending on your glaze needs (experiment if you are not sure), or make up your own program. Ask the supplier of your glaze if you use a commercial glaze. There are some good firing recipes in various glaze books, including Mastering Cone 6 Glazes available from us. Your clay and glaze supplier will know the cone number to which you should fire your work.

OVERGLAZE FIRING

When firing overglazes such as Gold, Palladium, Mother of Pearl, China Paints, etc., the kiln must be vented during the firing up to 1,100°F. If you are manually venting, leave the peepholes open. (NOTE: This is if you are not using a vent system such as an L&L Vent-Sure which automates the venting process). Check with your clay and glaze supplier for recommended cycles.

Speed of firing

Although the kiln may be capable of firing relatively fast, this does not mean you should fire it as fast as it is capable of firing. The speed of firing will depend on what you are trying to accomplish. Check with the glaze or clay manufacturer or supplier for a recommended firing cycle.



Robert Shenfeld's studio in Syracuse NY where he produces production quantities of hand-crafted tiles.



505 Sharptown Road • Swedesboro, NJ 08085
Phone: 856.294.0077 • Fax: 856.294.0070
sales@hotkilns.com • hotkilns.com

KILNS BUILT TO LAST

Bulletin No: EQ-3-15

The Ceramic Process **Firing Tips**

SOAKING

Soaking is holding the kiln at any given temperature for a set amount of time. One purpose is to achieve uniform temperatures on the inside and outside of your pieces. Other benefits include the smoothing out of glazed surfaces to get rid of pin holes or craters in the glazed surface. During the bisque firing, people often hold at different temperatures to allow the clay body to out-gas more of its organic material. Holding is also useful at a low temperature like 150°F to 180°F to dry out pottery or kiln wash on shelves.

The downside to holding only happens at high temperatures. There is almost no downside to holding at low temperatures except increased firing time and slight element and thermocouple degradation from the extra firing time. At high temperatures the amount of degradation to the elements and thermocouples is exponentially greater. As a result, holding the kiln at a high temperature will affect the element and thermocouple life.

Try soak times in the range of 5 or 10 minutes at the most. If longer, exercise care as the kiln may over-fire your work. Compensate by reducing the cone's temperature in the cone offset setting, or raise the thermocouple offset. Use witness cones that you can see through your peephole (and be sure to use dark safety glasses when doing so). If you see the cones bending (which would indicate proper heat-work achieved), then you can always turn off the control at that point manually. The Orton website has a great program available for free which helps you calculate how different temperature ramps and hold times will affect the "heat-work" and cone bending in a kiln.

FIRING LOG

Keep a firing log. Keep track of firing times, approximate load weight, firing temperatures and notes on results of the firing. There is a sample log in our instruction manuals (hotkilns.com/log.pdf).

APPLYING KILN WASH

Kiln wash the floor of the kiln and the upper sides of the shelves only. Apply the kiln wash to the thickness of a postcard. The purpose of kiln wash is to prevent any glaze that drips from ware from sticking to the floor or shelves. If dripping should occur, remove dripping and cover the spot with new kiln wash. Kiln wash is a powder mixed with water to a light creamy consistency.

See page 53.

For best results, apply three separate coats. If you brush one coat on, let it dry and then brush on another; you can brush off the first in the process, so ideally each coat should be fired on. The shelf can be used while firing the kiln wash, so theoretically you would put one coat on, load the shelves and do your test-firing of the kiln. The second coat would be fired on in the first bisque and the third coat in the second bisque or first glaze (whichever comes next). Fire at least to cone 018—hot enough to give the kiln wash enough adherence to the shelf to prevent it from coming off in the second coating. Note that some people make do without three firings of the kiln wash. However, we include this recommendation as a "best practice".

What happens when you bisque and glaze in your kiln

When you fire a kiln, you chemically and physically alter clay and glaze compounds in a way that, to some degree, can be anticipated and accounted for. There is



These instructions refer to the use of our DynaTrol control "Easy-Fire" programs. If you have a manual kiln you will need to adjust the switches to achieve various cycles.

quite a bit more going on during firing than meets the eye. It is useful to divide the processing cycle into separate distinct stages or segments. The stages that clay and glaze go through in a typical firing can be divided as follows:

COMPLETE DRYING

Even after you room-dry your work there will be some moisture left in the seemingly dry ware. Your ware will pick up moisture from the air, even if it is left for weeks on a warm, dry shelf. Bisque ware can also absorb moisture during glazing, and the newly applied glaze is really a very fine-grained clay coating at this point; it will retain the water it was mixed with and the water in the air until it is completely dry.

When you put this piece in the kiln it will first go through a complete drying stage. This is where any water that was in your ware evaporates and expands to 1,170 times its original volume. This moisture must escape from your ware before the kiln temperature gets to 212°F. It is important that the kiln temperature climb very slowly at first, and that the lid be propped 1" with several soft pieces of firebrick or ceramic posts and the peepholes opened if there is no forced venting system. (CAUTION: Keep in mind that propping open a lid in this way can cause the lid to crack if you are not careful). If you have a lot of moisture in your work you may want to prop open the lid for the first hour of preheat even if you have an automatic vent system. The amount of drying needed depends on factors such as how much mass is in the kiln and how wet the ware is. Factors that lead to a longer drying time include fine-grained clay and thick-walled ware. Be sure to use the Preheat feature in the DynaTrol which automatically sets the kiln temperature at the right drying temperature. Preheating overnight is recommended. It is best to be conservative to prevent the ware from exploding in the kiln. After a while you will get a feel for how long is necessary. Remember to carefully vacuum out your kiln if a piece that is not fully dried explodes.

THE "CERAMIC CHANGE"

This happens to each crystal and mineral particle in the clay body. Even though water between the crystals and minerals has already evaporated (hopefully during the slow preheat time), there is still water in these crystals and minerals that is venting off. This can occur all the way until the kiln

The Ceramic Process **Firing Tips**

reaches red heat. Slow firing is not as critical as there are pathways for the steam to travel through where the water molecules between the particles used to be. Venting, however, is critical to remove the water vapor.

QUARTZ INVERSION

This is a generic name for the 20 or so changes quartz goes through as the temperature increases and the molecules/particles/atoms become increasingly mobile. Most phases that a particle of quartz goes through as the kiln is heating will reverse during cooling. One of the largest and quickest changes the quartz goes through is roughly at 1,060°F with about a 2% increase in the size of the particles during heating. The process is reversed during cooling. Also, during cooling another 2% contraction takes place at about 439°F. This is caused by the formation of "cristobalite" in some clay bodies. There is a lot of other material in your clay besides quartz, so it is not always that important to account for the quartz while the kiln is heating up. The structure of unfired clay is full of pores and non-glass bound particles, so it can withstand the expansion of a few of its quartz particles. Once the clay is fired, though, the particles become part of a solid mass of glass. This mass is extremely intolerant of the expanding quartz particles. This is especially true in the glaze firing (even more so if the bisque was even slightly under-fired). In under-fired ware the quartz never has a chance to react with the fluxes and remains intact during a second firing, ready to expand and contract as your kiln heats and cools. This is one cause of dunting (fine cooling cracks). The glass mass simply has no room for the expanding quartz crystals.

BURNOUT

This is the burning off of any trapped organic matter in the clay. Burnout generally takes place at and above red heat. Sufficient airflow and time are necessary to burn off all the organic matter. If a bisque piece is under-fired, or fired too quickly, any unburned organic matter will bubble up through the glaze during the second firing. Even if the bisque is properly fired, there will still be some organic matter in the clay that will burn out once you pass the bisque's firing temperature. A glaze that fluxes too early will block off the exits for the gasses in the clay body and cause bloating or pitting.

SINTERING

This is the point at which powdered clay particles will begin to form chemical bonds with each other. Although the clay is not melting yet, it is forming a lump from the powdered clay. The point at which this begins to happen is called the 'sintering point'. This, like burnout, happens right around red heat.

DECOMPOSITION

This is where fluxes really start to react and clay and glaze ingredients are deconstructed into their basic building blocks. This process can emit gasses such as sulfur and carbon dioxide which must travel out of the clay body. Once the firing is finished and the kiln cools, reconstruction takes place and the glaze and clay body recombine into a glass.

VITRIFICATION

This is a process that develops in the clay body during firing. At one point a piece of clay might be under-fired and at a higher point it may have good strength, but not good color; at another point it may be perfect and at another, even hotter point, the piece may warp, or melt. What is important to understand is that as the firing progresses, more and more activity is taking place on a molecular level. This is good only to a certain point, after which you are left with a warped blob, or puddle. You want to achieve the "glassification" of the clay. This occurs right before the clay body begins to slump. At this point the molecular bond between fluxes, quartz, silica and other materials makes the "glass". However, it is the formation of the long mullite crystals (which only occurs above 2,000°F) from the decomposing clay crystals that gives the ware its strength.

GLAZE SET, COOL & FREEZE

Unlike the clay body, the glaze melts completely, and the bond between it and the clay becomes more complete as the temperature rises; eventually, the glaze starts to run. Things like fluidity and surface tension are determined first by the chemistry of the glaze, then by the layer formed by the heightened interaction between the glaze and clay molecules. When the ingredients of the clay and glaze have been properly matched, the nature of the molten layer between the two is such that when the kiln is at maximum temperature during firing, things like pinholes and bubbles can rise through this layer and reach the surface from the clay body within, and not remain trapped in the surface when the glaze sets and begins to cool. Once maximum temperature is reached and the kiln begins to cool, the glaze and clay body will follow. The glaze will not solidify until some time after the kiln begins to cool. When this happens depends on the rate of cooling and the chemistry of the glaze. Right before the glaze solidifies, however, crystals can form. Depending on its chemistry, the glaze can solidify quickly and form crystals. Or, with some glazes, crystal formation can take place throughout the initial cooling until the glaze finally solidifies several hundred degrees lower than the highest temperature. By adjusting the glaze recipe slightly, one can maximize or minimize the forming of crystals in the glaze during cooling. Once the glaze solidifies it is still important for the kiln to cool slowly. Crazing



Bill Campbell at work.

"I make a living out of my five L&L kilns. I really beat them up firing them at least three times a week to Cone ten. They take a real beating and keep on going" -Bill Campbell

(fine cracking) can occur if cooling is too rapid. Heat shock, which is usually catastrophic, is something that can happen in the kiln or may occur gradually over time.

In truth, simply test-firing the kiln and the ware to be fired is usually enough to deal with the complexity of the process. Every kiln and kiln-load fires differently, and a new kiln is no exception. The use of a vent system is recommended simply because it will exhaust any detrimental particles and fumes from the kiln, circulate air in the kiln and provide an oxygen-rich atmosphere. See ortonceramics.com for helpful information on how to use cones, firing tips and great information on firing kilns. They have an excellent program available for free which helps you calculate how different temperature ramps and hold times will affect the "heat-work" and cone bending in a kiln.

Firing Glass in a Ceramic Kiln

How to use an L&L Ceramic Kiln with a DynaTrol to Fire Glass

BASIC IDEAS

Glass is not as forgiving as clay when fired in a kiln. Temperatures and firing times must be more precise; as such firing glass requires special considerations when fusing and slumping in a pottery kiln.

Using a kiln sitter with cones is a difficult process when fusing and slumping glass and will not be discussed here. The following instructions address how to use a DynaTrol digital controlled pottery kiln when fusing and slumping glass. Glass casting is a special process and is not covered by the following information.

Pottery kilns heat from the side elements where as glass kilns heat from the lid element and side element. In most glass kilns the lid element provides 70% of the heat and the side elements provide 30% of the heat. The lid element throws heat down in a uniform manner across the kiln shelf. The side element is only there to adjust for the height of the kiln.

A pottery kiln heats from the sides toward the center. Using a standard glass firing sequence in a pottery kiln will cause the glass pieces on the outer edges of the kiln shelf to fuse long before the glass pieces in the center of the kiln shelf. If firing a large piece of glass the outer edges will fuse quickly and trap air bubbles in the glass and by the time the center of the piece reaches fusing temperature the outer edges will be over fired and may become distorted and thin.

The number of stacked shelves (amount of furniture) will impact the firing of the kiln. Kiln furniture absorbs heat before the glass absorbs heat causing what is referred to a heat steal. Also impacting glass firing in a pottery kiln is the size of the kiln plus if the kiln is made of 3 inch brick will also affect the firing. Glass kilns tend to be shorter in height than potter kilns and are usually made of 2 ½ inch brick or refractory fiber board or blanket.

With side elements, kiln furniture, size of the kiln and brick thickness you must fire slow in a pottery kiln when firing glass. If you fire too fast you will have an over fire plus you may also thermoshock the glass causing it to break. If you cool too fast you

will thermoshock the glass causing it to break.

The following fusing sequences are to be used as a starting point from which you will develop your own firing sequence for successful firing of your projects. The sized of your kiln and how you load the furniture may require refining the sequence below.

You would use the same firing sequence for small jewelry pieces as well as large platters and bowls.



On the left of the DynaTrol digital controller is a yellow section labeled "VARY-FIRE". This feature has 6 user programs each user program has 8 segments. A segment permits the artist to input firing sequences with a specified ramp rate in degrees per hour, a soak temperature, and a soak time. These three items comprise a segment. You select the number of segments needed for your firing sequence.

Simple firings like jewelry and small plates and bowls you should be able to obtain good results with the use of 2 segments.

If you are loading the kiln with multiple shelf levels or a single shelf you would use the 3 zone feature of your kiln to obtain uniform heating.

The assumption is made that you already know how to safely and correctly operate your DynaTrol digital controlled kiln. The following information is provides a guide line for adjusting your firing from pottery to glass.

The following information is not to replace the instructions provided in your kiln owner's manual. Refer to the owner's

manual for complete information on the operation and features of the DynaTrol digital controller.

After loading your kiln you would set the DynaTrol digital controller in the following manner.

NOTE: All degrees listed below are degrees F. If you want to use degrees C you will need to set the controller for degrees C and convert the degrees F below to degrees C for you firing.

The firing schedule below is for use with Bullseye, Uroboros, or Spectrum Glass. It is not for use with float or borosilicate glass.

FUSING GLASS

1. If the kiln has an off/on switch, turn the kiln on.
2. The kiln should indicate it is in the idle mode by flashing "Idle", the number of zones and the temperature inside the kiln.
3. Press the "Enter Prog" key in the VARY-FIRE section. You will see the display flashing between "USER" and a number between 1 and 6. At this point you want to choose which USER program you want to use. You can set USER 1 for a fusing project and you can set USER 2 for a slumping project, as an example.
4. Press the number 1 on the key pad, then press the ENTER button in the number key pad area. You have chosen to use "USER 1"
5. The display will now flash SEGS and a number. It is asking how many segments you want to use for your firing.
6. Press the number 2 on the key pad, then press the ENTER button in the number key pad area. You have chosen to use 2 segments for your firing.
7. The display will now flash RA 1 and a number. It is asking for the ramp rate in degrees per hour for the first segment.
8. Pressing the number keys enter 150, then press the ENTER button in the number key pad area. You have instructed the controller to heat at 150 degrees per hour. This means that after 1 hour the kiln will be at room temperature plus 150



505 Sharptown Road • Swedesboro, NJ 08085
Phone: 856.294.0077 • Fax: 856.294.0070
sales@hotkilns.com • hotkilns.com

KILNS BUILT TO LAST

Bulletin No: GLASS-3-15

Firing Glass in a Ceramic Kiln

degrees, after 2 hours it will be at room temperature plus 300 degrees, and so forth.

9. The display will now flash °F 1 and a number. It is asking for the soak temperature for the first segment.

10. Pressing the number keys enter 1450, then press the ENTER button in the number key pad area. You have instructed the controller to heat to 1450 °F. This means that the kiln will heat at a rate of 150 degrees per hour and go to 1450 degrees, taking roughly 9.66 hours to do so.

11. The display will now flash HLd 1 and a number with a decimal point 2 digits to the left, You may have a number which looks like 12.30 or 1.20 or 0.20. The decimal point separates minutes from hours. Hours to the left of the decimal point and minutes to the right of the decimal point. It is asking for the soak time period for the first segment.

12 - Pressing the number keys enter 15, then press the ENTER button in the number key pad area. You have instructed the controller to soak for 15 minutes. On review of the program you would see: 0.15. You have entered the first segment.

13. The display will now flash RA 2 and a number. It is asking for the ramp rate in degrees per hour for the second segment.

14. Pressing the number keys enter 150, then press the ENTER button in the number key pad area. You have instructed the controller to cool at 150 degrees per hour.

15. The display will now flash °F 2 and a number. It is asking for the soak temperature for the second segment.

16. Pressing the number keys enter 100, then press the ENTER button in the number key pad area. You have instructed the controller to cool to 100 °F. This means that the kiln will cool at a rate no faster than 150 degrees per hour and go to 100 degrees, taking roughly 14.5 hours to do so.

17. The display will now flash HLd 2 and a number with a decimal point 2 digits to the left, You may have a number which looks like 12.30 or 1.20 or 0.20. The decimal point separates minutes from hours. Hours to the left of the decimal point and minutes to the right of the decimal point. It is asking for the soak time period for the second segment.

18. Pressing the number keys enter 30, then press the ENTER button in the number key pad area. You have instructed the controller to soak for 30 minutes. On review of the program you would see: 0.30

19. The display will now flash ALRM and 9999. It is asking if you want to have an alarm sound when the kiln reaches a particular temperature. The number 9999 instructs the controller NOT to sound any alarm.

20. Press the ENTER button in the number key pad area, with the 9999 number in the display, if you do NOT want an alarm. If you want the controller to sound an alarm notifying you that it has reached a particular temperature enter that temperature number on the key pad and then press the ENTER button in the number key pad area.

21. The display will now display CPL for a few seconds then switch to the IdLE mode. You have entered the second and final segment. The digital controller has the above firing sequence in its memory as USER 1. It will remember this firing sequence even after the kiln is turned off. You can edit and change the firing sequence any time.

22. When the display is in the IdLE mode press the "Recall Prog" button in the VARY FIRE section of the key pad. The display will flash USER and a number. Press the number 1 and then press the "START /STOP" button. The display will briefly show STOP then switch to the IdLE mode. Press the START/STOP button again. The display will show -- ON -- and the controller will start the firing the USER 1 program.

Note: The digital controller does not understand heating or cooling. It only understands what temperature it is at and what temperature it is to go to. Thus it will adjust the firing to go to the destination temperature.

The above glass firing sequence has instructed the kiln to do the following.

Heat at 150 degrees per hour, go to 1450 degrees, stay at that temperature for 15 minutes then cool at 150 degrees per hour, go to 100 degrees and stay at that temperature for 30 minutes then stop firing.

SLUMPING GLASS

To slump glass you will use the same sequence however you must change the

soak temperature from 1450 degrees to 1250 degrees, all other values remain the same.

HOW TO CORRECT FOR OVER OR UNDER FIRING WITH THE ABOVE FIRING SEQUENCE

Only change one variable at a time.

1. I suggest that you adjust the soak time not the temperature.
2. If the glass is over fired reduce the soak time by 5 minutes.
3. If the glass is under fired add 5 minutes to the soak time



ANNEALING GLASS

The above firing sequence passes through the annealing temperature so slowly that the glass is annealed. If you want to use a formal annealing cycle you would use 3 segments with the second segment having the annealing soak temperature and soak time in it. The heating and cooling rate would remain the same.

Marty Dailey - Sept 2006

- Orton Firing Tips -



hotkilns.com/support/pdfs/orton-firing-tips

LOADING A KILN FOR BEST RESULTS	Pages 1-2	FIRING CERAMIC BODIES	Pages 17-18
First the Furniture		Gases	
Setters and Stilts		Firing Conditions	
Consider Heat Distribution		Types Of Bodies	
Don't Overfill		Critical Firing Periods	
UNDERSTANDING HEAT TRANSFER	Pages 3-4	FIRING LEAD FREE GLAZES	Pages 19-20
How Heat is Transferred		Changes In Glazes	
Convection		Why Do Problems Occur?	
Conduction		Glaze And Body Fit	
Radiation		Is Your Kiln Uniform In Temperature?	
Incomplete Burn Out		FIRING RED GLAZES	Pages 21-22
Preventing Incomplete Burnout		Common Red Glaze Problems	
CRACKING AND THERMAL SHOCK	Pages 5-6	Preparation and Application	
Why Does Cracking Occur?		How Colors Develop	
What Happens to Ware During Firing?		Controlling the Firing Rate	
Reducing Thermal Shock		Venting for Proper Air	
CRACKING AND WARPING CAUSED BY DRYING AND CASTING	Pages 7-8	Firing to Proper Cone Number	
Drying Ceramics		UNDERSTANDING CRAZING	Pages 23-24
Understanding Drying		What is Crazing	
Drying Faults		SOLVING GLAZE DEFECTS, BLISTERS, CRATERS AND PINHOLES	Pages 25-26
Reducing Warping And Cracking		What Causes These Defects?	
Drying Techniques		What Happens During Firing?	
USING THE THREE CONE SYSTEM	Pages 9-10	How Do I Solve Glaze Defects?	
What is the Three Cone System		SUCCESSFUL GLASS FUSING	Pages 27-28
Uses for the Three Cone System		Glass Compatibility	
How Witness Cones Work		Glass Sticking	
Using the Three Cone System for Manual Shut-off		Glass Heating Too Rapidly	
Using the Three Cone system to Evaluating Kiln Performance		Glass Annealed Too Quickly	
Checking Kiln-Sitter® Performance		SUCCESS WITH GOLDS	Pages 29-30
Witness Cones Are Like Insurance		Bright Golds	
CONES AND CONTROLLERS	Pages 11-12	Burnished Gold	
Advantages of Controllers		Firing Golds	
Firing Ceramics		Typical Gold Faults	
Firing With Cones		SUCCESS WITH DECALS	Pages 31-32
How Controllers Work		Firing Decals	
Measuring Temperature		Determining Firing Range	
Using Controllers and Cones		Color Development	
AVOIDING CARBON BURNOUT PROBLEMS	Pages 13-14	Measuring Heatwork	
How Carbon Burns Out		Measuring Heat Distribution	
Incomplete Burn Out		MAKING FOODSAFE WARE	Pages 33-34
Preventing Incomplete Burnout		What Type of Ware?	
FIRING HANDBUILT OR THICK CAST WARE	Pages 15-16	Making Smart Glaze Choices	
Firing Issues		How to Decorate	
Heating & Cooling Control		Safe Firing	
		Regulations	
		How to Test for Lead Release	

DAVINCI INSTRUCTION MANUAL

TROUBLE
SHOOTING



TROUBLESHOOTING AND REPAIR INSTRUCTIONS FOR L&L KILNS

TABLE OF CONTENTS

TROUBLESHOOTING GUIDE	2
VIDEOS	2
TROUBLESHOOTING WEB TOOLS	2
RELATED L&L GUIDES	2
CAUTION INSTRUCTIONS	2
REGULAR KILN MAINTENANCE	2
BASIC ELECTRICITY FOR TROUBLESHOOTING.....	2
TROUBLESHOOTING BRICK PROBLEMS.....	2
TROUBLESHOOTING ELEMENT PROBLEMS.....	3
TROUBLESHOOTING FIRING PROBLEMS WITH CONE PACKS.....	3
THE CERAMIC PROCESS.....	3
REPLACEMENT PARTS.....	3
SERVICE.....	3
GENERAL TROUBLESHOOTING TOOLS AND METHODS	3
BASIC TOOLS REQUIRED.....	3
KEYS TO GOOD TROUBLESHOOTING	3
SAFETY FIRST	3
DEFINE THE VARIABLES	3
ELIMINATE VARIABLES ONE AT A TIME	3
Err1 (ERROR 1) - THE MOST COMMON ERROR.....	3
CONTROL DISPLAY DOESN'T SHOW ANYTHING.....	3
On/Off Switch	3
Fuse.....	3
Fuse Holder	4
On/Off Switch	4
Plug & Cord (if you have one).....	4
Circuit Breaker / Power Source	4
Control Transformer	5
Control Board.....	5
Internal Wiring.....	5
Short Circuits.....	5
EASY-FIRE DISPLAY READS FAIL.....	5
EASY-FIRE DISPLAY READS 2400 or CPLt WHEN IT STARTS UP.....	6
ONE-TOUCH CONTROL DISPLAY READS FAIL.....	6
DISPLAY IS NORMAL BUT KILN WON'T HEAT UP	7
Programming.....	7
Wiring.....	7
EASY-FIRE Control Board Outputs	7
ONE-TOUCH Control Board Outputs.....	7
Bad Power Relays	7
Bad Elements	7
Run a Simple Paper Test.....	7
KILN FIRES UNEVENLY	8
Peepholes.....	8
Lid Seal.....	8
Elements	8
8	
Loading.....	8
Firing with Cones	8
EASY-FIRE Thermocouple Offsets	9
ONE-TOUCH Thermocouple Offsets.....	9
Vent System	9
KILN FIRES TOO HOT OR COLD.....	9
Firing with Cones.....	9
Easy-Fire vs Vary-Fire (on DynaTrol)	9
Be Careful with Hold Times.....	9
Control Settings and Calibration.....	9
Thermocouple Drift.....	9
KILN STALLS.....	9
KILN FIRES SLOWLY - BOTH SERIES.....	10
Run a Simple Paper Test.....	10
Bad or Wrong Voltage.....	10
Element Aging	10
Power Relays	11
Bad Wiring.....	11
Wiring in the Kiln.....	11
Element Connections.....	12

Heat Leakage & Vents	12
Adding More Insulation	12
KILN FIRES SLOWLY - EASY-FIRE.....	12
Single vs Three Zone Control.....	12
ShtO (SHUT-OFF) SETTING	12
Pld SETTING.....	13
Change elements to graded elements	13
KILN HEATS TOO FAST	13
Relays.....	13
Voltage.....	13
Elements	13
EASY-FIRE ERROR MESSAGES.....	13
Errd	14
Err1	14
Err2	15
Err3	15
Err4	15
Err5	15
Err6	15
Err7	15
Err8	15
ErrP + PF	15
Err-	15
FAIL	15
Turning Error Codes On or Off.....	16
Can you restart the kiln after it stops because of Error Codes?.....	16
Worst Case Scenario for Restarting After an Error Code.....	16
ONE-TOUCH ERROR MESSAGES.....	17
Errd	17
Err1	17
ErrP	18
ErrF	18
tC-	18
FAIL	18
Can you restart the kiln after it stops because of Error Codes?.....	18
Worst Case Scenario for Restarting After an Error Code.....	18
SERVICE FOR YOUR KILN	19
WHERE TO GET SERVICE	19
WHERE TO BUY PARTS.....	19
REPLACEMENT ELEMENTS	19
REMOVING PANEL FOR SERVICE.....	19
REPLACING DYNATROL	19
REPLACING ONE-TOUCH™.....	20
REPLACING TRANSFORMER.....	20
REPLACING POWER RELAYS	21
REPLACING FUSE HOLDER	21
REPLACING THERMOCOUPLES	21
CHECKING ELEMENT OHMS.....	22
Element Ohm Charts	22
CHANGING ELEMENTS	22
SEE THESE VIDEOS FIRST	22
REPLACING ELEMENT HOLDERS	22
CRACKS IN THE LID & BOTTOM.....	22
TIGHTENING STAINLESS BANDS.....	22
REPLACING FIREBRICK IN SIDES.....	22
DRILLING OUT HOLES FOR PEEPHOLES	22
DRILLING OUT FOR ELEMENT CONNECTIONS	22
REPLACING BOTTOMS	23
REPLACING LIDS	23
MORE ABOUT TROUBLESHOOTING CERAMIC PROBLEMS..	23
Photo of a 1-phase control panel for a three section Easy-Fire kiln.....	24
Photo of a 3-phase control panel for a three section School-Master kiln.....	25

TROUBLESHOOTING AND REPAIR INSTRUCTIONS FOR L&L KILNS

CAUTION - ELECTRICITY CAN KILL

Many of the tests described in here are performed under power. They should be done **ONLY** by someone who is familiar with electrical safety such as an electrician or trained maintenance person. We identify any test that is live with a CAUTION statement. We describe these tests in detail so that an electrically trained person who doesn't specifically understand kilns can do the troubleshooting - the level of simplicity described is not meant as an invitation to harm the untrained. **AS LONG AS THE KILN IS UNPLUGGED YOU ARE SAFE.**

GET A DIGITAL MULTIMETER!

If you want to do much of the troubleshooting described here and not be dependent on a kiln service person then get this tool. It is not hard to use! Without it you are only guessing at the origin and severity of an electrical problem based on how the kiln is acting. A slow-firing kiln may just have old elements, or the elements could be fine but the incoming voltage from your power supply could be low, or fluctuating. Unless you test with a multimeter, you could purchase new elements and run the risk that you might be wasting money and time without solving the problem. Be forewarned however: Testing electrical circuits is very dangerous and potentially deadly if you do it incorrectly. It could result in electrocution! If you don't feel comfortable doing this hire an electrician or get someone to do it who is qualified. That being said - many of the tests described in here just require testing for resistance - which is done with the kiln unplugged. **AS LONG AS THE KILN IS UNPLUGGED YOU ARE SAFE.**

You can buy an inexpensive digital multimeters for around \$40-\$50. The meter you buy should be digital simply because the analog type is not very accurate. **You must be able to see ohm (resistance) readings to the first decimal**



TROUBLESHOOTING GUIDE

This manual is meant to assist and educate kiln owners and service technicians. Our basic philosophy at L&L is to make kilns that last. No small part of having a reliable well-firing kiln is good maintenance. This information is provided as a service and is believed to be accurate. However, it is the reader's sole responsibility to interpret and use this information correctly. Please visit our web site to download the latest versions of all our instructional and technical information.

VIDEOS

ALSO WE ENCOURAGE YOU TO USE THE VIDEOS ON OUR WEB SITE (hotkilns.com/videos).

TROUBLESHOOTING WEB TOOLS

The latest troubleshooting information is on the web. This is constantly updated. See hotkilns.com/knowledgebase

RELATED L&L GUIDES

CAUTION INSTRUCTIONS

See CAUTION INSTRUCTIONS FOR L&L KILNS in the CAUTIONS section of your Instruction Manual. THIS IS SOMETHING YOU MUST READ. (Also hotkilns.com/cautions)

REGULAR KILN MAINTENANCE

See REGULAR MAINTENANCE OF YOUR L&L KILN in the MAINTENANCE section of your Instruction Manual. THIS IS SOMETHING YOU MUST READ.

BASIC ELECTRICITY FOR TROUBLESHOOTING

See BASIC ELECTRICITY FOR TROUBLESHOOTING KILNS in the TROUBLESHOOTING section. Also see hotkilns.com/volts for more in-depth information about electricity for kilns.

TROUBLESHOOTING BRICK PROBLEMS

See TROUBLESHOOTING AND FIXING BRICK PROBLEMS in the TROUBLESHOOTING section for information on firebrick problems and instructions on how to repair firebrick problems.

TROUBLESHOOTING AND REPAIR INSTRUCTIONS FOR L&L KILNS

TROUBLESHOOTING ELEMENT PROBLEMS

See ELEMENT TROUBLESHOOTING & INSTALLATION INSTRUCTIONS in the TROUBLESHOOTING section for information on elements problems and instructions on how to install elements and element holders.

TROUBLESHOOTING FIRING PROBLEMS WITH CONE PACKS

See TROUBLESHOOTING KILN FIRING WITH CONE PACKS in the LOG, CONES, TIPS section.

THE CERAMIC PROCESS

See THE CERAMIC PROCESS in the LOG, CONES, TIPS section.

REPLACEMENT PARTS

See the PARTS section.

SERVICE

See SERVICE section.

GENERAL TROUBLESHOOTING TOOLS AND METHODS

BASIC TOOLS REQUIRED

The minimal toolkit necessary for effective troubleshooting and fixing of electric kilns contains a digital multi-meter to measure ohms and AC voltage, and an assortment of screwdrivers, nutdrivers, wrenches, pliers, cutters, wire strippers and wire terminal crimpers. As you work on your kiln you will see what types of tools you need, like a 3/8" nut-driver, needle-nose pliers without the cutting part so the tips will close all the way. wire cutters heavy enough to cut the element terminals, wire strippers and wire terminal crimpers. No special tools are required for maintenance on L&L kilns.

KEYS TO GOOD TROUBLESHOOTING

SAFETY FIRST

Pay attention to electrical safety. Don't get electrocuted and don't guess.

DEFINE THE VARIABLES

Define all variables of the situation, and how they could potentially interact with and affect each other in each unique case you come across.

ELIMINATE VARIABLES ONE AT A TIME

Eliminate variables one by one to expose the problem variable(s). Asking questions can do this to some degree. Electrical testing, examining shards of ware or cone, or examining the interior of the kiln usually can supply the rest of the story. Good troubleshooting is based on logic.

Err1 (ERROR 1) - THE MOST COMMON ERROR

This is the most common troubleshooting problem we see. It generally means one of two things. 1) The elements have aged with increased resistance and therefore lower power. 2) A relay is not working. See The section in these instructions on Error Codes, CHECKING ELEMENT OHMS, and various paragraph on checking the relays. There are several good videos (hotkilns.com/videos) about how to check relays and ohms.

CONTROL DISPLAY DOESN'T SHOW ANYTHING

On/Off Switch

1) Make sure the On/Off Switch is turned on. Turn it on and off.

Fuse

1) Check control fuse in side of control box. Twist open the fuse holder and physically check the fuse. If the metal element inside is melted if it is blown. You can also use your digital multi-meter to check continuity across the fuse. Replace if faulty: hotkilns.com/control-panel-fuse

Picture of the on/off switch and fuse holder opened.



Fuse Holder

If you notice that the fuse holder itself is damaged replace it. See: hotkilns.com/change-fuse-holder

TROUBLESHOOTING AND REPAIR INSTRUCTIONS FOR L&L KILNS

On/Off Switch

The on/off switch rarely needs replacing but if you have to replace that see this video: hotkilns.com/replace-on-off-switch

Plug & Cord (if you have one)

1) Make sure the power cord is plugged into the receptacle. Reseat plug. Make sure it is held firmly and that the springs inside the receptacle seem to be working.

2) With power off examine the electrical cord. Look for burned or melted areas and breaks or pinched sections. Look closely at the head of the plug. If there is an internal problem with the wires and the plug parts you won't be able to see it but you may detect a softening or melting of the plastic at the plug head. Look for oxidation or substantial discoloration or even burnt spots on the prongs. Replace plug and cord if this is questionable.

3) With power turned on and panel open check voltage at the Power Terminal Block. If you see no voltage there then you know something is wrong with the power source.

CAUTION: This test should only be done by an experienced person familiar with electricity and its dangers.

If you have to replace the power cord see this video. It includes video of changing a power cord. hotkilns.com/change-phase-easy-fire

Checking voltage at the power terminal block.



Circuit Breaker / Power Source

1) Check voltage at the receptacle. **CAUTION: This test should only be done by an experienced person familiar with electricity and its dangers.**

A fused disconnect switch.



2) Check circuit breaker or fused disconnect switch to make sure they are turned on. Sometimes circuit breakers need to be turned on and off to reset them.

3) If you have a fused disconnect check the fuses with your voltmeter for continuity. **CAUTION: This test should only be done by an experienced person familiar with electricity and its dangers.**

4) Make sure fuses or circuit breaker are the proper amperage and type. See wiring diagram for details.

5) Test for voltage at the main power supply as close to the kiln as possible. **CAUTION: This test should only be done by an experienced person familiar with electricity and its dangers.**

Control Transformer

See this video: hotkilns.com/check-control-transformer and hotkilns.com/change-transformer.

1) If none of these solve the problem then you could have a bad control transformer. To check the transformer operation test with your digital multimeter. It should read 240 (or 208) volts across terminals 1 & 4 (black and white wires) and 24 volts across terminals 5 & 8 (where the gray and brown wires come out). This is a live test so be very careful not to touch any of the wires - remember there is 240 volts in the panel and this can electrocute you. See photo below. If you are receiving 240/208 Volts in, but not getting the proper approximate 24 Volts out, then you need to replace the control transformer. See: hotkilns.com/control-transformer-12-va

2) If there is no voltage coming into terminals 1 & 4, white & black, then test for it at the Power Terminal Block where the power cord comes in. If there is power there then look for a bad connection or wire between the power connection block and the transformer, i.e. a bad toggle switch, wire, or ½ amp fuse holder. If power is not there then go further

TROUBLESHOOTING AND REPAIR INSTRUCTIONS FOR L&L KILNS

back on the line and measure the voltage. Keep going until you find voltage, then look for the problem between that point with the voltage and the last point checked that had no voltage.

Control Board

1) If the transformer is OK and you know you have voltage going to the control board but the control still shows no display then the control board needs to be replaced.

DynaTrol: hotkilns.com/dynatrol-control-board

Genesis: hotkilns.com/genesis-control-board

One-Touch for School-Master kilns: hotkilns.com/one-touch-control-board-cone-6

One-Touch for Doll, Liberty-Belle and Fuego kilns: hotkilns.com/one-touch-control-board-cone-10

See this for how to replace: hotkilns.com/replace-dynatrol

Internal Wiring

1) Unplug kiln or turn off at circuit breaker or fused disconnect and open up panel. CHECK VOLTAGE TO BE SURE. Make sure that all the wires inside the control panel are connected. See photograph on page 2 or page 3 and also the Wiring Diagram. Specifically look at the wires that go from the power connection block to the on/off switch, then to the control fuse and then to the control transformer.

Short Circuits

Do all the following with the kiln unplugged.

1) Check for short circuits. Look for any signs of burnt wires. This might indicate a short circuit. A way this might happen, as an example, is that frayed wires at the end of a wire connector might touch each other.

2) Check for worn wires that may have shorted against the case. Examine wire insulation. If the wire insulation has become frayed the wires could short to the metal casing which is electrically grounded.

3) Look for dirt. Some dirt (such as carbon compounds) are electrically conductive. This is generally not the case with ceramic materials but some can be. Vacuum out if you see dirt.

NOTE: Usually a short circuit will trip either the circuit breaker for the kiln or the fuses in the fused disconnect switch, if you have one. You will then not see any display on the DynaTrol. Turn your circuit breaker on and off, and check fuses on the fused disconnect and control fuse.

CAUTION: These tests should only be done by an experienced person familiar with electricity and its dangers.

Checking output of the Control Transformer (DANGER-live test).

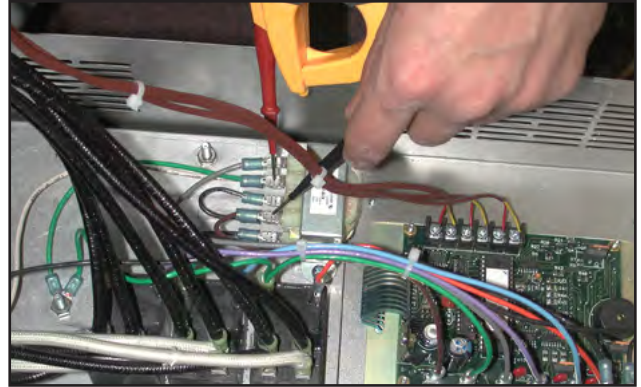

EASY-FIRE DISPLAY READS FAIL

Usually FAIL will be seen flashing along with a tC1, tC2 or tC3 indicating which thermocouple circuit has failed.

Typically this will just mean that your thermocouple(s) need replacing. Overtime the thermocouple tip will corrode and cause a circuit to FAIL. We recommend replacing all thermocouples simultaneously rather than as they fail.

See this to replace thermocouple: hotkilns.com/change-thermocouple

1) Unplug the kiln. Open the Control Panel. Remove the offending thermocouples connection wires from the Thermocouple Terminal Strip and bind the red and yellow wires together with electrical tape. Close up the panel and plug in the kiln. The control should read room temperature for that thermocouple (approximately 90 Deg F because of the thermocouple offsets).

2) If it does read room temperature then the thermocouple is probably bad and needs to be replaced. If the control does not read room temperature then there is either a bad thermocouple wire in the Control Thermocouple Harness or the control is bad.

3) Redo the test by putting a small jumper like a paperclip across the thermocouple terminals directly on the DynaTrol board. If the control now will read room temperature then you have a bad thermocouple wire. If it does not read room temperature then the control is definitely bad and needs to be replaced. See this: hotkilns.com/replace-dynatrol

EASY-FIRE DISPLAY READS 2400 or CPLt WHEN IT STARTS UP

Even though you know the kiln is not that hot. This

TROUBLESHOOTING AND REPAIR INSTRUCTIONS FOR L&L KILNS

indicates thermocouple circuit failure.

TECHNICAL NOTE: This is called thermocouple upscale protection. If the control senses a lack of millivoltage (an open circuit) it interprets this as the highest temperature the control could reach. This automatically ensures that the control will not call for power.

1) Check thermocouple end. Examine end carefully. Sometimes there can be a crack that opens up while the kiln is hot but appears to be normal when the kiln is cold. If the end of the thermocouple looks severely corroded and you are getting Error codes then it is best to replace the thermocouple. NOTE: You have to open up the Element Cover Box and remove the thermocouples to check the ends.

A thermocouple end that will still work but is getting close to creating a problem.

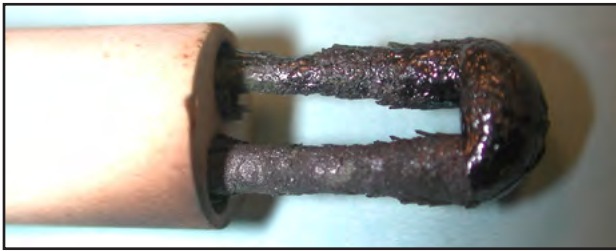

2) Check thermocouple circuit. For instance check to make sure that all the thermocouple lead wires are firmly connected to the Thermocouple Terminal Strip. Check where the thermocouple lead wires go into the ends of the thermocouples. Are the wires loose? Tighten the screws on the ends of the thermocouples to be sure you have a tight connection. Check for corrosion. Check where the thermocouples connect to the DynaTrol. Try pulling off each connection and reseating it. This can scrape away corrosion that may have built up. Check for melted wires inside the Element Cover Box.

3) A very easy check is to check resistance (ohms) right on the Thermocouple Terminal Strip. Unplug kiln or disconnect from live power by turning off circuit breaker or fused disconnect switch. Open panel. You don't even have to remove the thermocouple wires. Just touch the terminal strip itself with your probes (terminals #1 & #2 for TC1, terminals #3 & #4 for TC2 and terminals #5 & #6 for TC3). If the thermocouples and circuit is normal then you will see a resistance of about .9 or 1.0. If you see an **OL** in your meter then you have an open circuit somewhere which is probably a bad thermocouple.

4) If you have a bad thermocouple replace it with a new one. Although you may be able to "make it work" by

twisting the ends of the wire together this could easily fail during an important load and could also be extremely inaccurate.

ONE-TOUCH CONTROL DISPLAY READS FAIL

Usually **FAIL** will be seen flashing along with a **tC** indicating the thermocouple has failed.

1) Check thermocouple end. Examine end carefully. Sometimes there can be a crack that opens up while the kiln is hot but appears to be normal when the kiln is cold. If the end of the thermocouple looks severely corroded and you are getting Error codes then it is best to replace the thermocouple. NOTE: You have to open up the Element Cover Box and remove the thermocouple to check the end.

See this to replace thermocouple: hotkilns.com/change-thermocouple

2) Check thermocouple circuit. For instance check to make sure that all the thermocouple lead wires are firmly connected to the Thermocouple Terminal Strip. Check where the thermocouple lead wires go into the ends of the thermocouples. Are the wires loose? Tighten the screws on the ends of the thermocouples to be sure you have a tight connection. Check for corrosion. Check where the thermocouples connect to the DynaTrol. Try pulling off each connection and reseating it. This can scrape away corrosion that may have built up. Check for melted wires inside the Element Cover Box.

3) A very easy check is to check resistance (ohms) right on the Thermocouple Terminal Strip. Unplug kiln or disconnect from live power by turning off circuit breaker or fused disconnect switch. Open panel. You don't even have to remove the thermocouple wires. Just touch the terminal strip itself with your probes (terminals #1 & #2 for TC1, terminals #3 & #4 for TC2 and terminals #5 & #6 for TC3). If the thermocouples and circuit is normal then you will see a resistance of about .9 or 1.0. If you see an **OL** in your meter then you have an open circuit somewhere which is probably a bad thermocouple.

4) If you have a bad thermocouple replace it with a new one. Although you may be able to "make it work" by twisting the ends of the wire together this could easily fail during an important load and could also be extremely inaccurate.

TROUBLESHOOTING AND REPAIR INSTRUCTIONS FOR L&L KILNS

DISPLAY IS NORMAL BUT KILN WON'T HEAT UP

Programming

1) Make sure you have programmed the kiln properly and it is supposed to be firing. Do you have a **Delay Time** or a **Preheat Time** in your program? (Hit the **Review Prog** button on the Easy-Fire or hold down the **Custom/Review** button on the School-Master to find out).

Wiring

1) Unplug kiln or disconnect from live power by turning off circuit breaker or fused disconnect switch. Open panel. Check all power wires for firm connections. Using your multimeter set on resistance you can check continuity of each element circuit by placing the probes on each set of outputs on each Power Relay or right at the Power Terminal Strip (as shown below).

Picture showing a Multimeter testing for continuity in an element circuit.



2) Visually inspect the power wires coming from the Power Terminal Block to the inputs of the Power Relays. Reseat all the spade connectors to rub off any oxides and to ensure a good connection.

EASY-FIRE Control Board Outputs

1) It is possible that the internal switches on the DynaTrol or Genesis control board could be bad. You can test that by checking to see if you find voltage (12 volts DC) between any of the output contacts on the control board (where the orange, blue and purple wires come out) to ground (any green wire). CAUTION: This test should only be done by an experienced person familiar with electricity and its dangers. See this video: [hotkilns.com/ check-switches-dynatrol](https://www.hotkilns.com/check-switches-dynatrol)

ONE-TOUCH Control Board Outputs

1) It is possible that the internal switches on the One-Touch™ control board could be bad. You can test that by checking to see if you find voltage (12 volts DC) between the output contacts (AC1 & AC2 marked on the control

board) to ground (any green wire). CAUTION: This test should only be done by an experienced person familiar with electricity and its dangers.

Bad Power Relays

See this video: [hotkilns.com/checking-relay](https://www.hotkilns.com/checking-relay) and [hotkilns.com/change-relay](https://www.hotkilns.com/change-relay)

1) You should be able to hear contactors going on and off with a soft clicking noise when you first turn on the kiln and it is supposed to be heating up. If not try turning the kiln off and then back on again and restarting the program. Of course if you don't hear the relays it only tells you that they aren't firing. The problem could be in the control for instance not telling the relays to fire. If you do hear relays and the kiln is not heating then you know the problem is in the power circuit AFTER the relays.

2) With power on and panel open check voltage before and after each of the contactors while the kiln is firing. CAUTION: This test should only be done by an experienced person familiar with electricity and its dangers.

Bad Elements

See next section.

Run a Simple Paper Test

This will tell you if all kiln sections are firing. If they are not it could be a bad relay or maybe a bad internal switch on the control. See this: [hotkilns.com/paper-test](https://www.hotkilns.com/paper-test)

1. Place a little piece of paper in each element.
2. Then run a Fast Glaze (or turn the manual switches to Hi on a manual kiln) while you watch the papers.
3. They begin to smolder in about 2 minutes. After 3 or 4 minutes shut the kiln off.
4. This shows you if the elements are operating (or which ones are and which ones are not).

KILN FIRES UNEVENLY

Peepholes

1) Plug up Peephole holes in the kiln to prevent drafts.

Lid Seal

1) Check to make sure that door/lid is sealing properly. If door/lid is not sealing against top brick correctly a bright red glow will be visible around the door/lid seal when kiln is operating. (A little of this is OK). Also excessive heat loss can be felt around seal. Rub seal high points down with sandpaper until no more than 1/16 of an inch gap is found at any point along seal. Note that the gap at the

TROUBLESHOOTING AND REPAIR INSTRUCTIONS FOR L&L KILNS

top will definitely appear larger than any gap you see between the kiln sections. This is partly because the lid actually bows down in the center of the lid when it heats up and the edges consequently rise slightly. Just check for an UNEVENNESS in this gap which will cause an excessive heat loss.

2) If door/lid is excessively cracked or worn or has holes in it this may cause drafts in the kiln. Replace lid.

See the TROUBLESHOOTING AND FIXING BRICK PROBLEMS section in the TROUBLESHOOTING tab of your instruction manual or hotkilns.com/brick-troubleshooting

Elements

1) Elements may have differentially changed in resistance which will also have an effect on uniformity. The three zone control mostly compensates for this but there are limits. Check element resistance (see section at end of this Troubleshooting Guide called "CHECKING ELEMENT OHMS").

2) Empty the kiln. Then turn kiln on using a fast program like FAST GLAZE until elements are red. Open the door carefully and observe the elements to see if they all seem to be glowing about the same amount. CAUTION: The power does not turn off when you open the lid. Be careful not to put your hand inside the kiln while it is on. Dangerous electric shock could result if you touch an element.

RUN AN EASY-FIRE DIAGNOSTIC

There is a useful diagnostic program within the DynaTrol on Easy-Fire Kilns. This is handy to use when your kiln is first delivered and set up to make sure it was done properly. It can also be useful in seeing if an element has burned out. To use this diagnostic program enter the following sequence when the display says Idle.

1) Press **OTHER, 4, 4, 3**.

2) Keep pressing **OTHER** to cycle through the menu options until you get to **diag** and then press **ENTER**.

3) Open the lid of your kiln. You will see each zone of the kiln turn on for one minute each, starting with zone #1, the top zone. The control will display **OUt1**, then **OUt2**, then **OUt3** as it cycles through this sequence. **CAUTION: The power does not turn off when you open the lid. Be careful not to put your hand inside the kiln while it is on. Dangerous electric shock could result.** This will tell you if the kiln sections are in the wrong order or if the wires are somehow crossed in the control panel. If this is the case the zones will not turn on in the proper 1, 2, 3, order.

Loading

The Dynamic Zone Control of the EASY-FIRE kilns can compensate for many uneven loading situations. The SCHOOL-MASTER kilns, however, do not employ Zone Control so pay particularly close attention to the following steps.

1) If you are having a problem with uneven firing try to vary the way you load it to match the firing characteristics of the kiln. For instance if it typically fires hot at the top then put more weight in the top to absorb that heat. You can discern how your kiln fires in each section by using cones.

2) Be sure to put posts under the bottom shelf. The bottom shelf should be at least 1/2" to 1-1/2" above the floor of the kiln.

Firing with Cones

1) Run an empty kiln with three cone packs top- middle - bottom. This will tell you if the load contributes to the problem.

2) Try using cone packs in all sections (top, center, bottom) of the kiln during loaded firings and keep records of what happens. See the TROUBLESHOOTING KILN FIRING WITH CONE PACKS in the LOG, CONES,TIPS, CERAMIC PROCESS tab or hotkilns.com/troubleshooting-cones.

TROUBLESHOOTING AND REPAIR INSTRUCTIONS FOR L&L KILNS

EASY-FIRE Thermocouple Offsets

Thermocouples can drift in their accuracy over time and this can happen at different rates for each thermocouple. If one thermocouple reads at a different temperature than another thermocouple this can cause unevenness in the kiln. You may need to adjust the offsets to trick the kiln into firing hotter or cooler in certain zones. Read about Thermocouple Offset in section 9.9 of the DYNATROL 700 INSTRUCTIONS FOR L&L KILNS in the CONTROL section of the Instruction Manual and the and the CALIBRATING THE CONTROL section in the BASIC OPERATION OF L&L KILNS WITH A DYNATROL 700 in the OPERATION section of the manual. Also see this: hotkilns.com/calibrating-kiln.

ONE-TOUCH Thermocouple Offsets

Thermocouples can drift in their accuracy over time and this can cause inaccurate firings in the kiln. You may need to adjust the offset to trick the kiln into firing hotter or cooler. Read about THERMOCOUPLE OFFSET in the OPTIONS Section of the OPERATION OF L&L KILNS WITH A ONE-TOUCH™ (Deg F) in the OPERATION tab in your instruction manual. Also see this: hotkilns.com/calibrating-kiln.

Vent System

1) Is your vent system on and pulling air? You can check this with a source of smoke in a cold kiln. (If you burn a small piece of paper near the holes on the bottom of the kiln with the vent on and THE KILN OFF you can see if the smoke is being drawn into the holes. You can also check this by feeling the output of the vent when the kiln is at high temperatures. The air coming out should be quite warm to the touch (about 110°F to 140°F). The Vent-Sure will aid in keeping your kiln uniform by drawing hot air from the top of the kiln towards the bottom. It counteracts the natural rising of the heat.

2) If you want to increase draw first close the Bypass valve on the Bypass Collection Box under the kiln. You can also increase the size of the vent holes in the bottom of the kiln. You can also try taking out the top peephole plug. See the L&L VENT-SURE DOWNDRAFT KILN VENT INSTRUCTIONS in the VENT section of your instruction manual or hotkilns.com/vent-sure-instructions.

KILN FIRES TOO HOT OR COLD

Firing with Cones

Try using cone packs in all sections (top, center, bottom) of the kiln and keep records of what happens. See the TROUBLESHOOTING KILN FIRING WITH CONE PACKS in the LOG, CONES,TIPS, CERAMIC PROCESS tab or

hotkilns.com/troubleshooting-cones.

Easy-Fire vs Vary-Fire (on DynaTrol)

Keep in mind that the Easy-Fire programs feature Orton software that adjusts the final temperature based on the speed of firing. This in effect adjusts the heat-work and hence the actual cone that the kiln fires to. This applies to Easy-Fire and cone-fire Vary-Fire programs.

Be Careful with Hold Times

Be very careful with hold times. Even a fairly short hold time of 10 minutes can dramatically increase the amount of heat work and hence the cone that the kiln fires to. On the other hand you can use the hold time to increase the heat-work to compensate for underfired work. Just test this in small increments.

Control Settings and Calibration

You may need to calibrate your kiln with thermocouple offsets. See hotkilns.com/calibrate for the most up-to-date information on this process.

Thermocouple Drift

Thermocouples drift in their accuracy with time. You may have to make further adjustments in the Thermocouple Offset or Cone Offset settings over time. **You should change all thermocouples when you change elements because they age at approximately the same rate.**

KILN STALLS

1) The kiln may refuse to increase in temperature, and the kiln will just run on and on. If it is re-started it may work fine for a while. The most likely cause is old or failing elements or relays. An issue in one circuit/section/zone can cause the whole kiln to stall as it waits for the problem section to “catch up”. Check the temperatures in all zones to see if one zone is lagging behind and test elements and relays.

2) Thermocouples close to end of their useful life can cause some of these same problems.

3) Sometimes excessive ambient temperatures (over 125°F) around the control can cause stalling too.

4) Corroded connection points can also cause stalling.

5) Generally you will see the error message **Err1** when this happens.

TROUBLESHOOTING AND REPAIR INSTRUCTIONS FOR L&L KILNS

KILN FIRES SLOWLY - BOTH SERIES

Run a Simple Paper Test

See page 7.

Bad or Wrong Voltage

1) Check your voltage. Do this at the kiln at the Power Terminal Block with the control panel open or check it at your fused disconnect box. **CAUTION: This test should only be done by an experienced person familiar with electricity and its dangers.** You need to see what the voltage is when the kiln is firing. Low voltage will make the kiln fire considerably slower. For instance a kiln designed for 240 volts will have 25% less power when operated on 208 volts. Check voltage at your panel and where the kiln is connected. Check the voltage when the kiln is firing and when it is not firing. Sometimes the high amperage draw of the kiln will cause a voltage drop at the kiln. A voltage drop of 5 to 10 volts is not uncommon and is to be expected. If your voltage drop is more than that then you may have a problem with your electrical supply.

2) Make sure no other large electrical appliances such as a clothes dryer or electric oven are on when you are operating your kiln. This may cause a voltage drop which would slow the kiln down.

3) Voltage may vary in your area depending on season and time of day. Frequently there are "brown outs" during the summer months in some areas. This is when the electric utility reduces the voltage. Try firing at night after peak electrical use hours. You can use your Delay feature to do this easily. Find out from your local utility company when the end of the peak period of electrical use is. Some utilities offer preferential rates for using electricity at night because it is cheaper for them.

4) Check to see what the wire size of your circuit is. If it is very long (more than 50 feet) from your main circuit box then the wire size might need to be higher (e.g. #8 instead of #10 wire).

Element Aging

1) Elements both age and increase in resistance when fired. When they increase in resistance the amount of power they develop decreases. See the section on "CHECKING ELEMENT RESISTANCE" at the end of this guide.

2) Replacing only one element per section or zone may cause an unbalance in firing. In Easy-Fire kilns the multi-zone control will compensate for much of this imbalance automatically, however, this will not be the case in School-Master kilns.

3) Use original L&L parts for satisfactory maintenance.

(Elements, in particular, provided by other vendors may not work well in your L&L kiln. Some of our customers have found this out the hard way and thought it was an L&L problem. Only L&L has the design information to make our elements properly).

4) Empty the kiln. Then turn kiln on until elements are red. Open the door carefully and observe the elements to see if they all seem to be glowing about the same amount. **CAUTION:** The power does not turn off when you open the lid. Be careful not to put your hand inside the kiln while it is on. Dangerous electric shock could result. See the diagnostic program described in the earlier section called KILN FIRES UNEVENLY.

5) Elements expand and grow with age. If you fire low-fire clay and glazes and never get above cone 05 or so, your elements will last a long time, especially if you are only bisque firing. This is good, to a point. If you only low-fire, the problem you are most likely to encounter over many years is that the elements will expand as they age. The length and the coil diameter increase. Meanwhile the atmosphere in the kiln slowly eats away at the metal of the element. Although the total resistance usually increases as the elements age, sometimes it decreases, or reverses itself. This usually only happens when the elements are very old but have not yet failed completely. As the element expands, it binds up in the corners. This can make the individual coils push together and touch each other in the corners, making a short cut for the electricity, reducing the amount of element material the electricity must pass through, and therefore reducing the resistance in the whole element. This may make it hotter in the kiln, but if there is a lot of element material jammed in the corners there will not be enough material left in the coiled form to radiate the heat generated by the increased amperage and decreased resistance. Only the parts of the wire not touching the coils on either side of them will emit heat. More amperage through the electrical components in the control could cause damage if the situation continues or the resistance drops far enough. In addition, the expanding diameter of an element can make it difficult to get it out of the holder. Usually this will not happen to those firing to higher temperatures because the maximum temperature of the kiln is quickly compromised by increases in the resistance, requiring the elements to be changed long before they can jam up in the corners. Also, high temperatures and glaze firings are more prone to eating through the element, causing it to fail, before the element can expand enough to cause the problems mentioned above. Visually inspect your elements for the above conditions and do a resistance check. If you see this it may be time to change elements.

TROUBLESHOOTING AND REPAIR INSTRUCTIONS FOR L&L KILNS

Power Relays

As mechanical switches, power relays will fail over time. In particular, the coil which actuates the switch closure increases in resistance to the point where it no longer has the power to close, especially as it gets hot. This means that a relay can work at low temps but fail at elevated ones, making it more difficult to diagnose.

WIRES WILL GET HOT

Unlike many other appliances that use electricity (like motors) kilns are called a "resistive load." This means that there will be a continuous pull of steady electrical power for many hours. Even with properly sized wire this will generate SOME heat in the wires. This is one reason we recommend against using aluminum wire for a power feed. If you look carefully you will see that we have OVERSIZED our internal power wires far in excess of their rated capacity. In addition all our power wire is rated for very high temperatures. The larger the wires the less resistance in the wires and the cooler they will operate.

Bad Wiring

1) Have an electrician check your wiring. We have seen aluminum wire cause intermittent problems with allowing enough voltage through. We do not recommend aluminum wiring although some electricians will swear by it. The problem with it is that aluminum oxide, which is formed from heat, is a resistor while copper oxide is not a resistor. With kilns you will often develop some heat in the electrical lines. If all connections are perfect and the wire is oversized you probably will not have a problem - but why take that chance? Make sure your wires are of the proper size and that all connections are good.

2) Check your circuit breaker for proper operation. These sometimes go bad over time.

3) If all the elements are firing and the kiln is still firing too slow check the amperage draw of the kiln under a full load. CAUTION: This test should only be done by an experienced person familiar with electricity and its dangers. You need to see what the voltage is when the kiln is firing.

Check amperage under load with an amp-probe.



3) To check to see if all zones are firing on an Easy-Fire kiln, press the number 8 on the control numeric pad. You will see one little light per zone under the numbers on the control display. If you see two dots on an e18S, e23S, or e28S then you are firing at full load. If you see three dots on an e18T, e23T, or e28T then you are firing at full load. See if the amperage drawn is the same as what the kiln is rated for. See the product literature and/or data nameplate on the kiln for the rated amperage draw. There is also a complete table of this information in the Installation Instructions part of this manual. For instance, a model e23T rated for 240 volts, Single Phase should draw 48.0 amps. If it is substantially less than the rated amperage draw and your voltage is within 5% of the rated voltage (for instance 230 volts for a 240 volt unit), then chances are the elements have changed in resistance. This will require element replacement.

Pressing the number "8" will turn on 2 or 3 small LEDs that indicate whether the various zones are firing.

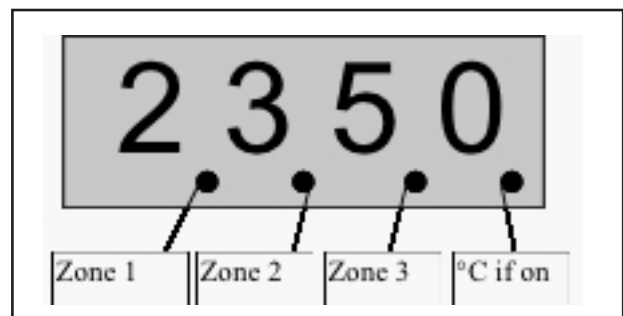

Wiring in the Kiln

- 1) Unplug kiln.
- 2) Trace wiring for missing or bad connections.
- 3) Check wiring against wiring diagram.
- 4) Check for corroded connectors or connectors that have

TROUBLESHOOTING AND REPAIR INSTRUCTIONS FOR L&L KILNS

frayed wires. Replace if you see this.

Element Connections

1) The holes where the elements go through the firebrick walls are too large. This could cause too much heat to escape from the kiln thereby overheating the element terminals. This can be remedied by lightly stuffing non-RCF ceramic fiber in the element holes. (See hotkilns.com/non-rcf-fiber-blanket for non-RCF fiber). You can stuff this in from the inside of the kiln using a sharp tool like a very small screw driver.

2) Check to see if the element ends are twisted properly. They should be twisted clockwise around the terminal screw. If the twist is too loose this could generate extra heat at the element ends. Check for corrosion on the terminal. If there is corrosion sometimes you can remove it with a wire brush.

3) The element connection hardware may not be tight enough. A loose connection can generate heat and cause oxidation of the hardware which in turn will cause a worse electrical connection (because of resistance) and more heat. Replace with new terminal hardware. See hotkilns.com/parts and filter for **Model Series** and **Elements (Terminals)**

Heat Leakage & Vents

- 1) Make sure peephole plugs are in.
- 2) Make sure hole for vent is proper. Check Vent-Sure instructions for proper hole sizes.
- 3) If you are using a different brand of vent make sure it is the appropriate size for your kiln. Check with the vent manufacturer and tell them how many cubic feet are in your kiln.
- 4) If your lid or bottom is cracked check to see if it seems to be leaking much heat at high temperatures. Patch or replace if extreme. (SOME IS OK).

Adding More Insulation

- 1) In L&L's top loading kilns an additional bottom may be placed under the original bottom. This will improve the insulation in the kiln, thereby slowing heat loss and speeding the firing time. You can also put a 2" layer of calcium silicate on top of the stand beneath the bottom of the kiln.
- 2) Also try raising the height of the kiln from the floor or putting a reflective stainless steel or aluminum sheet under the kiln. All these things keep the floor from absorbing the radiant energy from the kiln and will improve heat up times (as well as bottom of the kiln uniformity).

3) Put a 1" layer of non-RCF ceramic fiber on the lid. This is completely non-hazardous which is important in this application because you will be releasing fibers into the air when you move it while loading. While this is a somewhat extreme measure we have found that a disproportionate amount of the heat loss from a kiln is through the top. Non-RCF ceramic fiber is soluble in the body and is considered totally safe.

4) Whatever you do be sure NOT to put the kiln directly on the floor. If the floor is cement or other hard non-flammable material it will absorb the heat from the kiln. If the floor is wood or other flammable material you will create a very DANGEROUS situation which could cause a serious fire.

KILN FIRES SLOWLY - EASY-FIRE

Single vs Three Zone Control

- 1) Three zone control will slow a kiln down. It helps even out the temperatures in a kiln by shutting off one or more zones while firing. In addition zone control introduces other issues like LAG that sometimes complicate a firing. The first thing to try if you are getting a slow firing is to switch the kiln to single zone operation. That may get you back into operation quickly. Then, if that makes the problem go away you can fine tune the specific issue within the zone system that is causing the problem.
- 2) Normally models e23S and e28S are programmed to have two zones and models e23T and e28T are programmed to have three zone control. You can easily change this to be single zone operation.
- 3) Press **OTHER, 4, 4, 3**
- 4) The display says **notC** This stands for "number of thermocouples".
- 5) To run the kiln using only one thermocouple press **ENTER** at the **notC** prompt. You will then see **0003** or **0002** (depending on whether it is currently programmed for three zones or two zones). Then press **1**, then **ENTER**. The display will then say **StOP**. All the zones of the kiln will turn on and off simultaneously when you program the DynaTrol to use only one thermocouple.

ShtO (SHUT-OFF) SETTING

- 1) This option is used to shut off the automatic feature in the DynaTrol that holds the hottest part of the kiln at each segment's set point until the average of the three (or two) thermocouples reaches that set point. This can have a dramatic effect on speed of firing and is worth trying to see if it helps you if you are having a problem.
- 2) When you press **OTHER, 4, 4, 3**.

TROUBLESHOOTING AND REPAIR INSTRUCTIONS FOR L&L KILNS

- 3) Press **OTHER** until **ShtO** is displayed.
- 4) Pressing **ENTER** here allows you to toggle, using any number key, between **On** and **OFF**.
- 5) **On** means that as soon as the hottest zone gets to the segment's set point the entire kiln switches to either the "hold time" or the next segment. This will result in a quicker firing.
- 6) **OFF** means that the DynaTrol will not let the hottest zone's temperature rise until the average temperature of the three zones reaches that segment's set point. Then the kiln can begin the "hold time" or the next segment. This will result in more even firing.
- 7) When you have the setting you want shown in the display (**On** or **OFF**) press **ENTER**. **CPL** will display for a few seconds and then **IdLE**, **tC2** and current temperature.

PId SETTING

- 1) This setting generally should be left at its factory default because it is hard to predict the changes that it will create in your firing. However, a full explanation is given for more advanced users who want to experiment with this.
- 2) This setting comes pre-programmed at the factory for 65%. Basically this setting determines how much help the middle zone of the kiln gives the bottom zone of the kiln when the bottom zone is lagging behind during heating. This comes into play when the bottom zone is on 100% of the time. With this feature, the middle zone of the kiln will come on the programmed percent (**PId**) of the time that the TOP zone comes on, if the bottom zone is on all the time. Tests showed that if the bottom was on 100% of the time, the top zone was generally on 90% of the time, but the middle zone was on only about 40% of the time. By programming a higher percent you can greatly speed up your firings. (you will have to experiment, try the factory setting 65% then try maybe 100% and compare your results). Basically the higher the **PId** setting the faster the firing at the potential price of unevenness.
- 3) As your elements age firing by firing, this setting will activate earlier and earlier in the firing because the bottom will be working at 100% earlier and earlier. This will allow the artificial inflation of the center's temperature sooner and sooner. Because this center is heating based on mathematics now and not it's own thermocouple's reading, it will have a longer and longer period of time to get hotter than the top and the bottom. In some cases this can lead to gross unevenness. You may find yourself dialing down the **PId** to something like 50% or 60%. Remember that if it is set around 40% (it's normal operating percentage) or below, the thermocouple's reading then will be the control for that section, not the mathematics of the **PId** feature.

- 4) When display flashes **IDLe**, **tC2** press **OTHER** see **rSet**. Press **4, 4, 3**. See **notC**
- 5) Keep pressing **OTHER** to cycle through the menu options until you get to **Pld**.
- 6) Press **ENTER**. See **PCt, 0085** cycling.
- 7) Press any number from **0** to **150**, see the number you have entered preceded by a zero like **0120** if you entered **120**. Press **ENTER**, see **CPL** or **StOP** for a few seconds, then **IDLE**, etc.
- 8) Pressing **ENTER** here allows you set another percent setting that can help a slow, heavily loaded kiln fire faster.

Change elements to graded elements.

This is an extreme solution for Easy-fire kilns but can be effective. Contact factory.

KILN HEATS TOO FAST

Relays

- 1) A stuck relay, meaning that the power relay is stuck closed, delivering constant power to the elements, can cause the kiln to heat uncontrolled. If the kiln is still heating even when no program is firing or even the toggle switch is off, then you have a stuck relay. Whichever section is still heating, that is the relay that needs replacing.

Voltage

- 1) Check your voltage. Some people may have high voltage like 245 volts where you should nominally have 240 volts.
- 2) Make sure you don't have a 208 volt kiln hooked up to a 240 volt circuit. This is dangerous because the kiln will draw more amps than it is rated for which will overload the power wires and other components and could cause a fire.

Elements

- 1) Check element ohms and compare with factory values. (See CHECKING ELEMENT OHMS later in this section).
- 2.) Make sure the elements are wired properly. Check the wiring diagram.

EASY-FIRE ERROR MESSAGES

See this for a complete description on the web: hotkilns.com/error-codes. You can also see more information in the instruction manual in the CONTROL section: Appendix E in DYNATROL 700 INSTRUCTIONS FOR L&L KILNS.

Error codes can appear at any time during the firing. They always refer to a problem that, if allowed to continue,

TROUBLESHOOTING AND REPAIR INSTRUCTIONS FOR L&L KILNS

could end with unknown or even disastrous results. **Errd**, **Err1**, **ErrP** and the **FAIL** message make the most frequent appearances. **Errd** means there is a temperature difference of more than 50 degrees between the zones. **Err1** indicates that the kiln is climbing too slowly in an Easy-Fire program. **ErrP** indicates that there was either a very quick power outage (**ErrP** will flash along with the temperature and the kiln will still be heating), or there was a longer power outage (**PF** will be the only thing in the display and the kiln will not be heating). **FAIL** refers to a specific thermocouple failure. It will appear after displaying a 'tC' (thermocouple) number 1, 2 or 3.

Errd

- 1) If the kiln was just re-assembled and **Errd** is the error code, then double-check that the element connection wires go to their proper power relays and that the thermocouple wires are connected to the proper zones.
- 2) If you are sure the kiln is set up properly, nothing is out of place and none of the thermocouples are partially out of the kiln, then one of the following situations may apply:
- 3) You were firing with the lid open and you got **Errd** either while the lid was open or right after you closed it. For drying with the lid open, only about two inches is needed to adequately vent off water vapor. This is plenty if all the peep holes are open. The DynaTrol will attempt to compensate for the heat loss, and it usually can. The trouble may happen when you close the lid. The elements in the top of the kiln are already much hotter than the ones nearer the bottom due to their need to compensate for the heat loss from the top. When you close the lid it can take as long as eight seconds for the DynaTrol to respond to the rise in temperature in the top of the kiln, and shut off those elements. This can quickly cause an uneven temperature in the kiln, which will usually result in **Errd** (possibly an **Err2** in a smaller kiln -**Err2** is when the entire kiln temperature is more than 50°F over the hold time's temperature for longer than 18 seconds).
- 4) There was a lot of air being exhausted from your kiln when **Errd** appeared. If a vent system pulls too much air from just one point in the kiln, say, to down-ramp the load very quickly to a lower hold time for crystal formation, an uneven temperature can result. The firing will go slowly as it will be difficult to compensate for the heat loss; eventually, however, the **Errd** (or **Err1**) can appear.
- 5) Something is too close to, or is touching, **TC#** in the kiln. Allow almost an inch between everything for thermal expansion. Fix and re-fire the kiln.
- 6) A thermocouple wire has melted against the kiln case. The wire must be replaced.

7) A thermocouple is about to fail. Perform a physical inspection if possible, or just re-start the kiln and monitor it carefully.

8) Element(s) just burned out. Perform an ohms test for more information.

9) A relay has just failed. Perform a voltage test.

10) There is a bad connection point somewhere. This will become more of a possibility as the kiln ages. Examine all points carefully for melting, corrosion, and discoloration.

Err1

- 1) If **Err1** is the error code on the screen when you check on the firing, then for some reason the kiln could not generate enough heat to counter the heat loss. If the kiln can get no hotter (even though all the elements appear to be on and the program is not holding), then **Err1** is what you will see. If one of the elements or one of the circuits in the control fails while the kiln is at a high enough temperature then it will probably display an **Err8** code (which means temperature is falling when it should be rising) **Err1** or **Err8** can mean either you need new elements or a new component in one of the circuits. An ohms test and a voltage test can tell you which it is. If you recently changed locations, power supplies, elements, or did any repairs, then closely examine what changed between your last successful firing and this one. There may be some other issue besides bad elements or a bad component.
 - 2) A new location can mean a 208 volt power supply rather than a 240 volt supply (about 25% less power).
 - 3) In re-wiring the power supply you may not have used thick enough copper wire (line, conduit and connection points will be very hot).
 - 4) The elements are the wrong resistance. Check new elements with your multimeter just to be safe. Mistakes can happen.
 - 5) If you rewire anything improperly or incorrectly the potential for anything from a blown breaker to just no power at all is possible. (Using wire with a temperature rating of less than 150°C for the power wiring can seriously limit the life of the circuitry and can be dangerous as well, especially when the wires are close to the kiln.) Use a wire diagram and trace every wire to check yourself. You can buy high temperature wire from L&L (see the Parts List).
- ## Err2
- During a hold segment the temperature rises to greater than 50 degrees above the hold temperature which was set. The temperature must stay 50 degrees above this set temperature for 18 seconds before the error is displayed.

TROUBLESHOOTING AND REPAIR INSTRUCTIONS FOR L&L KILNS

Err3

During a hold segment the temperature is more than 50 degrees below the hold temperature which was set. The temperature must stay 50 degrees below this set temperature for 18 seconds before the error is displayed.

Err4

The temperature is more than 50 degrees above the previous hold temperature during a ramp segment where the temperature is programmed to decrease. The temperature must stay 50 degrees above this set temperature for 18 seconds before the error is displayed.

Err5

The temperature is more than 50 degrees below the local setpoint temperature during a ramp segment where the temperature is programmed to decrease. The temperature must stay 50 degrees below this set temperature for 18 seconds before the error is displayed.

Err6

A Negative temperature is displayed. This generally indicates the thermocouple is connected incorrectly. To correct this situation, ensure the red and yellow wires are connected correctly to the controller and at all junctions. You can identify the red lead on an unmarked thermocouple with a magnet because a magnet will be attracted to the red lead.

Err7

The temperature is more than 50 degrees above the local setpoint temperature during a ramp segment where the temperature is programmed to increase. The temperature must stay 50 degrees above this set temperature for 18 seconds before the error is displayed.

Err8

When using the Easy Fire Mode, the temperature is decreasing during the last ramp segment. This could indicate that the lid was up or the peepholes open or some other physical thing is causing the kiln to decrease in temperature.

ErrP + PF

Continuous **PF** in display. Indicates a long term power outage. The kiln has been shut down. Press **1** to clear the display.

ErrP and the current temperature are alternately flashing. To clear the display, press the **1** key. If a firing was in progress, the kiln will continue to fire even though this message is flashing. This error can also happen as a result of RF (radio frequency) noise that resets the microprocessor.

If this is suspected, the control panel should be returned to L&L for testing and possible modification. Also see hotkilns.com/noise

Err-

The **Err** with a dash indicates there was a power loss to the controller while writing a program to the non-volatile memory chip. Recheck the selected program, and reprogram if necessary.

FAIL

1) If, upon inspection, the error code **FAIL** turns out to be a burned out thermocouple then replace it. You typically will not need to replace the mullite protection tube - just the internal thermocouple "element" (see hotkilns.com/thermocouple-k-standard). You should not mix unsheathed thermocouples with sheathed ones. (because their response rates are slightly different). A spare on hand is a good idea as well.

2) If the TCs are not bad (you just replaced them and they worked fine for at least one complete firing) but the **FAIL** message still appears, it may be that the TC wire is bad (melted or broken at a point) or the electronics have partially failed.

A) Turn OFF the power at the Disconnect Switch or Circuit Breaker and/or unplug the kiln.

B) Open the cover of the control.

C) Remove the Thermocouple wires from the DynaTrol and the Thermocouple Terminal Strip. Take out of the Control Box and set aside.

D) Make tiny "U" shaped jumper wires from paperclips and jumper between each of the + and - connections on the DynaTrol board.

E) You are simply completing each TC circuit without using the TC wire or the TC. Do not let the 'U's touch anything other than the TC connection points. Note: the fact that a paperclip is not the proper type of metal to use in a Type K TC circuit is not an issue for a test like this.

F) Close up the Control Box and turn the unit on. If it still says **FAIL** then the electronic board has failed. If it reads room temperature then the TC wire or the TC has failed.

G) If it reads room temperature with these jumpers in, and you are not sure if it is the TC or the TC wire, just re-attach TC2's wire to TC3 and re-attach TC3's wire to TC2. If the **FAIL** message is still on **TC2** then it is the wire, not the TC. If it says that the **FAIL** is now at **TC3**, then you know it is the TC, not the wire (there are many other ways to determine this as well).

TROUBLESHOOTING AND REPAIR INSTRUCTIONS FOR L&L KILNS

Turning Error Codes On or Off

1) When you receive your DynaTrol the error codes are turned on. In most cases, you will want the error codes on. They can be turned off if you are doing special firings, such as jewelry or glass firing where the kiln is opened while hot. Turning the error codes off turns off the dynamic zone control feature that keeps the temperature in the kiln even top to bottom. It eliminates nuisance shut downs but side steps built in fail-safe measures.

2) The only Error codes that this can not turn off are **Err6**, **FAIL**, and **ErrP** in both the "Easy Fire" and "Vary Fire" modes. In addition **Err1** and **Err8** are not turned off in the last segment of an "Easy Fire" program. This is because the built in calculations would make no sense if the kiln were firing too slowly.

3) To turn Error Codes off do the following:

4) Press the **OTHER** button several times until you see **ErCd**.

5) Press **ENTER**

6) Display will say **On** (which indicates that the error codes are turned on) or **OFF** (which indicates that the Error Codes are Off). You can toggle back and forth between on and off by pressing the **1** key.

7) Hit **ENTER** when you see **On** or **OFF** and you want to keep that setting

8) **CPL** will display for a few seconds. **IdLE**, **tC2**, and the current temperature then cycle in the display.

Can you restart the kiln after it stops because of Error Codes?

You can try to restart the kiln after getting an error code. Some messages, like flashing **ErrP** and **FAIL**, will not necessarily turn off the kiln. Depending on the problem though, re-starting it may or may not let it finish the firing, or even start up again. An **Errd** will usually not re-start easily because the temperature top to bottom is drastically different. An **Err1** at the end of the firing will re-start but will probably re-occur in about 22 minutes. A **FAIL** message will not go away even if the problem is fixed during the firing. The kiln can still be firing with the **FAIL** message flashing along with the number of the TC that failed. Stopping and then re-starting the kiln after fixing the problem with the TC circuit is the only way to erase the **FAIL** message. **ErrP** flashing with the temperature means that the kiln is still firing, after just a short power outage or interference. Just press any number to clear the **ErrP**. An **ErrP** which is not flashing must be re-started.

Worst Case Scenario for Restarting After an Error Code

Keep in mind that you run the risk of over-firing if you re-start while the kiln is very close to the final temperature. A pyrometric cone melts with the proper combination of time and temperature. Add more time and you don't need as high a temperature, go to a higher temperature and you don't need as much time. When an error code shuts down the kiln near your final temperature (within about 50 degrees) and you do not know exactly how long it has been cooling, or what temperature it reached before the error code appeared, you run the risk of having too much unaccounted for time in your time-temperature equation. The DynaTrol calculates this equation automatically after determining how many degrees per hour the kiln is climbing (time) and to what temperature it is climbing to (temperature). However, it cannot do this accurately after a high temperature re-start.

If you have cones in the kiln that you can see through the peepholes, then use these after you re-start and turn off the kiln manually when the target cone bends over.

If you do not have cones visible then you can gamble and estimate a final temperature based on how many degrees per hour the kiln has risen, including the time it was off.

For example, you come in and the control says **tC2, 2200** (degrees F) and everything seems fine in your slow glaze to cone 6 firing. But twenty-five minutes later you come back and see **Err1**.

The first thing you want to do is press **1** to clear the error code. Look for **tC2**'s temperature and write it down. It might be **2175**. You have no cones in the kiln but you really need these pieces fired.

Wait a few seconds until you see "**IdLE, tC2, 2175**". Press **START** to re-start the program and note the time on your watch. Note the 25 minutes the kiln was "holding" from the last time you saw it at 2200°F until this time, where it says **2175**. It must have continued to climb somewhat, but because the **Err1** will appear after 22.5 minutes of holding when the kiln is programmed to be climbing, it probably never got over 2210°F. So the kiln has held at an average of about 2195°F for about 25 minutes, instead of continuing on to 2232°F (cone 6) to finish the firing.

The relationship between time and temperature allows you to estimate how much hold time to add to get the same amount of heat work as the kiln would have achieved by climbing to 2232°F. Assuming a 108°F per hour temperature rise, a good rule of thumb is to add about a 20 minute hold to the maximum temperature; this will allow you to lower the final temperature by about 20°F. An hour

TROUBLESHOOTING AND REPAIR INSTRUCTIONS FOR L&L KILNS

hold time would mean a final temperature of about 40°F lower. A two hour hold time would be about 60°F lower.

In this example, the kiln has already held at about 35 degrees lower than the final temperature for 25 minutes. It would need another 25 minutes of holding to give the ware the same amount of heat work that 2232°F (cone 6) would have.

In reality, however, an Err1 that close to the end of a firing probably means you need new elements. So re-starting the kiln will probably not enable it to climb much higher in temperature. Keeping track of the time, let it run, and when it shows Err1 again just keep re-starting it until the firing finishes. Meanwhile call and order new elements.

Be very careful if you try this method. On loads that are very important always use cones you can see through the peepholes in case of a failure of some kind. If you have to use this method without the cones, remember that almost all your calculations are based on estimates and the results could be disastrous to your ware and/or the kiln if you are not accurate enough. The further away the temperature that the kiln is holding at is from the cone that the firing was trying to get to, the less accurate an estimated amount of time will be to achieve the amount of heat work necessary. If you can wait and re-fire from room temperature, you should. If you depend in any way on your kiln you should keep spare parts around for it. You could replace the elements easily yourself after the kiln cools and then re-load it and re-fire it to the proper cone without losing much time at all. Or consider that most glazes have an entire cone's temperature range that they can mature within. Weigh your options and decide.

In general though, Error Codes mostly appear after the kiln has been disassembled and set back up improperly, has had its power supply altered (like moving to a new studio with different voltage), or has had an element, a relay, or a thermocouple burn out.

ONE-TOUCH ERROR MESSAGES

Error codes can appear at any time during the firing. They always refer to a problem that, if allowed to continue, could end with unknown or even disastrous results. [Errd](#), [Err1](#), [ErrP](#) and the [FAIL](#) message make the most frequent appearances.

Errd

Error d indicates that the kiln temperature is 100°F above the traveling set-point, which is the current desired temperature in the kiln. The traveling set-point will increase or decrease according to the programmed rate.

1) Something is too close to, or is touching the thermocouple. Allow almost an inch between everything for thermal expansion. Fix and re-fire the kiln.

2) The Thermocouple Lead Wire has melted against the kiln case. The wire must be replaced.

3) The thermocouple is about to fail. Perform a physical inspection, or just re-start the kiln and monitor it carefully.

4) Element(s) just burned out. Perform an ohms test for more information.

5) The relay has just failed.

6) There is a bad connection point somewhere. This will become more of a possibility as the kiln ages. Examine all points carefully for melting, corrosion, and/or discoloration.

Err1

Error 1 indicates the temperature in the kiln is rising during an up ramp slower than 15°F/hr. If this rate continues for 8 minutes the firing will be stopped. [Err1](#) may be an indication that the elements are worn or that a relay has stopped working.

1) If [Err1](#) is the error code on the screen when you check on the firing, then for some reason the kiln could not generate enough heat to counter the heat loss. If the kiln can get no hotter (even though all the elements appear to be on and the program is not holding), then [Err1](#) is what you will see. [Err1](#) can mean either you need new elements or a new relay. An ohms test and a voltage test can tell you which it is. If you recently changed locations, power supplies, elements, or did any repairs, then closely examine what changed between your last successful firing and this one. There may be some other issue besides bad elements or a bad component.

2) A new location can mean a 208 volt power supply rather than a 240 volt supply (about 25% less power).

3) In re-wiring the power supply you may not have used thick enough copper wire (line, conduit and connection points will be very hot).

4) The elements are the wrong resistance. Check new elements with your multimeter just to be safe. Mistakes can happen.

5) If you rewire anything improperly or incorrectly the potential for anything from a blown breaker to just no power at all is possible. (Using wire with a temperature rating of less than 150°C for the power wiring can seriously limit the life of the circuitry and can be dangerous as well, especially when the wires are close to the kiln. Use a wire diagram and trace every wire to check yourself). You can buy high temperature wire from L&L (see the Parts List).

TROUBLESHOOTING AND REPAIR INSTRUCTIONS FOR L&L KILNS

ErrP

ErrP is displayed whenever there is a power interruption that is long enough to stop the firing. If the power interruption is brief the kiln will continue to fire when power is restored; in this case there will no indication of a power failure. To clear the error, press any key.

This error can also happen as a result of RF (radio frequency) noise that resets the microprocessor. See hotkilns.com/noise

ErrF

ErrF indicates the temperature in the kiln is decreasing during a down ramp less than 15°F/hr. If this rate continues for 8 minutes the firing will be stopped. **ErrF** may be an indication that a relay has stuck in the on position.

tC-

tC- indicates that the red and yellow thermocouple wires are reversed. Make sure they are right all the way through the circuit.

FAIL

See the section in these Troubleshooting Instructions called DISPLAY READS **FAIL** and **tC**.

Can you restart the kiln after it stops because of Error Codes?

You can try to restart the kiln after getting an error code. Some messages, like flashing **ErrP** and **FAIL**, will not necessarily turn off the kiln. Depending on the problem though, re-starting it may or may not let it finish the firing, or even start up again. An **Err1** at the end of the firing will re-start but will probably re-occur in about 22 minutes.

Worst Case Scenario for Restarting After an Error Code

Keep in mind that you run the risk of over-firing if you re-start while the kiln is very close to the final temperature. A pyrometric cone melts with the proper combination of time and temperature. Add more time and you don't need as high a temperature, go to a higher temperature and you don't need as much time. When an error code shuts down the kiln near your final temperature (within about 50 degrees) and you do not know exactly how long it has been cooling, or what temperature it reached before the error code appeared, you run the risk of having too much unaccounted for time in your time-temperature equation.

If you have cones in the kiln that you can see through the peepholes, then use these after you re-start and turn off the kiln manually when the target cone bends over.

If you do not have cones visible then you can gamble and

estimate a final temperature based on how many degrees per hour the kiln has risen, including the time it was off.

For example, you come in and the control says 2200 (degrees F) and everything seems fine in your slow glaze to cone 6 firing. But twenty-five minutes later you come back and see **Err1**.

The first thing you want to do is press **1** to clear the error code. Look for the temperature and write it down. It might be 2175. You have no cones in the kiln but you really need these pieces fired.

Wait a few seconds until you see "ldLE, 2175". Press **START** to re-start the program and note the time on your watch. Note the 25 minutes the kiln was "holding" from the last time you saw it at 2200°F until this time, where it says 2175. It must have continued to climb somewhat, but because the **Err1** will appear after 22.5 minutes of holding when the kiln is programmed to be climbing, it probably never got over 2210°F. So the kiln has held at an average of about 2195°F for about 25 minutes, instead of continuing on to 2232°F (cone 6) to finish the firing.

The relationship between time and temperature allows you to estimate how much hold time to add to get the same amount of heat work as the kiln would have achieved by climbing to 2232°F. Assuming a 108°F per hour temperature rise, a good rule of thumb is to add about a 20 minute hold to the maximum temperature; this will allow you to lower the final temperature by about 20°F. An hour hold time would mean a final temperature of about 40°F lower. A two hour hold time would be about 60°F lower.

In this example, the kiln has already held at about 35 degrees lower than the final temperature for 25 minutes. It would need another 25 minutes of holding to give the ware the same amount of heat work that 2232°F (cone 6) would have.

In reality, however, an **Err1** that close to the end of a firing probably means you need new elements. So re-starting the kiln will probably not enable it to climb much higher in temperature. Keeping track of the time, let it run, and when it shows **Err1** again just keep re-starting it until the firing finishes. Meanwhile call and order new elements.

Be very careful if you try this method. On loads that are very important always use cones you can see through the peepholes in case of a failure of some kind. If you have to use this method without the cones, remember that almost all your calculations are based on estimates and the results could be disastrous to your ware and/or the kiln if you are not accurate enough. The further away the temperature that the kiln is holding at is from the cone that the firing was trying to get to, the less accurate an

TROUBLESHOOTING AND REPAIR INSTRUCTIONS FOR L&L KILNS

estimated amount of time will be to achieve the amount of heat work necessary. If you can wait and re-fire from room temperature, you should. If you depend in any way on your kiln you should keep spare parts around for it. You could replace the elements easily yourself after the kiln cools and then re-load it and re-fire it to the proper cone without losing much time at all. Or consider that most glazes have an entire cone's temperature range that they can mature within. Weigh your options and decide.

In general though, Error Codes mostly appear after the kiln has been disassembled and set back up improperly, has had its power supply altered (like moving to a new studio with different voltage), or has had an element or a thermocouple burn out.

SERVICE FOR YOUR KILN

WHERE TO GET SERVICE

See the SERVICE Section of your Instruction manual or see hotkilns.com/technical-support

WHERE TO BUY PARTS

You can order parts for your L&L Kiln through L&L or your local distributor. See the Parts List that pertains to your particular kiln model. Our on-line parts list is easy to navigate. See hotkilns.com/parts. Standard Parts are typically shipped the day after an order is placed. Rush service is available.

REPLACEMENT ELEMENTS

Replacement Elements made by L&L Kiln Mfg., Inc. are designed for each individual model for long life and superior performance. Good element design is a complex balance of watt density, design voltage, stretch ratio, wire gauge, element length and material. It takes many hours and years of experience to design a good element for each model. Do not expect an outside supplier with no interest in your kiln performance or long experience with L&L kilns to spend the necessary time to do this right. In the end you will not save money. See hotkilns.com/elements to order

NOTE: Many of these procedures have accompanying instructional videos. Look out for the video links in each section or go to hotkilns.com/videos for more.

REMOVING PANEL FOR SERVICE

- 1) It is easy to access the inside of the control panel for troubleshooting. In addition it is easy to remove this panel and send it back to the factory for inspection and/or repair.
- 2) Disconnect power and unplug the kiln.

- 3) Follow the instructions in ASSEMBLY INSTRUCTIONS FOR in the ASSEMBLY tab of your instruction manual or see hotkilns.com/assemble-easy-school in order to remove the Control Box for Easy-Fire and School-Master kilns.

- 4) Pack the control panel with cushioning material such as bubble wrap, balled-up newspaper or foam in a cardboard box and follow instructions from the factory or your local distributor about where to send it. DO NOT SEND A CONTROL PANEL WITHOUT CALLING FIRST.

CAUTION: The controller contains electronic components which are sensitive to static electricity. Before handling the controller dissipate any static charge you may have by touching metal or a screw on the controller panel, the electrical box, the kiln lid, or some other grounded object.

REPLACING DYNATROL

See this video: hotkilns.com/replace-dynatrol

- 1) Unplug kiln or turn off the kiln at the fused disconnect switch.
- 2) Remove the four #6 screws that hold the DynaTrol in place from the front face of the control panel.
- 3) Open up the control box and hinge down for access (as shown on page 2)
- 4) Pull off the spade connectors from all the connection points on the back of the control. Loosen the screws that hold down the thermocouple wires and pull out the wires from under the screw heads. It is OK to remove the screws if this is easier for you. First note where all the wires go. These are all clearly marked with color coding on the Wiring Diagram.
- 5) Pull old control out. Put new control in and screw in place with the #6 mounting screws. Replace wires on proper connectors.
- 6) Be careful to get the Red or Yellow of the thermocouple wires to match the colors painted on the DynaTrol board.

TROUBLESHOOTING AND REPAIR INSTRUCTIONS FOR L&L KILNS

Picture showing thermocouple wires installed on DynaTrol. There is no need to wrap the thermocouple wire around the screw head- although it is OK to do so. However, do make sure the wire is tight and secure UNDER the screw head.

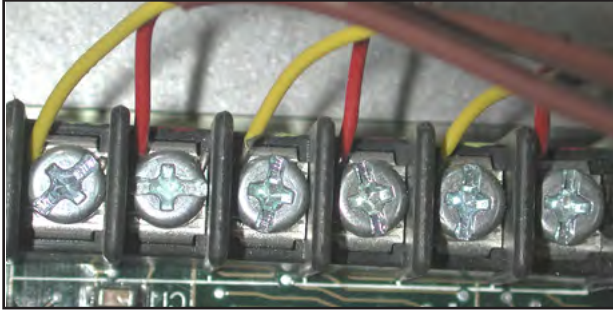

7) Double check that the proper color coded wire goes to the proper terminal.

Orange = OUT 1

Blue = OUT 2

Purple = OUT 3 (not on e18S, e23S, and e28S)

Gray = AC1

Green = CT

Brown = AC2

TC1 = TC1

TC2 = TC2

TC3 = TC3 (not on e18S, e23S, and e28S)

REPLACING ONE-TOUCH™

See this video: hotkilns.com/replace-dynatrol (Note the process of changing a DynaTrol is very similar)

- 1) Unplug kiln or turn off the kiln at the fused disconnect switch.
- 2) Remove the four #6 screws that hold the One-Touch™ in place from the front face of the control panel.
- 3) Open up the control box and hinge down for access (as shown on page 3)
- 4) Pull off the spade connectors from all the connection points on the back of the control. Loosen the screws that hold down the thermocouple wires and pull out the wires from under the screw heads. It is OK to remove the screws if this is easier for you. First note where all the wires go. These are all clearly marked with color coding on the Wiring Diagram.
- 5) Pull old control out. Put new control in and screw in

place with the #6 mounting screws. Replace wires on proper connectors.

6) Be careful to get the Red or Yellow of the thermocouple wires to match the colors painted on the control board.

Picture showing thermocouple wires installed on Control. One screw is removed to show how the TC wire should be prepared with a "U" shape.

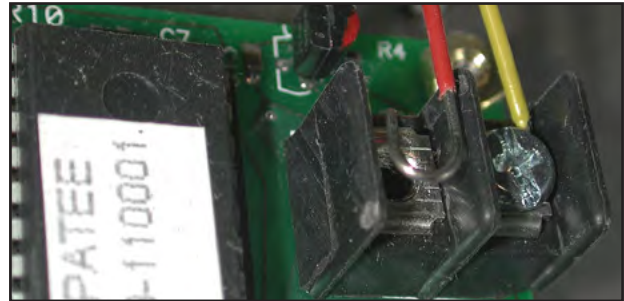

7) Double check that the proper color coded wire goes to the proper terminal.

Orange = J5

Gray = J2

Green/Yellow= J4

Brown = J3

REPLACING TRANSFORMER

See this video: hotkilns.com/change-transformer

- 1) Unplug kiln or turn off the kiln at the fused disconnect switch.
- 2) Open up the control box and hinge down for access (as shown on page 2).
- 3) Using needle nose pliers pull off the wires from the transformer. THIS CAN BE TRICKY. It can take a good bit of force sometimes to remove these little spade connectors. You will probably not be able to do it with just your hands. Also the spade connectors on the transformer are not very strong. Take your time. Of course, if you are replacing a bad transformer it doesn't matter if you damage it.

TROUBLESHOOTING AND REPAIR INSTRUCTIONS FOR L&L KILNS

Shows wires being pulled off the control transformer.



4) Unscrew the two #8 screws that hold the control transformer onto the Contactor Panel and remove the transformer.

5) Before installing the new transformer put the small jumper wire onto terminals #2 and #3 on the bottom row of terminals. Note the little numbers by the contacts.

REPLACING POWER RELAYS

See this video: hotkilns.com/change-relay

1) Unplug kiln or turn off the kiln at the fused disconnect switch.

2) Open up the control box and hinge down for access (as shown on page 2).

3) Pull off the wires to the relay(s) that you are replacing. Everything is color coded and marked so you can refer to the wiring diagram when replacing if you forget where the wires go. The wire lengths also don't give you much choice and will help keep you from making a mistake.

4) Unscrew the #8 screws that hold the relays in place. Remove old relay and replace with new one.

5) Visually inspect the wire connectors. Do they look corroded or "cooked"? Are the wires frayed? Any corrosion on the wire itself? If any of this is questionable you may need to replace the appropriate wire harness.

6) Reconnect all wires. Visually inspect to make sure the spade connectors are down as far as they can go and feel to see that they are tight (a gentle tug should not remove one). If they are loose for some reason remove the wire and

slightly squeeze the spade connector with pliers to tighten it.

IMPORTANT: The slip on wire connectors can not be loose or corroded. If there is a bad connection then heat will be generated and the component that they slip onto (relay, terminal strip, etc) may overheat and fail. If you squeeze the slip on terminal to make it tighter - be sure to squeeze it evenly so that one side is not tight and the other loose. If there are any doubts about the integrity of the wire or the connector replace the whole wire or harness.

REPLACING FUSE HOLDER

See this video: hotkilns.com/change-fuse-holder

1) Unplug kiln or turn off the kiln at the fused disconnect switch.

2) Open up the control box and hinge down for access (as shown on page 2).

3) Remove the wire connectors from the end of the fuse holder on the inside of the panel.

4) Unscrew the nut that holds the fuse holder in place.

5) Remove and replace with a new fuse holder. Reconnect wires.

REPLACING THERMOCOUPLES

See this video: hotkilns.com/change-thermocouple

1) Unplug kiln or turn off the kiln at the fused disconnect switch.

2) Remove the Control Box and Element Terminal Box as shown in the Assembly Instructions.

3) Remove the Thermocouple Lead Wires.

4) Unscrew the Thermocouple from the kiln (these are #6 x 1-1/2" screws)

5) Remove Thermocouple.

6) Remove Thermocouple Protection Tube. Shake it and dump out the oxide powder that has accumulated inside the tube. Then reinsert the tube into the hole in the kiln.

7) Install a new Thermocouple and screw in place.

8) Replace Thermocouple Lead Wires and tighten. Be sure to get Red matched to the Minus (-) sign and the Yellow matched to the Plus (+) sign.

TROUBLESHOOTING AND REPAIR INSTRUCTIONS FOR L&L KILNS

Picture showing end of thermocouple.

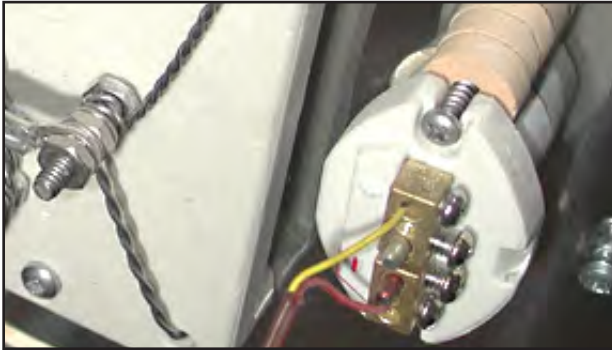

CHECKING ELEMENT OHMS

See this video: hotkilns.com/test-resistance-ez

See the instructions in the TROUBLESHOOTING Section of your instruction Manual (ELEMENT TROUBLESHOOTING & INSTALLATION INSTRUCTIONS) or here: hotkilns.com/element-troubleshooting

Element Ohm Charts

Check your wiring diagram for resistance values for your kiln.

CHANGING ELEMENTS

SEE THESE VIDEOS FIRST

For most top loading kilns:

hotkilns.com/change-elements-ez

For kilns with Quad elements:

hotkilns.com/change-element-quad

See the instructions in the TROUBLESHOOTING Section of your instruction Manual (ELEMENT TROUBLESHOOTING & INSTALLATION INSTRUCTIONS) or here: hotkilns.com/element-troubleshooting

REPLACING ELEMENT HOLDERS

See this video: hotkilns.com/change-element-holder

1) When ordering a new holder provide model number of kiln and length of the element holder. See the Parts List for this information.

2) Note that if the holder has melted badly you may need to either replace the brick that holds it or at least patch the brick with our Brick Repair Kit.

See the extensive instructions in the TROUBLESHOOTING

Section of your instruction Manual or here: hotkilns.com/element-troubleshooting

CRACKS IN THE LID & BOTTOM

See these videos for bad cracks:

hotkilns.com/fix-cracks-front-load

and hotkilns.com/repair-cracked-top

See this video for hairline cracks:

hotkilns.com/repair-hairline-cracks

See the instructions in the TROUBLESHOOTING Section of your instruction Manual (TROUBLESHOOTING & FIXING BRICK PROBLEMS) or here: hotkilns.com/brick-troubleshooting

TIGHTENING STAINLESS BANDS

See these videos:

hotkilns.com/replace-side-brick-kiln

hotkilns.com/replace-side-brick-davinci

See the instructions in the TROUBLESHOOTING Section of your instruction Manual (TROUBLESHOOTING & FIXING BRICK PROBLEMS) or here: hotkilns.com/brick-troubleshooting

REPLACING FIREBRICK IN SIDES

See these videos:

hotkilns.com/replace-side-brick-kiln

hotkilns.com/replace-side-brick-davinci

See the instructions in the TROUBLESHOOTING Section of your instruction Manual (TROUBLESHOOTING & FIXING BRICK PROBLEMS) or here: hotkilns.com/brick-troubleshooting

DRILLING OUT HOLES FOR PEEPHOLES

See the instructions in the TROUBLESHOOTING Section of your instruction Manual (TROUBLESHOOTING & FIXING BRICK PROBLEMS) or here: hotkilns.com/brick-troubleshooting

DRILLING OUT FOR ELEMENT CONNECTIONS

See the instructions in the TROUBLESHOOTING Section of your instruction Manual (TROUBLESHOOTING & FIXING BRICK PROBLEMS) or here: hotkilns.com/brick-troubleshooting

TROUBLESHOOTING AND REPAIR INSTRUCTIONS FOR L&L KILNS

REPLACING BOTTOMS

See the instructions in the TROUBLESHOOTING Section of your instruction Manual (TROUBLESHOOTING & FIXING BRICK PROBLEMS) or here: hotkilns.com/brick-troubleshooting

REPLACING LIDS

See the instructions in the TROUBLESHOOTING Section of your instruction Manual (TROUBLESHOOTING & FIXING BRICK PROBLEMS) or here: hotkilns.com/brick-troubleshooting

MORE ABOUT TROUBLESHOOTING CERAMIC PROBLEMS

1) We provide many firing tip brochures from Orton in the pdf library on our website. For a more in depth explanation Orton has a great booklet called Successful Firing Practices. They also have a number of other booklets available such as Cones and Firing (20 pages), Using Orton Cones/Temperature Charts, Kiln Safety Booklet, Kiln-Sitter Maintenance & Repair and Porcelain Firing Guide. Contact Orton at 614-895-2663 for more information. See ortonceramic.com for lots of very helpful information on how to use cones and for many firing tips and great information on firing kilns.

2) Check out a book called Electric Kiln Ceramics written by Richard Zakin, a book called What Every Potter Should Know by Jeff Zamek and Mastering Cone 6 Glazes by Ron Roy and John Hesselberth. Check out a book called "Ceramic Faults and their remedies" by Harry Fraser, A&C Black, London.

4) The magazines Ceramics Monthly (ceramicsmonthly.org) and Clay Times (claytimes.com) have many good articles and resources.

5) Also check out the great web resource, the Clayart discussion group at potters.org.

6) Check the links page on our web site.

7) Your ceramic supplier is a good source of knowledge and will have a wide variety of helpful books and videos as well

TROUBLESHOOTING KILN FIRING WITH CONE PACKS

BASIC CONE INFORMATION

PYROMETRIC CONES

Pyrometric cones are made of clay and other minerals and are precisely formulated to soften when fired in a kiln. They will bend over when they have absorbed a certain amount of heat. The amount of heat is related to both time and temperature. They mirror fairly accurately what goes on in a ceramic body and can be a more reliable guide to firing than a thermocouple instrument.

Differing materials in the cones result in different firing temperatures. The cones you are likely to use in an L&L kiln are numbered from Cone 022 to Cone 10 (coldest to hottest). The number is imprinted on the cone. Usually clay and glaze comes with a recommended cone to fire to. A cone is a tall (about 2-½") pyramid made from specific damp-pressed ceramic materials. Each cone has a slight lean to it when placed on a flat surface. Be careful not to drop cones or expose cones to moisture.

CONES MEASURE HEAT-WORK

Cones are not temperature measuring devices. They measure how much heat has been absorbed by the ware in the kiln, which is the result of the combination of time and temperature. A particular piece of clay needs a certain amount of time at a specific temperature to properly fire it, lower temperature if the time is longer, higher temperature if the time is shorter. An example of this would be if you added about a 20 minute hold to the maximum temperature of a cone 6 firing, you would be able to lower that final temperature by about 20°F. An hour hold time would mean a final temperature of about 40°F lower. A two hour hold time, about 60°F lower.

LARGE SELF SUPPORTING CONES

Although there are various types of cones available we recommend using the "self-supporting large cones". They have a built-in base that allows the cone to sit flat while always placing the pyramid part of it at the proper angle. The angle is there to ensure that the cone bends in the direction you want it to, and doesn't just slump and puddle.

CONE PACKS

The best way to use the cones, especially if they are all you have to tell how hot your kiln is getting, is to use 'cone packs', or the three cone system. The three cones are placed in a line, aimed so that when they fall, they will fall in a line. The first cone to fall should be in the front of the three cone line. This cone should be one cone number lower than the one you wish to fire to. The target cone (the cone you wish to fire to) should be the next one to fall and should be in the middle. The last cone should be one cone number higher than the

target cone. The first cone is to warn you that the firing is almost done. The target cone tells you when to turn off the kiln, and the last cone tells you if the kiln got hotter than you thought it did.



Picture of a "cone pack" (Courtesy of Orton). The ones in the back are before the firing and the ones in the front are after a perfect firing/ These are Self-Supporting Large Cones.

USE CONES TO CONTROL ACCURACY IN AN AUTOMATIC KILN

We recommend checking the accuracy of your control and thermocouples every so often by placing at least one large cone (the target cone or cone number you are firing to) in the top, middle and bottom. Thermocouples will drift in their accuracy, but you can adjust the cone offset or thermocouple offset (or both) to compensate for this. You know how many degrees off the thermocouple reads at the end of the firing. Using a cone near the thermocouple and a "cone to temperature chart" will help to calibrate a thermocouple accurately. Remember though, cone temperatures are affected by their location in the kiln, the angle at which they are held, and the rate at which they are heated. Slight variations throughout the kiln should be expected. You can see a "cone to temperature" chart in the LOG, CONES, TIPS, CERAMIC PROCESS section of your manual or at hotkilns.com/orton-cone-chart.

TROUBLESHOOTING FIRING PROBLEMS

Seems like the kiln is under-firing or over-firing slightly

1) On the next firing make up "cone packs", one for each thermocouple. A cone pack is a set of three cones, standing in a line. The cone the firing should go to is called the target cone, and is in the middle. The one in front of it is one cone number lower, and the one behind it is one cone number

TROUBLESHOOTING KILN FIRING WITH CONE PACKS

higher. Pay attention to how you position the cones as they are designed to only fall in one particular direction if placed on a level surface. You do not want a lower-numbered cone stuck in the cone pack behind a higher-numbered cone because the lower-numbered one will fall first and might lean against or knock over the higher-numbered cone, which will compromise the accuracy of both cones.

2) Once the cone packs are positioned on shelves (or on a post lying on its side) and are visible through the peepholes, fire the kiln to the middle cone's number.

3) Near the end of the firing start watching the cone packs. Look for the first cone to fall over in each pack, not necessarily at the same time, but pretty close, probably in the middle zone first.

4) Now watch for the middle cone in each pack. Keep checking the DynaTrol display to be sure it does not say **CPLt**. The middle cone in each pack should start to fall at pretty much the same time in the top, middle and bottom of the kiln. When the tip of the cone touches the melted cone in front of it note the temperature readout on the display for that zone's thermocouple.

a) If the middle cones did not go down together then immediately note the differences in each thermocouple reading from the one thermocouple in the same zone as the first cone that went down. Later on, use the "thermocouple offset" feature to add or subtract degrees from each thermocouple accordingly. Use the differences between the thermocouple readings as a guide to know how much to offset each thermocouple.

b) If the three thermocouple temperatures are close enough to be reading the same thing (the middle cones did all go over at the same time), then the kiln should say **CPLt** right when the cone tips bend over and touch or just before it. If the kiln is still firing after this point, note how many degrees higher it goes before shutting itself off. Then use the "cone offset" feature to change the temperature equivalent of that cone. Subtract the same amount of degrees from the temperature equivalent that the kiln over-fired the cone by.

c) If the kiln shut itself off before bending the cones properly, you want to reprogram it and then re-start it as quickly as possible. Note the temperature at which the kiln shut down. Get from **CPLt** to **IdLE**, **tC2**, current temperature by pressing either **START/STOP** or **ENTER**. Re-program the same program to one cone number higher, then re-start the firing. Do these steps quickly. Now watch the middle cones again and note at what temperature the cones properly bend. If they bent while you were programming then just offset the temperature by 5 or 6 degrees. Shut the kiln off once you note that temperature. Using the "cone offset" feature, add

the difference of the two readings to that cone's temperature equivalent.

Note: From the factory, the settings that interpret temperature signals in the DynaTrol are hard-programmed; they will not change unless part of the microprocessor has been affected. There is a range of acceptability for the accuracy however and the cone offset feature exists to allow you to fine tune the kiln to particular sized loads. It is best to use all new thermocouples to properly tune the cone offset before individual thermocouples begin to drift. Even keeping one new thermocouple solely for calibrating the individual thermocouples will help to keep the kiln accurate.

CALIBRATING YOUR DYNATROL

This is also covered in the instruction sheet called BASIC OPERATION OF L&L KILNS WITH A DYNATROL 700 in the OPERATION section of your manual or at hotkilns.com/calibrating-kiln.

HELPFUL VIDEOS & LINKS

Calibration

More information on calibrating your kiln:
hotkilns.com/calibrating-kiln

Cone Offset

How to change cone offset in a DynaTrol:
hotkilns.com/change-cone-offset

How to change the thermocouple offset on a DynaTrol. This helps you calibrate the control to match your kiln:
hotkilns.com/change-thermocouple-offset

Firing with Witness Cones

This video shows you how to use witness cones to check the accuracy of the control and your kiln in an L&L Easy-Fire kiln. This video applies to any kiln:
hotkilns.com/firing-kiln-witness-cones

Orton Ceramic Institute

See ortonceramics.com for lots of very helpful information on how to use cones and for many firing tips and great information on firing kilns. See this: ortonceramic.com/Resources/Pyrometric_Cones

Cone Chart

You can see a "cone to temperature" chart in the LOG, CONES, TIPS, CERAMIC PROCESS section of your manual or at hotkilns.com/orton-cone-chart.

BASIC ELECTRICITY TROUBLESHOOTING FOR L&L KILNS

SAFETY CHECKLIST

When repairing a kiln or working around any electrical equipment, always remember...

1. Wear appropriate PPE (personal protective equipment): rubber-soled/closed-toed shoes, safety goggles, or face shield if possible, work gloves, long pants and short sleeves, and remove all jewelry.
2. Do not work on live equipment unless absolutely necessary: unplug power cable and lock out electrical power.
3. If working with live equipment: use only one hand near the equipment; when touching the leads of a multimeter to your circuit, clamp one of them in place and operate the other lead with one hand, keeping your free hand away from the equipment.
4. Clean the area around the kiln and make sure it's free of water.
5. Use the proper tools and don't improvise: for example, use a fuse puller to remove blown fuses; don't use a screwdriver for this.

BASIC ELECTRICITY FOR KILNS

Electricity can be measured in four different ways: amps (current), volts (energy or potential energy), ohms (resistance), and watts (power). You will likely recognize a few of these as in your 15 amp, 120 volt outlet or your 60 watt light bulb. Let's go into a little more detail on each component of electricity.

Volts:

Volts can be thought of as the force or pressure pushing the electricity through the circuit. The higher the voltage the higher the force. (This is why high voltage can be dangerous). Voltage will likely be predetermined in your location, but it varies from place to place. In the United States, we typically have 240V available in most homes with 208V or 480V available in industrial or commercial settings and many schools. Some of your major household appliances (like ovens and house-sized air conditioners) will use 240V while your typical household outlets will use 120V for your small electronics.

Amps:

Amp(ere) is the unit of measurement for electrical current or flow. The higher the amperage the greater the total volume of electricity. Current is important because it represents the strain that will be placed on your electrical system. Your house for example will only have a set

amount of amps (very typically 200 amps) that it can handle and every wire and component must be sized to handle the appropriate amps.

Ohms:

Ohms are the measure of resistance to flow in an electrical circuit. Certain materials are more conductive than others (think copper vs. rubber). Copper has a very low resistance, which allows electricity to freely flow. Our elements are made of a metal alloy that is somewhat resistive, which is good because where there is resistance, heat builds up. Otherwise the kiln would never get hot!

Watts:

Finally, watts are the measure of power. This is important because the more power you have, the faster your kiln will heat up and the higher temperature it can get to. Larger kilns will need more watts than smaller ones, as they need more power to heat up the space in them.

Ohm's Law:

All four of these measurements are related to each other in what is called Ohm's Law. Using this, we can use two measurements to find a third. For example, we can find a kiln circuits amperage by dividing volts by ohms.

Mathematical Relationships (formulas)

For use with single phase only: The electrical industry has designated letters to stand for amps, volts, ohms, and watts.

Amps = "I" (think "intensity of amperage")

Volts = "E" (think "energy")

Ohms = "R" (think "resistance") (Ω is the symbol used to indicate ohms)

Watts = "P" (think "power")

Ohms Law in diagram form.

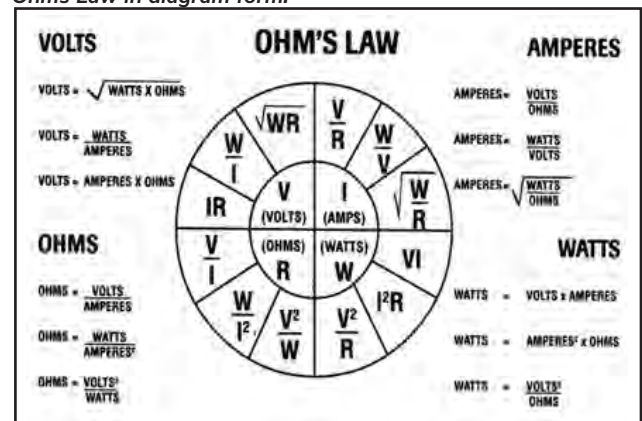

BASIC ELECTRICITY TROUBLESHOOTING FOR L&L KILNS

Single vs. Three Phase:

Electricity can also be delivered in two ways: single or three phase. Single phase means that electricity is moved along two “hot” wires. Think of it as flowing in one wire and out the other. Three phase meanwhile utilizes three “hot” wires to distribute electricity. The advantage here is that current is more spread out meaning that your kiln will draw fewer amps. Fewer amps means smaller wire and circuit breaker are needed.

THE WATER ANALOGY FOR UNDERSTANDING ELECTRICITY IN KILNS

Electricity is analogous to water

Electricity is easiest to understand when compared to water flow and pressure. As far as your kiln is concerned, its supply of electricity is like a huge reservoir of water. Imagine that a kiln is like a bucket with small holes for the water to leak out of (which would represent the heat loss of the kiln). Imagine that the water flowing into the bucket is like electricity. To fill two different sized buckets with the same porosity (i.e. same number of small holes per square inch which would be like the standard heat loss in firebrick) you will need different flow rates of water. If you turn on the small 2.6 cubic foot model e18S, electricity will flow into the kiln at one particular rate, measurable in “watts” per hour (actually Kilowatts per hour, or kWh, 1000 watts = 1 kWh). If you turn on a T3445 which has 34.5 cubic feet, electricity will flow into it at a much greater rate, still measurable in watts per hour. Likewise the larger bucket needs more gallons per hour than the smaller bucket not only to get filled at the same speed but to get filled up at all (because of the porosity). This analogy can help you to understand why it takes longer or might even be impossible for some kilns to heat up to very high temperatures. Note that the heat loss gets greater as the kiln gets hotter so it takes more and more electricity to heat a kiln the hotter it gets. It is like the porosity increasing over time as you fill up the bucket in the above analogy.

Amps (amperes) = flow

If the volume of water can be measured in gallons per second, then the volume of electricity flowing is measured in “amps”, a particular amount of electrons flowing through a wire in one second.

Volts (voltage) = pressure

Water is forced through the pipes by water pressure. A water tank at the top of a hill will provide you with more water pressure than a water tank only half-way up the

hill. Electricity is forced through the wires by electrical pressure, called volts. A 12 volt battery is like the lower water tank: there is not much voltage to push the electrons along the wire. A 120 volt house power source is like the higher water tank, pushing a much greater volume of electricity (many more amps) down the same diameter wire than the 12 volt source.

Ohms (resistance) = resistance to flow

Say your house in the valley is somehow fed by both of these two water tanks. Sink number one has water from the top-of-the-hill water tank flowing to it. Sink number two, which is right next to sink number one, has water from the half-way-up-the-hill water tank flowing to it. Sink number one will have much greater water pressure and much more water coming from it than sink number two (assuming the same size orifice in the faucet). To get them to flow at the same rate, you must use a smaller diameter pipe to connect the water to sink number one than the pipe connecting the water to sink number two. By restricting the heavier flow of water with a smaller pipe, you can make the same amount of water come out of each sink. Electricity can be restricted (or “resisted”) as well. A small diameter wire can resist electricity like the smaller pipe resisted the water. In the same way that a large pipe will let more water through than a small pipe, a thick wire will have less resistance and will allow more electricity through than a thin wire. A short wire will have less resistance and let more electricity through than a long wire. This amount of electrical resistance can be measured in terms of “ohms”. The higher the number of ohms, the higher the resistance of the circuit.

Watts (power) = work

In the same way that the combination of water pressure and the actual water itself (measured in gallons per second) comes together to perform “work”, the combination of voltage (pressure) and amps (volume) comes together to perform “work” as well. This electrical work is measured by multiplying the values of the volts and the amps together. The result is called “watts”. Watts are a measurement of the work done by electricity.

Single Phase Power

Like voltage, the phase is specific to each location. The huge electrical lines you see across the country use three “hot” lines, what is termed “three phase”, with 1000’s of volts running through them. From these three “hot” lines any two can be tapped (eventually, after stepping down the voltage through transformers) to provide power for any single phase circuit. To use a small electrical appliance as an example, if you trace the two wires that make up

BASIC ELECTRICITY TROUBLESHOOTING FOR L&L KILNS

the cord for the appliance back through the lines you will eventually end up at two of the three wires from some main power line, and from there back to the generating plant. Often the power for a residential area is all single phase, from a junction station to a single house in the neighborhood. There may be no way for three phase power to be obtained without the equipment (mainly the extra line) in place. Industrial areas, large facilities, and schools usually have access to three phase power. Even then, sometimes the three phase ends at the main junction box in the building and the single phase power supplies branch out from there.

Three Phase Power

Three phase power uses three "hot" wires to supply electricity to the circuit. From the main power supply, the three lines remain three lines all the way through to the circuit. The same amount of electricity is simply split over three wires instead of two. The benefit of three phase is not a lower electric bill, since the kilowatts used are still the same. The benefit is in the cost of setting up the supply line itself. For example, a model T3427 208 volt in single phase draws 119.88 amps. It will need two "2/0" awg wires to supply it with power. The circuit breaker would need to be a two pole, 150 amp breaker, and any safety switches would need to be rated for at least 150 amps, if not more. That same kiln in three phase will draw 69.21 amps. It would only need three 2 awg wires to supply it with power. The circuit breaker would only need to be a three pole, 90 amp breaker, and any safety switches would only need a 90 or more amp rating. The cost of material and components for creating electrical lines are expensive. This cost increases exponentially with the size of the service. A 2/0 awg wire costs considerably more per foot than a 2 awg wire. The size of the conduit that houses the wires costs more as the diameter increases. A 150 amp circuit breaker is large and has a heavy protective housing. It has mechanical arms to provide leverage and physically move the electrical contacts together or apart. A 90 amp breaker is more familiar looking, with its plastic switching arm and the way it sits side-by-side with the other breakers in the box. The total cost (especially if power needs to be run for some distance) is much less for three phase than for single phase. The cost for another wire in the three phase is almost always offset by the potentially vast difference in total cost between installing single and three phase.

SERIES CIRCUITS

A circuit that only has one path over which current can flow is a series circuit.

A break in any part of a series circuit stops current flow.

All components in a series circuit see the same amount of current; therefore, each component must be capable of carrying that number of amperes.

RULES FOR SERIES CIRCUITS

- 1) The value of a current (amperage) flowing in a series circuit is the same through all parts of the circuit.
- 2) The total voltage of a series circuit is equal to the sum of the voltages across each part of the circuit.
- 3) The total resistance (ohms) of a series circuit is equal to the sum of the resistances across each part of the circuit.
- 4) Line voltage is divided across each component in a series circuit in proportion to the component resistance values. Referring to the schematic below, the total resistance is ($25\Omega + 30\Omega = 55\Omega$). Voltage measured between points A and B is:

$$240 \times (25\Omega/55\Omega) = 109 \text{ Volts.}$$

Voltage measured between points B and C is:

$$240 \times (30\Omega/55\Omega) = 131 \text{ Volts.}$$

Note that $109 + 131 = 240$ volts

Series circuit:

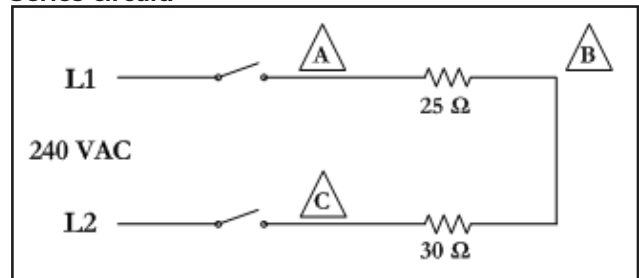

If there were (2) resistances whose values were equal, the voltage would be divided equally in half, and would measure 120 Volts.

Measuring Resistance in Series Circuits

The total resistance of a series circuit is the sum of all the individual resistances.

BASIC ELECTRICITY TROUBLESHOOTING FOR L&L KILNS

PARALLEL CIRCUITS

A circuit that has two or more current paths is a parallel circuit.

Each component is connected to line voltage, and current still flows through part of the circuit if one component fails.

Each component must be capable of withstanding the full line voltage.

The amount of current (amperes) varies according to the resistance of each separate part of the circuit.

The more circuit paths, the less opposition to the flow of electrons. Total circuit resistance decreases when more paths are added.

RULES FOR PARALLEL CIRCUITS

- 1) The total current (amperage) supplied to a parallel circuit is equal to the sum of the currents through the branches.
- 2) The voltage across any branch of a parallel circuit is equal to the supply voltage.
- 3) The total resistance of a parallel circuit is always less than the resistance of any of the branches.

Example of a Parallel Circuit in an L&L kiln

The following parallel circuit is typical of the DaVinci, Doll and J2900 kiln rings; there are (3) elements per ring, connected in parallel.

In this example, each element has a resistance of 49.8Ω. At 240 VAC, each element develops

$$(240 \text{ VAC} / 49.8\Omega) = 4.82 \text{ Amperes}$$

The total circuit amperes, then, is

$$4.82 + 4.82 + 4.82 = 14.46 \text{ Amperes.}$$

Parallel Circuit:

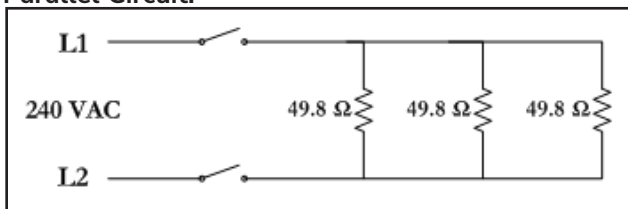

Measuring Resistance in Parallel Circuits

The total resistance is always less than the lowest reading of a single element. Often this is difficult to measure if all the elements in the circuit are connected to two points with no way to isolate them.

If all elements are known to all have the same resistance then you can multiply the number of elements by the resistance value of the entire circuit to get one

element's approximate resistance. In the above example The resistance of the entire circuit is $49.8\Omega / 3 = 16.6\Omega$.

$$\text{Total Resistance} = 1 / ((1 / R1) + (1 / R2) + (1 / R3))$$

If the elements in the circuit have different resistances, like in School-Master kilns, there is no easy way to determine the individual resistances of the elements. The best way to solve an element problem with these kilns is to replace all the elements in the troublesome circuit. You can also measure the resistance on each element.

BASIC ELECTRICITY TROUBLESHOOTING FOR L&L KILNS

SERIES/PARALLEL or COMBINATION CIRCUITS

Certain circumstances require the use of Series/Parallel, or Combination circuits (in which series and parallel circuits are combined). In some front-loading kilns these circuits are used to combine, for instance, sidewall heating elements and backwall heating elements (often shorter than sidewall) in a combination circuit that is controlled by one power relay.

Example of a Series/Parallel Combination Circuit:

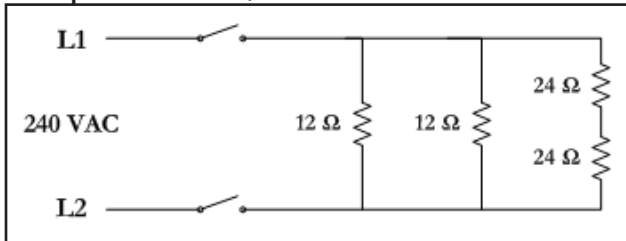

In the above example, the total resistance can be found by first dealing with each branch circuit individually. Starting from the right, this circuit is a series circuit; add the ($24\Omega + 24\Omega = 48\Omega$). The other two circuits are parallel and are equal in value (12Ω each); therefore, the resistance value of these two circuits is equal to ($12\Omega/2 = 6\Omega$). Drawing an equivalent circuit with (2) parallel circuits, one of 6Ω and one of 48Ω , looks like the following:

Series/Parallel Circuit simplified:

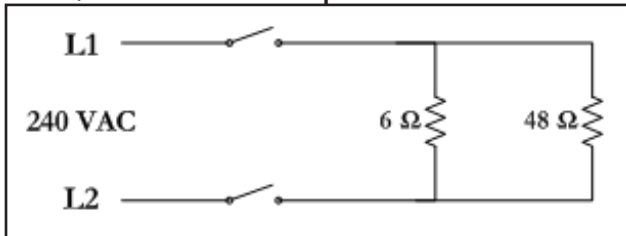

Solving for this circuit:

$$\text{Total Resistance} = 1 / ((1 / R1) + (1 / R2) + (1 / R3))$$

$$\text{Total Resistance} = 1 / ((1 / 6\Omega) + (1 / 48\Omega)) =$$

$$1 / (.1666 + .02083) = 5.33\Omega$$

WHERE TO GET MORE INFORMATION ABOUT ELECTRICITY

hotkilns.com/volts.pdf

www.elec-toolbox.com

ELEMENT TROUBLESHOOTING & INSTALLATION INSTRUCTIONS

TABLE OF CONTENTS

ELEMENT TROUBLESHOOTING	1
Getting E-1 Error.....	1
Why does an older kiln slow down?	1
Elements expand and grow with age.....	1
What if I see charred and blackened corners?	2
Factors shortening element life	2
Element Terminal Burn-out.....	3
CHECKING ELEMENT OHMS	3
Easy-Fire, eQuad-Pro, Liberty Belle, Doll, School Master, e23S-JH 3	
Jupiter, Davinci.....	4
How to check ohms of an entire L&L kiln section. Put the test leads of the multi-meter on the two "hot" plug terminals:.....	4
HOW ELEMENTS ARE WIRED	4
Why is this important?.....	4
Series Circuits.....	4
Series-Parallel	5
Specific to non-sectional kilns:.....	5
POWERED BOTTOMS	5
OTHER TYPES OF ELEMENTS	5
Heavy-Duty elements	5
APM Elements	5
Quad Elements	5
Increasing Power in Your Kilns	6
CHANGING ELEMENTS	6
SEE THESE VIDEOS FIRST	6
REMOVING OLD ELEMENTS.....	6
CHECKING ELEMENTS.....	7
STRETCHING ELEMENTS.....	8
INSTALLING NEW ELEMENTS.....	8
FIRST FIRING WITH NEW ELEMENTS.....	9
REPLACING ELEMENT HOLDERS	9
Method #1.....	10
Method #2.....	11

ELEMENT TROUBLESHOOTING

Getting E-1 Error

If you get an E1 or E-1 or Err1 error code on your DynaTrol or On-Touch control it means that your kiln no longer can get to temperature. It is slowing down. There are three main causes of this in order of likelihood:

- 1) Your elements have aged and need to be replaced. This is most likely when you notice the kiln gradually slowing down.
- 2) One or more contactors or relays have failed. This is most likely if you notice a sudden change.
- 3) You have a low voltage problem. This is most likely if you find this happening in the summer.

Why does an older kiln slow down?

Old elements generally increase in their resistance. Mathematically this increase in resistance will decrease the amount of amperage and, ultimately, the amount of heat given off by the elements. This is why older kilns sometimes go so slowly and may not reach their maximum temperature. Periodic element resistance readings using the multimeter will allow you to check the "health" of your elements. Of course, a slow firing kiln is the first indication that you have an element problem.

Elements expand and grow with age

If you fire low-fire clay and glazes and never get above cone 4 or so, your elements will last a long time, especially if you are only bisque firing. This is good, to a point. If you only low-fire, the problem you are most likely to encounter over time is that the elements expand as they age. The length and the coil diameter increase. Meanwhile the atmosphere in the kiln slowly eats away at the metal of the element. Although the total resistance usually increases as the elements age, sometimes it decreases, or reverses itself. This usually only happens when the elements are very old but have not yet failed completely. As the element expands, it binds up in the corners. This can make the individual coils push together and touch each other in the corners, making a short cut for the electricity, reducing the amount of element material the electricity must pass through, and therefore reducing the resistance in the whole element. This may make it hotter in the kiln, but if there is a lot of element material jammed in the corners there will not be enough material left in the coiled form to radiate the heat generated by the increased amperage and decreased resistance. Only the parts of the wire not touching the coils on either side of them will emit heat. More amperage through the electrical components in the control could cause damage if the situation continues or the resistance drops far enough.

In addition, the expanding diameter of an element can make it difficult to get it out of the holder. Usually this will not happen to those firing to higher temperatures because the maximum temperature of the kiln is quickly compromised by increases in the resistance, requiring the elements to be changed long before they can jam up in the corners. Also, high temperatures and glaze firings are more prone to eating through the element, causing it to fail, before the element can expand enough to cause the problems mentioned above. Use the multi-meter. Visually inspect your elements.

ELEMENT TROUBLESHOOTING & INSTALLATION INSTRUCTIONS

What if I see charred and blackened corners?

The coils that sometimes get squashed together in the corners do not always touch each other, but they may be close enough to allow the electricity to 'arc' across the gap. An electrical arc can generate extreme temperatures for the millisecond it arcs. Charred and blackened corners of the kiln are warning signs for this problem.

Do not confuse this with what can be observed even with new elements; which is randomly sized sections of the coils glowing more quickly than other sections of the same coil. The annealing process of the wire causes this, and does not adversely affect the elements' operation in the kiln.

Factors shortening element life

1) Contamination (such as glaze or kiln wash). Silica, a main ingredient of both of these, attacks the element wire.

2) Tightly wound areas on element coils resulting from improper stretch. Have the elements been stretched evenly? This is important. If the element coils are bunched up along the length of the element the element will overheat where the coils are too close. Some replacement elements are shipped unstretched. Even prestretched elements may need some stretching. See section below on stretching elements.

3) Glaze accidentally rubbing off into holder and on element in loading kiln. If this occurs immediately vacuum the kiln and element holders thoroughly. Glaze will cause very rapid element failure.

4) Blow ups or explosion of bisque ware cause small pieces of clay to be blown into holder and element. If not immediately removed clay may melt, contaminating the element and element holder. Keep in mind that temperatures are considerably higher right next to the element so that you may very well exceed the clay melting temperature next to the element even if the kiln temperature is correct for the clay body.

To avoid explosions make certain clay is very dry before firing and, in the case of heavy handmade pieces, fire on low for a long period until you are sure ware is dried out thoroughly. If you hear a "pop" when firing such pieces, stop firing, cool the kiln. If blow-up has occurred, vacuum all element grooves very thoroughly. If you have the DynaTrol use the PreHeat feature for this final forced drying.

5) Firing pieces too close to elements. We recommend at least 1-1/2" from piece to element. Further if large flat surfaces are parallel to kiln wall.

6) Reducing atmospheres will destroy elements. Do not use wood chips, oils and other materials to generate a reducing atmosphere. A very rapid element failure may result. NOTE: Reducing atmospheres are the opposite of oxidizing atmospheres (plain air is an oxidizing atmosphere). The word reducing comes from the ability of a reducing atmosphere to "reduce" oxides.

7) Are any waxes, oils, carbon, fluorine, fumes present? Are you using any lead glazes? Iron-Chrome-Aluminum elements require an oxidizing atmosphere to give dependable service. The aluminum in the element forms a protective aluminum oxide. Oil from tools or carbon from wax burnout will attack the element coating. Halogens such as chlorine or fluorine will attack the elements. Molten metals, for instance, zinc, aluminum and copper, react with iron-chrome-aluminum elements. Moreover, these metals oxidize easily and their oxides have an unfavorable effect on iron-chrome-aluminum. The salts of the alkali metals, halogen salts, nitrates, silicates, and compounds of borax, disturb the formation of oxide and are, therefore, harmful to these elements. This is also true of the oxides of such metals as copper, lead and iron. Do not use with free carbon. Lead oxide attacks the protective alumina oxide coating on the element. If you are using lead glaze (or are creating any of these other problems) be sure to use a kiln vent. Also try firing every other load or as often as you can with a non corrosive load (such as a bisque firing). This will help the element restore its protective alumina oxide coating. Note that clay almost always has organics (which will create a slightly reducing atmosphere, sulfur (which will also attack elements) and fluorine which is also corrosive. This is one reason why proper venting is critical for long trouble-free operation of your kiln.

8) Excessive soaking time will accelerate increase in element resistance. The higher the temperature, the longer the soak, the sooner the element will decrease in life. Usually short soaks work fine.

9) Are they genuine L&L elements? There are a number of people selling "replacement elements" for kilns. These people do not have access to the proper design information for L&L elements. Designing an element is a complicated process which balances such things as voltage, wire diameter, watt density, stretch ratio, etc. It is very easy to make an element that has the same watts as an L&L element and have nowhere near the other design qualities that result in long element life.

10) If the failure is taking place at the element end it may be twisted too tightly, causing stress at terminal through

ELEMENT TROUBLESHOOTING & INSTALLATION INSTRUCTIONS

holes. This causes local overheating at the “through hole”, and element failure. (Contact factory).

11) Make sure all elements are heating. If all elements are not doing their share of the work then the other elements will not last as long.

Element Terminal Burn-out

Sometimes the ends of the elements can burn out at the element terminals (connections). This can be due to any or all of the following causes:

1) The element ends are not twisted properly. If the twist is too loose this could generate extra heat at the element ends.

2) The holes where the elements go through the firebrick walls are too large. This could cause too much heat to escape from the kiln thereby overheating the element terminals. This can be remedied by lightly stuffing ceramic fiber (we have non-RCF ceramic fiber available in our parts list) in the element holes.

3) The element connection hardware may not be tight enough. A loose connection can generate heat and cause oxidation of the hardware which in turn will cause a worse electrical connection (because of resistance) and more heat. Replace with new hardware.

4) The hardware should be stainless steel or at least nickel plated. Check to see if the hardware is in good shape. If not replace at least the hardware with stainless steel hardware or better yet replace the whole terminal board assembly with one of our new ones.

CHECKING ELEMENT OHMS

The most common cause of kiln slowdown, E-1 messages, and failure to reach temperature is element wear. As your elements age they generally increase in electrical resistance. According to Ohm's Law, when resistance, measured in Ohms, increases, both Watts and Amperes will decrease, assuming Voltage remains constant. Since Amps and Watts are the measures of current and power respectively, they can be thought of as the amount of juice that your kiln has to generate heat. Obviously if you don't have enough power, your kiln will fire slowly and might not even reach the desired temperature.

Using resistance, we can tell exactly how much power your kiln has lost over the course of your element's life. For example on an e23T that uses 240V, a brand new kiln section would read about 14.5 ohms. If you measured this same kiln section after several months of cone 6 firings

let's say and the reading was 16.5 Ohms, you would know that this section of elements has lost approximately 14% of it's power ($16.5/14.5=1.138$, or close to a 14% increase). Again, an increase in resistance means decrease in power. A very general rule of thumb is that most people will typically begin to notice some slowdown once you've lost more than 10% of your power. It will certainly vary based on the kiln you have, your voltage, as the types of firing you do. People only doing low fire work will continue to get by on lower power than those needing to go to higher temperatures (cone 6+). As you can see, measuring your element Ohms is the best way to identify when elements need replacing.

Keep in mind that the ohms on the wiring diagram are per ELEMENT while your reading will be per SECTION. How you figure out the section ohms depends on whether the elements are wired in Parallel or Series. Most kilns are wired in Parallel except for JD230V and most 18" kilns like the e18T. For a parallel kiln you take the per element ohms listed and divide by the number of elements per section. Ex. e23T 240V 1 Phase is 28.9 Ω per element with two elements per ring = 14.5 Ω per section. Ex. 2. JD2927 240V is 36.5 Ω per element with three elements per ring = 12.2 Ω per section. See this link for more info on Series vs. Parallel

Here we will show how to best measure your element resistance for two groups of L&L Kilns, into which most models fall.

Easy-Fire, eQuad-Pro, Liberty Belle, Doll, School Master, e23S-JH

See this video: [hotkilns.com/test-resistance-ez](https://www.hotkilns.com/test-resistance-ez)

In these series' of kilns a piggy-backed control panel covers up the element terminals.

1. Turn the power to the kiln completely OFF and unplug it if possible. If it is direct wired, then you should at least turn off all power at the disconnect switch or circuit breaker.

2. Open the outermost control panel by unscrewing it either from the element cover box in the case of Easy-Fire, eQuad Pro, School Master and Liberty Belle kilns or from the kiln body in the case of Doll kilns.

3. Once you open up that control panel you will see the element power wire terminal strip. See the picture. It will have numbered wires coming from the element terminal blocks and wires connecting to the power relays. There are two wires per kiln section/ring, so numbers 1 & 2 are for the top section, 3 & 4 for the middle, and 5 & 6 for the bottom section on a three ring kiln.

ELEMENT TROUBLESHOOTING & INSTALLATION INSTRUCTIONS

4. Set your multimeter to Ohms (Omega symbol Ω) and using your testing leads, place one in between the two tabs/terminals w/ #1 wires connected. There is a small circular divot that the lead fits into (see picture). Put the other lead on terminal #2 and make note of the reading. Repeat the process for 3 & 4 and then for 5 & 6. Remember that each pair of wires represents one section.

5. Compare your readings to those on the wiring diagram in your instruction manual. Keep in mind that the ohms on the wiring diagram are per ELEMENT while your reading will be per SECTION. See above for more info on understanding the readings.

Jupiter, Davinci

See this video: hotkilns.com/test-resistance-jupiter

In these series' of kilns, the control panel is separated from the kiln body and the element terminals are connected to the controls via external jumper cords or plugs.

1. Turn the power to the kiln completely OFF and unplug it if possible. If it is direct wired, then you should at least turn off all power at the disconnect switch or circuit breaker.

2. Unplug the first jumper cord from the control panel.

3. Set your multimeter to Ohms (Omega symbol Ω) and using your testing leads, place one lead on each of the "hot" prongs. They will be the flat ones.

4. Make note of the reading and move on to the next one.

5. Compare your readings to those on the wiring diagram in your instruction manual. Keep in mind that the ohms on the wiring diagram are per ELEMENT while your reading will be per SECTION. See above for more info on understanding the readings.

How to check ohms of an entire L&L kiln section. Put the test leads of the multi-meter on the two "hot" plug terminals:



HOW ELEMENTS ARE WIRED

Why is this important?

The way the elements in a particular kiln are wired is important. Different wiring schemes with the same resistance elements will yield drastically different results. For example, if a kiln section or group of elements is out, and the kiln is made up of series circuits, you would first look at the elements because even one element out in a series circuit can make all the elements in that circuit appear to be burned out. If this same kiln had parallel circuits you would first look at the switch or relay. This is because in a parallel circuit, if one element is out the others will still light, so for all the elements in the parallel circuit to be out would mean that whatever controls the circuit (i.e. the switch or the switch by way of a relay) or the wires in-between would be suspect. CAUTION: Accidentally wiring a kiln with parallel element circuits will make it heat up incredibly fast, until the breaker trips. For instance, An e18S-3 kiln wired properly, in series, draws 23 amps at 240 volts. Wired in parallel it would draw around 90 amps at 240 volts, which would be disastrous.

Series Circuits

In a series circuit, power flows through one element and then another. We can see this in how it is wired. Think again of power coming in one wire and out the other.

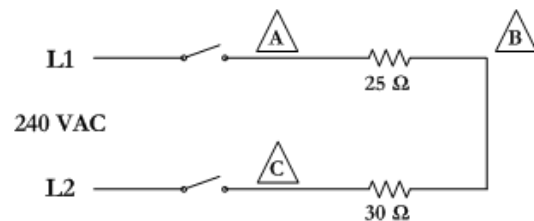

Parallel Circuits

Parallel circuits meanwhile allow power to flow through both elements simultaneously in no order. The power is applied to the beginning and end of ALL the elements at once. Thus the resistance of the entire circuit is the number of elements in the circuit divided into the factory resistance value for one element.

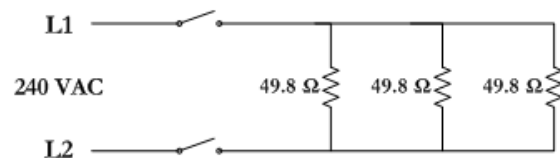

ELEMENT TROUBLESHOOTING & INSTALLATION INSTRUCTIONS

Series-Parallel

Sometimes element wiring can be termed series-parallel.

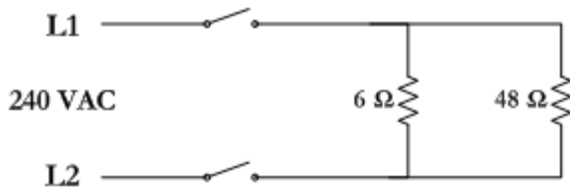

Both series circuits get power at the same time, making them series-parallel circuits.

Specific to non-sectional kilns:

In non-sectional kilns it can be difficult to tell the element circuits apart since the element connection board runs the entire length of the kiln and covers all the circuits. Trace the connecting wires to discover the beginning and end of each element circuit on the element connection board. Ideally, you would draw a picture of each element circuit before dismantling it. If you are just replacing the elements it is not necessary to know if they are wired series or parallel; it is imperative, though, that they go back together exactly how they came apart.

For a more in-depth description of Series, Parallel and Series-Parallel circuits, along with descriptive diagrams see **BASIC ELECTRICITY TROUBLESHOOTING FOR L&L KILNS** in the **TROUBLESHOOTING** Section for more information on circuit wiring. If you want even more information about electricity for kilns see hotkilns.com/volts.

POWERED BOTTOMS

The elements on the powered bottoms are typically the same as those in the kiln with some exceptions. Series elements cannot be used by themselves in a power bottom, so a parallel element must be used in smaller, series-wired kilns like the JD230V-PB.

OTHER TYPES OF ELEMENTS

Heavy-Duty elements

If your kiln was made after January of 1996 (the year and month are coded into the serial number) it has larger cross-section element holders. These new holders are capable of holding a larger diameter, heavy gauge element. These high grade heavy duty elements feature lower watt density than the standard elements and that, coupled with the

heavier gauge wire, results in longer element life. If you are experiencing short element life because of your duty cycle (frequent firing, high temperature firing, long soak times) you should try these heavy duty elements. They have the same ohm rating (resistance) as the standard elements. This means that the power rating of the kiln does not change. It also means that you can use them with the standard elements. One consideration with mixing the standard and heavy duty elements is that the heavy duty elements will age more slowly than the standard elements and may have an effect on uniformity in the kiln. This is really no different than what you would experience when you change just one element and so have a new element (unaged) with older elements. Dynamic Zone Control will automatically balance your system and compensate for this problem. We do suggest, however, that you put any newer elements in the bottom ring where temperatures tend to be cooler and hence need as much power as they can get. Keep in mind that L&L can not keep track of which elements you have and that you must specify heavy duty elements when ordering. If you don't specify heavy duty elements you will get standard elements.

APM Elements

APM is a special version of the Kanthal A-1 alloy used on kilns. It is sintered and resists the crystallization that normal Kanthal type alloy experiences. As a result it makes sense to use this when you are doing processes that require long holds at high temperatures (like crystalline glaze for instance). On the other hand these elements are very expensive and a subject to the same problems like glaze contamination that any elements can experience. See hotkilns.com/apm for more information.

Quad Elements

The quad element option gives you four rows of heavy duty elements to maximize element life and heating power. Double the element surface area means that quad elements will degrade at a slower rate than ordinary elements which is great for those firing to high temperatures. More surface area also means more radiated heat for faster and more even firings. Quad elements are also typically made from thick gauge element wire further increasing their durability. Note: Quad element designs use extra long elements to wrap around the kiln twice each meaning that the electrical specs are kept the same. Because of the need to have more element holders in the brick, quad elements are not interchangeable with regular elements. See hotkilns.com/quad-elements for more information.

ELEMENT TROUBLESHOOTING & INSTALLATION INSTRUCTIONS

Increasing Power in Your Kilns

If you have a JD230 you can retrofit the new Easy-Fire e23T elements in that specific model and increase the power rating of the kiln. That will give you about 10% more power to start with and therefore, as elements age, the lowering power will have less impact on your firings. See hotkilns.com/jd230-ez as an example. These elements can be retorfitted into older kilns.

CHANGING ELEMENTS

SEE THESE VIDEOS FIRST

For most top loading kilns:

hotkilns.com/change-elements-ez

For kilns with Quad elements:

hotkilns.com/change-element-quad

REMOVING OLD ELEMENTS

- 1) Unplug kiln or turn off the kiln at the fused disconnect switch.
2. First remove the control box or element boxes and their wire connections from the kiln. Before undoing any wires, however, label how the wires and the elements are configured inside the element boxes (take pictures if needed). After you are certain you have documented the wiring then you can carefully remove the wires.
- 3) Using a 3/8" nut driver remove the nuts that hold the element end onto the Element Terminal Bolt. If you don't have this tool you can use an adjustable wrench - it will just take longer.

A 3/8" nut driver:



- 4) Untwist the element end from around the Element Terminal Bolt. Straighten it out as much as possible.

Untightening the element terminal:



- 5) Cut the old elements off as close to the "through hole" on the outside of the kiln as possible. You want a straight element tail to pull through the through hole, not a crooked one.

FOR OLDER NON-CERAMIC TERMINAL BOARDS: Remove all the old tails from the element connection bolts and re-tighten these bolts to the element connection board. You may have to remove the element connection board from the kiln to do this. If the bolts are corroded, replace with new stainless steel terminal bolts, nuts, and washers. If the terminal board itself is burnt or broken replace that as a complete unit with new hardware.

- 6) In most cases you can just lift the element out of the holder at this point. Sometimes, if the element has really disintegrated, you need to remove it in pieces with needle nose pliers.

Using a sharp tool like a screw driver lift the elements out of the ceramic grooves at the corners. You can slide the holder over to make enough of a gap to get the tool under the element:



ELEMENT TROUBLESHOOTING & INSTALLATION INSTRUCTIONS

Lift Elements out of the groove of the ceramic holders:

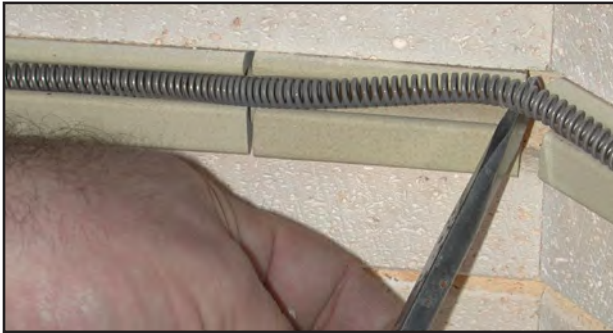

Sometimes very old elements can become wedged in the element holders, making it necessary to carefully pry/twist/break them out. A propane torch or just turning the kiln on for a few minutes (if it will come on) will soften the wire of the elements and make them easier to get out. Use heat protecting gloves such as welding gloves or heat treating gloves (you can buy these from L&L) and a pair of needle nose pliers to pull out the softened element. DANGER: You could burn or electrocute yourself if you get the elements too hot or forget to unplug the kiln after warming them up. IF YOU DECIDE TO USE THIS METHOD BE VERY CAREFUL OF THE POTENTIAL FOR BURNING YOURSELF.

7) Be sure to check for failure points for evidence of contamination on the element and the element holder. If the element holder is contaminated it will cause rapid failure of the new element. Replace contaminated holders with new ones (See later in this sheet how to do this).

8) From the inside of the kiln, using needle nose pliers, grab the element as close to where it goes through the brick wall to the Terminal Block. Pull the element end through the hole. Be careful not to enlarge the hole in the firebrick. The brick is quite soft and will not take much abrasion.

Removing element from inside the kiln:



9) FOR OLDER MODELS WITHOUT CERAMIC TERMINAL BOARDS: There are normally ceramic insulator bushings on the outsides of the through holes that the elements pass through. On some models (particularly older J2900

kilns and DaVinci kilns) there are spacers to keep these insulators in place. These may fall out (and chip or break) if you are not careful. Be sure not to lose these spacers when replacing elements. Note carefully how they are positioned so you can replace in the same way. Note that on the new all ceramic terminal boards used on the J2900 and DaVinci kilns there are no bushings or spacers - it is all one integrated piece.

10) Once the old elements are out, carefully vacuum all the element holders. Watch for any glaze or material contamination. Anything that will melt (i.e. glaze, slip, porcelain, etc.) will cause rapid failure of the new element. Chip or scrape carefully to remove the contaminant, or replace the affected element holders. DO NOT replace the element if there is foreign material stuck in the element holders. You must fix that problem first by either cleaning or replacing the contaminated element holder.

CHECKING ELEMENTS

Examine your new elements. Look to see the wire thickness is similar to that of the old ones. Look to see that the coils per inch and the diameter of the coils are also similar. Using your multimeter check the resistance of your new element. Compare to the factory resistance value(s) for your kiln's elements. Your reading should be no more than one ohm off (less for elements with ohm readings of less than 10 ohms). If you have received the wrong element in error call the factory to get it exchanged. This is the time to deal with the problem. DO NOT WAIT UNTIL YOU HAVE STARTED THE JOB, STRETCHED THE ELEMENT OR EVEN INSTALLED IT BECAUSE AT THAT POINT YOU WOULD NOT BE ABLE TO RETURN IT.

ELEMENT TROUBLESHOOTING & INSTALLATION INSTRUCTIONS

Checking resistance of the elements before you put them in. This is a good double-check and can save you a lot of trouble if there is a mistake. Put the probes on the twisted element ends about 3" from the beginning of the coil:



STRETCHING ELEMENTS

NOTE: Most replacement elements come prestretched. All elements are slightly understretched and will have to be adjusted for final fit. The following are instructions for how to stretch unstretched elements:

To determine total length to stretch an element measure total length of element grooves.

IF ELEMENTS NEED TO BE STRETCHED

- 1) Mark floor with two marks for stretched length. Have a helper stand on the tail of one element, and pull the other tail until the element is the proper length. The assistant must stand very firmly because a flying element could cause severe injuries. WEAR SAFETY GLASSES WHEN YOU DO THIS. Alternately clamp the end to something with vice-grips.
- 2) Examine for evenness of stretch. Selectively stretch close wound sections to provide uniformity of stretch.
- 3) Repeat this procedure several times.
- 4) You will have to pull element beyond last mark in order to obtain full stretch.
- 5) If overstretch occurs insert a metal rod or small diameter dowel into the element coil and compress with needle nose pliers.
- 6) Stretch uniformity is necessary for satisfactory element life.

INSTALLING NEW ELEMENTS

NOTE: We highly recommend you get all new element terminal hardware when you replace your elements. In fact we offer a 50% discount on element terminal hardware when buying elements.

- 1) Replace one element at a time so that you do not make a mistake with the wiring.
- 2) Insert the tails through the through holes from the inside out. Element ends should be straight at this point.
- 3) Pull them up tight up to the wall of the kiln by pulling from outside the kiln.
- 4) Lay the element into the groove. Note that the unfired element is going to have some springiness to it before it is fired for the first time. You may need to use a screw drive to press the element into the holder. YOU DO NOT NEED PINS.
- 5) FOR KILNS WITH NON-CERAMIC TERMINAL BLOCK OR ON RETROFITTED KILNS WHERE YOU HAVE ADDED A CERAMIC TERMINAL BLOCK BUT STILL NEED BUSHINGS: Be sure to replace the insulators and spacers over the element tails.
- 6) Consulting your picture or labeling, wrap the appropriate element tails around the appropriate element connection bolt, clockwise, once around, and cut off the excess tail. If you have the newer large washer system you just need to make a "U" around the bolt and let the large washer do the clamping.

Detail showing the terminal set:



ELEMENT TROUBLESHOOTING & INSTALLATION INSTRUCTIONS

Detail showing all the parts:



Detail showing how all the hardware gets assembled on the Terminal Bolt:



- 7) Install the elements and hardware:
 - a) A washer goes under the first element
 - b) Twist the first element end **CLOCKWISE** around the Terminal Bolt.
 - c) The next element gets twisted around the Terminal Bolt on top of the first element.
 - d) Then another washer goes over the Terminal Bolt.
 - e) Then the nut goes over it and get tightened.
 - f) Then a washer goes on.
 - g) Then the Ring Terminal of the Power Lead Wire goes on.
 - h) Then a washer goes on.
 - i) Then another nut goes on and gets tightened. How tight you can make this is dependent on how tight you got the

element connection bolt onto the element connection board. A tight connection is very important, but if you tighten too much and twist the element on the bolt too far you could break the element, the bolt, or the insulator.

Detail showing how all the parts for an older style "red board" terminal system for a J2900 kiln:



- 8) Place the wires from the jumper cord or connecting wires onto the appropriate bolts and tighten with stainless steel nuts.
- 9). Reattach the ground wires and the element box if the kiln has them. **DO NOT FORGET TO ATTACH GROUND WIRES. IF EACH KILN SECTION IS NOT GROUNDED THIS CAN BE VERY DANGEROUS.**
- 10) Test the ohms at the jumper cord's plug head or at the other end of the connecting wires.
- 11) Reattach the control box, turn the kiln on and make sure all the elements come on.

FIRST FIRING WITH NEW ELEMENTS

NOTE: You may experience some smoking from the kiln on its first firing with new elements. This, if it occurs, is due to residual oil left on the element wire when the wire was made. We recommend firing the kiln empty to cone 5 once to oxidize the new elements (no particular speed is necessary) and to seat the new elements in the holders.

REPLACING ELEMENT HOLDERS

See this video: [hotkilns.com/change-element-holder](https://www.hotkilns.com/change-element-holder)

- 1) When ordering a new holder provide model number of kiln and length of the element holder. See the Parts List for this information.

ELEMENT TROUBLESHOOTING & INSTALLATION INSTRUCTIONS

2) Note that if the holder has melted badly you may need to either replace the brick that holds it or at least patch the brick with our Brick Repair Kit.

Method #1

1) This method leaves the kiln in tact. You break up the holder and remove it in pieces and then modify the new holder to snap into the groove.

2) Using a chisel or large screw driver and a hammer carefully crack the holder that needs to be removed.

Just take your time with this. You can break the holder into little pieces so that it comes out:



The holder shown with about half the job done:



The groove is shown with the holder removed:



Using Linemen's Pliers snap off the BOTTOM edge of the holder



A normal holder compared to one with edge removed:



ELEMENT TROUBLESHOOTING & INSTALLATION INSTRUCTIONS

You can now just snap the new holder into the slot in the firebrick. It will hold in place with no cement:



Method #2

This method requires you to take the kiln sections apart.

- 1) Take the section with the bad holder off the kiln and put it on a flat surface like a flat floor or table.
- 2) Carefully pull the elements out of the element holders of the brick section involved and allow them to hang loose. Take great care not to “break” the element as they are very brittle after firing.
- 4) Loosen up the adjustable clamps that hold the stainless steel wrapping. Loosen them just enough to allow the brick to slide out with slight hand pressure (so that the other bricks stay in place). NOTE: If you don't have the section on a flat surface then the bricks will all come out of proper alignment at this point.
- 5) Pull up the brick with the bad element holder just enough to allow removal of the defective element holder and replace with new one. Slide the bad brick(s) out and put in new brick(s). Be sure the element holders line up with the other holders on either side. Note there is a top and a bottom in the element holder so be sure to get the orientation correct.
- 6) Retighten the clamps on the wrap. Alternately tighten the bottom and top clamp so that you don't cock the stainless casing.

TROUBLESHOOTING AND FIXING BRICK PROBLEMS

BRICK PROBLEMS

EXCESSIVE BRICK WEAR

1) Excessive brick wear can be the result of various conditions. Most common is improper curing of the brick when first fired. **FOLLOW THE INSTRUCTIONS FOR THE FIRST FIRING AND CURING CYCLE in the OPERATION Section of the instruction manual).**

2) All insulating firebrick expands and contracts when heated and cooled. Over time this will lead to cracking and spalling. Spalling is the continued cracking of the brick which eventually results in large pieces of the brick falling out from the brick section. This is a normal condition as long as the emphasis is on eventually. Factors such as how close the kiln is operated at or near maximum temperature, how often and how fast the kiln is cycled up to heat and then cooled, how heavy the loads are, all figure into the brick wear equation. There is no set rule as to how long a brick lining will last. There are some L&L kilns which are 25 to 40 years old with the original lining still in usable shape.

3) Frequent door openings when the kiln is at high temperatures can cause thermal shock, leading to excessive cracking and spalling.

INSTRUCTIONS FOR USING BRICK REPAIR KIT

To order see: hotkilns.com/brick-repair-kit

GENERAL NOTE: Firebrick is a very fragile material and subject to breakage, spalling and heat shock. The good news is that it is very easy to repair and maintain with the proper materials and techniques. Our Brick Repair Kit has all the materials you will need to do a first class job.

LIST OF BRICK REPAIR KIT MATERIALS

- (1) 3" X 4.5" x 9" K23 Firebrick piece
- (1) 1/2 pint of Brick Cement (in a 1/2 pint container)
- (1) One Quart container of Brick Dust

MIXING A BATCH OF GROUT

The grout should be mixed up JUST prior to use. (Otherwise it will dry out). Mix the ingredients with a small spatula in a container (like a glass jar or plastic cup). Mix in the following:

- 1/2 cup firebrick dust
- 1/4 cup water
- 1 tablespoon Brick Cement

NOTE ABOUT GROUT

The special grout material is firebrick dust mixed with water and a small amount of cement. The cement makes a matrix of the firebrick dust. This compound dries into a material almost exactly like the original firebrick with the same color, consistency, texture and insulating properties.

BRICK REPAIRS

APPLICATION OF BRICK FACING/HARDENER

- 1) Mix water and high temperature cement in a 50/50 mix.
- 2) First brush and vacuum the surface of the brick clean to remove any loose material or crumbling firebrick.
- 3) Next wet the brick surface lightly. Use a paint brush or spray bottle (make sure there is no soap residue in the bottle).
- 4) Then apply a thin coat of this mixture with a soft clean sponge or brush over the surface of the firebrick. Do not make too thick a coat of the hardener or it will spall off. One or two light brushings on wet brick is enough.
- 4) Let the coating dry for 24 hours.
- 5) Run the First Firing Cycle (See the OPERATION Section in your manual).

REPAIRING SMALL HOLES & CHIPS IN BRICK

- 1) Mix water and high temperature cement in a 50/50 mix.
- 2) Brush and vacuum the surface of the brick clean to remove any loose material or crumbling firebrick.
- 3) Next wet the brick surface lightly. Use a paint brush or spray bottle (make sure there is no soap residue in the bottle).
- 4) Apply a very thin coat of brick cement mix (no more than 1/3" to 1/6") all over the hole. Do this with your finger or a small brush.
- 5) Fill hole with the special grout material. Apply grout with a spatula (like plaster.) You can also use your finger. Push it into the hole. It is OK to let it be a rough surface or slightly larger than the hole it is filling.
- 5) Let dry for 24 hours.
- 6) Take some rough sandpaper and sand surface to even it out with the rest of the firebrick.
- 7) Run the First Firing Cycle (See the OPERATION Section in your manual).
- 8) You can brush on hardener or facing afterward if you desire.

TROUBLESHOOTING AND FIXING BRICK PROBLEMS

REPAIRING VERY LARGE HOLES IN BRICK

See this video: [hotkilns.com/repair-brick-front-load](https://www.hotkilns.com/repair-brick-front-load)

- 1) Cut out an area around the brick chip with a small knife, saw or router. The hole that you make should have 90° angles so that a square or rectangular block will fit in the hole.
- 2) Cut a piece of firebrick to fit into this cut out hole. The piece should be slightly smaller than the hole (by about 1/16" to 1/8").
- 3) Both the hole and the brick piece should be brushed and vacuumed clean.
- 4) Wet the brick surface lightly. (Both the hole and the surface of the block that you are going to insert in the hole). Use a paint brush or spray bottle (make sure there is no soap residue in the bottle).
- 5) Apply the High Temp Kiln Cement to the surface of the piece that you are going to put in the hole as well as the hole itself. Use only about 1/32" to 1/16" of an inch of cement. Push the brick plug in hard and move slightly for a second or two to make sure the cement adheres to all surfaces.
- 6) Let dry for 24 hours.
- 7) Sand off excess brick and cement.
- 8) Cover with Brick Facing and allow to dry for another 24 hours.
- 9) Run the First Firing Cycle (See the OPERATION Section in your manual).

FIRST FIRING AFTER REPAIR

(See FIRST FIRING INSTRUCTIONS in the Operation Section). The only difference is that you can fire to a lower temperature because you do not need to reseal the elements. Firing to cone 05 instead of 5 is OK.

The kiln needn't be empty either.

If you have the DYNA-TROL program control fire the following program: Using the "Easy-Fire" mode fire on Slow Bisque to Cone 05 with a PreHeat setting of 3 hours and a hold of 1 hour.

For kilns with the manual control fire the kiln on low (setting #2) for two hours to bake out any moisture. Then set to medium (setting #5) for two hours and then increase enough to reach final temperature. Fire it to cone 05 (1888°F).

CRACKS IN THE LID & BOTTOM

See these videos for bad cracks:

[hotkilns.com/fix-cracks-front-load](https://www.hotkilns.com/fix-cracks-front-load)
and [hotkilns.com/repair-cracked-top](https://www.hotkilns.com/repair-cracked-top)

See this video for hairline cracks:

[hotkilns.com/repair-hairline-cracks](https://www.hotkilns.com/repair-hairline-cracks)

- 1) It is quite normal to get hairline cracks in both the lid and the bottom firebricks.
- 2) They are caused by the expansion and contraction of the firebrick as it heats and cools.
- 3) As long as the bottom is fully supported by the stand the cracks in the bottom will not adversely affect the operation of the kiln.
- 4) The stainless steel clips we use in our lids also help keep these natural cracks from normally becoming a problem in the lids.
- 5) Note that it is possible to put another bottom under the original bottom as a second layer (this can also improve performance and heat up rate of the kiln).
- 8) You can tighten the stainless steel band.

This crack is OK:



TIGHTENING STAINLESS BANDS

See these videos:

[hotkilns.com/replace-side-brick-kiln](https://www.hotkilns.com/replace-side-brick-kiln)

[hotkilns.com/replace-side-brick-davinci](https://www.hotkilns.com/replace-side-brick-davinci)

- 1) The brick will shrink slightly over time. This is more pronounced when using the kiln at higher temperatures like cone 10. If you only use the kiln for low fire bisque you may never notice this condition.
- 2) If the bricks shrink too much they will become loose.

TROUBLESHOOTING AND FIXING BRICK PROBLEMS

3) Tighten the case by turning the screws of the case clamps. Do this 1/4 of a turn at a time on each of the clamps. Keep a balanced tightening (i.e don't tighten one clamp too much at one time). Slow is good.

Tightening the bands:



4) You can do this on the bands around the top and bottom also. This will help maintain the integrity of those slabs even if there is a crack.

REPLACING FIREBRICK IN SIDES

See these videos:

hotkilns.com/replace-side-brick-kiln

hotkilns.com/replace-side-brick-davinci

1) If you need to replace a firebrick piece in one of the sections do the following. While it does not require a great deal of experience to accomplish it does take time and patience.

2) Order the firebrick precut and prerouted from L&L Kiln. You can order this with the proper element holders already in place or you can reuse the holders from your old brick. Be sure to order it for your specific model kiln. Also, be sure to say whether it is a brick where the element connections come through (because this has different element holders).

3) There are no holes drilled in the brick for either peepholes or element connections. This has to be done in the field.

4) Take the section off the kiln and put it on a flat surface like a flat floor or table. Elements will have to be removed and probably replaced. If the elements are old they will be brittle. They may break so be prepared to get new elements.

5) Loosen up the adjustable clamps that hold the stainless steel wrapping. Loosen them just enough to allow the brick to slide out with slight hand pressure (so that the other bricks stay in place). NOTE: If you don't have the section on a flat surface then the bricks will all come out of proper alignment at this point.

6) Slide the bad brick(s) up and out and put in new brick(s). Be sure the element holders line up with the other holders on either side. Note there is a top and a bottom in the element holder so be sure to get the orientation correct.

7) Retighten the clamps on the wrap. Alternately tighten the two or three clamps (about a 1/4 or 1/2 turn at a time) so that you don't cock the stainless casing.

8) Sand off the top surface of the firebrick to match the surface of the other firebricks. Sandpaper will work fine. Reface with Brick Facing.

9) You can see this action in this video:
hotkilns.com/replace-side-brick-kiln

DRILLING HOLES FOR PEEPHOLES

1) Some of the bricks that you may need to replace will need to have holes drilled in them in the field. These holes can not be drilled in the factory because the alignment would not be perfect.

2) To drill out for peepholes use a 1" diameter drill bit or hole saw. You can also drill with a smaller drill and then file out with a round hasp type file. Drill slowly through the firebrick using the prepunched hole in the stainless steel. You may have to remove the bit several times and clean it out as you drill deeper. **It is a good idea to have someone help you by watching from the side to make sure you are drilling straight. It is hard to see this when you are doing the drilling.**

3) For sections that have two element rows: the hole is drilled perpendicular to the stainless case.

4) For sections that have three element rows: the hole is not drilled at a perfect 90° perpendicular angle to the kiln case. It will be drilled at a slightly down angle (about 5° to 7°). This is to miss the element holders.

5) Before drilling, as a precaution, you can measure down from the top of the brick to the top of the existing hole in the stainless steel case. This measurement on the inside will show you where the top of the drill bit will protrude. Adjust your angle of drilling accordingly.

Drilling the peephole:



TROUBLESHOOTING AND FIXING BRICK PROBLEMS

DRILLING ELEMENT CONNECTIONS

- 1) Use a 1/8" to 3/16" diameter drill bit and drill out from the center of the hole in the stainless steel case. Do this slowly with a speed control.
- 2) Do this perpendicular to the case.

REPLACING BOTTOMS

- 1) Remove the kiln sections.
- 2) Take the old bottom off the stand.
- 3) Put the new bottom on the stand.
- 4) Relevel the kiln. (This is important).
- 5) Replace the kiln sections.

NOTE: You may want to experiment with using the old bottom as a secondary back up bottom if it is not too badly damaged. Just make sure it is totally flat so that it doesn't crack the new bottom. Some people find that having this extra insulation thickness helps firing times and bottom uniformity.

REPLACING EASY-LIFT LIDS

- 1) Remove the Hinge Pin and take the old top off the kiln. See the Assembly Instructions for guidance if you have questions about how to do this. Use the Hinge Tool to take the tension off the spring. **BE SURE TO USE SAFETY GLASSES - THERE IS A LOT OF TENSION ON THE SPRING AND INJURY COULD RESULT.**
- 2) Remove the Top Hinge Part from the old lid. Note that there are three parts to this. There is the main Top Hinge Part. Then there is the Front Hinge Part (the little 3" x 4" aluminized steel plate with a small hole that gets attached to the front of the top with the screws for the Handle). Then there is the Handle. Note that the hole in the Front Hinge Part should be centered around the little stud that protrudes from the Top Hinge Part.
- 3) Using the old top as a guide, install the Top Hinge Part onto the new lid.
- 4) Reinstall the top and reset the spring. See the Assembly Instructions if you have questions about how to do this.
- 5) See this video: hotkilns.com/replace-easy-fire-lid

REPLACING SMALL NON-SPRING HINGE LIDS

- 1) Remove one of the Cotter pins from the Hinge Bar.
- 2) Pull out the Hinge Bar.
- 3) Unscrew the chains from the stainless steel case of the lid.
- 4) Remove the Top Hinge Part from the old lid.

A simple hinge with parts marked

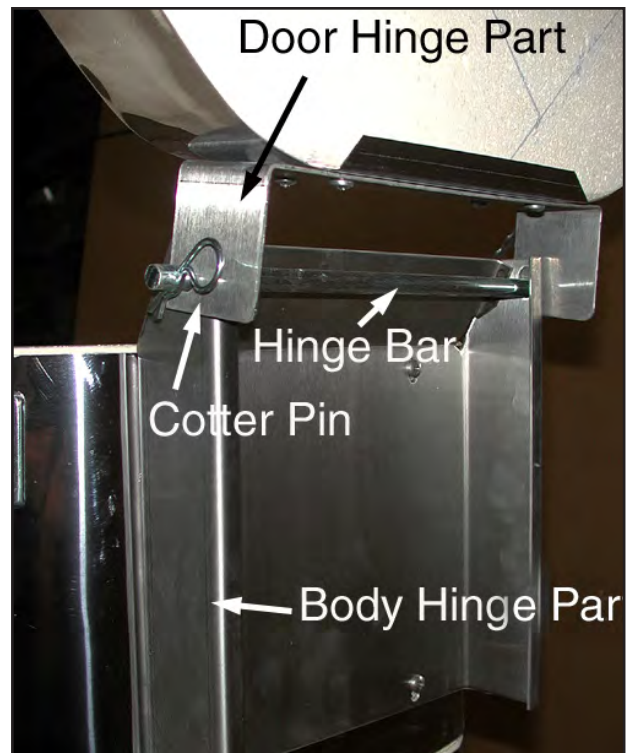

- 5) Using the old top as a guide, install the Top Hinge Part onto the new lid.
- 4) Reinstall the top.

REPLACING DAVINCI LIDS

See this video: hotkilns.com/replace-davinci-lid

DAVINCI INSTRUCTION MANUAL

SERVICE
& WARRANTY



SERVICE FOR L&L KILNS

IN GENERAL

SERVICE FOR YOUR KILN

L&L kilns are designed to be as easy to work on and fix as possible. This is one of the great advantages of L&L kilns.

TROUBLESHOOTING GUIDE

Check out the "Support" section of our web site, hotkilns.com for all of our troubleshooting references. We are constantly adding to our troubleshooting guides and the web site has the most up-to-date information on it. Also try the search engine on our website with your question.

THE MOST COMMON ERROR MESSAGES AND WHAT TO DO ABOUT THEM

Error 1, Err1: hotkilns.com/e1

Error D, ErrD: hotkilns.com/e-d

All Error messages on the DynaTrol:
hotkilns.com/error-codes

Adjusting and Calibrating the DynaTrol for More Accurate Firing: hotkilns.com/calibrating-kiln

What to do if the kiln fires slowly?: hotkilns.com/slow-kiln

YOUR LOCAL RESELLER

Call your local reseller, most of whom service the kilns they sell. If they don't they may be able to direct you to a local kiln service person.

OTHER KILN REPAIR PEOPLE

Search for a local kiln service person online or try your local yellow pages. L&L may also be able to recommend a local service person. We maintain a listing of kiln service people around the country. If you can't find a person experienced specifically in kiln repair, then a good electrician is often more than adequate to repair most problems that commonly occur.

REMOVABLE CONTROL PANELS

Some of the more difficult problems occur within the control panel. One of the unique features of most L&L kilns is the easy ability to remove this panel and send it back to the factory for inspection and/or repair. Call the factory for details on your kiln.

CUSTOMIZED TECHNICAL SUPPORT

To get technical support from L&L Kilns please send an email to service@hotkilns.com

Include in your email the following important information:

1. Your name.
2. Your organization name.
3. The Serial Number, Model Number and Voltage information from your Data Nameplate.
4. Your phone number and possible times to reach you during business hours.
5. A description of the problem you are having and anything you have done so far to troubleshoot it.
6. **Send Photos!**

You will get prompt, effective, and detailed expert answers. We are committed to answering service emails within one business day but normally they are answered far more quickly. If you need a phone call we can help you better if we have this information before we call.

Note about element resistance values: You can find the proper ohms for your elements on the wiring diagram which comes with your instruction manual.

PREPARING FOR A TECHNICAL SUPPORT PHONE CALL

Get Your Wiring Diagram

Be sure to get your wiring diagram if you don't have it. You can get this emailed free from our office if you know your model number, serial number and voltage. This is the key to understanding what is happening electrically and it makes a great visual reference to share with the tech support department over the phone.

Get A Multimeter

Get a "Digital Multimeter". Digital Multi-meters are inexpensive. For around \$50 or less you can get one at a place like Amazon or Home Depot. Get one that can test at least 250 volts AC and 28 volts DC, also ohms from 0 to 200, and is able to show at least the tenths decimal place for accuracy.

If You Need An Electrician

Sometimes you may need get an electrician or experienced person, to test live electricity if you cannot. If you get someone to provide on-site service, the kiln must be hot and exhibiting its problem when they test it. Sometimes it is difficult to coordinate the electrician, a hot kiln, and our

SERVICE FOR L&L KILNS

technical support on the phone all at the same time, but it can be necessary to make the most of the electrician's time, and to fix the kiln in a timely fashion. It is usually best also to discuss with our technical support department the date and approximate time an electrician is expected to arrive.

Be Aware Of Limitations

As a practical matter the technical support staff is limited by the fact that we are at a distance from your kiln, communicating by email or telephone and are often working with you through multiple sessions to fix your kiln's problem. We rely heavily on your accurate and complete description of the problem, and your responses to our questions. We rely on you to remember where we are in the process of fixing your kiln each time we talk. (Email is easier because there is a recorded thread of communication).

Application Support

Resellers often offer a degree of application support. For instance if you are having problems with firing your work the first place to go for answers is the people who supply your clay and glazes. We offer some application support on this web site but it is minimal. Generally, this is outside the scope of our service. Look at the External Links for many great sites that can help you.

Be Comprehensive And Proactive

We have found through long experience that is best when trouble starts to replace all of a certain part. If your elements are old and one burns out – change the whole set of elements. The same is true for thermocouples, thermocouple wires, element terminal screws, power cords, and contactors. Do not expect control panel components to reliably perform after 15 or 20 years. The heat of kilns causes unavoidable oxidation of electrical components - some that you can't see. Kilns need to be rebuilt occasionally. Changing JUST the part that is causing the immediate problem is just asking for more trouble in short order.

WHERE TO BUY PARTS

You can order parts through your local reseller or directly from the factory. L&L stocks almost all parts we sell including elements. We normally ship within one to three days although some parts do take longer. Most parts are listed at hotkilns.com/parts.

FREE LIFETIME SUPPORT IS CONTINGENT ON THE USE OF L&L FACTORY PARTS. USE OF NON-L&L PARTS WILL VOID THE WARRANTY.

WHAT WE CAN'T DO

We can not give you advice over the phone on hooking up your kiln to your electrical system. You must have a qualified electrician who can physically see what your specific electrical situation is and who understands any local codes.

SELECTING AN ELECTRICAL CONTRACTOR

A quality electrical contractor:

1. Complies with state and local codes and regulations.
2. Carries the proper business and workers compensation insurance.
3. Is knowledgeable on a wide range of new equipment, technology and design procedures.
4. Has a local facility, and is willing to have you visit.
5. Is prompt and courteous and provides fast, reliable service -- attempting to perform service at your convenience.
6. Is neat and well groomed. This neatness should be reflected in their vehicles and offices as well as their personal appearance.
7. Provides a detailed written proposal, clearly outlining the work to be done and the agreed upon cost, including labor and materials. Make sure you understand every word of any contract before you sign it.
8. Asks in detail about any problems and offers understandable solutions.

CONSIDER THE FOLLOWING

1. Ask for references. Find out if other customers were satisfied. Check with the local Better Business Bureau regarding any filed complaints.
2. Compare price. Get bids from a few contractors. Make sure you give each contractor the same specifications and materials needed for the job.
3. Remember! How a company treats you now reflects how they will treat you if there's a problem. A quality electrical contractor listens to your problems, understands what you want accomplished and is willing to follow up after the work is completed.

STANDARD LIMITED THREE YEAR WARRANTY FOR L&L KILNS

THREE YEAR LIMITED KILN WARRANTY

L&L Kilns are warranted to be free of defects in workmanship for a period of three (3) years, starting on the date of original purchase from L&L Kiln Mfg., Inc. (L&L) or from an authorized L&L reseller, subject to the following terms and conditions, including but not limited to, the exclusions and limitations set forth herein.

1. A sales receipt may be required for proof of purchase.
2. In addition, L&L may require you to deliver defective parts to L&L for examination to determine the applicability of these warranty provisions. *Do not discard parts before contacting L&L for instructions. Failure to adhere to L&L's instructions, including those contained in the instruction manual and as stated herein, will void this warranty.*
3. L&L will replace or repair any defective part that is covered by this warranty and sent freight-prepaid to L&L. L&L will prepay return shipping cost without charge in the Continental United States. Shipping outside the Continental United States is at cost.
4. On-site labor is not part of this warranty and is not covered by L&L. Any warranty labor provided by resellers is provided at their own discretion and expense.
5. Warranty is not valid for second-hand or damaged kilns that are sold by unauthorized sellers.
6. Any modifications to the original kiln by anyone other than the factory or someone specifically authorized in writing by the factory will void the warranty. Any modification is made solely at the risk of the customer. L&L takes no responsibility for hazardous conditions created by unauthorized modifications.

APPLICATION

Applies to Easy-Fire, Jupiter, Davinci, Doll/Test, JH Series, Quad-Pro kilns, eFL Series and Fuego kilns when used for ceramics and glass.

EXCLUSIONS AND LIMITATIONS

The following are examples of items that are not covered by and/or circumstances that will void L&L's warranties:

1. **Use of elements and/or other parts other than genuine L&L Kiln parts.**

Kiln warranty may be voided by firing materials that introduce harmful atmospheres into the kiln. Atmospheres

containing carbon, reducing atmospheres (caused, for example, by introducing carbonaceous gasses or solids like graphite or paper into the kiln), binders from lusters and decals, wax burn out effluents, fluorines, halogens, acids, metal oxides, and salts are some of the corrosive and harmful atmospheres that will damage a kiln. Most ceramic processes will release some of these harmful constituents into the kiln and venting will prevent most of the problems that those processes would cause. Also, depending on the concentration of the harmful gasses, kiln source ventilation (such as our Vent-Sure) may limit the damage to the kiln. It is the customer's sole responsibility to ensure that the materials and the processes used are not harmful. This is of particular importance for industrial uses where processes may be unusual.

2. Over-firing damage for any reason and regardless of cause. **IMPORTANT: We specifically warn you not to fire the kiln unattended. Neither the DynaTrol, Genesis, One-Touch control, nor any other electronic control used by L&L is designed to be a failproof shut off device. L&L is not responsible for damage caused by failure of any of these controls.**
3. Controls made by Orton, Future Controls, Eurotherm, Honeywell or other manufactures are warranted by their manufacturers. L&L is not responsible for damage caused by failure of one of these controls.
4. Also note that it is easy to melt clay if you inadvertently fire it hotter than its rating. It is possible in some controls to limit the upper firing limit of the kiln to avoid accidental overfirings of this type. Contact factory or read your control instruction manual if you would like further information on this.
5. Firebrick by its nature is fragile and will chip, crack, and create dust. L&L designs its kilns to minimize the effects of this but can not warrant against cracking, breakage, spalling or dusting. There is specifically no warranty for cracked arches, tops, lids or bottoms.
6. Corrosion of the case is specifically not warranted. Corrosion is typically due to use of a kiln in an unheated outside shed (where morning dew condenses on the kiln and humidity attacks the kiln) or from an unvented kiln (where the water vapor and fumes generated by firing ceramic materials attack the kiln case). However, even a vented kiln can corrode due to all the environmental and process conditions that a kiln can be exposed to. Exposure to other ambient conditions, including but not limited to humidity, rain, snow, dust, and salt air will also cause corrosion.
7. Damage due to neglect, inadequate room or kiln ventilation, mechanical abuse, improper storage,

STANDARD LIMITED THREE YEAR WARRANTY FOR L&L KILNS

inadequate maintenance, improper use or freight damage.

8. Damage to the elements or element holders due to failure to properly keep the kiln clean (i.e. allowing glaze or ceramic chards from exploding pots) to make contact with the element holders.
9. Damage to the kiln caused for firing in ambient conditions that are too hot for the control or other components in the kiln. The DynaTrol or Genesis is rated for use up to 125°F (52°C). That means that the room that you fire in should be less than 100°F (38°C) (because the control will be slightly hotter than room air due to transferred heat from the kiln). Note that direct sunlight on the control face may raise the temperature of the board beyond what you would expect from the ambient temperature or the kiln heat. Also note that the DynaTrol specifically allows the operator to check the control board temperature.
10. Failure to report defect within fifteen (15) days after it becomes manifest or known.
11. Any alteration of parts or design that vary from factory designs.
12. Thermocouple Protection Tubes are not warranted against breakage.
13. L&L's warranty is strictly limited to repair or replacement of defective items. Kilns may not be returned.
14. Resellers are not authorized by L&L to modify and/or assume any other obligations or liabilities other than those expressed in this limited warranty and any such additional obligations are null and void.
15. EXCEPT AS SPECIFICALLY WARRANTED HEREIN, KILNS ARE SOLD AS IS. L&L MAKES NO OTHER WARRANTY, EXPRESS OR IMPLIED, COVERING THE GOODS AND SPECIFICALLY DISCLAIMS ALL IMPLIED WARRANTIES OF MERCHANTABILITY OR FITNESS FOR A PARTICULAR PURPOSE. Purchaser acknowledges that certain conditions or circumstances may be created or incurred by Purchaser or user or over which L&L has no control, including, but not limited to, climactic conditions, improper use, inadequate maintenance, and Purchaser, as a condition of purchase or use, assumes responsibility for and releases L&L from liability arising out of the use of the kilns attributable to such causes.
16. L&L SHALL NOT BE LIABLE FOR ANY INCIDENTAL, SECONDARY, OR CONSEQUENTIAL DAMAGES, INCLUDING BUT NOT LIMITED TO BODILY INJURY

OR DEATH, LOST PROFITS, LOSS OF USE, OR OTHER ECONOMIC LOSSES. Purchaser agrees that L&L's total liability for any damages or remedies arising hereunder shall be limited to direct damages, in an amount not exceeding the purchase price actually paid. Replacement or repair or refund, at L&L's sole discretion, of the purchase price of the equipment purchased shall constitute the exclusive and sole remedy available to Purchaser. Any action for breach of contract or negligence must be commenced by Purchaser within 6 months after delivery of the equipment to Purchaser.

17. L&L's full Terms and Conditions of Sale are available at hotkilns.com/terms.

3 YEAR PRO-RATED ELEMENT & THERMOCOUPLE LIMITED WARRANTY

Elements and thermocouples are warranted for three (3) years on a pro-rated basis with the following exceptions:

1. Glaze damage to the elements caused by accidentally scraping edges of unfired glazed ware against element groove. WARNING: causing unfired glaze to contaminate element will damage elements and can lead to element failure, and creates a fire hazard.
2. Firing of kiln to a temperature that exceeds the lower of either the maximum rating of kiln or 2350°F (1290°C).
3. Damage to elements caused by explosion of ceramic object. WARNING: this may cause damage to the elements and can lead to element failure, and creates a fire hazard.
4. **Elements are warranted on a prorated schedule based on the ship date of the kiln.** All dates are based on ship date from factory if sold direct or drop shipped to customer. If sold from a reseller's warehouse the date would be based on when it was shipped and/or sold from the reseller. The warranty is not extended for any period of where operation of the kiln is delayed for shipping, warehousing, or other reasons.
5. Labor to replace elements is not covered.
6. **The pro-rated discount schedule only is valid for elements that you are actually replacing.** In other words you can't buy a whole set of elements at these prices for anticipated future replacement. We reserve the right to ask for replaced elements in return.
7. This replacement schedule is limited to new kilns.

STANDARD LIMITED THREE YEAR WARRANTY FOR L&L KILNS

PRO-RATED SCHEDULE FOR KILNS THAT DO HAVE A VENT-SURE INSTALLED

Date from time of shipment from factory	Price of thermocouples and elements
0-12 Months	No Charge
12-24 Months	25% of full list price
24-36 Months	50% of full list price

PRO-RATED SCHEDULE FOR ALL KILNS THAT DO NOT HAVE A VENT-SURE INSTALLED AND ALL JH SERIES KILNS

JH KILNS

The pro-rated schedule for elements for the JH series kilns varies because of the hard use these kilns get during the crystalline glaze firing process.

KILNS WITHOUT VENTS

In kilns used without an automatic Vent-Sure, the elements will corrode a lot quicker than normally and fail more quickly and this pro-rated schedule takes this into account. NOTE: The vent on the kiln must be an L&L Vent-Sure downdraft vent or this exclusion will apply even with a vent made by other companies.

Date from time of shipment from factory	Price of thermocouples and elements
0-6 Months	No Charge
6-12 Months	25% of full list price
12-24 Months	50% of full list price

3 YEAR LIMITED VENT WARRANTY

L&L VS-1 Vent-Sure is warranted to be free of defects in workmanship for a period of (3) years, starting from date of original purchase from L&L Kiln Mfg., Inc. or from an authorized L&L reseller. Corrosion of motor and parts is not covered. A sales receipt is required for proof of purchase. In addition, L&L may require you to send in defective parts for examination to determine the applicability of these warranty provisions. DO NOT DISCARD PARTS BEFORE CONTACTING L&L. L&L Kiln Mfg., Inc. will replace or repair any defective part sent freight-prepaid to L&L Kiln Mfg., Inc. following L&L's written acknowledgement and authorization regarding the specific issue. L&L Kiln Mfg., Inc. will prepay return shipping cost without charge in the Continental United States. On site labor is not covered by the factory; however, local resellers or dealers may offer this service.

EXCLUSIONS & LIMITATIONS

1. The Vent-Sure must be used as instructed in our vent instructions.
2. The use of any wax process that might cause condensation of wax or other similar substance in the vent system will void the warranty.
3. The Vent-Sure is not warranted to vent highly corrosive fumes, and any such use will void any warranties otherwise provided.

PARTS WARRANTY

1. L&L does not warrant replacement elements and thermocouples except for catastrophic failure (for instance, a situation where the element end broke off without fault of the operator).
2. Parts (aside from elements and thermocouples) are warranted for ninety (90) days from time of shipment. Complete control panels are warranted for one (1) year from time of shipment. Warranty is for replacement or repair only and does not include labor.

DAVINCI INSTRUCTION MANUAL

PARTS



PARTS FOR ALL KILNS (ONLINE DATABASE)

PARTS LIST

A comprehensive and up-to-date listing of parts that pertain to all Kiln Series' built by L&L Kiln Mfg., Inc. can be found on our website at: hotkilns.com/parts

DATA NAMEPLATE

Have the Nameplate Information

You can get Model Number, Serial Number and voltage information about your kiln from the Data Nameplate affixed to your kiln. You will typically find this on the control panel. Please have this available when ordering parts. It helps us make sure you are getting the proper parts!

This is a Data Nameplate that you will find on your kiln. Obtain the Serial Number, Model Number, Voltage, Phase, Amps and Watts from this nameplate.



If you cannot find the data nameplate

If the nameplate has come off your kiln we can help you determine the model number by the number of ring sections and the diameter of the rings. You will need to know your voltage by checking your line voltage with a voltmeter. Most household voltage in the United States is 240 volts single phase. Industrial, commercial and institutional locations often have 208 volts and may be either three phase or single phase. THIS NEEDS TO BE KNOWN! Check with an electrician if you aren't sure.

HOW TO ORDER PARTS

Delivery Times for Parts

We ship most parts such as elements, kiln shelves and posts, switches and other electrical items, and ceramic parts usually very quick. See each part number on the website for specific lead times.

How to Place an Order

You can place an order by phone or by using the handy order form in the back of this parts list. This order form can be faxed to 856.294.0070. Be sure to include your Visa or Mastercard number and expiration date, three digit verification code, your name, phone number and correct shipping address. For more information see: hotkilns.com/ordering-parts

Payment

Most customers pay by Visa, Mastercard or American Express. For more information see: hotkilns.com/payment

Shipment

Most parts ship by UPS. Unless you specify we choose the carrier based on the cheapest price. You can specify overnight or second day shipment or Saturday delivery. Kiln sections and tops and bottoms must ship by motor freight. for more information see: hotkilns.com/shipping-policy

Packing Charges

For packing and crating charges see: hotkilns.com/shipping-policy. UPS, USPS or FedEx shipping charges are billed at cost.

Returning Parts

Some parts are returnable; some are custom and cannot be returned. The policy for each part is listed on the page for that part. For the general policy see: hotkilns.com/return-parts

Sales Tax

For where we collect sales tax and for sales tax exemption policies see: hotkilns.com/sales-tax

FAX ORDER FORM FOR L&L KILNS AND PARTS

Fax to 856.294.0070

ORDERED BY:

Date: _____
Company _____
Name _____
Street Address _____
City _____
State _____ Zip/Postal Code _____
Day Phone _____
Fax: _____
Email: _____

SHIP TO: (if different from "ORDERED BY")

Company _____
Name _____
Street Address _____
City _____
State _____ Zip/Postal Code _____
Day Phone _____
Fax: _____
Email: _____

QTY	ITEM NO.	VOLTS	DESCRIPTION	AMOUNT	TOTAL

PAYMENT METHOD: Purchase Order: _____
Purchase Orders must have preapproved credit with L&L.

Visa Mastercard AmerExp Discovery

CHARGE TO:
Card Account Number _____
Name on Card _____
Issuing Bank _____
CSV (3 Digit V-Code on back of Card) _____
Expiration Date _____
Customer Signature _____

Merchandise Total:		
6% sales tax for shipments to PA or NJ: (unless accompanied by a sales tax exempt form):		
Standard Packing & Handling Charge (See below. To be filled in by L&L)		
UPS, Fed X or Common Carrier Charges. (To be filled in at time of shipment. Based on Actual Cost.)		
TOTAL:		

To be filled out by L&L

PLEASE PROVIDE THIS TECHNICAL INFORMATION

MODEL# _____

SERIAL# _____

VOLTS: _____ PHASE: _____

DAVINCI INSTRUCTION MANUAL

SAFETY DATA
SHEETS



L&L KILN COMPONENTS MATERIAL SAFETY DATA SHEETS

TABLE OF CONTENTS

REFRACTORY BRICK

REFRACTORY MORTAR

ALKALINE EARTH SILICATE (AES) WOOL PRODUCT

REFRACTORY CERAMIC FIBER PRODUCT

MATERIAL SAFETY DATA SHEETS

DOWNLOAD PDF

Scan QR or visit:

hotkilns.com/support/pdfs/full-safety-data-sheets-davinci-kilns



DAVINCI INSTRUCTION MANUAL



TB2318

Temperature Rating: Cone 10

Volume: 9.6 Cubic Feet

Brick Thickness: 3" Brick

Inside: 34.75" D x 18" H

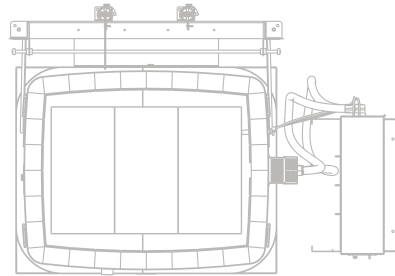

34.75" W
x 26.5" D x
18" H

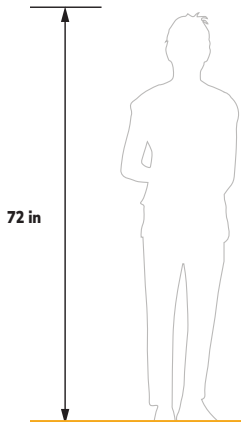

72 in



33.6 in



Large volume square and rectangular kilns with adjustable height. DaVinci kilns are great for production and tiles. Includes arched sides for strength and counterbalanced lid.

- **Genesis Touch Screen Control** with Dynamic Zone Control
- **Cone 10 • 2350°F • 1290°C**
- **Counterbalanced Lid** with springs inside of tubes
- **Safety Latches for Lid**
- **Welded angle-iron powder-coated stand and hinge**
- **3" brick**
- **Type K Thermocouples (2)**
 - with protection tubes
- **Strong arched sides** with extra

space added to interior dimensions for good air circulation

- **Three elements per 9" section**
- **Ceramic Element Terminals**
- **Hard Ceramic Element Channels**
- **Plug in kiln sections** (except 480 volt models)
- **Floor mounted control panel**
- **c-MET-us listed to UL499 Standards**
- **See hotkilns.com/tb2318 for all features and options**

GENERAL DIMENSIONS

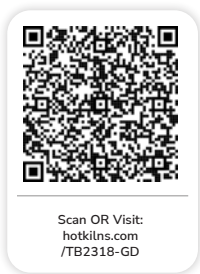

TRUST YOUR KILN
hotkilns.com

Manufactured in Swedesboro, NJ
800-750-8350 • sales@hotkilns.com

Bulletin No: BL-TB2318 REV: 0

Page 1



USA

Standard Models							Powered Bottom Models				
Model Number	Part Number	Volt/Phase	Watts	Amps	Wire Size	Fuse Size	Part Number	Watts	Amps	Wire Size	Fuse Size
TB2318-D-240	K-T-2318/31	240/1P	15,340	63.9	3 ga	80	K-T-231P/31	20,453	85.2	1 ga	110
TB2318-D-240-3P	K-T-2318/32	240/3P	15,340	55.4	4 ga	70	K-T-231P/32	20,453	55.4	4 ga	70
TB2318-D-208	K-T-2318/21	208/1P	15,340	73.8	1 ga	100	K-T-231P/21	20,453	98.3	1/0	125
TB2318-D-208-3P	K-T-2318/22	208/3P	15,340	63.9	3 ga	80	K-T-231P/22	20,453	63.9	3 ga	80
TB2318-D-480-3P	K-T-2318/62	480/3P	15,340	18.5	12 ga	25	K-T-231P/62	20,453	27.7	8 ga	40

WORLD

TB2318-D-220	K-T-2318/41	220/1P	15,340	69.7	2 ga	90	K-T-231W/41	20,453	93.0	1/0	125
TB2318-D-380-3PY	K-T-2318/52	380/3PY	15,340	34.9	6 ga	50	K-T-231W/52	20,453	34.9	6 ga	50
TB2318-D-400-3PY	K-T-2318/82	400/3PY	15,340	33.3	6 ga	50	K-T-231W/82	20,453	33.4	6 ga	50
TB2318-D-415-3P4	K-T-2318/72	415/3PY	15,340	32.0	8 ga	40	K-T-231W/72	20,453	32.0	8 ga	40



Control: Full digital touchscreen Genesis control with easy-to-use interface, WiFi enabled app, and simple programs for firing ceramics or glass.

For Model Number of Powered Bottom Model: Add a “PB” after the “D” (Example = T2327-D-PB-240-1).

UL Listing: c-MET-us listed.

Control Panels: Floor standing panel. NEMA 1 panel are recommended but not required for 480 volts.

480 Volt Models with Quad Element Option: See website kiln pages for electrical specifications.

Crating: Comes fully crated. Easily disassembles for installation.



FURNITURE KIT FOR TB2318

Part Number: H-T-K418/00

Includes: Six 22” x 11” x 3/4” rectangular shelves (3/4” thick), six each 1/2”, 1”, 2”, 4”, 6”, and 8” square posts, and one pair heat resistant. Gloves.

T2327

Temperature Rating: Cone 10

Volume: 14.4 Cubic Feet

Brick Thickness: 3" Brick

Inside: 34.75" D x 27" H

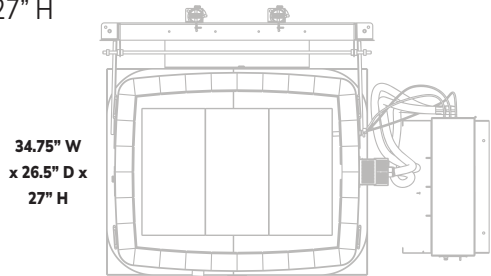

34.75" W
x 26.5" D x
27" H



Large volume square and rectangular kilns with adjustable height . DaVinci kilns are great for production and tiles. Includes arched sides for strength and counterbalanced lid.

- **Genesis Touch Screen Control** with Dynamic Zone Control
- **Cone 10 • 2350°F • 1290°C**
- **Counterbalanced Lid** with springs inside of tubes
- **Safety Latches for Lid**
- **Welded angle-iron powder-coated stand and hinge**
- **3" brick**
- **Type K Thermocouples (3)**
 - with protection tubes
- **Strong arched sides** with extra space added to interior dimensions for good air circulation
- **Three elements per 9" section**
- **Ceramic Element Terminals**
- **Hard Ceramic Element Channels**
- **Plug in kiln sections** (except 480 volt models)
- **Floor mounted control panel**
- **c-MET-us listed to UL499 Standards**
- **See hotkilns.com/t2327 for all features and options**

GENERAL DIMENSIONS

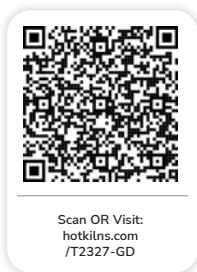

TRUST YOUR KILN
hotkilns.com

Manufactured in Swedesboro, NJ
800-750-8350 • sales@hotkilns.com

Bulletin No: BL-T2327 REV: 0

Page 1



Electrical Specifications for T2327

DaVinci Top-Loading Kilns

USA

Standard Models							Powered Bottom Models				
Model Number	Part Number	Volt/Phase	Watts	Amps	Wire Size	Fuse Size	Part Number	Watts	Amps	Wire Size	Fuse Size
T2327-D-240	K-T-2327/31	240/1P	19,510	81.3	1 ga	110	K-T-232P/31	23,844	99.4	1/0	125
T2327-D-240-3P	K-T-2327/32	240/3P	19,510	46.9	6 ga	60	K-T-232P/32	23,844	63.2	3 ga	80
T2327-D-208	K-T-2327/21	208/1P	19,510	93.8	1/0	125	K-T-232P/21	23,844	114.6	3/0	150
T2327-D-208-3P	K-T-2327/22	208/3P	19,510	54.2	4 ga	70	K-T-232P/22	23,844	72.9	1 ga	100
T2327-D-480-3P	K-T-2327/62	480/3P	19,510	23.5	10 ga	30	K-T-232P/62	23,844	31.3	8 ga	40
TB2327-D-240	K-T-232B/31	240/1P	23,010	95.9	1/0	125	K-T-232W/31	28,123	117.2	3/0	150
TB2327-D-240-3P	K-T-232B/32	240/3P	23,010	55.4	4 ga	70	K-T-232W/32	28,123	74.6	1 ga	100
TB2327-D-208	K-T-232B/21	208/1P	23,010	110.6	3/0	150	K-T-232W/21	28,123	135.2	4/0	175
TB2327-D-208-3P	K-T-232B/22	208/3P	23,010	63.9	3 ga	80	K-T-232W/22	28,123	86.0	1 ga	110
TB2327-D-480-3P	K-T-232B/62	480/3P	23,010	27.7	8 ga	40	K-T-232W/62	28,123	36.9	6 ga	50

WORLD

T2327-D-220	K-T-2327/41	220/1P	19,510	88.7	1/0	125	K-T-232P/41	23,844	108.4	3/0	150
T2327-D-380-3PY	K-T-2327/52	380/3PY	19,510	29.6	8 ga	40	K-T-232P/52	23,844	49.3	4 ga	70
T2327-D-400-3PY	K-T-2327/82	400/3PY	19,510	28.3	8 ga	40	K-T-232P/82	23,844	47.1	6 ga	60
T2327-D-415-3PY	K-T-2327/72	415/3PY	19,510	27.1	8 ga	40	K-T-232P/72	23,844	45.1	6 ga	60
TB2327-D-220	K-T-232B/41	220/1P	23,010	104.6	3/0	150	K-T-232W/41	28,123	127.8	4/0	175
TB2327-D-380-3PY	K-T-232B/52	380/3PY	23,010	34.9	6 ga	50	K-T-232W/52	28,123	58.1	3 ga	80
TB2327-D-400-3PY	K-T-232B/82	400/3PY	23,010	33.3	6 ga	50	K-T-232W/82	28,123	55.6	4 ga	70
TB2327-D-415-3PY	K-T-232B/72	415/3PY	23,010	32.0	8 ga	40	K-T-232W/72	28,123	53.3	4 ga	70



Control: Full digital touchscreen Genesis control with easy-to-use interface, WiFi enabled app, and simple programs for firing ceramics or glass.

For Model Number of Powered Bottom

Model: Add a "PB" after the "D" (Example = T2327-D-PB-240-1).

UL Listing: c-MET-us listed.



Control Panels: Floor standing panel. NEMA 1 panel are recommended but not required for 480 volts.

TB MODELS: TB models have more power.

480 Volt Models with Quad Element Option: See website kiln pages for electrical specifications.

Crating: Comes fully crated. Easily disassembles for installation.

FURNITURE KIT FOR T2327

Part Number: H-T-K427/00

Includes: Nine 22" x 11" x 3/4" rectangular shelves (3/4" thick), six each 1/2", 1", 2", 4", 6", and 8" square posts, and one pair heat resistant gloves.

TRUST YOUR KILN
hotkilns.com

Manufactured in Swedesboro, NJ
800-750-8350 • sales@hotkilns.com

Bulletin No: BL-T2327 REV: 0

Page 2



T2336

Temperature Rating: Cone 10

Volume: 19.2 Cubic Feet

Brick Thickness: 3" Brick

Inside: 34.75" D x 36" H

34.75" W
x 26.5" D x
36" H

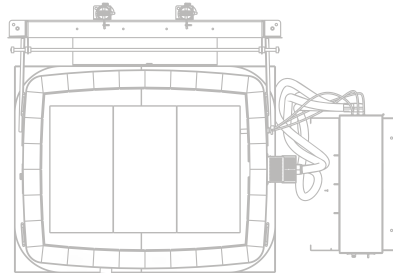

Large volume square and rectangular kilns with adjustable height. DaVinci kilns are great for production and tiles. Includes arched sides for strength and counterbalanced lid.

- **Genesis Touch Screen Control** with Dynamic Zone Control
- **Cone 10 • 2350°F • 1290°C**
- **Counterbalanced Lid** with springs inside of tubes
- **Safety Latches for Lid**
- **Welded angle-iron powder-coated stand and hinge**
- **3" brick**
- **Type K Thermocouples (3)**
 - with protection tubes
- **Strong arched sides** with extra space added to interior dimensions for good air circulation
- **Three elements per 9" section**
- **Ceramic Element Terminals**
- **Hard Ceramic Element Channels**
- **Plug in kiln sections** (except 480 volt models)
- **Floor mounted control panel**
- **c-MET-us listed to UL499 Standards**
- **See hotkilns.com/t2336 for all features and options**

GENERAL DIMENSIONS



TRUST YOUR KILN
hotkilns.com

Manufactured in Swedesboro, NJ
800-750-8350 • sales@hotkilns.com

Bulletin No: BL-T2336 REV: 0

Page 1



Electrical Specifications for T2336

DaVinci Top-Loading Kilns

USA

Standard Models							Powered Bottom Models				
Model Number	Part Number	Volt/Phase	Watts	Amps	Wire Size	Fuse Size	Part Number	Watts	Amps	Wire Size	Fuse Size
T2336-D-240	K-T-2336/31	240/1P	26,013	108.4	3/0	150	K-T-233P/31	30,347	126.4	4/0	175
T2336-D-240-3P	K-T-2336/32	240/1P	26,013	71.7	2 ga	90	K-T-233P/32	30,347	86.2	1 ga	110
T2336-D-208	K-T-2336/21	208/1P	26,013	125.1	4/0	175	K-T-233P/21	30,347	145.9	250 mcm	200
T2336-D-208-3P	K-T-2336/22	208/3P	26,013	82.7	1 ga	110	K-T-233P/22	30,347	99.4	1/0	125
T2336-D-480-3P	K-T-2336/62	480/3P	26,013	31.3	8 ga	40	K-T-233P/62	30,347	39.1	6 ga	50
TB2336-D-240	K-T-233B/31	240/1P	30,680	127.8	4/0	175	K-T-233W/31	35,793	149.1	250 mcm	200
TB2336-D-240-3P	K-T-233B/32	240/1P	30,680	84.6	1 ga	110	K-T-233W/32	35,793	101.6	3/0	150
TB2336-D-208	K-T-233B/21	208/1P	30,680	147.5	250 mcm	200	K-T-233W/21	35,793	172.1	300 mcm	225
TB2336-D-208-3P	K-T-233B/22	208/3P	30,680	97.6	1/0	125	K-T-233W/22	35,793	117.3	3/0	150
TB2336-D-480-3P	K-T-233B/62	480/3P	30,680	36.9	6 ga	50	K-T-233W/62	35,793	46.2	6 ga	60

WORLD

T2336-D-220	K-T-2336/41	220/1P	26,013	118.2	3/0	150	K-T-233P/41	30,347	137.9	4/0	175
T2336-D-380-3PY	K-T-2336/52	380/3PY	26,013	59.1	3 ga	80	K-T-233P/52	30,347	59.1	3 ga	80
T2336-D-400-3PY	K-T-2336/82	400/3PY	26,013	56.6	3 ga	80	K-T-233P/82	30,347	56.6	3 ga	80
T2336-D-415-3PY	K-T-2336/72	415/3PY	26,013	54.2	4 ga	70	K-T-233P/72	30,347	54.2	4 ga	70
TB2336-D-220	K-T-233B/41	220/1P	30,680	139.5	4/0	175	K-T-233W/41	35,793	162.7	300 mcm	225
TB2336-D-380-3PY	K-T-233B/52	380/3PY	30,680	69.7	2 ga	90	K-T-233W/52	35,793	69.7	2 ga	90
TB2336-D-400-3PY	K-T-233B/82	400/3PY	30,680	66.7	2 ga	90	K-T-233W/82	35,793	66.7	2 ga	90
TB2336-D-415-3PY	K-T-233B/72	415/3PY	30,680	63.9	3 ga	80	K-T-233W/72	35,793	63.9	3 ga	80



Control: Full digital touchscreen Genesis control with easy-to-use interface, WiFi enabled app, and simple programs for firing ceramics or glass.

For Model Number of Powered Bottom

Model: Add a "PB" after the "D" (Example = T2327-D-PB-240-1).

UL Listing: c-MET-us listed.



Control Panels: Floor standing panel. NEMA 1 panel are recommended but not required for 480 volts.

TB MODELS: TB models have more power.

480 Volt Models with Quad Element Option: See website kiln pages for electrical specifications.

Crating: Comes fully crated. Easily disassembles for installation.

FURNITURE KIT FOR T2336

Part Number: H-T-K436/00

Includes: Twelve 22" x 11" x 3/4" rectangular shelves (3/4" thick), twelve each 1/2", 1", 2", 4", 6", and 8" square posts, and one pair heat resistant gloves.

TRUST YOUR KILN
hotkilns.com

Manufactured in Swedesboro, NJ
800-750-8350 • sales@hotkilns.com

Bulletin No: BL-T2336 REV: 0

Page 2



T2345

Temperature Rating: Cone 10

Volume: 24.0 Cubic Feet

Brick Thickness: 3" Brick

Inside: 34.75" D x 45" H

34.75" W
x 26.5" D x
45" H

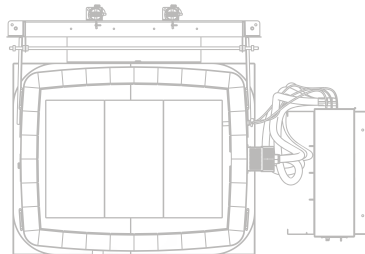

72 in



60.5 in



Large volume square and rectangular kilns with adjustable height. DaVinci kilns are great for production and tiles. Includes arched sides for strength and counterbalanced lid.

- **Genesis Touch Screen Control** with Dynamic Zone Control
- **Cone 10 • 2350°F • 1290°C**
- **Counterbalanced Lid** with springs inside of tubes
- **Safety Latches for Lid**
- **Welded angle-iron powder-coated stand and hinge**
- **3" brick**
- **Type K Thermocouples (3)**
 - with protection tubes
- **Strong arched sides** with extra space added to interior dimensions for good air circulation
- **Three elements per 9" section**
- **Ceramic Element Terminals**
- **Hard Ceramic Element Channels**
- **Plug in kiln sections** (except 480 volt models)
- **Floor mounted control panel**
- **c-MET-us listed to UL499 Standards**
- **See hotkilns.com/t2345 for all features and options**

GENERAL DIMENSIONS

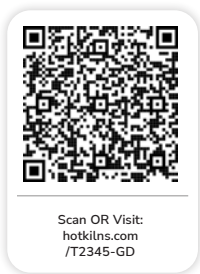

TRUST YOUR KILN
hotkilns.com

Manufactured in Swedesboro, NJ
800-750-8350 • sales@hotkilns.com

Bulletin No: BL-T2345 REV: 0

Page 1



USA

Standard Models							Powered Bottom Models				
Model Number	Part Number	Volt/Phase	Watts	Amps	Wire Size	Fuse Size	Part Number	Watts	Amps	Wire Size	Fuse Size
TB2318-D-240	K-T-2318/31	240/1P	15,340	63.9	3 ga	80	K-T-231P/31	20,453	85.2	1 ga	110
T2345-D-240	K-T-2345/31	240/1P	32,515	135.5	4/0	175	K-T-234P/31	36,850	153.5	250 mcm	200
T2345-D-240-3P	K-T-2345/32	240/3P	32,515	93.9	1/0	125	K-T-234P/32	36,850	93.9	1/0	125
T2345-D-208	K-T-2345/21	208/1P	32,515	156.3	250 mcm	200	K-T-234P/21	36,850	177.2	300 mcm	225
T2345-D-208-3P	K-T-2345/22	208/3P	32,515	108.3	3/0	150	K-T-234P/22	36,850	62.5	3 ga	80
T2345-D-480-3P	K-T-2345/62	480/3P	32,515	39.1	6 ga	50	K-T-234P/62	36,850	47.0	6 ga	60
TB2345-D-240	K-T-234B/31	240/1P	38,350	159.8	250 mcm	200	K-T-234W/31	43,463	181.1	350 mcm	250
TB2345-D-240-3P	K-T-234B/32	240/3P	38,350	110.7	3/0	150	K-T-234W/32	43,463	110.7	3/0	150
TB2345-D-208	K-T-234B/21	208/1P	38,350	184.4	350 mcm	250	K-T-234W/21	43,463	209.0	400 mcm	275
TB2345-D-208-3P	K-T-234B/22	208/3P	38,350	127.7	4/0	175	K-T-234W/22	43,463	127.8	4/0	175
TB2345-D-480-3P	K-T-234B/62	480/3P	38,350	46.1	6 ga	60	K-T-234W/62	43,463	55.4	4 ga	70

WORLD

T2345-D-220	K-T-2345/41	220/1P	32,515	147.8	250 mcm	200	K-T-234P/41	36,850	167.5	300 mcm	225
T2345-D-380-3PY	K-T-2345/52	380/3PY	32,515	34.2	6 ga	50	K-T-234P/52	36,850	59.1	3 ga	80
T2345-D-400-3PY	K-T-2345/82	400/3PY	32,515	32.5	6 ga	50	K-T-234P/82	36,850	56.6	3 ga	80
T2345-D-415-3PY	K-T-2345/72	415/3PY	32,515	31.3	8 ga	40	K-T-234P/72	36,850	54.2	4 ga	70
TB2345-D-220	K-T-234B/41	220/1P	38,350	174.3	300 mcm	225	K-T-234W/41	43,463	197.6	350 mcm	250
TB2345-D-380-3PY	K-T-234B/52	380/3PY	38,350	69.7	2 ga	90	K-T-234W/52	43,463	69.7	2 ga	90
TB2345-D-400-3PY	K-T-234B/82	400/3PY	38,350	66.7	2 ga	90	K-T-234W/82	43,463	66.7	2 ga	90
TB2345-D-415-3PY	K-T-234B/72	415/3PY	38,350	63.9	3 ga	80	K-T-234W/72	43,463	63.9	3 ga	80



Control: Full digital touchscreen Genesis control with easy-to-use interface, WiFi enabled app, and simple programs for firing ceramics or glass.

For Model Number of Powered Bottom Model: Add a "PB" after the "D" (Example = T2327-D-PB-240-1).

UL Listing: c-MET-us listed.



FURNITURE KIT FOR T2345

Part Number: H-T-K425/00

Includes: Fifteen 22" x 11" x 3/4" rectangular shelves (3/4" thick), twelve each 1/2", 1", 2", 4", 6", and 8" square posts, and one pair heat resistant gloves.

Control Panels: Floor standing panel. NEMA 1 panel are recommended but not required for 480 volts.

TB MODELS: TB models have more power.

480 Volt Models with Quad Element Option: See website kiln pages for electrical specifications.

Crating: Comes fully crated. Easily disassembles for installation.

TB3418

Temperature Rating: Cone 10

Volume: 13.8 Cubic Feet

Brick Thickness: 3" Brick

Inside: 43.5" D x 18" H

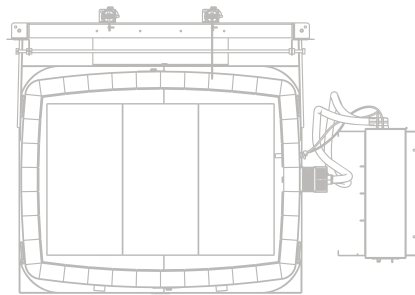

43.5" W x
30.5" D x
18" H

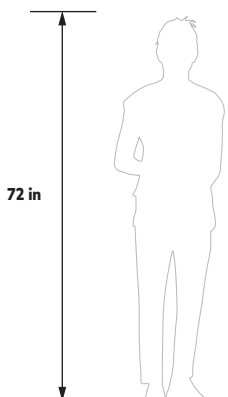

72 in



33.6 in



Large volume square and rectangular kilns with adjustable height. DaVinci kilns are great for production and tiles. Includes arched sides for strength and counterbalanced lid.

- **Genesis Touch Screen Control** with Dynamic Zone Control
- **Cone 10 • 2350°F • 1290°C**
- **Counterbalanced Lid** with springs inside of tubes
- **Safety Latches for Lid**
- **Welded angle-iron powder-coated stand and hinge**
- **3" brick**
- **Type K Thermocouples (2)**
 - with protection tubes
- **Strong arched sides** with extra space

added to interior dimensions for good air circulation

- **Three elements per 9" section**
- **Ceramic Element Terminals**
- **Hard Ceramic Element Channels**
- **Plug in kiln sections** (except 480 volt models)
- **Floor mounted control panel**
- **c-MET-us listed to UL499 Standards**
- **See hotkilns.com/tb3418 for all features and options**

GENERAL DIMENSIONS

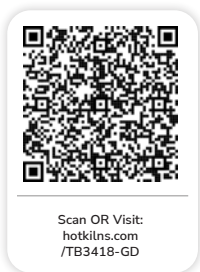

TRUST YOUR KILN
hotkilns.com

Manufactured in Swedesboro, NJ
800-750-8350 • sales@hotkilns.com

Bulletin No: BL-TB3418 REV: 0

Page 1



USA

Standard Models							Powered Bottom Models				
Model Number	Part Number	Volt/Phase	Watts	Amps	Wire Size	Fuse Size	Part Number	Watts	Amps	Wire Size	Fuse Size
TB3418-D-240	K-T-3418/31	240/1P	19,934	83.1	1 ga	110	K-T-341P/31	26,579	110.7	3/0	150
TB3418-D-240-3P	K-T-3418/32	240/3P	19,934	71.9	2 ga	90	K-T-341P/32	26,579	71.9	2 ga	90
TB3418-D-208	K-T-3418/21	208/1P	19,934	95.8	1/0	125	K-T-341P/21	26,579	127.8	4/0	175
TB3418-D-208-3P	K-T-3418/22	208/3P	19,934	83.0	1 ga	110	K-T-341P/22	26,579	83.0	1 ga	110
TB3418-D-480-3P	K-T-3418/62	480/3P	19,934	24.0	10 ga	30	K-T-341P/62	26,579	36.0	6 ga	50

WORLD

TB3418-D-220	K-T-B348/41	220/1P	19,934	90.6	1/0	125	K-T-341P/41	26,579	120.8	4/0	175
TB3418-D-380-3PY	K-T-B348/52	380/3PY	11,592	45.3	6 ga	60	K-T-341P/52	26,579	45.3	6 ga	60
TB3418-D-400-3PY	K-T-B348/82	400/3PY	11,592	43.3	6 ga	60	K-T-341P/82	26,579	43.3	6 ga	60
TB3418-D-415-3P4	K-T-B348/72	415/3PY	11,592	41.5	6 ga	60	K-T-341P/72	26,579	41.5	6 ga	60



Control: Full digital touchscreen Genesis control with easy-to-use interface, WiFi enabled app, and simple programs for firing ceramics or glass.

For Model Number Powered Bottom Model: Add a “PB” after the “D” (Example = T3427-D-PB-240-1).

UL Listing: c-MET-us listed.

Control Panels: All T3400 kilns get a floor standing panel. NEMA 1 panel are recommended but not required for 480 volts.

TB MODELS: TB models have more power.

480 Volt Models with Quad Element Option: See website kiln pages for electrical specifications.

Crating: Comes fully crated. Easily disassembles for installation.



FURNITURE KIT FOR TB3418

Part Number: H-T-K518/00

Includes: Six 28” x 14” x 3/4” rectangular shelves (3/4” thick), twelve each 1/2”, 1”, 2”, 4”, 6”, and 8” square posts, and one pair heat resistant. Gloves.

T3427

Temperature Rating: Cone 10

Volume: 20.7 Cubic Feet

Brick Thickness: 3" Brick

Inside: 43.5" D x 27" H

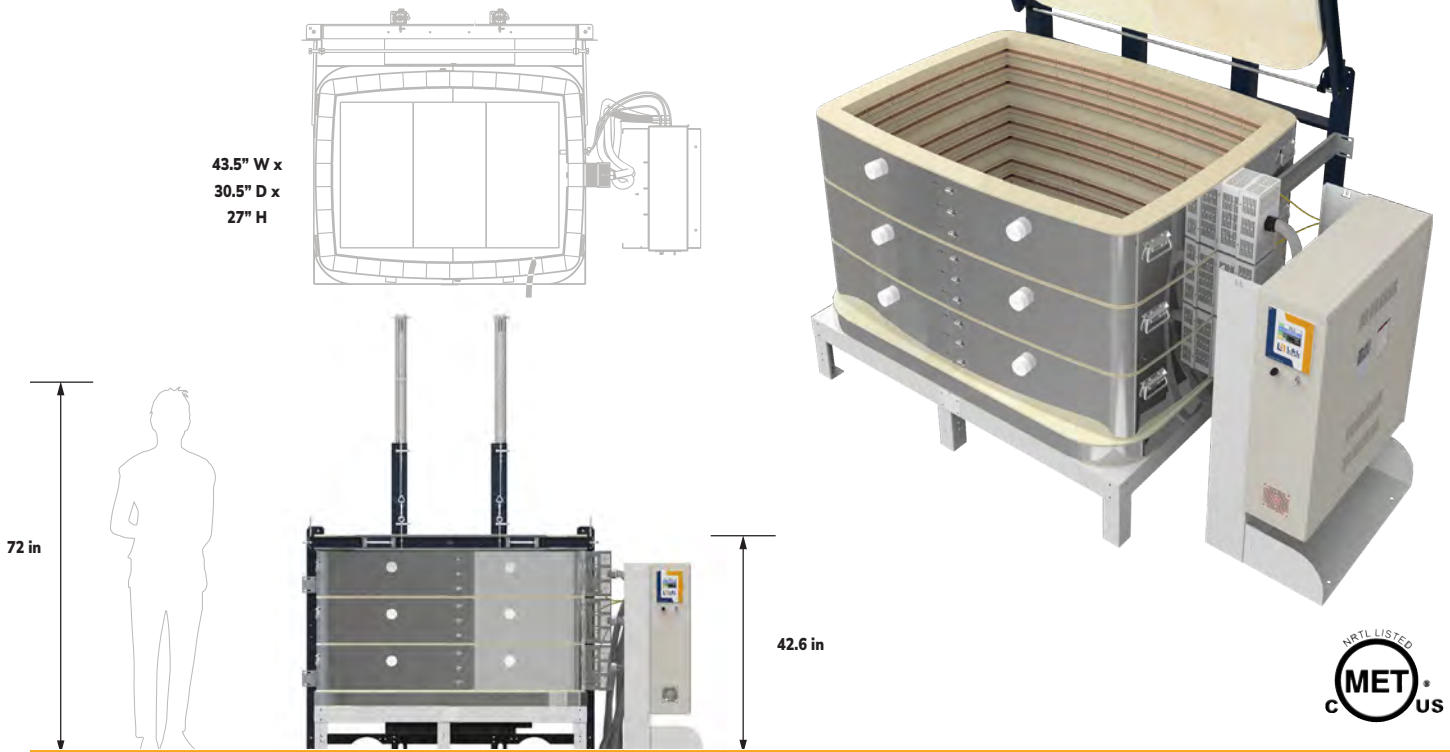

Large volume square and rectangular kilns with adjustable height. DaVinci kilns are great for production and tiles. Includes arched sides for strength and counterbalanced lid.

- **Genesis Touch Screen Control** with Dynamic Zone Control
- **Cone 10 • 2350°F • 1290°C**
- **Counterbalanced Lid** with springs inside of tubes
- **Safety Latches for Lid**
- **Welded angle-iron powder-coated stand and hinge**
- **3" brick**
- **Type K Thermocouples (3)**
 - with protection tubes
- **Strong arched sides** with extra space added to interior dimensions for good air circulation
- **Three elements per 9" section**
- **Ceramic Element Terminals**
- **Hard Ceramic Element Channels**
- **Plug in kiln sections** (except 480 volt models)
- **Floor mounted control panel**
- **c-MET-us listed to UL499 Standards**
- **See hotkilns.com/t3427 for all features and options**

GENERAL DIMENSIONS

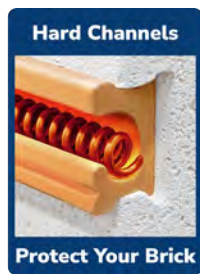
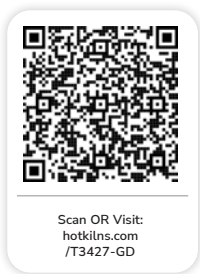

TRUST YOUR KILN
hotkilns.com

Manufactured in Swedesboro, NJ
800-750-8350 • sales@hotkilns.com

Bulletin No: BL-T3427 REV: 0

Page 1



USA

Standard Models							Powered Bottom Models				
Model Number	Part Number	Volt/Phase	Watts	Amps	Wire Size	Fuse Size	Part Number	Watts	Amps	Wire Size	Fuse Size
T3427-D-240	K-T-3427/31	240/1P	24,936	103.9	3/0	150	K-T-342P/31	30,477	127.0	4/0	175
T3427-D-240-3P	K-T-3427/32	240/3P	24,936	60.0	3 ga	80	K-T-342P/32	30,477	80.8	1 ga	110
T3427-D-208	K-T-3427/21	208/1P	24,936	119.9	3/0	150	K-T-342P/21	30,477	146.5	250 mcm	200
T3427-D-208-3P	K-T-3427/22	208/3P	24,936	69.2	2 ga	90	K-T-342P/22	30,477	93.2	1/0	125
T3427-D-480-3P	K-T-3427/62	480/3P	24,936	30.0	8 ga	40	K-T-342P/62	30,477	40.0	6 ga	50
TB3427-D-240	K-T-342B/31	240/1P	29,901	124.6	4/0	175	K-T-342W/31	36,546	152.3	250 mcm	200
TB3427-D-240-3P	K-T-342B/32	240/3P	29,901	71.9	2 ga	90	K-T-342W/32	36,546	96.9	1/0	125
TB3427-D-208	K-T-342B/21	208/1P	29,901	143.8	250 mcm	200	K-T-342W/21	36,546	175.7	300 mcm	225
TB3427-D-208-3P	K-T-342B/22	208/3P	29,901	83.0	1 ga	110	K-T-342W/22	36,546	111.8	3/0	150
TB3427-D-480-3P	K-T-342B/62	480/3P	29,901	36.0	6 ga	50	K-T-342W/62	36,546	48.0	6 ga	60

WORLD

T3427-D-220	K-T-3427/41	220/1P	24,936	113.3	3/0	150	K-T-342P/41	30,477	138.5	4/0	175
T3427-D-380-3PY	K-T-3427/52	380/3PY	24,936	37.8	6 ga	50	K-T-342P/52	30,477	63.0	3 ga	80
T3427-D-400-3PY	K-T-3427/82	400/3PY	24,936	36.1	6 ga	50	K-T-342P/82	30,477	60.2	3 ga	80
T3427-D-415-3PY	K-T-3427/72	415/3PY	24,936	34.6	6 ga	50	K-T-342P/72	30,477	57.7	3 ga	80
TB3427-D-220	K-T-342B/41	220/1P	29,901	135.9	4/0	175	K-T-342W/41	36,546	166.1	300 mcm	225
TB3427-D-380-3PY	K-T-342B/52	380/3PY	29,901	45.3	6 ga	60	K-T-342W/52	36,546	75.5	1 ga	100
TB3427-D-400-3PY	K-T-342B/82	400/3PY	29,901	43.3	6 ga	60	K-T-342W/82	36,546	72.2	1 ga	100
TB3427-D-415-3PY	K-T-342B/72	415/3PY	29,901	41.5	6 ga	60	K-T-342W/72	36,546	69.2	2 ga	90



Control: Full digital touchscreen Genesis control with easy-to-use interface, WiFi enabled app, and simple programs for firing ceramics or glass.

For Model Number Powered Bottom Model: Add a "PB" after the "D" (Example = T3427-D-PB-240-1).



FURNITURE KIT FOR T3427

Part Number: H-T-K527/00

Includes: Nine 28" x 14" x 3/4" rectangular shelves (3/4" thick), twelve each 1/2", 1", 2", 4", 6", and 8" square posts, and one pair heat resistant gloves.

UL Listing: c-MET-us listed.

Control Panels: Floor standing panel. NEMA 1 panel are recommended but not required for 480 volts.

TB MODELS: TB models have more power.

480 Volt Models with Quad Element Option: See website kiln pages for electrical specifications.

Crating: Comes fully crated. Easily disassembles for installation.

TRUST YOUR KILN
hotkilns.com

Manufactured in Swedesboro, NJ
800-750-8350 • sales@hotkilns.com

Bulletin No: BL-T3427 REV: 0

Page 2



T3436

Temperature Rating: Cone 10

Volume: 27.6 Cubic Feet

Brick Thickness: 3" Brick

Inside: 43.5" D x 36" H

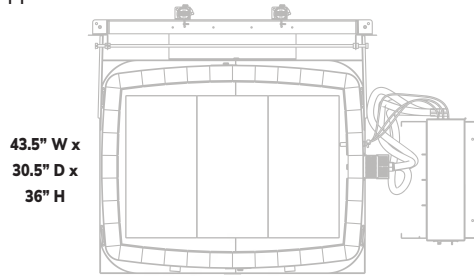

43.5" W x
30.5" D x
36" H

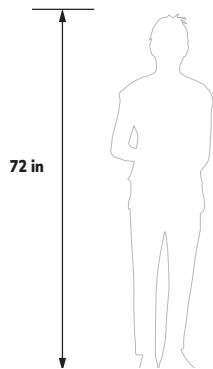

72 in



51.6 in



Large volume square and rectangular kilns with adjustable height. DaVinci kilns are great for production and tiles. Includes arched sides for strength and counterbalanced lid.

- **Genesis Touch Screen Control** with Dynamic Zone Control
- **Cone 10 • 2350°F • 1290°C**
- **Counterbalanced Lid** with springs inside of tubes
- **Safety Latches for Lid**
- **Welded angle-iron powder-coated stand and hinge**
- **3" brick** with all brick construction (including lid)
- **Type K Thermocouples (3)**
 - with protection tubes
- **Strong arched sides** with extra space added to interior dimensions for good air circulation
- **Three elements per 9" section**
- **Ceramic Element Terminals**
- **Hard Ceramic Element Channels**
- **Plug in kiln sections** (except 480 volt models)
- **Floor mounted control panel**
- **c-MET-us listed to UL499 Standards**
- **See hotkilns.com/t3436 for all features and options**

GENERAL DIMENSIONS

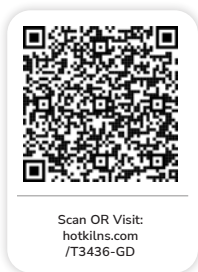

TRUST YOUR KILN
hotkilns.com

Manufactured in Swedesboro, NJ
800-750-8350 • sales@hotkilns.com

Bulletin No: BL-T3436 REV: 0

Page 1



Electrical Specifications for T3436

DaVinci Top-Loading Kilns

USA

Standard Models							Powered Bottom Models				
Model Number	Part Number	Volt/Phase	Watts	Amps	Wire Size	Fuse Size	Part Number	Watts	Amps	Wire Size	Fuse Size
T3436-D-240	K-T-3436/31	240/1P	33,248	138.5	4/0	175	K-T-343P/31	38,789	161.6	300 mcm	225
T3436-D-240-3P	K-T-3436/32	240/1P	33,248	91.6	1/0	125	K-T-343P/32	38,789	110.1	3/0	150
T3436-D-208	K-T-3436/21	208/1P	33,248	159.8	250 mcm	200	K-T-343P/21	38,789	186.5	350 mcm	250
T3436-D-208-3P	K-T-3436/22	208/3P	33,248	105.7	3/0	150	K-T-343P/22	38,789	127.1	4/0	175
T3436-D-480-3P	K-T-3436/62	480/3P	33,248	40.0	6 ga	50	K-T-343P/62	38,789	50.0	4 ga	70
TB3436-D-240	K-T-343B/31	240/1P	39,868	166.1	300 mcm	225	K-T-343W/31	46,513	193.8	350 mcm	250
TB3436-D-240-3P	K-T-343B/32	240/1P	39,868	109.9	3/0	150	K-T-343W/32	46,513	132.1	4/0	175
TB3436-D-208	K-T-343B/21	208/1P	39,868	191.7	350 mcm	250	K-T-343W/21	46,513	223.6	500 mcm	300
TB3436-D-208-3P	K-T-343B/22	208/3P	39,868	126.8	4/0	175	K-T-343W/22	46,513	152.4	250 mcm	200
TB3436-D-480-3P	K-T-343B/62	480/3P	39,868	48.0	6 ga	60	K-T-343W/62	46,513	60.0	3 ga	80

WORLD

T3436-D-220	K-T-3436/41	220/1P	33,248	151.1	250 mcm	200	K-T-343P/41	38,789	176.3	300 mcm	225
T3436-D-380-3PY	K-T-3436/52	380/3PY	33,248	75.6	1 ga	100	K-T-343P/52	38,789	75.6	1 ga	100
T3436-D-400-3PY	K-T-3436/82	400/3PY	33,248	72.3	1 ga	100	K-T-343P/82	38,789	72.3	1 ga	100
T3436-D-415-3PY	K-T-3436/72	415/3PY	33,248	69.3	2 ga	90	K-T-343P/72	38,789	69.3	2 ga	90
TB3436-D-220	K-T-343B/41	220/1P	39,868	181.2	350 mcm	250	K-T-343W/41	46,513	211.4	400 mcm	275
TB3436-D-380-3PY	K-T-343B/52	380/3PY	39,868	90.6	1/0	125	K-T-343W/52	46,513	90.6	1/0	125
TB3436-D-400-3PY	K-T-343B/82	400/3PY	39,868	86.7	1 ga	110	K-T-343W/82	46,513	86.7	1 ga	110
TB3436-D-415-3PY	K-T-343B/72	415/3PY	39,868	83.1	1 ga	110	K-T-343W/72	46,513	83.1	1 ga	110



Control: Full digital touchscreen Genesis control with easy-to-use interface, WiFi enabled app, and simple programs for firing ceramics or glass.

For Model Number Powered Bottom Model: Add a "PB" after the "D" (Example = T3427-D-PB-240-1).

UL Listing: All models are c-MET-us listed.

Control Panels: All T3400 kilns get a floor standing panel. NEMA 1 panel are recommended but not required for 480 volts.

TB MODELS: TB models have more power than the regular T model kilns.

480 Volt Models with Quad Element Option: See website kiln pages for electrical specifications.



FURNITURE KIT FOR T3436

Part Number: H-T-K536/00

Includes: Twelve 28" x 14" x 3/4" rectangular shelves (3/4" thick), twelve each 1/2", 1", 2", 4", 6", and 8" square posts, and one pair heat resistant gloves.

TRUST YOUR KILN
hotkilns.com

Manufactured in Swedesboro, NJ
800-750-8350 • sales@hotkilns.com

Bulletin No: BL-T3436 REV: 0

Page 2



T3445

Temperature Rating: Cone 10

Volume: 34.6 Cubic Feet

Brick Thickness: 3" Brick

Inside: 43.5" D x 45" H

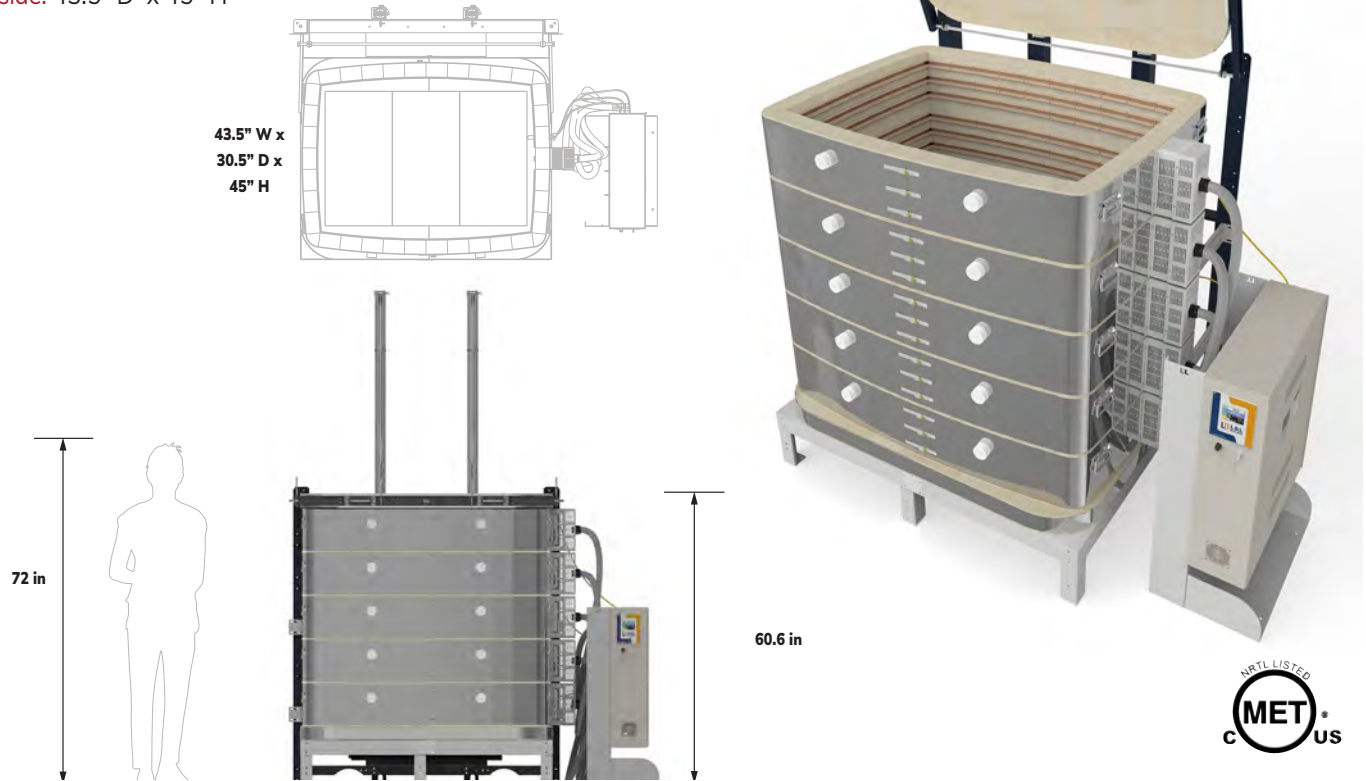

Large volume square and rectangular kilns with adjustable height. DaVinci kilns are great for production and tiles. Includes arched sides for strength and counterbalanced lid.

- **Genesis Touch Screen Control** with Dynamic Zone Control
- **Cone 10 • 2350°F • 1290°C**
- **Counterbalanced Lid** with springs inside of tubes
- **Safety Latches for Lid**
- **Welded angle-iron powder-coated stand and hinge**
- **3" brick**
- **Type K Thermocouples (3)**
 - with protection tubes
- **Strong arched sides** with extra space added to interior dimensions for good air circulation
- **Three elements per 9" section**
- **Ceramic Element Terminals**
- **Hard Ceramic Element Channels**
- **Plug in kiln sections** (except 480 volt models)
- **Floor mounted control panel**
- **c-MET-us listed to UL499 Standards**
- **See hotkilns.com/t3445 for all features and options**

GENERAL DIMENSIONS

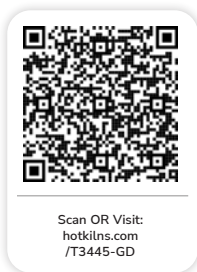

TRUST YOUR KILN
hotkilns.com

Manufactured in Swedesboro, NJ
800-750-8350 • sales@hotkilns.com

Bulletin No: BL-T3445 REV: 0

Page 1



USA

Standard Models							Powered Bottom Models				
Model Number	Part Number	Volt/Phase	Watts	Amps	Wire Size	Fuse Size	Part Number	Watts	Amps	Wire Size	Fuse Size
T3445-D-240	K-T-3445/31	240/1P	41,560	173.2	300 mcm	225	K-T-344P/31	47,101	196.3	350 mcm	250
T3445-D-240-3P	K-T-3445/32	240/3P	41,560	120.0	3/0	150	K-T-344P/32	47,101	120.0	3/0	150
T3445-D-208	K-T-3445/21	208/1P	41,560	199.8	350 mcm	250	K-T-344P/21	47,101	226.4	500 mcm	300
T3445-D-208-3P	K-T-3445/22	208/3P	41,560	138.4	4/0	175	K-T-344P/22	47,101	138.4	4/0	175
T3445-D-480-3P	K-T-3445/62	480/3P	41,560	50.0	4 ga	70	K-T-344P/62	47,101	60.0	3 ga	80
TB3445-D-240	K-T-344B/31	240/1P	49,835	207.7	400 mcm	275	K-T-344W/31	56,480	235.3	500 mcm	300
TB3445-D-240-3P	K-T-344B/32	240/3P	49,835	143.9	250 mcm	200	K-T-344W/32	56,480	143.9	250 mcm	200
TB3445-D-208	K-T-344B/21	208/1P	49,835	239.6	500 mcm	300	K-T-344W/21	56,480	271.5	500 mcm	350
TB3445-D-208-3P	K-T-344B/22	208/3P	49,835	166.0	350 mcm	225	K-T-344W/22	56,480	166.0	300 mcm	225
TB3445-D-480-3P	K-T-344B/62	480/3P	49,835	60.0	3 ga	80	K-T-344W/62	56,480	72.0	2 ga	90

WORLD

T3445-D-220	K-T3445/41	220/1P	41,560	188.9	350 mcm	250	K-T344P/41	47,101	214.1	400 mcm	275
T3445-D-380-3PY	K-T3445/52	380/3PY	41,560	75.6	1 ga	100	K-T344P/52	47,101	75.6	1 ga	100
T3445-D-400-3PY	K-T3445/82	400/3PY	41,560	72.3	1 ga	100	K-T344P/82	47,101	72.3	1 ga	100
T3445-D-415-3PY	K-T3445/72	415/3PY	41,560	69.3	2 ga	90	K-T344P/72	47,101	69.3	2 ga	90
TB3445-D-220	K-T344B/41	220/1P	49,835	226.5	500 mcm	300	K-T-344W/41	56,480	256.7	500 mcm	350
TB3445-D-380-3PY	K-T344B/52	380/3PY	49,835	52.5	4 ga	70	K-T-344W/52	56,480	90.6	1/0	125
TB3445-D-400-3PY	K-T344B/82	400/3PY	49,835	49.8	4 ga	70	K-T-344W/82	56,480	86.7	1 ga	110
TB3445-D-415-3PY	K-T344B/72	415/3PY	49,835	48.0	6 ga	60	K-T-344W/72	56,480	83.1	1 ga	110



Control: Full digital touchscreen Genesis control with easy-to-use interface, WiFi enabled app, and simple programs for firing ceramics or glass.

For Model Number Powered Bottom Model: Add a "PB" after the "D" (Example = T3427-D-PB-240-1).

UL Listing: c-MET-us listed.

Control Panels: Floor standing panel. NEMA 1 panel are recommended but not required for 480 volts.

TB MODELS: TB models have more power.

480 Volt Models with Quad Element Option: See website kiln pages for electrical specifications.

Crating: Comes fully crated. Easily disassembles for installation.



FURNITURE KIT FOR T3445

Part Number: H-T-K545/00

Includes: Fifteen 28" x 14" x 3/4" rectangular shelves (3/4" thick), eighteen each 1/2", 1", 2", 4", 6", and 8" square posts, and one pair heat resistant gloves.

XB2818

Temperature Rating: Cone 10

Volume: 7.3 Cubic Feet

Brick Thickness: 3" Brick

Inside: 26.5" W x 26.5" D x 18" H

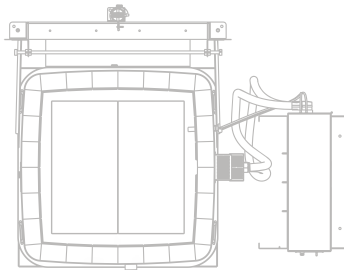

26.5" W x
26.5" D x
18" H



Large volume square kilns with adjustable height. DaVinci kilns are great for production and tiles. Includes arched sides for strength and counterbalanced lid.

- **Genesis Touch Screen Control** with Dynamic Zone Control
- **Cone 10 • 2350°F • 1290°C**
- **Counterbalanced Lid** with springs inside of tubes
- **Safety Latches for Lid**
- **Welded angle-iron powder-coated stand and hinge**
- **3" brick**
- **Type K Thermocouples (2)**
 - with protection tubes
- **Strong arched sides** with extra

space added to interior dimensions for good air circulation

- **Three elements per 9" section**
- **Ceramic Element Terminals**
- **Hard Ceramic Element Channels**
- **Plug in kiln sections** (except 480 volt models)
- **Floor mounted control panel**
- **c-MET-us listed to UL499 Standards**
- **See hotkilns.com/xb2818 for all features and options**

GENERAL DIMENSIONS



TRUST YOUR KILN
hotkilns.com

Manufactured in Swedesboro, NJ
800-750-8350 • sales@hotkilns.com

Bulletin No: BL-XB2818 REV: 0

Page 1



Electrical Specifications for XB2818

DaVinci Top-Loading Kilns

USA

Standard Models							Powered Bottom Models				
Model Number	Part Number	Volt/Phase	Watts	Amps	Wire Size	Fuse Size	Part Number	Watts	Amps	Wire Size	Fuse Size
XB2818-D-240	K-X-2818/31	240/1P	11,592	48.3	4 ga	70	K-X-281W/31	15,456	64.4	2 ga	90
XB2818-D-240-3P	K-X-2818/32	240/3P	11,592	41.8	6 ga	60	K-X-281W/32	15,456	41.8	6 ga	60
XB2818-D-208	K-X-2818/21	208/1P	11,592	55.7	4 ga	70	K-X-281W/21	15,456	74.3	1 ga	100
XB2818-D-208-3P	K-X-2818/22	208/3P	11,592	48.3	4 ga	70	K-X-281W/62	15,456	48.3	4 ga	70
XB2818-D-480-3P	K-X-2818/22	480/3P	11,592	20.9	10 ga	30	K-X-281W/22	15,456	20.9	10 ga	30

WORLD

Standard Models							Powered Bottom Models				
Model Number	Part Number	Volt/Phase	Watts	Amps	Wire Size	Fuse Size	Part Number	Watts	Amps	Wire Size	Fuse Size
XB2818-D-220	K-X-2818/41	220/1P	11,592	69.7	2 ga	90	K-X-281W/41	15,456	70.3	2 ga	90
XB2818-D-380-3PY	K-X-2818/52	380/3PY	11,592	26.3	8 ga	40	K-X-281W/52	15,456	26.4	8 ga	40
XB2818-D-400-3PY	K-X-2818/82	400/3PY	11,592	25.2	8 ga	40	K-X-281W/82	15,456	25.2	8 ga	40
XB2818-D-415-3P4	K-X-2818/72	415/3PY	11,592	24.2	8 ga	40	K-X-281W/72	15,456	24.2	8 ga	40



Control: Full digital touchscreen Genesis control with easy-to-use interface, WiFi enabled app, and simple programs for firing ceramics or glass.

For Model Number Powered Bottom Model: Add a “PB” after the “D” (Example = X2827-D-PB-240-1). Note: Powered Bottoms on the X2800 models are by special order only.

UL Listing: c-MET-us listed.

Control Panels: Floor standing panel. NEMA 1 panel are recommended but not required for 480 volts.

480 Volt Models with Quad Element Option: See website kiln pages for electrical specifications.

Power Bottoms for X2800: These are special order only. Electrical specifications are included above.

Crating: Comes fully crated. Easily disassembles for installation.



FURNITURE KIT FOR XB2818

Part Number: H-X-K818/00

Includes: Four 24” X 12” rectangular shelves (3/4” thick), six each 1/2”, 1”, 2”, 4”, 6”, and 8” square posts, heat resistant gloves.

TRUST YOUR KILN
hotkilns.com

Manufactured in Swedesboro, NJ
800-750-8350 • sales@hotkilns.com

Bulletin No: BL-XB2818 REV: 0

Page 2



X2827

Temperature Rating: Cone 10

Volume: 11.0 Cubic Feet

Brick Thickness: 3" Brick

Inside: 26.5" D x 27" H



Large volume square kilns with adjustable height. DaVinci kilns are great for production and tiles. Includes arched sides for strength and counterbalanced lid.

- **Genesis Touch Screen Control** with Dynamic Zone Control
- **Cone 10 • 2350°F • 1290°C**
- **Counterbalanced Lid** with springs inside of tubes
- **Safety Latches for Lid**
- **Welded angle-iron powder-coated stand and hinge**
- **3" brick**
- **Type K Thermocouples (3)**
 - with protection tubes
- **Strong arched sides** with extra

space added to interior dimensions for good air circulation

- **Three elements per 9" section**
- **Ceramic Element Terminals**
- **Hard Ceramic Element Channels**
- **Plug in kiln sections** (except 480 volt models)
- **Floor mounted control panel**
- **c-MET-us listed to UL499 Standards**
- **See hotkilns.com/x2827 for all features and options**

GENERAL DIMENSIONS



TRUST YOUR KILN
hotkilns.com

Manufactured in Swedesboro, NJ
800-750-8350 • sales@hotkilns.com

Bulletin No: BL-X2827 REV: 0

Page 1



USA

Standard Models							Powered Bottom Models				
Model Number	Part Number	Volt/Phase	Watts	Amps	Wire Size	Fuse Size	Part Number	Watts	Amps	Wire Size	Fuse Size
X2827-D-240	K-X-2827/31	240/1P	14,930	62.2	3 ga	80	K-X-282P/31	18,250	76.0	1 ga	100
X2827-D-240-3P	K-X-2827/32	240/3P	14,930	35.9	6 ga	50	K-X-282P/32	18,250	48.4	4 ga	70
X2827-D-208	K-X-2827/21	208/1P	14,930	71.8	2 ga	90	K-X-282P/21	18,250	87.7	1 ga	110
X2827-D-208-3P	K-X-2827/22	208/3P	14,930	41.5	6 ga	60	K-X-282P/22	18,250	55.8	4 ga	70
X2827-D-480-3P	K-X-2827/62	480/3P	14,930				K-X-282P/62	18,250	24.0	10 ga	30
XB2827-D-240	K-X-282B/31	240/1P	17,388	72.5	1 ga	100	K-X-282W/31	21,252	88.6	1/0	125
XB2827-D-240-3P	K-X-282B/32	240/3P	17,388	41.8	6 ga	60	K-X-282W/32	21,252	56.3	3 ga	80
XB2827-D-208	K-X-282B/21	208/1P	17,388	83.6	1 ga	110	K-X-282W/21	21,252	102.2	3/0	150
XB2827-D-208-3P	K-X-282B/22	208/3P	17,388	48.3	4 ga	70	K-X-282W/22	21,252	65.0	2 ga	90
XB2827-D-480-3P	K-X-282B/62	480/3P	17,388	20.9	10 ga	30	K-X-282W/62	21,252	27.9	8 ga	40

WORLD

X2827-D-220	K-X-2827/41	220/1P	14,930	67.9	2 ga	90	K-X-282P/41	18,250	83.0	1 ga	110
X2827-D-380-3PY	K-X-2827/52	380/3PY	14,930	22.6	10 ga	30	K-X-282P/52	18,250	37.7	6 ga	50
X2827-D-400-3PY	K-X-2827/82	400/3PY	14,930	21.6	10 ga	30	K-X-282P/82	18,250	36.1	6 ga	50
X2827-D-415-3PY	K-X-2827/72	415/3PY	14,930	20.7	10 ga	30	K-X-282P/72	18,250	34.6	6 ga	50
XB2827-D-220	K-X-2827/41	220/1P	17,388	79.0	1 ga	100	K-X-282W/41	21,252	96.6	1/0	125
XB2827-D-380-3PY	K-X-2827/52	380/3PY	17,388	26.3	8 ga	40	K-X-282W/52	21,252	43.9	6 ga	60
XB2827-D-400-3PY	K-X-2827/82	400/3PY	17,388	25.2	8 ga	40	K-X-282W/82	21,252	42.0	6 ga	60
XB2827-D-415-3PY	K-X-2827/72	415/3PY	17,388	24.2	8 ga	40	K-X-282W/72	21,252	40.2	6 ga	60



Control: Full digital touchscreen Genesis control with easy-to-use interface, WiFi enabled app, and simple programs for firing ceramics or glass.

For Model Number Powered Bottom Model: Add a "PB" after the "D" (Example = X2827-D-PB-240-1). Note: Powered Bottoms on the X2800 models are by special order only.

UL Listing: c-MET-us listed.

Control Panels: Floor standing panel. NEMA 1 panel are recommended but not required for 480 volts.

XB MODELS: XB models have more power.

480 Volt Models with Quad Element Option: See website kiln pages for electrical specifications.

Power Bottoms for X2800: These are special order only. Electrical specifications are included above.

Crating: Comes fully crated. Easily disassembles for installation.



FURNITURE KIT FOR X2827

Part Number: H-X-K827/00

Includes: Six 24" X 12" rectangular shelves (3/4" thick), six each 1/2", 1", 2", 4", 6", and 8" square posts, heat resistant gloves.

X2836

Temperature Rating: Cone 10

Volume: 14.6 Cubic Feet

Brick Thickness: 3" Brick

Inside: 26.5" D x 36" H

26.5" W x 26.5" D
x 36" H

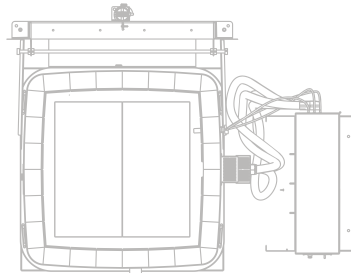

72 in



51.6 in



Large volume square kilns with adjustable height. DaVinci kilns are great for production and tiles. Includes arched sides for strength and counterbalanced lid.

- **Genesis Touch Screen Control** with Dynamic Zone Control
- **Cone 10 • 2350°F • 1290°C**
- **Counterbalanced Lid** with springs inside of tubes
- **Safety Latches for Lid**
- **Welded angle-iron powder-coated stand and hinge**
- **3" brick**
- **Type K Thermocouples (3)**
 - with protection tubes
- **Strong arched sides** with extra

space added to interior dimensions for good air circulation

- **Three elements per 9" section**
- **Ceramic Element Terminals**
- **Hard Ceramic Element Channels**
- **Plug in kiln sections** (except 480 volt models)
- **Floor mounted control panel**
- **c-MET-us listed to UL499 Standards**
- **See hotkilns.com/x2836 for all features and options**

GENERAL DIMENSIONS



Scan OR Visit:
hotkilns.com/X2836-GD



TRUST YOUR KILN
hotkilns.com

Manufactured in Swedesboro, NJ
800-750-8350 • sales@hotkilns.com

Bulletin No: BL-X2836 REV: 0

Page 1



USA

Standard Models							Powered Bottom Models				
Model Number	Part Number	Volt/Phase	Watts	Amps	Wire Size	Fuse Size	Part Number	Watts	Amps	Wire Size	Fuse Size
X2836-D-240	K-X-2836/31	240/1P	19,907	82.9	1 ga	110	K-X-283P/31	23,226	96.8	1/0	125
X2836-D-240-3P	K-X-2836/32	240/3P	19,907	54.9	4 ga	70	K-X-283P/32	23,226	65.9	2 ga	90
X2836-D-208	K-X-2836/21	208/1P	19,907	95.7	1/0	125	K-X-283P/21	23,226	111.7	3/0	150
X2836-D-208-3P	K-X-2836/22	208/3P	19,907	63.3	3 ga	80	K-X-283P/22	23,226	76.1	1 ga	100
X2836-D-480-3P	K-X-2836/62	480/3P	19,907	20.7	10 ga	30	K-X-283P/62	23,226	30.0	8 ga	40
XB2836-D-240	K-X-283B/31	240/1P	23,184	96.6	1/0	125	K-X-283W/31	27,050	112.7	3/0	150
XB2836-D-240-3P	K-X-283B/32	240/3P	23,184	63.9	3 ga	80	K-X-283W/32	27,050	76.8	1 ga	100
XB2836-D-208	K-X-283B/21	208/1P	23,184	111.5	3/0	150	K-X-283W/21	27,050	130.0	4/0	175
XB2836-D-208-3P	K-X-283B/22	208/3P	23,184	73.7	1 ga	100	K-X-283W/22	27,050	88.6	1/0	125
XB2836-D-480-3P	K-X-283B/62	480/3P	23,184	27.9	8 ga	40	K-X-283W/62	27,050	34.9	6 ga	50

WORLD

X2836-D-220	K-X-2836/41	220/1P	19,907	90.5	1/0	125	K-X-283P/41	23,226	105.6	3/0	150
X2836-D-380-3PY	K-X-2836/52	380/3PY	19,907	45.2	6 ga	60	K-X-283P/52	23,226	45.3	6 ga	60
X2836-D-400-3PY	K-X-2836/82	400/3PY	19,907	43.3	6 ga	60	K-X-283P/82	23,226	43.3	6 ga	60
X2836-D-415-3PY	K-X-2836/72	415/3PY	19,907	41.5	6 ga	60	K-X-283P/72	23,226	41.5	6 ga	60
XB2836-D-220	K-X-2836/41	220/1P	23,184	105.4	3/0	150	K-X-283W/41	27,050	123.0	4/0	175
XB2836-D-380-3PY	K-X-2836/52	380/3PY	23,184	52.7	4 ga	70	K-X-283W/52	27,050	52.7	4 ga	70
XB2836-D-400-3PY	K-X-2836/82	400/3PY	23,184	50.4	4 ga	70	K-X-283W/82	27,050	50.4	4 ga	70
XB2836-D-415-3PY	K-X-2836/72	415/3PY	23,184	48.3	4 ga	70	K-X-283W/72	27,050	48.3	4 ga	70



Control: Full digital touchscreen Genesis control with easy-to-use interface, WiFi enabled app, and simple programs for firing ceramics or glass.

For Model Number Powered Bottom Model:

Add a "PB" after the "D" (Example = X2827-D-PB-240-1). Note: Powered Bottoms on the X2800 models are by special order only.

UL Listing: c-MET-us listed.



Control Panels: All X2800 kilns get a floor standing panel. NEMA 1 panel are recommended but not required for 480 volts.

XB MODELS: XB models have more power.

480 Volt Models with Quad Element Option: See website kiln pages for electrical specifications.

Power Bottoms for X2800: These are special order only. Electrical specifications are included above.

Crating: Comes fully crated. Easily disassembles for installation.

FURNITURE KIT FOR X2836

Part Number: H-X-K836/00

Includes: Eight 24" X 12" rectangular shelves (3/4" thick), twelve each 1/2", 1", 2", 4", 6", and 8" square posts, heat resistant gloves.

X2845

Temperature Rating: Cone 10

Volume: 18.3 Cubic Feet

Brick Thickness: 3" Brick

Inside: 26.5" D x 45" H

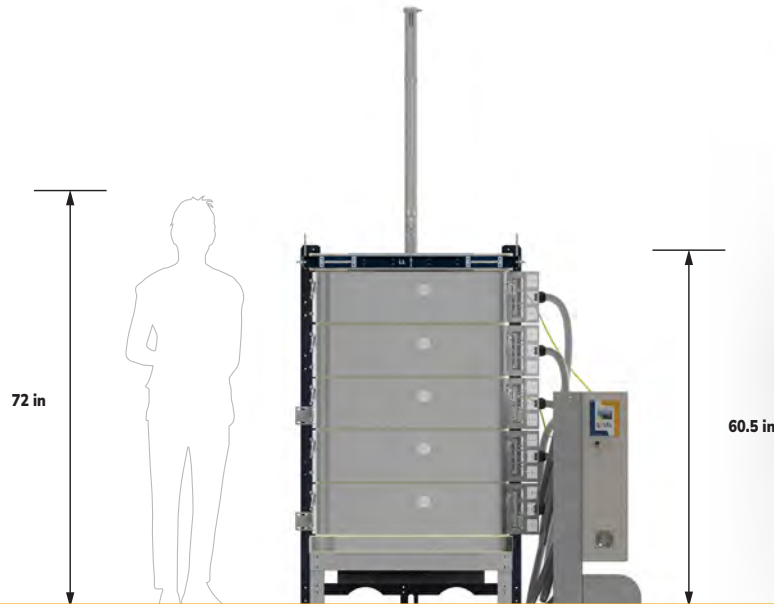
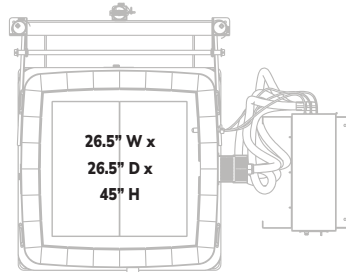

Large volume square kilns with adjustable height. DaVinci kilns are great for production and tiles. Includes arched sides for strength and counterbalanced lid.

- **Genesis Touch Screen Control** with Dynamic Zone Control
- **Cone 10 • 2350°F • 1290°C**
- **Counterbalanced Lid** with springs inside of tubes
- **Safety Latches for Lid**
- **Welded angle-iron powder-coated stand and hinge**
- **3" brick**
- **Type K Thermocouples (3)**
 - with protection tubes
- **Strong arched sides** with extra

space added to interior dimensions for good air circulation

- **Three elements per 9" section**
- **Ceramic Element Terminals**
- **Hard Ceramic Element Channels**
- **Plug in kiln sections** (except 480 volt models)
- **Floor mounted control panel**
- **c-MET-us listed to UL499 Standards**
- **See hotkilns.com/X2845 for all features and options**

GENERAL DIMENSIONS

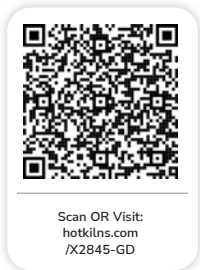

TRUST YOUR KILN
hotkilns.com

Manufactured in Swedesboro, NJ
800-750-8350 • sales@hotkilns.com

Bulletin No: BL-X2845 REV: 0

Page 1



USA

Standard Models							Powered Bottom Models				
Model Number	Part Number	Volt/Phase	Watts	Amps	Wire Size	Fuse Size	Part Number	Watts	Amps	Wire Size	Fuse Size
X2845-D-240	K-X-2845/31	240/1P	24,885	103.7	3/0	150	K-X-284P/31	28,203	117.5	3/0	150
X2845-D-240-3P	K-X-2845/32	240/3P	24,885	71.9	2 ga	90	K-X-284P/32	28,203	71.8	2 ga	90
X2845-D-208	K-X-2845/21	208/1P	24,885	119.6	3/0	150	K-X-284P/21	28,203	135.6	4/0	175
X2845-D-208-3P	K-X-2845/22	208/3P	24,885	82.9	1 ga	110	K-X-284P/22	28,203	82.9	1 ga	110
X2845-D-480-3P	K-X-2845/62	480/3P	24,885	29.9	8 ga	40	K-X-284P/62	28,203	35.9	6 ga	50
XB2845-D-240	K-X-284B/31	240/1P	29,980	120.8	4/0	175	K-X-284W/31	32,845	136.9	4/0	175
XB2845-D-240-3P	K-X-284B/32	240/3P	29,980	83.7	1 ga	110	K-X-284W/32	32,845	83.7	1 ga	110
XB2845-D-208	K-X-284B/21	208/1P	29,980	139.3	4/0	175	K-X-284W/21	32,845	157.9	250 mcm	200
XB2845-D-208-3P	K-X-284B/22	208/3P	29,980	96.5	1/0	125	K-X-284W/22	32,845	96.5	1/0	125
XB2845-D-480-3P	K-X-284B/62	480/3P	29,980	34.9	6 ga	50	K-X-284W/62	32,845	41.9	6 ga	60

WORLD

X2845-D-220	K-X-2845/41	220/1P	24,885	113.1	3/0	150	K-X-284P/41	28,203	128.2	4/0	175
X2845-D-380-3PY	K-X-2845/52	380/3PY	24,885	45.2	6 ga	60	K-X-284P/52	28,203	45.3	6 ga	60
X2845-D-400-3PY	K-X-2845/82	400/3PY	24,885	43.3	6 ga	60	K-X-284P/82	28,203	43.3	6 ga	60
X2845-D-415-3PY	K-X-2845/72	415/3PY	24,885	41.5	6 ga	60	K-X-284P/72	28,203	41.5	6 ga	60
XB2845-D-220	K-X-2845/41	220/1P	28,980	131.7	4/0	175	K-X-284W/41	32,845	149.3	250 mcm	200
XB2845-D-380-3PY	K-X-2845/52	380/3PY	28,980	52.7	4 ga	70	K-X-284W/52	32,845	52.7	4 ga	70
XB2845-D-400-3PY	K-X-2845/82	400/3PY	28,980	50.4	4 ga	70	K-X-284W/82	32,845	50.4	4 ga	70
XB2845-D-415-3PY	K-X-2845/72	415/3PY	28,980	48.3	4 ga	70	K-X-284W/72	32,845	48.3	4 ga	70

Control: Full digital touchscreen Genesis control with easy-to-use interface, WiFi enabled app, and simple programs for firing ceramics or glass.

For Model Number Powered Bottom

Model: Add a "PB" after the "D" (Example = X2827-D-PB-240-1). Note: Powered Bottoms on the X2800 models are by special order only.

UL Listing: c-MET-us listed.



Control Panels: Floor standing panel. NEMA 1 panel are recommended but not required for 480 volts.

XB MODELS: XB models have more power.

480 Volt Models with Quad Element Option: See website kiln pages for electrical specifications.

Power Bottoms for X2800: These are special order only. Electrical specifications are included above.

Crating: Comes fully crated. Easily disassembles for installation.

FURNITURE KIT FOR X2845

Part Number: H-X-K845/00

Includes: Ten 24" X 12" rectangular shelves (3/4" thick), twelve each 1/2", 1", 2", 4", 6", and 8" square posts, and one pair heat resistant gloves.

XB3218

Temperature Rating: Cone 10

Volume: 9.7 Cubic Feet

Brick Thickness: 3" Brick

Inside: 30.5" D x 18" H

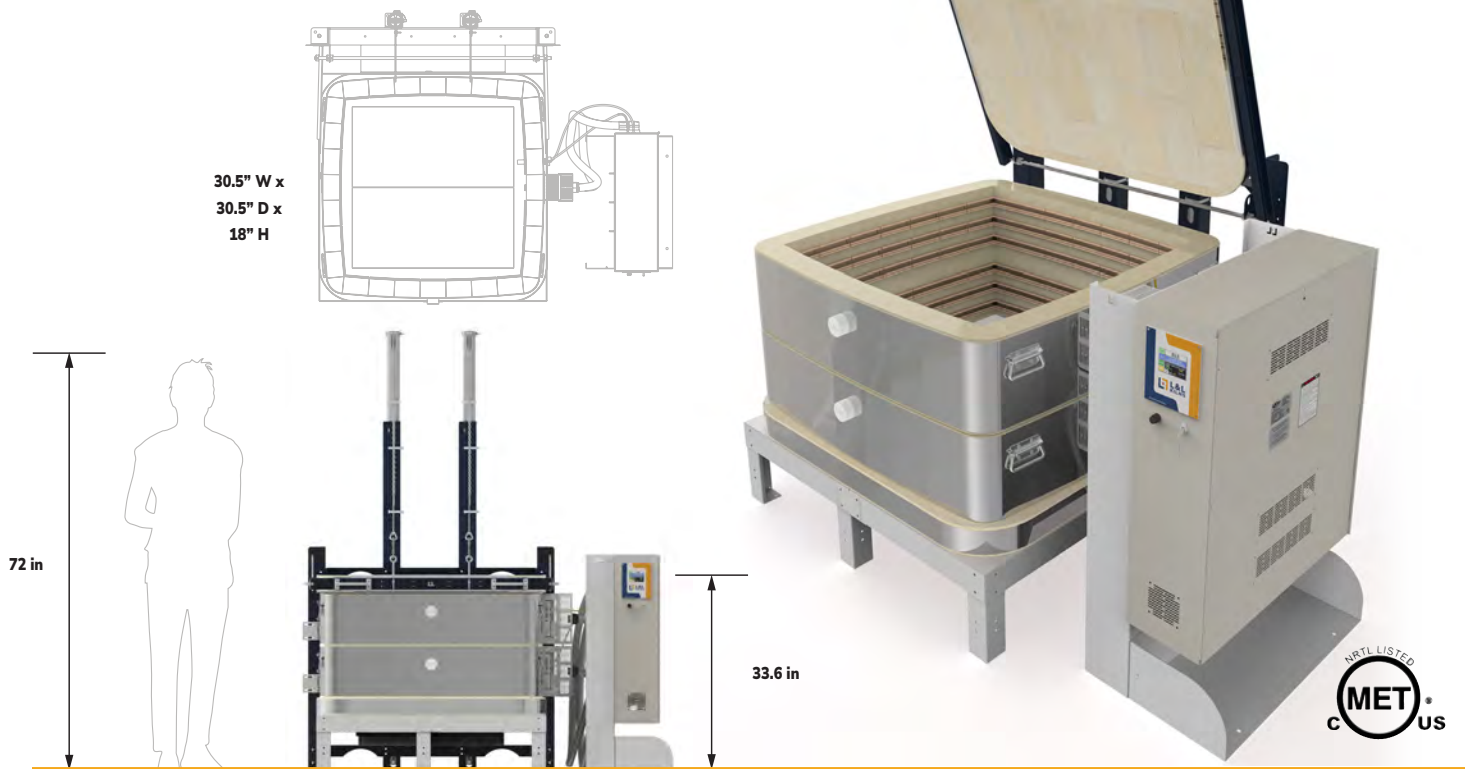

Large volume square kilns with adjustable height. DaVinci kilns are great for production and tiles. Includes arched sides for strength and counterbalanced lid.

- **Genesis Touch Screen Control** with Dynamic Zone Control
- **Cone 10 • 2350°F • 1290°C**
- **Counterbalanced Lid** with springs inside of tubes
- **Safety Latches for Lid**
- **Welded angle-iron powder-coated stand and hinge**
- **3" brick**
- **Type K Thermocouples (2)**
 - with protection tubes
- **Strong arched sides** with extra space added to interior dimensions for good air circulation
- **Three elements per 9" section**
- **Ceramic Element Terminals**
- **Hard Ceramic Element Channels**
- **Plug in kiln sections** (except 480 volt models)
- **Floor mounted control panel**
- **c-MET-us listed to UL499 Standards**
- **See hotkilns.com/xb3218 for all features and options**

GENERAL DIMENSIONS

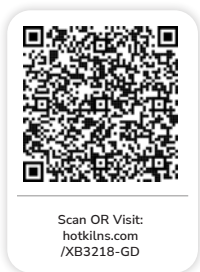

TRUST YOUR KILN
hotkilns.com

Manufactured in Swedesboro, NJ
800-750-8350 • sales@hotkilns.com

Bulletin No: BL-XB3218 REV: 0

Page 1



USA

Standard Models							Powered Bottom Models				
Model Number	Part Number	Volt/Phase	Watts	Amps	Wire Size	Fuse Size	Part Number	Watts	Amps	Wire Size	Fuse Size
XB3218-D-240	K-X-3218/31	240/1P	14,196	59.2	3 ga	80	K-X-321P/31	18,928	78.9	1 ga	100
XB3218-D-240-3P	K-X-3218/32	240/3P	14,196	51.2	4 ga	70	K-X-321P/32	18,928	51.2	4 ga	70
XB3218-D-208	K-X-3218/21	208/1P	14,196	68.3	2 ga	90	K-X-321P/21	18,928	91.0	1/0	125
XB3218-D-208-3P	K-X-3218/22	208/3P	14,196	59.1	3 ga	80	K-X-321P/22	18,928	59.1	3 ga	80
XB3218-D-480-3P	K-X-3218/62	480/3P	14,196	17.1	12 ga	25	K-X-321P/62	18,928	25.6	8 ga	40

WORLD

XB3218-D-220	K-X-3218/41	220/1P	14,196	64.5	2 ga	90	K-X-321P/41	18,928	86.0	1 ga	110
XB3218-D-380-3PY	K-X-3218/52	380/3PY	14,196	32.3	6 ga	50	K-X-321P/52	18,928	32.3	6 ga	50
XB3218-D-400-3PY	K-X-3218/82	400/3PY	14,196	30.9	8 ga	40	K-X-321P/82	18,928	30.9	8 ga	40
XB3218-D-415-3P4	K-X-3218/72	415/3PY	14,196	29.6	8 ga	40	K-X-321P/72	18,928	29.6	8 ga	40



Control: Full digital touchscreen Genesis control with easy-to-use interface, WiFi enabled app, and simple programs for firing ceramics or glass.

For Model Number of Powered Bottom Model: Add a "PB" after the "D" (Example = X3227-D-PB-240-1).

UL Listing: c-MET-us listed.

Control Panels: Floor standing panel. NEMA 1 panel are recommended but not required for 480 volts.

480 Volt Models with Quad Element Option: See website kiln pages for electrical specifications.

Crating: Comes fully crated. Easily disassembles for installation.



FURNITURE KIT FOR XB3218

Part Number: H-X-K218/00

Includes: Four 28" X 14" rectangular shelves (3/4" thick), six each 1/2", 1", 2", 4", 6", and 8" square posts, and one pair heat resistant gloves.

X3227

Temperature Rating: Cone 10

Volume: 14.5 Cubic Feet

Brick Thickness: 3" Brick

Inside: 30.5" D x 27" H

30.5" W x
30.5" D x
27" H

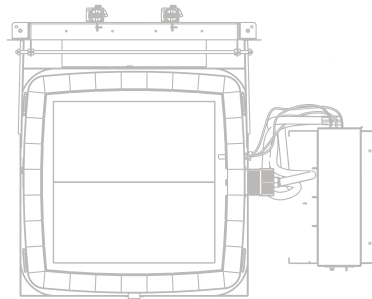

72 in



42.6 in



Large volume square kilns with adjustable height. DaVinci kilns are great for production and tiles. Includes arched sides for strength and counterbalanced lid.

- **Genesis Touch Screen Control** with Dynamic Zone Control
- **Cone 10 • 2350°F • 1290°C**
- **Counterbalanced Lid** with springs inside of tubes
- **Safety Latches for Lid**
- **Welded angle-iron powder-coated stand and hinge**
- **3" brick**
- **Type K Thermocouples (3)**
 - with protection tubes
- **Strong arched sides** with extra

space added to interior dimensions for good air circulation

- **Three elements per 9" section**
- **Ceramic Element Terminals**
- **Hard Ceramic Element Channels**
- **Plug in kiln sections** (except 480 volt models)
- **Floor mounted control panel**
- **c-MET-us listed to UL499 Standards**
- **See hotkilns.com/X3227 for all features and options**

GENERAL DIMENSIONS



Scan OR Visit:
hotkilns.com/X3227-GD



TRUST YOUR KILN
hotkilns.com

Manufactured in Swedesboro, NJ
800-750-8350 • sales@hotkilns.com

Bulletin No: BL-X3227 REV: 0

Page 1



USA

Standard Models							Powered Bottom Models				
Model Number	Part Number	Volt/Phase	Watts	Amps	Wire Size	Fuse Size	Part Number	Watts	Amps	Wire Size	Fuse Size
X3227-D-240	K-X-3227/31	240/1P	18,039	75.2	1 ga	100	K-X-322P/31	22,047	91.9	1/0	125
X3227-D-240-3P	K-X-3227/32	240/3P	18,039	43.4	6 ga	60	K-X-322P/32	22,047	58.5	3 ga	80
X3227-D-208	K-X-3227/21	208/1P	18,039	86.7	1 ga	110	K-X-322P/21	22,047	106.0	3/0	150
X3227-D-208-3P	K-X-3227/22	208/3P	18,039	50.1	4 ga	70	K-X-322P/22	22,047	67.4	2 ga	90
X3227-D-480-3P	K-X-3227/62	480/3P	18,039	21.7	10 ga	30	K-X-322P/62	22,047	28.9	8 ga	40
XB3227-D-240	K-X-322B/31	240/1P	21,294	88.7	1/0	125	K-X-322W/31	26,026	108.4	3/0	150
XB3227-D-240-3P	K-X-322B/32	240/3P	21,294	51.2	4 ga	70	K-X-322W/32	26,026	69.0	2 ga	90
XB3227-D-208	K-X-322B/21	208/1P	21,294	102.4	3/0	150	K-X-322W/21	26,026	125.1	4/0	175
XB3227-D-208-3P	K-X-322B/22	208/3P	21,294	59.1	3 ga	80	K-X-322W/22	26,026	79.6	1 ga	100
XB3227-D-480-3P	K-X-322B/62	480/3P	21,294	25.6	8 ga	40	K-X-322W/62	26,026	34.2	6 ga	50

WORLD

X3227-D-220	K-X-3227/41	220/1P	18,039	82.0	1 ga	110	K-X-322P/41	22,047	100.2	3/0	150
X3227-D-380-3PY	K-X-3227/52	380/3PY	18,039	27.3	8 ga	40	K-X-322P/52	22,047	45.5	6 ga	60
X3227-D-400-3PY	K-X-3227/82	400/3PY	18,039	26.1	8 ga	40	K-X-322P/82	22,047	43.6	6 ga	60
X3227-D-415-3PY	K-X-3227/72	415/3PY	18,039	25.1	8 ga	40	K-X-322P/72	22,047	41.7	6 ga	60
XB3227-D-220	K-X-3227/41	220/1P	21,294	96.8	1/0	125	K-X-322W/41	26,026	118.3	3/0	150
XB3227-D-380-3PY	K-X-3227/52	380/3PY	21,294	32.3	6 ga	50	K-X-322W/52	26,026	53.8	4 ga	70
XB3227-D-400-3PY	K-X-3227/82	400/3PY	21,294	30.9	8 ga	40	K-X-322W/82	26,026	51.4	4 ga	70
XB3227-D-415-3PY	K-X-3227/72	415/3PY	21,294	29.6	8 ga	40	K-X-322W/72	26,026	49.3	4 ga	70



Control: Full digital touchscreen Genesis control with easy-to-use interface, WiFi enabled app, and simple programs for firing ceramics or glass.

For Model Number of Powered Bottom Model: Add a "PB" after the "D" (Example = X3227-D-PB-240-1).



FURNITURE KIT FOR X3227

Part Number: H-X-K227/00

Includes: Six 28" X 14" rectangular shelves (3/4" thick), six each 1/2", 1", 2", 4", 6", and 8" square posts, and one pair heat resistant gloves.

UL Listing: c-MET-us listed.

Control Panels: Floor standing panel. NEMA 1 panel are recommended but not required for 480 volts.

XB MODELS: XB models have more power.

480 Volt Models with Quad Element Option: See website kiln pages for electrical specifications.

Crating: Comes fully crated. Easily disassembles for installation.

TRUST YOUR KILN
hotkilns.com

Manufactured in Swedesboro, NJ
800-750-8350 • sales@hotkilns.com

Bulletin No: BL-X3227 REV: 0

Page 2



X3236

Temperature Rating: Cone 10

Volume: 19.4 Cubic Feet

Brick Thickness: 3" Brick

Inside: 30.5" D x 36" H

30.5" W x
30.5" D x
36" H

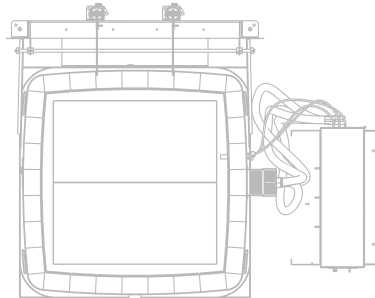

72 in



51.6 in



Large volume square kilns with adjustable height. DaVinci kilns are great for production and tiles. Includes arched sides for strength and counterbalanced lid.

- **Genesis Touch Screen Control** with Dynamic Zone Control
- **Cone 10 • 2350°F • 1290°C**
- **Counterbalanced Lid** with springs inside of tubes
- **Safety Latches for Lid**
- **Welded angle-iron powder-coated stand and hinge**
- **3" brick**
- **Type K Thermocouples (3)**
 - with protection tubes
- **Strong arched sides** with extra space added to interior dimensions for good air circulation
- **Three elements per 9" section**
- **Ceramic Element Terminals**
- **Hard Ceramic Element Channels**
- **Plug in kiln sections** (except 480 volt models)
- **Floor mounted control panel**
- **c-MET-us listed to UL499 Standards**
- **See hotkilns.com/x3236 for all features and options**

GENERAL DIMENSIONS

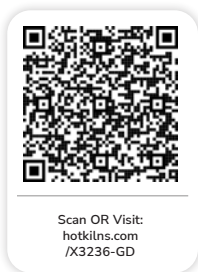

TRUST YOUR KILN
hotkilns.com

Manufactured in Swedesboro, NJ
800-750-8350 • sales@hotkilns.com

Bulletin No: BL-X3236 REV: 0

Page 1



USA

Standard Models							Powered Bottom Models				
Model Number	Part Number	Volt/Phase	Watts	Amps	Wire Size	Fuse Size	Part Number	Watts	Amps	Wire Size	Fuse Size
X3236-D-240	K-X-3236/31	240/1P	24,052	100.2	3/0	150	K-X-323P/31	28,060	116.9	3/0	150
X3236-D-240-3P	K-X-3236/32	240/3P	24,052	66.3	2 ga	90	K-X-323P/32	28,060	79.7	1 ga	100
X3236-D-208	K-X-3236/21	208/1P	24,052	115.6	3/0	150	K-X-323P/21	28,060	134.9	4/0	175
X3236-D-208-3P	K-X-3236/22	208/3P	24,052	76.5	1 ga	100	K-X-323P/22	28,060	91.9	1/0	125
X3236-D-480-3P	K-X-3236/62	480/3P	24,052	28.9	8 ga	40	K-X-323P/62	28,060	36.2	6 ga	50
XB3236-D-240	K-X-323B/31	240/1P	28,392	118.3	3/0	150	K-X-323W/31	33,124	138.0	4/0	175
XB3236-D-240-3P	K-X-323B/32	240/3P	28,392	78.2	1 ga	100	K-X-323W/32	33,124	94.0	1/0	125
XB3236-D-208	K-X-323B/21	208/1P	28,392	136.5	4/0	175	K-X-323W/21	33,124	159.3	250 mcm	200
XB3236-D-208-3P	K-X-323B/22	208/3P	28,392	90.3	1/0	125	K-X-323W/22	33,124	108.5	3/0	150
XB3236-D-480-3P	K-X-323B/62	480/3P	28,392	43.2	6 ga	50	K-X-323W/62	33,124	42.7	6 ga	60

WORLD

X3236-D-220	K-X-3236/41	220/1P	24,052	109.3	3/0	150	K-X-323P/41	28,060	127.5	4/0	175
X3236-D-380-3PY	K-X-3236/52	380/3PY	24,052	54.7	4 ga	70	K-X-323P/52	28,060	54.7	4 ga	70
X3236-D-400-3PY	K-X-3236/82	400/3PY	24,052	52.3	4 ga	70	K-X-323P/82	28,060	52.3	4 ga	70
X3236-D-415-3PY	K-X-3236/72	415/3PY	24,052	50.1	4 ga	70	K-X-323P/72	28,060	50.1	4 ga	70
XB3236-D-220	K-X-3236/41	220/1P	28,392	129.1	4/0	175	K-X-323W/41	31,124	150.6	250 mcm	200
XB3236-D-380-3PY	K-X-3236/52	380/3PY	28,392	64.5	2 ga	90	K-X-323W/52	31,124	64.5	2 ga	90
XB3236-D-400-3PY	K-X-3236/82	400/3PY	28,392	61.7	3 ga	80	K-X-323W/82	31,124	61.7	3 ga	80
XB3236-D-415-3PY	K-X-3236/72	415/3PY	28,392	59.2	3 ga	80	K-X-323W/72	31,124	59.2	3 ga	80



Control: Full digital touchscreen Genesis control with easy-to-use interface, WiFi enabled app, and simple programs for firing ceramics or glass.

For Model Number of Powered Bottom Model: Add a "PB" after the "D" (Example = X3227-D-PB-240-1).

UL Listing: c-MET-us listed.



FURNITURE KIT FOR X3236

Part Number: H-X-K236/00

Includes: Eight 28" X 14" rectangular shelves (3/4" thick), twelve each 1/2", 1", 2", 4", 6", and 8" square posts, and one pair heat resistant gloves.

Control Panels: Floor standing panel. NEMA 1 panel are recommended but not required for 480 volts.

XB MODELS: XB models have more power.

480 Volt Models with Quad Element Option: See website kiln pages for electrical specifications.

Crating: Comes fully crated. Easily disassembles for installation.

TRUST YOUR KILN
hotkilns.com

Manufactured in Swedesboro, NJ
800-750-8350 • sales@hotkilns.com

Bulletin No: BL-X3236 REV: 0

Page 2



X3245

Temperature Rating: Cone 10

Volume: 24.2 Cubic Feet

Brick Thickness: 3" Brick

Inside: 30.5" D x 45" H

30.5" W x
30.5" D x
45" H

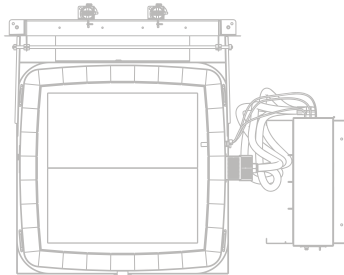

72 in



60.6 in



Large volume square kilns with adjustable height. DaVinci kilns are great for production and tiles. Includes arched sides for strength and counterbalanced lid.

- **Genesis Touch Screen Control** with Dynamic Zone Control
- **Cone 10 • 2350°F • 1290°C**
- **Counterbalanced Lid** with springs inside of tubes
- **Safety Latches for Lid**
- **Welded angle-iron powder-coated stand and hinge**
- **3" brick**
- **Type K Thermocouples (3)**
 - with protection tubes
- **Strong arched sides** with extra space added to interior dimensions for good air circulation
- **Three elements per 9" section**
- **Ceramic Element Terminals**
- **Hard Ceramic Element Channels**
- **Plug in kiln sections** (except 480 volt models)
- **Floor mounted control panel**
- **c-MET-us listed to UL499 Standards**
- **See hotkilns.com/x3245 for all features and options**

GENERAL DIMENSIONS

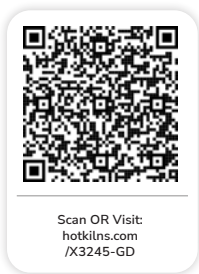

TRUST YOUR KILN
hotkilns.com

Manufactured in Swedesboro, NJ
800-750-8350 • sales@hotkilns.com

Bulletin No: BL-X3245 REV: 0

Page 1



Electrical Specifications for X3245

DaVinci Top-Loading Kilns

USA

Standard Models							Powered Bottom Models				
Model Number	Part Number	Volt/Phase	Watts	Amps	Wire Size	Fuse Size	Part Number	Watts	Amps	Wire Size	Fuse Size
X3245-D-240	K-X-3245/31	240/1P	30,065	125.3	4/0	175	K-X-324P/31	34,074	142.0	250 mcm	200
X3245-D-240-3P	K-X-3245/32	240/3P	30,065	86.8	1 ga	110	K-X-324P/32	34,074	86.8	1 ga	110
X3245-D-208	K-X-3245/21	208/1P	30,065	144.5	250 mcm	200	K-X-324P/21	34,074	163.8	300 mcm	225
X3245-D-208-3P	K-X-3245/22	208/3P	30,065	100.1	3/0	150	K-X-324P/22	34,074	100.2	3/0	150
X3245-D-480-3P	K-X-3245/62	480/3P	30,065	36.2	6 ga	50	K-X-324P/62	34,074	43.4	6 ga	60
XB3245-D-240	K-X-324B/31	240/1P	35,490	147.9	250 mcm	200	K-X-324W/31	40,222	167.6	300 mcm	225
XB3245-D-240-3P	K-X-324B/32	240/3P	35,490	102.5	3/0	150	K-X-2-84W/32	40,222	102.5	3/0	150
XB3245-D-208	K-X-324B/21	208/1P	35,490	170.6	300 mcm	225	K-X-324W/21	40,222	193.4	350 mcm	250
XB3245-D-208-3P	K-X-324B/22	208/3P	35,490	118.2	3/0	150	K-X-324W/22	40,222	118.2	3/0	150
XB3245-D-480-3P	K-X-324B/62	480/3P	35,490	42.7	6 ga	60	K-X-324W/62	40,222	51.3	4 ga	70

WORLD

X3245-D-220	K-X-3245/41	220/1P	30,065	136.7	4/0	175	K-X324P/41	34,074	154.9	250 mcm	200
X3245-D-380-3PY	K-X-3245/52	380/3PY	30,065	54.7	4 ga	70	K-X324P/52	34,074	54.7	4 ga	70
X3245-D-400-3PY	K-X3245/82	400/3PY	30,065	52.3	4 ga	70	K-X324P/82	34,074	52.3	4 ga	70
X3245-D-415-3PY	K-X3245/72	415/3PY	30,065	50.1	4 ga	70	K-X324P/72	34,074	50.1	4 ga	70
XB3245-D-220	K-X3245/41	220/1P	35,490	161.3	300 mcm	225	K-X324W/41	40,222	182.8	350 mcm	250
XB3245-D-380-3PY	K-X3245/52	380/3PY	35,490	64.5	2 ga	90	K-X324W/52	40,222	64.5	2 ga	90
XB3245-D-400-3PY	K-X3245/82	400/3PY	35,490	61.7	3 ga	80	K-X324W/82	40,222	61.7	2 ga	80
XB3245-D-415-3PY	K-X3245/72	415/3PY	35,490	59.2	3 ga	80	K-X324W/72	40,222	59.2	3 ga	80



Control: Full digital touchscreen Genesis control with easy-to-use interface, WiFi enabled app, and simple programs for firing ceramics or glass.

For Model Number of Powered Bottom Model: Add a "PB" after the "D" (Example = X3227-D-PB-240-1).



FURNITURE KIT FOR X3245

Part Number: H-X-K245/00

Includes: Ten 28" x 14" rectangular shelves (3/4" thick), twelve each 1/2", 1", 2", 4", 6", and 8" square posts, and one pair heat resistant gloves.

UL Listing: c-MET-us listed.

Control Panels: Floor standing panel. NEMA 1 panel are recommended but not required for 480 volts.

XB MODELS: XB models have more power.

480 Volt Models with Quad Element Option: See website kiln pages for electrical specifications.

Crating: Comes fully crated. Easily disassembles for installation.

TRUST YOUR KILN
hotkilns.com

Manufactured in Swedesboro, NJ
800-750-8350 • sales@hotkilns.com

Bulletin No: BL-X3245 REV: 0

Page 2

