



SAR TEST REPORT

For

Shanghai SmartPeak Technology Co.,Ltd.

POS Terminal

Test Model:P600

Additional Model No.: P600 Countertop

Prepared for : Shanghai SmartPeak Technology Co.,Ltd.
Address : Room 1, No.3 Building, NO.295, Qianqiao Road, Fengxian District, Shanghai, China

Prepared by : Shenzhen LCS Compliance Testing Laboratory Ltd.
Address : 101, 201 Bldg A & 301 Bldg C, Juji Industrial Park
Yabianxueziwei, Shajing Street, Baoan District, Shenzhen, 518000, China
Tel : (86)755-82591330
Fax : (86)755-82591332
Web : www.LCS-cert.com
Mail : webmaster@LCS-cert.com

Date of receipt of test sample : December 10, 2022
Number of tested samples : 2
Sample No. : A120822082-1, A120822082-2
Serial number : Prototype
Date of Test : December 10, 2022~January 03, 2023
Date of Report : January 03, 2023





SAR TEST REPORT

Report Reference No. : **LCSA120822082EB**

Date Of Issue : January 03, 2023

Testing Laboratory Name : **Shenzhen LCS Compliance Testing Laboratory Ltd.**

Address : 101, 201 Bldg A & 301 Bldg C, Juji Industrial Park Yabianxueziwei, Shajing Street, Baoan District, Shenzhen, 518000, China

Applicant's Name : **Shanghai SmartPeak Technology Co.,Ltd.**

Address : Room 1, No.3 Building, NO.295, Qianqiao Road, Fengxian District, Shanghai, China

Test Specification:

Standard : IEEE Std C95.1, 2019/ IEEE Std 1528™-2013/FCC Part 2.1093

Test Report Form No. : LCSEMC-1.0

TRF Originator : Shenzhen LCS Compliance Testing Laboratory Ltd.

Master TRF : Dated 2011-03

Shenzhen LCS Compliance Testing Laboratory Ltd. All rights reserved.

This publication may be reproduced in whole or in part for non-commercial purposes as long as the Shenzhen LCS Compliance Testing Laboratory Ltd. is acknowledged as copyright owner and source of the material. Shenzhen LCS Compliance Testing Laboratory Ltd. takes no responsibility for and will not assume liability for damages resulting from the reader's interpretation of the reproduced material due to its placement and context.

Test Item Description : **POS Terminal**

Trade Mark : SmartPeak

Model/Type Reference : P600

Operation Frequency : GSM 850,1900;WCDMA II,V;
LTE2,4,7;WLAN2.4G and Bluetooth4.1.

Ratings : Input: 5V---2A
For Adapter Input: 100-240V~, 50/60Hz, 0.40A
For Adapter Output: 5.0V---2.0A, 10.0W
DC 7.4V by Rechargeable Li-ion Battery, 2600mAh

Result : **Positive**

Compiled by:

Jay zhan

Jay Zhan/ File administrators

Supervised by:

Cary Luo

Cary Luo/ Technique principal

Approved by:

Gavin Liang

Gavin Liang/ Manager





SAR -- TEST REPORT

Test Report No. :	LCSA120822082EB	<u>January 03, 2023</u> Date of issue
--------------------------	------------------------	--

Type / Model.....	: P600
EUT.....	: POS Terminal
Applicant.....	: Shanghai SmartPeak Technology Co.,Ltd.
Address.....	: Room 1, No.3 Building, NO.295, Qianqiao Road, Fengxian District, Shanghai, China
Telephone.....	: /
Fax.....	: /
Manufacturer.....	: Shanghai SmartPeak Technology Co.,Ltd.
Address.....	: Room 1, No.3 Building, NO.295, Qianqiao Road, Fengxian District, Shanghai, China
Telephone.....	: /
Fax.....	: /
Factory.....	: Shanghai SmartPeak Technology Co.,Ltd.
Address.....	: Room 1, No.3 Building, NO.295, Qianqiao Road, Fengxian District, Shanghai, China
Telephone.....	: /
Fax.....	: /

Test Result	Positive
--------------------	-----------------

The test report merely corresponds to the test sample.
 It is not permitted to copy extracts of these test result without the written permission of the test laboratory.





Revision History

Revision	Issue Date	Revision Content	Revised By
000	January 03, 2023	Initial Issue	





TABLE OF CONTENTS

1. TEST STANDARDS AND TEST DESCRIPTION.....6

1.1. TEST STANDARDS6

1.2. TEST DESCRIPTION.....6

1.3. GENERAL REMARKS6

1.4. PRODUCT DESCRIPTION6

1.5. STATEMENT OF COMPLIANCE8

2. TEST ENVIRONMENT9

2.1. TEST FACILITY9

2.2. ENVIRONMENTAL CONDITIONS9

2.3. SAR LIMITS9

2.4. EQUIPMENTS USED DURING THE TEST10

3. SAR MEASUREMENTS SYSTEM CONFIGURATION11

3.1. SARMEASUREMENT SET-UP.....11

3.2. OPENSAR E-FIELD PROBE SYSTEM.....12

3.3. PHANTOMS.....13

3.4. DEVICE HOLDER13

3.5. SCANNING PROCEDURE14

3.6. DATA STORAGE AND EVALUATION.....16

3.7. TISSUE DIELECTRIC PARAMETERS FOR HEAD AND BODY PHANTOMS18

3.8. TISSUE EQUIVALENT LIQUID PROPERTIES18

3.9. SYSTEM CHECK19

3.10. SAR MEASUREMENT PROCEDURE22

3.11. POWER REDUCTION27

3.12. POWER DRIFT27

4. TEST CONDITIONS AND RESULTS28

4.1. CONDUCTED POWER RESULTS28

4.2. TRANSMIT ANTENNAS AND SAR MEASUREMENT POSITION39

4.3. SAR MEASUREMENT RESULTS40

4.4. SIMULTANEOUS TX SAR CONSIDERATIONS43

4.5. SAR MEASUREMENT VARIABILITY45

4.6. GENERAL DESCRIPTION OF TEST PROCEDURES46

4.7. MEASUREMENT UNCERTAINTY (450MHZ-6GHZ)46

4.8. SYSTEM CHECK RESULTS47

4.9. SAR TEST GRAPH RESULTS.....52

5. CALIBRATION CERTIFICATES60

5.1 PROBE-EPGO376 CALIBRATION CERTIFICATE.....60

5.2 SID835DIPOLE CALIBRATION CERITICATE.....71

5.3 SID1800 DIPOLE CALIBRATION CERTIFICATE82

5.4 SID1900 DIPOLE CALIBRATION CERTIFICATE93

5.5 SID2450 DIPOLE CALIBRATION CERTIFICATE.....104

5.6 SID2600 DIPOLE CALIBRATION CERITICATE.....115

6. PHOTOGRAPHS OF THE LIQUID126

7. PHOTOGRAPHS OF THE TEST129

8. EUT PHOTOGRAPHS130





1. TEST STANDARDS AND TEST DESCRIPTION

1.1. Test Standards

- [IEEE Std C95.1-2019](#): IEEE Standard for Safety Levels with Respect to Human Exposure to Electric, Magnetic, and Electromagnetic Fields, 0 Hz to 300 GHz. It specifies the maximum exposure limit of 1.6 W/kg as averaged over any 1 gram of tissue for portable devices being used within 20 cm of the user in the uncontrolled environment.
- [IEEE Std 1528™-2013](#): IEEE Recommended Practice for Determining the Peak Spatial-Average Specific Absorption Rate (SAR) in the Human Head from Wireless Communications Devices: Measurement Techniques.
- [FCC Part 2.1093 Radiofrequency Radiation Exposure Evaluation: Portable Devices](#)
- [KDB447498 D01 General RF Exposure Guidance v06](#) : Mobile and Portable Device RF Exposure Procedures and Equipment Authorization Policies
- [KDB447498 D02 SAR Procedures for Dongle Xmtr v02r01](#): SAR Measurement Procedures For USB Dongle Transmitters.
- [KDB865664 D01 SAR Measurement 100 MHz to 6 GHz v01r04](#) : SAR Measurement Requirements for 100 MHz to 6 GHz
- [KDB865664 D02 RF Exposure Reporting v01r02](#): RF Exposure Compliance Reporting and Documentation Considerations
- [KDB 248227 D01 802.11 Wi-Fi SAR v02r02](#): SAR GUIDANCE FOR IEEE 802.11 (Wi-Fi) TRANSMITTERS
- [KDB941225 D01 3G SAR Procedures](#): 3G SAR MEAUREMENT PROCEDURES
- [KDB 941225 D05 SAR for LTE Devices](#): SAR Evaluation Considerations For LTE Devices

1.2. Test Description

The EUT battery must be fully charged and checked periodically during the test to ascertain uniform power . And Test device is identical prototype.

1.3. General Remarks

Date of receipt of test sample	:	December 10, 2022
Testing commenced on	:	December 10, 2022
Testing concluded on	:	January 03, 2023

1.4. Product Description

The Shanghai SmartPeak Technology Co.,Ltd.'s Model: P600 or the "EUT" as referred to in this report; more general information as follows, for more details, refer to the user's manual of the EUT.

General Description	
EUT :	POS Terminal
Model/Type reference:	P600
Additional Model No.	P600 Countertop
Model Declaration:	PCB board, structure and internal of these model(s) are the same, So no additional models were tested
Hardware Version	/
Firmware Version:	V0.70.7506
Power supply:	Input: 5V $\overline{\text{---}}$ 2A For Adapter Input: 100-240V~, 50/60Hz, 0.40A For Adapter Output: 5.0V $\overline{\text{---}}$ 2.0A, 10.0W DC 7.4V by Rechargeable Li-ion Battery, 2600mAh
<i>The EUT is POS Terminal. the POS Terminal is intended for WLAN transmission. It is equipped with WiFi2.4G; GSM 850,1900; WCDMA Band II,Band V; LTE 2,4,7. For more information see the following datasheet</i>	





Technical Characteristics	
LTE	
Operation Band:	<input checked="" type="checkbox"/> E-UTRA Band 2(U.S.-Band) <input checked="" type="checkbox"/> E-UTRA Band 4(U.S.-Band) <input checked="" type="checkbox"/> E-UTRA Band 7(U.S.-Band)
Modulation Type:	QPSK/16QAM
Release Version:	R9
Power Class:	Class 3
Antenna Description:	PIFA Antenna 0.5dBi (max.) For E-UTRA Band 2 0.5dBi (max.) For E-UTRA Band 4 0.5dBi (max.) For E-UTRA Band 7
Bluetooth	
Frequency Range:	2402MHz ~ 2480MHz
Chanel Number:	79 channels for Bluetooth V4.1(DSS) 40 channels for Bluetooth V4.1 (DTS)
Chanel Spacing:	1MHz for Bluetooth V4.1 (DSS) 2MHz for Bluetooth V4.1 (DTS)
Modulation Type;	GFSK, $\pi/4$ -DQPSK, 8-DPSK for Bluetooth V4.1(DSS) GFSK for Bluetooth V4.1 (DTS)
Bluetooth Version:	V4.1
Antenna Description:	PIFA Antenna, 0.5dBi(Max.)
WIFI 2.4G	
Frequency Range:	2412MHz-2462MHz
Type of Modulation:	IEEE 802.11b: DSSS (CCK, DQPSK, DBPSK) IEEE 802.11g: OFDM (64QAM, 16QAM, QPSK, BPSK) IEEE 802.11n: OFDM (64QAM, 16QAM, QPSK, BPSK)
Channel number:	11 Channels for 20MHz bandwidth (2412~2462MHz)
Channel separation:	5MHz
Antenna Description:	PIFA Antenna, 0.5dBi(Max.)
UMTS	
Operation Band:	<input checked="" type="checkbox"/> WCDMA Band II (U.S.-Band) <input checked="" type="checkbox"/> WCDMA Band V (U.S.-Band) <input type="checkbox"/> WCDMA Band IV (U.S.-Band) <input type="checkbox"/> WCDMA Band I (EU-Band) <input type="checkbox"/> WCDMA Band VIII (EU-Band)
Modulation Type:	QPSK,16QAM
WCDMA Release Version:	R9
Antenna Description:	PIFA Antenna 0.5dBi (max.) For WCDMA Band II 0.5dBi (max.) For WCDMA Band V
GSM	
Support Band:	<input type="checkbox"/> GSM 900 (EU-Band) <input type="checkbox"/> DCS 1800 (EU-Band) <input checked="" type="checkbox"/> GSM 850 (U.S.-Band) <input checked="" type="checkbox"/> PCS 1900 (U.S.-Band)
Release Version:	R99
GPRS Class	Class 12
EGPRS Class	Class 12
Modulation Type:	GMSK for GSM/GPRS; GMSK/8PSK for EGPRS
Antenna Description:	PIFA Antenna 0.5dBi (max.) For GSM 850 1.0dBi (max.) For PCS 1900
GPS function	Support and only RX
NFC	
Operating Frequency	13.56MHz
Modulation Type	ASK
Antenna Description	Internal, 0.5dBi(Max.)



Shenzhen LCS Compliance Testing Laboratory Ltd.

Add: 101, 201 Bldg A & 301 Bldg C, Juji Industrial Park Yabianxueziwei, Shajing Street, Baoan District, Shenzhen, 518000, China

Tel: +(86) 0755-82591330 | E-mail: webmaster@lcs-cert.com | Web: www.lcs-cert.com

Scan code to check authenticity



1.5. Statement of Compliance

The maximum of results of SAR found during testing for P600 are follows:

<Highest Reported standalone SAR Summary>

Classment Class	Frequency Band	Hotspot (Report SAR _{1-g} (W/kg)	Body-worn (Report SAR _{1-g} (W/kg)
		(Separation Distance 10mm)	
PCB	GSM 850	0.291	0.291
	GSM1900	0.138	0.138
	WCDMA Band V	0.321	0.321
	WCDMA Band II	0.191	0.191
	LTE band 2	0.179	0.179
	LTE band 4	0.521	0.521
DTS	WIFI2.4G	0.271	0.271
		0.080	0.080

This device is in compliance with Specific Absorption Rate (SAR) for general population/uncontrolled exposure limits (1.6 W/kg) specified in FCC 47 CFR part 2 (2.1093) and ANSI/IEEE C95.1-2019, and had been tested in accordance with the measurement methods and procedures specified in IEEE 1528-2013.

<Highest Reported simultaneous SAR Summary>

Exposure Position	Classment Class	Highest Reported Simultaneous Transmission SAR _{1-g} (W/kg)
Body-worn (hotspot open)	PCB	0.601
	DTS	





2. TEST ENVIRONMENT

2.1. Test Facility

The test facility is recognized, certified, or accredited by the following organizations:

Site Description
EMC Lab.

: NVLAP Accreditation Code is 600167-0.
FCC Designation Number is CN5024.
CAB identifier is CN0071.
CNAS Registration Number is L4595.
Test Firm Registration Number: 254912.

2.2. Environmental conditions

During the measurement the environmental conditions were within the listed ranges:

Temperature:	18-25 ° C
Humidity:	40-65 %
Atmospheric pressure:	950-1050mbar

2.3. SAR Limits

FCC Limit (1g Tissue)

EXPOSURE LIMITS	SAR (W/kg)	
	(General Population / Uncontrolled Exposure Environment)	(Occupational / Controlled Exposure Environment)
Spatial Average(averaged over the whole body)	0.08	0.4
Spatial Peak(averaged over any 1 g of tissue)	1.6	8.0
Spatial Peak(hands/wrists/ feet/anklesaveraged over 10 g)	4.0	20.0

Population/Uncontrolled Environments are defined as locations where there is the exposure of individual who have no knowledge or control of their exposure.

Occupational/Controlled Environments are defined as locations where there is exposure that may be incurred by people who are aware of the potential for exposure (i.e. as a result of employment or occupation).



Shenzhen LCS Compliance Testing Laboratory Ltd.

Add: 101, 201 Bldg A & 301 Bldg C, Juji Industrial Park Yabianxueziwei, Shajing Street, Baoan District, Shenzhen, 518000, China

Tel: +(86) 0755-82591330 | E-mail: webmaster@lcs-cert.com | Web: www.lcs-cert.com

Scan code to check authenticity



2.4. Equipments Used during the Test

Item	Equipment	Manufacturer	Model No.	Serial No.	Cal Date	Due Date
1	PC	Lenovo	G5005	MY42081102	N/A	N/A
2	SAR Measurement system	SATIMO	4014_01	SAR_4014_01	N/A	N/A
3	Signal Generator	Agilent	E4438C	MY49072627	2022-06-16	2023-06-15
4	S-parameter Network Analyzer	Agilent	8753ES	US38432944	2022-06-16	2023-06-15
5	Wideband Radio Communication Tester	R&S	CMW500	103818-1	2022-06-16	2023-06-15
6	E-Field PROBE	MVG	SSE2	SN 25/22 EPGO376	2022-06-29	2023-06-28
7	DIPOLE 835	SATIMO	SID 835	SN 07/14 DIP 0G835-303	2021-09-29	2024-09-28
8	DIPOLE 1800	SATIMO	SID 1800	SN 07/14 DIP 1G800-301	2021-09-29	2024-09-28
9	DIPOLE 1900	SATIMO	SID 1900	SN 38/18 DIP 1G900-466	2021-09-22	2024-09-21
10	DIPOLE 2450	SATIMO	SID 2450	SN 07/14 DIP 2G450-306	2021-09-29	2024-09-28
11	DIPOLE 2600	SATIMO	SID 2600	SN 38/18 DIP 2G600-468	2021-09-22	2024-09-21
12	COMOSAR OPENCoaxial Probe	SATIMO	OCPG 68	SN 40/14 OCPG68	2022-10-29	2023-10-28
13	SAR Locator	SATIMO	VPS51	SN 40/14 VPS51	2022-10-29	2023-10-28
14	Communication Antenna	SATIMO	ANTA57	SN 39/14 ANTA57	2022-10-29	2023-10-28
15	FEATURE PHONEPOSITIONING DEVICE	SATIMO	MSH98	SN 40/14 MSH98	N/A	N/A
16	DUMMY PROBE	SATIMO	DP60	SN 03/14 DP60	N/A	N/A
17	SAM PHANTOM	SATIMO	SAM117	SN 40/14 SAM117	N/A	N/A
18	Liquid measurement Kit	HP	85033D	3423A03482	N/A	N/A
19	Power meter	Agilent	E4419B	MY45104493	2022-10-29	2023-10-28
20	Power meter	Agilent	E4419B	MY45100308	2022-10-29	2023-10-28
21	Power sensor	Agilent	E9301H	MY41495616	2022-10-29	2023-10-28
22	Power sensor	Agilent	E9301H	MY41495234	2022-10-29	2023-10-28
23	Directional Coupler	MCLI/USA	4426-20	03746	2022-06-16	2023-06-15

Note:

- 1) Per KDB865664D01 requirements for dipole calibration, the test laboratory has adopted three year extended calibration interval. Each measured dipole is expected to evaluate with following criteria at least on annual interval.
 - a) There is no physical damage on the dipole;
 - b) System check with specific dipole is within 10% of calibrated values;
 - c) The most recent return-loss results, measured at least annually, deviates by no more than 20% from the previous measurement;
 - d) The most recent measurement of the real or imaginary parts of the impedance, measured at least annually is within 5Ω from the previous measurement.
- 2) Network analyzer probe calibration against air, distilled water and a shorting block performed before measuring liquid parameters.



Shenzhen LCS Compliance Testing Laboratory Ltd.

Add: 101, 201 Bldg A & 301 Bldg C, Juji Industrial Park Yabianxueziwei, Shajing Street, Baoan District, Shenzhen, 518000, China

Tel: +(86) 0755-82591330 | E-mail: webmaster@lcs-cert.com | Web: www.lcs-cert.com

Scan code to check authenticity

3. SAR MEASUREMENTS SYSTEM CONFIGURATION

3.1. SAR Measurement Set-up

The OPENSAR system for performing compliance tests consist of the following items:

A standard high precision 6-axis robot (KUKA) with controller and software.

KUKA Control Panel (KCP)

A dosimetric probe, i.e., an isotropic E-field probe optimized and calibrated for usage in tissue simulating liquid. The probe is equipped with a Video Positioning System(VPS).

The stress sensor is composed with mechanical and electronic when the electronic part detects a change on the electro-mechanical switch,It sends an "Emergency signal" to the robot controller that to stop robot's moves

A computer operating Windows XP.

OPENSAR software

Remote control with teaches pendant and additional circuitry for robot safety such as warning lamps, etc.

The SAM phantom enabling testing left-hand right-hand and body usage.

The Position device for handheld EUT

Tissue simulating liquid mixed according to the given recipes.

System validation dipoles to validate the proper functioning of the system.

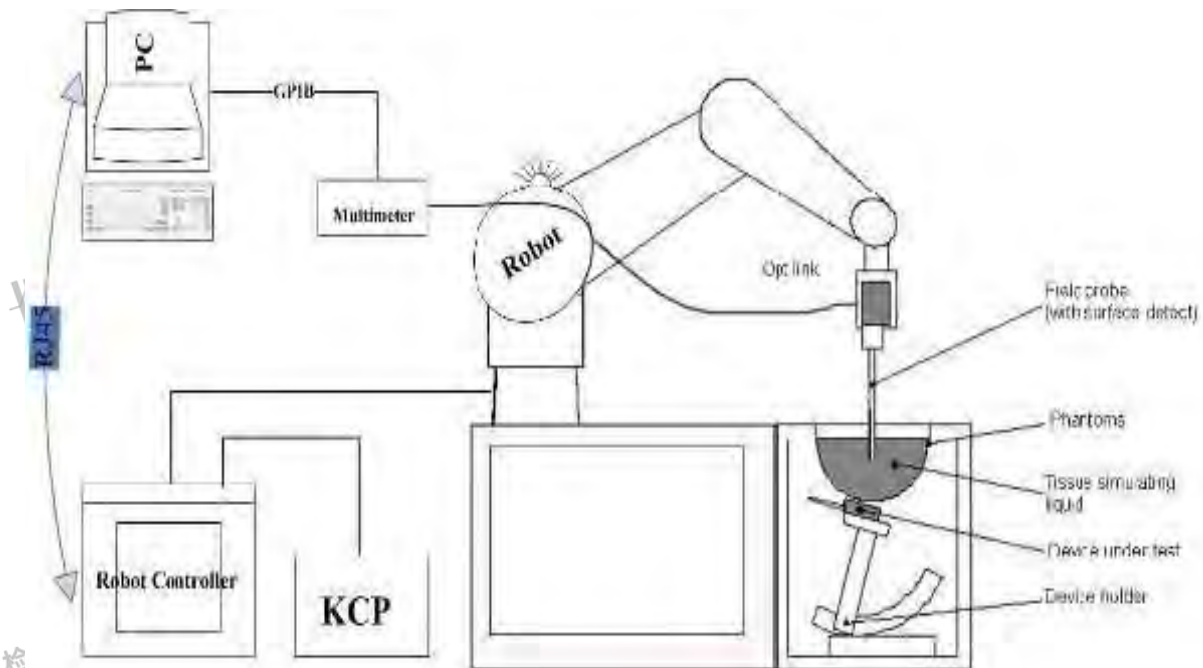



3.2. OPENSAR E-field Probe System

The SAR measurements were conducted with the dosimetric probe EPGO376 (manufactured by MVG), designed in the classical triangular configuration and optimized for dosimetric evaluation.

Probe Specification

Construction Symmetrical design with triangular core
 Interleaved sensors
 Built-in shielding against static charges
 PEEK enclosure material (resistant to organic solvents, e.g., DGBE)

Calibration ISO/IEC 17025 calibration service available.

Frequency	450 MHz to 6 GHz; Linearity: 0.25dB(450 MHz to 6 GHz)
Directivity	0.25 dB in HSL (rotation around probe axis) 0.5 dB in tissue material (rotation normal to probe axis)
Dynamic Range	0.01W/kg to > 100 W/kg; Linearity: 0.25 dB
Dimensions	Overall length: 330 mm (Tip: 16mm) Tip diameter: 5 mm (Body: 8 mm) Distance from probe tip to sensor centers: 2.5 mm
Application	General dosimetry up to 6 GHz Dosimetry in strong gradient fields Compliance tests of Mobile Phones

Isotropic E-Field Probe

The isotropic E-Field probe has been fully calibrated and assessed for isotropicity, and boundary effect within a controlled environment. Depending on the frequency for which the probe is calibrated the method utilized for calibration will change.

The E-Field probe utilizes a triangular sensor arrangement as detailed in the diagram below:

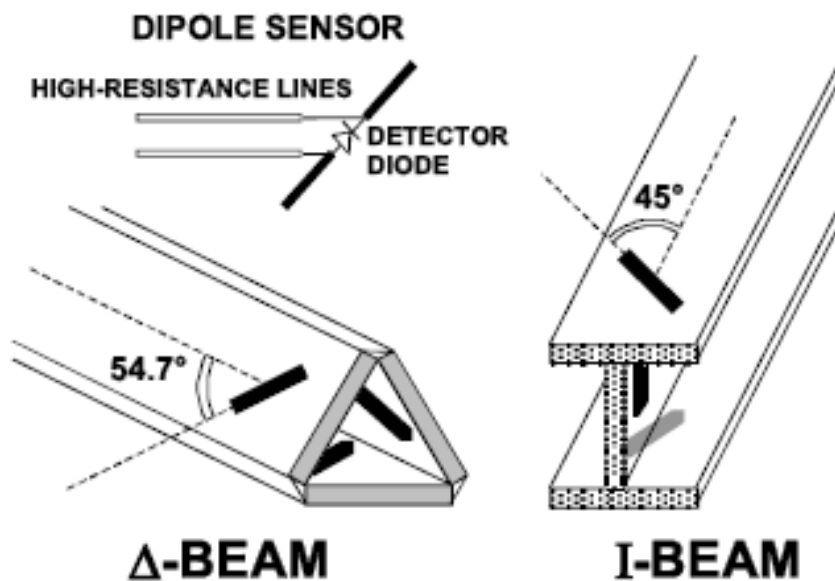

3.3. Phantoms

The SAM Phantom SAM117 is constructed of a fiberglass shell integrated in a wooden table. The shape of the shell is in compliance with the specification set in IEEE 1528 and EN62209-1, EN62209-2. The phantom enables the dosimetric evaluation of left and right hand phone usage as well as body mounted usage at the flat phantom region. A cover prevents the evaporation of the liquid. Reference markings on the Phantom allow the complete setup of all predefined phantom positions and measurement grids by manually teaching three points in the robot.

System checking was performed using the flat section, whilst Head SAR tests used the left and right head profile sections. Body SAR testing also used the flat section between the head profiles.



SAM Twin Phantom

3.4. Device Holder

In combination with the Generic Twin Phantom SAM117, the Mounting Device enables the rotation of the mounted transmitter in spherical coordinates whereby the rotation points is the ear opening. The devices can be easily, accurately, and repeatedly positioned according to the FCC specifications. The device holder can be locked at different phantom locations (left head, right head, flat phantom).





Device holder supplied by SATIMO

3.5. Scanning Procedure

The procedure for assessing the peak spatial-average SAR value consists of the following steps

Power Reference Measurement

The reference and drift jobs are useful jobs for monitoring the power drift of the device under test in the batch process. Both jobs measure the field at a specified reference position, at a selectable distance from the phantom surface. The reference position can be either the selected section's grid reference point or a user point in this section. The reference job projects the selected point onto the phantom surface, orients the probe perpendicularly to the surface, and approaches the surface using the selected detection method.

Area Scan

The Area Scan is used as a fast scan in two dimensions to find the area of high field values before running a detailed measurement around the hot spot. Before starting the area scan a grid spacing of 15 mm x 15 mm is set. During the scan the distance of the probe to the phantom remains unchanged. After finishing area scan, the field maxima within a range of 2 dB will be ascertained.

	≤ 3 GHz	> 3 GHz
Maximum distance from closest measurement point (geometric center of probe sensors) to phantom surface	5 mm ± 1 mm	$\frac{1}{2} \cdot \delta \cdot \ln(2)$ mm ± 0.5 mm
Maximum probe angle from probe axis to phantom surface normal at the measurement location	30° ± 1°	20° ± 1°
Maximum area scan spatial resolution: Δx_{Area} , Δy_{Area}	≤ 2 GHz: ≤ 15 mm 2 – 3 GHz: ≤ 12 mm	3 – 4 GHz: ≤ 12 mm 4 – 6 GHz: ≤ 10 mm
	When the x or y dimension of the test device, in the measurement plane orientation, is smaller than the above, the measurement resolution must be ≤ the corresponding x or y dimension of the test device with at least one measurement point on the test device.	

Zoom Scan

Zoom Scans are used to estimate the peak spatial SAR values within a cubic averaging volume containing 1 g and 10 g of simulated tissue. The default Zoom Scan is done by 7x7x7 points within a cube whose base is centered around the maxima found in the preceding area scan.





股份
ng Lab

Maximum zoom scan spatial resolution: $\Delta x_{Zoom}, \Delta y_{Zoom}$		≤ 2 GHz: ≤ 8 mm $2 - 3$ GHz: ≤ 5 mm*	$3 - 4$ GHz: ≤ 5 mm* $4 - 6$ GHz: ≤ 4 mm*
Maximum zoom scan spatial resolution, normal to phantom surface	uniform grid: $\Delta z_{Zoom}(n)$	≤ 5 mm	$3 - 4$ GHz: ≤ 4 mm $4 - 5$ GHz: ≤ 3 mm $5 - 6$ GHz: ≤ 2 mm
	graded grid	$\Delta z_{Zoom}(1)$: between 1 st two points closest to phantom surface	≤ 4 mm
		$\Delta z_{Zoom}(n>1)$: between subsequent points	$\leq 1.5 \cdot \Delta z_{Zoom}(n-1)$ mm
Minimum zoom scan volume	x, y, z	≥ 30 mm	$3 - 4$ GHz: ≥ 28 mm $4 - 5$ GHz: ≥ 25 mm $5 - 6$ GHz: ≥ 22 mm
<p>Note: δ is the penetration depth of a plane-wave at normal incidence to the tissue medium; see IEEE Std 1528-2013 for details.</p> <p>* When zoom scan is required and the <i>reported SAR</i> from the <i>area scan based 1-g SAR estimation</i> procedures of KDB Publication 447498 is ≤ 1.4 W/kg, ≤ 8 mm, ≤ 7 mm and ≤ 5 mm zoom scan resolution may be applied, respectively, for 2 GHz to 3 GHz, 3 GHz to 4 GHz and 4 GHz to 6 GHz.</p>			





E – fieldprobes :
$$E_i = \sqrt{\frac{V_i}{Norm_i \cdot ConvF}}$$

H – fieldprobes :
$$H_i = \sqrt{V_i \cdot \frac{a_{i0} + a_{i1}f + a_{i2}f^2}{f}}$$

 (i = x, y, z)
 (i = x, y, z)

- With
- V_i = compensated signal of channel i
 - $Norm_i$ = sensor sensitivity of channel i [mV/(V/m)²] for E-field Probes
 - $ConvF$ = sensitivity enhancement in solution
 - a_{ij} = sensor sensitivity factors for H-field probes
 - f = carrier frequency [GHz]
 - E_i = electric field strength of channel i in V/m
 - H_i = magnetic field strength of channel i in A/m

The RSS value of the field components gives the total field strength (Hermitian magnitude):

$$E_{tot} = \sqrt{E_x^2 + E_y^2 + E_z^2}$$

The primary field data are used to calculate the derived field units.

$$SAR = E_{tot}^2 \cdot \frac{\sigma}{\rho \cdot 1'000}$$

- with
- SAR = local specific absorption rate in mW/g
 - E_{tot} = total field strength in V/m
 - σ = conductivity in [mho/m] or [Siemens/m]
 - ρ = equivalent tissue density in g/cm³

Note that the density is normally set to 1 (or 1.06), to account for actual brain density rather than the density of the simulation liquid.





3.7. Tissue Dielectric Parameters for Head and Body Phantoms

The liquid is consisted of water, salt, Glycol, Sugar, Preventol and Cellulose. The liquid has previously been proven to be suited for worst-case. It's satisfying the latest tissue dielectric parameters requirements proposed by the KDB865664.

The composition of the tissue simulating liquid

Frequency (MHz)	Bactericide	DGBE	HEC	NaCl	Sucrose	1,2-Propanediol	X100	Water	Conductivity	Permittivity
	%	%	%	%	%	%	%	%	σ	ϵ_r
750	/	/	/	0.79	/	64.81	/	34.40	0.97	41.8
835	/	/	/	0.79	/	64.81	/	34.40	0.97	41.8
900	/	/	/	0.79	/	64.81	/	34.40	0.97	41.8
1800	/	13.84	/	0.35	/	/	30.45	55.36	1.38	41.0
1900	/	13.84	/	0.35	/	/	30.45	55.36	1.38	41.0
2000	/	7.99	/	0.16	/	/	19.97	71.88	1.55	41.1
2450	/	7.99	/	0.16	/	/	19.97	71.88	1.88	40.3
2600	/	7.99	/	0.16	/	/	19.97	71.88	1.88	40.3

Target Frequency (MHz)	Head		Body	
	ϵ_r	σ (S/m)	ϵ_r	σ (S/m)
150	52.3	0.76	61.9	0.80
300	45.3	0.87	58.2	0.92
450	43.5	0.87	56.7	0.94
835	41.5	0.90	55.2	0.97
900	41.5	0.97	55.0	1.05
915	41.5	0.98	55.0	1.06
1450	40.5	1.20	54.0	1.30
1610	40.3	1.29	53.8	1.40
1800-2000	40.0	1.40	53.3	1.52
2450	39.2	1.80	52.7	1.95
2600	39.0	1.96	52.5	2.16
3000	38.5	2.40	52.0	2.73
5800	35.3	5.27	48.2	6.00

3.8. Tissue equivalent liquid properties

Dielectric Performance of Head and Body Tissue Simulating Liquid

Test Engineer: Jerry hu									
Tissue Type	Measured Frequency (MHz)	Target Tissue		Measured Tissue				Liquid Temp.	Test Data
		σ	ϵ_r	σ	Dev.	ϵ_r	Dev.		
835H	835	0.90	41.50	0.92	2.22%	42.82	1.81%	20.5	12/10/2022
1800H	1800	1.52	53.30	1.56	-1.32%	52.11	-2.23%	22.1	12/12/2022
1900H	1900	1.40	40.00	1.37	-2.14%	38.56	-3.60%	21.2	12/13/2022
2450H	2450	1.80	39.20	1.84	2.22%	39.70	1.28%	22.3	12/14/2022
2600H	2600	1.96	39.00	1.92	-2.04%	38.43	-1.46%	22.1	12/15/2022



3.9. System Check

The purpose of the system check is to verify that the system operates within its specifications at the device test frequency. The system check is a simple check of repeatability to make sure that the system works correctly at the time of the compliance test;

System check results have to be equal or near the values determined during dipole calibration with the relevant liquids and test system ($\pm 10\%$).

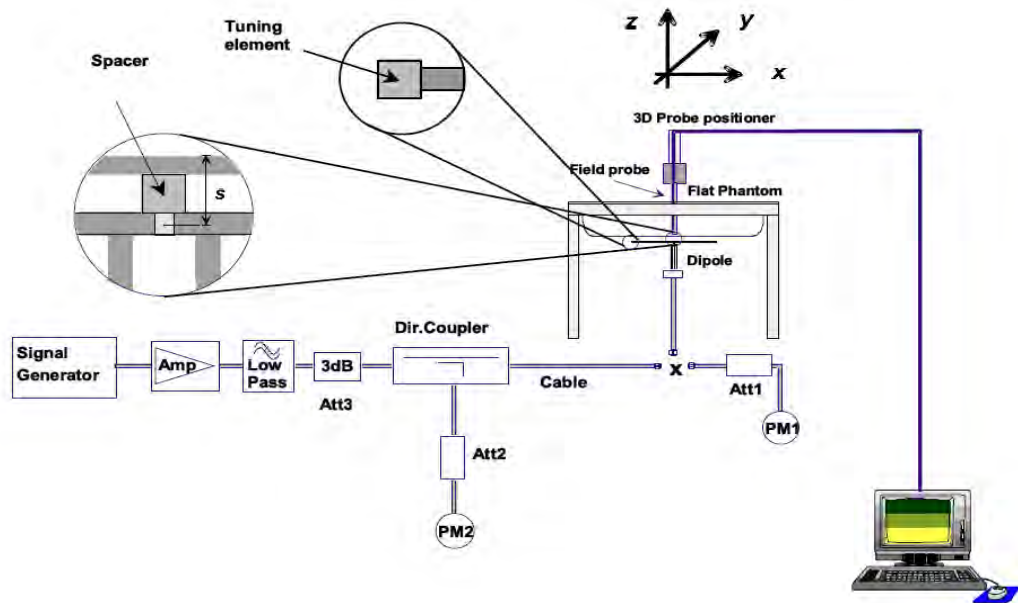

The output power on dipole port must be calibrated to 20 dBm (100mW) before dipole is connected.



Photo of Dipole Setup





Justification for Extended SAR Dipole Calibrations

Referring to KDB 865664D01V01r04, if dipoles are verified in return loss (<-20dB, within 20% of prior calibration), and in impedance (within 5 ohm of prior calibration), the annual calibration is not necessary and the calibration interval can be extended. While calibration intervals not exceed 3 years.

SID835 SN 07/14 DIP 0G835-303 Extend Dipole Calibrations

Date of Measurement	Return-Loss (dB)	Delta (%)	Real Impedance (ohm)	Delta (ohm)	Imaginary Impedance (ohm)	Delta (ohm)
2021-09-29	-24.49		54.9		2.8	
2022-09-29	-24.17	-1.31	54.5	-0.4	2.6	-0.2

SID1800 SN 30/14 DIP 1G800-301 Extend Dipole Calibrations

Date of Measurement	Return-Loss (dB)	Delta (%)	Real Impedance (ohm)	Delta (ohm)	Imaginary Impedance (ohm)	Delta (ohm)
2021-09-29	-20.26		43.1		6.9	
2022-09-29	-20.13	-0.64	42.9	-0.2	6.7	-0.2

SID1900 SN 38/18 DIP 1G900-466 Extend Dipole Calibrations

Date of Measurement	Return-Loss (dB)	Delta (%)	Real Impedance (ohm)	Delta (ohm)	Imaginary Impedance (ohm)	Delta (ohm)
2021-09-22	-26.43		50.5		4.7	
2022-09-22	-26.33	-0.38	50.2	-0.3	4.5	-0.2

SID2450 SN 07/14 DIP 2G450-306 Extend Dipole Calibrations

Date of Measurement	Return-Loss (dB)	Delta (%)	Real Impedance (ohm)	Delta (ohm)	Imaginary Impedance (ohm)	Delta (ohm)
2021-09-29	-25.59		44.7		-1.1	
2022-09-29	-25.68	0.35	44.8	0.1	-1.0	0.1

SID2600 SN 38/18 DIP 2G600-468 Extend Dipole Calibrations

Date of Measurement	Return-Loss (dB)	Delta (%)	Real Impedance (ohm)	Delta (ohm)	Imaginary Impedance (ohm)	Delta (ohm)
2021-09-22	-29.14		49.2		3.4	
2022-09-22	-29.12	-0.07	49.1	-0.1	3.2	-0.1



Mixture	Frequency	Power	SAR _{1g}	SAR _{10g}	Drift	1W Target	Difference	Liquid	Date
---------	-----------	-------	-------------------	--------------------	-------	-----------	------------	--------	------



Shenzhen LCS Compliance Testing Laboratory Ltd.
 Add: 101, 201 Bldg A & 301 Bldg C, Juji Industrial Park Yabianxueziwei, Shajing Street, Baoan District, Shenzhen, 518000, China
 Tel: +(86) 0755-82591330 | E-mail: webmaster@lcs-cert.com | Web: www.lcs-cert.com
 Scan code to check authenticity



Type	(MHz)		(W/Kg)	(W/Kg)	(%)	SAR		percentage		Temp	
						SAR _{1g} (W/Kg)	SAR _{10g} (W/Kg)	1g	10g		
Head	835	100 mW	0.923	0.639	2.03	9.60	6.20	-3.85%	3.06%	20.5	12/10/2022
		Normalize to 1 Watt	9.23	6.39							
Head	1800	100 mW	3.853	2.055	1.62	38.13	20.20	1.05%	1.73%	22.1	12/12/2022
		Normalize to 1 Watt	38.53	20.55							
Head	1900	100 mW	3.911	2.096	-1.20	40.03	20.55	-2.30%	2.00%	21.2	12/13/2022
		Normalize to 1 Watt	39.11	20.96							
Head	2450	100 mW	5.487	2.521	-0.08	53.89	24.15	1.82%	4.39%	22.3	12/14/2022
		Normalize to 1 Watt	54.87	25.21							
Head	2600	100 mW	5.747	2.246	3.14	56.91	24.69	0.98%	-9.03%	22.1	12/15/2022
		Normalize to 1 Watt	57.47	22.46							





3.10. SAR measurement procedure

The measurement procedures are as follows:

3.10.1 Conducted power measurement

- For WWAN power measurement, use base station simulator connection with RF cable, at maximum power in each supported wireless interface and frequency band.
- Read the WWAN RF power level from the base station simulator.
- For WLAN/BT power measurement, use engineering software to configure EUT WLAN/BT continuously Transmission, at maximum RF power in each supported wireless interface and frequency band.
- Connect EUT RF port through RF cable to the power meter, and measure WLAN/BT output power.

3.10.2 GSM Test Configuration

SAR tests for GSM 850 and GSM 1900, a communication link is set up with a System Simulator (SS) by air link. Using CMU200 the power level is set to "5" for GSM 850, set to "0" for GSM 1900. Since the GPRS class is 12 for this EUT, it has at most 4 timeslots in uplink and at most 4 timeslots in downlink, the maximum total timeslots is 5. the EGPRS class is 12 for this EUT, it has at most 4 timeslots in uplink and at most 4 timeslots in downlink, the maximum total timeslots is 5.

SAR test reduction for GPRS and EDGE modes is determined by the source-based time-averaged output power specified for production units, including tune-up tolerance. The data mode with highest specified time-averaged output power should be tested for SAR compliance in the applicable exposure conditions. For modes with the same specified maximum output power and tolerance, the higher number time-slot configuration should be tested. GSM voice and GPRS data use GMSK, which is a constant amplitude modulation with minimal peak to average power difference within the time-slot burst. For EDGE, GMSK is used for MCS 1 – MCS 4 and 8-PSK is used for MCS 5 – MCS 9; where 8-PSK has an inherently higher peak-to-average power ratio. The GMSK and 8-PSK EDGE configurations are considered separately for SAR compliance. The GMSK EDGE configurations are grouped with GPRS and considered with respect to time-averaged maximum output power to determine compliance. The 3G SAR test reduction procedure is applied to 8-PSK EDGE with GMSK GPRS/EDGE as the primary mode.

3.10.3 UMTS Test Configuration

3G SAR Test Reduction Procedure

In the following procedures, the mode tested for SAR is referred to as the primary mode. The equivalent modes considered for SAR test reduction are denoted as secondary modes. Both primary and secondary modes must be in the same frequency band. When the maximum output power and tune-up tolerance specified for production units in a secondary mode is $\leq \frac{1}{4}$ dB higher than the primary mode or when the highest reported SAR of the primary mode is scaled by the ratio of specified maximum output power and tune-up tolerance of secondary to primary mode and the adjusted SAR is ≤ 1.2 W/kg, SAR measurement is not required for the secondary mode. This is referred to as the 3G SAR test reduction procedure in the following SAR test guidance, where the primary mode is identified in the applicable wireless mode test procedures and the secondary mode is wireless mode being considered for SAR test reduction by that procedure. When the 3G SAR test reduction procedure is not satisfied, it is identified as "otherwise" in the applicable procedures; SAR measurement is required for the secondary mode.

Output power Verification

Maximum output power is verified on the high, middle and low channels according to procedures described in section 5.2 of 3GPP TS 34.121, using the appropriate RMC or AMR with TPC (transmit power control) set to all "1's" for WCDMA/HSDPA or by applying the required inner loop power control procedures to maintain maximum output power while HSUPA is active. Results for all applicable physical channel configurations (DPCCH, DPDCHn and spreading codes, HSDPA, HSPA) are required in the SAR report. All configurations that are not supported by the handset or cannot be measured due to technical or equipment limitations must be clearly identified.

Head SAR

SAR for next to the ear head exposure is measured using a 12.2 kbps RMC with TPC bits configured to all "1's". The 3G SAR test reduction procedure is applied to AMR configurations with 12.2 kbps RMC as the primary mode. Otherwise, SAR is measured for 12.2 kbps AMR in 3.4 kbps SRB (signaling radio bearer) using the highest reported SAR configuration in 12.2 kbps RMC for head exposure.





1) Body-Worn Accessory SAR

SAR for body-worn accessory configurations is measured using a 12.2 kbps RMC with TPC bits configured to all "1's". The 3G SAR test reduction procedure is applied to other spreading codes and multiple DPDCHn configurations supported by the handset with 12.2 kbps RMC as the primary mode. Otherwise, SAR is measured using an applicable RMC configuration with the corresponding spreading code or DPDCHn, for the highest reported body-worn accessory exposure SAR configuration in 12.2 kbps RMC. When more than 2 DPDCHn are supported by the handset, it may be necessary to configure additional DPDCHn using FTM (Factory Test Mode) or other chipset based test approaches with parameters similar to those used in 384 kbps and 768 kbps RMC.

2) Handsets with Release 5 HSDPA

The 3G SAR test reduction procedure is applied to HSDPA body-worn accessory configurations with 12.2 kbps RMC as the primary mode. Otherwise, SAR is measured for HSDPA using the HSDPA body SAR procedures in the "Release 5 HSDPA Data Devices" section of this document, for the highest reported SAR body-worn accessory exposure configuration in 12.2 kbps RMC. Handsets with both HSDPA and HSUPA are tested according to Release 6 HSPA test procedures.

HSDPA should be configured according to the UE category of a test device. The number of HSDSCH/HS-PDSCHs, HARQ processes, minimum inter-TTI interval, transport block sizes and RV coding sequence are defined by the H-set. To maintain a consistent test configuration and stable transmission conditions, QPSK is used in the H-set for SAR testing. HS-DPCCH should be configured with a CQI feedback cycle of 4 ms with a CQI repetition factor of 2 to maintain a constant rate of active CQI slots. DPCCH and DPDCH gain factors (β_c , β_d), and HS-DPCCH power offset parameters (Δ_{ACK} , Δ_{NACK} , Δ_{CQI}) should be set according to values indicated in the Table below. The CQI value is determined by the UE category, transport block size, number of HS-PDSCHs and modulation used in the H-set

Table 2: Subtests for UMTS Release 5 HSDPA

Sub-set	β_c	β_d	β_d (SF)	β_c/β_d	β_{hs} (note 1, note 2)	CM(dB) (note 3)	MPR(dB)
1	2/15	15/15	64	2/15	4/15	0.0	0.0
2	12/15 (note 4)	15/15 (note 4)	64	12/15 (note 4)	24/15	1.0	0.0
3	15/15	8/15	64	15/8	30/15	1.5	0.5
4	15/15	4/15	64	15/4	30/15	1.5	0.5

Note1: Δ_{ACK} , Δ_{NACK} and $\Delta_{CQI} = 8 \Leftrightarrow A_{hs} = \beta_{hs}/\beta_c = 30/15 \Leftrightarrow \beta_{hs} = 30/15 * \beta_c$
 Note2: CM=1 for $\beta_c/\beta_d = 12/15$, $\beta_{hs}/\beta_c = 24/15$.
 Note3: For subtest 2 the β_c/β_d ratio of 12/15 for the TFC during the measurement period (TF1, TF0) is achieved by setting the signaled gain factors for the reference TFC (TFC1, TF1) to $\beta_c = 11/15$ and $\beta_d = 15/15$.

HSUPA Test Configuration

The 3G SAR test reduction procedure is applied to HSPA (HSUPA/HSDPA with RMC) body-worn accessory configurations with 12.2 kbps RMC as the primary mode. Otherwise, SAR is measured for HSPA using the HSPA body SAR procedures in the "Release 6 HSPA Data Devices" section of this document, for the highest reported body-worn accessory exposure SAR configuration in 12.2 kbps RMC. When VOIP is applicable for next to the ear head exposure in HSPA, the 3G SAR test reduction procedure is applied to HSPA with 12.2 kbps RMC as the primary mode; otherwise, the same HSPA configuration used for body-worn accessory measurements is tested for next to the ear head exposure.

Due to inner loop power control requirements in HSPA, a communication test set is required for output power and SAR tests. The 12.2 kbps RMC, FRC H-set 1 and E-DCH configurations for HSPA are configured according to the β values indicated in Table 2 and other applicable procedures described in the 'WCDMA Handset' and 'Release 5 HSDPA Data Devices' sections of this document

Table 3: Sub-Test 5 Setup for Release 6 HSUPA

Sub-set	β_c	β_d	β_d (SF)	β_c/β_d	$\beta_{hs}^{(1)}$	β_{ec}	β_{ed}	β_{ed} (SF)	β_{ed} (codes)	CM ⁽²⁾ (dB)	MPR (dB)	AG ⁽⁴⁾ Index	E-TFCI
1	11/15 ⁽³⁾	15/15 ⁽³⁾	64	11/15 ⁽³⁾	22/15	209/225	1039/225	4	1	1.0	0.0	20	75
2	6/15	15/15	64	6/15	12/15	12/15	94/75	4	1	3.0	2.0	12	67





3	15/15	9/15	64	15/9	30/15	30/15	$\beta_{ed1} 47/15$ $\beta_{ed2} 47/15$	4	2	2.0	1.0	15	92
4	2/15	15/15	64	2/15	4/15	2/15	56/75	4	1	3.0	2.0	17	71
5	15/15 ⁽⁴⁾	15/15 ⁽⁴⁾	64	15/15 ⁽⁴⁾	30/15	24/15	134/15	4	1	1.0	0.0	21	81

Note 1: Δ_{ACK} , Δ_{NACK} and $\Delta_{CQI} = 8 \Leftrightarrow A_{hs} = \beta_{hs}/\beta_c = 30/15 \Leftrightarrow \beta_{hs} = 30/15 * \beta_c$.

Note 2: CM = 1 for $\beta_c/\beta_d = 12/15$, $\beta_{hs}/\beta_c = 24/15$. For all other combinations of DPDCH, DPCCH, HS-DPCCH, E-DPDCH and E-DPCCH the MPR is based on the relative CM difference.

Note 3: For subtest 1 the β_c/β_d ratio of 11/15 for the TFC during the measurement period (TF1, TF0) is achieved by setting the signaled gain factors for the reference TFC (TF1, TF1) to $\beta_c = 10/15$ and $\beta_d = 15/15$.

Note 4: For subtest 5 the β_c/β_d ratio of 15/15 for the TFC during the measurement period (TF1, TF0) is achieved by setting the signaled gain factors for the reference TFC (TF1, TF1) to $\beta_c = 14/15$ and $\beta_d = 15/15$.

Note 5: Testing UE using E-DPDCH Physical Layer category 1 Sub-test 3 is not required according to TS 25.306 Figure 5.1g.

Note 6: β_{ed} can not be set directly; it is set by Absolute Grant Value.

3.10.4 WIFI Test Configuration

The SAR measurement and test reduction procedures are structured according to either the DSSS or OFDM transmission mode configurations used in each standalone frequency band and aggregated band. For devices that operate in exposure configurations that require multiple test positions, additional SAR test reduction may be applied. The maximum output power specified for production units, including tune-up tolerance, are used to determine initial SAR test requirements for the 802.11 transmission modes in a frequency band. SAR is measured using the highest measured maximum output power channel for the initial test configuration. SAR measurement and test reduction for the remaining 802.11 modes and test channels are determined according to measured or specified maximum output power and reported SAR of the initial measurements. The general test reduction and SAR measurement approaches are summarized in the following:

1. The maximum output power specified for production units are determined for all applicable 802.11 transmission modes in each standalone and aggregated frequency band. Maximum output power is measured for the highest maximum output power configuration(s) in each frequency band according to the default power measurement procedures.
2. For OFDM transmission configurations in the 2.4 GHz and 5 GHz bands, an "initial test configuration" is first determined for each standalone and aggregated frequency band according to the maximum output power and tune-up tolerance specified for production units.
 - a. When the same maximum power is specified for multiple transmission modes in a frequency band, the largest channel bandwidth, lowest order modulation, lowest data rate and lowest order 802.11a/g/n/ac mode is used for SAR measurement, on the highest measured output power channel in the initial test configuration, for each frequency band.
 - b. SAR is measured for OFDM configurations using the initial test configuration procedures. Additional frequency band specific SAR test reduction may be considered for individual frequency bands
 - c. Depending on the reported SAR of the highest maximum output power channel tested in the initial test configuration, SAR test reduction may apply to subsequent highest output channels in the initial test configuration to reduce the number of SAR measurements.
3. The Initial test configuration does not apply to DSSS. The 2.4 GHz band SAR test requirements and 802.11b DSSS procedures are used to establish the transmission configurations required for SAR measurement.
4. An "initial test position" is applied to further reduce the number of SAR tests for devices operating in next to the ear, UMPC mini-tablet or hotspot mode exposure configurations that require multiple test positions.
 - a. SAR is measured for 802.11b according to the 2.4 GHz DSSS procedure using the exposure condition established by the initial test position.
 - b. SAR is measured for 2.4 GHz and 5 GHz OFDM configurations using the initial test configuration. 802.11b/g/n operating modes are tested independently according to the service requirements in each frequency band. 802.11b/g/n modes are tested on the maximum average output channel.
5. The Initial test position does not apply to devices that require a fixed exposure test position. SAR is measured in a fixed exposure test position for these devices in 802.11b according to the 2.4 GHz DSSS procedure or in 2.4 GHz and 5 GHz OFDM configurations using the initial test configuration procedures.
6. The "subsequent test configuration" procedures are applied to determine if additional SAR measurements are required for the remaining OFDM transmission modes that have not been tested in the initial test



Shenzhen LCS Compliance Testing Laboratory Ltd.

Add: 101, 201 Bldg A & 301 Bldg C, Juji Industrial Park Yabianxueziwei, Shajing Street, Baoan District, Shenzhen, 518000, China

Tel: +(86) 0755-82591330 | E-mail: webmaster@lcs-cert.com | Web: www.lcs-cert.com

Scan code to check authenticity



configuration. SAR test exclusion is determined according to reported SAR in the initial test configuration and maximum output power specified or measured for these other OFDM configurations.

2.4 GHz and 5GHz SAR Procedures

Separate SAR procedures are applied to DSSS and OFDM configurations in the 2.4 GHz band to simplify DSSS test requirements. For 802.11b DSSS SAR measurements, DSSS SAR procedure applies to fixed exposure test position and initial test position procedure applies to multiple exposure test positions. When SAR measurement is required for an OFDM configuration, the initial test configuration, subsequent test configuration and initial test position procedures are applied. The SAR test exclusion requirements for 802.11g/n OFDM configurations are described in section 5.2.2.

1. 802.11b DSSS SAR Test Requirements

SAR is measured for 2.4 GHz 802.11b DSSS using either a fixed test position or, when applicable, the initial test position procedure. SAR test reduction is determined according to the following:

- a. When the reported SAR of the highest measured maximum output power channel (section 3.1) for the exposure configuration is ≤ 0.8 W/kg, no further SAR testing is required for 802.11b DSSS in that exposure configuration.
- b. When the reported SAR is > 0.8 W/kg, SAR is required for that exposure configuration using the next highest measured output power channel. When any reported SAR is > 1.2 W/kg, SAR is required for the third channel; i.e., all channels require testing.

1. 2.4 GHz 802.11g/n OFDM SAR Test Exclusion Requirements

When SAR measurement is required for 2.4 GHz 802.11g/n OFDM configurations, the measurement and test reduction procedures for OFDM are applied (section 5.3). SAR is not required for the following 2.4 GHz OFDM conditions.

- a. When KDB Publication 447498 SAR test exclusion applies to the OFDM configuration
- b. When the highest reported SAR for DSSS is adjusted by the ratio of OFDM to DSSS specified maximum output power and the adjusted SAR is ≤ 1.2 W/kg.

2. SAR Test Requirements for OFDM Configurations

When SAR measurement is required for 802.11 a/g/n/ac OFDM configurations, each standalone and frequency aggregated band is considered separately for SAR test reduction. When the same transmitter and antenna(s) are used for U-NII-1 and U-NII-2A bands, additional SAR test reduction applies. When band gap channels between U-NII-2C band and 5.8 GHz U-NII-3 or §15.247 band are supported, the highest maximum output power transmission mode configuration and maximum output power channel across the bands must be used to determine SAR test reduction, according to the initial test configuration and subsequent test configuration requirements.²⁰ In applying the initial test configuration and subsequent test configuration procedures, the 802.11 transmission configuration with the highest specified maximum output power and the channel within a test configuration with the highest measured maximum output power should be clearly distinguished to apply the procedures.

3. OFDM Transmission Mode SAR Test Configuration and Channel Selection Requirements

The initial test configuration for 2.4 GHz and 5 GHz OFDM transmission modes is determined by the 802.11 configuration with the highest maximum output power specified for production units, including tune-up tolerance, in each standalone and aggregated frequency band. SAR for the initial test configuration is measured using the highest maximum output power channel determined by the default power measurement procedures (section 4). When multiple configurations in a frequency band have the same specified maximum output power, the initial test configuration is determined according to the following steps applied sequentially.

- a. The largest channel bandwidth configuration is selected among the multiple configurations with the same specified maximum output power.
- b. If multiple configurations have the same specified maximum output power and largest channel bandwidth, the lowest order modulation among the largest channel bandwidth configurations is selected.
- c. If multiple configurations have the same specified maximum output power, largest channel bandwidth and lowest order modulation, the lowest data rate configuration among these configurations is selected.
- d. When multiple transmission modes (802.11a/g/n/ac) have the same specified maximum output power, largest channel bandwidth, lowest order modulation and lowest data rate, the lowest order 802.11 mode is selected; i.e., 802.11a is chosen over 802.11n then 802.11ac or 802.11g is chosen over 802.11n.

After an initial test configuration is determined, if multiple test channels have the same measured maximum output power, the channel chosen for SAR measurement is determined according to the following. These channel selection procedures apply to both the initial test configuration and subsequent test configuration(s), with respect to the default power measurement procedures or additional power measurements required for





further SAR test reduction. The same procedures also apply to subsequent highest output power channel(s) selection.

- a. Channels with measured maximum output power within ¼ dB of each other are considered to have the same maximum output.
- b. When there are multiple test channels with the same measured maximum output power, the channel closest to mid-band frequency is selected for SAR measurement.
- c. When there are multiple test channels with the same measured maximum output power and equal separation from mid-band frequency; for example, high and low channels or two mid-band channels, the higher frequency (number) channel is selected for SAR measurement.

Initial Test Configuration Procedures

An initial test configuration is determined for OFDM transmission modes according to the channel bandwidth, modulation and data rate combination(s) with the highest maximum output power specified for production units in each standalone and aggregated frequency band. SAR is measured using the highest measured maximum output power channel. For configurations with the same specified or measured maximum output power, additional transmission mode and test channel selection procedures are required (see section 5.3.2). SAR test reduction of subsequent highest output test channels is based on the reported SAR of the initial test configuration.

For next to the ear, hotspot mode and UMC mini-tablet exposure configurations where multiple test positions are required, the initial test position procedure is applied to minimize the number of test positions required for SAR measurement using the initial test configuration transmission mode.²³ For fixed exposure conditions that do not have multiple SAR test positions, SAR is measured in the transmission mode determined by the initial test configuration. When the reported SAR of the initial test configuration is > 0.8 W/kg, SAR measurement is required for the subsequent next highest measured output power channel(s) in the initial test configuration until the reported SAR is ≤ 1.2 W/kg or all required channels are tested.

4. Subsequent Test Configuration Procedures

SAR measurement requirements for the remaining 802.11 transmission mode configurations that have not been tested in the initial test configuration are determined separately for each standalone and aggregated frequency band, in each exposure condition, according to the maximum output power specified for production units. The initial test position procedure is applied to next to the ear, UMPC mini-tablet and hotspot mode configurations. When the same maximum output power is specified for multiple transmission modes, the procedures in section 5.3.2 are applied to determine the test configuration. Additional power measurements may be required to determine if SAR measurements are required for subsequent highest output power channels in a subsequent test configuration. The subsequent test configuration and SAR measurement procedures are described in the following.

- a. When SAR test exclusion provisions of KDB Publication 447498 are applicable and SAR measurement is not required for the initial test configuration, SAR is also not required for the next highest maximum output power transmission mode subsequent test configuration(s) in that frequency band or aggregated band and exposure configuration.
- b. When the highest reported SAR for the initial test configuration (when applicable, include subsequent highest output channels), according to the initial test position or fixed exposure position requirements, is adjusted by the ratio of the subsequent test configuration to initial test configuration specified maximum output power and the adjusted SAR is ≤ 1.2 W/kg, SAR is not required for that subsequent test configuration.
- c. The number of channels in the initial test configuration and subsequent test configuration can be different due to differences in channel bandwidth. When SAR measurement is required for a subsequent test configuration and the channel bandwidth is smaller than that in the initial test configuration, all channels in the subsequent test configuration that overlap with the larger bandwidth channel tested in the initial test configuration should be used to determine the highest maximum output power channel. This step requires additional power measurement to identify the highest maximum output power channel in the subsequent test configuration to determine SAR test reduction.
 - 1). SAR should first be measured for the channel with highest measured output power in the subsequent test configuration.
 - 2). SAR for subsequent highest measured maximum output power channels in the subsequent test configuration is required only when the reported SAR of the preceding higher maximum output power channel(s) in the subsequent test configuration is > 1.2 W/kg or until all required channels are tested.
 - a) For channels with the same measured maximum output power, SAR should be measured using the channel closest to the center frequency of the larger channel bandwidth channel in the initial test configuration.





- d. SAR measurements for the remaining highest specified maximum output power OFDM transmission mode configurations that have not been tested in the initial test configuration (highest maximum output) or subsequent test configuration(s) (subsequent next highest maximum output power) is determined by applying the subsequent test configuration procedures in this section to the remaining configurations according to the following:
- 1) replace “subsequent test configuration” with “next subsequent test configuration” (i.e., subsequent next highest specified maximum output power configuration)
 - 2) replace “initial test configuration” with “all tested higher output power configurations.”

3.11. Power Reduction

The product without any power reduction.

3.12. Power Drift

To control the output power stability during the SAR test, SAR system calculates the power drift by measuring the E-field at the same location at the beginning and at the end of the measurement for each test position. This ensures that the power drift during one measurement is within 5%.





4. TEST CONDITIONS AND RESULTS

4.1. Conducted Power Results

According KDB 447498D01 General RF Exposure Guidance v06 Section 4.1 2) states that "Unless it is specified differently in the published RF exposure KDB procedures, these requirements also apply to test reduction and test exclusion considerations. Time-averaged maximum conducted output power applies to SAR and, as required by § 2.1091(c), time-averaged ERP applies to MPE. When an antenna port is not available on the device to support conducted power measurement, such as FRS and certain Part 15 transmitters with built-in integral antennas, the maximum output power allowed for production units should be used to determine RF exposure test exclusion and compliance."

<GSM Conducted Power>

General Note:

1. Per KDB 447498 D01v06, the maximum output power channel is used for SAR testing and for further SAR test reduction.
2. According to October 2013TCB Workshop, for GSM / GPRS / EGPRS, the number of time slots to test for SAR should correspond to the highest frame-average maximum output power configuration, considering the possibility of e.g. 3rd party VoIP operation for head and body-worn SAR testing, the EUT was set in GPRS (4Tx slot) for GSM850/GSM1900 band due to their highest frame-average power.
3. For hotspot mode SAR testing, GPRS should be evaluated, therefore the EUT was set in GPRS (4 Tx slots) for GSM850/GSM1900 band due to its highest frame-average power.

Conducted power measurement results for GSM850/PCS1900

GSM 850		Tune-up	Burst Conducted power (dBm)			Division Factors	Tune-up	Average power (dBm)		
			Channel/Frequency(MHz)					Channel/Frequency(MHz)		
		Max	128/824.2	190/836.6	251/848.8		Max	128/824.2	190/836.6	251/848.8
GSM		32.50	32.42	32.42	32.40	-9.03dB	23.47	23.39	23.39	23.37
GPRS (GMSK)	1TX slot	32.50	32.31	32.28	32.28	-9.03dB	23.47	23.28	23.25	23.25
	2TX slot	31.50	30.99	30.97	31.02	-6.02dB	25.48	24.97	24.95	25.00
	3TX slot	30.00	29.51	29.49	29.47	-4.26dB	25.74	25.25	25.23	25.21
	4TX slot	28.50	28.00	28.01	28.01	-3.01dB	25.49	24.99	25.00	25.00
EGPRS (8PSK)	1TX slot	26.50	25.97	26.02	26.01	-9.03dB	17.47	16.94	16.99	16.98
	2TX slot	25.00	24.48	24.49	24.47	-6.02dB	18.98	18.46	18.47	18.45
	3TX slot	23.50	23.02	23.02	22.99	-4.26dB	19.24	18.76	18.76	18.73
	4TX slot	21.50	21.47	21.50	21.47	-3.01dB	18.49	18.46	18.49	18.46
GSM 1900		Tune-up	Burst Conducted power (dBm)			Division Factors	Tune-up	Average power (dBm)		
			Channel/Frequency(MHz)					Channel/Frequency(MHz)		
		Max	512/1850.2	661/1880	810/1909.8		Max.	512/1850.2	661/1880	810/1909.8
GSM		29.50	29.45	29.45	29.47	-9.03dB	20.47	20.42	20.42	20.44
GPRS (GMSK)	1TX slot	29.50	29.40	29.40	29.39	-9.03dB	20.47	20.37	20.37	20.36
	2TX slot	28.00	27.99	27.98	27.97	-6.02dB	21.98	21.97	21.96	21.95
	3TX slot	27.00	26.48	26.49	26.52	-4.26dB	22.74	22.22	22.23	22.26
	4TX slot	25.50	24.99	25.02	24.99	-3.01dB	22.49	21.98	22.01	21.98
EGPRS (8PSK)	1TX slot	26.00	25.47	25.51	25.48	-9.03dB	16.97	16.44	16.48	16.45
	2TX slot	24.50	24.00	24.01	23.98	-6.02dB	18.48	17.98	17.99	17.96
	3TX slot	23.00	22.50	22.52	22.50	-4.26dB	18.74	18.24	18.26	18.24
	4TX slot	21.50	21.01	21.00	21.01	-3.01dB	18.49	18.00	17.99	18.00

Notes:

1. Division Factors

To average the power, the division factor is as follows:

1TX-slot = 1 transmit time slot out of 8 time slots=> conducted power divided by (8/1) => -9.00dB

2TX-slots = 2 transmit time slots out of 8 time slots=> conducted power divided by (8/2) => -6.00dB

3TX-slots = 3 transmit time slots out of 8 time slots=> conducted power divided by (8/3) => -4.26dB

4TX-slots = 4 transmit time slots out of 8 time slots=> conducted power divided by (8/4) => -3.00dB



Shenzhen LCS Compliance Testing Laboratory Ltd.

Add: 101, 201 Bldg A & 301 Bldg C, Juji Industrial Park Yabianxueziwei, Shajing Street, Baoan District, Shenzhen, 518000, China

Tel: +(86) 0755-82591330 | E-mail: webmaster@lcs-cert.com | Web: www.lcs-cert.com

Scan code to check authenticity



2. According to the conducted power as above, the GPRS measurements are performed with 3Txslot for GPRS850 and 3Txslot GPRS1900.

<UMTS Conducted Power>

The following tests were conducted according to the test requirements outlines in 3GPP TS 34.121 specification. A summary of these settings are illustrated below:

HSDPA Setup Configuration:

- a. The EUT was connected to Base Station E5515C referred to the Setup Configuration.
- b. The RF path losses were compensated into the measurements.
- c. A call was established between EUT and Base Station with following setting:
 - i. Set Gain Factors (β_c and β_d) and parameters were set according to each
 - ii. Specific sub-test in the following table, C10.1.4, quoted from the TS 34.121
 - iii. Set RMC 12.2Kbps + HSDPA mode.
 - iv. Set Cell Power = -86 dBm
 - v. Set HS-DSCH Configuration Type to FRC (H-set 1, QPSK)
 - vi. Select HSDPA Uplink Parameters
 - vii. Set Delta ACK, Delta NACK and Delta CQI = 8
 - viii. Set Ack-Nack Repetition Factor to 3
 - ix. Set CQI Feedback Cycle (k) to 4 ms
 - x. Set CQI Repetition Factor to 2
 - xi. Power Ctrl Mode = All Up bits
- d. The transmitted maximum output power was recorded.

Table C.10.1.4: β values for transmitter characteristics tests with HS-DPCCH

Sub-test	β_c	β_d	β_d (SF)	β_c/β_d	β_{HS} (Note 1, Note 2)	CM (dB) (Note 3)	MPR (dB) (Note 3)
1	2/15	15/15	64	2/15	4/15	0.0	0.0
2	12/15 (Note 4)	15/15 (Note 4)	64	12/15 (Note 4)	24/15	1.0	0.0
3	15/15	8/15	64	15/8	30/15	1.5	0.5
4	15/15	4/15	64	15/4	30/15	1.5	0.5

Note 1: $\Delta_{ACK}, \Delta_{NACK}$ and $\Delta_{CQI} = 30/15$ with $\beta_{HS} = 30/15 * \beta_c$.

Note 2: For the HS-DPCCH power mask requirement test in clause 5.2C, 5.7A, and the Error Vector Magnitude (EVM) with HS-DPCCH test in clause 5.13.1A, and HSDPA EVM with phase discontinuity in clause 5.13.1AA, Δ_{ACK} and $\Delta_{NACK} = 30/15$ with $\beta_{HS} = 30/15 * \beta_c$, and $\Delta_{CQI} = 24/15$ with $\beta_{HS} = 24/15 * \beta_c$.

Note 3: CM = 1 for $\beta_c/\beta_d = 12/15, \beta_{HS}/\beta_c = 24/15$. For all other combinations of DPDCH, DPCCH and HS-DPCCH the MPR is based on the relative CM difference. This is applicable for only UEs that support HSDPA in release 6 and later releases.

Note 4: For subtest 2 the β_c/β_d ratio of 12/15 for the TFC during the measurement period (TF1, TF0) is achieved by setting the signalled gain factors for the reference TFC (TF1, TF1) to $\beta_c = 11/15$ and $\beta_d = 15/15$.

Setup Configuration

HSUPA Setup Configuration:

- a. The EUT was connected to Base Station R&S CMU200 referred to the Setup Configuration.
- b. The RF path losses were compensated into the measurements.
- c. A call was established between EUT and Base Station with following setting * :
 - i. Call Configs = 5.2B, 5.9B, 5.10B, and 5.13.2B with QPSK
 - ii. Set the Gain Factors (β_c and β_d) and parameters (AG Index) were set according to each specific sub-test in the following table, C11.1.3, quoted from the TS 34.121
 - iii. Set Cell Power = -86 dBm
 - iv. Set Channel Type = 12.2k + HSPA
 - v. Set UE Target Power
 - vi. Power Ctrl Mode= Alternating bits
 - vii. Set and observe the E-TFCl
 - viii. Confirm that E-TFCl is equal to the target E-TFCl of 75 for sub-test 1, and other subtest's E-TFCl
- d. The transmitted maximum output power was recorded.





Table C.11.1.3: β values for transmitter characteristics tests with HS-DPCCH and E-DCH

Sub-test	β_c	β_d	β_d (SF)	β_c/β_d	β_{HS} (Note 1)	β_{ec}	β_{ed} (Note 5) (Note 6)	β_{ed} (SF)	β_{ed} (Codes)	CM (dB) (Note 2)	MPR (dB) (Note 2)	AG Index (Note 6)	E-TFCI
1	11/15 (Note 3)	15/15 (Note 3)	64	11/15 (Note 3)	22/15	209/25	1309/225	4	1	1.0	0.0	20	75
2	6/15	15/15	64	6/15	12/15	12/15	94/75	4	1	3.0	2.0	12	67
3	15/15	9/15	64	15/9	30/15	30/15	$\beta_{ed1}: 47/15$ $\beta_{ed2}: 47/15$	4 4	2	2.0	1.0	15	92
4	2/15	15/15	64	2/15	4/15	2/15	56/75	4	1	3.0	2.0	17	71
5	15/15 (Note 4)	15/15 (Note 4)	64	15/15 (Note 4)	30/15	24/15	134/15	4	1	1.0	0.0	21	81

Note 1: $\Delta_{ACK}, \Delta_{NACK}$ and $\Delta_{CQI} = 30/15$ with $\beta_{hs} = 30/15 * \beta_c$.

Note 2: CM = 1 for $\beta_c/\beta_d=12/15, \beta_{hs}/\beta_c=24/15$. For all other combinations of DPDCH, DPCCH, HS-DPCCH, E-DPDCH and E-DPCCH the MPR is based on the relative CM difference.

Note 3: For subtest 1 the β_c/β_d ratio of 11/15 for the TFC during the measurement period (TF1, TF1) is achieved by setting the signalled gain factors for the reference TFC (TF1, TF1) to $\beta_c = 10/15$ and $\beta_d = 15/15$.

Note 4: For subtest 5 the β_c/β_d ratio of 15/15 for the TFC during the measurement period (TF1, TF0) is achieved by setting the signalled gain factors for the reference TFC (TF1, TF1) to $\beta_c = 14/15$ and $\beta_d = 15/15$.

Note 5: In case of testing by UE using E-DPDCH Physical Layer category 1, Sub-test 3 is omitted according to TS25.306 Table 5.1g.

Note 6: β_{ed} can not be set directly, it is set by Absolute Grant Value.

General Note

1. Per KDB 941225 D01, RMC 12.2kbps setting is used to evaluate SAR. If AMR 12.2kbps power is < 0.25dB higher than RMC 12.2kbps, SAR tests with AMR 12.2kbps can be excluded.
2. By design, AMR and HSDPA/HSUPA RF power will not be larger than RMC 12.2kbps, detailed information is included in Tune-up Procure exhibit.
3. It is expected by the manufacturer that MPR for some HSDPA/HSUPA subtests may differ from the specification of 3GPP, according to the chipset implementation in this model. The implementation and expected deviation are detailed in tune-up procedure exhibit.

Conducted Power Measurement Results(WCDMA Band II/V)

Item	Band	FDD Band V result (dBm)			FDD Band II result (dBm)		
		Test Channel			Test Channel		
		4132/826.4	4183/836.6	4233/846.6	9262/1852.4	9400/1880	9538/1907.6
RMC	12.2kbps	22.73	22.86	22.68	23.26	23.24	23.21
HSDPA	Subtest 1	22.49	22.89	22.65	22.53	22.59	22.52
	Subtest 2	22.59	22.80	22.56	22.69	22.56	22.50
	Subtest 3	22.60	22.65	22.56	22.59	22.48	22.43
	Subtest 4	22.58	22.75	22.57	22.34	22.45	22.60
HSUPA	Subtest 1	22.43	22.67	22.46	22.62	22.74	22.65
	Subtest 2	22.38	22.61	22.56	22.43	22.42	22.37
	Subtest 3	22.34	22.55	22.54	22.55	22.44	22.59
	Subtest 4	21.64	21.04	21.66	22.47	22.34	22.52
	Subtest 5	21.47	21.66	21.40	21.45	21.54	21.66

Note: 1. When the maximum output power and tune-up tolerance specified for production units in a secondary mode is $\leq 1/2$ dB higher than the primary mode (RMC 12.2kbps) or when the highest reported SAR of the primary mode is scaled by the ratio of specified maximum output power and tune-up tolerance of secondary to primary mode and the adjusted SAR is ≤ 1.2 W/kg, SAR measurement is not required for the secondary mode.





LTE Band2

BW (MHz)	Frequency (MHz)	RB Configuration		Average Power [dBm]	
		Size	Offset	QPSK	16QAM
1.4	1850.7	1	0	23.16	22.19
		1	2	23.19	22.57
		1	5	23.06	22.24
		3	0	23.14	21.71
		3	1	23.24	22.08
		3	3	23.28	21.75
		6	0	22.28	21.62
	1880.0	1	0	23.49	22.49
		1	2	23.56	22.68
		1	5	23.35	22.46
		3	0	23.39	22.35
		3	1	23.47	22.17
		3	3	23.36	22.24
		6	0	22.40	21.64
	1909.3	1	0	23.18	22.06
		1	2	23.27	21.71
		1	5	23.02	21.51
		3	0	23.07	21.75
		3	1	23.04	21.89
		3	3	23.08	21.67
		6	0	22.00	21.06
3	1851.5	1	0	23.25	21.97
		1	8	23.48	21.81
		1	14	23.33	22.09
		8	0	22.11	21.29
		8	4	22.10	21.58
		8	7	22.13	21.11
	1880.0	15	0	22.18	20.95
		1	0	23.40	22.30
		1	8	23.36	22.03
		1	14	23.30	22.13
		8	0	22.21	21.39
		8	4	22.21	21.39
	1908.5	8	7	22.23	21.44
		15	0	22.28	21.60
		1	0	23.31	22.10
		1	8	23.15	21.53
		1	14	23.24	22.26
		8	0	22.07	21.49
5	1852.5	8	4	22.27	21.34
		8	7	22.08	21.11
		15	0	22.14	21.27
		1	0	23.53	22.19
		1	12	23.44	21.62
		1	24	23.24	22.12
		12	0	22.19	21.26
	1880.0	12	6	22.17	21.11
		12	13	22.04	21.09
		25	0	22.08	21.03
		1	0	23.22	21.52
		1	12	23.21	21.52
		1	24	23.43	21.54
		12	0	22.24	21.20
		12	6	22.27	21.19
12	13	22.12	21.26		
25	0	22.27	21.19		





10	1907.5	1	0	23.27	21.82
		1	12	23.02	21.50
		1	24	22.93	21.80
		12	0	22.01	21.27
		12	6	22.03	21.37
		12	13	22.12	21.24
		25	0	22.00	21.08
10	1855.0	1	0	23.15	22.20
		1	24	23.35	21.88
		1	49	23.11	22.17
		25	0	22.14	21.25
		25	12	22.12	21.13
		25	25	22.18	21.10
		50	0	22.10	21.14
	1880.0	1	0	23.20	21.95
		1	24	23.14	22.32
		1	49	23.26	21.87
		25	0	22.16	21.09
		25	12	22.15	21.17
		25	25	22.18	21.11
		50	0	22.25	21.30
1905.0	1	0	23.31	22.13	
	1	24	22.87	21.82	
	1	49	23.13	22.16	
	25	0	22.01	21.20	
	25	12	22.12	21.21	
	25	25	22.17	21.07	
	50	0	21.95	21.14	
15	1857.5	1	0	23.03	21.98
		1	38	23.09	21.98
		1	74	22.88	22.33
		37	0	22.19	22.10
		37	18	21.88	21.90
		37	37	22.24	22.24
		75	0	21.95	21.14
	1880.0	1	0	23.47	22.09
		1	38	23.16	22.10
		1	74	22.90	22.34
		37	0	22.38	22.19
		37	18	22.02	22.12
		37	37	22.22	22.14
		75	0	22.26	21.38
	1902.5	1	0	23.26	22.34
		1	38	22.98	22.02
		1	74	23.14	22.08
		37	0	22.11	22.26
		37	18	21.91	21.84
		37	37	21.99	22.03
		75	0	22.04	21.18
20	1860.0	1	0	23.62	22.40
		1	49	23.39	22.98
		1	99	23.30	22.63
		50	0	22.15	21.41
		50	25	22.13	21.35
		50	50	22.32	21.55
		100	0	22.33	21.37
	1880.0	1	0	23.47	23.23
		1	49	23.74	22.64
		1	99	23.58	22.72





	1900.0	50	0	22.18	21.29
		50	25	22.19	21.42
		50	50	22.20	21.31
		100	0	22.21	21.30
		1	0	23.46	22.08
		1	49	23.23	22.29
		1	99	22.97	22.15
		50	0	22.20	21.54
		50	25	22.43	21.56
		50	50	22.26	21.30
		100	0	22.34	21.34

LTE Band4

BW (MHz)	Frequency (MHz)	RB Configuration		Average Power [dBm]		
		Size	Offset	QPSK	16QAM	
1.4	1710.7	1	0	23.03	22.50	
		1	2	23.20	22.48	
		1	5	23.02	22.27	
		3	0	23.04	21.54	
		3	1	23.03	21.64	
		3	3	23.02	21.77	
			6	0	22.26	21.38
		1732.5	1	0	23.26	22.87
			1	2	23.24	22.52
			1	5	23.23	22.32
			3	0	23.36	21.89
			3	1	23.25	21.87
			3	3	23.22	22.06
			6	0	22.52	21.56
		1754.3	1	0	23.16	21.69
			1	2	23.47	21.70
			1	5	23.18	21.64
			3	0	23.00	22.31
	3		1	23.00	21.79	
	3		3	23.10	21.68	
		6	0	22.26	21.14	
3	1711.5	1	0	23.10	22.12	
		1	8	22.95	21.90	
		1	14	22.97	22.03	
		8	0	22.23	21.36	
		8	4	22.11	21.04	
		8	7	22.08	21.43	
			15	0	22.11	21.15
		1732.5	1	0	23.23	21.99
			1	8	23.21	22.16
			1	14	23.23	22.03
			8	0	22.32	21.50
			8	4	22.30	21.50
			8	7	22.29	21.47
			15	0	22.23	21.22
		1753.5	1	0	23.04	21.90
			1	8	23.07	22.10
			1	14	22.97	22.10
			8	0	22.21	21.32
	8		4	22.34	21.35	
	8		7	22.12	21.23	
		15	0	22.25	21.10	
5	1712.0	1	0	23.00	22.02	
		1	12	22.94	21.41	





10	1732.5	1	24	23.23	21.35
		12	0	21.97	20.90
		12	6	21.95	20.84
		12	13	21.88	20.98
		25	0	21.90	20.83
		1	0	23.19	21.64
	1752.5	1	12	23.08	21.39
		1	24	23.11	21.51
		12	0	22.18	21.10
		12	6	22.15	21.30
		12	13	22.15	21.20
		25	0	22.11	21.18
	1715.0	1	0	22.92	21.77
		1	12	22.86	21.45
		1	24	22.84	21.93
		12	0	21.94	21.05
		12	6	21.96	21.16
		12	13	21.95	21.17
15	1732.5	25	0	21.97	20.96
		1	0	23.05	21.88
		1	24	23.02	22.27
		1	49	23.12	21.97
		25	0	21.98	21.04
		25	12	22.04	21.04
	1750.0	25	25	22.04	20.94
		50	0	21.96	20.97
		1	0	23.30	22.25
		1	24	23.07	22.35
		1	49	23.14	22.12
		25	0	22.17	21.20
1717.5	1732.5	25	12	22.15	21.19
		25	25	22.06	21.10
		50	0	22.08	21.13
		1	0	23.05	21.95
		1	24	23.04	21.93
		1	49	22.89	21.78
	1747.5	25	0	22.08	21.13
		25	12	22.09	21.14
		25	25	22.04	21.08
		50	0	22.04	21.08
		1	0	23.08	22.12
		1	38	22.47	21.89
1732.5	1717.5	1	74	23.00	22.06
		37	0	22.06	22.13
		37	18	21.79	21.96
		37	37	22.10	22.00
		75	0	22.05	21.04
		1	0	23.30	22.17
	1747.5	1	38	22.80	22.13
		1	74	22.90	22.14
		37	0	22.19	22.22
		37	18	22.10	22.14
		37	37	22.17	22.14
		75	0	22.17	21.17
1732.5	1	0	23.23	22.20	
	1	38	22.68	21.93	
	1	74	22.57	21.85	
	37	0	22.18	22.21	
	37	18	21.89	21.93	
	37	18	21.89	21.93	





20	1720.0	37	37	21.80	21.94
		75	0	22.15	21.14
		1	0	23.17	22.19
		1	49	23.12	22.33
		1	99	23.01	22.17
		50	0	21.99	21.18
		50	25	22.00	21.28
		50	50	22.05	22.22
	1732.5	100	0	22.23	21.34
		1	0	23.63	22.31
		1	49	23.35	22.14
		1	99	22.43	22.89
		50	0	22.44	21.55
		50	25	22.52	21.55
		50	50	22.41	21.38
		100	0	22.51	21.47
	1745.0	1	0	23.50	22.46
		1	49	23.83	22.15
		1	99	23.12	21.91
		50	0	22.48	21.47
50		25	22.37	21.50	
50		50	22.25	21.48	
100		0	22.44	21.45	

LTE Band 7

BW (MHz)	Frequency (MHz)	RB Configuration		Average Power [dBm]	
		Size	Offset	QPSK	16QAM
5	2502.5	1	0	20.34	19.52
		1	12	19.87	19.10
		1	24	20.04	19.29
		12	0	19.75	19.08
		12	6	19.71	19.04
		12	13	19.67	19.00
		25	0	19.63	18.99
	2535.0	1	0	21.83	21.03
		1	12	21.06	20.30
		1	24	20.72	19.97
		12	0	21.29	20.61
		12	6	21.27	20.59
		12	13	20.70	20.02
		25	0	20.96	20.29
	2567.5	1	0	22.19	21.18
		1	12	21.64	20.96
		1	24	21.54	20.84
		12	0	21.52	20.52
		12	6	21.11	20.32
		12	13	21.47	20.81
25		0	21.13	20.16	
10	2505.0	1	0	19.53	18.76
		1	24	19.70	19.02
		1	49	20.33	19.62
		25	0	19.37	18.66
		25	12	19.33	18.62
		25	25	19.91	19.18
		50	0	19.58	18.89
	2535.0	1	0	21.32	20.64
		1	24	20.56	19.91
		1	49	19.31	18.64
		25	0	20.97	20.25





15	2565.0	25	12	20.95	20.23			
		25	25	19.93	19.22			
		50	0	20.45	19.76			
		1	0	22.34	21.21			
		1	24	21.88	21.06			
		1	49	20.74	19.87			
		25	0	21.21	20.25			
		25	12	21.17	20.44			
		25	25	21.25	20.55			
15	2507.5	50	0	21.09	20.11			
		1	0	19.84	19.30			
		1	37	20.13	19.68			
		1	74	22.02	20.90			
		37	0	19.42	19.50			
		37	18	19.75	19.79			
		37	38	21.11	21.26			
		75	0	20.62	19.98			
		15	2535.0	1	0	22.61	21.62	
1	37			20.94	20.55			
1	74			19.58	19.19			
37	0			21.96	22.06			
37	18			20.33	20.46			
37	38			19.02	19.13			
75	0			21.07	20.35			
15	2562.5			1	0	21.98	21.01	
				1	37	21.70	20.84	
		1	74	21.40	20.76			
		37	0	21.07	21.14			
		37	18	21.03	21.01			
		37	38	20.84	20.92			
		75	0	20.99	20.22			
		20	2510.0	1	0	19.60	19.50	
				1	49	21.38	20.84	
1	99			22.24	21.54			
50	0			20.26	19.67			
50	25			20.18	19.90			
50	50			20.88	20.22			
100	0			21.37	20.98			
20	2535.0			1	0	22.52	21.75	
				1	49	21.66	21.17	
			1	99	19.67	19.16		
			50	0	21.18	20.42		
			50	25	21.20	20.48		
			50	50	20.23	19.65		
			100	0	21.02	20.18		
			20	2560	1	0	20.94	20.41
					1	49	22.82	22.44
1	99				21.36	20.87		
50	0				21.09	20.13		
50	25	21.08			20.30			
50	50	21.08			20.36			
100	0	21.10			20.19			





<WLAN 2.4GHz Conducted Power>

Mode	Channel	Frequency (MHz)	Data rate (Mbps)	Average Output Power (dBm)
IEEE 802.11b	1	2412	1	15.53
			2	15.46
			5.5	15.37
			11	15.28
	6	2437	1	15.20
			2	15.12
			5.5	15.08
			11	15.03
	11	2462	1	14.25
			2	14.18
			5.5	14.11
			11	14.05
IEEE 802.11g	1	2412	6	15.22
			9	15.16
			12	15.11
			18	15.04
			24	15.00
			36	14.95
			48	14.87
			54	14.79
	6	2437	6	15.27
			9	15.20
			12	15.14
			18	15.11
			24	15.06
			36	15.00
			48	14.95
			54	14.90
	11	2462	6	14.12
			9	14.06
			12	14.01
			18	13.94
			24	13.89
			36	13.82
			48	13.76
			54	13.70
IEEE 802.11n HT20	1	2412	MCS0	14.42
			MCS1	14.35
			MCS2	14.30
			MCS3	14.24
			MCS4	14.16
			MCS5	14.10
			MCS6	14.04
			MCS7	13.95
	6	2437	MCS0	14.39
			MCS1	14.32
			MCS2	14.26
			MCS3	14.20
			MCS4	14.16
			MCS5	14.11
			MCS6	14.06
			MCS7	14.02
	11	2462	MCS0	14.01
			MCS1	13.93
			MCS2	13.86
			MCS3	13.82





		MCS4	13.74
		MCS5	13.66
		MCS6	13.60
		MCS7	13.54

Note: SAR is not required for the following 2.4 GHz OFDM conditions as the highest reported SAR for DSSS is adjusted by the ratio of OFDM to DSSS specified maximum output power and the adjusted SAR is ≤ 1.2 W/kg.

<BT Conducted Power>

Mode	channel	Frequency (MHz)	Conducted AVG output power (dBm)
BLE	0	2402	-0.24
	20	2442	0.99
	39	2480	0.88
GFSK	0	2402	1.03
	39	2441	1.62
	78	2480	1.68
$\pi/4$ -DQPSK	0	2402	1.20
	39	2441	1.47
	78	2480	1.51
8DPSK	0	2402	1.30
	39	2441	1.54
	78	2480	1.61

Per KDB 447498 D01v06, the 1-g and 10-g SAR test exclusion thresholds for 100 MHz to 6 GHz at test separation distances ≤ 50 mm are determined by:

$[(\text{max. power of channel, including tune-up tolerance, mW}) / (\text{min. test separation distance, mm})] \cdot [\sqrt{f(\text{GHz})}] \leq 3.0$
for 1-g SAR and ≤ 7.5 for 10-g extremity SAR

- f(GHz) is the RF channel transmit frequency in GHz
- Power and distance are rounded to the nearest mW and mm before calculation
- The result is rounded to one decimal place for comparison

Bluetooth Turn up Power (dBm)	Separation Distance (mm)	Frequency (GHz)	Exclusion Thresholds
2.0	5	2.45	0.5

Per KDB 447498 D01v06, when the minimum test separation distance is < 5 mm, a distance of 5 mm is applied to determine SAR test exclusion. The test exclusion threshold is $0.5 < 3.0$, SAR testing is not required.



Shenzhen LCS Compliance Testing Laboratory Ltd.

Add: 101, 201 Bldg A & 301 Bldg C, Juji Industrial Park Yabianxueziwei, Shajing Street, Baoan District, Shenzhen, 518000, China

Tel: +(86) 0755-82591330 | E-mail: webmaster@lcs-cert.com | Web: www.lcs-cert.com

Scan code to check authenticity

4.2. Transmit Antennas and SAR Measurement Position

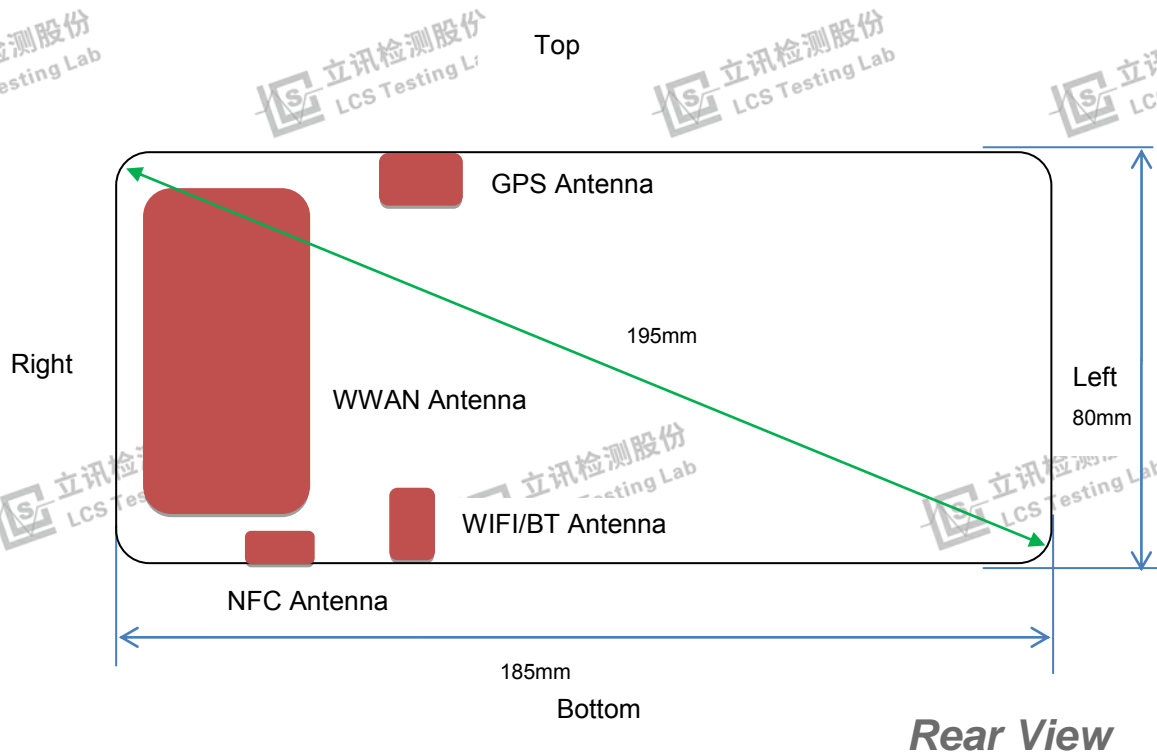

Antenna information:

WLAN/BT Antenna	WLAN/BT TX/RX
WWAN Antenna	GSM/UMTS/LTE TX/RX

Note:

- 1). Per KDB648474 D04, because the overall diagonal distance of this devices is 195mm>160mm, it is considered as "POS Terminal PC" device.
- 2). Per KDB648474 D04, 10-g extremity SAR is not required when Body-Worn mode 1-g reported SAR < 1.2 W/Kg.
- 3). According to the KDB941225 D06 Hot Spot SAR v02, the edges with less than 25 mm distance to the antennas need to be tested for SAR.
- 4). Per KDB 616217 D04, The antennas in tablets are typically located near the back (bottom) surface and/or along the edges of the devices; therefore, SAR evaluation is required for these configurations. Exposures from antennas through the front (top) surface of the displaysection of a full-size tablet, away from the edges, are generally limited to the user's hands.

Distance of The Antenna to the EUT surface and edge (mm)

Antennas	Front	Back	Top Side	Bottom Side	Left Side	Right Side
BT/WLAN	<5	<5	63	<5	109	69
WWAN	<5	<5	<5	<5	152	<5

Positions for SAR tests; Hotspot mode

Antennas	Front	Back	Top Side	Bottom Side	Left Side	Right Side
BT/WLAN	Yes	Yes	No	Yes	No	No
WWAN	Yes	Yes	Yes	Yes	No	Yes

General Note: Referring to KDB 941225 D06 v02, When the overall device length and width are $\geq 9\text{cm} \times 5\text{cm}$, the test distance is 0mm, SAR must be measured for all sides and surfaces with a transmitting antenna located with 25mm from that surface or edge.





4.3. SAR Measurement Results

The calculated SAR is obtained by the following formula:

$$\text{Reported SAR} = \text{Measured SAR} * 10^{(P_{\text{target}} - P_{\text{measured}})/10}$$

$$\text{Scaling factor} = 10^{(P_{\text{target}} - P_{\text{measured}})/10}$$

$$\text{Reported SAR} = \text{Measured SAR} * \text{Scaling factor}$$

Where

P_{target} is the power of manufacturing upper limit;

P_{measured} is the measured power;

Measured SAR is measured SAR at measured power which including power drift)

Reported SAR which including Power Drift and Scaling factor

Duty Cycle

Test Mode	Duty Cycle
GSM	3:8
UMTS	1:1
LTE	1:1
WLAN2450	1:1

4.3.1 SAR Results

SAR Values [GSM 850]

Ch.	Freq. (MHz)	Time slots	Test Position	Conducted Power (dBm)	Maximum Allowed Power (dBm)	Power Drift (%)	Scaling Factor	SAR _{1-g} results(W/kg)		Graph Results
								Measured	Reported	
measured / reported SAR numbers - Body (hotspot open, distance 10mm)										
128	824.2	3Txslots	Front	29.51	30.00	-4.74	1.119	0.115	0.129	
128	824.2	3Txslots	Rear	29.51	30.00	-0.37	1.119	0.260	0.291	Plot 1
128	824.2	3Txslots	Right	29.51	30.00	3.68	1.119	0.100	0.112	
128	824.2	3Txslots	Top	29.51	30.00	1.95	1.119	0.084	0.094	
128	824.2	3Txslots	Bottom	29.51	30.00	4.87	1.119	0.070	0.078	

Remark:

- The value with blue color is the maximum SAR Value of each test band.
- The frame average of GPRS (3Tx slots) higher than GSM and sample can support VoIP function, tested at GPRS (3Tx slots) mode for head.
- Per FCC KDB Publication 447498 D01, if the reported (scaled) SAR measured at the middle channel or highest output power channel for each test configuration is ≤ 0.8 W/kg then testing at the other channels is optional for such test configuration(s).

SAR Values [GSM 1900]

Ch.	Freq. (MHz)	time slots	Test Position	Conducted Power (dBm)	Maximum Allowed Power (dBm)	Power Drift (%)	Scaling Factor	SAR _{1-g} results(W/kg)		Graph Results
								Measured	Reported	
measured / reported SAR numbers - Body (hotspot open, distance 10mm)										
810	1909.8	3Txslots	Front	26.52	27.00	-0.63	1.117	0.084	0.094	
810	1909.8	3Txslots	Rear	26.52	27.00	-1.31	1.117	0.124	0.138	Plot 2
810	1909.8	3Txslots	Right	26.52	27.00	3.10	1.117	0.065	0.073	
810	1909.8	3Txslots	Top	26.52	27.00	4.70	1.117	0.058	0.065	
810	1909.8	3Txslots	Bottom	26.52	27.00	-1.08	1.117	0.039	0.044	

Remark:

- The value with blue color is the maximum SAR Value of each test band.
- The frame average of GPRS (3Tx slots) higher than GSM and sample can support VoIP function, tested at GPRS (3Tx slots) mode for head.
- Per FCC KDB Publication 447498 D01, if the reported (scaled) SAR measured at the middle channel or highest output power channel for each test configuration is ≤ 0.8 W/kg then testing at the other channels is optional for such test configuration(s).



**SAR Values [WCDMA Band V]**

Ch.	Freq. (MHz)	Channel Type	Test Position	Conducted Power (dBm)	Maximum Allowed Power (dBm)	Power Drift (%)	Scaling Factor	SAR _{1-g} results(W/kg)		Graph Results
								Measured	Reported	
measured / reported SAR numbers - Body (hotspot open, distance 10mm)										
4183	836.6	RMC*	Front	22.89	23.00	0.32	1.026	0.269	0.276	
4183	836.6	RMC*	Rear	22.89	23.00	-0.37	1.026	0.313	0.321	Plot 3
4183	836.6	RMC*	Right	22.89	23.00	3.65	1.026	0.244	0.250	
4183	836.6	RMC*	Top	22.89	23.00	0.20	1.026	0.228	0.234	
4183	836.6	RMC*	Bottom	22.89	23.00	4.78	1.026	0.217	0.223	

Remark:

- The value with blue color is the maximum SAR Value of each test band.
- Per FCC KDB Publication 447498 D01, if the reported (scaled) SAR measured at the middle channel or highest output power channel for each test configuration is ≤ 0.8 W/kg then testing at the other channels is optional for such test configuration(s).
- RMC* - RMC 12.2kbps mode;

SAR Values [WCDMA Band II]

Ch.	Freq. (MHz)	Channel Type	Test Position	Conducted Power (dBm)	Maximum Allowed Power (dBm)	Power Drift (%)	Scaling Factor	SAR _{1-g} results(W/kg)		Graph Results
								Measured	Reported	
measured / reported SAR numbers - Body (hotspot open, distance 10mm)										
9400	1880.0	RMC	Front	22.74	23.00	0.25	1.062	0.147	0.156	
9400	1880.0	RMC	Rear	22.74	23.00	0.41	1.062	0.180	0.191	Plot 4
9400	1880.0	RMC	Right	22.74	23.00	1.96	1.062	0.127	0.135	
9400	1880.0	RMC	Top	22.74	23.00	-0.32	1.062	0.118	0.125	
9400	1880.0	RMC	Bottom	22.74	23.00	-3.65	1.062	0.104	0.110	

Remark:

- The value with blue color is the maximum SAR Value of each test band.
- Per FCC KDB Publication 447498 D01, if the reported (scaled) SAR measured at the middle channel or highest output power channel for each test configuration is ≤ 0.8 W/kg then testing at the other channels is optional for such test configuration(s).
- RMC* - RMC 12.2kbps mode;

SAR Values [LTE Band 2]

Ch.	Freq. (MHz)	Channel Type (20M)	Test Position	Conducted Power (dBm)	Maximum Allowed Power (dBm)	Power Drift (%)	Scaling Factor	SAR _{1-g} results(W/kg)		Graph Results
								Measured	Reported	
measured / reported SAR numbers - Body (hotspot open, distance 10mm)										
18900	1880.0	1RB	Front	23.74	24.00	0.34	1.062	0.116	0.123	
18900	1880.0	1RB	Rear	23.74	24.00	-1.79	1.062	0.169	0.179	Plot 5
18900	1880.0	1RB	Right	23.74	24.00	-4.79	1.062	0.104	0.110	
18900	1880.0	1RB	Top	23.74	24.00	1.09	1.062	0.091	0.097	
18900	1880.0	1RB	Bottom	23.74	24.00	3.45	1.062	0.080	0.085	
19100	1900.0	50%RB	Front	22.43	22.50	-2.06	1.016	0.058	0.059	
19100	1900.0	50%RB	Rear	22.43	22.50	1.47	1.016	0.089	0.090	
19100	1900.0	50%RB	Right	22.43	22.50	2.22	1.016	0.049	0.050	
19100	1900.0	50%RB	Top	22.43	22.50	-3.67	1.016	0.038	0.039	
19100	1900.0	50%RB	Bottom	22.43	22.50	4.50	1.016	0.030	0.030	



**SAR Values [LTE Band 4]**

Ch.	Freq. (MHz)	Channel Type (20M)	Test Position	Conducted Power (dBm)	Maximum Allowed Power (dBm)	Power Drift (%)	Scaling Factor	SAR _{1-g} results(W/kg)		Graph Results
								Measured	Reported	
measured / reported SAR numbers - Body (hotspot open, distance 10mm)										
20300	1745.0	1RB	Front	23.83	24.00	1.58	1.040	0.315	0.328	
20300	1745.0	1RB	Rear	23.83	24.00	-0.65	1.040	0.501	0.521	Plot 6
20300	1745.0	1RB	Right	23.83	24.00	-3.56	1.040	0.304	0.316	
20300	1745.0	1RB	Top	23.83	24.00	-1.79	1.040	0.295	0.307	
20300	1745.0	1RB	Bottom	23.83	24.00	0.95	1.040	0.280	0.291	
20175	1732.5	50%RB	Front	22.52	23.00	-3.06	1.117	0.156	0.174	
20175	1732.5	50%RB	Rear	22.52	23.00	-4.02	1.117	0.248	0.277	
20175	1732.5	50%RB	Right	22.52	23.00	-3.03	1.117	0.145	0.162	
20175	1732.5	50%RB	Top	22.52	23.00	-4.78	1.117	0.133	0.149	
20175	1732.5	50%RB	Bottom	22.52	23.00	0.25	1.117	0.118	0.132	

SAR Values [LTE Band 7]

Ch.	Freq. (MHz)	Channel Type (20M)	Test Position	Conducted Power (dBm)	Maximum Allowed Power (dBm)	Power Drift (%)	Scaling Factor	SAR _{1-g} results(W/kg)		Graph Results
								Measured	Reported	
measured / reported SAR numbers - Body (hotspot open, distance 10mm)										
21350	2560.0	1RB	Front	22.82	23.00	4.44	1.042	0.118	0.123	
21350	2560.0	1RB	Rear	22.82	23.00	-3.10	1.042	0.260	0.271	Plot 7
21350	2560.0	1RB	Right	22.82	23.00	-3.05	1.042	0.104	0.108	
21350	2560.0	1RB	Top	22.82	23.00	4.02	1.042	0.093	0.097	
21350	2560.0	1RB	Bottom	22.82	23.00	-0.65	1.042	0.084	0.088	
21100	2535.0	50%RB	Front	21.18	21.50	-3.98	1.076	0.059	0.064	
21100	2535.0	50%RB	Rear	21.18	21.50	4.78	1.076	0.135	0.145	
21100	2535.0	50%RB	Right	21.18	21.50	-2.09	1.076	0.047	0.051	
21100	2535.0	50%RB	Top	21.18	21.50	1.01	1.076	0.038	0.041	
21100	2535.0	50%RB	Bottom	21.18	21.50	-2.65	1.076	0.019	0.020	

SAR Values [WIFI2.4G]

Ch.	Freq. (MHz)	Service	Test Position	Conducted Power (dBm)	Maximum Allowed Power (dBm)	Power Drift (%)	Scaling Factor	SAR _{1-g} results(W/kg)		Graph Results
								Measured	Reported	
measured / reported SAR numbers - Body (hotspot open, distance 10mm)										
1	2412	802.11b	Front	15.53	16.00	4.52	1.114	0.038	0.042	
1	2412	802.11b	Rear	15.53	16.00	-1.47	1.114	0.072	0.080	Plot 8
1	2412	802.11b	Bottom	15.53	16.00	-3.78	1.114	0.029	0.032	

Remark:

- The value with blue color is the maximum SAR Value of each test band.
- Per FCC KDB Publication 447498 D01, if the reported (scaled) SAR measured at the middle channel or highest output power channel for each test configuration is ≤ 0.8 W/kg then testing at the other channels is optional for such test configuration(s).
- When the same maximum output power is specified for both bands, begin SAR measurement in U-NII-2A band by applying the OFDM SAR requirements. 19 If the highest reported SAR for a test configuration is ≤ 1.2 W/kg, SAR is not required for U-NII-1 band for that configuration (802.11 mode and exposure condition); otherwise, each band is tested independently for SAR.
- When different maximum output power is specified for the bands, begin SAR measurement in the band with higher specified maximum output power. The highest reported SAR for the tested configuration is adjusted by the ratio of lower to higher specified maximum output power for the two bands. When the adjusted SAR is ≤ 1.2 W/kg, SAR is not required for the band with lower maximum output power in that test configuration; otherwise, each band is tested independently for SAR.



Shenzhen LCS Compliance Testing Laboratory Ltd.

Add: 101, 201 Bldg A & 301 Bldg C, Juji Industrial Park Yabianxueziwei, Shajing Street, Baoan District, Shenzhen, 518000, China

Tel: +(86) 0755-82591330 | E-mail: webmaster@lcs-cert.com | Web: www.lcs-cert.com

Scan code to check authenticity



4.3.2 Standalone SAR Test Exclusion Considerations and Estimated SAR

Per KDB447498 requires when the standalone SAR test exclusion of section 4.3.1 is applied to an antenna that transmits simultaneously with other antennas, the standalone SAR must be estimated according to the following to determine simultaneous transmission SAR test exclusion;

- (max. power of channel, including tune-up tolerance, mW)/(min. test separation distance, mm)] • [√ f((GHz)/x) W/kg for test separation distances ≤ 50 mm;

where x = 7.5 for 1-g SAR, and x = 18.75 for 10-g SAR.

- 0.4 W/kg for 1-g SAR and 1.0 W/kg for 10-g SAR, when the test separation distances is > 50 mm

Per FCC KD B447498 D01, simultaneous transmission SAR test exclusion may be applied when the sum of the 1-g SAR for all the transmitting antenna in a specific a physical test configuration is ≤1.6 W/Kg. When the sum is greater than the SAR limit, SAR test exclusion is determined by the SAR to peak location separation ratio.

$$\text{Ratio} = \frac{(\text{SAR}_1 + \text{SAR}_2)^{1.5}}{(\text{peak location separation, mm})} < 0.04$$

Estimated stand alone SAR					
Communication system	Frequency (MHz)	Configuration	Maximum Power (dBm)	Separation Distance (mm)	Estimated SAR _{1-g} (W/kg)
Bluetooth*	2450	Hotspot	2.0	10	0.066
Bluetooth*	2450	Body-worn	2.0	10	0.066

Remark:

1. Bluetooth*- Including Lower power Bluetooth
2. Maximum average power including tune-up tolerance;
3. When the minimum test separation distance is < 5 mm, a distance of 5 mm is applied to determine SAR test exclusion
4. Body as body use distance is 10mm from manufacturer declaration of user manual

4.4. Simultaneous TX SAR Considerations

4.4.1 Introduction

Simultaneous transmission SAR test exclusion is determined for each operating configuration and exposure condition according to the reported standalone SAR of each applicable simultaneous transmitting antenna. The device has 4 antennas, WWAN main antenna, WWAN diversity antenna(RX only), and WiFi antenna supports 2.4Wi-Fi. The 2 TX antennas can always transmit simultaneously. The work mode combination is showed as below table.;

Application Simultaneous Transmission information:

Combination No.	Mode
1	WWAN+WIFI
2	WWAN+BT

4.4.2 Evaluation of Simultaneous SAR

Body Hotspot Exposure Conditions

Simultaneous transmission SAR for WiFi and GSM

Test Position	GSM850 Reported SAR1-g (W/kg)	GSM1900 Reported SAR1-g (W/kg)	WiFi2.4G Reported SAR1-g (W/kg)	MAX. ΣSAR1-g (W/kg)	SAR1-g Limit (W/kg)	Peak location separation ratio	Simut Meas. Required
Front	0.129	0.094	0.042	0.171	1.6	no	no
Rear	0.291	0.138	0.080	0.371	1.6	no	no
Left	/	/	/	/	1.6	no	no
Right	0.112	0.073	/	0.112	1.6	no	no
Bottom	0.078	0.044	0.032	0.110	1.6	no	no
Top	0.094	0.065	/	0.094	1.6	no	no





Simultaneous transmission SAR for WiFi and UMTS

Test Position	UMTS Band V Reported SAR1-g (W/kg)	UMTS Band II Reported SAR1-g (W/kg)	WiFi2.4G Reported SAR1-g (W/kg)	MAX. ΣSAR1-g (W/kg)	SAR1-g Limit (W/kg)	Peak location separation ratio	Simut Meas. Required
Front	0.276	0.156	0.042	0.318	1.6	no	no
Rear	0.321	0.191	0.080	0.401	1.6	no	no
Left	/	/	/	/	1.6	no	no
Right	0.250	0.135	/	0.250	1.6	no	no
Bottom	0.223	0.110	0.032	0.255	1.6	no	no
Top	0.234	0.125	/	0.234	1.6	no	no

SAR for WiFi and LTE

Reported SAR1-g(W/kg)	Test Position					
	Front	Rear	Left	Right	Bottom	Top
LTE Band2	0.123	0.179	/	0.110	0.085	0.097
LTE Band4	0.328	0.521	/	0.316	0.291	0.307
LTE Band7	0.123	0.271	/	0.108	0.088	0.097
WiFi2.4G	0.042	0.080	/	/	0.032	/
MAX. ΣSAR1-g (W/kg)	0.370	0.601	/	0.316	0.323	0.307
SAR1-g Limit (W/kg)	1.6	1.6	1.6	1.6	1.6	1.6
Peak location separation ratio	no	no	no	no	no	no
Simut Meas. Required	no	no	no	no	no	no

Simultaneous transmission SAR for BT and GSM

Test Position	GSM850 Reported SAR1-g (W/kg)	GSM1900 Reported SAR1-g (W/kg)	BT Estimated SAR1-g (W/kg)	MAX. ΣSAR1-g (W/kg)	SAR1-g Limit (W/kg)	Peak location separation ratio	Simut Meas. Required
Front	0.129	0.094	0.066	0.195	1.6	no	no
Rear	0.291	0.138	0.066	0.357	1.6	no	no
Left	/	/	/	/	1.6	no	no
Right	0.112	0.073	/	0.112	1.6	no	no
Bottom	0.078	0.044	0.066	0.144	1.6	no	no
Top	0.094	0.065	/	0.094	1.6	no	no

Simultaneous transmission SAR for BT and UMTS

Test Position	UMTS Band V Reported SAR1-g (W/kg)	UMTS Band II Reported SAR1-g (W/kg)	BT Estimated SAR1-g (W/kg)	MAX. ΣSAR1-g (W/kg)	SAR1-g Limit (W/kg)	Peak location separation ratio	Simut Meas. Required
Front	0.276	0.156	0.066	0.342	1.6	no	no
Rear	0.321	0.191	0.066	0.387	1.6	no	no
Left	/	/	/	/	1.6	no	no
Right	0.250	0.135	/	0.250	1.6	no	no
Bottom	0.223	0.110	0.066	0.289	1.6	no	no
Top	0.234	0.125	/	0.234	1.6	no	no

Simultaneous transmission SAR for BT and LTE

Reported SAR1-g(W/kg)	Test Position					
	Front	Rear	Left	Right	Bottom	Top
LTE Band2	0.123	0.179	/	0.110	0.085	0.097
LTE Band4	0.328	0.521	/	0.316	0.291	0.307
LTE Band7	0.123	0.271	/	0.108	0.088	0.097
BT Estimated SAR1-g (W/kg)	0.066	0.066	/	/	0.066	/
MAX. ΣSAR1-g (W/kg)	0.394	0.587	/	0.316	0.357	0.307
SAR1-g Limit (W/kg)	1.6	1.6	1.6	1.6	1.6	1.6
Peak location separation ratio	no	no	no	no	no	no
Simut Meas. Required	no	no	no	no	no	no

Note:

1. The WiFi and BT share same antenna, so cannot transmit at same time.
2. The value with block color is the maximum values of standalone
3. The value with blue color is the maximum values of ΣSAR_{1-g}





4.5. SAR Measurement Variability

According to KDB865664, Repeated measurements are required only when the measured SAR is ≥ 0.80 W/kg. If the measured SAR value of the initial repeated measurement is < 1.45 W/kg with $\leq 20\%$ variation, only one repeated measurement is required to reaffirm that the results are not expected to have substantial variations, which may introduce significant compliance concerns. A second repeated measurement is required only if the measured result for the initial repeated measurement is within 10% of the SAR limit and vary by more than 20%, which are often related to device and measurement setup difficulties. The following procedures are applied to determine if repeated measurements are required. The same procedures should be adapted for measurements according to extremity and occupational exposure limits by applying a factor of 2.5 for extremity exposure and a factor of 5 for occupational exposure to the corresponding SAR thresholds.¹⁹ The repeated measurement results must be clearly identified in the SAR report. All measured SAR, including the repeated results, must be considered to determine compliance and for reporting according to KDB 690783. Repeated measurement is not required when the original highest measured SAR is < 0.80 W/kg; steps 2) through 4) do not apply.

- 3) When the original highest measured SAR is ≥ 0.80 W/kg, repeat that measurement once.
- 4) Perform a second repeated measurement only if the ratio of largest to smallest SAR for the original and first repeated measurements is > 1.20 or when the original or repeated measurement is ≥ 1.45 W/kg ($\sim 10\%$ from the 1-g SAR limit).
- 5) Perform a third repeated measurement only if the original, first or second repeated measurement is ≥ 1.5 W/kg and the ratio of largest to smallest SAR for the original, first and second repeated measurements is > 1.20 .
- 6) Perform a third repeated measurement only if the original, first or second repeated measurement is ≥ 1.5 W/kg and the ratio of largest to smallest SAR for the original, first and second repeated measurements is > 1.20 .

Frequency Band (MHz)	Air Interface	RF Exposure Configuration	Test Position	Repeated SAR (yes/no)	Highest Measured SAR _{1-g} (W/Kg)	First Repeated	
						Measured SAR _{1-g} (W/Kg)	Largest to Smallest SAR Ratio
850	GSM 850	Standalone	Body-Rear	no	0.260	n/a	n/a
	WCDMA Band V	Standalone	Body- Rear	no	0.313	n/a	n/a
1800	LTE Band 4	Standalone	Body- Rear	no	0.501	n/a	n/a
1900	GSM 1900	Standalone	Body-Rear	no	0.124	n/a	n/a
	WCDMA Band II	Standalone	Body-Rear	no	0.180	n/a	n/a
	LTE Band 2	Standalone	Body-Rear	no	0.169	n/a	n/a
2450	2.4GWLAN	Standalone	Body-Rear	no	0.072	n/a	n/a
2600	LTE Band 7	Standalone	Body-Rear	no	0.260	n/a	n/a

Remark:

1. *Second Repeated Measurement is not required since the ratio of the largest to smallest SAR for the original and first repeated measurement is not > 1.20 or 3 (1-g or 10-g respectively)*





4.6. General description of test procedures

1. Test positions as described in the tables above are in accordance with the specified test standard.
2. Tests in body position were performed in that configuration, which generates the highest time based averaged output power (see conducted power results).
3. According to IEEE 1528 the SAR test shall be performed at middle channel. Testing of top and bottom channel is optional.
4. According to KDB 447498 D01 testing of other required channels within the operating mode of a frequency band is not required when the reported 1-g or 10-g SAR for the mid-band or highest output power channel is:
 - ≤ 0.8 W/kg or 2.0 W/kg, for 1-g or 10-g respectively, when the transmission band is ≤ 100 MHz
 - ≤ 0.6 W/kg or 1.5 W/kg, for 1-g or 10-g respectively, when the transmission band is between 100 MHz and 200 MHz
 - ≤ 0.4 W/kg or 1.0 W/kg, for 1-g or 10-g respectively, when the transmission band is ≥ 200 MHz
5. IEEE 1528-2003 require the middle channel to be tested first. This generally applies to wireless devices that are designed to operate in technologies with tight tolerances for maximum output power variations across channels in the band. When the maximum output power variation across the required test channels is $> \frac{1}{2}$ dB, instead of the middle channel, the highest output power channel must be used.
6. When the same maximum output power is specified for both bands, begin SAR measurement in U-NII-2A band by applying the OFDM SAR requirements.19 If the highest reported SAR for a test configuration is ≤ 1.2 W/kg, SAR is not required for U-NII-1 band for that configuration (802.11 mode and exposure condition); otherwise, each band is tested independently for SAR.
7. When different maximum output power is specified for the bands, begin SAR measurement in the band with higher specified maximum output power. The highest reported SAR for the tested configuration is adjusted by the ratio of lower to higher specified maximum output power for the two bands. When the adjusted SAR is ≤ 1.2 W/kg, SAR is not required for the band with lower maximum output power in that test configuration; otherwise, each band is tested independently for SAR.

4.7. Measurement Uncertainty (450MHz-6GHz)

Not required as SAR measurement uncertainty analysis is required in SAR reports only when the highest measured SAR in a frequency band is ≥ 1.5 W/kg for 1-g SAR according to KDB865664D01.



Shenzhen LCS Compliance Testing Laboratory Ltd.

Add: 101, 201 Bldg A & 301 Bldg C, Juji Industrial Park Yabianxueziwei, Shajing Street, Baoan District, Shenzhen, 518000, China

Tel: +(86) 0755-82591330 | E-mail: webmaster@lcs-cert.com | Web: www.lcs-cert.com

Scan code to check authenticity

4.8. System Check Results

Test mode:835MHz(Head)

Product Description:Validation

Model:Dipole SID835

E-Field Probe:SSE2(SN 25/22 EPGO376)

Test Date: December 10, 2022

Medium(liquid type)	HSL_850
Frequency (MHz)	835.0000
Relative permittivity (real part)	42.82
Conductivity (S/m)	0.92
Input power	100mW
Crest Factor	1.0
Conversion Factor	1.75
Variation (%)	2.030000
SAR 10g (W/Kg)	0.639132
SAR 1g (W/Kg)	0.923488

SURFACE SAR

VOLUME SAR

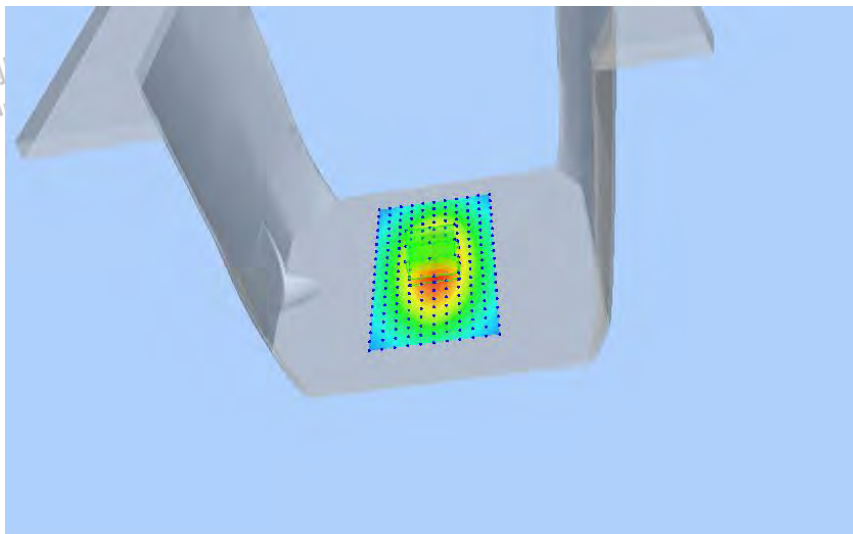
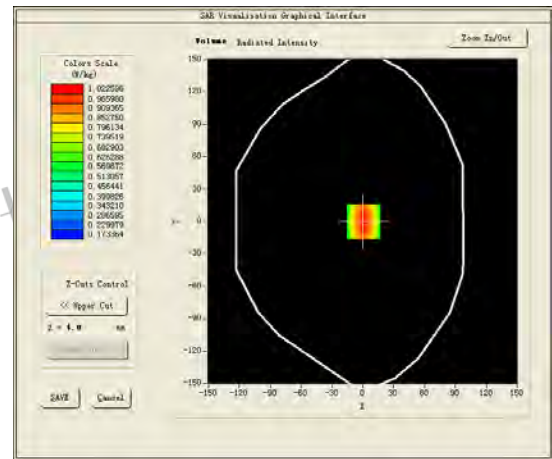
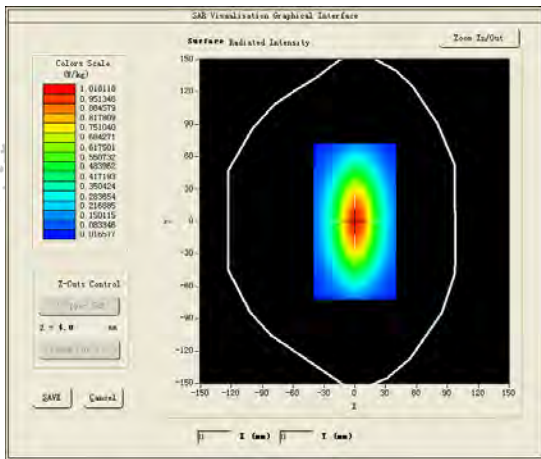

Test mode:1800MHz(Head)
 Product Description:Validation
 Model :Dipole SID1800
 E-Field Probe:SSE2(SN 25/22 EPGO376)
 Test Date: December 12, 2022

Medium(liquid type)	HSL_1800
Frequency (MHz)	1800.0000
Relative permittivity (real part)	52.11
Conductivity (S/m)	1.56
Input power	100mW
Crest Factor	1.0
Conversion Factor	2.09
Variation (%)	1.620000
SAR 10g (W/Kg)	2.055283
SAR 1g (W/Kg)	3.853085

SURFACE SAR

VOLUME SAR

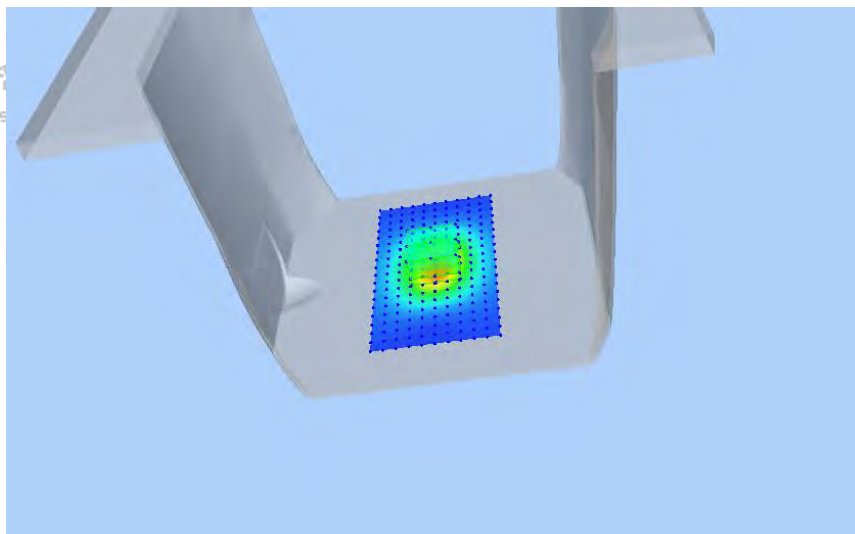
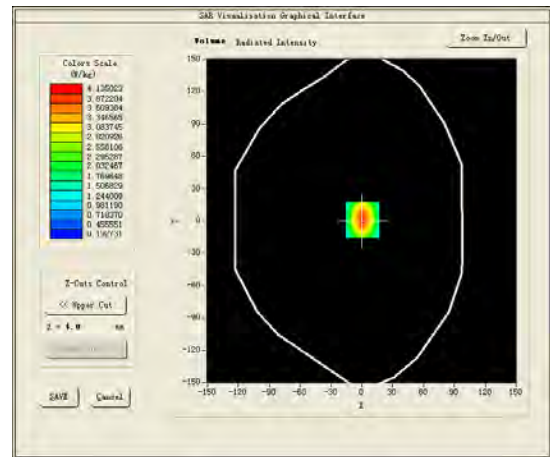
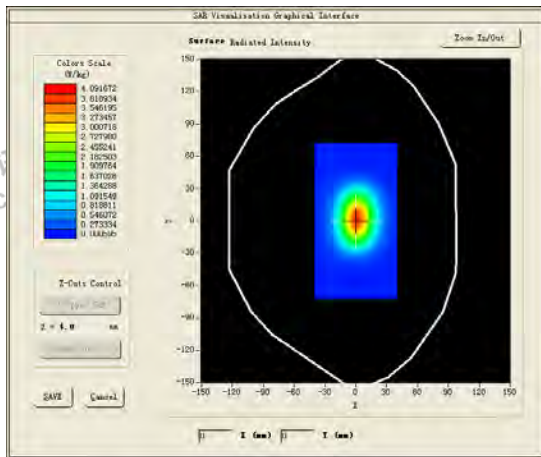

Test mode:1900MHz(Head)
 Product Description:Validation
 Model :Dipole SID1900
 E-Field Probe:SSE2(SN 25/22 EPGO376)
 Test Date: December 13, 2022

Medium(liquid type)	HSL_1900
Frequency (MHz)	1900.0000
Relative permittivity (real part)	38.56
Conductivity (S/m)	1.37
Input power	100mW
Crest Factor	1.0
Conversion Factor	2.14
Variation (%)	-1.200000
SAR 10g (W/Kg)	2.096260
SAR 1g (W/Kg)	3.911162

SURFACE SAR

VOLUME SAR

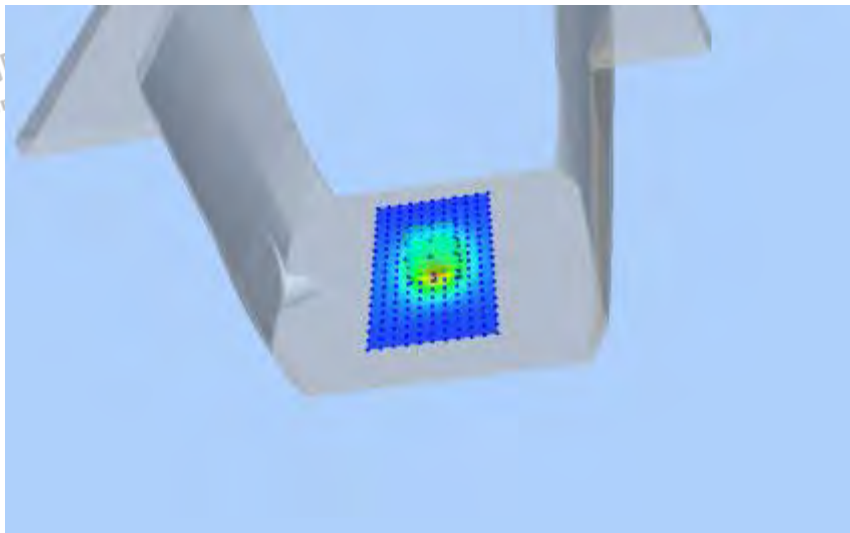
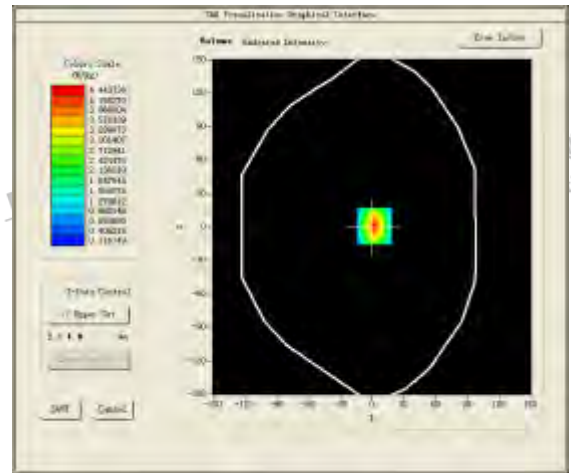
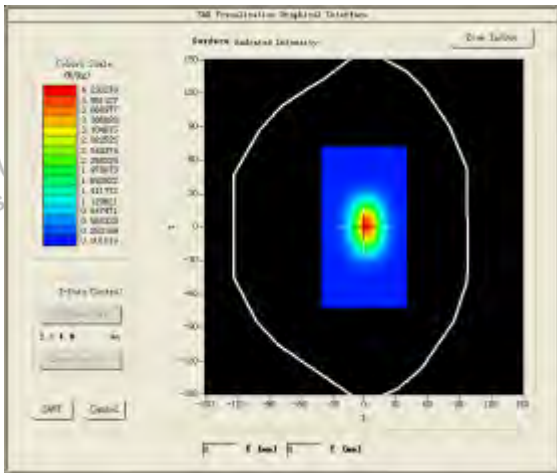



Test mode:2450MHz(Head)
 Product Description:Validation
 Model:Dipole SID2450
 E-Field Probe:SSE2(SN 25/22 EPGO376)
 Test Date: December 14, 2022

Medium(liquid type)	HSL_2450
Frequency (MHz)	2450.0000
Relative permittivity (real part)	39.70
Conductivity (S/m)	1.84
Input power	100mW
Crest Factor	1.0
Conversion Factor	2.60
Variation (%)	-0.080000
SAR 10g (W/Kg)	2.521463
SAR 1g (W/Kg)	5.487016
SURFACE SAR	VOLUME SAR

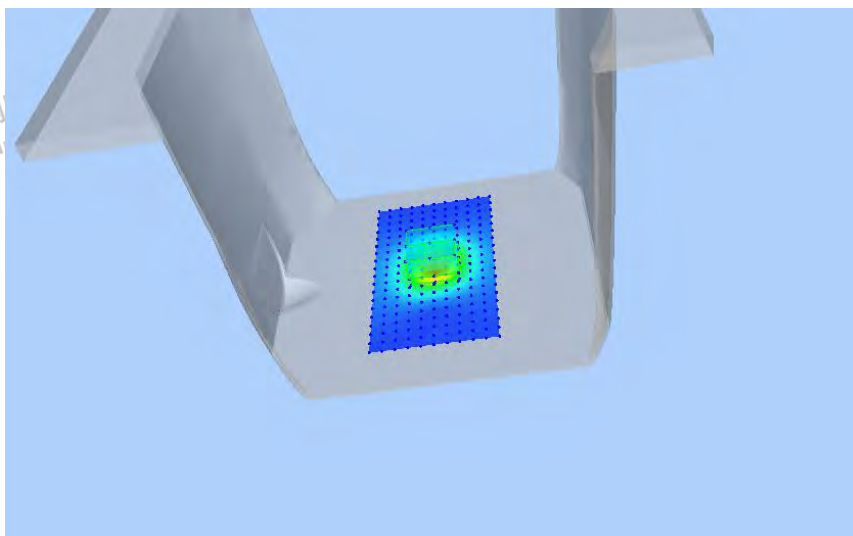
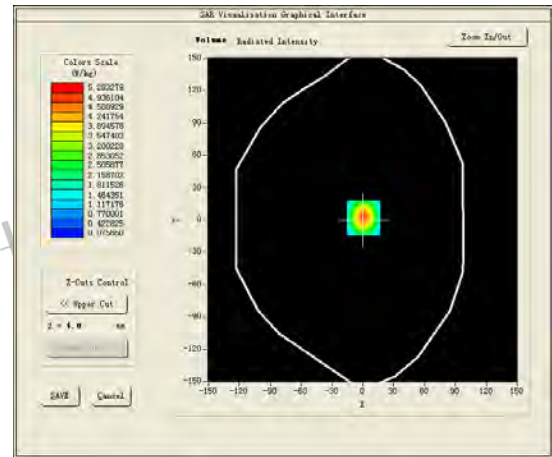
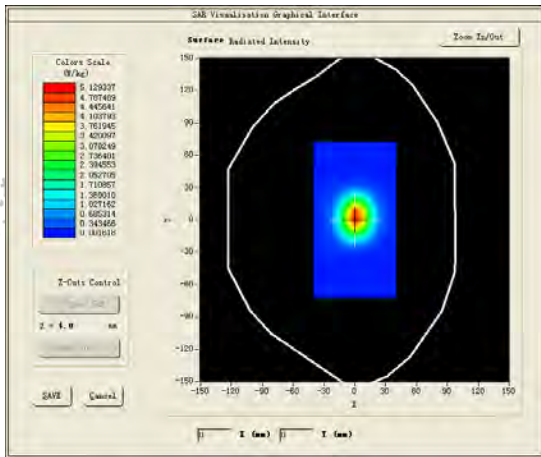

Test mode:2600MHz

Product Description:Validation

Model:Dipole SID2600

E-Field Probe: SSE2(SN 25/22 EPGO376)

Test Date: January 03, 2023

Medium(liquid type)	HSL_2600
Frequency (MHz)	2600.0000
Relative permittivity (real part)	38.43
Conductivity (S/m)	1.92
Input power	100mW
Crest Factor	1.0
Conversion Factor	2.39
Variation (%)	3.140000
SAR 10g (W/Kg)	2.246235
SAR 1g (W/Kg)	5.747023

SURFACE SAR

VOLUME SAR

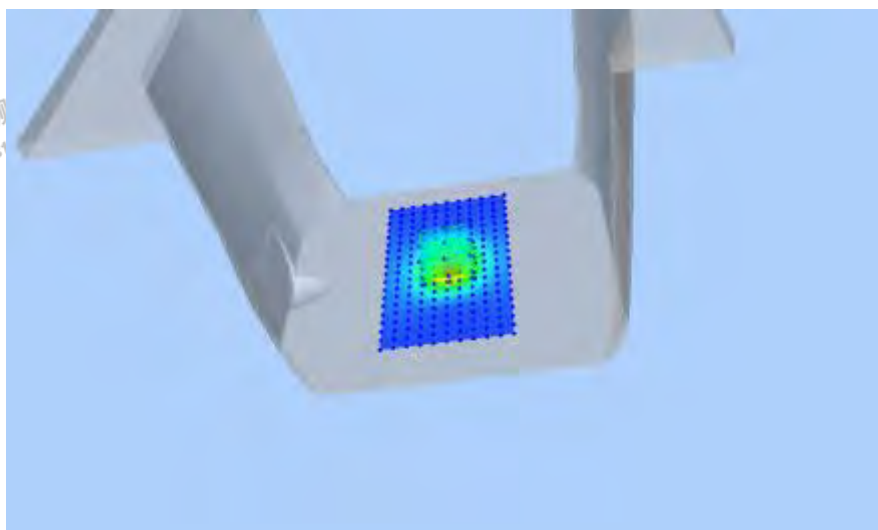
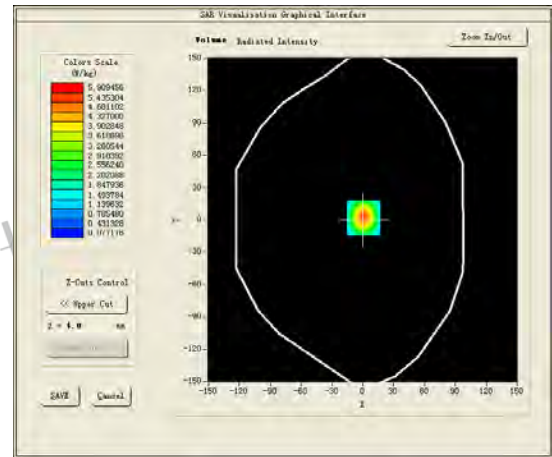
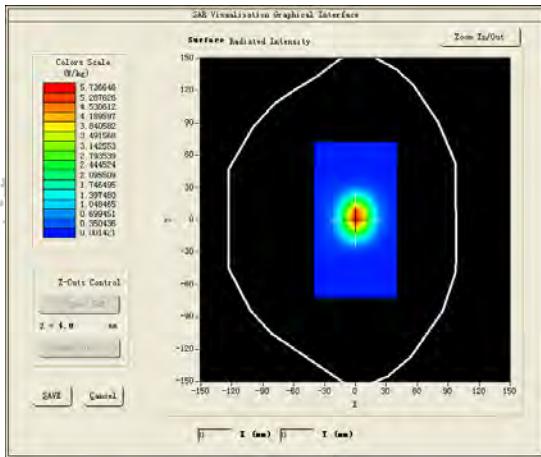



4.9. SAR Test Graph Results

SAR plots for the highest measured SAR in each exposure configuration, wireless mode and frequency band combination

#1 Test Mode: GSM850MHz, Low channel(Body Rear Side)

Product Description: POS Terminal

Model: P600

Test Date: December 10, 2022

Medium(liquid type)	HSL_850
Frequency (MHz)	824.2000
Relative permittivity (real part)	42.82
Conductivity (S/m)	0.92
E-Field Probe	SN 25/22 EPG0376
Crest Factor	2.0
Conversion Factor	1.75
Sensor	4mm
Area Scan	dx=8mm dy=8mm
Zoom Scan	5x5x7,dx=8mm dy=8mm dz=5mm
Variation (%)	-0.370000
SAR 10g (W/Kg)	0.123303
SAR 1g (W/Kg)	0.260314
SURFACE SAR	VOLUME SAR

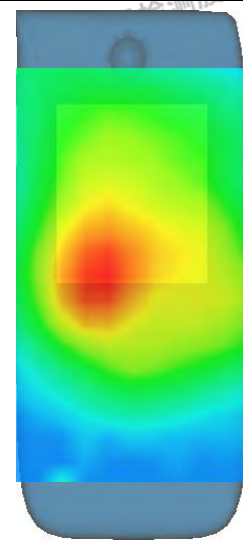
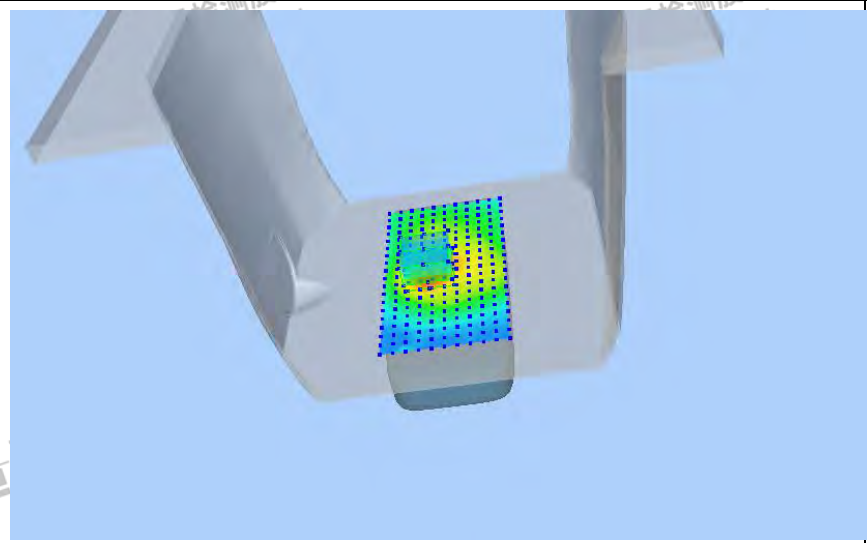
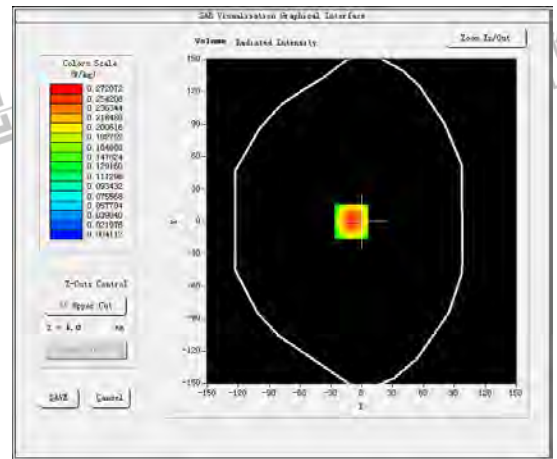
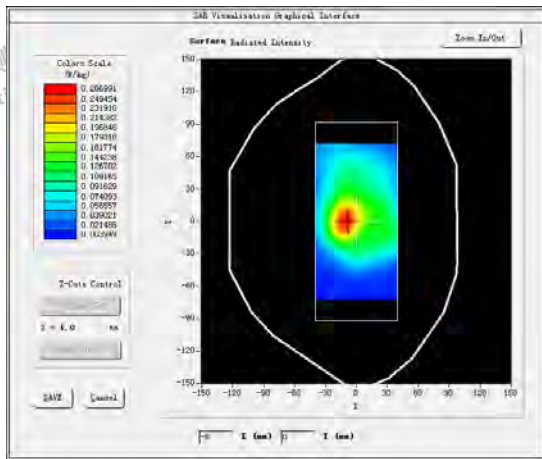

#2

Test Mode: GPRS1900MHz,High channel(Body Rear Side)

Product Description:POS Terminal

Model:P600

Test Date: December 13, 2022

Medium(liquid type)	HSL_1900
Frequency (MHz)	1909.8000
Relative permittivity (real part)	38.56
Conductivity (S/m)	1.37
E-Field Probe	SN 25/22 EPGO376
Crest Factor	2.0
Conversion Factor	2.14
Sensor	4mm
Area Scan	dx=8mm dy=8mm
Zoom Scan	5x5x7,dx=8mm dy=8mm dz=5mm
Variation (%)	-1.310000
SAR 10g (W/Kg)	0.058592
SAR 1g (W/Kg)	0.123818

SURFACE SAR

VOLUME SAR

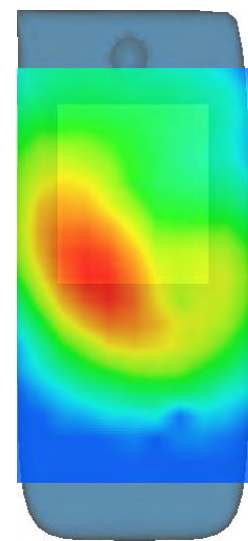
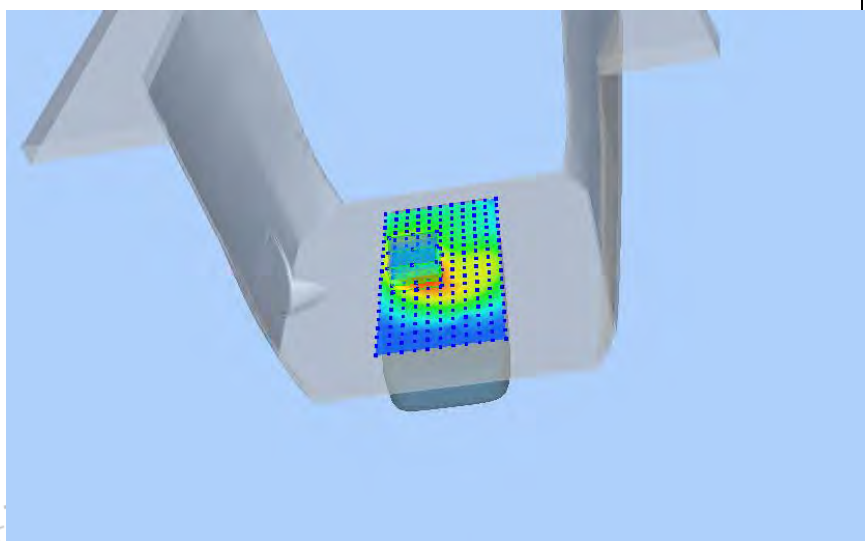
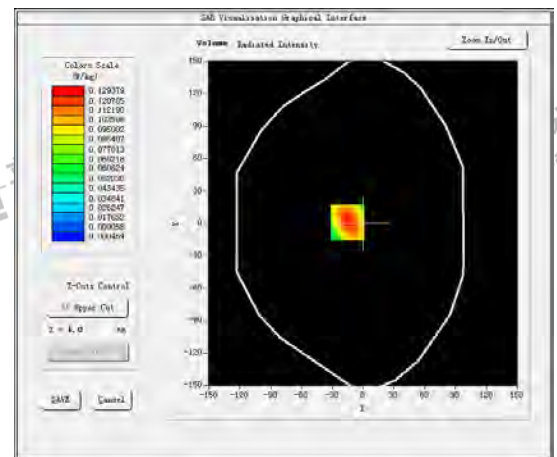
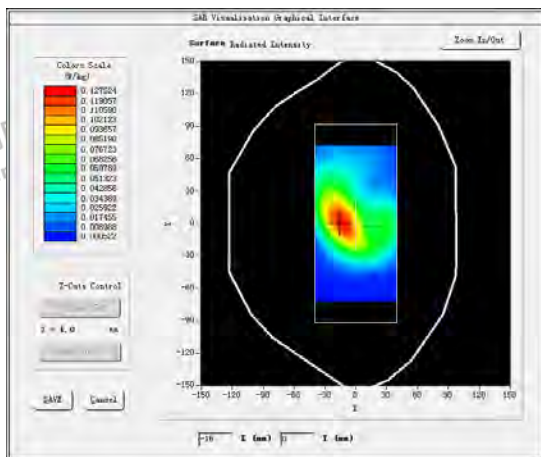

#3

Test Mode: WCDMA Band V, Middle channel(Body Rear Side)

Product Description: POS Terminal

Model: P600

Test Date: December 10, 2022

Medium(liquid type)	HSL_850
Frequency (MHz)	836.6000
Relative permittivity (real part)	42.82
Conductivity (S/m)	0.92
E-Field Probe	SN 25/22 EPGO376
Crest Factor	1.0
Conversion Factor	1.75
Sensor	4mm
Area Scan	dx=8mm dy=8mm
Zoom Scan	5x5x7,dx=8mm dy=8mm dz=5mm
Variation (%)	-0.370000
SAR 10g (W/Kg)	0.146655
SAR 1g (W/Kg)	0.313350

SURFACE SAR

VOLUME SAR

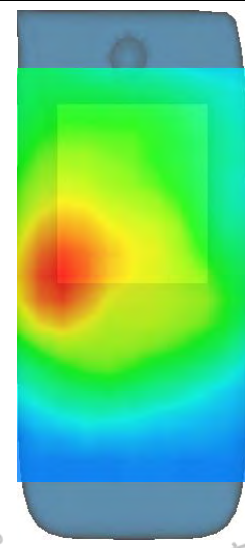
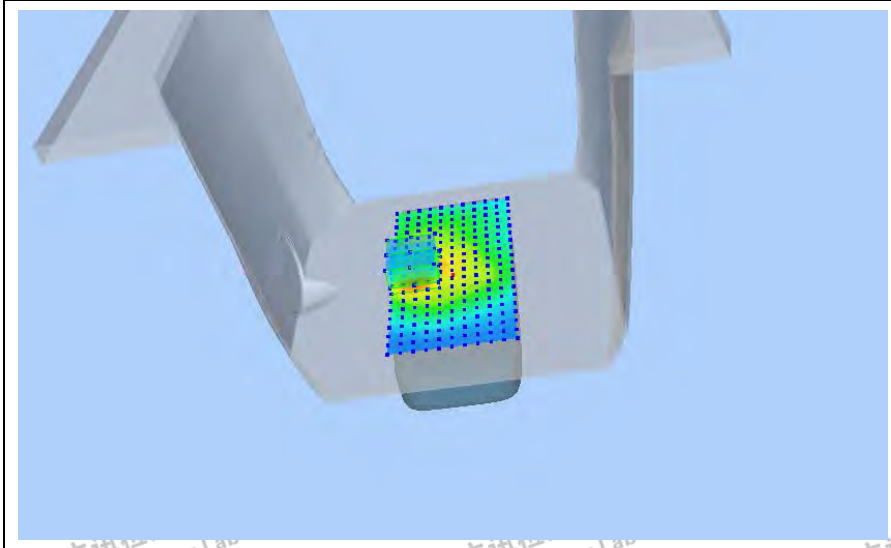
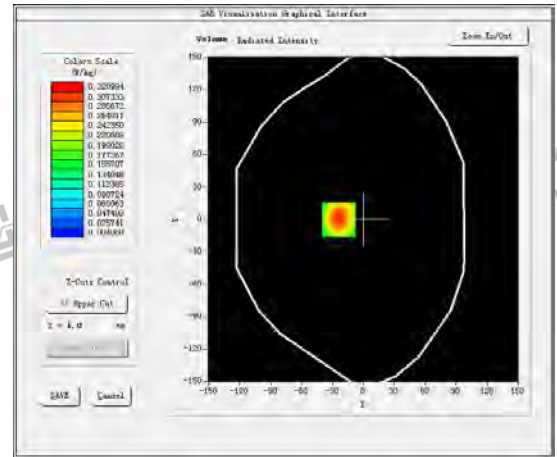
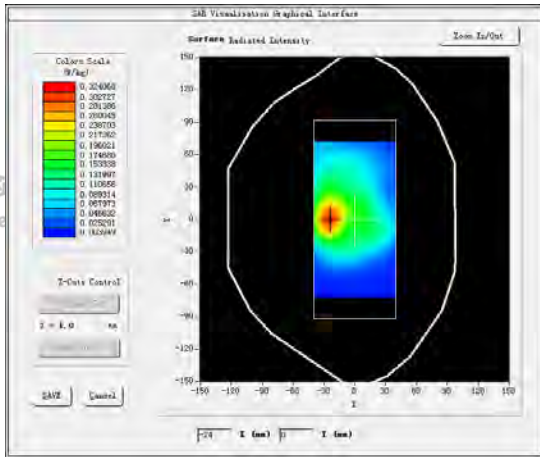

#4

Test Mode: WCDMA Band II, Middle channel(Body Rear Side)

Product Description: POS Terminal

Model: P600

Test Date: December 13, 2022

Medium(liquid type)	HSL_1900
Frequency (MHz)	1880.0000
Relative permittivity (real part)	38.56
Conductivity (S/m)	1.37
E-Field Probe	SN 25/22 EPGO376
Crest Factor	1.0
Conversion Factor	2.14
Sensor	4mm
Area Scan	dx=8mm dy=8mm
Zoom Scan	5x5x7,dx=8mm dy=8mm dz=5mm
Variation (%)	0.410000
SAR 10g (W/Kg)	0.086277
SAR 1g (W/Kg)	0.179581
SURFACE SAR	VOLUME SAR

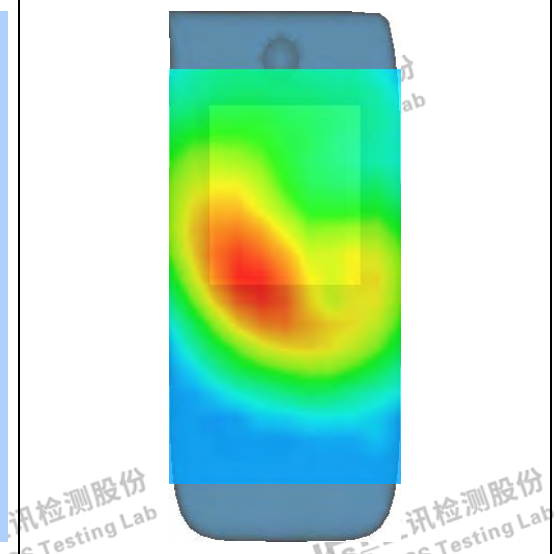
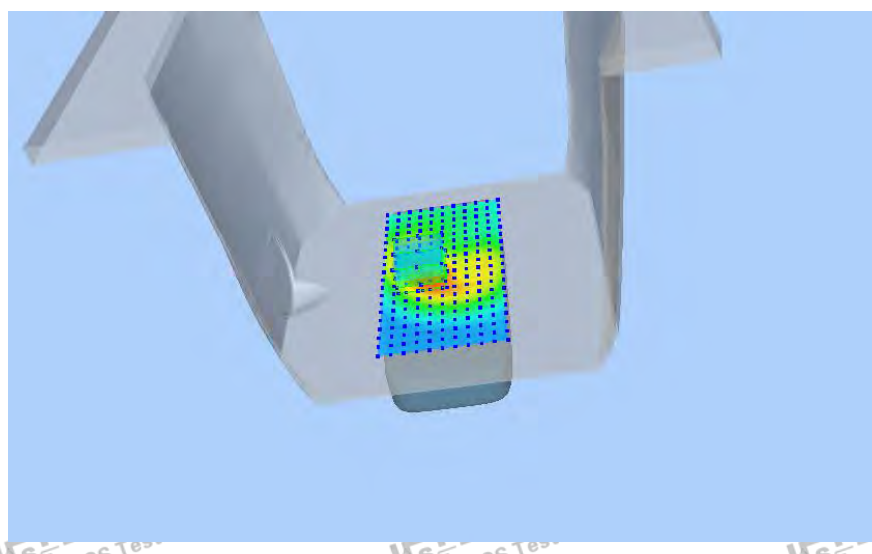
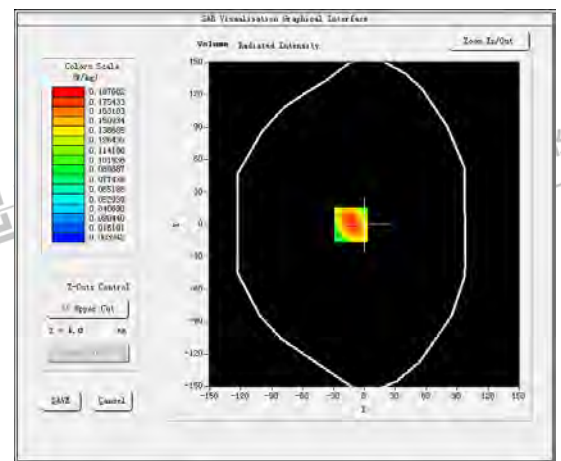
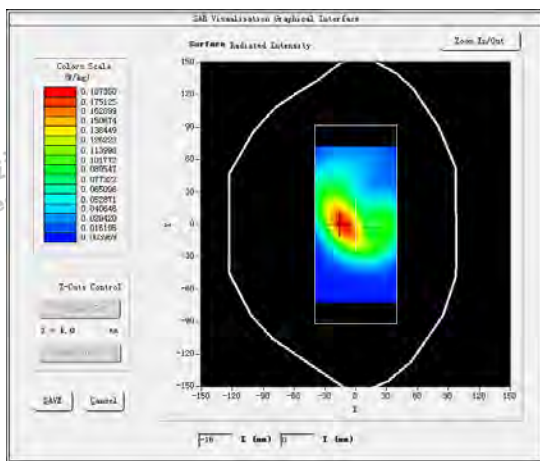



#5

Test Mode: LTE Band 2, 1RB, Middle channel (Body Rear Side)

Product Description: POS Terminal

Model: P600

Test Date: December 13, 2022

Medium (liquid type)	HSL_1900
Frequency (MHz)	1880.0000
Relative permittivity (real part)	38.56
Conductivity (S/m)	1.37
E-Field Probe	SN 25/22 EPGO376
Crest Factor	1.0
Conversion Factor	2.14
Sensor	4mm
Area Scan	dx=8mm dy=8mm
Zoom Scan	5x5x7, dx=8mm dy=8mm dz=5mm
Variation (%)	-1.790000
SAR 10g (W/Kg)	0.082393
SAR 1g (W/Kg)	0.169388
SURFACE SAR	VOLUME SAR

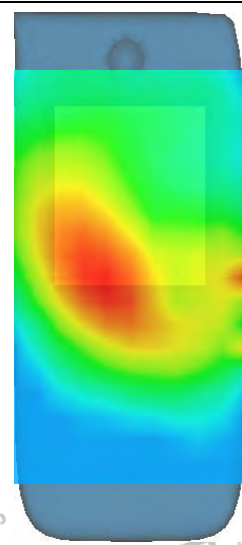
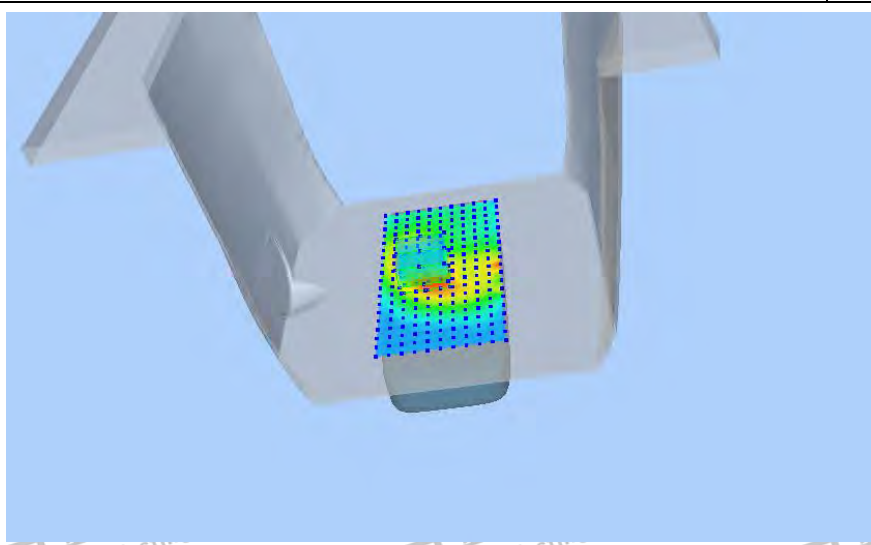
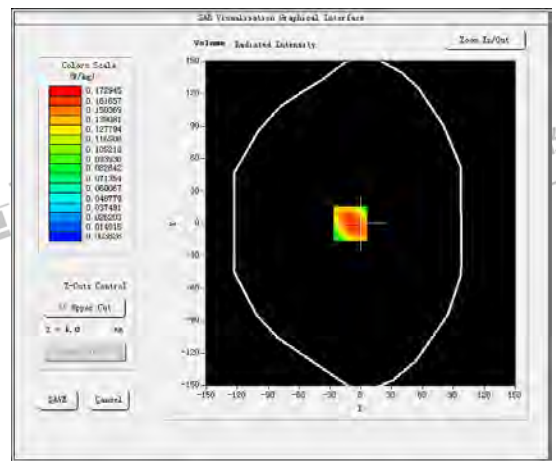
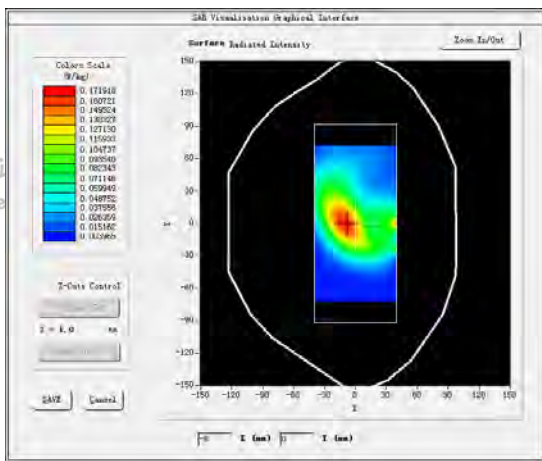



#6

Test Mode: LTE Band 4, 1RB, High channel (Body Rear Side)

Product Description: POS Terminal

Model: P600

Test Date: December 12, 2022

Medium (liquid type)	HSL_1800
Frequency (MHz)	1745.0000
Relative permittivity (real part)	52.11
Conductivity (S/m)	1.56
E-Field Probe	SN 25/22 EPGO376
Crest Factor	1.0
Conversion Factor	2.09
Sensor	4mm
Area Scan	dx=8mm dy=8mm
Zoom Scan	5x5x7, dx=8mm dy=8mm dz=5mm
Variation (%)	-0.650000
SAR 10g (W/Kg)	0.227607
SAR 1g (W/Kg)	0.500972

SURFACE SAR

VOLUME SAR

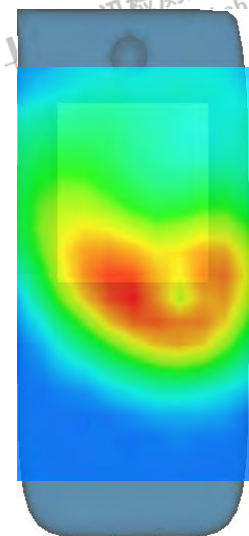
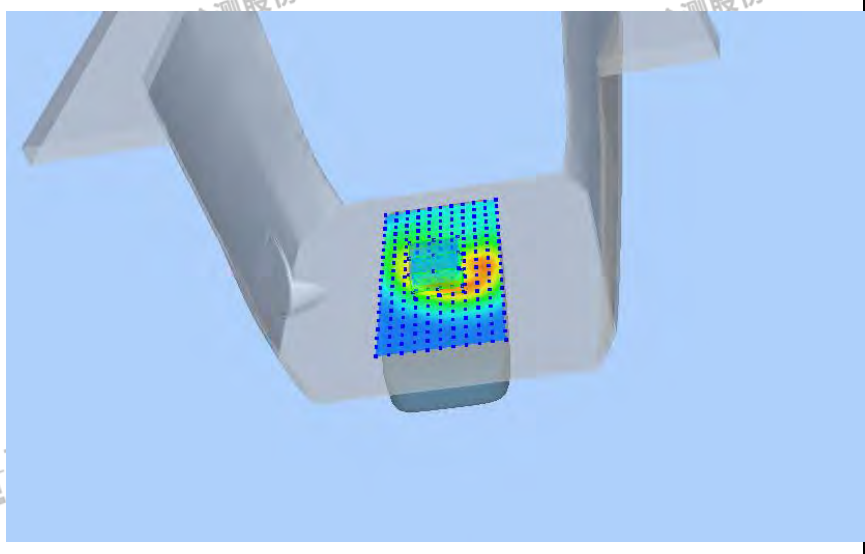
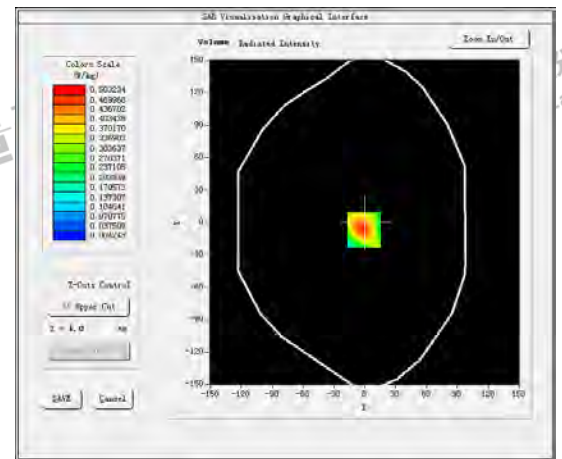
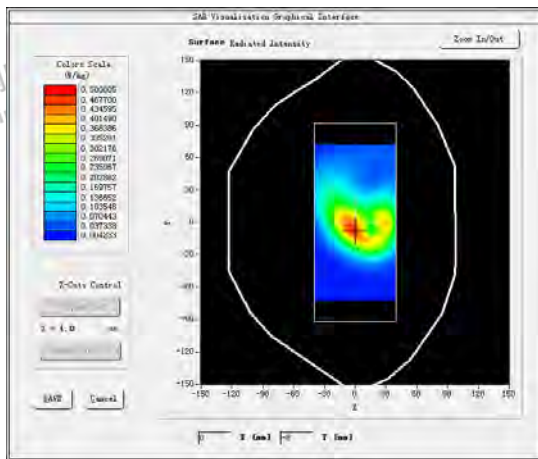

#7

Test Mode: LTE Band 7, 1RB, High channel (Body Rear Side)

Product Description: POS Terminal

Model: P600

Test Date: January 03, 2023

Medium (liquid type)	HSL_2600
Frequency (MHz)	2560.0000
Relative permittivity (real part)	38.43
Conductivity (S/m)	1.92
E-Field Probe	SN 25/22 EPGO376
Crest Factor	1.0
Conversion Factor	2.39
Sensor	4mm
Area Scan	dx=8mm dy=8mm
Zoom Scan	5x5x7, dx=8mm dy=8mm dz=5mm
Variation (%)	-3.100000
SAR 10g (W/Kg)	0.121834
SAR 1g (W/Kg)	0.260177
SURFACE SAR	VOLUME SAR

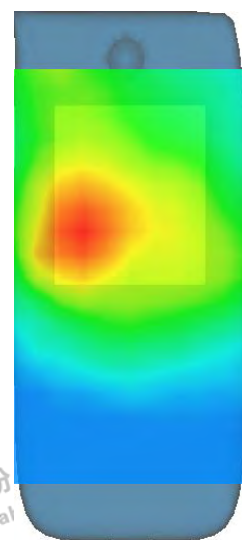
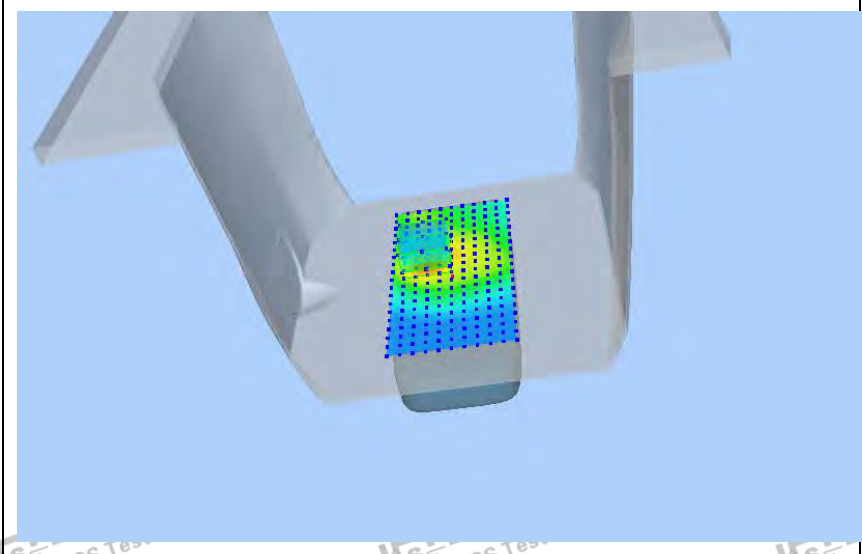
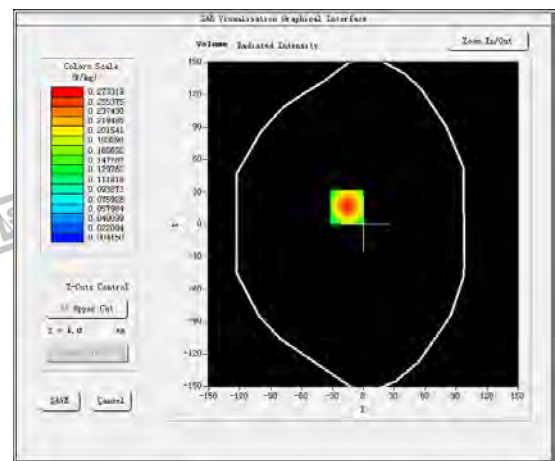
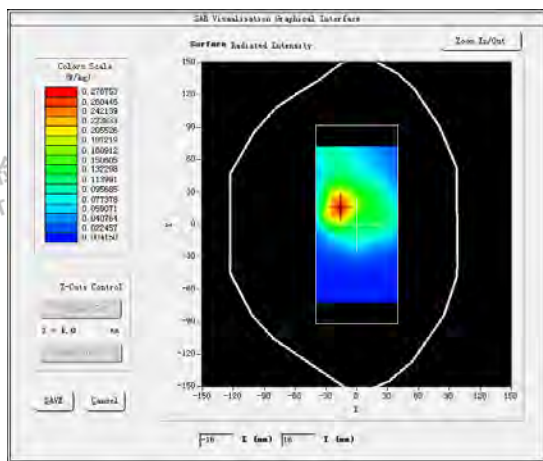

#8

Test Mode: 802.11b(WiFi2.4G),Low channel(Body Rear Side)

Product Description:POS Terminal

Model:P600

Test Date: December 14, 2022

Medium(liquid type)	HSL_2450
Frequency (MHz)	2412.0000
Relative permittivity (real part)	39.70
Conductivity (S/m)	1.84
E-Field Probe	SN 25/22 EPGO376
Crest Factor	1.0
Conversion Factor	2.60
Sensor	4mm
Area Scan	dx=8mm dy=8mm
Zoom Scan	5x5x7,dx=8mm dy=8mm dz=5mm
Variation (%)	-1.470000
SAR 10g (W/Kg)	0.032650
SAR 1g (W/Kg)	0.071563
SURFACE SAR	VOLUME SAR

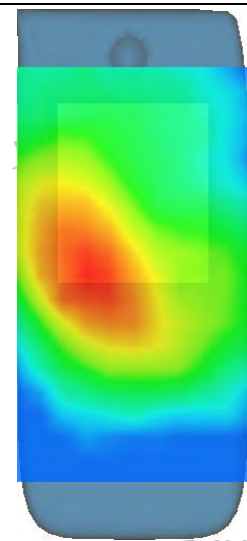
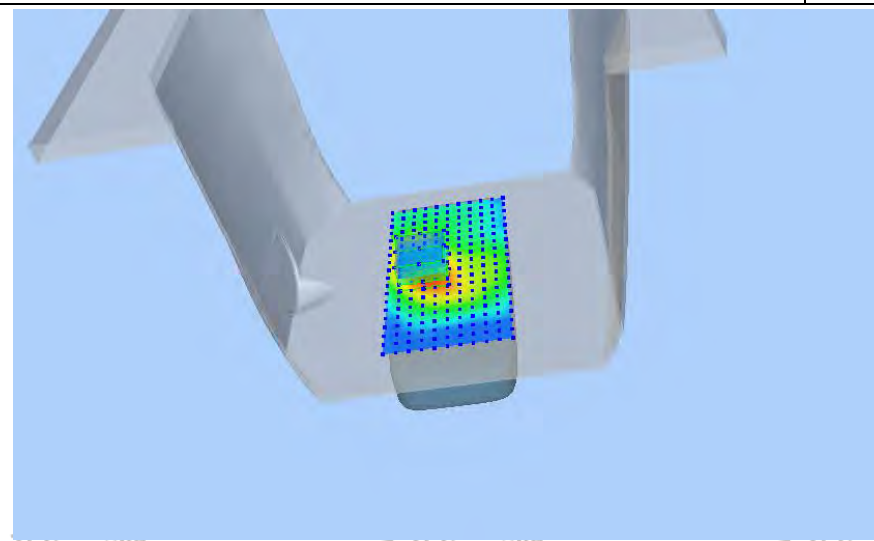
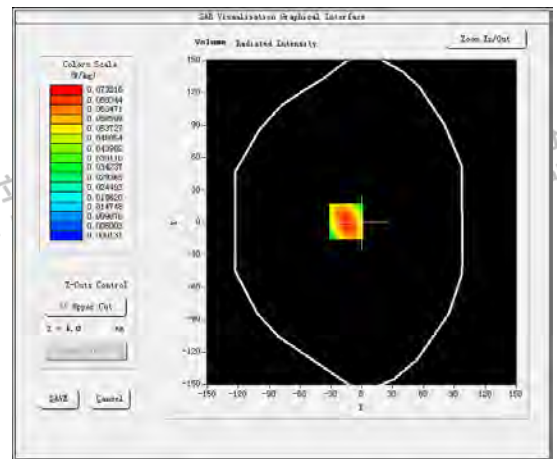
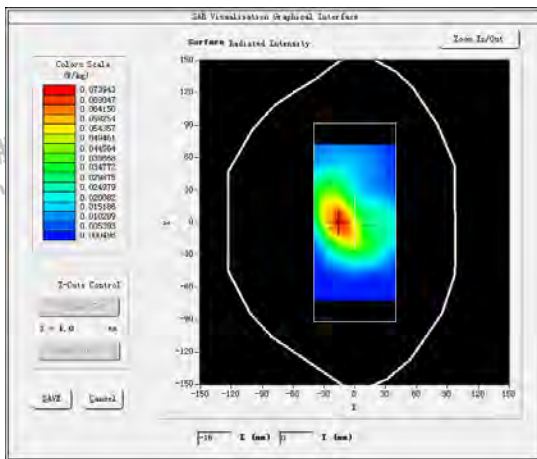



5. CALIBRATION CERTIFICATES

5.1 Probe-EPGO376 Calibration Certificate



COMOSAR E-Field Probe Calibration Report

Ref: ACR.180.4.22.BES.A

SHENZHEN LCS COMPLIANCE TESTING LABORATORY LTD.

1F., XINGYUAN INDUSTRIAL PARK, TONGDA ROAD, BAO'AN BLVD

BAO'AN DISTRICT, SHENZHEN, GUANGDONG, CHINA

MVG COMOSAR DOSIMETRIC E-FIELD PROBE

SERIAL NO.: SN 25/22 EPGO376

Calibrated at MVG

Z.I. de la pointe du diable

Technopôle Brest Iroise – 295 avenue Alexis de Rochon

29280 PLOUZANE - FRANCE

Calibration date: 06/29/2022



Accreditations #2-6789

Scope available on www.cofrac.fr

The use of the Cofrac brand and the accreditation references is prohibited from any reproduction.

Summary:

This document presents the method and results from an accredited COMOSAR Dosimetric E-Field Probe calibration performed at MVG, using the CALIPROBE test bench, for use with a MVG COMOSAR system only. The test results covered by accreditation are traceable to the International System of Units (SI).





COMOSAR E-FIELD PROBE CALIBRATION REPORT

Ref: ACR.180.4.22.BES.A

份
Lab

	Name	Function	Date	Signature
Prepared by :	Jérôme Le Gall	Measurement Responsible	6/30/2022	
Checked & approved by:	Jérôme Luc	Technical Manager	6/30/2022	
Authorized by:	Yann Toutain	Laboratory Director	6/30/2022	

2022.06.30
13:37:53 +02'00'

	Customer Name
Distribution :	Shenzhen LCS Compliance Testing Laboratory Ltd.

份
Lab

Issue	Name	Date	Modifications
A	Jérôme Le Gall	6/30/2022	Initial release

Template: ACR.DDD.N.YY.MVGH.ISSUE_COMOSAR Probe vK

This document shall not be reproduced, except in full or in part, without the written approval of MVG. The information contained herein is to be used only for the purpose for which it is submitted and is not to be released in whole or part without written approval of MVG.

份
Lab





COMOSAR E-FIELD PROBE CALIBRATION REPORT

Ref: ACR.180.4.22.BES.A

TABLE OF CONTENTS

1 Device Under Test 4

2 Product Description 4

 2.1 General Information 4

3 Measurement Method 4

 3.1 Linearity 4

 3.2 Sensitivity 4

 3.3 Lower Detection Limit 5

 3.4 Isotropy 5

 3.1 Boundary Effect 5

4 Measurement Uncertainty 6

5 Calibration Measurement Results 6

 5.1 Sensitivity in air 6

 5.2 Linearity 7

 5.3 Sensitivity in liquid 8

 5.4 Isotropy 9

6 List of Equipment 10

Page: 3/11

Template_ACR.DDD.N.YY.MVGB.ISSUE_COMOSAR Probe vK

This document shall not be reproduced, except in full or in part, without the written approval of MVG. The information contained herein is to be used only for the purpose for which it is submitted and is not to be released in whole or part without written approval of MVG.





1 DEVICE UNDER TEST

Device Under Test	
Device Type	COMOSAR DOSIMETRIC E FIELD PROBE
Manufacturer	MVG
Model	SSE2
Serial Number	SN 25/22 EPGO376
Product Condition (new / used)	New
Frequency Range of Probe	0.15 GHz-6GHz
Resistance of Three Dipoles at Connector	Dipole 1: R1=0.193 MΩ Dipole 2: R2=0.188 MΩ Dipole 3: R3=0.198 MΩ

2 PRODUCT DESCRIPTION

2.1 GENERAL INFORMATION

MVG's COMOSAR E field Probes are built in accordance to the IEC/IEEE 62209-1528 and FCC KDB865664 D01 standards.



Figure 1 – MVG COMOSAR Dosimetric E field Probe

Probe Length	330 mm
Length of Individual Dipoles	2 mm
Maximum external diameter	8 mm
Probe Tip External Diameter	2.5 mm
Distance between dipoles / probe extremity	1 mm

3 MEASUREMENT METHOD

The IEC/IEEE 62209-1528 and FCC KDB865664 D01 standards provide recommended practices for the probe calibrations, including the performance characteristics of interest and methods by which to assess their affect. All calibrations / measurements performed meet the fore mentioned standards.

3.1 LINEARITY

The evaluation of the linearity was done in free space using the waveguide, performing a power sweep to cover the SAR range 0.01W/kg to 100W/kg.

3.2 SENSITIVITY

The sensitivity factors of the three dipoles were determined using a two step calibration method (air and tissue simulating liquid) using waveguides as outlined in the standards.

Page: 4/11

Template_ACR.DDB.N.YY.MVGB.ISSUE_COMOSAR Probe v8

This document shall not be reproduced, except in full or in part, without the written approval of MVG. The information contained herein is to be used only for the purpose for which it is submitted and is not to be released in whole or part without written approval of MVG.





3.3 LOWER DETECTION LIMIT

The lower detection limit was assessed using the same measurement set up as used for the linearity measurement. The required lower detection limit is 10 mW/kg.

3.4 ISOTROPY

The axial isotropy was evaluated by exposing the probe to a reference wave from a standard dipole with the dipole mounted under the flat phantom in the test configuration suggested for system validations and checks. The probe was rotated along its main axis from 0 to 360 degrees in 15-degree steps. The hemispherical isotropy is determined by inserting the probe in a thin plastic box filled with tissue-equivalent liquid, with the plastic box illuminated with the fields from a half wave dipole. The dipole is rotated about its axis (0°–180°) in 15° increments. At each step the probe is rotated about its axis (0°–360°).

3.1 BOUNDARY EFFECT

The boundary effect is defined as the deviation between the SAR measured data and the expected exponential decay in the liquid when the probe is oriented normal to the interface. To evaluate this effect, the liquid filled flat phantom is exposed to fields from either a reference dipole or waveguide. With the probe normal to the phantom surface, the peak spatial average SAR is measured and compared to the analytical value at the surface.

The boundary effect uncertainty can be estimated according to the following uncertainty approximation formula based on linear and exponential extrapolations between the surface and $d_{be} + d_{step}$ along lines that are approximately normal to the surface:

$$SAR_{uncertainty} [\%] = \Delta SAR_{be} \frac{(d_{be} + d_{step})^2}{2d_{step}} \frac{(e^{-d_{be}/(\delta/2)})}{\delta/2} \text{ for } (d_{be} + d_{step}) < 10 \text{ mm}$$

- where
- $SAR_{uncertainty}$ is the uncertainty in percent of the probe boundary effect
- d_{be} is the distance between the surface and the closest *zoom-scan* measurement point, in millimetre
- Δ_{step} is the separation distance between the first and second measurement points that are closest to the phantom surface, in millimetre, assuming the boundary effect at the second location is negligible
- δ is the minimum penetration depth in millimetres of the head tissue-equivalent liquids defined in this standard, i.e., $\delta \approx 14$ mm at 3 GHz;
- ΔSAR_{be} in percent of SAR is the deviation between the measured SAR value, at the distance d_{be} from the boundary, and the analytical SAR value.

The measured worst case boundary effect SAR uncertainty[%] for scanning distances larger than 4mm is 1.0% Limit ,2%).





4 MEASUREMENT UNCERTAINTY

The guidelines outlined in the IEC/IEEE 62209-1528 and FCC KDB865664 D01 standards were followed to generate the measurement uncertainty associated with an E-field probe calibration using the waveguide technique. All uncertainties listed below represent an expanded uncertainty expressed at approximately the 95% confidence level using a coverage factor of k=2, traceable to the Internationally Accepted Guides to Measurement Uncertainty.

Uncertainty analysis of the probe calibration in waveguide					
ERROR SOURCES	Uncertainty value (%)	Probability Distribution	Divisor	ci	Standard Uncertainty (%)
Expanded uncertainty 95 % confidence level k = 2					14 %

5 CALIBRATION MEASUREMENT RESULTS

Calibration Parameters	
Liquid Temperature	20 +/- 1 °C
Lab Temperature	20 +/- 1 °C
Lab Humidity	30-70 %

5.1 SENSITIVITY IN AIR

Normx dipole 1 (µV/(V/m) ²)	Normy dipole 2 (µV/(V/m) ²)	Normz dipole 3 (µV/(V/m) ²)
0.76	0.78	0.76

DCP dipole 1 (mV)	DCP dipole 2 (mV)	DCP dipole 3 (mV)
106	107	108

Calibration curves $e_i=f(V)$ (i=1,2,3) allow to obtain E-field value using the formula:

$$E = \sqrt{E_1^2 + E_2^2 + E_3^2}$$





COMOSAR E-FIELD PROBE CALIBRATION REPORT

Ref: ACR.180.4.22.BES.A

份
Lab

Calibration curves

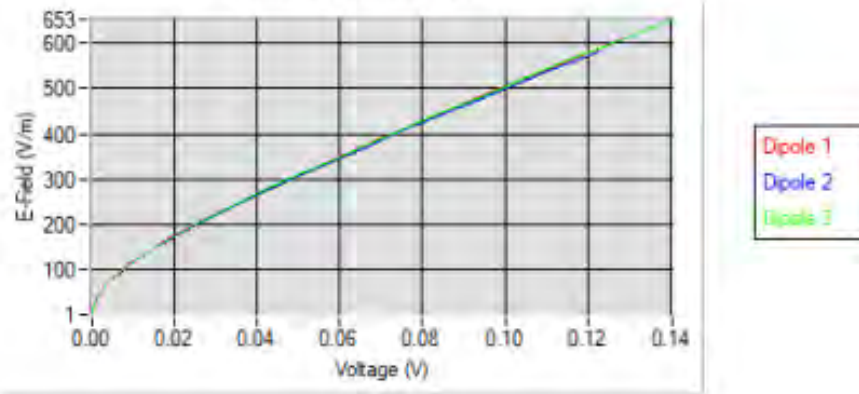

5.2 LINEARITY

Linearity

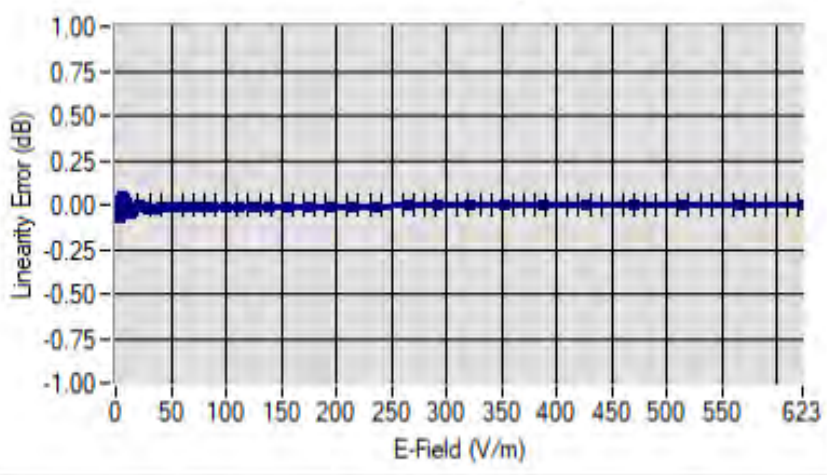

Linearity: +/-1.81% (+/-0.08dB)

Template: ACR.DDD.N.YY.MVGB.ISSUE_COMOSAR Probe vK

This document shall not be reproduced, except in full or in part, without the written approval of MVG. The information contained herein is to be used only for the purpose for which it is submitted and is not to be released in whole or part without written approval of MVG.

份
Lab



份
Lab

份
Lab



COMOSAR E-FIELD PROBE CALIBRATION REPORT

Ref: ACR.180.4.22.BES.A

股份
ng Lab

5.3 SENSITIVITY IN LIQUID

Liquid	Frequency (MHz +/- 100MHz)	ConvF
HL450*	450*	1.74*
BL450*	450*	1.67*
HL750	750	1.69
BL750	750	1.73
HL850	835	1.75
BL850	835	1.80
HL900	900	1.87
BL900	900	1.85
HL1800	1800	2.09
BL1800	1800	2.15
HL1900	1900	2.14
BL1900	1900	2.27
HL2000	2000	2.31
BL2000	2000	2.34
HL2300	2300	2.46
BL2300	2300	2.51
HL2450	2450	2.60
BL2450	2450	2.70
HL2600	2600	2.39
BL2600	2600	2.50
HL5200	5200	1.85
BL5200	5200	1.81
HL5400	5400	2.07
BL5400	5400	2.00
HL5600	5600	2.19
BL5600	5600	2.11
HL5800	5800	2.01
BL5800	5800	1.97

* Frequency not cover by COFRAC scope, calibration not accredited

LOWER DETECTION LIMIT: 7mW/kg

Template: ACR.DDD.X.YY.MVGB.ISSUE_COMOSAR Probe vK

This document shall not be reproduced, except in full or in part, without the written approval of MVG. The information contained herein is to be used only for the purpose for which it is submitted and is not to be released in whole or part without written approval of MVG.

股份
ng Lab





COMOSAR E-FIELD PROBE CALIBRATION REPORT

Ref: ACR.180.4.22.BES.A

股份
ig Lab

5.4 ISOTROPY

HL1800 MHz

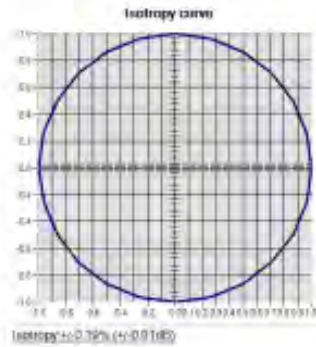

股份
ig Lab

Template_ACR.DDD.N.YY.MVGB.ISSUE_COMOSAR Probe vK

This document shall not be reproduced, except in full or in part, without the written approval of MVG. The information contained herein is to be used only for the purpose for which it is submitted and is not to be released in whole or part without written approval of MVG.

股份
ig Lab





COMOSAR E-FIELD PROBE CALIBRATION REPORT

Ref: ACR.180.4.22.BES.A

股份
ig Lab

6 LIST OF EQUIPMENT

Equipment Summary Sheet				
Equipment Description	Manufacturer / Model	Identification No.	Current Calibration Date	Next Calibration Date
CALIPROBE Test Bench	Version 2	NA	Validated. No cal required.	Validated. No cal required.
Network Analyzer	Rohde & Schwarz ZVM	100203	08/2021	08/2024
Network Analyzer	Agilent 8753ES	MY40003210	10/2019	10/2022
Network Analyzer – Calibration kit	HP 85033D	3423A08186	06/2021	06/2027
Multimeter	Keithley 2000	1160271	02/2020	02/2023
Signal Generator	Rohde & Schwarz SMB	106589	03/2022	03/2025
Amplifier	MVG	MODU-023-C-0002	Characterized prior to test. No cal required.	Characterized prior to test. No cal required.
Power Meter	NI-USB 5680	170100013	06/2021	06/2024
Power Meter	Rohde & Schwarz NRVD	832839-056	11/2019	11/2022
Directional Coupler	Krytar 158020	131467	Characterized prior to test. No cal required.	Characterized prior to test. No cal required.
Waveguide	MVG	SN 32/16 WG4_1	Validated. No cal required.	Validated. No cal required.
Liquid transition	MVG	SN 32/16 WGLIQ_0G900_1	Validated. No cal required.	Validated. No cal required.
Waveguide	MVG	SN 32/16 WG6_1	Validated. No cal required.	Validated. No cal required.
Liquid transition	MVG	SN 32/16 WGLIQ_1G500_1	Validated. No cal required.	Validated. No cal required.
Waveguide	MVG	SN 32/16 WG8_1	Validated. No cal required.	Validated. No cal required.
Liquid transition	MVG	SN 32/16 WGLIQ_1G800B_1	Validated. No cal required.	Validated. No cal required.
Liquid transition	MVG	SN 32/16 WGLIQ_1G800H_1	Validated. No cal required.	Validated. No cal required.
Waveguide	MVG	SN 32/16 WG10_1	Validated. No cal required.	Validated. No cal required.
Liquid transition	MVG	SN 32/16 WGLIQ_3G500_1	Validated. No cal required.	Validated. No cal required.
Waveguide	MVG	SN 32/16 WG12_1	Validated. No cal required.	Validated. No cal required.

Page: 10/11

Template_ACR.DDD.N.YY.MVGB.ISSUE_COMOSAR Probe v6

This document shall not be reproduced, except in full or in part, without the written approval of MVG. The information contained herein is to be used only for the purpose for which it is submitted and is not to be released in whole or part without written approval of MVG.

股份
ig Lab

股份
ig Lab





COMOSAR E-FIELD PROBE CALIBRATION REPORT

Ref: ACR.180.4.22.BES.A

股份
ng Lab

Liquid transition	MVG	SN 32/16 WGLIQ_5G000_1	Validated. No cal required.	Validated. No cal required.
Temperature / Humidity Sensor	Testo 184 H1	44225320	06/2021	06/2024

股份
ng Lab

Page: 11/11

Template_ACR.DDD.N.YY.MVGB,ISSUE_COMOSAR Probe vR

This document shall not be reproduced, except in full or in part, without the written approval of MVG. The information contained herein is to be used only for the purpose for which it is submitted and is not to be released in whole or part without written approval of MVG.

股份
ng Lab





5.2 SID835 Dipole Calibration Certificate



SAR Reference Dipole Calibration Report

Ref : ACR.287.4.14.SATU.A

**SHENZHEN LCS COMPLIANCE TESTING
LABORATORY LTD.**
**1F., XINGYUAN INDUSTRIAL PARK, TONGDA ROAD,
BAO'AN BLVD**
BAO'AN DISTRICT, SHENZHEN, GUANGDONG, CHINA
SATIMO COMOSAR REFERENCE DIPOLE
FREQUENCY: 835 MHZ
SERIAL NO.: SN 07/14 DIP 0G835-303

Calibrated at SATIMO US
2105 Barrett Park Dr. - Kennesaw, GA 30144



09/29/2021

Summary:

This document presents the method and results from an accredited SAR reference dipole calibration performed in SATIMO USA using the COMOSAR test bench. All calibration results are traceable to national metrology institutions.



测股份
ing Lab

测股份
ing Lab

测股份
ing Lab



SAR REFERENCE DIPOLE CALIBRATION REPORT

Ref: ACR 2874-14.SATIM.A

股份
ig Lab

	<i>Name</i>	<i>Function</i>	<i>Date</i>	<i>Signature</i>
<i>Prepared by :</i>	Jérôme LUC	Product Manager	10/12/2021	
<i>Checked by :</i>	Jérôme LUC	Product Manager	10/12/2021	
<i>Approved by :</i>	Kim RUTKOWSKI	Quality Manager	10/12/2021	

	<i>Customer Name</i>
<i>Distribution :</i>	Shenzhen LCS Compliance Testing Laboratory Ltd.

<i>Issue</i>	<i>Date</i>	<i>Modifications</i>
A	10/12/2021	Initial release

*This document shall not be reproduced, except in full or in part, without the written approval of SATIMO.
The information contained herein is to be used only for the purpose for which it is submitted and is not to
be released in whole or part without written approval of SATIMO.*

股份
ig Lab

股份
ig Lab





股份
ig Lab

TABLE OF CONTENTS

1	Introduction.....	4
2	Device Under Test.....	4
3	Product Description.....	4
3.1	General Information.....	4
4	Measurement Method.....	5
4.1	Return Loss Requirements.....	5
4.2	Mechanical Requirements.....	5
5	Measurement Uncertainty.....	5
5.1	Return Loss.....	5
5.2	Dimension Measurement.....	5
5.3	Validation Measurement.....	5
6	Calibration Measurement Results.....	6
6.1	Return Loss and Impedance.....	6
6.2	Mechanical Dimensions.....	6
7	Validation measurement.....	7
7.1	Head Liquid Measurement.....	7
7.2	SAR Measurement Result With Head Liquid.....	7
7.3	Body Liquid Measurement.....	9
7.4	SAR Measurement Result With Body Liquid.....	9
8	List of Equipment.....	11

股份
ig Lab

*This document shall not be reproduced, except in full or in part, without the written approval of SATIMO.
The information contained herein is to be used only for the purpose for which it is submitted and is not to
be released in whole or part without written approval of SATIMO.*

股份
ig Lab



1 INTRODUCTION

This document contains a summary of the requirements set forth by the IEEE 1528, OET 65 Bulletin C and CEI/IEC 62209 standards for reference dipoles used for SAR measurement system validations and the measurements that were performed to verify that the product complies with the fore mentioned standards.

2 DEVICE UNDER TEST

Device Under Test	
Device Type	COMOSAR 835 MHz REFERENCE DIPOLE
Manufacturer	Satimo
Model	SID835
Serial Number	SN 07/14 DIP 0G835-303
Product Condition (new / used)	New

A yearly calibration interval is recommended.

3 PRODUCT DESCRIPTION

3.1 GENERAL INFORMATION

Satimo's COMOSAR Validation Dipoles are built in accordance to the IEEE 1528, OET 65 Bulletin C and CEI/IEC 62209 standards. The product is designed for use with the COMOSAR test bench only.



Figure 1 – Satimo COMOSAR Validation Dipole

Page: 4/11

This document shall not be reproduced, except in full or in part, without the written approval of SATIMO. The information contained herein is to be used only for the purpose for which it is submitted and is not to be released in whole or part without written approval of SATIMO.





股份
ig Lab

4 MEASUREMENT METHOD

The IEEE 1528, OET 65 Bulletin C and CEI/IEC 62209 standards provide requirements for reference dipoles used for system validation measurements. The following measurements were performed to verify that the product complies with the fore mentioned standards.

4.1 RETURN LOSS REQUIREMENTS

The dipole used for SAR system validation measurements and checks must have a return loss of -20 dB or better. The return loss measurement shall be performed against a liquid filled flat phantom, with the phantom constructed as outlined in the fore mentioned standards.

4.2 MECHANICAL REQUIREMENTS

The IEEE Std. 1528 and CEI/IEC 62209 standards specify the mechanical components and dimensions of the validation dipoles, with the dimensions frequency and phantom shell thickness dependent. The COMOSAR test bench employs a 2 mm phantom shell thickness therefore the dipoles sold for use with the COMOSAR test bench comply with the requirements set forth for a 2 mm phantom shell thickness.

5 MEASUREMENT UNCERTAINTY

All uncertainties listed below represent an expanded uncertainty expressed at approximately the 95% confidence level using a coverage factor of k=2, traceable to the Internationally Accepted Guides to Measurement Uncertainty.

5.1 RETURN LOSS

The following uncertainties apply to the return loss measurement:

Frequency band	Expanded Uncertainty on Return Loss
400-6000MHz	0.1 dB

5.2 DIMENSION MEASUREMENT

The following uncertainties apply to the dimension measurements:

Length (mm)	Expanded Uncertainty on Length
3 - 300	0.05 mm

5.3 VALIDATION MEASUREMENT

The guidelines outlined in the IEEE 1528, OET 65 Bulletin C, CENELEC EN50361 and CEI/IEC 62209 standards were followed to generate the measurement uncertainty for validation measurements.

Scan Volume	Expanded Uncertainty
1 g	20.3 %
10 g	20.1 %

Page: 5/11

This document shall not be reproduced, except in full or in part, without the written approval of SATIMO. The information contained herein is to be used only for the purpose for which it is submitted and is not to be released in whole or part without written approval of SATIMO.

股份
ig Lab

股份
ig Lab





股份
ig Lab

6 CALIBRATION MEASUREMENT RESULTS

6.1 RETURN LOSS AND IMPEDANCE

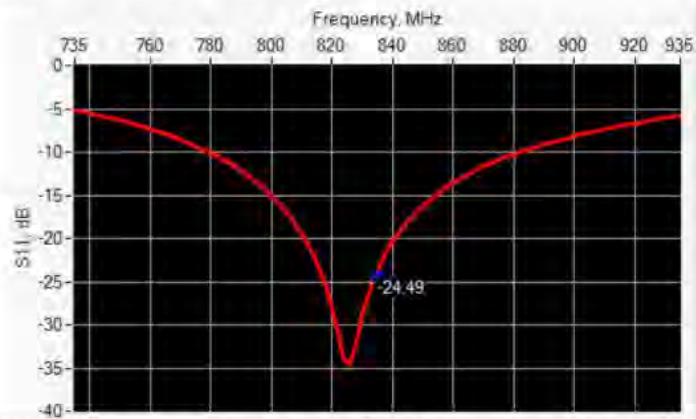

Frequency (MHz)	Return Loss (dB)	Requirement (dB)	Impedance
835	-24.49	-20	54.9 Ω + 2.8 jΩ

6.2 MECHANICAL DIMENSIONS

Frequency MHz	L mm		h mm		d mm	
	required	measured	required	measured	required	measured
300	420.0 ±1 %.		250.0 ±1 %.		6.35 ±1 %.	
450	290.0 ±1 %.		166.7 ±1 %.		6.35 ±1 %.	
750	176.0 ±1 %.		100.0 ±1 %.		6.35 ±1 %.	
835	161.0 ±1 %.	PASS	89.8 ±1 %.	PASS	3.6 ±1 %.	PASS
900	149.0 ±1 %.		83.3 ±1 %.		3.6 ±1 %.	
1450	89.1 ±1 %.		51.7 ±1 %.		3.6 ±1 %.	
1500	80.5 ±1 %.		50.0 ±1 %.		3.6 ±1 %.	
1640	79.0 ±1 %.		45.7 ±1 %.		3.6 ±1 %.	
1750	75.2 ±1 %.		42.9 ±1 %.		3.6 ±1 %.	
1800	72.0 ±1 %.		41.7 ±1 %.		3.6 ±1 %.	
1900	68.0 ±1 %.		39.5 ±1 %.		3.6 ±1 %.	
1950	66.3 ±1 %.		38.5 ±1 %.		3.6 ±1 %.	
2000	64.5 ±1 %.		37.5 ±1 %.		3.6 ±1 %.	
2100	61.0 ±1 %.		35.7 ±1 %.		3.6 ±1 %.	
2300	55.5 ±1 %.		32.6 ±1 %.		3.6 ±1 %.	
2450	51.5 ±1 %.		30.4 ±1 %.		3.6 ±1 %.	
2600	48.5 ±1 %.		28.8 ±1 %.		3.6 ±1 %.	
3000	41.5 ±1 %.		25.0 ±1 %.		3.6 ±1 %.	
3500	37.0 ±1 %.		26.4 ±1 %.		3.6 ±1 %.	
3700	34.7 ±1 %.		26.4 ±1 %.		3.6 ±1 %.	

Page: 6/11

This document shall not be reproduced, except in full or in part, without the written approval of SATIMO. The information contained herein is to be used only for the purpose for which it is submitted and is not to be released in whole or part without written approval of SATIMO.

股份
ig Lab

股份
ig Lab





股份
ig Lab

7 VALIDATION MEASUREMENT

The IEEE Std. 1528, OET 65 Bulletin C and CEI/IEC 62209 standards state that the system validation measurements must be performed using a reference dipole meeting the fore mentioned return loss and mechanical dimension requirements. The validation measurement must be performed against a liquid filled flat phantom, with the phantom constructed as outlined in the fore mentioned standards. Per the standards, the dipole shall be positioned below the bottom of the phantom, with the dipole length centered and parallel to the longest dimension of the flat phantom, with the top surface of the dipole at the described distance from the bottom surface of the phantom.

7.1 HEAD LIQUID MEASUREMENT

Frequency MHz	Relative permittivity (ϵ_r)		Conductivity (σ) S/m	
	required	measured	required	measured
300	45.3 ±5 %		0.87 ±5 %	
450	43.5 ±5 %		0.87 ±5 %	
750	41.9 ±5 %		0.89 ±5 %	
835	41.5 ±5 %	PASS	0.90 ±5 %	PASS
900	41.5 ±5 %		0.97 ±5 %	
1450	40.5 ±5 %		1.20 ±5 %	
1500	40.4 ±5 %		1.23 ±5 %	
1640	40.2 ±5 %		1.31 ±5 %	
1750	40.1 ±5 %		1.37 ±5 %	
1800	40.0 ±5 %		1.40 ±5 %	
1900	40.0 ±5 %		1.40 ±5 %	
1950	40.0 ±5 %		1.40 ±5 %	
2000	40.0 ±5 %		1.40 ±5 %	
2100	39.8 ±5 %		1.49 ±5 %	
2300	39.5 ±5 %		1.67 ±5 %	
2450	39.2 ±5 %		1.80 ±5 %	
2600	39.0 ±5 %		1.96 ±5 %	
3000	38.5 ±5 %		2.40 ±5 %	
3500	37.9 ±5 %		2.91 ±5 %	

股份
ig Lab

7.2 SAR MEASUREMENT RESULT WITH HEAD LIQUID

The IEEE Std. 1528 and CEI/IEC 62209 standards state that the system validation measurements should produce the SAR values shown below (for phantom thickness of 2 mm), within the uncertainty for the system validation. All SAR values are normalized to 1 W forward power. In bracket, the measured SAR is given with the used input power.

Software	OPENSAR V4
Phantom	SN 20/09 SAM71
Probe	SN 18/11 EPG122
Liquid	Head Liquid Values: ϵ_{ps}^1 : 42.3 sigma : 0.92
Distance between dipole center and liquid	15.0 mm
Area scan resolution	dx=8mm/dy=8mm

Page: 7/11

*This document shall not be reproduced, except in full or in part, without the written approval of SATIMO.
The information contained herein is to be used only for the purpose for which it is submitted and is not to be released in whole or part without written approval of SATIMO.*

股份
ig Lab





SAR REFERENCE DIPOLE CALIBRATION REPORT

Ref: ACR.287.4.14.SATIM.A

股份
ig Lab

Zoon Scan Resolution	dx=8mm/dy=8m/dz=5mm
Frequency	835 MHz
Input power	20 dBm
Liquid Temperature	21 °C
Lab Temperature	21 °C
Lab Humidity	45 %

Frequency MHz	1 g SAR (W/kg/W)		10 g SAR (W/kg/W)	
	required	measured	required	measured
300	2.85		1.94	
450	4.58		3.06	
750	8.49		5.55	
835	9.56	9.60 (0.96)	6.22	6.20 (0.62)
900	10.9		6.99	
1450	29		16	
1500	30.5		16.8	
1640	34.2		18.4	
1750	36.4		19.3	
1800	38.4		20.1	
1900	39.7		20.5	
1950	40.5		20.9	
2000	41.1		21.1	
2100	43.6		21.9	
2300	48.7		23.3	
2450	52.4		24	
2600	55.3		24.6	
3000	63.8		25.7	
3500	67.1		25	

股份
ig Lab

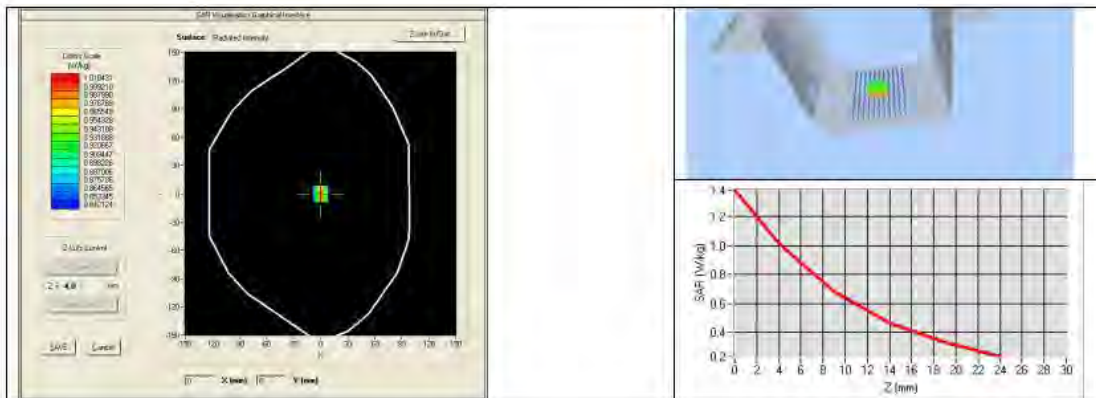

This document shall not be reproduced, except in full or in part, without the written approval of SATIMO. The information contained herein is to be used only for the purpose for which it is submitted and is not to be released in whole or part without written approval of SATIMO.

股份
ig Lab





SAR REFERENCE DIPOLE CALIBRATION REPORT

Ref: ACR.2874.14.SATIM.A

股份
ig Lab

7.3 BODY LIQUID MEASUREMENT

Frequency MHz	Relative permittivity (ϵ_r)		Conductivity (σ) S/m	
	required	measured	required	measured
150	61.9 ±5 %		0.80 ±5 %	
300	58.2 ±5 %		0.92 ±5 %	
450	56.7 ±5 %		0.94 ±5 %	
750	55.5 ±5 %		0.96 ±5 %	
835	55.2 ±5 %	PASS	0.97 ±5 %	PASS
900	55.0 ±5 %		1.05 ±5 %	
915	55.0 ±5 %		1.06 ±5 %	
1450	54.0 ±5 %		1.30 ±5 %	
1610	53.8 ±5 %		1.40 ±5 %	
1800	53.3 ±5 %		1.52 ±5 %	
1900	53.3 ±5 %		1.52 ±5 %	
2000	53.3 ±5 %		1.52 ±5 %	
2100	53.2 ±5 %		1.62 ±5 %	
2450	52.7 ±5 %		1.95 ±5 %	
2600	52.5 ±5 %		2.16 ±5 %	
3000	52.0 ±5 %		2.73 ±5 %	
3500	51.3 ±5 %		3.31 ±5 %	
5200	49.0 ±10 %		5.30 ±10 %	
5300	48.9 ±10 %		5.42 ±10 %	
5400	48.7 ±10 %		5.53 ±10 %	
5500	48.6 ±10 %		5.65 ±10 %	
5600	48.5 ±10 %		5.77 ±10 %	
5800	48.2 ±10 %		6.00 ±10 %	

股份
ig Lab

7.4 SAR MEASUREMENT RESULT WITH BODY LIQUID

Software	OPENSAR V4
Phantom	SN 20/09 SAM71
Probe	SN 18/11 EPG122
Liquid	Body Liquid Values: ϵ_r : 54.1 σ : 0.97
Distance between dipole center and liquid	15.0 mm
Area scan resolution	dx=8mm/dy=8mm
Zoon Scan Resolution	dx=8mm/dy=8mm/dz=5mm
Frequency	835 MHz
Input power	20 dBm
Liquid Temperature	21 °C
Lab Temperature	21 °C
Lab Humidity	45 %

*This document shall not be reproduced, except in full or in part, without the written approval of SATIMO.
The information contained herein is to be used only for the purpose for which it is submitted and is not to
be released in whole or part without written approval of SATIMO.*

股份
ig Lab



Frequency MHz	1 g SAR (W/kg/W)	10 g SAR (W/kg/W)
	measured	measured
835	9.90 (0.99)	6.39 (0.64)

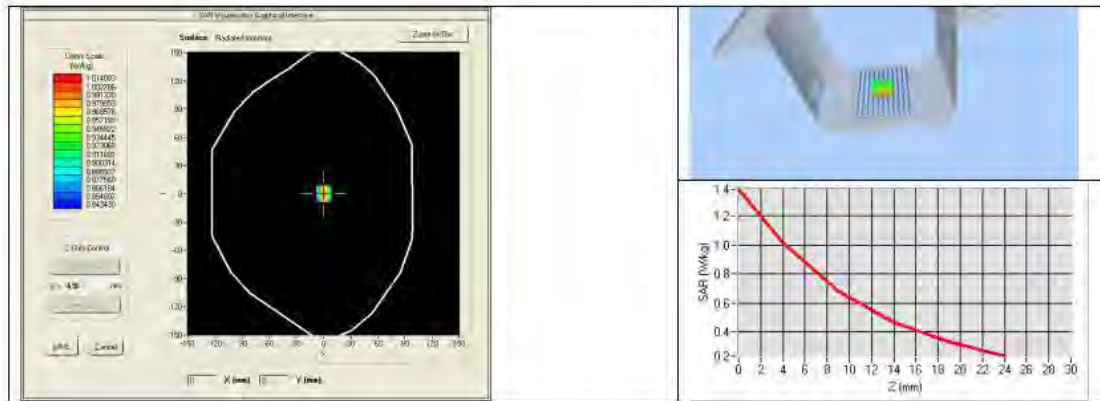



股份
ig Lab

8 LIST OF EQUIPMENT

Equipment Summary Sheet				
Equipment Description	Manufacturer / Model	Identification No.	Current Calibration Date	Next Calibration Date
SAM Phantom	Satimo	SN-20/09-SAM71	Validated. No cal required.	Validated. No cal required.
COMOSAR Test Bench	Version 3	NA	Validated. No cal required.	Validated. No cal required.
Network Analyzer	Rhode & Schwarz ZVA	SN100132	02/2021	02/2024
Calipers	Carrera	CALIPER-01	12/2018	12/2021
Reference Probe	Satimo	EPG122 SN 18/11	10/2021	10/2022
Multimeter	Keithley 2000	1188656	12/2018	12/2021
Signal Generator	Agilent E4438C	MY49070581	12/2018	12/2021
Amplifier	Aethercomm	SN 046	Characterized prior to test. No cal required.	Characterized prior to test. No cal required.
Power Meter	HP E4418A	US38261498	12/2018	12/2021
Power Sensor	HP ECP-E26A	US37181460	12/2018	12/2021
Directional Coupler	Narda 4216-20	01386	Characterized prior to test. No cal required.	Characterized prior to test. No cal required.
Temperature and Humidity Sensor	Control Company	11-661-9	8/2021	8/2024

股份
ig Lab

This document shall not be reproduced, except in full or in part, without the written approval of SATIMO. The information contained herein is to be used only for the purpose for which it is submitted and is not to be released in whole or part without written approval of SATIMO.

股份
ig Lab





5.3 SID1800 Dipole Calibration Certificate



SAR Reference Dipole Calibration Report

Ref : ACR.287.6.14.SATU.A

SHENZHEN LCS COMPLIANCE TESTING LABORATORY LTD.
1F., XINGYUAN INDUSTRIAL PARK, TONGDA ROAD, BAO'AN BLVD
BAO'AN DISTRICT, SHENZHEN, GUANGDONG, CHINA
SATIMO COMOSAR REFERENCE DIPOLE
FREQUENCY: 1800 MHZ
SERIAL NO.: SN 07/14 DIP 1G800-301

Calibrated at SATIMO US
2105 Barrett Park Dr. - Kennesaw, GA 30144



09/29/2021

Summary:

This document presents the method and results from an accredited SAR reference dipole calibration performed in SATIMO USA using the COMOSAR test bench. All calibration results are traceable to national metrology institutions.



股份
ing Lab

股份
ing Lab

股份
ing Lab



SAR REFERENCE DIPOLE CALIBRATION REPORT

REF ACR 287.6.14.SATU.A

份
Lab

	<i>Name</i>	<i>Function</i>	<i>Date</i>	<i>Signature</i>
<i>Prepared by :</i>	Jérôme LUC	Product Manager	10/12/2021	<i>[Signature]</i>
<i>Checked by :</i>	Jérôme LUC	Product Manager	10/12/2021	<i>[Signature]</i>
<i>Approved by :</i>	Kim RUTKOWSKI	Quality Manager	10/12/2021	<i>[Signature]</i>

	<i>Customer Name</i>
<i>Distribution :</i>	Shenzhen LCS Compliance Testing Laboratory Ltd.

<i>Issue</i>	<i>Date</i>	<i>Modifications</i>
A	10/12/2021	Initial release

*This document shall not be reproduced, except in full or in part, without the written approval of SATIMO.
The information contained herein is to be used only for the purpose for which it is submitted and is not to
be released in whole or part without written approval of SATIMO.*



份
Lab



TABLE OF CONTENTS

1 Introduction.....4

2 Device Under Test4

3 Product Description4

 3.1 General Information4

4 Measurement Method5

 4.1 Return Loss Requirements5

 4.2 Mechanical Requirements5

5 Measurement Uncertainty.....5

 5.1 Return Loss5

 5.2 Dimension Measurement5

 5.3 Validation Measurement5

6 Calibration Measurement Results6

 6.1 Return Loss and Impedance6

 6.2 Mechanical Dimensions6

7 Validation measurement7

 7.1 Head Liquid Measurement7

 7.2 SAR Measurement Result With Head Liquid7

 7.3 Body Liquid Measurement9

 7.4 SAR Measurement Result With Body Liquid9

8 List of Equipment11

*This document shall not be reproduced, except in full or in part, without the written approval of SATIMO.
The information contained herein is to be used only for the purpose for which it is submitted and is not to be released in whole or part without written approval of SATIMO.*





份
Lab

1 INTRODUCTION

This document contains a summary of the requirements set forth by the IEEE 1528, OET 65 Bulletin C and CEI/IEC 62209 standards for reference dipoles used for SAR measurement system validations and the measurements that were performed to verify that the product complies with the fore mentioned standards.

2 DEVICE UNDER TEST

Device Under Test	
Device Type	COMOSAR 1800 MHz REFERENCE DIPOLE
Manufacturer	Satimo
Model	SID1800
Serial Number	SN 07/14 DIP 1G800-301
Product Condition (new / used)	New

A yearly calibration interval is recommended.

3 PRODUCT DESCRIPTION

3.1 GENERAL INFORMATION

Satimo's COMOSAR Validation Dipoles are built in accordance to the IEEE 1528, OET 65 Bulletin C and CEI/IEC 62209 standards. The product is designed for use with the COMOSAR test bench only.



Figure 1 – Satimo COMOSAR Validation Dipole

Page: 4/11

This document shall not be reproduced, except in full or in part, without the written approval of SATIMO. The information contained herein is to be used only for the purpose for which it is submitted and is not to be released in whole or part without written approval of SATIMO.

份
Lab

份
Lab





份
Lab

4 MEASUREMENT METHOD

The IEEE 1528, OET 65 Bulletin C and CEI/IEC 62209 standards provide requirements for reference dipoles used for system validation measurements. The following measurements were performed to verify that the product complies with the fore mentioned standards.

4.1 RETURN LOSS REQUIREMENTS

The dipole used for SAR system validation measurements and checks must have a return loss of -20 dB or better. The return loss measurement shall be performed against a liquid filled flat phantom, with the phantom constructed as outlined in the fore mentioned standards.

4.2 MECHANICAL REQUIREMENTS

The IEEE Std. 1528 and CEI/IEC 62209 standards specify the mechanical components and dimensions of the validation dipoles, with the dimensions frequency and phantom shell thickness dependent. The COMOSAR test bench employs a 2 mm phantom shell thickness therefore the dipoles sold for use with the COMOSAR test bench comply with the requirements set forth for a 2 mm phantom shell thickness.

5 MEASUREMENT UNCERTAINTY

All uncertainties listed below represent an expanded uncertainty expressed at approximately the 95% confidence level using a coverage factor of k=2, traceable to the Internationally Accepted Guides to Measurement Uncertainty.

5.1 RETURN LOSS

The following uncertainties apply to the return loss measurement:

Frequency band	Expanded Uncertainty on Return Loss
400-6000MHz	0.1 dB

5.2 DIMENSION MEASUREMENT

The following uncertainties apply to the dimension measurements:

Length (mm)	Expanded Uncertainty on Length
3 - 300	0.05 mm

5.3 VALIDATION MEASUREMENT

The guidelines outlined in the IEEE 1528, OET 65 Bulletin C, CENELEC EN50361 and CEI/IEC 62209 standards were followed to generate the measurement uncertainty for validation measurements.

Scan Volume	Expanded Uncertainty
1 g	20.3 %
10 g	20.1 %

Page: 5/11

This document shall not be reproduced, except in full or in part, without the written approval of SATIMO. The information contained herein is to be used only for the purpose for which it is submitted and is not to be released in whole or part without written approval of SATIMO.

份
Lab

份
Lab





6 CALIBRATION MEASUREMENT RESULTS

6.1 RETURN LOSS AND IMPEDANCE

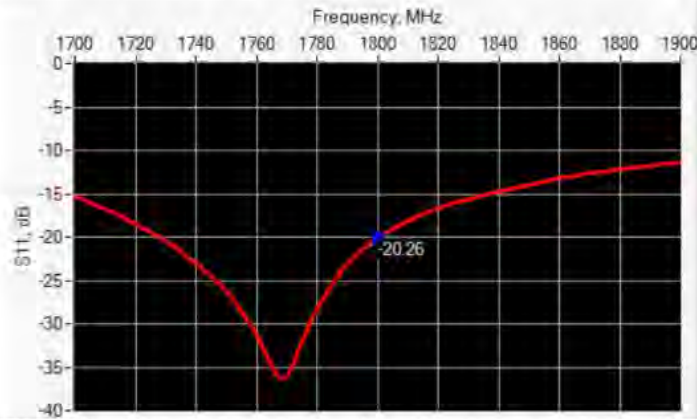

Frequency (MHz)	Return Loss (dB)	Requirement (dB)	Impedance
1800	-20.26	-20	43.1 Ω + 6.9 jΩ

6.2 MECHANICAL DIMENSIONS

Frequency MHz	L mm		h mm		d mm	
	required	measured	required	measured	required	measured
300	420.0 ±1 %		250.0 ±1 %		6.35 ±1 %	
450	290.0 ±1 %		166.7 ±1 %		6.35 ±1 %	
750	176.0 ±1 %		100.0 ±1 %		6.35 ±1 %	
835	161.0 ±1 %		89.8 ±1 %		3.6 ±1 %	
900	149.0 ±1 %		83.3 ±1 %		3.6 ±1 %	
1450	89.1 ±1 %		51.7 ±1 %		3.6 ±1 %	
1500	80.5 ±1 %		50.0 ±1 %		3.6 ±1 %	
1640	79.0 ±1 %		45.7 ±1 %		3.6 ±1 %	
1750	75.2 ±1 %		42.9 ±1 %		3.6 ±1 %	
1800	72.0 ±1 %	PASS	41.7 ±1 %	PASS	3.6 ±1 %	PASS
1900	68.0 ±1 %		39.5 ±1 %		3.6 ±1 %	
1950	66.3 ±1 %		38.5 ±1 %		3.6 ±1 %	
2000	64.5 ±1 %		37.5 ±1 %		3.6 ±1 %	
2100	61.0 ±1 %		35.7 ±1 %		3.6 ±1 %	
2300	55.5 ±1 %		32.6 ±1 %		3.6 ±1 %	
2450	51.5 ±1 %		30.4 ±1 %		3.6 ±1 %	
2600	48.5 ±1 %		28.8 ±1 %		3.6 ±1 %	
3000	41.5 ±1 %		25.0 ±1 %		3.6 ±1 %	
3500	37.0 ±1 %		26.4 ±1 %		3.6 ±1 %	
3700	34.7 ±1 %		26.4 ±1 %		3.6 ±1 %	

Page: 6/11

This document shall not be reproduced, except in full or in part, without the written approval of SATIMO. The information contained herein is to be used only for the purpose for which it is submitted and is not to be released in whole or part without written approval of SATIMO.





7 VALIDATION MEASUREMENT

The IEEE Std. 1528, OET 65 Bulletin C and CEI/IEC 62209 standards state that the system validation measurements must be performed using a reference dipole meeting the fore mentioned return loss and mechanical dimension requirements. The validation measurement must be performed against a liquid filled flat phantom, with the phantom constructed as outlined in the fore mentioned standards. Per the standards, the dipole shall be positioned below the bottom of the phantom, with the dipole length centered and parallel to the longest dimension of the flat phantom, with the top surface of the dipole at the described distance from the bottom surface of the phantom.

7.1 HEAD LIQUID MEASUREMENT

Frequency MHz	Relative permittivity (ϵ_r)		Conductivity (σ) S/m	
	required	measured	required	measured
300	45.3 ±5 %		0.87 ±5 %	
450	43.5 ±5 %		0.87 ±5 %	
750	41.9 ±5 %		0.89 ±5 %	
835	41.5 ±5 %		0.90 ±5 %	
900	41.5 ±5 %		0.97 ±5 %	
1450	40.5 ±5 %		1.20 ±5 %	
1500	40.4 ±5 %		1.23 ±5 %	
1640	40.2 ±5 %		1.31 ±5 %	
1750	40.1 ±5 %		1.37 ±5 %	
1800	40.0 ±5 %	PASS	1.40 ±5 %	PASS
1900	40.0 ±5 %		1.40 ±5 %	
1950	40.0 ±5 %		1.40 ±5 %	
2000	40.0 ±5 %		1.40 ±5 %	
2100	39.8 ±5 %		1.49 ±5 %	
2300	39.5 ±5 %		1.67 ±5 %	
2450	39.2 ±5 %		1.80 ±5 %	
2600	39.0 ±5 %		1.96 ±5 %	
3000	38.5 ±5 %		2.40 ±5 %	
3500	37.9 ±5 %		2.91 ±5 %	

7.2 SAR MEASUREMENT RESULT WITH HEAD LIQUID

The IEEE Std. 1528 and CEI/IEC 62209 standards state that the system validation measurements should produce the SAR values shown below (for phantom thickness of 2 mm), within the uncertainty for the system validation. All SAR values are normalized to 1 W forward power. In bracket, the measured SAR is given with the used input power.

Software	OPENSAR V4
Phantom	SN 20/09 SAM71
Probe	SN 18/11 EPG122
Liquid	Head Liquid Values: ϵ_r : 41.3 σ : 1.38
Distance between dipole center and liquid	10.0 mm
Area scan resolution	$dx=8mm/dy=8mm$

*This document shall not be reproduced, except in full or in part, without the written approval of SATIMO.
The information contained herein is to be used only for the purpose for which it is submitted and is not to be released in whole or part without written approval of SATIMO.*





SAR REFERENCE DIPOLE CALIBRATION REPORT

Ref: ACR.287.6.14.SATIM.A

Zoon Scan Resolution	dx=8mm/dy=8m/dz=5mm
Frequency	1800 MHz
Input power	20 dBm
Liquid Temperature	21 °C
Lab Temperature	21 °C
Lab Humidity	45 %

Frequency MHz	1 g SAR (W/kg/W)		10 g SAR (W/kg/W)	
	required	measured	required	measured
300	2.85		1.94	
450	4.58		3.06	
750	8.49		5.55	
835	9.56		6.22	
900	10.9		6.99	
1450	29		16	
1500	30.5		16.8	
1640	34.2		18.4	
1750	36.4		19.3	
1800	38.4	38.13 (3.81)	20.1	20.20 (2.02)
1900	39.7		20.5	
1950	40.5		20.9	
2000	41.1		21.1	
2100	43.6		21.9	
2300	48.7		23.3	
2450	52.4		24	
2600	55.3		24.6	
3000	63.8		25.7	
3500	67.1		25	

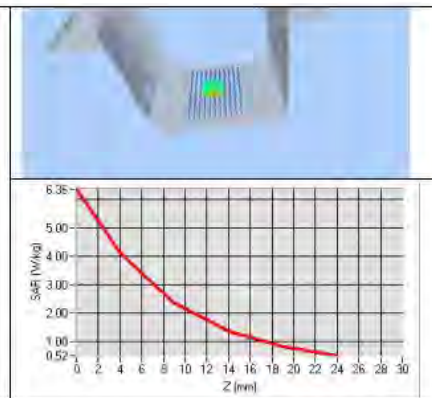
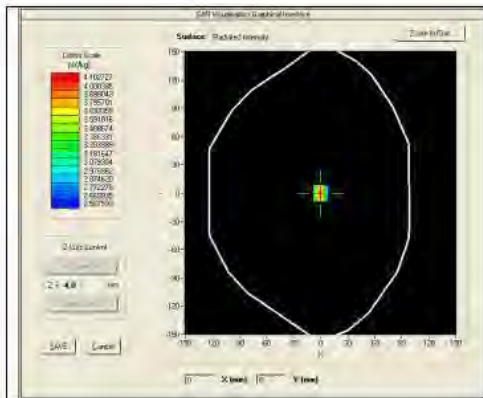

*This document shall not be reproduced, except in full or in part, without the written approval of SATIMO.
The information contained herein is to be used only for the purpose for which it is submitted and is not to be released in whole or part without written approval of SATIMO.*





SAR REFERENCE DIPOLE CALIBRATION REPORT

REF ACR 287.6.14.SATIM.A

份
Lab

7.3 BODY LIQUID MEASUREMENT

Frequency MHz	Relative permittivity (ϵ_r)		Conductivity (σ) S/m	
	required	measured	required	measured
150	61.9 ±5 %		0.80 ±5 %	
300	58.2 ±5 %		0.92 ±5 %	
450	56.7 ±5 %		0.94 ±5 %	
750	55.5 ±5 %		0.96 ±5 %	
835	55.2 ±5 %		0.97 ±5 %	
900	55.0 ±5 %		1.05 ±5 %	
915	55.0 ±5 %		1.06 ±5 %	
1450	54.0 ±5 %		1.30 ±5 %	
1610	53.8 ±5 %		1.40 ±5 %	
1800	53.3 ±5 %	PASS	1.52 ±5 %	PASS
1900	53.3 ±5 %		1.52 ±5 %	
2000	53.3 ±5 %		1.52 ±5 %	
2100	53.2 ±5 %		1.62 ±5 %	
2450	52.7 ±5 %		1.95 ±5 %	
2600	52.5 ±5 %		2.16 ±5 %	
3000	52.0 ±5 %		2.73 ±5 %	
3500	51.3 ±5 %		3.31 ±5 %	
5200	49.0 ±10 %		5.30 ±10 %	
5300	48.9 ±10 %		5.42 ±10 %	
5400	48.7 ±10 %		5.53 ±10 %	
5500	48.6 ±10 %		5.65 ±10 %	
5600	48.5 ±10 %		5.77 ±10 %	
5800	48.2 ±10 %		6.00 ±10 %	

份
Lab

7.4 SAR MEASUREMENT RESULT WITH BODY LIQUID

Software	OPENSAR V4
Phantom	SN 20/09 SAM71
Probe	SN 18/11 EPG122
Liquid	Body Liquid Values: ϵ_{ps} : 53.3 σ : 1.51
Distance between dipole center and liquid	10.0 mm
Area scan resolution	$dx=8mm/dy=8mm$
Zoon Scan Resolution	$dx=8mm/dy=8m/dz=5mm$
Frequency	1800 MHz
Input power	20 dBm
Liquid Temperature	21 °C
Lab Temperature	21 °C
Lab Humidity	45 %

This document shall not be reproduced, except in full or in part, without the written approval of SATIMO. The information contained herein is to be used only for the purpose for which it is submitted and is not to be released in whole or part without written approval of SATIMO.

份
Lab





SAR REFERENCE DIPOLE CALIBRATION REPORT

Ref: ACR.287.6.14.SATU.A

Frequency MHz	1 g SAR (W/kg/W)	10 g SAR (W/kg/W)
	measured	measured
1800	39.03 (3.90)	20.65 (2.07)

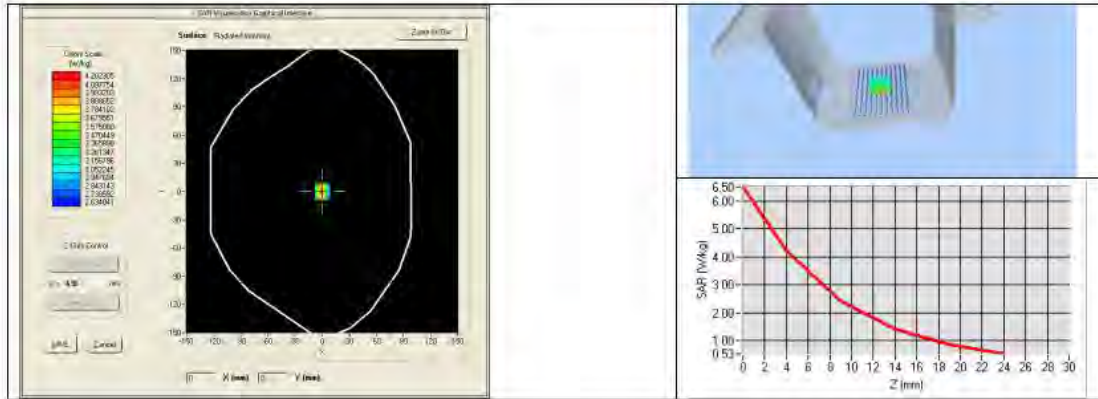

This document shall not be reproduced, except in full or in part, without the written approval of SATIMO. The information contained herein is to be used only for the purpose for which it is submitted and is not to be released in whole or part without written approval of SATIMO.





8 LIST OF EQUIPMENT

Equipment Summary Sheet				
Equipment Description	Manufacturer / Model	Identification No.	Current Calibration Date	Next Calibration Date
SAM Phantom	Satimo	SN-20/09-SAM71	Validated. No cal required.	Validated. No cal required.
COMOSAR Test Bench	Version 3	NA	Validated. No cal required.	Validated. No cal required.
Network Analyzer	Rhode & Schwarz ZVA	SN100132	02/2021	02/2024
Calipers	Carrera	CALIPER-01	12/2018	12/2021
Reference Probe	Satimo	EPG122 SN 18/11	10/2021	10/2022
Multimeter	Keithley 2000	1188656	12/2018	12/2021
Signal Generator	Agilent E4438C	MY49070581	12/2018	12/2021
Amplifier	Aethercomm	SN 048	Characterized prior to test. No cal required.	Characterized prior to test. No cal required.
Power Meter	HP E4418A	US38261498	12/2018	12/2021
Power Sensor	HP ECP-E26A	US37181460	12/2018	12/2021
Directional Coupler	Narda 4216-20	01386	Characterized prior to test. No cal required.	Characterized prior to test. No cal required.
Temperature and Humidity Sensor	Control Company	11-661-9	8/2021	8/2024

*This document shall not be reproduced, except in full or in part, without the written approval of SATIMO.
The information contained herein is to be used only for the purpose for which it is submitted and is not to be released in whole or part without written approval of SATIMO.*





5.4 SID1900 Dipole Calibration Certificate



SAR Reference Dipole Calibration Report

Ref: ACR.273.2.18.SATU.A

**SHENZHEN LCS COMPLIANCE TESTING
LABORATORY LTD.**
**1F., XINGYUAN INDUSTRIAL PARK, TONGDA ROAD,
BAO'AN BLVD**
BAO'AN DISTRICT, SHENZHEN, GUANGDONG, CHINA
MVG COMOSAR REFERENCE DIPOLE
FREQUENCY: 1900 MHZ
SERIAL NO.: SN 38/18 DIP 1G900-466

Calibrated at MVG US
2105 Barrett Park Dr. - Kennesaw, GA 30144



Calibration Date: 09/22/2021

Summary:

This document presents the method and results from an accredited SAR reference dipole calibration performed in MVG USA using the COMOSAR test bench. All calibration results are traceable to national metrology institutions.



股份
ing Lab

股份
ing Lab

股份
ing Lab



SAR REFERENCE DIPOLE CALIBRATION REPORT

REF ACR 273.2.18.SATU.A

股份
ig Lab

	<i>Name</i>	<i>Function</i>	<i>Date</i>	<i>Signature</i>
<i>Prepared by :</i>	Jérôme LUC	Product Manager	09/28/2021	<i>[Signature]</i>
<i>Checked by :</i>	Jérôme LUC	Product Manager	09/28/2021	<i>[Signature]</i>
<i>Approved by :</i>	Kim RUTKÓWSKI	Quality Manager	09/28/2021	<i>[Signature]</i>

	<i>Customer Name</i>
<i>Distribution :</i>	Shenzhen LCS Compliance Testing Laboratory Ltd.

股份
ig Lab

<i>Issue</i>	<i>Date</i>	<i>Mod.ifications</i>
A	09/28/2021	Initial release

*This document shall not be reproduced, except in full or in part, without the written approval of MVG.
The information contained herein is to be used only for the purpose for which it is submitted and is not to
be released in whole or part without written approval of MVG.*

股份
ig Lab





SAR REFERENCE DIPOLE CALIBRATION REPORT

Ref: ACR.273.2.18.SATL.A

股份
ig Lab

TABLE OF CONTENTS

1 Introduction..... 4

2 Device Under Test..... 4

3 Product Description..... 4

 3.1 General Information..... 4

4 Measurement Method..... 5

 4.1 Return Loss Requirements..... 5

 4.2 Mechanical Requirements..... 5

5 Measurement Uncertainty..... 5

 5.1 Return Loss..... 5

 5.2 Dimension Measurement..... 5

 5.3 Validation Measurement..... 5

6 Calibration Measurement Results..... 6

 6.1 Return Loss and Impedance In Head Liquid..... 6

 6.2 Return Loss and Impedance In Body Liquid..... 6

 6.3 Mechanical Dimensions..... 6

7 Validation measurement..... 7

 7.1 Head Liquid Measurement..... 7

 7.2 SAR Measurement Result With Head Liquid..... 8

 7.3 Body Liquid Measurement..... 9

 7.4 SAR Measurement Result With Body Liquid..... 10

8 List of Equipment..... 11

股份
ig Lab

*This document shall not be reproduced, except in full or in part, without the written approval of MVG.
The information contained herein is to be used only for the purpose for which it is submitted and is not to be released in whole or part without written approval of MVG.*

股份
ig Lab





1 INTRODUCTION

This document contains a summary of the requirements set forth by the IEEE 1528, FCC KDBs and CE/IEC 62209 standards for reference dipoles used for SAR measurement system validations and the measurements that were performed to verify that the product complies with the fore mentioned standards.

2 DEVICE UNDER TEST

Device Under Test	
Device Type	COMOSAR 1900 MHz REFERENCE DIPOLE
Manufacturer	MVG
Model	SID1900
Serial Number	SN 38/18 DIP 1G900-466
Product Condition (new / used)	Used

A yearly calibration interval is recommended.

3 PRODUCT DESCRIPTION

3.1 GENERAL INFORMATION

MVG's COMOSAR Validation Dipoles are built in accordance to the IEEE 1528, FCC KDBs and CE/IEC 62209 standards. The product is designed for use with the COMOSAR test bench only.



Figure 1 – MVG COMOSAR Validation Dipole





股份
ig Lab

4 MEASUREMENT METHOD

The IEEE 1528, FCC KDBs and CEI/IEC 62209 standards provide requirements for reference dipoles used for system validation measurements. The following measurements were performed to verify that the product complies with the fore mentioned standards.

4.1 RETURN LOSS REQUIREMENTS

The dipole used for SAR system validation measurements and checks must have a return loss of -20 dB or better. The return loss measurement shall be performed against a liquid filled flat phantom, with the phantom constructed as outlined in the fore mentioned standards.

4.2 MECHANICAL REQUIREMENTS

The IEEE Std. 1528 and CEI/IEC 62209 standards specify the mechanical components and dimensions of the validation dipoles, with the dimensions frequency and phantom shell thickness dependent. The COMOSAR test bench employs a 2 mm phantom shell thickness therefore the dipoles sold for use with the COMOSAR test bench comply with the requirements set forth for a 2 mm phantom shell thickness.

5 MEASUREMENT UNCERTAINTY

All uncertainties listed below represent an expanded uncertainty expressed at approximately the 95% confidence level using a coverage factor of k=2, traceable to the Internationally Accepted Guides to Measurement Uncertainty.

5.1 RETURN LOSS

The following uncertainties apply to the return loss measurement:

Frequency band	Expanded Uncertainty on Return Loss
400-6000MHz	0.1 dB

5.2 DIMENSION MEASUREMENT

The following uncertainties apply to the dimension measurements:

Length (mm)	Expanded Uncertainty on Length
3 - 300	0.05 mm

5.3 VALIDATION MEASUREMENT

The guidelines outlined in the IEEE 1528, FCC KDBs, CENELEC EN50361 and CEI/IEC 62209 standards were followed to generate the measurement uncertainty for validation measurements.

Scan Volume	Expanded Uncertainty
1 g	20.3 %

This document shall not be reproduced, except in full or in part, without the written approval of MVG. The information contained herein is to be used only for the purpose for which it is submitted and is not to be released in whole or part without written approval of MVG.

股份
ig Lab



股份
ig Lab



SAR REFERENCE DIPOLE CALIBRATION REPORT

Rev. ACR. 273.2.18.SATL.A

股份
ig Lab

10 g	20.1 %
------	--------

6 CALIBRATION MEASUREMENT RESULTS

6.1 RETURN LOSS AND IMPEDANCE IN HEAD LIQUID

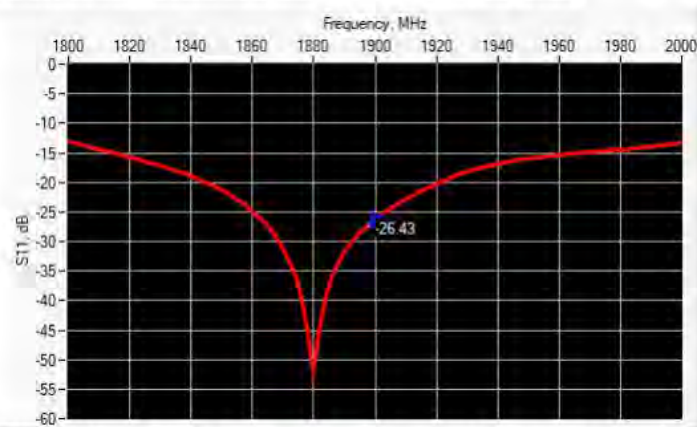

Frequency (MHz)	Return Loss (dB)	Requirement (dB)	Impedance
1900	-26.43	-20	50.5 Ω + 4.7 jΩ

6.2 RETURN LOSS AND IMPEDANCE IN BODY LIQUID

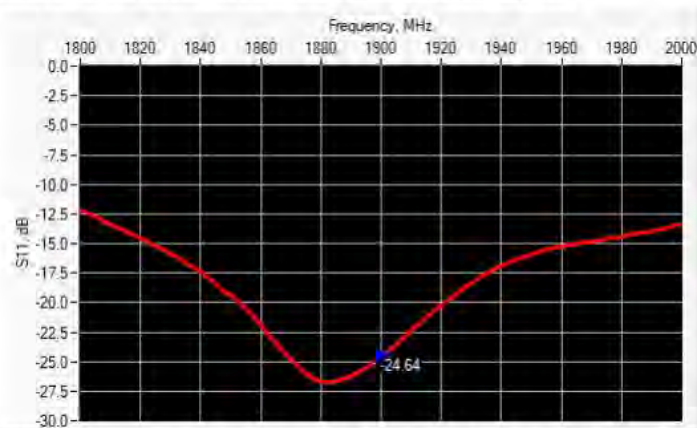

Frequency (MHz)	Return Loss (dB)	Requirement (dB)	Impedance
1900	-24.64	-20	46.2 Ω + 4.4 jΩ

6.3 MECHANICAL DIMENSIONS

Frequency MHz	L mm		h mm		d mm	
	required	measured	required	measured	required	measured
300	420.0 ±1 %		250.0 ±1 %		6.35 ±1 %	

Page: 6/11

*This document shall not be reproduced, except in full or in part, without the written approval of MVG.
The information contained herein is to be used only for the purpose for which it is submitted and is not to be released in whole or part without written approval of MVG.*

股份
ig Lab





SAR REFERENCE DIPOLE CALIBRATION REPORT

Ref: ACR-273.2.18.SATU.A

股份
ig Lab

450	290.0 ±1 %.		166.7 ±1 %.		6.35 ±1 %.	
750	176.0 ±1 %.		100.0 ±1 %.		6.35 ±1 %.	
835	161.0 ±1 %.		89.8 ±1 %.		3.6 ±1 %.	
900	149.0 ±1 %.		83.3 ±1 %.		3.6 ±1 %.	
1450	89.1 ±1 %.		51.7 ±1 %.		3.6 ±1 %.	
1500	80.5 ±1 %.		50.0 ±1 %.		3.6 ±1 %.	
1640	79.0 ±1 %.		45.7 ±1 %.		3.6 ±1 %.	
1750	75.2 ±1 %.		42.9 ±1 %.		3.6 ±1 %.	
1800	72.0 ±1 %.		41.7 ±1 %.		3.6 ±1 %.	
1900	68.0 ±1 %.	PASS	39.5 ±1 %.	PASS	3.6 ±1 %.	PASS
1950	66.3 ±1 %.		38.5 ±1 %.		3.6 ±1 %.	
2000	64.5 ±1 %.		37.5 ±1 %.		3.6 ±1 %.	
2100	61.0 ±1 %.		35.7 ±1 %.		3.6 ±1 %.	
2300	55.5 ±1 %.		32.6 ±1 %.		3.6 ±1 %.	
2450	51.5 ±1 %.		30.4 ±1 %.		3.6 ±1 %.	
2600	48.5 ±1 %.		28.8 ±1 %.		3.6 ±1 %.	
3000	41.5 ±1 %.		25.0 ±1 %.		3.6 ±1 %.	
3500	37.0 ±1 %.		26.4 ±1 %.		3.6 ±1 %.	
3700	34.7 ±1 %.		26.4 ±1 %.		3.6 ±1 %.	

7 VALIDATION MEASUREMENT

The IEEE Std. 1528, FCC KDBs and CEM/IEC 62209 standards state that the system validation measurements must be performed using a reference dipole meeting the fore mentioned return loss and mechanical dimension requirements. The validation measurement must be performed against a liquid filled flat phantom, with the phantom constructed as outlined in the fore mentioned standards. Per the standards, the dipole shall be positioned below the bottom of the phantom, with the dipole length centered and parallel to the longest dimension of the flat phantom, with the top surface of the dipole at the described distance from the bottom surface of the phantom.

7.1 HEAD LIQUID MEASUREMENT

Frequency MHz	Relative permittivity (ϵ_r)		Conductivity (σ) S/m	
	required	measured	required	measured
300	45.3 ±5 %		0.87 ±5 %	
450	43.5 ±5 %		0.87 ±5 %	
750	41.9 ±5 %		0.89 ±5 %	
835	41.5 ±5 %		0.90 ±5 %	
900	41.5 ±5 %		0.97 ±5 %	
1450	40.5 ±5 %		1.20 ±5 %	
1500	40.4 ±5 %		1.23 ±5 %	
1640	40.2 ±5 %		1.31 ±5 %	
1750	40.1 ±5 %		1.37 ±5 %	

Page: 7/11

*This document shall not be reproduced, except in full or in part, without the written approval of MVG.
The information contained herein is to be used only for the purpose for which it is submitted and is not to be released in whole or part without written approval of MVG.*

股份
ig Lab





SAR REFERENCE DIPOLE CALIBRATION REPORT

Ref: ACR 273.2.18.SATU.A

股份
ig Lab

1800	40.0 ±5 %		1.40 ±5 %	
1900	40.0 ±5 %	PASS	1.40 ±5 %	PASS
1950	40.0 ±5 %		1.40 ±5 %	
2000	40.0 ±5 %		1.40 ±5 %	
2100	39.8 ±5 %		1.49 ±5 %	
2300	39.5 ±5 %		1.67 ±5 %	
2450	39.2 ±5 %		1.80 ±5 %	
2600	39.0 ±5 %		1.96 ±5 %	
3000	38.5 ±5 %		2.40 ±5 %	
3500	37.9 ±5 %		2.91 ±5 %	

7.2 SAR MEASUREMENT RESULT WITH HEAD LIQUID

The IEEE Std. 1528 and CEI/IEC 62209 standards state that the system validation measurements should produce the SAR values shown below (for phantom thickness of 2 mm), within the uncertainty for the system validation. All SAR values are normalized to 1 W forward power. In bracket, the measured SAR is given with the used input power.

Software	OPENSAR V4
Phantom	SN 20/09 SAM71
Probe	SN 18/11 EPG122
Liquid	Head Liquid Values: $\epsilon_{ps} = 38.5$ $\sigma_{ps} = 1.45$
Distance between dipole center and liquid	10.0 mm
Area scan resolution	$dx=8mm/dy=8mm$
Zoon Scan Resolution	$dx=8mm/dy=8mm/dz=5mm$
Frequency	1900 MHz
Input power	20 dBm
Liquid Temperature	21 °C
Lab Temperature	21 °C
Lab Humidity	45 %

股份
ig Lab

Frequency MHz	1 g SAR (W/kg/W)		10 g SAR (W/kg/W)	
	required	measured	required	measured
300	2.85		1.94	
450	4.58		3.06	
750	8.49		5.55	
835	9.56		6.22	
900	10.9		6.99	
1450	29		16	
1500	30.5		16.8	
1640	34.2		18.4	
1750	36.4		19.3	
1800	38.4		20.1	

Page: 8/11

This document shall not be reproduced, except in full or in part, without the written approval of MVG. The information contained herein is to be used only for the purpose for which it is submitted and is not to be released in whole or part without written approval of MVG.

股份
ig Lab





SAR REFERENCE DIPOLE CALIBRATION REPORT

Rev. ACR.273.2.18.SATL.A

股份
ig Lab

1900	39.7	40.03 (4.00)	20.5	20.55 (2.06)
1950	40.5		20.9	
2000	41.1		21.1	
2100	43.6		21.9	
2300	48.7		23.3	
2450	52.4		24	
2600	55.3		24.6	
3000	63.8		25.7	
3500	67.1		25	
3700	67.4		24.2	

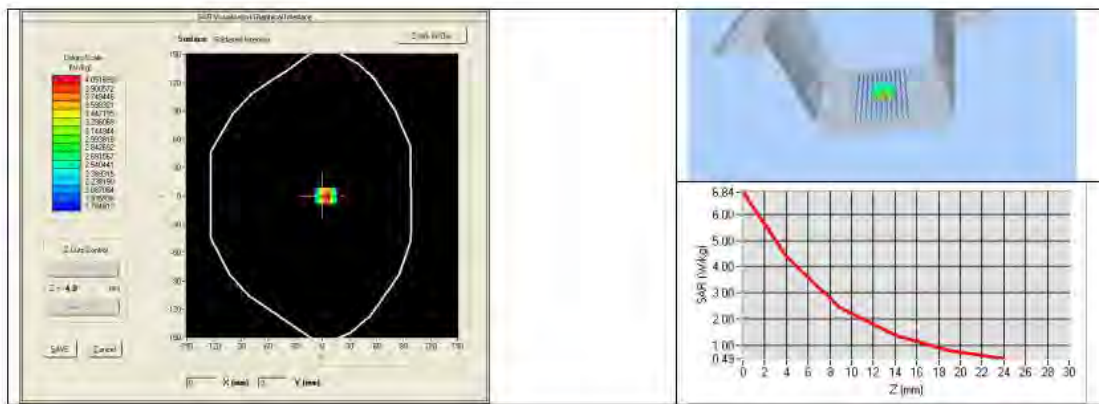

股份
ig Lab

7.3 BODY LIQUID MEASUREMENT

Frequency MHz	Relative permittivity (ϵ_r')		Conductivity (σ) S/m	
	required	measured	required	measured
150	61.9 ±5 %		0.80 ±5 %	
300	58.2 ±5 %		0.92 ±5 %	
450	56.7 ±5 %		0.94 ±5 %	
750	55.5 ±5 %		0.96 ±5 %	
835	55.2 ±5 %		0.97 ±5 %	
900	55.0 ±5 %		1.05 ±5 %	
915	55.0 ±5 %		1.06 ±5 %	
1450	54.0 ±5 %		1.30 ±5 %	
1610	53.8 ±5 %		1.40 ±5 %	
1800	53.3 ±5 %		1.52 ±5 %	
1900	53.3 ±5 %	PASS	1.52 ±5 %	PASS
2000	53.3 ±5 %		1.52 ±5 %	
2100	53.2 ±5 %		1.62 ±5 %	

Page: 9/11

*This document shall not be reproduced, except in full or in part, without the written approval of MVG.
The information contained herein is to be used only for the purpose for which it is submitted and is not to be released in whole or part without written approval of MVG.*

股份
ig Lab





SAR REFERENCE DIPOLE CALIBRATION REPORT

Ref: ACR.273.2.18.SATL.A

股份
ig Lab

2300	52.9 ±5 %		1.81 ±5 %
2450	52.7 ±5 %		1.95 ±5 %
2600	52.5 ±5 %		2.16 ±5 %
3000	52.0 ±5 %		2.73 ±5 %
3500	51.3 ±5 %		3.31 ±5 %
3700	51.0 ±5 %		3.55 ±5 %
5200	49.0 ±10 %		5.30 ±10 %
5300	48.9 ±10 %		5.42 ±10 %
5400	48.7 ±10 %		5.53 ±10 %
5500	48.6 ±10 %		5.65 ±10 %
5600	48.5 ±10 %		5.77 ±10 %
5800	48.2 ±10 %		6.00 ±10 %

7.4 SAR MEASUREMENT RESULT WITH BODY LIQUID

Software	OPENSAR V4
Phantom	SN 20/09 SAM71
Probe	SN 18/11 EPG122
Liquid	Body Liquid Values: eps': 53.3 sigma : 1.56
Distance between dipole center and liquid	10.0 mm
Area scan resolution	dx=8mm/dy=8mm
Zoon Scan Resolution	dx=8mm/dy=8mm/dz=5mm
Frequency	1900 MHz
Input power	20 dBm
Liquid Temperature	21 °C
Lab Temperature	21 °C
Lab Humidity	45 %

股份
ig Lab

Frequency MHz	1 g SAR (W/kg/W)	10 g SAR (W/kg/W)
	measured	measured
1900	40.91 (4.09)	21.40 (2.14)

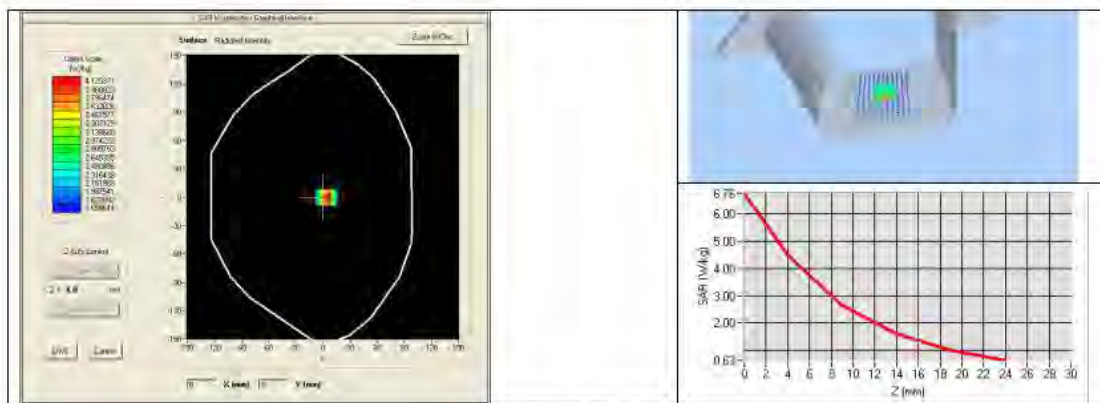

Page: 10/11

This document shall not be reproduced, except in full or in part, without the written approval of MVG. The information contained herein is to be used only for the purpose for which it is submitted and is not to be released in whole or part without written approval of MVG.

股份
ig Lab





SAR REFERENCE DIPOLE CALIBRATION REPORT

REF ACR 273.2.18.SATU.A

股份
ig Lab

8 LIST OF EQUIPMENT

Equipment Summary Sheet				
Equipment Description	Manufacturer / Model	Identification No.	Current Calibration Date	Next Calibration Date
SAM Phantom	MVG	SN-20/09-SAM71	Validated. No cal required.	Validated. No cal required.
COMOSAR Test Bench	Version 3	NA	Validated. No cal required.	Validated. No cal required.
Network Analyzer	Rhode & Schwarz ZVA	SN100132	06/2021	06/2024
Calipers	Carrera	CALIPER-01	01/2020	01/2023
Reference Probe	MVG	EPG122 SN 18/11	08/2021	08/2022
Multimeter	Keithley 2000	1188656	01/2020	01/2023
Signal Generator	Agilent E4438C	MY49070581	01/2020	01/2023
Amplifier	Aethercomm	SN 046	Characterized prior to test. No cal required.	Characterized prior to test. No cal required.
Power Meter	HP E4418A	US38261498	11/2020	11/2023
Power Sensor	HP ECP-E26A	US37181460	01/2020	01/2023
Directional Coupler	Narda 4216-20	01386	Characterized prior to test. No cal required.	Characterized prior to test. No cal required.
Temperature and Humidity Sensor	Control Company	150798832	11/2020	11/2023

股份
ig Lab

This document shall not be reproduced, except in full or in part, without the written approval of MVG. The information contained herein is to be used only for the purpose for which it is submitted and is not to be released in whole or part without written approval of MVG.

股份
ig Lab





5.5 SID2450 Dipole Calibration Certificate



SAR Reference Dipole Calibration Report

Ref : ACR.287.8.14.SATU.A

SHENZHEN LCS COMPLIANCE TESTING LABORATORY LTD.
1F., XINGYUAN INDUSTRIAL PARK, TONGDA ROAD, BAO'AN BLVD
BAO'AN DISTRICT, SHENZHEN, GUANGDONG, CHINA
SATIMO COMOSAR REFERENCE DIPOLE
FREQUENCY: 2450 MHZ
SERIAL NO.: SN 07/14 DIP 2G450-306

Calibrated at SATIMO US
2105 Barrett Park Dr. - Kennesaw, GA 30144



09/29/2021

Summary:

This document presents the method and results from an accredited SAR reference dipole calibration performed in SATIMO USA using the COMOSAR test bench. All calibration results are traceable to national metrology institutions.





SAR REFERENCE DIPOLE CALIBRATION REPORT

Ref: ACR.287.8.14.SATIM.A

股份
ig Lab

	<i>Name</i>	<i>Function</i>	<i>Date</i>	<i>Signature</i>
<i>Prepared by :</i>	Jérôme LUC	Product Manager	10/12/2021	
<i>Checked by :</i>	Jérôme LUC	Product Manager	10/12/2021	
<i>Approved by :</i>	Kim RUTKOWSKI	Quality Manager	10/12/2021	

	<i>Customer Name</i>
<i>Distribution :</i>	Shenzhen LCS Compliance Testing Laboratory Ltd.

<i>Issue</i>	<i>Date</i>	<i>Modifications</i>
A	10/12/2021	Initial release

This document shall not be reproduced, except in full or in part, without the written approval of SATIMO. The information contained herein is to be used only for the purpose for which it is submitted and is not to be released in whole or part without written approval of SATIMO.

股份
ig Lab

股份
ig Lab





股份
ig Lab

TABLE OF CONTENTS

1	Introduction.....	4
2	Device Under Test	4
3	Product Description	4
3.1	General Information	4
4	Measurement Method	5
4.1	Return Loss Requirements	5
4.2	Mechanical Requirements	5
5	Measurement Uncertainty.....	5
5.1	Return Loss	5
5.2	Dimension Measurement	5
5.3	Validation Measurement	5
6	Calibration Measurement Results	6
6.1	Return Loss and Impedance	6
6.2	Mechanical Dimensions	6
7	Validation measurement	7
7.1	Head Liquid Measurement	7
7.2	SAR Measurement Result With Head Liquid	7
7.3	Body Liquid Measurement	9
7.4	SAR Measurement Result With Body Liquid	9
8	List of Equipment	11

股份
ig Lab

This document shall not be reproduced, except in full or in part, without the written approval of SATIMO. The information contained herein is to be used only for the purpose for which it is submitted and is not to be released in whole or part without written approval of SATIMO.

股份
ig Lab



1 INTRODUCTION

This document contains a summary of the requirements set forth by the IEEE 1528, OET 65 Bulletin C and CEI/IEC 62209 standards for reference dipoles used for SAR measurement system validations and the measurements that were performed to verify that the product complies with the fore mentioned standards.

2 DEVICE UNDER TEST

Device Under Test	
Device Type	COMOSAR 2450 MHz REFERENCE DIPOLE
Manufacturer	Satimo
Model	SID2450
Serial Number	SN 07/14-DIP 2G450-306
Product Condition (new / used)	New

A yearly calibration interval is recommended.

3 PRODUCT DESCRIPTION

3.1 GENERAL INFORMATION

Satimo's COMOSAR Validation Dipoles are built in accordance to the IEEE 1528, OET 65 Bulletin C and CEI/IEC 62209 standards. The product is designed for use with the COMOSAR test bench only.



Figure 1 – Satimo COMOSAR Validation Dipole

Page: 4/11

This document shall not be reproduced, except in full or in part, without the written approval of SATIMO. The information contained herein is to be used only for the purpose for which it is submitted and is not to be released in whole or part without written approval of SATIMO.





股份
ig Lab

4 MEASUREMENT METHOD

The IEEE 1528, OET 65 Bulletin C and CEI/IEC 62209 standards provide requirements for reference dipoles used for system validation measurements. The following measurements were performed to verify that the product complies with the fore mentioned standards.

4.1 RETURN LOSS REQUIREMENTS

The dipole used for SAR system validation measurements and checks must have a return loss of -20 dB or better. The return loss measurement shall be performed against a liquid filled flat phantom, with the phantom constructed as outlined in the fore mentioned standards.

4.2 MECHANICAL REQUIREMENTS

The IEEE Std. 1528 and CEI/IEC 62209 standards specify the mechanical components and dimensions of the validation dipoles, with the dimensions frequency and phantom shell thickness dependent. The COMOSAR test bench employs a 2 mm phantom shell thickness therefore the dipoles sold for use with the COMOSAR test bench comply with the requirements set forth for a 2 mm phantom shell thickness.

5 MEASUREMENT UNCERTAINTY

All uncertainties listed below represent an expanded uncertainty expressed at approximately the 95% confidence level using a coverage factor of k=2, traceable to the Internationally Accepted Guides to Measurement Uncertainty.

5.1 RETURN LOSS

The following uncertainties apply to the return loss measurement:

Frequency band	Expanded Uncertainty on Return Loss
400-6000MHz	0.1 dB

5.2 DIMENSION MEASUREMENT

The following uncertainties apply to the dimension measurements:

Length (mm)	Expanded Uncertainty on Length
3 - 300	0.05 mm

5.3 VALIDATION MEASUREMENT

The guidelines outlined in the IEEE 1528, OET 65 Bulletin C, CENELEC EN50361 and CEI/IEC 62209 standards were followed to generate the measurement uncertainty for validation measurements.

Scan Volume	Expanded Uncertainty
1 g	20.3 %
10 g	20.1 %

Page: 5/11

This document shall not be reproduced, except in full or in part, without the written approval of SATIMO. The information contained herein is to be used only for the purpose for which it is submitted and is not to be released in whole or part without written approval of SATIMO.

股份
ig Lab

股份
ig Lab





股份
ig Lab

6 CALIBRATION MEASUREMENT RESULTS

6.1 RETURN LOSS AND IMPEDANCE

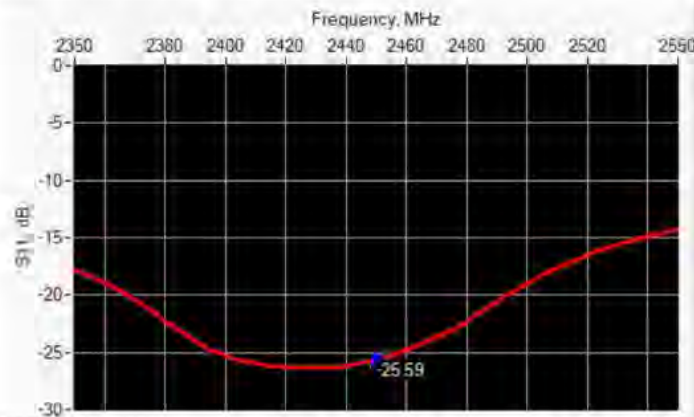

Frequency (MHz)	Return Loss (dB)	Requirement (dB)	Impedance
2450	-25.59	-20	44.7 Ω - 1.1 jΩ

6.2 MECHANICAL DIMENSIONS

Frequency MHz	L mm		h mm		d mm	
	required	measured	required	measured	required	measured
300	420.0 ±1 %.		250.0 ±1 %.		6.35 ±1 %.	
450	290.0 ±1 %.		166.7 ±1 %.		6.35 ±1 %.	
750	176.0 ±1 %.		100.0 ±1 %.		6.35 ±1 %.	
835	161.0 ±1 %.		89.8 ±1 %.		3.6 ±1 %.	
900	149.0 ±1 %.		83.3 ±1 %.		3.6 ±1 %.	
1450	89.1 ±1 %.		51.7 ±1 %.		3.6 ±1 %.	
1500	80.5 ±1 %.		50.0 ±1 %.		3.6 ±1 %.	
1640	79.0 ±1 %.		45.7 ±1 %.		3.6 ±1 %.	
1750	75.2 ±1 %.		42.9 ±1 %.		3.6 ±1 %.	
1800	72.0 ±1 %.		41.7 ±1 %.		3.6 ±1 %.	
1900	68.0 ±1 %.		39.5 ±1 %.		3.6 ±1 %.	
1950	66.3 ±1 %.		38.5 ±1 %.		3.6 ±1 %.	
2000	64.5 ±1 %.		37.5 ±1 %.		3.6 ±1 %.	
2100	61.0 ±1 %.		35.7 ±1 %.		3.6 ±1 %.	
2300	55.5 ±1 %.		32.6 ±1 %.		3.6 ±1 %.	
2450	51.5 ±1 %.	PASS	30.4 ±1 %.	PASS	3.6 ±1 %.	PASS
2600	48.5 ±1 %.		28.8 ±1 %.		3.6 ±1 %.	
3000	41.5 ±1 %.		25.0 ±1 %.		3.6 ±1 %.	
3500	37.0 ±1 %.		26.4 ±1 %.		3.6 ±1 %.	
3700	34.7 ±1 %.		26.4 ±1 %.		3.6 ±1 %.	

Page: 6/11

This document shall not be reproduced, except in full or in part, without the written approval of SATIMO.
The information contained herein is to be used only for the purpose for which it is submitted and is not to be released in whole or part without written approval of SATIMO.

股份
ig Lab

股份
ig Lab





股份
ig Lab

7 VALIDATION MEASUREMENT

The IEEE Std. 1528, OET 65 Bulletin C and CEI/IEC 62209 standards state that the system validation measurements must be performed using a reference dipole meeting the fore mentioned return loss and mechanical dimension requirements. The validation measurement must be performed against a liquid filled flat phantom, with the phantom constructed as outlined in the fore mentioned standards. Per the standards, the dipole shall be positioned below the bottom of the phantom, with the dipole length centered and parallel to the longest dimension of the flat phantom, with the top surface of the dipole at the described distance from the bottom surface of the phantom.

7.1 HEAD LIQUID MEASUREMENT

Frequency MHz	Relative permittivity (ϵ_r)		Conductivity (σ) S/m	
	required	measured	required	measured
300	45.3 ±5 %		0.87 ±5 %	
450	43.5 ±5 %		0.87 ±5 %	
750	41.9 ±5 %		0.89 ±5 %	
835	41.5 ±5 %		0.90 ±5 %	
900	41.5 ±5 %		0.97 ±5 %	
1450	40.5 ±5 %		1.20 ±5 %	
1500	40.4 ±5 %		1.23 ±5 %	
1640	40.2 ±5 %		1.31 ±5 %	
1750	40.1 ±5 %		1.37 ±5 %	
1800	40.0 ±5 %		1.40 ±5 %	
1900	40.0 ±5 %		1.40 ±5 %	
1950	40.0 ±5 %		1.40 ±5 %	
2000	40.0 ±5 %		1.40 ±5 %	
2100	39.8 ±5 %		1.49 ±5 %	
2300	39.5 ±5 %		1.67 ±5 %	
2450	39.2 ±5 %	PASS	1.80 ±5 %	PASS
2600	39.0 ±5 %		1.96 ±5 %	
3000	38.5 ±5 %		2.40 ±5 %	
3500	37.9 ±5 %		2.91 ±5 %	

股份
ig Lab

7.2 SAR MEASUREMENT RESULT WITH HEAD LIQUID

The IEEE Std. 1528 and CEI/IEC 62209 standards state that the system validation measurements should produce the SAR values shown below (for phantom thickness of 2 mm), within the uncertainty for the system validation. All SAR values are normalized to 1 W forward power. In bracket, the measured SAR is given with the used input power.

Software	OPENSAR V4
Phantom	SN 20/09 SAM71
Probe	SN 18/11 EPG122
Liquid	Head Liquid Values: ϵ_{ps}' : 39.0 σ : 1.77
Distance between dipole center and liquid	10.0 mm
Area scan resolution	$dx=8mm; dy=8mm$

Page: 7/11

*This document shall not be reproduced, except in full or in part, without the written approval of SATIMO.
The information contained herein is to be used only for the purpose for which it is submitted and is not to be released in whole or part without written approval of SATIMO.*

股份
ig Lab





SAR REFERENCE DIPOLE CALIBRATION REPORT

Ref: ACR.287.8.14.SATIM.A

股份
ig Lab

Zoon Scan Resolution	dx=8mm/dy=8mm/dz=5mm
Frequency	2450 MHz
Input power	20 dBm
Liquid Temperature	21 °C
Lab Temperature	21 °C
Lab Humidity	45 %

Frequency MHz	1 g SAR (W/kg/W)		10 g SAR (W/kg/W)	
	required	measured	required	measured
300	2.85		1.94	
450	4.58		3.06	
750	8.49		5.55	
835	9.56		6.22	
900	10.9		6.99	
1450	29		16	
1500	30.5		16.8	
1640	34.2		18.4	
1750	36.4		19.3	
1800	38.4		20.1	
1900	39.7		20.5	
1950	40.5		20.9	
2000	41.1		21.1	
2100	43.6		21.9	
2300	48.7		23.3	
2450	52.4	53.89 (5.39)	24	24.15 (2.42)
2600	55.3		24.6	
3000	63.8		25.7	
3500	67.1		25	

股份
ig Lab

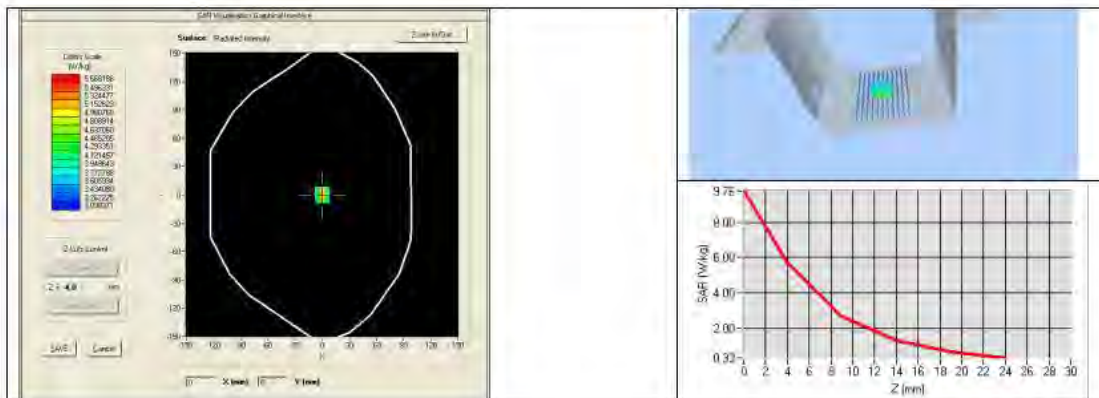

This document shall not be reproduced, except in full or in part, without the written approval of SATIMO. The information contained herein is to be used only for the purpose for which it is submitted and is not to be released in whole or part without written approval of SATIMO.

股份
ig Lab





SAR REFERENCE DIPOLE CALIBRATION REPORT

Ref: ACR-287.8.14.SATIM.A

股份
ig Lab

7.3 BODY LIQUID MEASUREMENT

Frequency MHz	Relative permittivity (ϵ_r)		Conductivity (σ) S/m	
	required	measured	required	measured
150	61.9 ±5 %		0.80 ±5 %	
300	58.2 ±5 %		0.92 ±5 %	
450	56.7 ±5 %		0.94 ±5 %	
750	55.5 ±5 %		0.96 ±5 %	
835	55.2 ±5 %		0.97 ±5 %	
900	55.0 ±5 %		1.05 ±5 %	
915	55.0 ±5 %		1.06 ±5 %	
1450	54.0 ±5 %		1.30 ±5 %	
1610	53.8 ±5 %		1.40 ±5 %	
1800	53.3 ±5 %		1.52 ±5 %	
1900	53.3 ±5 %		1.52 ±5 %	
2000	53.3 ±5 %		1.52 ±5 %	
2100	53.2 ±5 %		1.62 ±5 %	
2450	52.7 ±5 %	PASS	1.95 ±5 %	PASS
2600	52.5 ±5 %		2.16 ±5 %	
3000	52.0 ±5 %		2.73 ±5 %	
3500	51.3 ±5 %		3.31 ±5 %	
5200	49.0 ±10 %		5.30 ±10 %	
5300	48.9 ±10 %		5.42 ±10 %	
5400	48.7 ±10 %		5.53 ±10 %	
5500	48.6 ±10 %		5.65 ±10 %	
5600	48.5 ±10 %		5.77 ±10 %	
5800	48.2 ±10 %		6.00 ±10 %	

股份
ig Lab

7.4 SAR MEASUREMENT RESULT WITH BODY LIQUID

Software	OPENSAR V4
Phantom	SN 20/09 SAM71
Probe	SN 18/11 EPG122
Liquid	Body Liquid Values: ϵ_r : 53.0 σ : 1.93
Distance between dipole center and liquid	10.0 mm
Area scan resolution	$dx=8mm/dy=8mm$
Zoon Scan Resolution	$dx=8mm/dy=8mm/dz=5mm$
Frequency	2450 MHz
Input power	20 dBm
Liquid Temperature	21 °C
Lab Temperature	21 °C
Lab Humidity	45 %

Page: 9/11

This document shall not be reproduced, except in full or in part, without the written approval of SATIMO. The information contained herein is to be used only for the purpose for which it is submitted and is not to be released in whole or part without written approval of SATIMO.

股份
ig Lab





SAR REFERENCE DIPOLE CALIBRATION REPORT

Ref: ACR.287.8.14.SATIM.A

股份
ig Lab

Frequency MHz	1 g SAR (W/kg/W)	10 g SAR (W/kg/W)
	measured	measured
2450	54.65 (5.46)	24.58 (2.46)

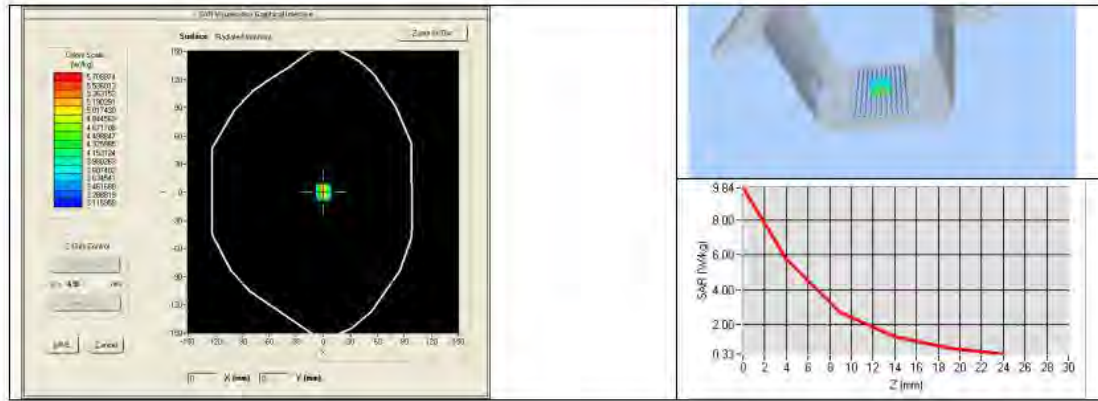

股份
ig Lab

This document shall not be reproduced, except in full or in part, without the written approval of SATIMO. The information contained herein is to be used only for the purpose for which it is submitted and is not to be released in whole or part without written approval of SATIMO.

股份
ig Lab





股份
ig Lab

8 LIST OF EQUIPMENT

Equipment Summary Sheet				
Equipment Description	Manufacturer / Model	Identification No.	Current Calibration Date	Next Calibration Date
SAM Phantom	Satimo	SN-20/09-SAM71	Validated. No cal required.	Validated. No cal required.
COMOSAR Test Bench	Version 3	NA	Validated. No cal required.	Validated. No cal required.
Network Analyzer	Rhode & Schwarz ZVA	SN100132	02/2021	02/2024
Calipers	Carrera	CALIPER-01	12/2018	12/2021
Reference Probe	Satimo	EPG122 SN 18/11	10/2021	10/2022
Multimeter	Keithley 2000	1188656	12/2018	12/2021
Signal Generator	Agilent E4438C	MY49070581	12/2018	12/2021
Amplifier	Aethercomm	SN 046	Characterized prior to test. No cal required.	Characterized prior to test. No cal required.
Power Meter	HP E4418A	US38261498	12/2018	12/2021
Power Sensor	HP ECP-E26A	US37181460	12/2018	12/2021
Directional Coupler	Narda 4216-20	01386	Characterized prior to test. No cal required.	Characterized prior to test. No cal required.
Temperature and Humidity Sensor	Control Company	11-661-9	8/2021	8/2024

股份
ig Lab

This document shall not be reproduced, except in full or in part, without the written approval of SATIMO. The information contained herein is to be used only for the purpose for which it is submitted and is not to be released in whole or part without written approval of SATIMO.

股份
ig Lab





5.6 SID2600 Dipole Calibration Certificate



股份
ing Lab

SAR Reference Dipole Calibration Report

Ref: ACR.273.4.18.SATU.A

**SHENZHEN LCS COMPLIANCE TESTING
LABORATORY LTD.**
**1F., XINGYUAN INDUSTRIAL PARK, TONGDA ROAD,
BAO'AN BLVD**
BAO'AN DISTRICT, SHENZHEN, GUANGDONG, CHINA
MVG COMOSAR REFERENCE DIPOLE
FREQUENCY: 2600 MHZ
SERIAL NO.: SN 38/18 DIP 2G600-468

股份
ing Lab

Calibrated at MVG US
2105 Barrett Park Dr. - Kennesaw, GA 30144



Calibration Date: 09/22/2021

Summary:

This document presents the method and results from an accredited SAR reference dipole calibration performed in MVG USA using the COMOSAR test bench. All calibration results are traceable to national metrology institutions.

股份
ing Lab





SAR REFERENCE DIPOLE CALIBRATION REPORT

Ref: ACR.273.4.18.SATL.A

股份
ig Lab

	Name	Function	Date	Signature
Prepared by :	Jérôme LUC	Product Manager	09/28/2021	
Checked by :	Jérôme LUC	Product Manager	09/28/2021	
Approved by :	Kim RUTKÓWSKI	Quality Manager	09/28/2021	

	Customer Name
Distribution :	Shenzhen LCS Compliance Testing Laboratory Ltd.

股份
ig Lab

Issue	Date	Modifications
A	09/28/2021	Initial release

*This document shall not be reproduced, except in full or in part, without the written approval of MVG.
The information contained herein is to be used only for the purpose for which it is submitted and is not to be released in whole or part without written approval of MVG.*

股份
ig Lab





SAR REFERENCE DIPOLE CALIBRATION REPORT

Ref: ACR.273.4.18.SATL.A

股份
ig Lab

TABLE OF CONTENTS

1 Introduction..... 4

2 Device Under Test..... 4

3 Product Description..... 4

 3.1 General Information..... 4

4 Measurement Method..... 5

 4.1 Return Loss Requirements..... 5

 4.2 Mechanical Requirements..... 5

5 Measurement Uncertainty..... 5

 5.1 Return Loss..... 5

 5.2 Dimension Measurement..... 5

 5.3 Validation Measurement..... 5

6 Calibration Measurement Results..... 6

 6.1 Return Loss and Impedance In Head Liquid..... 6

 6.2 Return Loss and Impedance In Body Liquid..... 6

 6.3 Mechanical Dimensions..... 6

7 Validation measurement..... 7

 7.1 Head Liquid Measurement..... 7

 7.2 SAR Measurement Result With Head Liquid..... 8

 7.3 Body Liquid Measurement..... 9

 7.4 SAR Measurement Result With Body Liquid..... 10

8 List of Equipment..... 11

股份
ig Lab

*This document shall not be reproduced, except in full or in part, without the written approval of MVG.
The information contained herein is to be used only for the purpose for which it is submitted and is not to be released in whole or part without written approval of MVG.*

股份
ig Lab





股份
ig Lab

1 INTRODUCTION

This document contains a summary of the requirements set forth by the IEEE 1528, FCC KDBs and CEI/IEC 62209 standards for reference dipoles used for SAR measurement system validations and the measurements that were performed to verify that the product complies with the fore mentioned standards.

2 DEVICE UNDER TEST

Device Under Test	
Device Type	COMOSAR 2600 MHz REFERENCE DIPOLE
Manufacturer	MVG
Model	SID2600
Serial Number	SN 38/18 DIP 2G600-468
Product Condition (new / used)	Used

A yearly calibration interval is recommended.

3 PRODUCT DESCRIPTION

3.1 GENERAL INFORMATION

MVG's COMOSAR Validation Dipoles are built in accordance to the IEEE 1528, FCC KDBs and CEI/IEC 62209 standards. The product is designed for use with the COMOSAR test bench only.



Figure 1 – MVG COMOSAR Validation Dipole

股份
ig Lab





股份
ig Lab

4 MEASUREMENT METHOD

The IEEE 1528, FCC KDBs and CEI/IEC 62209 standards provide requirements for reference dipoles used for system validation measurements. The following measurements were performed to verify that the product complies with the fore mentioned standards.

4.1 RETURN LOSS REQUIREMENTS

The dipole used for SAR system validation measurements and checks must have a return loss of -20 dB or better. The return loss measurement shall be performed against a liquid filled flat phantom, with the phantom constructed as outlined in the fore mentioned standards.

4.2 MECHANICAL REQUIREMENTS

The IEEE Std. 1528 and CEI/IEC 62209 standards specify the mechanical components and dimensions of the validation dipoles, with the dimensions frequency and phantom shell thickness dependent. The COMOSAR test bench employs a 2 mm phantom shell thickness therefore the dipoles sold for use with the COMOSAR test bench comply with the requirements set forth for a 2 mm phantom shell thickness.

5 MEASUREMENT UNCERTAINTY

All uncertainties listed below represent an expanded uncertainty expressed at approximately the 95% confidence level using a coverage factor of k=2, traceable to the Internationally Accepted Guides to Measurement Uncertainty.

5.1 RETURN LOSS

The following uncertainties apply to the return loss measurement:

Frequency band	Expanded Uncertainty on Return Loss
400-6000MHz	0.1 dB

5.2 DIMENSION MEASUREMENT

The following uncertainties apply to the dimension measurements:

Length (mm)	Expanded Uncertainty on Length
3 - 300	0.05 mm

5.3 VALIDATION MEASUREMENT

The guidelines outlined in the IEEE 1528, FCC KDBs, CENELEC EN50361 and CEI/IEC 62209 standards were followed to generate the measurement uncertainty for validation measurements.

Scan Volume	Expanded Uncertainty
1 g	20.3 %

股份
ig Lab

股份
ig Lab





SAR REFERENCE DIPOLE CALIBRATION REPORT

Rev. ACR.273.4.18.SATL.A

股份
ig Lab

10 g	20.1 %
------	--------

6 CALIBRATION MEASUREMENT RESULTS

6.1 RETURN LOSS AND IMPEDANCE IN HEAD LIQUID

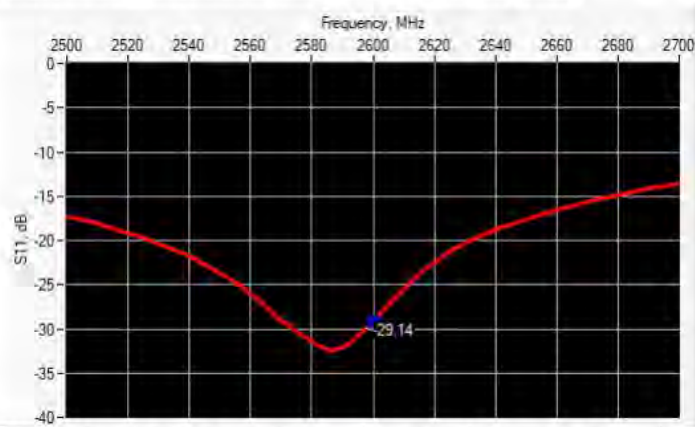

Frequency (MHz)	Return Loss (dB)	Requirement (dB)	Impedance
2600	-29.14	-20	49.2 Ω + 3.4 jΩ

6.2 RETURN LOSS AND IMPEDANCE IN BODY LIQUID

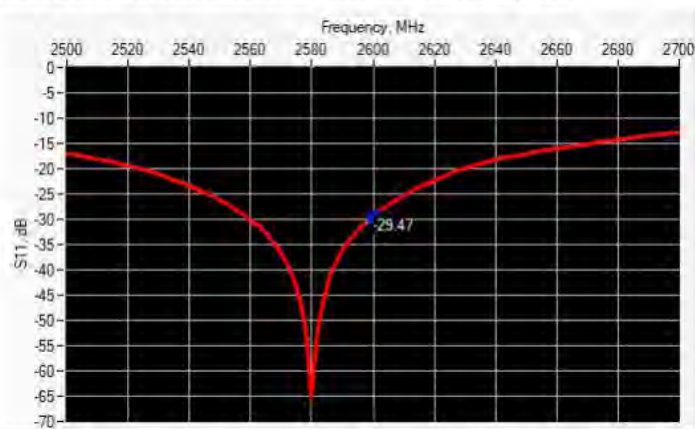

Frequency (MHz)	Return Loss (dB)	Requirement (dB)	Impedance
2600	-29.47	-20	47.5 Ω + 2.2 jΩ

6.3 MECHANICAL DIMENSIONS

Frequency MHz	L mm		h mm		d mm	
	required	measured	required	measured	required	measured
300	420.0 ±1 %		250.0 ±1 %		6.35 ±1 %	

Page: 6/11

*This document shall not be reproduced, except in full or in part, without the written approval of MVG.
The information contained herein is to be used only for the purpose for which it is submitted and is not to be released in whole or part without written approval of MVG.*

股份
ig Lab





SAR REFERENCE DIPOLE CALIBRATION REPORT

Ref: ACR-2734-18-SATL-A

股份
ig Lab

450	290.0 ±1 %.		166.7 ±1 %.		6.35 ±1 %.	
750	176.0 ±1 %.		100.0 ±1 %.		6.35 ±1 %.	
835	161.0 ±1 %.		89.8 ±1 %.		3.6 ±1 %.	
900	149.0 ±1 %.		83.3 ±1 %.		3.6 ±1 %.	
1450	89.1 ±1 %.		51.7 ±1 %.		3.6 ±1 %.	
1500	80.5 ±1 %.		50.0 ±1 %.		3.6 ±1 %.	
1640	79.0 ±1 %.		45.7 ±1 %.		3.6 ±1 %.	
1750	75.2 ±1 %.		42.9 ±1 %.		3.6 ±1 %.	
1800	72.0 ±1 %.		41.7 ±1 %.		3.6 ±1 %.	
1900	68.0 ±1 %.		39.5 ±1 %.		3.6 ±1 %.	
1950	66.3 ±1 %.		38.5 ±1 %.		3.6 ±1 %.	
2000	64.5 ±1 %.		37.5 ±1 %.		3.6 ±1 %.	
2100	61.0 ±1 %.		35.7 ±1 %.		3.6 ±1 %.	
2300	55.5 ±1 %.		32.6 ±1 %.		3.6 ±1 %.	
2450	51.5 ±1 %.		30.4 ±1 %.		3.6 ±1 %.	
2600	48.5 ±1 %.	PASS	28.8 ±1 %.	PASS	3.6 ±1 %.	PASS
3000	41.5 ±1 %.		25.0 ±1 %.		3.6 ±1 %.	
3500	37.0 ±1 %.		26.4 ±1 %.		3.6 ±1 %.	
3700	34.7 ±1 %.		26.4 ±1 %.		3.6 ±1 %.	

7 VALIDATION MEASUREMENT

The IEEE Std. 1528, FCC KDBs and CEM/IEC 62209 standards state that the system validation measurements must be performed using a reference dipole meeting the fore mentioned return loss and mechanical dimension requirements. The validation measurement must be performed against a liquid filled flat phantom, with the phantom constructed as outlined in the fore mentioned standards. Per the standards, the dipole shall be positioned below the bottom of the phantom, with the dipole length centered and parallel to the longest dimension of the flat phantom, with the top surface of the dipole at the described distance from the bottom surface of the phantom.

7.1 HEAD LIQUID MEASUREMENT

Frequency MHz	Relative permittivity (ϵ_r)		Conductivity (σ) S/m	
	required	measured	required	measured
300	45.3 ±5 %		0.87 ±5 %	
450	43.5 ±5 %		0.87 ±5 %	
750	41.9 ±5 %		0.89 ±5 %	
835	41.5 ±5 %		0.90 ±5 %	
900	41.5 ±5 %		0.97 ±5 %	
1450	40.5 ±5 %		1.20 ±5 %	
1500	40.4 ±5 %		1.23 ±5 %	
1640	40.2 ±5 %		1.31 ±5 %	
1750	40.1 ±5 %		1.37 ±5 %	

Page: 7/11

*This document shall not be reproduced, except in full or in part, without the written approval of MVG.
The information contained herein is to be used only for the purpose for which it is submitted and is not to be released in whole or part without written approval of MVG.*

股份
ig Lab





SAR REFERENCE DIPOLE CALIBRATION REPORT

Ref: ACR-2734-18-SATL-A

股份
1g Lab

1800	40.0 ±5 %		1.40 ±5 %	
1900	40.0 ±5 %		1.40 ±5 %	
1950	40.0 ±5 %		1.40 ±5 %	
2000	40.0 ±5 %		1.40 ±5 %	
2100	39.8 ±5 %		1.49 ±5 %	
2300	39.5 ±5 %		1.67 ±5 %	
2450	39.2 ±5 %		1.80 ±5 %	
2600	39.0 ±5 %	PASS	1.96 ±5 %	PASS
3000	38.5 ±5 %		2.40 ±5 %	
3500	37.9 ±5 %		2.91 ±5 %	

7.2 SAR MEASUREMENT RESULT WITH HEAD LIQUID

The IEEE Std. 1528 and CEI/IEC 62209 standards state that the system validation measurements should produce the SAR values shown below (for phantom thickness of 2 mm), within the uncertainty for the system validation. All SAR values are normalized to 1 W forward power. In bracket, the measured SAR is given with the used input power.

Software	OPENSAR V4
Phantom	SN 20/09 SAM71
Probe	SN 18/11 EPG122
Liquid	Head Liquid Values: $\epsilon_{ps} = 39.8$ $\sigma_{ps} = 1.99$
Distance between dipole center and liquid	10.0 mm
Area scan resolution	$dx=8mm/dy=8mm$
Zoon Scan Resolution	$dx=5mm/dy=5mm/dz=5mm$
Frequency	2600 MHz
Input power	20 dBm
Liquid Temperature	21 °C
Lab Temperature	21 °C
Lab Humidity	45 %

股份
1g Lab

Frequency MHz	1 g SAR (W/kg/W)		10 g SAR (W/kg/W)	
	required	measured	required	measured
300	2.85		1.94	
450	4.58		3.06	
750	8.49		5.55	
835	9.56		6.22	
900	10.9		6.99	
1450	29		16	
1500	30.5		16.8	
1640	34.2		18.4	
1750	36.4		19.3	
1800	38.4		20.1	

Page: 8/11

This document shall not be reproduced, except in full or in part, without the written approval of MVG. The information contained herein is to be used only for the purpose for which it is submitted and is not to be released in whole or part without written approval of MVG.

股份
1g Lab





SAR REFERENCE DIPOLE CALIBRATION REPORT

Ref: ACR_273.4.18.SATU.A

股份
ig Lab

1900	39.7		20.5	
1950	40.5		20.9	
2000	41.1		21.1	
2100	43.6		21.9	
2300	48.7		23.3	
2450	52.4		24	
2600	55.3	56.91 (5.69)	24.6	24.69 (2.47)
3000	63.8		25.7	
3500	67.1		25	
3700	67.4		24.2	

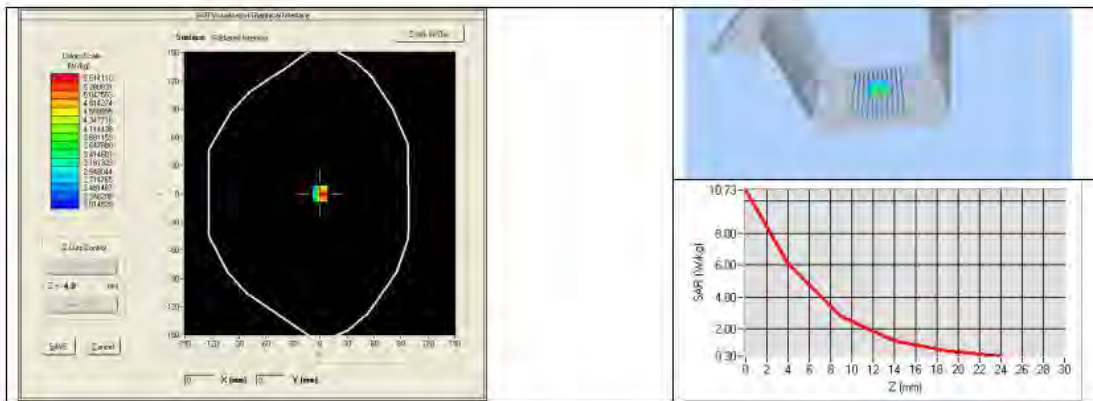

股份
ig Lab

7.3 BODY LIQUID MEASUREMENT

Frequency MHz	Relative permittivity (ϵ_r')		Conductivity (σ) S/m	
	required	measured	required	measured
150	61.9 ±5 %		0.80 ±5 %	
300	58.2 ±5 %		0.92 ±5 %	
450	56.7 ±5 %		0.94 ±5 %	
750	55.5 ±5 %		0.96 ±5 %	
835	55.2 ±5 %		0.97 ±5 %	
900	55.0 ±5 %		1.05 ±5 %	
915	55.0 ±5 %		1.06 ±5 %	
1450	54.0 ±5 %		1.30 ±5 %	
1610	53.8 ±5 %		1.40 ±5 %	
1800	53.3 ±5 %		1.52 ±5 %	
1900	53.3 ±5 %		1.52 ±5 %	
2000	53.3 ±5 %		1.52 ±5 %	
2100	53.2 ±5 %		1.62 ±5 %	

Page: 9/11

This document shall not be reproduced, except in full or in part, without the written approval of MVG. The information contained herein is to be used only for the purpose for which it is submitted and is not to be released in whole or part without written approval of MVG.

股份
ig Lab





SAR REFERENCE DIPOLE CALIBRATION REPORT

Ref: ACR.273.4.18.SATU.A

股份
ig Lab

2300	52.9 ±5 %		1.81 ±5 %	
2450	52.7 ±5 %		1.95 ±5 %	
2600	52.5 ±5 %	PASS	2.16 ±5 %	PASS
3000	52.0 ±5 %		2.73 ±5 %	
3500	51.3 ±5 %		3.31 ±5 %	
3700	51.0 ±5 %		3.55 ±5 %	
5200	49.0 ±10 %		5.30 ±10 %	
5300	48.9 ±10 %		5.42 ±10 %	
5400	48.7 ±10 %		5.53 ±10 %	
5500	48.6 ±10 %		5.65 ±10 %	
5600	48.5 ±10 %		5.77 ±10 %	
5800	48.2 ±10 %		6.00 ±10 %	

7.4 SAR MEASUREMENT RESULT WITH BODY LIQUID

Software	OPENSAR V4
Phantom	SN 20/09 SAM71
Probe	SN 18/11 EPG122
Liquid	Body Liquid Values: cps: 52.5 sigma: 2.23
Distance between dipole center and liquid	10.0 mm
Area scan resolution	dx=8mm/dy=8mm
Zoon Scan Resolution	dx=5mm/dy=5mm/dz=5mm
Frequency	2600 MHz
Input power	20 dBm
Liquid Temperature	21 °C
Lab Temperature	21 °C
Lab Humidity	45 %

股份
ig Lab

Frequency MHz	1 g SAR (W/kg/W)	10 g SAR (W/kg/W)
	measured	measured
2600	54.14 (5.41)	24.13 (2.41)

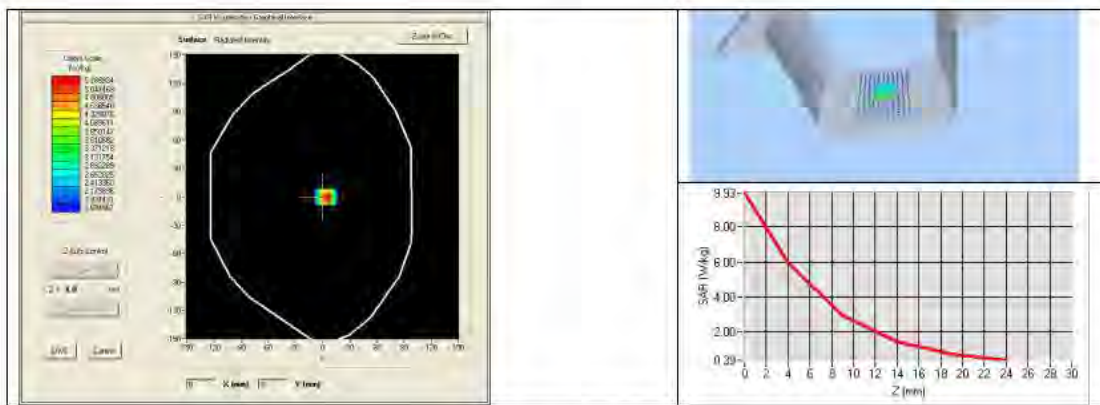

Page: 10/11

This document shall not be reproduced, except in full or in part, without the written approval of MVG. The information contained herein is to be used only for the purpose for which it is submitted and is not to be released in whole or part without written approval of MVG.

股份
ig Lab





股份
ng Lab

8 LIST OF EQUIPMENT

Equipment Summary Sheet				
Equipment Description	Manufacturer / Model	Identification No.	Current Calibration Date	Next Calibration Date
SAM Phantom	MVG	SN-20/09-SAM71	Validated. No cal required.	Validated. No cal required.
COMOSAR Test Bench	Version 3	NA	Validated. No cal required.	Validated. No cal required.
Network Analyzer	Rhode & Schwarz ZVA	SN100132	06/2021	06/2024
Calipers	Carrera	CALIPER-01	01/2020	01/2023
Reference Probe	MVG	EPG122 SN 18/11	08/2021	08/2022
Multimeter	Keithley 2000	1188656	01/2020	01/2023
Signal Generator	Agilent E4438C	MY49070581	01/2020	01/2023
Amplifier	Aethercomm	SN 046	Characterized prior to test. No cal required.	Characterized prior to test. No cal required.
Power Meter	HP E4418A	US38261498	11/2020	11/2023
Power Sensor	HP ECP-E26A	US37181460	01/2020	01/2023
Directional Coupler	Narda 4216-20	01386	Characterized prior to test. No cal required.	Characterized prior to test. No cal required.
Temperature and Humidity Sensor	Control Company	150798832	11/2020	11/2023

股份
ng Lab

This document shall not be reproduced, except in full or in part, without the written approval of MVG. The information contained herein is to be used only for the purpose for which it is submitted and is not to be released in whole or part without written approval of MVG.

股份
ng Lab



6. PHOTOGRAPHS OF THE LIQUID

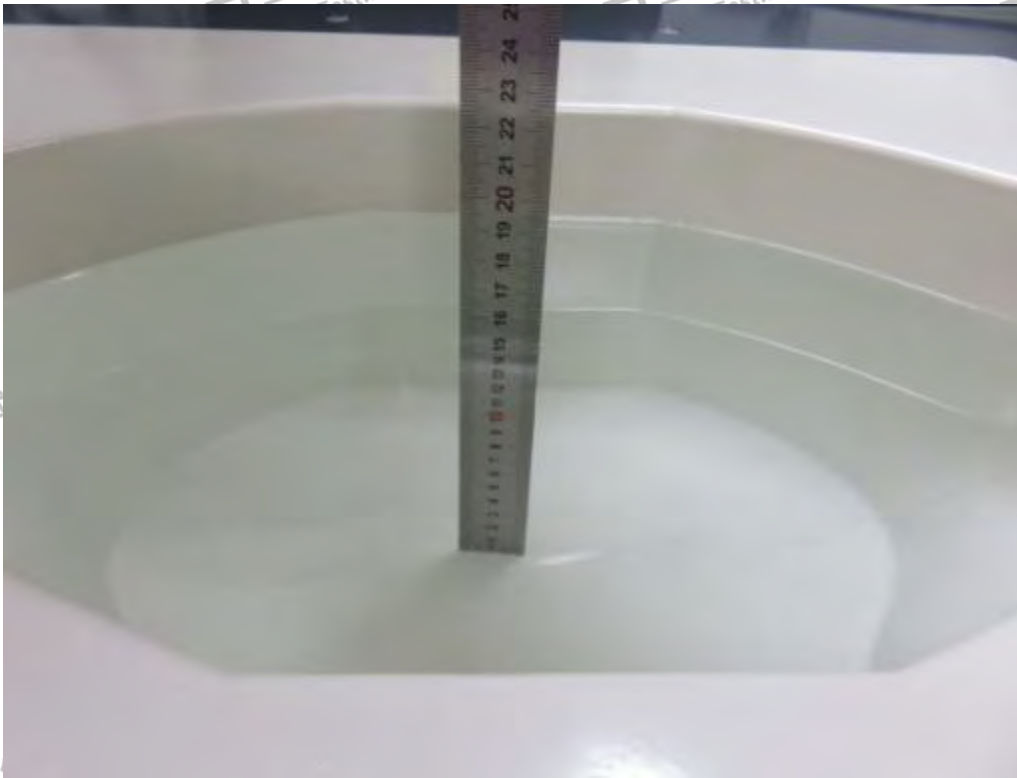

Photograph of the depth in the Body Phantom (835MHz, 16.1cm depth)

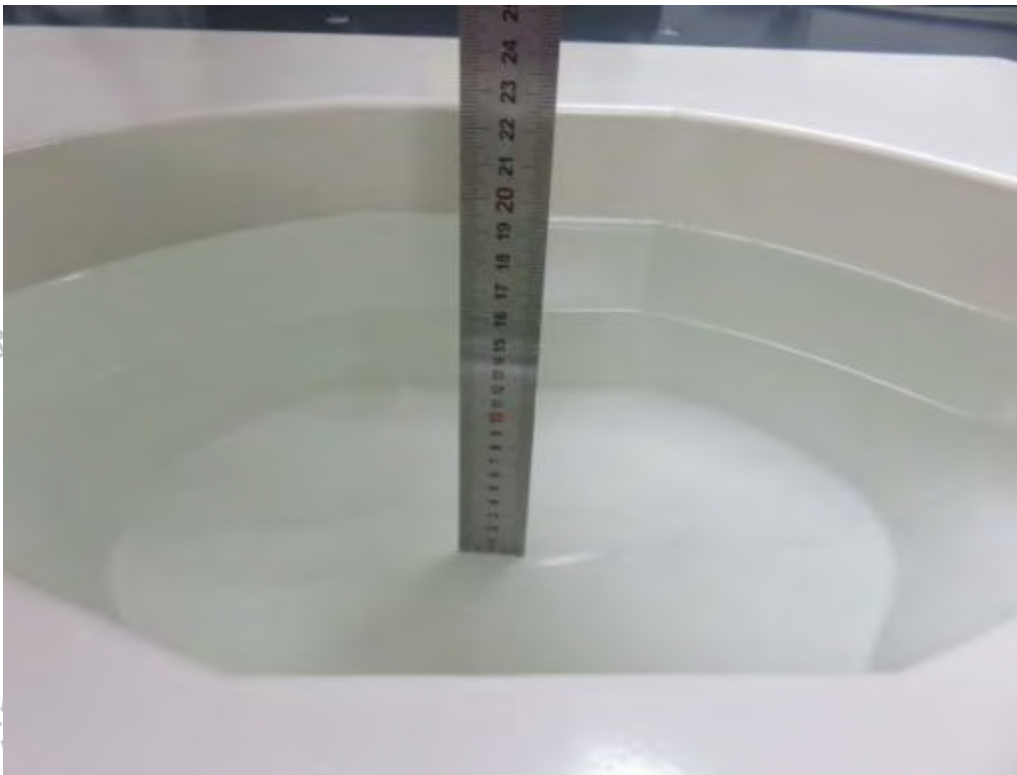

Photograph of the depth in the Body Phantom (1800MHz, 16.1cm depth)



Shenzhen LCS Compliance Testing Laboratory Ltd.

Add: 101, 201 Bldg A & 301 Bldg C, Juji Industrial Park Yabianxueziwei, Shajing Street, Baoan District, Shenzhen, 518000, China

Tel: +(86) 0755-82591330 | E-mail: webmaster@lcs-cert.com | Web: www.lcs-cert.com

Scan code to check authenticity

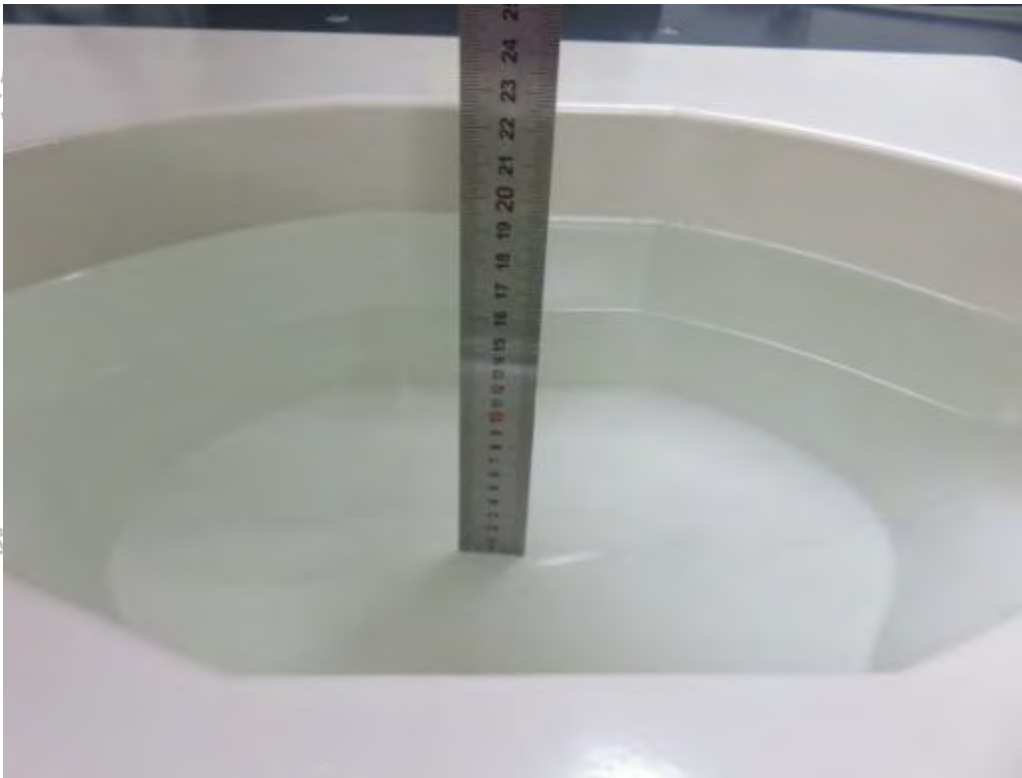

Photograph of the depth in the Body Phantom (1900MHz, 16.0cm depth)



Photograph of the depth in the Body Phantom (2450MHz, 15.6cm depth)





Photograph of the depth in the Body Phantom (2600MHz, 15.5cm depth)





7. PHOTOGRAPHS OF THE TEST

Please refer to separated files for Test Setup Photos of SAR.





8. EUT PHOTOGRAPHS

Please refer to separated files for Test Setup Photos of SAR.

.....The End of Test Report.....

