



f560x

Car Camcorder  
User Manual

# Contents

Regulatory notices .....	3
Prohibition of co-location .....	3
WEEE Notice.....	3
<a href="#">FCC</a> .....	<a href="#">4</a>
CE Regulatory Notice .....	4
Notes on Installation .....	5
Caution.....	5
<b>1 Introduction .....</b>	<b>9</b>
1.1 Features .....	9
1.2 Package Contents.....	9
1.3 Product Overview.....	10
<b>2 Getting Started .....</b>	<b>11</b>
2.1 Storage Media.....	11
2.1.1 Insert the Memory Card.....	11
2.1.2 Remove the Memory Card.....	11
2.2 Installing in Vehicles.....	12
2.2.1 Mount to Windshield.....	12
2.2.2 Adjust the Camcorder.....	13
2.3 Connecting to Power.....	14
2.4 LED Indicator .....	14
2.5 Powering the Camcorder On / Off .....	16
2.5.1 Auto Power On/Off .....	16
2.5.2 Manual Power On/Off .....	16
2.5.3 Reset.....	16
2.6 Initial Settings .....	17
2.6.1 Set Time Zone.....	17
2.6.2 Set the Date / Time.....	18
<b>3 Using the Car Camcorder .....</b>	<b>19</b>

3.1	Automatic Record .....	19
3.1.1	The Recording Screen.....	20
3.1.2	Emergency Recording .....	22
3.2	Add Speed Point .....	22
3.3	Picture in Video.....	23
3.4	Driving Safety .....	23
3.4.1	Speed Cam Alert .....	24
3.4.2	Speed Limit Alert .....	25
3.4.3	Driver Fatigue Alert.....	26
3.4.4	LDWS.....	26
3.4.5	FCWS .....	28
3.4.6	Headlight Warning .....	29
3.7	Playback Videos and Photos.....	34
3.8	The Playback Screen .....	35
3.9	Deleting Files .....	36
<b>4</b>	<b>Initial set up Go Dashcam application .....</b>	<b>38</b>
<b>5</b>	<b>Using the Go Dashcam application.....</b>	<b>41</b>
5.1	Camera preview, record, snapshot.....	42
5.2	Playback, delete, download.....	43
5.3	Local album .....	46
5.4	Camera Setting.....	47
<b>6</b>	<b>Adjusting the Settings .....</b>	<b>48</b>
6.1	Using the Menu.....	48
6.2	Menu Items.....	48
<b>7</b>	<b>Installing the Software .....</b>	<b>53</b>
<b>8</b>	<b>SuperCar.....</b>	<b>54</b>
<b>9</b>	<b>Specifications.....</b>	<b>55</b>

## About this Guide

The content in this document is for information purpose and is subject to change without prior notice. We have made every effort to ensure that this User Guide is accurate and complete.

However, no liability is assumed for any errors or omissions that may have occurred.

The manufacturer reserves the right to change the technical specifications without prior notice.

## Regulatory notices

This document provides country- and region-specific non-wireless and wireless regulatory notices and compliance information for your product. Some of these notices may not apply to your product.

## Prohibition of co-location

This device and its antenna(s) must not be co-located or operated in conjunction with any other antenna or transmitter.

## WEEE Notice

### Disposal of Waste Electrical and Electronic Equipment and/or Battery by users in private households in the European Union



**WEEE**



**Battery**

This symbol on the product or on the packaging indicates that this cannot be disposed of as a household waste. You must dispose of your waste equipment and/or battery by handling it over to the applicable take-back scheme for the recycling of electrical and electronic equipment and/or battery. For more information about recycling of this equipment and/or battery, please contact your city office, the shop where you purchased the equipment or your household waste disposal service. The recycling of materials will help to conserve natural resources and ensure that it is recycled in a manner that protects human health and environment.

## FCC

This device complies with Part 15 of the FCC Rules. Operation is subject to the following two conditions: (1) this device may not cause harmful interference, and (2) this device must accept any interference received, including interference that may cause undesired operation.

Note: This equipment has been tested and found to comply with the limits for a Class B digital device, pursuant to Part 15 of the FCC Rules. These limits are designed to provide reasonable protection against harmful interference in a residential installation. This equipment generates, uses and can radiate radio frequency energy and, if not installed and used in accordance with the instructions, may cause harmful interference to radio communications. However, there is no guarantee that interference will not occur in a particular installation.

If this equipment does cause harmful interference to radio or television reception, which can be determined by turning the equipment off and on, the user is encouraged to try to correct the interference by one or more of the following measures:

- Reorient or relocate the receiving antenna.
- Increase the separation between the equipment and receiver.
- Connect the equipment into an outlet on a circuit different from that to which the receiver is connected.
- Consult the dealer or an experienced radio/TV technician for help.

Caution: changes or modifications not expressly approved by the party responsible for compliance could void the user's authority to operate the equipment.

This equipment complies with FCC radiation exposure limits set forth for an uncontrolled environment. This equipment should be installed and operated with minimum distance 20cm between the radiator and your body. This transmitter must not be co-located or operating in conjunction with any other antenna or transmitter.

## CE Regulatory Notice

The product herewith complies with the requirements of the

RED-Directive 2014/53/EU.

EU Health Protection: This equipment should be installed and operated with minimum distance 20cm between the radiator & your body.

### Notes on Installation

1. Please measure the front windshield viewing area, make sure not to block driver's front view, install the camcorder below the rearview mirror (the central, higher right position of the front windshield). And we recommend that the sky and the land occupied by the screen 50%, fix the car holder and then adjust the camcorder so that the lane is aligned with the screen. Proper installation enables the camcorder to maximize the efficiency also can enhance the accuracy of LDWS.
2. Make sure that the lens is within the wiping range of the windscreen wiper to ensure a clear view even when it rains.
3. Do not touch the lens with your fingers. Finger grease may be left on the lens and will result in unclear videos or pictures. Clean the lens on a regular basis.
4. Do not install the camcorder on a tinted window. Doing so may damage the tint film.
5. Make sure that the installation position is not hindered by the tinted window.
6. This product is suitable for light windshield or light color heat-resistant film windows, it will affect video quality if install it on the dark windows or dark heat-resistant film windows.
7. Use the products of the attached power charger only, please do not use other brand power charger, in order to avoid equipment burn or cause the battery explosion.

### Caution

- ❖ Due to local laws and vehicles safety considerations, do not operate the camcorder while driving.
- ❖ Set up time zone, time and date accurately before you use this camcorder.
- ❖ Please use SuperCar software under the condition that Electronic Map are functioning normally.

- ❖ The firmware function in the camcorder is for reference only, drivers are advised to exercise discretion based on actual road conditions.
- ❖ The results of GPS positioning are only for reference, and should not affect the actual driving situation. The camcorder also cannot ensure the positioning accuracy.
- ❖ GPS positioning accuracy may differ depending on weather and location such as high buildings, tunnels, undergrounds, or forests. GPS satellite signals cannot pass through solid materials (except glass). Tinted window will also affect the performance of the GPS satellite reception.
- ❖ GPS reception performance on each camcorder may differ. The camcorder cannot determine the accuracy of the positioning results from different hardware.
- ❖ The values displayed in this camcorder, such as speed and position, may be inaccurate due to the influence of surrounding environment. They are for your reference only.
- ❖ This product is used only for non-commercial use, within the maximum limits permitted by applicable law. We do not take any responsibilities for the loss of use of the product.
- ❖ This camcorder gets warm when in use; this is normal.
- ❖ Improper use or operation of the product may result in damage of the product or its accessories and void the warranty.
- ❖ Wi-Fi Signals are unable to pass through the building. The upper limit of signal transmission is 5m.
- ❖ Wi-Fi Operation Channel: Ch1~Ch13 (for EU)
- ❖ The product employs wireless data communication which may interfere, or be interfered by, a near-by camcorder.
- ❖ Never use this camcorder in the vicinity of a microwave oven or at places where there is radio interference.
- ❖ Radio wave reception may be worsened in specific environments.
- ❖ Please be advised that if another camcorder is also using the same 2.4GHz band as this product, the processing speed of both camcorders may slow down.
- ❖ This product gets warm when in use; this is normal.
- ❖ Improper use or operation of the product may result in damage of the product or its accessories and void the warranty.

- ❖ The radio frequency (RF) generated by this RF electronic camcorder may cause adverse effects on the operation of other electronic camcorders and result in malfunctioning. Wireless transmitters and circuitry may also interfere with other electronic camcorders. Therefore, do observe the following precautions:
  - Aircraft: Never use a radio transmitter when you are in an airplane. Please switch off the Wi-Fi function of the camcorder.
  - Vehicle: The radio frequency transmitted by this camcorder may affect the electronic system in a motorized vehicle. Please consult the manufacturer or dealer of your vehicle on the possible effect.
  - Pacemaker: In order to prevent any potential interference to a pacemaker, anyone who uses a pacemaker should be advised, that, when using this camcorder, a minimum distance of 15cm (6 inch) should be kept between the camcorder and the pacemaker; and never put this camcorder in a chest pocket. In case of any doubt of interference, switch off the camcorder immediately.
  - Medical Camcorder: If you use a personal medical camcorder, consult the camcorder manufacturer or your physician to confirm if your camcorder is sufficiently shielded from the RF transmission of this camcorder.
  - Medical Facilities: Hospitals and medical institutes may use facilities that are sensitive to an external RF energy. Observe such instructions when the medical care personnel or any posted sign requests you to switch off any camcorder that may interfere the radio frequency.
- ❖ Explosion sites or any location with a posted sign: In order to prevent interfering with an explosion activity, observe all the signage and instructions in the Explosion Area or in a zone with a “Switch Off 2-way Radios” sign by switching off camcorders that may interfere with the radio frequency.
- ❖ HP Inc. is NOT responsible for the loss of any data/content during operation.
- ❖ Disposal of a battery into fire or a hot oven, or mechanically crushing or cutting of a battery, that can result in an explosion.



- ❖ Leaving a battery in an extremely high temperature surrounding environment that can result in an explosion or the leakage of flammable liquid or gas

# 1 Introduction





Thank you for purchasing this advanced Car Camcorder. This product is specifically designed for real time video recording when driving. It also supports a HP rear camera. You might ask distributor for further information.

## 1.1 Features

- Full HD 1920\*1080
- 2.4" TFT-LCD color screen
- 150° Wide angle lens
- Collision Detection, when a collision is detected, the camcorder will automatically trigger the emergency recording
- Parking Mode
- Multifunction traffic safety reminder

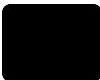
## 1.2 Package Contents







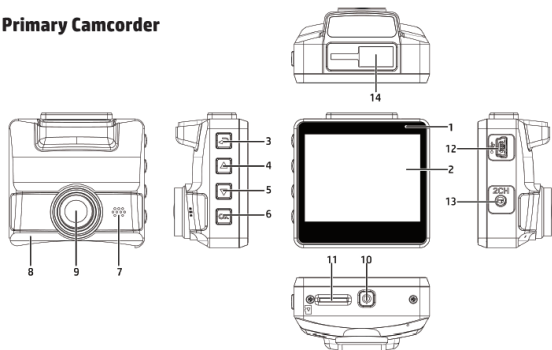

The package contains the following items. In case there is any missing or damaged item, contact your dealer immediately.

Car camcorder	Electrostatic sticker	CD-ROM
		
Quick start guide	Car charger	Rear Camera (option)
		

## 1.3 Product Overview

### Primary Camcorder



NO.	Item	NO.	Item
1	LED Indicator	8	Microphone
2	LCD Color Screen	9	Wide Angle Lens
3	Menu / Back Button (  /  )	10	Power / Switch Camera Button
4	Add Speed Point / Up Button (  /  )	11	Memory Card Slot
5	Snapshot / Down Button (  /  )	12	Power Connector Port
6	Emergency Recording / Confirm Button (  /  )	13	Rear camera connector port
7	Speaker	14	Bracket Socket

**Note:**

Please press the button (3-7) according to the diagram notice shown on screen.

## 2 Getting Started

### 2.1 Storage Media

#### 2.1.1 Insert the Memory Card

Insert memory card with the pins facing forward and the screen of the camcorder facing forward too, see the picture as below:

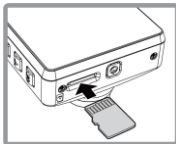

#### 2.1.2 Remove the Memory Card

If the camcorder is power on, please power off first and wait for the procedure of switching off the camcorder completed before removing the memory card.

Note:

1. Do not remove or insert the memory card when the camcorder is turned on. This may damage the memory card.
2. Support SDHC class 10 and memory storage 8GB or above (support up to 32GB).
3. Please format the micro SD cards before the initial use. The formatted file type for this camcorder is FAT32 file.
4. Periodically format the microSD card (recommended period: once a month).

## 2.2 Installing in Vehicles

### 2.2.1 Mount to Windshield

1. Put the electrostatic sticker onto the suggested area on the windshield. Before putting the sticker, please wipe and clean the windshield. During the installation, please make sure the bubbles in between the sticker and the window are all gone.

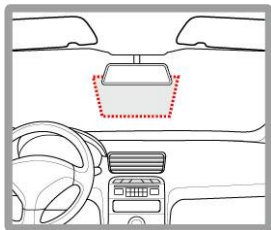

2. Peel off the protective plastic sheet from the adhesive pad.

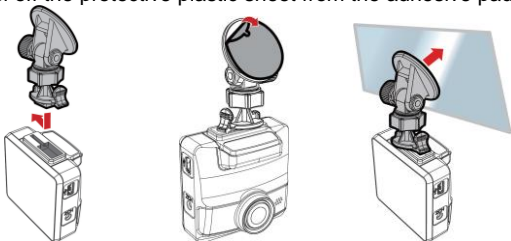

3. Place and press the bracket firmly onto the electrostatic sticker on the windshield window. Make sure the base is securely locked in place.

## **2.2.2 Adjust the Camcorder**

1. Loosen the knob to swivel the camcorder to adjust view angle.
2. Then tighten the knob to make sure the camcorder is securely locked in place.

## 2.3 Connecting to Power

Use only the supplied car charger to power up the camcorder.

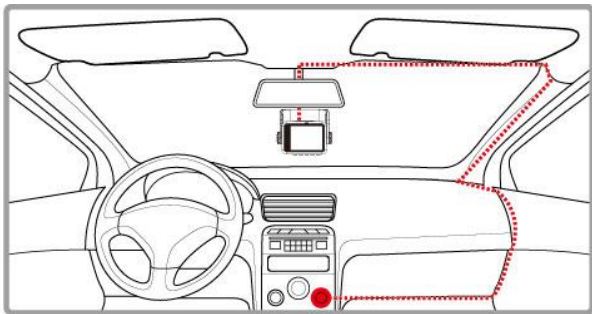

1. Connect one end of the car charger to the USB connector of the camcorder. USB port input: DC 5V / 1A.
2. Plug the other end of the car charger to the cigarette lighter socket of your vehicle. Once the vehicle engine is started, the camcorder automatically powers on. Car charger input: DC 12 / 24V.

## 2.4 LED Indicator

Status Explanation	LED Indicator Color
Power off, connect external power	Red
Power on, standby	Green
Recording/ Recording and screen off	Flash red





## 2.5 Powering the Camcorder On / Off

### 2.5.1 Auto Power On/Off

Start the car engine, wait a few seconds to charge the camcorder, and then screen will light up and the camcorder will automatically power on and start recording.

Once the vehicle engine shuts down, the camcorder automatically saves the recording and turns off the power.

### 2.5.2 Manual Power On/Off

To manually turn on the power, press the **POWER** button.

To turn off, press and hold the **POWER** button for at least 2 seconds.

### 2.5.3 Reset

Press and hold the Power button for 8 seconds to reset the device.

## 2.6 Initial Settings









Before using the camcorder, we recommend you setup the correct **Time zone, Date and Time.**

Note:

Please note that if you press the  button during recording, the system will stop recording and enter OSD menu. Make sure the recording is already stopped then continue operating the menu.

### 2.6.1 Set Time Zone

To set the time zone, do the following:

1. Press the  button to enter the OSD menu.
2. Press the  or  button to select **Set Time Zone**, and then press the  button for entering function menu.
3. Press the  or  button to set the current time zone, and then press the  button to complete setting.
4. Press the  button to return to recording screen.







City	UTC	City	UTC	City	UTC	City	UTC	City	UTC
Accra	0	Budapest *	+1	Houston *	-6	Melbourne	+10	Santiago	-4
Addis Ababa	+3	Buenos Aires	-3	Indianapolis *	-5	Mexico City *	-6	Santo Domingo	-4
Adelaide **	+9	Cairo	+2	Islamabad	+5	Miami *	-5	São Paulo	-3
Algiers	+1	Calgary *	-7	Istanbul *	+2	Minneapolis *	-6	Seattle *	-8
Almaty	+6	Canberra	+10	Jakarta	+7	Minsk	+3	Seoul	+9
Amman *	+2	Cape Town	+2	Jerusalem *	+2	Montevideo	-3	Shanghai	+8
Amsterdam *	+1	Caracas **	-4	Johannesburg	+2	Montreal *	-5	Singapore	+8
Anadyr	+12	Casablanca *	0	Kabul **	+4	Moscow	+4	Sofia *	+2
Anchorage *	-9	Chicago *	-6	Karachi	+5	Mumbai **	+5	St. John's **	-3
Ankara *	+2	Columbus *	-5	Kathmandu **	+5	Nairobi	+3	Stockholm *	+1
Antananarivo	+3	Copenhagen *	+1	Khartoum	+3	Nassau *	-5	Suva	+12
Asuncion	-4	Dallas *	-6	Kingston	-5	New Delhi **	+5	Sydney	+10
Athens *	+2	Dar es Salaam	+3	Kinshasa	+1	New Orleans *	-6	Taipei	+8
Atlanta *	-5	Darwin **	+9	Kiritimati	+14	New York *	-5	Tallinn *	+2
Auckland	+12	Denver *	-7	Kolkata **	+5	Oslo *	+1	Tashkent	+5
Baghdad	+3	Detroit *	-5	Kuala Lumpur	+8	Ottawa *	-5	Tegucigalpa	-6
Bangalore	+5	Dhaka	+6	Kuwait City	+3	Paris *	+1	Tehran **	+3
Bangkok	+7	Doha	+3	Kyiv *	+2	Perth	+8	Tokyo	+9
Barcelona *	+1	Dubai	+4	La Paz	-4	Philadelphia *	-5	Toronto *	-5
Beijing	+8	Dublin *	0	Lagos	+1	Phoenix	-7	Vancouver *	-8
Beirut *	+2	Edmonton *	-7	Lahore	+5	Prague *	+1	Vienna *	+1
Belgrade *	+1	Frankfurt *	+1	Las Vegas *	-8	Reykjavik	0	Warsaw *	+1
Berlin *	+1	Guatemala	-6	Lima	-5	Rio de Janeiro	-3	Washington DC *	-5
Bogota	-5	Halifax *	-4	Lisbon *	0	Riyadh	+3	Winnipeg *	-6
Boston *	-5	Hanoi	+7	London *	0	Rome *	+1	Yangon **	+6
Brasilia	-3	Harare	+2	Los Angeles *	-8	Salt Lake City *	-7	Zagreb *	+1
Brisbane	+10	Havana *	-5	Madrid *	+1	San Francisco *	-8	Zürich *	+1
Brussels *	+1	Hong Kong	+8	Managua	-6	San Juan	-4		
Bucharest *	+2	Honolulu	-10	Manila	+8	San Salvador	-6		

Note:

1. If *Time Sync.* is on, camcorder clock will be calibrated via satellite clock signal based on *Set Time zone.*
2. If satellite positioning is not successful, camcorder clock will run based on user defined time.

## 2.6.2 Set the Date / Time

To set the correct date and time, do the following:

1. Press the  button to enter the OSD menu.
2. Press the  or  button to select **Date / Time**, and then press the  button for entering function menu.
3. Press the  or  button to adjust the value, and then press the  button to set the next field.
4. Repeat step 3 until the date and time setting is completed.

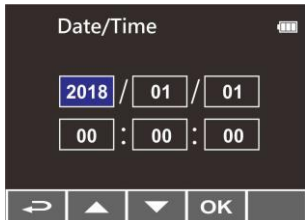

**Note:**

To ensure the accuracy of the video file time, please reset the date and time when not in use over 7 days.

## 3 Using the Car Camcorder

### 3.1 Automatic Record

Start the car engine, wait a few seconds to charge the camcorder, and then screen will light up and the camcorder will automatically power on and start recording.

Recording will automatically stop when the engine is switched off.





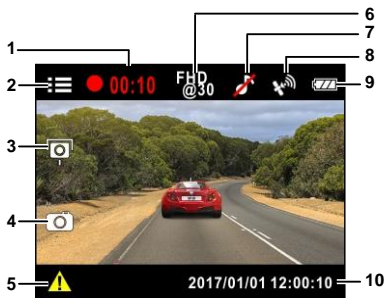

Note:

1. Some vehicle power supply would not turn on / off automatically with the car engine start, if the camcorder cannot automatically power on/off with the car engine, please manually connect the power supply with the vehicle power, and then power on, or manually power off the camcorder and then release the connector with the car power supply.
2. It can be configured to save a video file for every 30 seconds, 1 or 3 minutes of recording.
3. All the videos and photos are saved in the memory card, if memory card is full, loop recording will generally overwrite the oldest video file.
4. The camcorder is built-in super capacitor. After start the car engine, please wait a few seconds for charging the camcorder, and then the camcorder will automatically power on and start recording.

### 3.1.1 The Recording Screen



No.	Icon	Item	Description
1		Recording Duration	Indicates the video current duration.
2		Menu Button	During video recording, press the  button to enter the OSD menu ; long press 3 seconds  button to enter Function Chart.
3		Add Speed Point Button	During video recording, press the  button to add a speed cam point. Please refer to <i>錯誤! 找不到參照來源。</i> (錯誤! 找不到參照來源。).
4		PIV (Picture in Video) Button	Press  to capture video screen shots from the front camera.
5		Emergency Recording Button	During video recording, press the  button to enter emergency recording mode. Please refer to <i>錯誤! 找不到參照來源。</i> (錯誤! 找不到參照來源。).

6		Resolution icon	Indicates the video resolution.
7		Voice Record icon	Indicates voice recording sets as off, the sound will not be recorded. Please refer to <i>錯誤! 找不到參照來源。</i> (6.2).
8		Satellite Positioning icon	Indicates the strength of satellite positioning. If the  icon shows up on screen, it indicates that the camcorder cannot complete the satellite positioning.
9		Battery Power icon	Indicates battery or camcorder charging status.
10		Date / Time	Indicates the current recording date and time.

\*\*\*Press Power Key to switch between front and back images.

### 3.1.2 Emergency Recording

To Start the Emergency Recording, do the following:

1. During Video Recording, press the  button to enter emergency recording mode, the "**Emergency**" message will be shown immediately on the upper left corner of the screen, and the recorded file will be protected.
2. The emergency video recording length is same as the recording interval setting. When the emergency recording length reaches the setting, the system will return to the general recording mode.



Note:

1. If the *Collision Detection* function is enabled and a collision is detected, the camcorder will automatically trigger the emergency recording.
2. The emergency file is created as a new file and saved in Emergency folder, which will be protected to avoid being overwritten by normal loop recording. The Emergency folder will occupy 40% of available memory card capacity. For example, if you use 8GB memory card, about 3.2GB memory space will be saved for emergency files. When the Emergency folder is full, the oldest emergency file will be automatically deleted by the newest emergency file.

## 3.2 Add Speed Point

You may customize speed cam positions in this product.



1. When the GPS positioning is completed , press  to update speed camera points.
2. This product features a capacity of 50 speed cam positions. In case you are trying to add more than that, the system prompts with message "**Speed Position is full**".

Note:

You may delete custom speed cam positions by selecting the *Delete Last Position* or *Delete All Position* option from the *Speed Position Management* menu. Please note that all of your existing speed cam positions are deleted once the *Delete All Position* option is selected. Make sure you are ready to recreate your custom speed cam positions before running this option.

### 3.3 Picture in Video

You can also use this camcorder to take snapshots of the current scene.

1. In recording status, press  to capture recording screen shots from the front (and rear) lens.
2. When the icon  shows in the central of screen, it means the screenshots is completed.

Note:

1. The screen shots image resolution quality is depending on the video resolution setting.
2. The picture resolution is limited by the speed of the target object and changes in ambient lighting. The photograph function is better used for taking still pictures in accident scenes or when the car is stopped to wait for a traffic light.

### 3.4 Driving Safety

**The following driving safety function is for reference only. Drivers are advised to exercise discretion based on actual road conditions.**

Note:

1. The *Driving Safety* function is limited to triggering no more than two alarms at the same time. If a voice and alert message have been triggered, any other alarm will be ignored until either of the two is settled.
2. Satellite positioning must be completed before functions such as *Speed Cam Alert*, *Speed Position Management*, *Speed Limit Alert*, *LDWS*, *FCWS* and *FCMD* to be enabled. Be sure to check that Satellite positioning has been completed prior to using the product.
3. The detections of *LDWS*, *FCWS* and *FCMD* may be inaccurate when used in rain, at night or in environments of insufficient lighting. Drivers are advised to exercise discretion based on actual road conditions.









### 3.4.1 Speed Cam Alert

If the **Speed Cam Alert** function is enabled, once your car's location is determined by GPS and approaches a speed cam, this product produces audible alert and screen message.

To enable the Speed Cam Alert, do the following:



1. Press the  button to enter the OSD menu.
2. Press the  button to select **Speed Cam Alert**, and then press the  button for entering function menu.
3. Press the  button to select **On**, and then press the  button to enable the function.
4. Press the  button to return recording screen.
5. The alarm screen turns red to remind you to slow down if you are driving faster than the speed limit.

Note:







The speed cam alert function must have the speed cam datum from the country you use. The function will be void if the product is used in any other countries. Please consult with the shop you purchased if the function is void. There is no guarantee the speed cam datum will be included for the worldwide countries.

### 3.4.2 Speed Limit Alert

If the **Speed Limit Alert** function is enabled, this product produces audible alert and screen message once your car's location is determined by GPS and its running speed exceeds the set limit.







To set the Speed Limit Alert, do the following:



1. Press the  button to enter the OSD menu.
2. Press the  button to select **Speed Limit Alert**, and then press the  button for entering function menu.
3. Press the  button to set up a Speed Limit Alert to trigger this product's alarm [Off / 50 ~ 200 km/h (30~125 mph)], and then press the  button to complete setting.
4. Press the  button to return recording screen.
5. The screen pops up red icon to remind you to slow down when you are driving faster than the set speed limit.

### 3.4.3 Driver Fatigue Alert

If the **Driver Fatigue Alert** function is enabled, this product produces audible alert and screen message one hour after it has begun recording and repeats the alerts every half hour afterwards. To enable the Driver Fatigue Alert, do the following:





1. Press the  button to enter the OSD menu.
2. Press the  button to select **Driver Fatigue Alert**, and then press the  button for entering function menu.
3. Press the  button to select **On**, and then press the  button to enable the function.
4. Press the  button return to recording screen.
5. This product produces audible alert and screen message when **Driver Fatigue Alert** activates.





### 3.4.4 LDWS

Once your car's location is determined by GPS and the **LDWS** function is enabled, this camcorder produces audible alert and screen message when you drive off of or change lanes at speeds over 70 km/h (43 mph).

To set the LDWS (Lane Departure Warning Systems), do the following:

1. Press the  button to enter the OSD menu.
2. Press the  button to select **LDWS**, and then press the  button for entering function menu.
3. Press the  button to select **On**, and then press the  button to enable the function.

4. Press the  button to return to recording screen.
5. After enabling **LDWS**, the screen will display traffic lane align icon , please adjust the camcorder so that the horizontal line and the eye level are overlapped and the slash lines are centered in the driving lane.

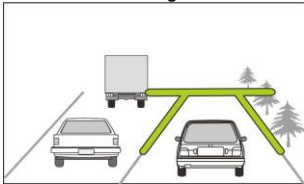

6. This product produces audible alert and screen message when **LDWS** is activates.









**Note:**

1. Please measure front windshield viewing area, do not block the driver's forward field of vision, and install the camcorder below rearview mirror (upper central of the front windshield). We recommend that the sky and the ground occupied 50 % of the video screen, install the bracket then adjust the camcorder to make the lane is aligned to the lane alignment icon. Correct installation makes the camcorder to maximize the efficiency and improve the accuracy of LDWS.
2. Make sure that traffic lane align icon will not be obscured other things (e.g. hood). It may cause misjudgment if the endpoint is obscured.

### 3.4.5 FCWS

Once your car's location is determined by GPS and the **FCWS** function is enabled, this camcorder produces audible alert and screen message when you drive at speeds over 60 km/h (37 mph) and are less than 20 m away from the car in front of you. If the camcorder not completes the satellite positioning, and the leading vehicle distance below 20 meters, it will also produce a warning screen and beep reminder.

To set the FCWS (Forward Collision Warning System), do the following:







1. Press the  button to enter the OSD menu.
2. Press the  button to select **FCWS**, and then press the  button for entering function menu.
3. Press the  button to select **On**, and then press the  button to enable the function.
4. Press the  button to return recording screen.
5. This product produces audible alert and screen message when **FCWS** is activates.



### 3.4.6 Headlight Warning

The **Headlight Warning** function produces audible alert and screen message when it detects poor lighting conditions through the recording displays of this camcorder, including driving in rainy or cloudy weather, at night, and in basements, parking lots, and tunnels.

To enable the Headlight Warning, do the following:







1. Press the  button to enter the OSD menu.
2. Press the  button to select **Headlight Warning**, and then press the  button for entering function menu.
3. Press the  button to select **On**, and then press the  button to enable the function.
4. Press the  button to return recording screen.
5. This product produces audible alert and screen message when **Headlight Warning** activates.



### 3.4.7 FCMD

If FCMD function is enabled, when the front car moves and you don't start to drive forward, the camcorder will issue audible alert and screen message.

To set the FCMD (Front Car Move Detection), do the following:

1. Press the  button to enter the OSD menu.
2. Press the  button to select **FCMD**, and then press the  button for entering function menu.
3. Press the  button to select **On**, and then press the  button to enable the function.
4. Press the  button to return recording screen.
5. This product produces audible alert and screen message when **FCMD** activates.









**Note:**

The camcorder will detect the front image change to determine FCMD notification alert, so if the car is in rest condition and front object moves, the camcorder may occur false judgment, and please judge it according to the actual driving situation.

## 3.5 Parking Mode

To monitor the vehicle when it is parked, you can activate **Park Recording**, or **Motion and Collision Detection**, or **Timelapse**. **Before you activate Parking Mode, please install ACC cable through professional car service shop.**

Follow the steps below to change the settings for Parking Mode:

1. Press the  button to enter the OSD menu.
2. Press the  button to select **Parking Mode**, and then press the  button for entering function menu.
3. Press the  button to configure Parking Mode (Park Recording / Motion and Collision Detection / Timelapse/ Off), and then press the  button to complete setting.
4. Press the  button to return recording screen.

Note: ACC cable is not included in the package. Please ask for more information from your distributor.

### 3.5.1 Park Recording

- In normal recording, press and hold **POWER** key for 3 seconds, the screen will show message "**Press OK key to power off or enter Park Recording after 10 sec.**" Please wait for 10 seconds and the camcorder will enter Park Recording automatically. The camcorder will turn off the screen temporarily, but still in recording status. Once the collision or vibration is detected, it will automatically trigger emergency recording.
- To disable this function, press any key to wake up the screen, and press again any key to resume to normal loop recording.

Note:

1. The video file taken in this mode is same as normal loop recording mode. It will be saved in the "Video" folder. And the emergency file will be saved in the "Emergency" folder.
2. The file size is according to Record Interval setting.



### 3.5.2 Motion and Collision Detection

- In normal loop recording mode, press and hold **POWER** key for 3 seconds, the screen will show message "**Press OK to power off or enter Motion and Collision Detection after 10 sec.**" Please wait for 10 seconds and the camcorder will enter Motion and Collision Detection automatically. The camcorder will turn off the screen temporarily, but still in standby detection status. When the camcorder detects any motion in front of lens or any vibration/collision, the video recording will be triggered and the event will be recorded.
- To disable this function, press any key to wake up the screen, and press again any key to resume to normal loop recording.

Note:

1. The video file taken in this mode will be saved in the "Emergency" folder.
2. In this mode, the event will be recorded for 10 seconds (per file). If the event lasts more than 10 seconds, the camcorder will keep recording up to 2 minutes.

### 3.5.3 Timelapse







- In normal loop recording mode, press and hold **POWER** key for 3 seconds, the screen will show message "**Press OK to power off or enter Timelapse after 10 sec.**" . Please wait for 10 seconds and the camcorder will enter Timelapse automatically. The camcorder will turn off the screen temporarily, but in timelapse recording status.
- To disable this function, press any key to wake up the screen, and press again any key to resume to normal loop recording.

Note:













1. The video file taken in this mode will be saved in the "Video" folder.
2. In this mode, the camcorder is continuously recording by one second one frame. For example, 30 minutes recording will be saved in one minute.
3. The file size is according to Record Interval setting.

## 3.6 Collision Detection

If the **Collision Detection** function is enabled, this camcorder begins emergency recording once it detects any collision. Sensitivity of the Collision Detection function is set to Normal by default, if user wants to change the settings of Collision Detection, do the following:

1. Press the  button to enter the OSD menu.
2. Press the  button to select **Collision Detection**, and then press the  button for entering function menu.
3. Press the  button to change the sensitivity of this camcorder's collision detection (High Sensitivity / Normal Sensitivity / Low Sensitivity / Off), and then press the  button for entering function menu.
4. Press the  button return to recording screen.

## 3.7 Playback Videos and Photos

1. If recording is in progress, press the  /  button to stop recording and enter Menu.
2. Press the  or  button to select **Playback** and press the  button.
3. Press the  or  button to select **Video**, **Emergency** or **Picture** category and press the  button.
4. Use the  or  to select the video or photo you want to playback, and press  button to confirm your selection. Or, press  to switch recorded files by front or rear camera.

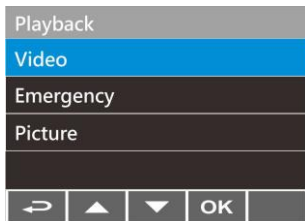

## 3.8 The Playback Screen



No.	Icon	Item	Description
1		Return	Press the  button to return preview screen of video or picture. Press the  button repetitively to return recording screen.
2		Fast Forward / Fast Rewind icon	Indicates video fast-forward and rewind status.
3		Fast Rewind / Previous File Button	When playing videos, press the  button will reverse the playback. Press  button to view previous file.
4		Fast Forward / Next File Button	When playing videos, press the  button to fast forward playing of video. Press  button to view next file.
5	FILE0001.MOV	File name	Indicates the file name of video / picture.
6		Playback/ Pause button	Press the  button to play or pause the video.
7		Battery icon	Indicates Battery or charging status.
8	00:10 / 01:00	Playback Duration /	Indicates video playback time and total duration.

No.	Icon	Item	Description
		Total Duration	
9		Serial Number	Shows the current file serial number and total file number.
10		Previous File	When viewing pictures, press the  button will switch over to the previous file.
11		Next File	When viewing pictures, press the  button will switch over to the next file.
12		Date and time	Date and time of photo taking.



\*\*\*Press Power Key to switch between front and back images.

### 3.9 Deleting Files

To delete file(s), perform the following steps:

1. Press the button to stop recording and enter the main Menu.
2. Press the or button to select **File Deletion** and press the button to confirm.
3. Press the or button to select folder and press the button to confirm. The following options will display in screen,

Item	Description
Delete One	Delete the current selected file.
Delete All	Deletes all files in this folder.

4. Use the  or  to select the video or photo you want to delete, and press  button to confirm your selection.

**Note:**

1. Deleted files **CANNOT** be recovered. Ensure the files you wish to preserve are backup before deletion.
2. If the file is taken by front camera and rear camera at the same time, no matter you delete video or picture from Front camera folder or Rear camera folder, both front camera file and rear camera file will be deleted.

## 4 Initial set up Go Dashcam application

### 4.1 Camcorder application installation

The camcorder allows you to connect to the mobile devices via the App. When using for the first time, install the [**Go Dashcam**] App for your mobile device.

1. Download **Go Dashcam** App  from Google Play or App Store.
2. Install the App.

**APP layout and features may be changed subject to different software versions. Please refer to Google Play or APP Store for update.**

## 4.2 Wi-Fi connecting

1. Press the **Power** button to switch on the camcorder.
2. Enter Menu and go to **Wi-Fi** option; choose “ON” to activate the wireless network.
3. The camcorder’s screen will display Wi-Fi Device ID and Password. Using the Wi-Fi function of your mobile device, search for the camcorder ID “hp\_f560x\_123456” from the list (last 6 numbers are system random numbers). Enter default password **12345678**.



4. There is a Wi-Fi icon on the camcorder’s screen. Once the icon is blue, your connection has been successfully established.



**Note:**

1. The mobile device shall be within a maximum of a 5m distance from the camcorder without any buildings in between.
2. When the Wi-Fi function of the camcorder is ON but not yet connecting with your mobile device, or the connection is disconnected, the Wi-Fi icon on camcorder’s screen will be white, and you will need to re-activate the Wi-Fi and re-pair with your mobile device.



3. After connecting the mobile device with the camcorder, and activate app feature "Camera Preview", all the button operation of the camcorder will be disable; all the operations shall be carried out via the Go Dashcam App.
4. The language of the Go Dashcam App will be consistent with your mobile device, beyond the language options, the App will be activated with default language.

## 5 Using the Go Dashcam application



Touch [Go Dashcam] icon to activate the application. The main screen will pop up. Follow the below instruction to operate this application.

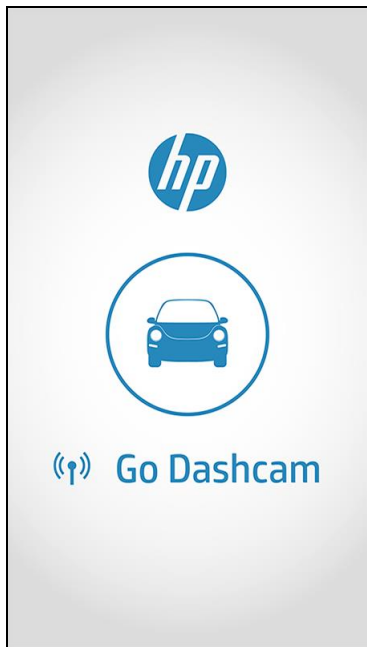



## 5.1 Camera preview, record, snapshot

You can use this feature to preview, record or take snapshot.



1. The mobile device will display camcorder's preview screen. The camcorder will lose control and screen will show "Network Streaming". Please use Go Dashcam app to operate the camcorder.



	icon	Description
1		Start/stop recording
2		Snapshot (no matter in front camcorder or rear camcorder preview, once you touch this icon, both of front and rear camcorder will take photo.)
3		Switch front and rear camcorder preview

## 5.2 Playback, delete, download

You can use this feature to playback or delete the file saved in camcorder, or to download the file from camcorder to your mobile device.

1. Touch the icon  [Video playback] or  [Picture playback].
2. The files saved in the camcorder will be displayed on your mobile device. Camcorder will stop recording for a few seconds until your mobile device finishes reading the saved files from camcorder, and screen will show "Network Playback".
3. Touch the preview image of video or picture to playback.
4. Touch the right top corner "Select" and pick up the files that you want to delete or download, and touch below icon to execute.

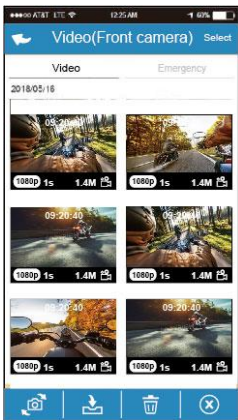

	Icon	Description
1		Switch front and rear camcorder
2		Download the file from camcorder to your mobile device
3		Delete
4		Exit

**Note:**

1. If you find the video playback without audio, please check if you turn on Voice Record on the menu. If you do turn it on, it means the mobile device itself doesn't support the video decoding. It's not the problem of the file. We recommend you to install a free app software such as VLC to playback the file.
2. Deleted files cannot be recovered. Ensure the files have been backed-up before deletion.
3. Picture and video files could be downloaded to the internal memory of your mobile device. Use the application program in your mobile device to view the file.
4. The downloaded videos or pictures will be saved in the album of your mobile device, at the mean time it will create a new folder "Go Dashcam". You can preview the files from the album.

## 5.3 Local album

You can use this feature to playback or delete the file that you download to your mobile device.



1. Touch icon [Local Album] ◦
2. Pick up the file that you want to playback.
3. The downloaded videos or pictures will be saved in the album of your mobile device, at the mean time it will create a new folder "Go Dashcam". You can preview or delete the files from the album.

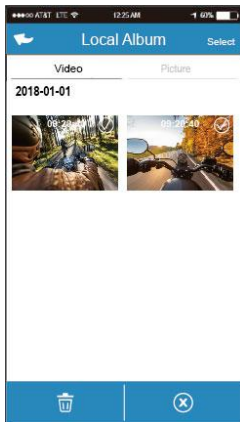

### Note:

1. Deleted files cannot be recovered. Ensure the files have been backed-up before deletion.
2. If you find the downloaded files could not be played or without audio, which means the mobile device itself does not support the video decoding. It's not the problem of the file. We recommend you to install a free App software such as VLC to playback the file.

## 5.4 Camera Setting

You can use this feature to set up your car camcorder.



1. Touch icon [Camera Setting].
2. Refer to the below table for details of menu items and available menu options.







Menu option	Description	Available option
Resolution	Set the desired video resolution.	1080p 30fps HDR 1080p 27.5fps HDR 720p 30fps HDR 720p 27.5fps HDR
Record Interval	Save respective video files in a length of the selected duration.	30 sec / 1 min / 3 min
Voice Record	Setting for activating audio in the video.	On / Off
Time Stamp	If the time stamp is enabled, recording files or photos will show the date and time.	On / Off
Default	Return to factory default setting.	Yes / No
Format	To format the memory card, all the files in the camcorder will be deleted.	Yes / No
WiFi Setting	To set up Wi-Fi password	
Firmware Version	Indicates the current car camcorder's firmware version.	
App Version	Indicates the current application version.	



## 6 Adjusting the Settings

### 6.1 Using the Menu





You can customize the general settings via the on-screen display (OSD) menus.

1. Press the  button to enter the OSD menu.
2. Press the  button to select menu item, and then press the  button for entering function menu.
3. Press the  button to select or adjust the value, and then press the  button to confirm setting.
4. Press the  button to return recording screen.

### 6.2 Menu Items

Refer to the below table for details of main menu and function list.

Menu option	Description	Available option
Playback	Select the file category that you want to view.	Video Emergency Picture
Wi-Fi	Set up Wi-Fi linkage of a mobile phone.	On / Off
Satellite Status	Displays the current state of the satellite reception.	
Satellite Synchronization	If the satellite time is enabled, the car camcorder clock will synchronize according to the satellite time zone you set. When you turn on this feature, it will display the satellite time preferentially, and cannot be manually changed.	On / Off
Speed Unit	The system displays the speed setting unit.	KM/H / MPH

Menu option	Description	Available option
Speed Cam Alert	If the Speed Cam Alert function is enabled, once your car's location is determined by GPS and approaches a speed cam, this product produces audible alert and screen message.	On / Off
Speed Position Management	<b>Add Speed Point:</b> The satellite positioning will manually add speed camera location. You can add up to 50 speed camera locations to the built-in system. <b>Delete Last Position:</b> Delete the last speed camera point. <b>Delete All Position:</b> Delete all speed camera point.	Add Speed Point / Delete Last Position / Delete All Position
Speed Limit Alert	Set a customized maximum speed limit. When the vehicle speed exceeds the maximum, an audible alert is automatically triggered and a warning message is displayed on the screen.	Press the  button to set the speed limit. You can set the off, or set speed limit from 50 to 200km/h (30 to 125mph)
Set Time Zone	Set the time zone you are in.	Press the  button to set the satellite time. You may customize it between GMT -12:00 ~ GMT +14:00
Date / Time	Set the date and time.	Press the  button to adjust the value, and then press the  button to set the next field, and complete setting
Language	Language setting.	According to the actual shipping regions.
Time Stamp	If the time stamp is enabled, recording files or photos will show the date and time.	On / Off

Menu option	Description	Available option
Resolution	Setting of video resolution.	1920x1080 30fps HDR 1920x1080 27.5fps HDR 1280x720 30fps HDR 1280x720 27.5fps HDR
EV	Setting of exposure value.	Press the $\triangle/\nabla$ button to set the exposure value. It can be set between -2 ~ +2
LCD Setting	Set LCD off time. Camcorder screen will be off after a set time if no operation is detected during the standby or record mode. Press any button will switch it on. (Recording is not affected when screen is off).	On/ Turn off after 7 sec / Turn off after 1min/ Turn off after 3min
Voice Record	Setting for activating audio in the video.	On / Off
Key Tone	Enable / disable power-on sound and key tone.	On / Off
Volume	Adjust the sound volume.	Press the $\triangle/\nabla$ button to set the volume. It can be set between 0 ~ 10.
Record Interval	Save respective video files in a length of the selected duration.	30 sec. / 1 min. / 3 min.
Parking Mode	If one of parking mode is activated, the camcorder will enter parking mode 10 seconds after disconnect the external power.	Off/ Park Recording / Motion and Collision Detection / Timelapse
Collision Detection	If Collision Detection is activated, this camcorder starts emergency recording once it detects any collision.	High Sensitivity / Normal Sensitivity / Low Sensitivity / Off
Driver Fatigue Alert	When Driver Fatigue Alert is enabled, audible alert and screen message will be activated 1 hour after the camcorder is powered on, with a repetition every 30 minutes.	On / Off

Menu option	Description	Available option
Headlight Warning	When Headlight Warning is activated, camcorder will issue an audible alert and screen message reminding that insufficient brightness is sensed on the recording face.	On / Off
LDWS	Once your car's location is determined by GPS and the LDWS function is enabled, this camcorder produces audible alert and screen message when you drive off of or change lanes at speeds over 70 km/h (43 mph).	On / Off
FCWS	When FCWS is activated after satellite positioning, camcorder will issue audible alert and screen message when vehicle speed is above 60 km/h (37 mph) and the distance with the front vehicle is less than 20m.	On / Off
FCMD	If FCMD function is enabled, when the front car moves and you don't start to drive forward, the camcorder will issue audible alert and screen message.	On / Off
File Deletion	Delete the file(s).	Video Emergency Picture
Anti-flicker	Domestic power supply varies by area. It is recommended that you should check the "Table of voltage and frequency of different countries" for the correct setting.	60Hz / 50Hz

Menu option	Description	Available option
Format	Format the memory card inserted in the equipment. All the files in the card will be erased.	Yes / No
Default	The system reverts to the default setting.	Yes / No
Firmware Version	Indicates the current firmware version.	

## 7 Installing the Software

1. Place the attached CD ROM into the CD player.
2. If the CD does not execute automatically, please use Windows File Manager to execute the Install\_CD.exe file in the CD.

The following screen will be shown up.

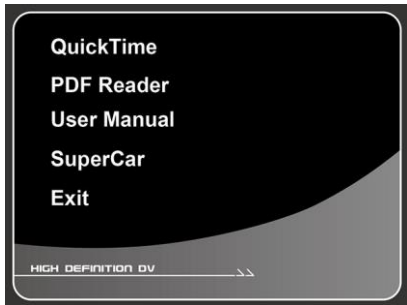

3. Press the [Menu] item to start the installation process according to the instructions on-screen.

## 8 SuperCar



No.	Item
1	Front Camera Playback
2	Play / Pause
3	Previous
4	Next
5	Stop
6	Electronic Map
7	Compass
8	Speed Meter

No.	Item
9	File Path
10	Browser File
11	File List
12	Rear Camera Playback
13	Volume
14	Playback Duration / Total Duration
15	G-Sensor

### Note:

1. To display the route on Electronic Map, please make sure the internet is connected before starting the video playback.
2. Video files of front-view camera (MOV) and GPS/G-Sensor files (NMEA) must be stored in the same folder before starting the playback.
3. The SuperCar software is only applicable to Windows operating system.

## 9 Specifications

Item	Description
Image sensor	1/2.8" CMOS sensor
Effective pixels	1920 (H) x 1080 (V)
Storage media	Supports Micro SDHC, up to 32GB class 10 speed or greater
LCD display	2.31" LCD color TFT
Lens	Wide Angle Fixed Focus lens Aperture: Up to F1.8
Focus range	1.5m~Infinity
<b>Satellite System</b>	<b>GPS ( frequency:1575.42MHz)</b>
Video	Resolution: 1080P/ 30 fps · 1080P/ 27.5 fps · 720P/ 30 fps · 720P/27.5 fps
	Format: MOV
Still image (Photograph)	Resolution: depends on video resolution setting
	Format: DCF (JPG)
Shutter	Electronic shutter
G-Sensor	3-Axis G-Force sensor
ISO	Auto
White Balance	Auto
Microphone	Built-in
Speaker	Built-in
Interface	Mini USB



Item	Description
Power	Super Capacitor
Operating Temperature	0° ~ 45° C
Operating Humidity	20 ~ 70% RH
Storage Temperature	-20° ~ 70° C
Dimensions	56.5 x 30 x 58 mm
Weight	Approx. 74g

Built-in IEEE 802.11g/n(HT20) Wi-Fi chip: RTL8188FTV

Frequency range	2412~2472MHz (for EU)
Wi-Fi Channel	Ch1~Ch13 (for EU)
Wi-Fi Max. output	11.29dBm EIRP (for EU)