

DISTRIBUTED BY



madisonAV



JBL

PROFESSIONAL

by **HARMAN**

Loudspeakers & Commercial Audio Products.



innovate / distribute / support

Innovate.

MadisonAV is an Australian owned and operated business that innovates, distributes and supports a range of high-quality AV product solutions from globally recognised brands.

We bring together detailed knowledge of AV industry best practice and innovative products from global technology partners.

Our experience supporting AV and broadcast solutions across key market sectors is underpinned by 30 years of insights and customer understanding.



Support.

Our team is dedicated to finding the best possible solution for every project.

Our dedicated team provide a successful formula for delivering innovation, agility and practicality for any complex AV project challenges.

From specification assistance, design support, or post sale technical support, our team is right behind you.

Distribute.

Connecting you to world-leading brands.

We efficiently connect customers with leading, state of the art solutions through our sales, warehouse and distribution networks across Australia and New Zealand.

Our heavy investment in stock ensures we have what you need, when you need it.

Contents

JBL Professional Innovation.....	4
Ceiling Speakers.....	8
Surface Mount Speakers.....	16
Pendant Speakers.....	23
Column Speakers.....	28
Point Source Speakers.....	36
Line Array Speakers.....	51
Portable PA Speakers.....	56
Studio Monitors.....	64
Commercial Series.....	65
Training.....	73
Software Tools.....	74



Contact Us.

For more information on the range of JBL Professional Loudspeakers and Commercial Audio products for your next project visit us at www.madisonav.com.au or call on 1800 00 77 80.

About JBL.



Power and versatility is only the beginning.

When it comes to the listening experience, JBL never ceases to push the boundaries. From its inception 75 years ago, the brand has grown to become synonymous with epic sound, revolutionising the way we listen. And while the enjoyment is instinctive, the science behind each and every innovation is precise and methodical. Passionate and gifted engineers and designers around the world devote themselves to developing JBL products and solutions that take listening to the next level - and they've been doing it since day one.



Today, JBL professional solutions encompass recording studios, movie theatres, tour sound, installed sound, arenas and stadiums, and much more. At the heart of each of these solutions is a meticulous attention to detail, a willingness to develop everything from the ground up, and an absolute dedication to giving artists outstanding sound, whether they're performing at a major music festival or busking on a street corner. And the technologies that JBL develops for its professional audience benefit all of JBL's listeners as they are distilled into smaller form factors, allowing people everywhere to enjoy professional quality sound at a convenient size and an affordable price.



Over the decades, JBL has contributed a remarkable number of industry firsts and technical innovations that further cemented its reputation as an audio pioneer, garnering Grammy® awards, Academy awards, and widespread recognition from the world's most celebrated musicians and consumers along the way.



Expertly blending a bold vision of the future with the passion and talent of its engineers and designers, JBL develops its own solutions, invents its own technologies, and creates its own tools with a pioneering spirit that has defined the brand for the past 75 years. Today, JBL is present in more than 130 countries, encompasses an increasingly diverse range of next-level products and solutions, and has over 300 patents to its name, such as VGC™ transducer technology, Slip Stream™ low frequency port, Progressive Transition™ (PT) waveguides, and Plus One™ woofer cone technology.



Thanks to a truly exceptional dedication to constantly delivering exactly what customers desire, JBL sound has become part of the fabric of people's lives. Whether it's cinema sound that makes the movie-going experience more immersive, soundbars that transform the living room into a concert hall, portables that let listeners enjoy their favourite tunes wherever they go, gaming headsets that make players swear they've just stepped into the game, or in-car audio technology that turns the daily commute into a moment of pure listening pleasure, JBL fills listeners' lives with sound as it was meant to be heard.

A Journey of Engineering Excellence.



Audio technology is at the core of everything JBL does. For 75 years they have employed the best methodology and tools, developing everything from the ground up, guaranteeing their efforts exceed the needs and expectations of audio professionals throughout the world. Never straying from this exacting formula, this journey has produced a prolific list of audio achievements, groundbreaking technologies, revolutionary advances in the art and science of professional audio, many patents, and many awards. It's a journey that is legendary worldwide and has positioned JBL as the world leader in professional audio. Not just as a brand, but as a company known for consistently blending creativity and science as a manifestation of their passion for sound and commitment to those who create it.



Transducers.

The technology of transducers is truly the starting place for the entire JBL engineering legacy. Building on founder James B. Lansing's historic foundation, JBL engineers continue to break ground on new and better ways to design transducers, reaching beyond what is commonly understood as possible and consistently setting new performance benchmarks for the audio industry. Starting from scratch and often developing patents in the process, has resulted in technologies such as Differential Drive woofers, CMCD Cone Midrange drivers, and the D2 Dual Voice Coil Compression Driver, that cover the entire practical bandwidth of professional audio devices. Simultaneously addressing performance-robbing challenges such as power compression, heat dissipation, distortion, component weight, and physical footprint, JBL has created a range of transducers that are unparalleled in their ability to deliver extraordinary performance throughout a wide range of applications.



DIFFERENTIAL DRIVE®

JBL's exclusive dual voice coil, dual magnetic gap Differential Drive technology reduces weight while enhancing all critical performance parameters including better heat dissipation, lower power compression and higher dynamic range versus conventional single-coil designs.

This allows very high output with minimal power compression, resulting in deep distortion-free bass even at very high SPL. Differential Drive® technology is now at the core of a full range of woofer models incorporated in many JBL loudspeaker systems from touring sound and fixed installation, to studio and cinema sound.



FEATURING
D2
DUAL DIAPHRAGM
DUAL VOICE COIL
COMPRESSION DRIVER

D2 DUAL DIAPHRAGM DUAL VOICE COIL COMPRESSION DRIVER

The revolutionary D2 Dual Driver dramatically improves the sound and performance of high frequencies, providing an extreme output advantage over conventional systems with significantly higher array power, reduced distortion, double the number of voice coils and more than double the power handling. This results in a dramatic increase in pure high frequency sound pressure levels in the same physical footprint with a 30% reduction in weight.



Directivity.

Building better loudspeakers is only the first of many performance challenges that face all audio design engineers. Controlling the sound as it leaves the speaker enclosure is as critical to the performance of the system as the quality of the source component. The goal is always the same: create a consistent sound pattern throughout the desired vertical and horizontal plane without introducing artifacts, while ensuring the full bandwidth and SPL capability of the transducers, and providing a seamless transition from high frequency to low frequency components. JBL engineers relentlessly test new shapes and develop new materials to achieve the desired performance, often inventing new testing methodologies to ensure that nothing is left out of a thorough and rigorous examination of the design. The resulting technology has produced such groundbreaking designs as the Progressive Transition Waveguide, Image Control Waveguide, Slip Stream Port, Radiation Boundary Integrator, and Constant Curvature Waveguide. With multiple patents, and many successful installations in use worldwide, this critical component of JBL technology continues to evolve through our continuous pursuit of better, more accurate sound.



RADIATION BOUNDARY INTEGRATOR™ (RBI)

JBL's patented Radiation Boundary Integrator combines the high frequency and mid-range so the transition across each band is uninterrupted, undistorted and seamless. A patented, tuned resonant-chamber is integrated into the waveguide itself, effectively eliminating throat-related cancellations due to back pressure from the mid-range section. Our refined RBI waveguide implementation provides improved horizontal coverage - broader and more stable.



RBI™: RADIATION BOUNDARY INTEGRATOR

Testing.

All audio products have a useful life, and JBL engineers are committed to making that as long as possible, not only in terms of reliability, but also in terms of how good the sound is the very first time a system is turned on. Every JBL Professional product undergoes stringent testing above and beyond what the product would face when deployed in the real world.



JBL has multiple application specific anechoic testing chambers, and has developed the only known 'Speaker Shuffler' that allows rapid and precise re-positioning of speaker systems in the exact same space for truly accurate A/B testing. This rigorous, uncompromising adherence to testing results in continuous breakthroughs in performance and ensures that JBL users worldwide can always work with confidence.

CEILING SPEAKERS.



JBL CSS Commercial Series.

ENTRY-LEVEL BACKGROUND MUSIC AND PAGING SPEAKERS

The JBL CSS Commercial Series provides affordable performance for paging and background music applications in retail stores, restaurants, schools and other facilities.

CSS8004 100MM (4") COMMERCIAL SERIES CEILING SPEAKERS

The CSS8004 is a 100mm (4") speaker with 90dB sensitivity and a 5-Watt multi tap transformer. The speaker's triple-voltage transformer provides versatility by allowing use on 100V, 70V, or 25V distributed loudspeaker lines. Available in White.

- Transducer: 100mm
- Dispersion: 175° Conical
- Response: 85Hz-18kHz
- Sensitivity: 90dB
- Power: 15W 8Ω (5W Tx)



CSS8008 200MM (8") COMMERCIAL SERIES CEILING SPEAKERS

The CSS8008 is a 200mm (8") speaker with 96dB sensitivity and a 5-Watt multi tap transformer. The speaker's triple-voltage transformer provides versatility by allowing use on 100V, 70V, or 25V distributed loudspeaker lines. Available in White.

- Transducer: 200mm
- Dispersion: 120° Conical
- Response: 55Hz-16kHz
- Sensitivity: 96dB
- Power: 15W 8Ω (5W Tx)



CSS8018 200MM (8") COMMERCIAL SERIES CEILING SPEAKERS

The CSS8018 is a high-powered 200mm (8") speaker with 97dB sensitivity and a 10-Watt multi tap transformer. The speaker's triple-voltage transformer provides versatility by allowing use on 100V, 70V, or 25V distributed loudspeaker lines. Available in White.

- Transducer: 200mm
- Dispersion: 110° Conical
- Response: 50Hz-17kHz
- Sensitivity: 97dB
- Power: 20W 8Ω (10W Tx)



CSS15C-VA 127MM (5") CEILING LOUDSPEAKER FOR EN54-24 APPLICATIONS

A full-range, EN54-24 certified ceiling speaker consisting of a 127mm (5") full-range dual-cone driver, torsion-mounted into an included easy-install blind-mount metal fire dome. The speaker is designed to provide clear and intelligible sound for applications requiring EN54 certification and/or BS5839 compliance. Available in White.

- Transducer: 125mm
- Dispersion: 120° Conical
- Response: 180Hz-20kHz
- Sensitivity: 92dB
- Power: 6W Tx



ACCESSORIES FOR CS8004/8008/8018

MTC-BB4X6: Pre-install backcan for CSS8004. Pack of 6 pieces.

MTC-BB8x6: Pre-install backcan for CSS8008 and CSS8018. Pack of 6 pieces.

MTC-TR4/8x12: Tile rails for CSS-BB4 and CSS-BB8 backcans. Pack of 12 pieces for 6 speakers.

JBL 8100 Series.

SCULPTED GRILLE DUAL-CONE CEILING SPEAKERS

High sensitivity at a cost-effective price point, the 8100 Series is an easy to install loudspeaker solution for a wide variety of commercial sound applications. With its contemporary grille design, the 8100 Series loudspeakers are ideal for a variety of settings ranging from restaurant and retail settings to professional offices and reception areas. All models feature 6W transformer for 70V/100V distributed lines.

8124 100MM (4") FULL-RANGE, IN-CEILING LOUDSPEAKER

The 8124 is a 100mm (4"), full-range, loudspeaker, featuring a high sensitivity driver that provides 130° conical coverage in a lightweight 1.2kg package and includes dog-ears for easy blind mount installations. Available in White.

- Transducer: 100mm
- Dispersion: 130° Conical
- Response: 60Hz-18kHz
- Sensitivity: 93dB
- Power: 20W 8Ω (6W Tx)



8128 200MM (8") FULL-RANGE, IN-CEILING LOUDSPEAKER

The 8128 is a 200mm (8"), full-range loudspeaker featuring a high sensitivity driver that provides 90° conical coverage in a lightweight 1.4kg package and includes dog-ears for easy blind mount installations. Available in White.

- Transducer: 200mm
- Dispersion: 90° Conical
- Response: 50Hz-16kHz
- Sensitivity: 97dB
- Power: 25W 8Ω (6W Tx)



The 8124 and 8128 Ceiling Speakers are designed with built-in dog-ears for fast and easy installations, and are lightweight with open-back design for applications not requiring an in-ceiling backcan.

8138 200MM (8") FULL-RANGE, IN-CEILING LOUDSPEAKER

The 8138 is a 200mm (8"), full-range loudspeaker designed for use with MTC-81BB8 pre-install in-ceiling backcan, resulting in high sensitivity performance at a cost effective price point. Available in White.

- Transducer: 200mm
- Dispersion: 90° Conical
- Response: 95Hz-18kHz
- Sensitivity: 97dB
- Power: 25W 8Ω (6W Tx)



ACCESSORIES

Because of the very light weight of 8124 and 8128, tile rails may not be required for some in-ceiling applications. They are not packaged with these models, however MTC-RAIL tile rail sets and MTC-8124C and MTC-8128C C-rings are available separately.

The 8138 is designed for use with MTC-81BB8 backcan and MTC-81TB8 tile bridge.



JBL Control 10 Series.

AFFORDABLE BLIND-MOUNT CEILING SPEAKERS



Control 10 Series in-ceiling loudspeakers meet the increased market demand for superior sound quality, installation-friendly features and value, delivering a level of sonic performance unmatched by comparably priced products. They are ideal for applications where excellent sound quality is needed for medium-volume music playback and paging.

Control 10 Series models feature wide bandwidth, wide coverage, and combined 70V/100V and 8 ohm operation in each speaker. Dual conduit clamp allows separate strain reliefs for the input and loop out cables. High humidity grilles are available to suit Control 12, 14 and 16 models.



CONTROL 12C/T 76MM (3") COMPACT CEILING LOUDSPEAKER

The Control 12C/T is a high fidelity speaker with a 76mm (3") full-range driver and a wide frequency range of 68Hz to 17kHz. The short 120mm (4.7") blind-mount backcan allows for easy installation in shallow ceiling spaces. Available in Black or White.

- Transducer: 76mm
- Dispersion: 130° Conical
- Response: 95Hz-15kHz
- Sensitivity: 84dB
- Power: 20W 8Ω (15W Tx)

Also available: Control 12C-VA – EN54-24 Certified for life safety applications



CONTROL 14C/T 100MM (4") TWO-WAY COAXIAL IN-CEILING LOUDSPEAKER

The Control 14C/T contains a co-axially mounted 100mm (4") woofer and 19mm (3/4") soft dome tweeter. The liquid-cooled soft dome tweeter provides clear, pleasant sound over a wide coverage area. Blind-mount backcan for quick and easy installation. Available in Black or White.

- Transducer: 100mm+19mm
- Dispersion: 120° Conical
- Response: 74Hz-20kHz
- Sensitivity: 87dB, D, WG
- Power: 30W 8Ω (25W Tx)

Also available: Control 14C-VA – EN54-24 Certified for life safety applications





CONTROL 16C/T 165MM (6.5") TWO-WAY COAXIAL IN-CEILING LOUDSPEAKER

Control 16C/T is a full-range ceiling speaker consisting of a 165 mm (6.5") high tech cone driver and a 19mm soft-dome liquid cooled tweeter mounted in a vented, paintable baffle made of UV resistant UL94-V0 and UL94-5HB material, with a pre-attached blindmount backcan for quick and easy installation. Available in Black or White.

- Transducer: 165mm+19mm
- Dispersion: 110° Conical
- Response: 62Hz-20kHz
- Sensitivity: 91dB, D, WG
- Power: 50W 8Ω (30W Tx)



Also available: Control 16C-VA – EN54-24 Certified for life safety applications

CONTROL 18C/T 200MM (8") TWO WAY COAXIAL CEILING LOUDSPEAKER

Control 18C/T is a full-range ceiling speaker consisting of a 200 mm (8") high tech cone driver and a 25 mm soft-dome liquid cooled tweeter mounted in a vented, paintable baffle made of UV resistant UL94-V0 and UL94-5HB material, with a pre-attached blind-mount backcan for quick and easy installation. The speaker is designed to provide excellent sound quality for a wide variety of medium to high volume applications. Available in Black or White.

- Transducer: 200mm+25mm
- Dispersion: 90° Conical
- Response: 58Hz-20kHz
- Sensitivity: 92dB, D, WG
- Power: 90W 8Ω (60W Tx)



ACCESSORIES

- New Construction Brackets & Trim Rings: The Control 10 Series speaker utilises the Control 20 Series NC New Construction Brackets, MR Plaster Ring Brackets, and TR Trim Rings.
- Control 12C/T and 14C/T utilise MTC-24NC, MR & TR
- Control 16C/T utilises MTC-26NC, MR & TR
- MTC-48TRx12: Tile Rails for (4' x 4') ceiling tiles (pack of 12 rails)

High Humidity Grilles:

- MTC-14WG (White) fits Control 12C/T and 14C/T
- MTC-14WG-BK (Black) fits Control 12C/T-BK and 14C/T-BK
- MTC-16WG (White) fits Control 16C/T
- MTC-16WG-BK (Black) fits Control 16C/T-BK

JBL Control® Contractor 20 Series.

PREMIUM SMALL FORMAT CEILING SPEAKERS

JBL Control Contractor 20 Series small-format ceiling speakers provide full-range, high-fidelity sound reinforcement for background music and music-plus-paging systems. Innovative features like titanium-coated tweeters and JBL's proprietary diffraction-horn loading technology deliver extremely wide, even coverage, meaning fewer speakers are required for any installation. Models are packaged as complete assemblies including grille, backcan and tile rails, and can be installed without accessing areas above the ceiling. All speakers feature JBL's exclusive SonicGuard™ overload protection, enabling higher operational levels and improving reliability. Control Contractor 20 Series ceiling speakers are voiced similarly to other JBL Control Contractor models, allowing them to be combined with in-wall and surface-mount speakers in a single listening space.

CONTROL 24C MICRO, 24CT MICRO & 24CT MICROPLUS 115MM (4.5") BACKGROUND MUSIC CEILING LOUDSPEAKER

The Control 24C/CT Micro AND 24CT MicroPlus are compact and easy to install in-ceiling speakers providing full, high quality sound for background music and music-plus paging systems. The 24CT Micro includes a 9W multi-tap transformer and the 24CT MicroPlus includes a 25W multi-tap transformer. Available in White.

- Transducer: 115mm+12mm
- Dispersion: 150° (Asym)
- Response: 85Hz-25kHz (Control 24CT Microplus 80Hz-25kHz)
- Sensitivity: 86dB, D
- Power: 15W 8Ω C / 9W Tx CT (Control 24CT Microplus: 25W Tx)



CONTROL 24C, 24CT & 24CT-BK 100MM (4") BACKGROUND/FOREGROUND CEILING LOUDSPEAKER

The Control 24C contains a coaxially mounted 4" woofer and 3/4" titanium coated tweeter providing high fidelity sound over a wide coverage area. The 24CT provides a 70V/100V multi-tap transformer. The 24CT is available in Black (C24CT-BK).

- Transducer: 115mm+19mm
- Dispersion: 130° Conical
- Response: 80Hz-20kHz
- Sensitivity: 86dB, D, WG
- Power: 40W 16Ω C / 30W Tx CT



CONTROL 26C, 26CT & 26CT-LS 165MM (6.5") BACKGROUND MUSIC CEILING LOUDSPEAKER

The Control 26C contains a coaxially mounted 165mm (6.5") woofer and 3/4" titanium coated tweeter, able to deliver maximum sound level over a defined area. The 26CT provides a 70V/100V multi-tap transformer. The 26CT-LS is ULI480/UUMW life-safety certified. Available in White.

- Transducer: 165mm+19mm
- Dispersion: 110° Conical
- Response: 75Hz-20kHz / 80Hz-20kHz -LS
- Sensitivity: 89dB, D, WG
- Power: 75W 16Ω C / 60W Tx CT, -LS



CONTROL 26-DT 165MM (6.5") COAXIAL CEILING SPEAKER

The Control 26-DT is a compact ceiling speaker assembly configured to install into standard ceiling backcans designed for 200mm (8") drivers. Available in Black.

- Comes complete with transducer, network and transformer
- Advanced crossover network provides natural sound and even coverage throughout listening area

- Transducer: 165mm+19mm
- Dispersion: 90° Conical
- Response: 70Hz-20kHz
- Sensitivity: 89dB, D, WG
- Power: 60W Tx



CONTROL 19CS & 19CST 200MM (8") IN-CEILING SUBWOOFER

The Control 19CS uses advanced proprietary technologies to produce powerful bass from a low profile in-ceiling design. The optional 19CST has a special subwoofer band transformer for 70V/100V operation. Available in White.

- Transducer: 200mm
- Response: 42Hz-200Hz
- Sensitivity: 95dB
- Power: 100W 8Ω CS / 75W Tx CST



ACCESSORIES

- New Construction Bracket: MTC-xxNC* • Plaster Ring Bracket: MTC-xxMR*
- Trim Rings: Allow for installation into existing ceiling speaker cutouts that are larger than the speaker's normal cutout size. MTC-xxTR*
- MTC-48TRx12: Tile Rails for 4' x 4' ceiling tiles (pack of 12 rails)
- High humidity grille MTC-16WG (white) fits Control 26C and 26CT.

*These models are available in different sizes. Specify speaker model when ordering.

JBL Control® 40 Series.

EXTENDED PERFORMANCE SMALL FORMAT CEILING SPEAKERS WITH CONICAL RBI



The Control 40 Series Ceiling Speaker are designed to work perfectly in environments that require a premium, in-ceiling speaker with an extremely wide bandwidth and consistent coverage. Consisting of three 165mm (6.5") coaxial models, a 60mm (2.5") ultra-compact satellite speaker and in-ceiling subwoofer, the Control 40 Series can be configured in many different ways to accommodate a full range of applications. JBL focused on ease-of-installation by including an integrated backcan, grille and tile rails (except Control 42C), locking 2-pin connectors and two knockouts. The Control Series speakers are designed for use in air handling spaces.

CONTROL 42C

60MM (2.5") ULTRA COMPACT SATELLITE SPEAKER

The Control 42C is an ultra-compact in-ceiling satellite loudspeaker designed for use with the Control 40CS/T subwoofer. It offers an unobtrusive design which is ideal for a wide range of installations. Available in White.

- Transducer: 50mm
- Dispersion: 150° Conical
- Response: 140Hz-20kHz
- Sensitivity: 82dB
- Power: 15W 16Ω



CONTROL 45C/T

130MM (5.25") COAXIAL CEILING RBI™ LOUDSPEAKER

The Control 45C/T is a premium loudspeaker designed for applications that can benefit from extremely wide bandwidth and very consistent coverage from a ceiling speaker with a small footprint. Available in White.

- Transducer: 130mm+20mm
- Dispersion: 120° Conical
- Response: 55Hz-20kHz
- Sensitivity: 88dB, D, WG
- Power: 75W 8Ω (60W Tx)



CONTROL 47C/T & 47LP

165MM (6.5") COAXIAL CEILING RBI™ LOUDSPEAKER

The Control 47C/T and Control 47LP are designed for applications that require extremely wide bandwidth and very consistent coverage. The Control 47LP (Low Profile backcan) is identical to Control 47 but equipped with a shallow backcan for use in areas with restricted mounting depths. Available in White.

- Transducer: 165mm+25mm
- Dispersion: 120° Conical
- Response: 55Hz-20kHz / 68Hz 47LP
- Sensitivity: 91dB, D, WG
- Power: 75W 8Ω (60W Tx)



CONTROL 47HC

165MM (6.5") COAXIAL HIGH CEILING RBI™ LOUDSPEAKER

The Control 47HC is designed for applications that require a narrow focused beamwidth pattern and very consistent coverage, such as for increasing clarity, intelligibility and SPL when in high-ceiling applications. Available in White.

- Transducer: 165mm+25mm
- Dispersion: 75° Conical
- Response: 55Hz-17kHz
- Sensitivity: 93dB, D, WG
- Power: 75W 8Ω (60W Tx)



CONTROL 40CS/T

200MM (8") HIGH IMPACT CEILING SUBWOOFER

The Control 40CS/T is a direct radiating, high impact 8" subwoofer designed for powerful bass response in an in-ceiling loudspeaker. It features a built in crossover network and four high-passed outputs enabling it to be used as a sub/sat system. Available in White.

- Transducer: 200mm
- Response: 32Hz-300Hz
- Sensitivity: 89dB
- Power: 100W 8Ω (80W Tx)



ACCESSORIES

- New Construction Bracket: MTC-xxNC* · Plaster Ring Bracket: MTC-xxMR*
- Trim Rings: Allow for installation into existing ceiling speaker cutouts that are larger than the speaker's normal cutout size. MTC-xxTR*
- MTC-48TRx12: Tile Rails for 4' x 4' ceiling tiles (pack of 12 rails).

*These models are available in different sizes. Specify speaker model when ordering.

JBL Control® 200 Series.

MEDIUM FORMAT CEILING SPEAKERS

Control 226C/T, 227C and 227CT are premium in-ceiling speakers designed to meet the increasing market demand for premium quality sound in ceiling-mount applications. The Control 200 Series loudspeakers incorporate breakthrough performance features such as best-in-class pattern control to provides a consistent sound throughout the listening area. Especially wide coverage allows fewer speakers to cover the space, reducing both the material and labor cost for the installation. The high-power kevlar-reinforced 6.5" (165 mm) low-frequency driver along with the titanium-diaphragm compression driver and the advanced-technology steep-slope crossover provide superb, wide-bandwidth sound quality.



CONTROL 226C/T

Control 200 models are available both in an independent backcan design (Control 227C & 227CT) and in an integrated backcan version (Control 226C/T).



CONTROL 226C/T

165MM (6.5") COAXIAL CEILING LOUDSPEAKER WITH HF COMPRESSION DRIVER

Control 226C/T is a compact, easy-to-install speaker with integrated backcan for blind-mounting into ceilings. It features a top-quality 60W multi-tap transformer for 70V/100V line distribution systems. The transformer may be bypassed, allowing the Control 226C/T to be used as a low-impedance 8 ohm speaker. C-ring, tile rails and grille are included. This model is designed to be able to utilise the optional MTC-19NC new construction ring and MTC-19MR plaster-ring for new construction projects requiring pre-installation rings. Available in White.

- Transducer: 165mm+25mm
- Dispersion: 120° Conical
- Response: 47Hz-19kHz
- Sensitivity: 90dB, CD
- Power: 100W 8Ω (68W Tx)



CONTROL 227C & 227CT

165MM (6.5") COAXIAL CEILING LOUDSPEAKER WITH HF COMPRESSION DRIVER

Control 227C is a high-output, low-impedance 8 ohm speaker assembly for installation with the separate MTC-200BB8 backcan and MTC-RG6/8 grille (both sold separately). Optional accessories include MTC-19NC new construction ring, MTC-19MR plaster-ring, and MTC-TB6/8 tile bridge. Control 227CT is a 70V/100V version of Control 227C, featuring a top-quality 60W multi-tap transformer for 70V/100V line distribution systems.

- Transducer: 165mm+25mm
- Dispersion: 120° Conical
- Response: 43Hz-19kHz
- Sensitivity: 90dB, CD
- Power: 100W 8Ω C / 68W Tx CT



CONTROL 227C & 227CT

Assembly with backcan and grille.

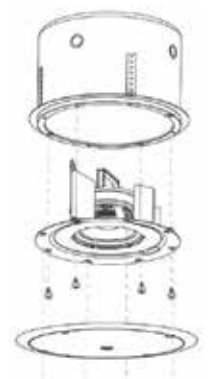

ACCESSORIES

- MTC-200BB6: Backcan for Control 227C and 227CT. 337mm (13.3") max diameter x 206mm (8.1") deep
- MTC-RG6/8: Round grille for Control 227C and 227CT. Also fits Control 328C & 328CT. 345mm (13.6") in diameter
- MTC-SG6/8: Square grille for Control 227C and 227CT. Also fits Control 328C & 328CT. 340mm (13.4 ") x (340 mm)
- MTC-TB6/8: Tile bridge for Control 227C and 227CT. Also fits Control 328C & 328CT.
- MTC-19NC & MTC-19MR: New-construction and mud rings fit Control 226 for new construction applications requiring pre-installation rings.

JBL Control® Contractor 300 Series.

LARGE FORMAT CEILING SPEAKERS

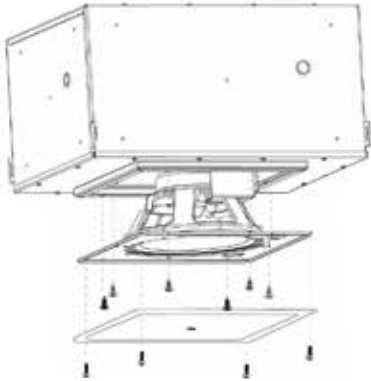

Control 300 Series represents the state of the art in large-format ceiling loudspeaker systems. True point-source coax designs, multiple power levels and transformer choices, plus an in-ceiling subwoofer, make it easy to fulfill any system performance requirements. Premium components include Kevlar-reinforced cones, low-saturation transformers and legendary JBL compression drivers. Advanced high-slope crossover networks, combined with low system distortion and smooth frequency response provides full, natural music along with exceptional speech intelligibility.

CONTROL 328C & 328CT 200MM (8") COAXIAL CEILING LOUDSPEAKER WITH HF COMPRESSION DRIVER

The Control 328C has a 8" woofer and 1" compression driver engineered from the ground up to deliver exceptional performance in a coaxial point source design ceiling speaker. The optional Control 328CT includes 70V/100V multi-tap transformer.

- Transducer: 200mm+25mm
- Dispersion: 100° Conical
- Response: 45Hz-18kHz
- Sensitivity: 93dB, CD
- Power: 150W 8Ω C / 68W Tx CT



CONTROL 321C & 321CT 300MM (12") COAXIAL CEILING LOUDSPEAKER WITH HF COMPRESSION DRIVER

The Control 321C has a 12" woofer and 1" compression driver engineered from the ground up to deliver exceptional performance in a coaxial point source design ceiling speaker. The optional Control 321CT includes 70V/100V multi-tap transformer.

- Transducer: 300mm+25mm
- Dispersion: 90° Conical
- Response: 34Hz-18kHz
- Sensitivity: 94dB, CD
- Power: 200W 8Ω C / 68W Tx CT



CONTROL 322C & 321CT 300MM (12") HIGH OUTPUT COAXIAL CEILING SPEAKER

The Control 322C has a high output 12" woofer and 1" compression driver engineered from the ground up to deliver exceptional performance in a coaxial point source design ceiling speaker. The optional Control 322CT includes 70V/100V multi-tap transformer.

- Transducer: 300mm+37mm
- Dispersion: 90° Conical
- Response: 32Hz-20kHz
- Sensitivity: 95dB, CD
- Power: 250W 8Ω C / 100W Tx CT



CONTROL 312CS 300MM (12") HIGH OUTPUT IN-CEILING SUBWOOFER SPEAKER

The Control 312CS is a high output 12" subwoofer that is an excellent addition to JBL Control 321, 322, and 328 loudspeaker systems.

- Response: 30Hz-4kHz
- Sensitivity: 93dB
- Power: 250W 8Ω



ACCESSORIES

Premium accessories include best-in-class black boxes made of heavy 16 gauge metal and lined with 1/2 MDF, as well as contemporary grilles and an optional higher power transformer. A variety of grilles are available.

SURFACE MOUNT SPEAKERS.



JBL Control Contractor 20 Series.

SURFACE MOUNT SPEAKERS

JBL Control Contractor 20 Series surface-mount speakers and subwoofers deliver full, rich sound; deep bass extension; high SPL output; and wide, consistent coverage for retail stores, restaurants, health clubs, theme parks, educational facilities or any application demanding top-quality sound reinforcement in a rugged, compact package.

Built-in JBL Invisiball® mounting technology makes installation a breeze. Outdoor capabilities can be further enhanced with optional IP55 WeatherMax™ grilles. Control Contractor surface-mount speakers are voiced similarly to other JBL Control Contractor models, allowing them to be combined with in-wall and in-ceiling speakers in a single listening space. The Control Contractor 20 line balances superior fidelity with versatility, ease-of-installation and contemporary style: Models feature IP44 weather-resistant transducers and enclosures.

CONTROL 23-1 ULTRA-COMPACT INDOOR/OUTDOOR BACKGROUND/FOREGROUND SPEAKER

The Control® 23-1 is a two-way 3" speaker with rich sonic character, wide coverage, consistent dispersion, versatile mounting, and a contemporary high-design look that fits into a wide range of decors. Available in Black or White.

Also available: Control 23-1L - 8 ohm only

- Dispersion: 100°x 100° HxV
- Response: 70Hz-20kHz
- Sensitivity: 86dB, D, WG
- Power: 40W 8Ω (15W Tx)
- Environmental: IP-44



CONTROL 25-1 COMPACT INDOOR/OUTDOOR BACKGROUND/FOREGROUND SPEAKER

The Control® 25-1 is a two-way 5" speaker with rich sonic character, wide coverage, consistent dispersion, versatile mounting, and a contemporary high-design look that fits into a wide range of decors. Available in Black or White.

Also available: Control 25-1L - 8 ohm only

- Dispersion: 100°x 100° HxV
- Response: 60Hz-20kHz
- Sensitivity: 90dB, D, WG
- Power: 75W 8Ω (30W Tx)
- Environmental: IP-44



CONTROL 28-1 HIGH-OUTPUT INDOOR/OUTDOOR BACKGROUND/FOREGROUND SPEAKER

The Control® 28-1 is a two-way 8" speaker with rich sonic character, wide coverage, consistent coverage, versatile mounting, and a contemporary high-design look that fits into a wide range of decors. Available in Black or White.

Also available: Control 28-1L - 8 ohm only

- Dispersion: 100°x 100° HxV
- Response: 45Hz-20kHz
- Sensitivity: 91dB, D, WG
- Power: 90W 8Ω (60W Tx)
- Environmental: IP-44



CONTROL 25-AV & 25-AVLS COMPACT BACKGROUND/FOREGROUND SPEAKER

The Control 25 is an especially wide band-width, smooth response speaker. It features a top quality 70V/100V transformer for distribution systems which can also be bypassed for use as an 8 ohm speaker. The Control 25AV-LS is UL1480 UUMW listed for use in fire alarm and/or emergency communication systems. Also EN52-24 certified. Available in Black or White.

- Dispersion: 100°x 100° HxV
- Response: 70Hz-23kHz
- Sensitivity: 87dB, D, WG
- Power: 100W 8Ω (60W Tx)
- Environmental: IP-X4



CONTROL 29AV-1 PREMIUM INDOOR/OUTDOOR MONITOR SPEAKER

The Control 29AV-1 utilises high power components and a complex network to achieve smooth high fidelity performance and a well-controlled defined coverage from a compact loudspeaker. Available in Black or White.

- Dispersion: 110°x85° HxV
- Response: 37Hz-18kHz
- Sensitivity: 90dB, CD, WG, R
- Power: 150W 8Ω (110W Tx)
- Environmental: IP-X4



CONTROL 30 3-WAY HIGH OUTPUT INDOOR/OUTDOOR MONITOR SPEAKER

The Control 30 is a three-way high output speaker designed for multiple uses. Weather resistance has been maximised, making the Control 30 suitable for outdoor applications. Includes 70V/100V multi-tap transformer. Available in Black or White.

- Dispersion: 120°x120° HxV
- Response: 38Hz-17kHz
- Sensitivity: 93dB, CD, WG
- Power: 250W 4Ω (150W Tx)
- Environmental: IP-X5



CONTROL 31 2-WAY HIGH OUTPUT INDOOR/OUTDOOR MONITOR SPEAKER

The Control 31 utilises high-power components, computer optimised horn, and a complex network to achieve smooth, powerful high-fidelity performance, extended bandwidth, and well-controlled defined coverage from a compact loudspeaker. Available in Black or White.

- Dispersion: 110°x110° HxV
- Response: 33Hz-19kHz
- Sensitivity: 92dB, CD, WG
- Power: 200w 8Ω (150w Tx)
- Environmental: IP-55



CONTROL SB2 DUAL COIL 250mm (10") COMPACT SUBWOOFER

The Control SB-2 functions as the subwoofer section of left/right music systems, preserving the stereo separation. The dual coil 10" transducer has been optimised to compliment four Control 23 speakers. Available in Black.

- Response: 38Hz-160Hz
- Sensitivity: 97dB
- Power: 170W 8Ω (x2)



CONTROL SB2210 DUAL 250MM COMPACT SUBWOOFER

The Control S82210 provides low frequency reinforcement for a wide variety of sound system applications. Its compact size, high output and outdoor capable design makes it one of the most versatile subwoofers in the installation market. Available in Black or White.

- Response: 42Hz-200Hz
- Sensitivity: 95dB
- Power: 400W 8Ω
- Environmental: IP-45



ACCESSORIES

MTC-PC2: The MTC-PC2 Panel Cover provides sealed entrance protection for input terminals and strain relief for incoming speaker wire.

MTC-xxSSG and MTC-xxWMG: SSG stainless steel retrofit grilles for Control 23, 25, and 28. WMG WeatherMax™ grilles add a foam and tight-weave backing to break up driving rain.

MTC-xxH* Horizontal Array Brackets: Allows horizontal arraying of two Control 23, 25 or 28 speakers. MTC-H brackets can be interconnected to form a suspended ring for mounting 6 or 3 speakers in a 360° cluster module.

MTC-xxV* Vertical Array Brackets: Allows vertical end-to-end mounting of up to three Control 23, 25, or 28 speakers.

MTC-xxCM* Ceiling Brackets: The curved arm allows installation of Control 23, 25, 28, 29AV or 30 speakers down from a ceiling.

MTC-30MK-WH: Marine grille kit for Control 30 (white only).

SB-2 Installation Brackets: The MTC-SB2W wall/corner bracket allows mounting of the subwoofer onto a wall surface or into a corner. The MTC-SB2C ceiling bracket enables suspension of the SB-2 from above, projecting downward into the listening area.

PMB-BK and PMB-WH: Control CRV pole-mount bracket for 4-speaker 360° hanging pendant cluster.

Various adaptors for installing via threaded pipe or rod available from third party.

* These models are available in different sizes. Specify speaker model when ordering.

JBL CSS Commercial Series.

CEILING AND SURFACE-MOUNT SPEAKERS



CSS-1S/T 135MM (5.25") COMPACT TWO-WAY SPEAKER

The CSS-1S/T is a versatile, compact two-way loudspeaker designed for use on 100V or 70V distributed speaker lines or in 8 ohm direct mode. Aimable wall-mount bracket is included. Available in Black.

- Dispersion: 120°x 120° HxV
- Response: 85Hz-18kHz
- Sensitivity: 86dB, D
- Power: 60W 8Ω (10W Tx)

JBL CSS Commercial Series.

PAGING HORNS



CSS-H15/H30 15W/30W PAGING HORNS

The CSS-H15 and H30 paging horns provide excellent voice range clarity. The wide coverage pattern allow the horns to cover larger audience areas, and they are designed for demanding environmental conditions. Available in Grey.

CSS-H15

- Dispersion: 70°x 90° HxV
- Response: 400Hz-7.5kHz
- Sensitivity: 105dB
- Power: 15W 8Ω (15W Tx)
- Environmental: IP-65

CSS-H30

- Dispersion: 50°x 70° HxV
- Response: 380Hz-6kHz
- Sensitivity: 108dB
- Power: 30W 8Ω (30W Tx)
- Environmental: IP-65



JBL Control® 50 Series.

SURFACE-MOUNT SUBWOOFER SATELLITE SYSTEM

The Control 50 Series subwoofer-satellite loudspeaker system provides high fidelity sound in any location where full-range high fidelity foreground/background music is required from a surface-mount system.

The Control 50S/T subwoofer can be utilised with either two of four Control 52 satellite speakers. The Control 50 system is mono. Both the Control 50S/T and Control 52 can be intermixed in systems along with the Control 40 Series in-ceiling models – Control 40CS/T subwoofer and Control 42 satellite speaker – to match the form factor requirements of a wide variety of applications.



CONTROL 52 60MM (2.5") SURFACE-MOUNT SATELLITE LOUDSPEAKER

The Control 52 satellite loudspeaker produces superb high fidelity sound via a low distortion 2.5" driver. The included wall bracket allows each speaker to be angled up to 45 degrees off-axis. Available in Black and White.

- Dispersion: 150° Conical
- Response: 140Hz-20kHz
- Sensitivity: 82dB
- Power: 15W 16Ω



CONTROL 50S/T 200MM (8") SURFACE-MOUNT SUBWOOFER SYSTEM

The Control 50S/T subwoofer contains a high-power, long excursion, 8" driver which provides extended low frequency response. The Control 50S/T installs quickly with its included two-piece easy-mount wall-bracket. Available in Black and White.

- Response: 32Hz-200Hz
- Sensitivity: 89dB
- Power: 100W 8Ω (80W Tx)



CONTROL C50PACK PACKAGED SURFACE-MOUNT SUBWOOFER-SATELLITE LOUDSPEAKER SYSTEM

The Control 50Pack includes 4x Control 52 satellite speakers and 1x Control 50 subwoofer. Available in Black and White.

- Versatile four satellite speaker system
- Wall mount brackets included
- Response: 32Hz-20kHz

CONTROL 52



CONTROL 50ST



JBL Control Pro Series.

COMPACT INSTALLATION MONITORS

The JBL Control Series speakers offer well balanced sound and exceptional power handling, making these speakers ideal for any installation requiring professional control monitor performance from a compact source.



CONTROL 1 PRO 100MM (5.25") TWO-WAY PROFESSIONAL COMPACT LOUDSPEAKER SYSTEM

The Control 1 Pro is a high-performance compact loudspeaker system incorporating monitor-grade, magnetically shielded transducers, a professional crossover network and full-range SonicGuard overload protection. Available in Black.

- Dispersion: 100°x 100° HxV
- Response: 80Hz-20kHz
- Sensitivity: 87dB, D
- Power: 150W 4Ω



CONTROL 2P 100MM (5.25") COMPACT POWERED TWO-WAY LOUDSPEAKER SYSTEM

The Control 2P compact powered reference monitor system combines JBL's legendary loudspeaker design with powerful amplification to deliver rich, accurate performance for demanding audio applications. Available in Black.

- Dispersion: 100°x 100° HxV
- Response: 80Hz-20kHz
- Connector: XLR, 1/4" TRS & RCA
- Power Amp: 35W x2



CONTROL 5 125MM (6.5") COMPACT PASSIVE TWO-WAY LOUDSPEAKER SYSTEM

The Control 5 is a high-performance, wide range control monitor suitable for use as the primary sound source in a variety of applications. All transducers are magnetically shielded for use in close proximity to video monitors. Available in Black.

- Response: 55Hz-20kHz
- Sensitivity: 89dB, D
- Power: 85W 4Ω



JBL Control CRV Series.

ARCHITECTURAL SPEAKERS



The Control CRV brings high design and versatility to commercial applications such as restaurants, retail stores, lounges, theme bars, music cafes, hotels, boardrooms, boutiques, museums, leisure venues, outdoors, upscale lobbies, and other foreground and background music and paging applications that require a fashionable look with superb sound quality.

JBL Control CRV speakers are exceedingly versatile, with multiple installation possibilities. The JBL Control CRV speaker can be wall-mounted aimed straight out from the wall, angled down at a 45° aiming axis, mounted spanning the junction of a wall and ceiling, or spanning the junction of a wall and another wall. At a junction, the unique curved shape of the speaker couples well with both boundary surfaces, forming a dual ground plane configuration which increases the acoustic length of the speaker, providing additional spaciousness to the sound character and increased bass output. In addition, two or three Control CRV speakers can be joined together to create loudspeaker solutions for a wide variety of coverage, appearance and mounting requirements. Using the optional PMB pole-mount bracket, four speakers can be joined together and suspended by a ceiling fan pole to form a cluster module with 360° horizontal coverage.



CONTROL CRV CONTEMPORARY CURVED DESIGN LOUDSPEAKER

Control CRV are outdoor capable to IP-34 (per IEC 529), utilising stainless steel screws, professional outdoor-rated screw-down terminals, and screened ports to prevent ingress of pests. Available in Black or White.

- Dispersion: 80°x 105° HxV
- Response: 80Hz-20kHz
- Sensitivity: 89dB, D, WG
- Power: 60W 4Ω (30W Tx)
- Environmental: IP-34

JBL Control HST Series.

ARCHITECTURAL SPEAKERS

The Control HST utilises JBL's patent-pending Hemispherical Soundfield Technology™ to achieve extremely wide coverage of the listening space along with eliminating the primary wall reflection that tends to cause inconsistent sound when speakers are attached to a wall. The wide hemispherical soundfield covers from wall to wall, allowing a single speaker to provide high-fidelity full-range sound to a large listening area. This can reduce the number of speakers needed for covering a space, lowering the overall cost for a sound system.



CONTROL HST

WIDE-COVERAGE SPEAKER WITH 5-1/4" LF, DUAL TWEETERS AND HST TECHNOLOGY™ LOUDSPEAKER

Control HST is ideal for a wide variety of applications, including retail stores, restaurants, corridors, educational facilities, hospitality, music cafes, leisure venues, upscale lobbies, and other background/foreground music and paging applications. The IP-54 outdoor capability also makes it suitable for applications where an outdoor capable speaker is required. The system is capable of handling 100 Watts, and is equipped with a 60W/70V/100V multi-tap transformer. Available in Black or White.

- Dispersion: 160°x 150° HxV
- Response: 50Hz-20kHz
- Sensitivity: 88dB, D, WG
- Power: 75W 8Ω (60W Tx)
- Environmental: IP-54



PENDANT SPEAKERS.



JBL Control 60 Series.

HIGH PERFORMANCE PENDANT LOUDSPEAKERS

The Control 60 Series bring renowned JBL sound and outstanding coverage to rooms and venues with open architecture or high-ceilings, while providing superior voice and musical clarity for rooms with difficult acoustics. Easy to install stainless steel hanging hardware is included, featuring redundant suspension cables and UL listed adjustable height hangers. The Control 60 Series pendant speakers are outdoor capable to IP44 (per IEC 529) and pair perfectly with the Control 40 Series ceiling speakers as they share the same sound signature and sonic characteristics.

CONTROL 62P 50MM (2.5") ULTRA-COMPACT SATELLITE PENDANT SPEAKER

The Control 62P is great for speech and mid-high music applications (external high-pass required) in visually sensitive applications. For full-range applications, up to 4 pieces can be driven from a Control 50S/T or 40CS/T subwoofer. Available in Black or White.

- Dispersion: 140° Conical
- Response: 150Hz-20kHz
- Sensitivity: 84dB
- Power: 15W 16Ω
- Environmental: IP-44



CONTROL 64P/T 100MM (4") COMPACT FULL RANGE PENDANT SPEAKER WITH RBI™

The Control 64P/T is a compact full-range, pendant-type loudspeaker that provides superb sound reproduction for rooms with open architecture ceilings and other locations where a pendant form factor is desired. Available in Black or White.

- Dispersion: 120° Conical
- Response: 55Hz-20kHz
- Sensitivity: 86dB, D, WG
- Power: 75W 8Ω (60W Tx)
- Environmental: IP-44



CONTROL 65P/T 133MM (5.25") COMPACT FULL RANGE PENDANT SPEAKER WITH RBI™

The Control 65P/T incorporates JBL's exclusive RBI Radiation Boundary Integration technology to provide very consistent, wide coverage throughout the listening space. 120° constant directivity broadband pattern control. Available in Black or White.

- Dispersion: 120° Conical
- Response: 55Hz-20kHz
- Sensitivity: 86dB, D, WG
- Power: 75W 8Ω (60W Tx)
- Environmental: IP-44



PENDANT SPEAKERS.

CONTROL 65P/T

CONTROL 67P/T

CONTROL 62P

CONTROL 67HC/T



CONTROL 67P/T

158MM (6.5") EXTENDED RANGE PENDANT SPEAKER WITH RBI™

The Control 67P/T incorporates a larger enclosure and high power 6.5" transducer for extended bass output capability. 120° constant directivity broadband pattern control. Available in Black or White.

- Dispersion: 120° Conical
- Response: 58Hz-18kHz
- Sensitivity: 90dB, D, WG
- Power: 75W 8Ω (60W Tx)
- Environmental: IP-44



CONTROL 67HC/T

158MM (6.5") HIGH CEILING PENDANT SPEAKER WITH RBI™

The Control 65HC/T has well controlled narrow coverage, ideal for improved voice intelligibility and musical clarity in high-ceiling venues or in rooms with difficult acoustics. Narrow 75° constant directivity broadband pattern control. Available in Black or White.

- Dispersion: 75° Conical
- Response: 75Hz-17kHz
- Sensitivity: 93dB, D, WG
- Power: 75W 8Ω (60W Tx)
- Environmental: IP-44



CONTROL 60PS/T

200MM (8") PENDANT SUBWOOFER WITH CROSSOVER

The Control 60 PS/T provides bass and extension, high impact and good transient response for high-fidelity sound systems. Available in Black or White.

- Response: 42Hz-350Hz
- Sensitivity: 89dB
- Power: 150W 8Ω (110W Tx)
- Environmental: IP-44



ACCESSORIES

MTC-PC60: Terminal Cover for C65P/T, C67P/T, C67HC/T & C60PS/T

MTC-PC62: Terminal Cover for C62P

IN-WALL SPEAKERS.



JBL Control® Contractor 100 Series.

EASY TO INSTALL WALL SPEAKERS

The Control 100 Speakers are premium in-wall speakers designed for applications where top performance from a loudspeaker with minimal visual impact is required, such as common theatre spaces. The Control 100 Series speakers are voiced similarly to other JBL control Contractor models, allowing mixing with surface-mount and in-ceiling speakers within a single listening space. The premium sound quality makes these loudspeakers ideal for critical listening environments, yet they are high power and rugged enough to handle venues requiring high-SPL heavy duty-cycle music.

CONTROL 126W/WT PREMIUM IN-WALL LOUDSPEAKER

The Control 126W is a premium in-wall speaker within the JBL Professional Control® Contractor line designed for applications such as foreground music, boardrooms, reception areas, airports, convention centres, cruise ships, retail outlets, restaurants, museums, surround locations, or any critical listening application where top performance from a loudspeaker with minimal visual impact is required. Available in White.



- Response: 38Hz-20kHz
- Sensitivity: 88dB, D
- Power: 50W 8Ω W / 30W Tx WT

CONTROL 128W/WT PREMIUM IN-WALL LOUDSPEAKER

The Control 128W is a premium in-wall speaker within the JBL Professional Control® Contractor line designed for applications such as foreground music, boardrooms, reception areas, airports, convention centres, cruise ships, retail outlets, restaurants, museums, surround locations, or any critical listening application where top performance from a loudspeaker with minimal visual impact is required. Available in White.



- Response: 30Hz-20kHz
- Sensitivity: 90dB, D
- Power: 60w 8Ω W / 50w Tx WT

LANDSCAPE SPEAKERS.



JBL Control 80 Series.

MUSHROOM TYPE OUTDOOR LANDSCAPE LOUDSPEAKERS

The Control 80 Series mushroom-type landscape speakers feature high fidelity performance for outdoor in-ground or on-ground use in applications such as hotels, restaurants, and shopping complexes. A wide frequency response and 360° of horizontal coverage ensure coverage of outdoor spaces with top-quality music and/or intelligible paging. The wiring entrance is via an included water-tight gland nut fitting which can be located in a number of positions on the speaker (installed in the field). A double-chamber seal helps to further protect connections and electrical components for long-term reliability. Colour infused throughout the enclosure case minimises the visual impact of the nicks and scratches that can happen with outdoor speakers. The Control 80 Series are IP-55 rated as per IEC529 (protected against jets of water) and exceeds MilSpec 810 for humidity, salt spray, temperature and UV.

CONTROL 85M

TWO-WAY 135MM (5.25") COAXIAL MUSHROOM LANDSCAPE SPEAKER

- Dispersion: 360°x 160° HxV
- Response: 55Hz-18kHz
- Sensitivity: 86dB, D, WG
- Power: 45W 8Ω (30W Tx)
- Environmental: IP-56
- Available in Green



CONTROL 88M

TWO-WAY 200MM (8") COAXIAL MUSHROOM LANDSCAPE SPEAKER

- Dispersion: 360°x 160° HxV
- Response: 47Hz-16kHz
- Sensitivity: 87dB, D, WG
- Power: 100W 8Ω (60W Tx)
- Environmental: IP-56
- Available in Green.



JBL PRO SOUNDBAR.



JBL Pro Soundbar.

COMMERCIAL GRADE ACTIVE SOUNDBAR

The JBL Pro SoundBar PSB-1 is a cost-effective, commercial-grade active soundbar designed specifically for use in applications such as hotel guestrooms, cruise ship staterooms, meeting rooms and public spaces. With an optimised feature set targeting the unique requirements of these applications, the Pro SoundBar reduces the cost and complexity found in consumer-grade soundbars while providing excellent sound quality, security, and reliability.

The all-in-one design of the Pro SoundBar provides full-range sound without the need for a separate subwoofer, providing excellent quality audio while minimising sound transfer to neighboring rooms. For further volume management, the Pro SoundBar offers a 4-position volume limiting switch to control the maximum volume output of the soundbar. The Pro SoundBar supports both fixed and variable source volume for maximum TV compatibility. Controls for the volume switch and source volume selection can be covered by a lockout plate to prevent tampering by anyone other than the support staff.

PSB-1

2.0 CHANNEL COMMERCIAL GRADE SOUNDBAR

- Response: 42Hz-20kHz
- Connector: RCA x2
- Power Amp: 20W x2
- Available in Black



Clarity at Any Level

Better clarity at low levels allows users to hear without increasing volume to intrusive levels.

Front-Facing Speakers

Front-facing speakers offer improved clarity over internal television speakers. TV speakers are typically rear or downward facing, diminishing the quality and volume and increasing sound transference.

Premium Materials

No cloth is used on the speaker grill, making the product easier to clean and maintain and less prone to damage.

Flexible and Easy to Use

The JBL Pro SoundBar is compatible with both fixed volume and variable volume control schemes. Whether the volume is controlled directly at the soundbar or upstream at the TV, the Pro SoundBar is able to support these scenarios, with a single remote controlling the entire system.

This is made possible by the Pro SoundBar's IR Learning feature. In fixed volume scenarios, where the volume is controlled at the soundbar, the Pro SoundBar is able to "learn" the IR pulse of volume up and volume down controls, meaning any remote can be used—programmable or not. This allows guests to use a television remote to adjust the entire system without the need to use a smart remote. No matter the system requirements, the JBL Pro SoundBar offers users a simplified experience.

COLUMN LOUDSPEAKERS.



JBL CBT Series.

LINE ARRAY COLUMN LOUDSPEAKERS

The JBL CBT Series line array columns with Constant Beamwidth Technology break new ground in performance, versatility, and affordability. Designed for venues that would typically use larger point-and-shoot speakers or powered columns, the CBT models incorporate patented technical advancements that allow them to vastly outperform competitive systems, with a level of user-friendliness that virtually eliminates the challenges of delivering great sound. With a slim compact design in fibreglass reinforced ABS enclosures, the CBT Series fits well into virtually any decor. When installed with optional MTC-PC2 panel cover, the CBT series is IP-55 rated (per IEC529).

CBT 50LA-1

50CM TALL LINE ARRAY COLUMN WITH 8X 50MM DRIVERS

The CBT 50LA-1 is the most compact of the models. At 150 watts, it holds its own against larger competitive columns. Response to 80 Hz works well for speech or music. Voicing can be set for music (flat) or speech via a switch. Available in Black or White.

- Dispersion: 150°x 20° HxV
- Response: 80Hz-20kHz
- Sensitivity: 89dB-93dB (Variable modes)
- Power: 100W 8Ω (60W Tx)
- Environmental: IP-55

Also available: Control 50LA-LS – EN54-24 Certified for life safety applications





CBT 100LA-1 100CM TALL LINE ARRAY COLUMN WITH 16X 50MM DRIVERS

The CBT 100LA-1 contains 16x 2" drivers in a slim, compact cabinet, providing excellent pattern control. Vertical coverage is adjustable via a switch and voicing is switchable between music (flat) or speech setting, making this model a great choice for a wide variety of environments. Available in Black or White.

- Dispersion: 150°x 15°/40° HxV
- Response: 80Hz-20kHz
- Sensitivity: 93dB-96dB (Variable modes)
- Power: 200W 8Ω (120W Tx)
- Environmental: IP-55



Also available: Control 100LA-LS – EN54-24 Certified for life safety applications

CBT 200LA-1 200CM TALL LINE ARRAY COLUMN WITH 32X 50MM DRIVERS

With a height of 200cm (6.6 ft), CBT 200LA-1 is the tallest model, providing useful pattern control down to below 200Hz. The top and bottom speaker modules allow individual adjustment of music (flat)/ speech voicing and vertical pattern settings. Setting in Asymmetrical Progressive Gradient coverage mode (top narrow; bottom broad) sends more sound toward the far listening area versus close for more even SPL near-to-far in the listening space. Available in Black or White.

- Dispersion: 150°x 15°/30° HxV
- Response: 80Hz-20kHz
- Sensitivity: 90dB-95dB (Variable modes)
- Power: 400W 4Ω (240W Tx)
- Environmental: IP-55



CBT50LA-1

CBT100LA-1

CBT200LA-1

CBT 70J-1
TWO-WAY LINE ARRAY COLUMN WITH ASYMMETRICAL VERTICAL COVERAGE

The CBTJ-1 is a two-way speaker with high fidelity and response down to 60Hz, 500W power handling, high sensitivity and high SPL capability. This model provides Asymmetrical Progressive Gradient coverage sending more sound toward the far area of the listening space. Available in Black or White.

- Dispersion: 150°x 25°/45° HxV
- Response: 60Hz-20kHz
- Sensitivity: 92dB-98dB (Variable modes)
- Power: 350W 8Ω
- Environmental: IP-55



CBT 70JE-1
PURPOSE DESIGNED EXTENSION FOR CTB 70J-1

The CTB 70JE-1 extension speaker is purpose-built for use with CBT 70J-1, lengthening the line array to extend the pattern control, extending the bass response, and increasing power handling SPL levels in the LF range. Available in Black or White.

- Response: 45Hz-700Hz
- Sensitivity: 90dB
- Power: 350w 8Ω
- Environmental: IP-55



CBT 1000
CONSTANT BEAMWIDTH TECHNOLOGY™ ADJUSTABLE COVERAGE LINE ARRAY COLUMN

Expanding upon our highly successful Constant Beamwidth Technology™ breakthrough, the CBT 1000 represents the next-generation in pattern control consistency utilising adjustable vertical coverage and a tapered horizontal waveguide to increase the versatility of aiming the coverage of the loudspeaker to more accurately map to the room geometry in a wide variety of listening spaces. Available in Black or White.

- Dispersion Horizontal: 160° to 100° (Asym)
- Dispersion Vertical: 16 Variable Patterns
- Response: 45Hz-20kHz
- Sensitivity: 95dB-102dB (Variable modes)
- Power: 1000W 4Ω
- Environmental: IP55





CBT 1000E PURPOSE-DESIGNED EXTENSION FOR CBT 1000 LINE ARRAY COLUMN SPEAKER

When connected to a CBT 1000 line array column speaker, the CBT 1000E Extension provides extended bass response, extended pattern control, and increased sound output levels. Available in Black or White.

- Response: 38Hz-650Hz
- Sensitivity: 92dB
- Power: 1000W 8Ω
- Environmental: IP-55



CBT70J-1

CBT70JE-1

CBT70J-1 +
CBT70JE-1

CBT1000

CBT1000E

CBT1000
& CBT1000E

ACCESSORIES

MTC-CBT-70T - Transformer module for CBT 70J-1 or 70J-1 + 70JE-1 array, bolts onto back, 70V/100V taps at 120W, 60W, 30W (plus 15W for 70V), gland nuts for water tight seal.

MTC-CBT-SMB1 - Stand Mount Bracket fits all models for portable applications. Note: For stability, CST 70J+E array system and CST 200LA-1 requires larger, heavier-duty stand than JBL SS2-BK.

MTC-CBT-FM1 - Low-profile, close-to-wall mounting bracket for use with CBT 50LA-1, CBT50LA-LS, and CST 100LA-1 and CBT 100LALS.

MTC-CBT-FM2 - Low-profile, close-to-wall mounting bracket for use with CBT 70J-1 and CST 70J-1/70JE-1 array.

CBT Calculator Software - For designing CBT speakers into projects. Download from jblpro.com website.



LOUDSPEAKERS ARRAYS.



JBL Intellivox Series.

BEAM FORMING, SELF POWERED LOUDSPEAKER ARRAYS



The JBL Intellivox Series has revolutionised directivity control. If you need to deliver a clear & intelligible message and/or musical clarity in a large reverberant space, then Intellivox is the solution. Thanks to its small cross section and neutral visual design, Intellivox can blend into any environment, allowing sound system designers, architects and acoustic engineers to work together to deliver systems that not only look great but sound great too. Intellivox's pioneering of Beam Steering wasn't the end of the journey, but just the start. Ground-breaking Beam Shaping technology delivers a level of control that is quite simply unmatched. Its superior coverage capabilities once again set a new bench mark within its class. JBL has been constantly improving their DDC (Digital Directivity Control for beam steering) and DDS (Digital Directivity Synthesis for complex beam shaping) technologies, to ensure that the systems continually outpace the competition and are easy to set up and operate.

WHY CHOOSE INTELLIVOX? A GREAT SOUNDING SYSTEM

Quality sound reproduction - delivering the ultimate intelligibility:

- Highly intelligible speech reinforcement
 - Natural sound reproduction
 - High direct-to-reverberant ratio
 - Free from distortion
 - Even SPL coverage (The sound level from a properly set up Intellivox unit will be the same, whether the listener is at a distance or close up)
- Digital directivity technologies ensure a high ratio of direct sound to reverberant sound which is critical to the intelligibility of any sound system.





Kings Cross Station, UK

A GREAT LOOKING SYSTEM

Architectural Integration - for systems that look great and sound great

- No need for mechanical aiming
- Units can be mounted vertically
- Units can be recessed into surfaces
- Colour matching service available
- Units have a slim and unobtrusive design
- Can be integrated into buildings of all ages and styles.

AN EASY TO INSTALL AND MAINTAIN SYSTEM

Installation and maintenance - easy to install and maintain:

- Fewer installation/maintenance points than conventional distributed systems
- Units can be configured from a single control point via an RS-485 network
- A wide range of mounting and cable entry options
- All parts & connections are accessible from the front as well as the rear of the unit making it possible to service the unit in situ
- Most units can be ordered with the electronics module at the top or bottom of the enclosure, allowing additional architectural flexibility.



JFK Terminal 4, USA



Cologne Dome, Germany



Covington Cathedral, USA

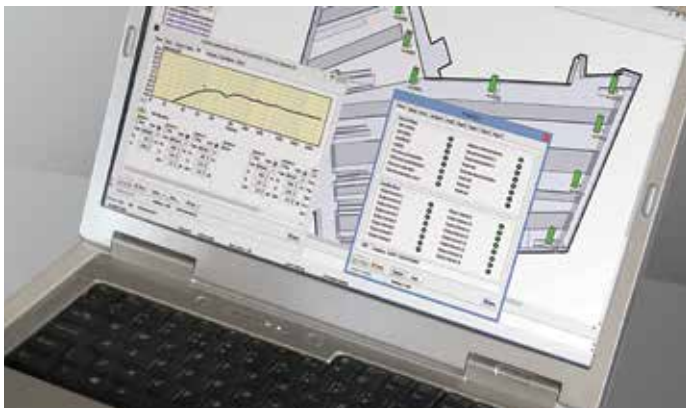

A SAFE AND RELIABLE SYSTEM

Emergency sound systems - Intellivox products are designed for use in emergency sound systems:

- Designed to provide reliable operation
- In some cases, Intellivox products are the only way of achieving the required levels of speech intelligibility in a large reverberant space
- All elements of Intellivox products are constantly monitored by the on board RISC processor
- Faults can be reported via the built in failure relay or via the network
- WinControl servers can be supplied to provide fault logging and to interface to external controllers.



Integrated electronics module which combines powerful Digital Signal Processing with multi-channel class D Amplifiers

THE JBL PROFESSIONAL INTELLIVOX FAMILY

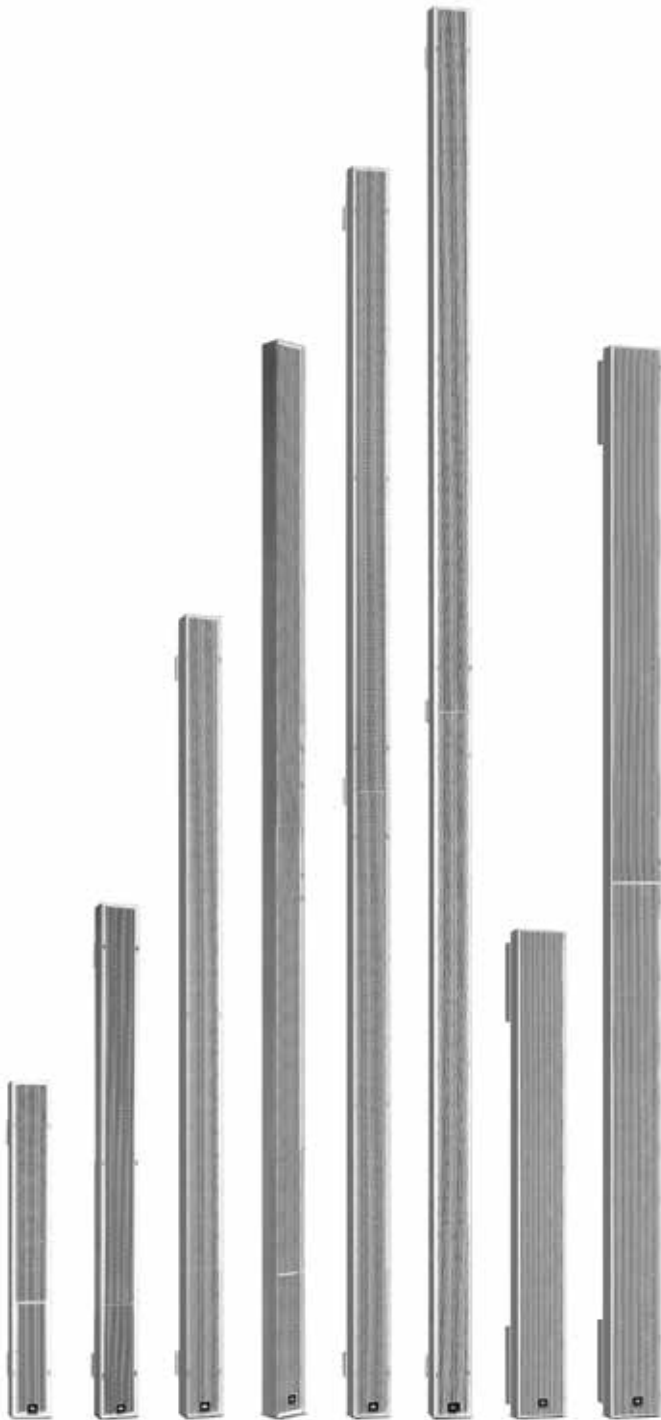

1. DC/ DS/ DSX500
2. DC/ DS/ DSX430
3. DC/ DS/ DSX380
4. HP-DS370
5. DC/ DS/ DSX280
6. DC/ DS/ DSX180
7. HP-DS170
8. DC/ DS115



DDA (DIGITAL DIRECTIVITY ANALYSIS)

DDA is a powerful yet intuitive Windows application for accurately predicting the electro-acoustic performance of loudspeaker systems in (semi) open or closed spaces. It includes 3D room acoustic modelling, direct sound simulation as well as statistical prediction of various acoustic parameters.

DDA supports all JBL point source loudspeakers with CLF data and all JBL Intellivox products. Intellivox makes use of JBL's advanced beam shaping (DDS) technologies. From DDA the radiation pattern of JBL Intellivox loudspeaker arrays can be controlled precisely and tailored to the shape and the acoustics of the space. In addition, DDA offers various design tools which reduce design time and help the sound designer to optimise the system performance. For installation and commissioning purposes DDA also generates FIR output filters which can be uploaded to supported DDS-controlled loudspeaker arrays using the JBL WinControl software.

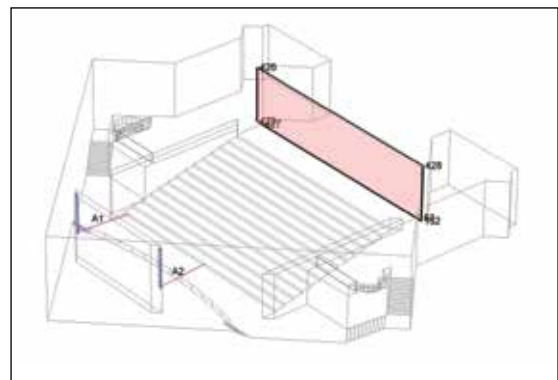

POINTSOURCE SPEAKERS.



AE APPLICATION ENGINEERED™ SPEAKERS.

ORIGINAL SERIES LOUDSPEAKERS

Imagine if your every need was not only met, but anticipated. The Application Engineered Series does exactly that. The AE Series is a complete line of permanent installation loudspeakers, containing the performance and features that meet the needs of contractors and consultants alike. Incorporating the latest loudspeaker technology, a wide selection of models, high performance features, reliability, and a systems approach. AE Series has a loudspeaker for just about any challenge you might encounter. Optional Weather Protection treatment is available.

AM7212

HIGH-POWER 300MM (12") TWO-WAY

The AM7212 loudspeaker system is comprised of one 300mm (12") Differential Drive 2262H woofer and a 2432H high frequency compression driver. The large format PT waveguide provides excellent coverage and is rotatable for use in either the vertical or horizontal orientation. Available in Black or White and WRC/WRX finishes for extreme weather protection.

Available in five models:

AM7212/95:	90° x 50°
AM7212/64:	60° x 40°
AM7212/00:	100° x 100°
AM7212/66:	60° x 60°
AM7212/26:	120° x 60°

- Response: 36Hz-20kHz
- Sensitivity: 95dB, CD, WG, R
- Power: 600W 8Ω (Bi-Amp Switchable)
- Environmental: IP-X3, Optional IP-55 or IP-56
- Suspension: M10 x15



AM7215

HIGH-POWER 380MM (15") TWO-WAY

The AM7215 loudspeaker system is comprised of one 380mm (15") Differential Drive 2262H woofer and a 2432H high frequency compression driver. The large format PT waveguide provides excellent coverage and is rotatable for use in either the vertical or horizontal orientation. Available in Black or White and WRC/WRX finishes for extreme weather protection.

Available in four models:

AM7215/95:	90° x 50°
AM7215/64:	60° x 40°
AM7215/26:	120° x 60°
AM7215/66:	60° x 60°

- Response: 34Hz-20kHz
- Sensitivity: 96dB, CD, WG, R
- Power: 600W 8Ω (Bi-Amp Switchable)
- Environmental: IP-X3, Optional IP-55 or IP-56
- Suspension: M10 x15



AM5212

MEDIUM-POWER 300MM (12") TWO-WAY

The AM5212 loudspeaker system is comprised of one 300mm (12") Differential Drive 262H-1 woofer and a 2408H-1 high frequency compression driver. The large format PT waveguide provides excellent coverage and is rotatable for use in either the vertical or horizontal orientation. Available in Black or White and WRC/WRX finishes for extreme weather protection.

Available in five models:

AM5212/95:	90° x 50°
AM5212/64:	60° x 40°
AM5212/00:	100° x 100°
AM5212/66:	60° x 60°
AM5212/26:	120° x 60°

- Response: 37Hz-20kHz
- Sensitivity: 96dB, CD, WG, R
- Power: 300W 8Ω (Bi-Amp Switchable)
- Environmental: IP-X3, Optional IP-55 or IP-56
- Suspension: M10 x15



AE SERIES POINTSOURCE LOUDSPEAKERS.

AE Series loudspeakers are ideal for a wide variety of fixed installation applications including performing arts facilities, theatrical sound design, auditoriums, houses of worship, live music clubs, dance clubs/ discotheques, sports facilities and themed entertainment venues.

The special mid-high frequency models can be used without LF reinforcement in voice-only PA and delay-fill applications. The smaller models are ideal in lecture halls and corporate learning centres as well as in delay-fill locations of larger systems.

AE Series models provide a wide variety of building blocks for system designers to achieve just the right solution for any installation.

Within the AE Series there are three power footprint levels. The high output models are found in the 7000 and 6000, medium output power level is found in the 5000 and 4000 with lower output power found in the Compact AC series and Expansion AC series.

Many AE Series speakers offer selectable crossover modes: tri-amp/bi-amp or bi-amp/ passive switchable. In addition, AE Series models incorporate sophisticated crossover designs for outstanding sound quality and consistent coverage. To minimise overlap between adjacent frequency bands, steep slopes are utilised in passive crossovers – most are 4th order (24 dB/octave).



This reduces off-axis lobing, providing consistent coverage throughout the crossover region. Conjugate networks are added in some models to fine tune the frequency response for optimum sound quality.



Differential Drive Technology

JBL's exclusive Differential Drive technology is at the core of the AM5212, AM5215, AM7212, AM7215, AM7315, AM7200 and AL7115 as well as the ASB6112, ASB6115, ASB6125, ASB7118 and ASB7128. This technology reduces weight while enhancing all critical performance parameters.



Progressive Transition Waveguides

JBL's new patent pending Progressive Transition waveguides represent the latest in horn technology. In addition to providing smooth, low distortion sound, PT waveguides deliver uniform off-axis frequency response to every point within the intended coverage area.

CMCD™ Cone Midrange Compression Drivers

Incorporated into all cone midrange models – patented CMCD technology is more than a simple displacement plug. In addition to providing increased output and lower distortion, this cone-based true compression driver design extends operational bandwidth (both up and down in frequency) to cover the entire vocal range seamlessly, allows for better waveguide pattern control, and improves phase coherency of the midrange signal for clearer, more intelligible audio quality.



AM5215

MEDIUM-POWER 380MM (15") TWO-WAY

The AM5212 loudspeaker system is comprised of one 380mm (15") Differential Drive 265H-1 woofer and a 2408H-1 high frequency compression driver. The large format PT waveguide provides excellent coverage and is rotatable for use in either the vertical or horizontal orientation. Available in Black, White and WRC/WRX weather resistant finishes.

- Response: 35Hz-20kHz
- Sensitivity: 98dB, CD, WG, R
- Power: 350W 8Ω (Bi-Amp Switchable)
- Environmental: IP-X3, Optional IP-55 or IP-56
- Suspension: M10 x15
- Available in four models:
 - AM5215/64: 60° x 40°
 - AM5215/66: 60° x 60°
 - AM5215/95: 90° x 50°
 - AM5215/26: 120° x 60°



AM7315

HIGH-POWER 380MM (15") THREE-WAY

The AM7315 loudspeaker system is comprised of a 380mm (15") low frequency woofer, one 8" CMCD compression driver, and one 38mm (1.5") exit compression driver. The multi-band PT mid-high frequency waveguide provides well controlled coverage and is rotatable for cabinet positioning in either horizontal or vertical orientation. Black DuraFlex™ finish. White available upon request.

- Response: 38Hz-20kHz
- Sensitivity: LF 97dB, MHF 108dB, CD, WG, R
- Power: LF 600W 8Ω, MHF 200W 8Ω (Tri-Amp Switchable)
- Environmental: IP-X3, Optional IP-55 or IP-56
- Suspension: M10 x13
- Available in two models:
 - AM7315/95: 90° x 50°
 - AM7315/64: 60° x 40°



AE Application Engineered™ Subwoofers.

ORIGINAL SERIES SUBWOOFERS

AL7115

HIGH POWER 15" LOW FREQUENCY TRAPEZOIDAL LOUDSPEAKER SYSTEM

The AL7115 loudspeaker system is comprised of one 15" JBL Differential Drive 2265H woofer in a front-loaded, vented configuration. This model arrays with various AE series mid-high frequency and compact two-way models. Available in Black DuraFlex™ finish. White available on request.

- Cabinet matches AM7315 footprint
- Response: 40Hz-4.2kHz
- Sensitivity: 97dB @ 50Hz-125Hz
- Power: 600W 8Ω
- Environmental: IP-X3, Optional IP-55 or IP-56
- Suspension: M10 x13



ASB6112

HIGH POWER COMPACT 300MM (12") SUBWOOFER SYSTEM

The ASB6112 compact subwoofer system is comprised of one 300mm (12") JBL Differential Drive 2263H woofer. Black DuraFlex™ finish. White available on request.

- Response: 35Hz-1kHz
- Sensitivity: 96dB
- Power: 700W 8Ω
- Environmental: IP-X3, Optional IP-55 or IP-56
- Suspension: M10 x16



ASB6115

HIGH POWER LIGHTWEIGHT 380MM (15") SUBWOOFER

The ASB6115 subwoofer system is comprised of one 380mm (15") JBL Differential Drive 2265H-1 woofer in a vented, front-loaded enclosure. This system is for ground-stacked or suspended applications in combination with other AE series products. Black DuraFlex™ finish. White available on request.

- Response: 32Hz-1kHz
- Sensitivity: 97dB @ 35Hz-400Hz
- Power: 675W 8Ω
- Environmental: IP-X3, Optional IP-55 or IP-56
- Suspension: M10 x16



ASB6125

HIGH POWER LIGHTWEIGHT DUAL 380MM (15") SUBWOOFER

The ASB6125 subwoofer system is comprised of two 380mm (15") JBL Differential Drive 2265H-1 woofer in a vented, front-loaded enclosure. This system is for ground-stacked or suspended applications in combination with other AE series products. Black DuraFlex™ finish. White available on request.

- Response: 32Hz-1kHz
- Sensitivity: 100dB @ 35Hz-400Hz
- Power: 675W 8Ω x2, 1350W 4Ω
- Environmental: IP-X3, Optional IP-55 or IP-56
- Suspension: M10 x16



ASB7118

HIGH POWER ULTRA LONG EXCURSION DUAL 457MM (18") SUBWOOFER

The ASB7118 high power subwoofer system is comprised of one 18" JBL Differential Drive 2269H ultra long excursion woofer. JBL's exclusive vented gap cooling and ultra robust composite cone ensure extra long life. Black DuraFlex™ finish. Available in White on request.

- Response: 22Hz-1kH
- Sensitivity: 96dB @ 25Hz-200Hz
- Power: 1200W 8Ω
- Environmental: IP-X3, Optional IP-55 or IP-56
- Suspension: M10 x16



ASB7128

HIGH POWER ULTRA LONG EXCURSION 457MM (18") SUBWOOFER

The ASB7128 high power subwoofer system is comprised of two 457mm (18") JBL Differential Drive 2269H ultra long excursion woofers. JBL's exclusive vented gap cooling and ultra robust composite cone ensure extra long life. Black DuraFlex™ finish. Available in White on request.

- Response: 20Hz-1kHz
- Sensitivity: 99dB @ 25Hz-200Hz
- Power: 1200w 8Ω x2, 2400w 4Ω
- Environmental: IP-X3, Optional IP-55 or IP-56
- Suspension: M10 x16



ASB4128

MEDIUM POWER DUAL 457MM (18") SUBWOOFER

The ASB4128 subwoofer system is comprised of two 18" JBL 2042H woofers in a vented, front-loaded configuration. The deep cabinet allows for extended low frequency bandwidth with minimal frontal profile. Black DuraFlex™ finish. Available in White on request.

- Response: 30Hz-1kHz
- Sensitivity: 103dB @ 30Hz-200Hz
- Power: 300W 8Ω x2, 600W 4Ω
- Environmental: IP-X3, Optional IP-55 or IP-56
- Suspension: M10 x12



ASB6118

HIGH POWER 457MM (18") SUBWOOFER SYSTEM

The ASB6118 subwoofer system is comprised of one 458mm (18") JBL 2242H SVG woofer in a vented, front-loaded configuration. Black DuraFlex™ finish. Available in White on request.

- Response: 28Hz- 1kHz
- Sensitivity: 98dB @ 30Hz-100Hz
- Power: 800W 8Ω
- Environmental: IP-X3, Optional IP-55 or IP-56
- Suspension: M10 x12



ASB6128

HIGH POWER DUAL 457MM (18") SUBWOOFER

The ASB6128 subwoofer system is comprised of two 457mm (18") JBL 2242H SVG woofers in a vented, front-loaded configuration. The deep cabinet allows for extended low frequency bandwidth with minimal frontal profile. Black DuraFlex™ finish. Available in White on request.

- Response: 28Hz-1kHz
- Sensitivity: 102dB @ 30Hz-100Hz
- Power: 800W 8Ω x2, 1600W 4Ω
- Environmental: IP-X3, Optional IP-55 or IP-56
- Suspension: M10 x12



AE Application Engineered™ Expansion Series Loudspeakers.

EXPANSION SERIES LOW COST LOUDSPEAKERS

The AE Expansion series is designed for use in a variety of applications. All models are equipped with multiple M10 attachment points and additional installation-friendly features and utilise a rugged grille design and system appearance suitable for nearly all indoor environments.

The AE Expansion Series includes six 2-way full-range systems and two subwoofer models. The full-range systems include fourteen M10 suspension points and four M8 mounting points for use when a wall mount bracket is required. The subwoofer models include 12 M10 suspension points. All models are available in both black and white textured coatings and are intended for indoor use. The line includes optional U-brackets and a wall mount bracket accessory for all full-range models.

These low-cost systems are a perfect choice for projects including bars, restaurants, clubs, lounges, worship facilities, gymnasiums, retail spaces, and education facilities. Their compact size provides opportunities for system designers to satisfy most architectural requirements.

AC895

TWO-WAY FULL-RANGE LOUDSPEAKER WITH 1 X 203MM (8") LF

AC895 is a compact 2-way full-range loudspeaker system comprised of one 209mm (8") low frequency driver and one 25mm (1") exit/25mm (1") voice-coil compression driver. The rotatable PT™ Progressive Transition waveguide provides 90° by 50° coverage in vertical cabinet orientation. Highslope passive crossovers minimise band overlap and well-controlled off axis response. Textured Black paint finish. Available in White on request.

- Dispersion: 90°x 50° HxV
- Response: 70Hz-20kHz
- Sensitivity: 94dB, CD, WG, R
- Power: 150W 8Ω
- Suspension: M10 x18



AC195

TWO-WAY FULL-RANGE LOUDSPEAKER WITH 1 X 254MM (10") LF

AC195 is a compact 2-way full-range loudspeaker system comprised of one 258mm (10") low frequency driver and one 25mm (1") exit/35mm (1.5") voice-coil compression driver. The rotatable PT™ Progressive Transition waveguide provides 90° by 50° coverage in vertical cabinet orientation. Highslope passive crossovers minimise band overlap and well-controlled off axis response. Textured Black paint finish. Available in White on request.

- Dispersion: 90°x 50° HxV
- Response: 68Hz-20kHz
- Sensitivity: 95dB, CD, WG, R
- Power: 200W 8Ω
- Suspension: M10 x18



AC266

TWO-WAY FULL-RANGE LOUDSPEAKER WITH 1 X 300MM (12") LF

A compact 2-way full-range loudspeaker system comprised of one 300mm (12") low frequency driver and one 25mm (1") exit/35mm (1.5") voice-coil compression driver. The horn provides 60° by 60° coverage in vertical and horizontal orientation. High-slope passive crossovers minimise band overlap and well-controlled off axis response. Textured Black paint finish. Available in White on request.

- Dispersion: 60°x 60° HxV
- Response: 63Hz-20kHz
- Sensitivity: 97dB, CD, WG
- Power: 250W 8Ω
- Suspension: M10 x18



AC299

TWO-WAY FULL-RANGE LOUDSPEAKER WITH 1 X 300MM (12") LF

A compact 2-way full-range loudspeaker system comprised of one 300mm (12") low frequency driver and one 25mm (1") exit/35mm (1.5") voice-coil compression driver. The horn provides 90° by 90° coverage in vertical and horizontal orientation. High-slope passive crossovers minimise band overlap and well-controlled off axis response. Textured Black paint finish. Available in White on request.

- Dispersion: 90°x 90° HxV
- Response: 63Hz-20kHz
- Sensitivity: 97dB, CD, WG
- Power: 250W 8Ω
- Suspension: M10 x18



AC566

TWO-WAY FULL-RANGE LOUDSPEAKER WITH 1 X 385MM (15") LF

A compact 2-way full-range loudspeaker system comprised of one 385mm (15") low frequency driver and one 25mm (1") exit/35 mm (1.5") voice-coil compression driver. The horn provides 60° by 60° coverage in vertical and horizontal orientation. High-slope passive crossovers minimise band overlap and well-controlled off axis response. Textured Black paint finish. Available in White on request.

- Dispersion: 60°x 60° HxV
- Response: 60Hz-20kHz
- Sensitivity: 98dB, CD, WG
- Power: 250W 8Ω
- Suspension: M10 x18



AC599

TWO-WAY FULL-RANGE LOUDSPEAKER WITH 1 X 385MM (15") LF

A compact 2-way full-range loudspeaker system comprised of one 385mm (15") low frequency driver and one 25mm (1") exit/35 mm (1.5") voice-coil compression driver. The horn provides 60° by 60° coverage in vertical and horizontal orientation. High-slope passive crossovers minimise band overlap and well-controlled off axis response. Textured Black paint finish. Available in White on request.

- Dispersion: 90°x 90° HxV
- Response: 60Hz-20kHz
- Sensitivity: 98dB, CD, WG
- Power: 250W 8Ω
- Suspension: M10 x18



AC115S

385MM (15") HIGH POWER SUBWOOFER

A high power subwoofer system comprised of one 385mm (15") low frequency driver in a vented, front-loaded configuration for extended bandwidth. Textured Black paint finish. Available in White on request.

- Response: 32Hz-250Hz
- Sensitivity: 94dB
- Power: 400W 8Ω
- Suspension: M10 x12



AC118S

459MM (18") HIGH POWER SUBWOOFER

As per AC115S but 459mm (18"). Textured Black paint finish. Available in White on request.

- Response: 32Hz-250Hz
- Sensitivity: 95dB
- Power: 450W 8Ω
- Suspension: M10 x12



AE Application Engineered™ Compact Loudspeakers.

COMPACT LOUDSPEAKERS



An extension of the industry leading AE Series, the AE Compact family consists of high output, 2-way loudspeaker systems combining flexibility with high fidelity. Ranging from a single 133mm (5.25") point-and-shoot box to dual 200mm (8") loudspeaker system that are specifically designed for better serving the needs of both designers and artists alike. The ultra-compact AC15 and AC25 models include a 1" dome tweeter while the AC16, AC26, AC18, and AC28 models feature 1" exit compression drivers providing sonic clarity and crisp detail. The AC18 and AC28 featuring JBL's Progressive Transition™ Rotatable Waveguides, offer the system designer a choice of coverage patterns in either 90° x 50° or 120° x 60°.

AC15

Ultra compact enclosure with one 133mm (5.25") LF transducer and 90° x 90° waveguide with 25mm dome tweeter. It is equipped with attachment points for a U-bracket and OmniMount® type bracket. Black DuraFlex™ finish. White available upon request.

- Dispersion: 90°x 90° HxV
- Response: 80Hz-20kHz
- Sensitivity: 86dB, D, WG
- Power: 150W 16Ω
- Suspension: M6 x2, M8 x4



AC25

With all the features of the AC15 with two 133mm (5.25") LF transducers. Black DuraFlex™ finish. White available upon request.

- Dispersion: 90°x 90° HxV
- Response: 80Hz-20kHz
- Sensitivity: 91dB, D, WG
- Power: 225W 16Ω
- Suspension: M6 x4, M8 x4



AC16

Ultra compact enclosure with one 165mm (6.50") LF transducer and 90° x 90° Progressive Transition™ waveguide with a 25mm exit compression driver. It is equipped with attachment points for a U-bracket and OmniMount® type bracket and standard mount adapter. Black DuraFlex™ finish. White available upon request. WRC/WRX finishes are available for extreme weather protection.

- Dispersion: 90°x 90° HxV
- Response: 55Hz-20kHz
- Sensitivity: 90dB, CD, WG
- Power: 160W 16Ω
- Suspension: M6 x4, M8 x5



AC26

With all the features of the AC16 with two 165mm (6.50") LF transducers. Black DuraFlex™ finish. White available upon request. WRC/WRX finishes are available for extreme weather protection.

- Dispersion: 90°x 90° HxV
- Response: 55Hz-20kHz
- Sensitivity: 92dB, CD, WG
- Power: 180W 8Ω
- Suspension: M6 x4, M8 x6



AC18/95 & AC18/26

Compact enclosures with one 200mm (8") LF transducer and a 90°x 50° Progressive Transition Field Rotatable Waveguide with a 25mm (1") exit compression driver (AC18/95) or 120°x60° Progressive Transition™ Field Rotatable Waveguide with a 25mm (1") exit compression driver (AC18/26). Equipped with U-bracket attachment points, OmniMount bracket and stand mount adaptor. Black DuraFlex™ finish. White available upon request. WRC/WRX finishes are available for extreme weather protection.

- Dispersion: 90°x 50° & 120°x 60° HxV
- Response: 52Hz-20kHz
- Sensitivity: 92dB, CD, WG, R
- Power: 250W 8Ω
- Environmental: IP-X3, Optional IP-55 or IP-56
- Suspension: M6 x4, M8 x6



AC28/95 & AC28/26

With all the features of the AC18/95 & AC18/26 with two 200mm (8") LF transducers. Black DuraFlex™ finish. White available upon request. WRC/WRX finishes are available for extreme weather protection.

- Dispersion: 90°x 50° & 120°x 60° HxV
- Response: 53Hz-20kHz
- Sensitivity: 94dB, CD, WG, R
- Power: 375W 8Ω
- Environmental: IP-X3, Optional IP-55 or IP-56
- Suspension: M8 x10



JBL All Weather Compact Series.

COMPACT ALL WEATHER

The AWC All Weather Compact models incorporate co-axial drivers for high output, consistent pattern control, extraordinary clarity with speech, and extended frequency response for music, all from very compact enclosures.

These models include minimally audible overload protection, 200 Watt transformers for 70V or 100V distributed systems, and can also be operated 8 ohm direct.



AWC62

COMPACT ALL-WEATHER 165MM (6.5") TWO-WAY COAXIAL LOUDSPEAKER

The AWC62 is a compact two-way highly weather-resistant full-range loudspeaker system which is ideal for speech and music-fill in a wide variety of applications. Available in Black or Light Grey.

- Dispersion: 110° Conical
- Response: 70Hz-18kHz
- Sensitivity: 92dB, CD
- Power: 120W 8Ω (120W Tx)
- Environmental: IP-56



AWC82

COMPACT ALL-WEATHER 200MM (8") TWO-WAY COAXIAL LOUDSPEAKER

The AWC82 is a compact two-way highly weather-resistant full-range loudspeaker system which is ideal for speech and music-fill in a wide variety of applications. Available in Black or Light Grey.

- Dispersion: 120° Conical
- Response: 80Hz-18kHz
- Sensitivity: 94dB, CD
- Power: 200W 8Ω (200w Tx)
- Environmental: IP-56



AWC129

COMPACT ALL-WEATHER 300MM (12") TWO-WAY COAXIAL LOUDSPEAKER

The AWC129 is a compact two-way highly weather-resistant full-range loudspeaker system which is ideal for speech and music-fill in a wide variety of applications. Available in Black or Light Grey.

- Dispersion: 90° Conical
- Response: 55Hz-18kHz
- Sensitivity: 96dB, CD
- Power: 250W 8Ω (200w Tx)
- Environmental: IP-56



AWC159

COMPACT ALL-WEATHER 385MM (15") TWO-WAY COAXIAL LOUDSPEAKER

The AWC159 is a compact two-way highly weather-resistant full-range loudspeaker system which is ideal for speech and music-fill in a wide variety of applications. Available in Black or Light Grey.

- Dispersion: 90° Conical
- Response: 52Hz-18kHz
- Sensitivity: 96dB, CD
- Power: 300W 8Ω (300w Tx)
- Environmental: IP-56



AWC15LF

COMPACT ALL-WEATHER 385MM (15") LOW FREQUENCY LOUDSPEAKER

The AWC15LF is a compact highly weather resistant loudspeaker for augmenting the low frequency capability of a sound system, and is ideal for use with other AWC full-range loudspeakers. Available in Black or Light Grey.

- Response: 45Hz-2.2kHz
- Sensitivity: 94dB
- Power: 350W 8Ω (300w Tx)
- Environmental: IP-56



JBL AW All Weather Series.

FULL SIZE ALL WEATHER



ALL WEATHER SERIES: EXCELLENT PROTECTION IN THE HARSHTEST ENVIRONMENTS

The AW full-size models are comprised of the JBL Differential Driver® dual voice coils and dual magnetic gap low frequency 12" and 15" woofers and the 2432H high-frequency 38mm (1.5") exit, 75mm (3") voice-coil compression driver. The large format Progressive Transition™ wave-guides provide excellent high-frequency coverage patterns. Waveguides are rotatable so the loudspeaker system can be used in either vertical or horizontal orientation.

Enclosures are constructed of multilayer glass composite and are heavily braced to maximize low-frequency performance. A 14-gauge stainless steel grille, backed with open cell foam and stainless steel mesh, provides excellent protection in the harshest environments. The systems are equipped with a 400W 70/100V transformer. A heavy-duty U-type mounting bracket is included and allows for easy installation on flat surfaces or in 90° corners.

AW SERIES ALL WEATHER

- Weather-resistant, all fibreglass enclosure
- Differential Drive® low frequency driver
- U-Type mounting bracket included
- Variety of coverage patterns for versatile installation use
- Available in -LS model for EN54-24 compliance
- Available in Black or Light Grey

AW266/AW266-LS
AW295/AW295-LS

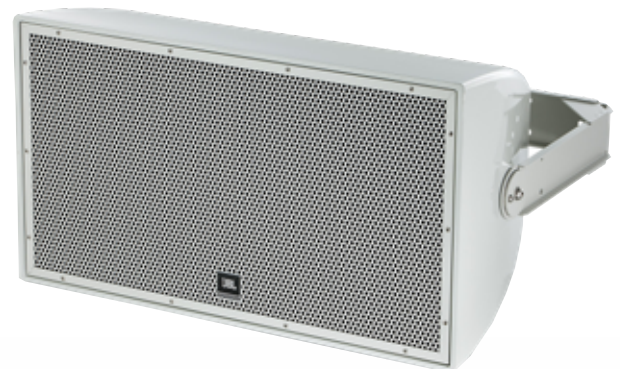

AW526/AW526-LS
AW566/AW566-LS
AW595/AW595-LS



AW266

HIGH POWER 300MM (12") TWO-WAY FULL-RANGE ALL-WEATHER LOUDSPEAKER

- Dispersion: 60°x 60° HxV
- Response: 40Hz-20kHz
- Sensitivity: 98dB, CD, WG, R
- Power: 500Ww 8Ω (400W Tx)
- Environmental: IP-55
- Available in Black or Light Grey

Also available: Control AW266-LS – EN54-24 Certified for life safety applications



AW295

HIGH POWER 300MM (12") TWO-WAY FULL-RANGE ALL-WEATHER LOUDSPEAKER

- Dispersion: 90°x 50° HxV
- Response: 40Hz-20kHz
- Sensitivity: 98dB, CD, WG, R
- Power: 500W 8Ω (400W Tx)
- Environmental: IP-55
- Available in Black or Light Grey

Also available: Control AW295-LS – EN54-24 Certified for life safety applications



AW526

HIGH POWER 380MM (15") TWO-WAY FULL-RANGE ALL-WEATHER LOUDSPEAKER

- Dispersion: 120°x 60° HxV
- Response: 35Hz-20kHz
- Sensitivity: 98dB, CD, WG, R
- Power: 600W 8Ω (400W Tx)
- Environmental: IP-55
- Available in Black or Light Grey

Also available: Control AW526-LS – EN54-24 Certified for life safety applications



AW566

HIGH POWER 380MM (15") TWO-WAY FULL-RANGE ALL-WEATHER LOUDSPEAKER/ROTATABLE HORN

- Dispersion: 60°x 60° HxV
- Response: 35Hz-20kHz
- Sensitivity: 98dB, CD, WG, R
- Power: 600W 8Ω (400W Tx)
- Environmental: IP-55
- Available in Black or Light Grey

Also available: Control AW566-LS – EN54-24 Certified for life safety applications



AW595

HIGH POWER 380MM (15") TWO-WAY FULL-RANGE ALL-WEATHER LOUDSPEAKER/ROTATABLE HORN

- Dispersion: 90°x 50° HxV
- Response: 35Hz-20kHz
- Sensitivity: 98dB, CD, WG, R
- Power: 600W 8Ω (400W Tx)
- Environmental: IP-55
- Available in Black or Light Grey

Also available: Control AW595-LS – EN54-24 Certified for life safety applications



JBL CWT Series.

EXTREMELY WIDE-ANGLE COVERAGE LOUDSPEAKER SYSTEM



CWT SERIES

CROSSFIRED WAVEGUIDE TECHNOLOGY

To provide high quality, full bandwidth sound evenly dispersed across a coverage area greater than 100°, often two speaker systems are mounted and splayed to achieve wider horizontal coverage. But this approach produces interference where the coverage patterns overlap resulting in uneven sound fields and compromised intelligibility. JBL engineers created an innovative solution to this problem: the CWT128 loudspeaker system featuring CWT Crossfired Waveguide Technology. Drawing on its vast experience in the art and science of loudspeaker technology, JBL continually sets new standards for the audio industry while creating elegant solutions for the challenges that face all sound professionals.

CWT128 HIGH OUTPUT DUAL 200MM (8") LOUDSPEAKER SYSTEM

The CWT128 is a compact full-range system with dual 209mm (8") SFG drivers and a 1" exit compression driver. It is designed to provide maximum bandwidth and SPL in a single package system. Available in Black or White.

- Dispersion: 160°x 60° HxV
- Response: 71Hz-20kHz
- Sensitivity: 94dB, CD, WG
- Power: 450W 8Ω (110W Tx)
- Environmental: IP-X3, Optional IP-55 or IP-56
- Suspension: M8 x4, M10 x4

Crossfire Waveguide Technology

At the heart of the CWT128 is the CWT Waveguide featuring a wide coverage pattern designed to provide seamless horizontal coverage across a full 160°. Based on JBL patented technology, the CWT Waveguide is essentially split in half and loaded with two compression drivers facing in different directions. The waveguide delivers wide angle coverage in a single enclosure, exhibiting no interference, and providing remarkable off-axis response. By eliminating multiple sets of speakers that interfere with each other, the overall fidelity of the system is greatly improved, intelligibility is increased, and a more pleasant listening experience is provided for the audience.

JBL PD500 Series.

LARGE FORMAT LOUDSPEAKERS 380MM (15") HORN-LOADED FULL-RANGE LOUDSPEAKER SYSTEM

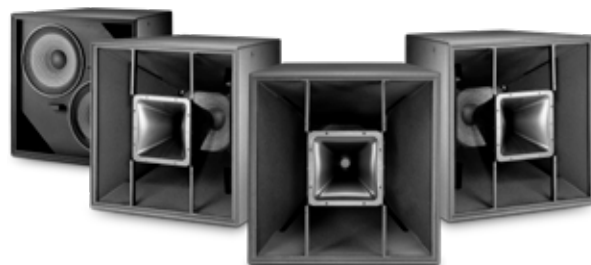

The PD500 Series is a line of loudspeaker systems consisting of four horn-loaded 380mm (15") 2-way systems and one dual 380mm (15") subwoofer. The Series includes horn coverage patterns of 40° x 40°, 60° x 40°, 60° x 60°, and 90° x 50°.

These systems utilise JBL Progressive Transition™ (PT) waveguides coupled with the 2432H 38mm (1.5") exit, 75mm (3") voice coil compression driver and the 2031H 380mm (15") low frequency transducer that features high sensitivity and low power compression for high continuous SPL capability. It is horn-loaded for additional sensitivity and improved pattern control. The 60° x 40° and 90° x 50° waveguides are rotatable allowing all models to be utilised in either vertical or horizontal orientation. The loudspeaker can be operated in either bi-amplified or in full passive mode. All models are available with JBL Professional WRC weather protection and WRX extreme weather protection finishes. All four full-range models are EN54-24 certified when used in full-range (not bi-amp) model.



Horizontal Array

Vertical Stack



Vertical Array



PD544

- Dispersion: 40°x 40° HxV
- Response: 50Hz-20kHz
- Sensitivity: 106dB, CD, WG, R

- Power: 300W 8Ω (Bi-Amp Switchable)
- Environmental: IP-X3, Optional IP-55 or IP-56
- Suspension: M10 x20
- Available in Black and White

PD566

- Dispersion: 60°x 60° HxV
- Response: 50Hz-20kHz
- Sensitivity: 104dB, CD, WG, R

- Power: 300W 8Ω (Bi-Amp Switchable)
- Environmental: IP-X3, Optional IP-55 or IP-56
- Suspension: M10 x20
- Available in Black and White

PD564

- Dispersion: 60°x 40° HxV
- Response: 50Hz-20kHz
- Sensitivity: 105dB, CD, WG, R

- Power: 300W 8Ω (Bi-Amp Switchable)
- Environmental: IP-X3, Optional IP-55 or IP-56
- Suspension: M10 x20
- Available in Black and White

PD595

- Dispersion: 90°x 50° HxV
- Response: 50Hz-20kHz
- Sensitivity: 104dB, CD, WG, R

- Power: 300W 8Ω (Bi-Amp Switchable)
- Environmental: IP-X3, Optional IP-55 or IP-56
- Suspension: M10 x20
- Available in Black and White

PD525S

HIGH OUTPUT, DUAL 380MM (15") LOW-FREQUENCY SUBWOOFER LOUDSPEAKER

The PD525S is a high power low frequency loudspeaker comprised of two 380mm (15") Dual Coil - Dual Gap Differential Drive® low frequency drivers in a front-loaded, vented configuration. The trapezoidal cabinet is fitted with M10 threaded suspension points. Available in Black and White.

- Response: 28Hz-3.8kHz
- Sensitivity: 102dB @ 40Hz-1000Hz
- Power: 500W 8Ω x2, 1000w 4Ω
- Environmental: IP-X3, Optional IP-55 or IP-56
- Suspension: M10 x20



JBL PD6000 Series.

PRECISION DIRECTIVITY LARGE FORMAT LOUDSPEAKERS

The PD6000 Series joins JBL's broad lineup of installed sound loudspeakers, complementing the larger PD700 mid-high cabinets with a more compact size and supplementing the smaller AE Series cabinets with higher SPL capability and larger horns for pattern control to a lower frequency. The PD6000 Series loudspeakers deliver high power and constant coverage in a low profile form. Featured across the PD6000 Series, newly developed 24 x 24" PT™ Progressive Transition mid-frequency rotatable waveguides that provide versatility, excellent pattern control with low distortion and extremely natural sound character. This is an evolution of the waveguide technology of the successful JBL Professional Application Engineered™ (AE) install series. Also incorporating sophisticated, steep-slope passive crossover networks minimise band overlap, further enhancing off-axis pattern control. User accessible internal switches allow for a fully active crossover. Optional Weather Protection treatment is available.

PD6200

200MM (8") HIGH-OUTPUT MID-HIGH LOUDSPEAKER SYSTEM

- Response: 200Hz-18kHz
- Sensitivity: 109dB, CD, WG, R
- Power: 300W 8Ω (Bi-Amp Switchable)
- Environmental: IP-X3, Optional IP-55 or IP-56
- Suspension: M10 x20
- Black DuraFlex™ finish, available in White on request

- Available models:
 - PD6200/43 (40° x 30°)
 - PD6200/64 (60° x 40°)
 - PD6200/66 (60° x 60°)
 - PD6200/95 (90° x 50°)



PD6212

300mm (12") FULL-RANGE TWO-WAY LOUDSPEAKER SYSTEM

- Response: 80Hz-18kHz
- Sensitivity: 106dB, CD, WG, R
- Power: 300W 8Ω (Bi-Amp Switchable)
- Environmental: IP-X3, Optional IP-55 or IP-56
- Suspension: M10 x20
- Black DuraFlex™ finish, available in White on request

- Available models:
 - PD6212/43 (40° x 30°)
 - PD6212/64 (60° x 40°)
 - PD6212/66 (60° x 60°)
 - PD6212/95 (90° x 50°)



PD6322

DUAL 300MM (12") FULL-RANGE THREE WAY LOUDSPEAKER SYSTEM

- Response: 41Hz-17kHz
- Sensitivity: LF 96dB, MHF 109dB, CD, WG, R
- Power: LF 1200W 4Ω, MHF 300W 8Ω (Tri-Amp Switchable)
- Environmental: IP-X3, Optional IP-55 or IP-56
- Suspension: M10 x20
- Black DuraFlex™ finish, available in White on request

- Available models:
 - PD6322/43 (40° x 30°)
 - PD6322/64 (60° x 40°)
 - PD6322/66 (60° x 60°)
 - PD6322/95 (90° x 50°)



PD5122

DUAL 300MM (12") HIGH-POWER LOW FREQUENCY MODULE

The PD5122 is intended for use as a flown or ground supported, high power low frequency module used in conjunction with mid/high-only or fullrange systems of the PD5000 series. Black DuraFlex™ finish, available in White on request.

- Response: 41Hz-1kHz
- Sensitivity: 96dB @ 60Hz-250Hz
- Power: 600W 8Ω x2, 1200W 4Ω
- Environmental: IP-X3, Optional IP-55 or IP-56
- Suspension: M10 x20



PD5125

DUAL 380MM (15") HIGH-POWER LOW FREQUENCY MODULE

The PD5125 is a high power low frequency loudspeaker comprised of two 380mm (15") VGC™ Vented Gap Cooled low frequency drivers in a front-loaded, vented configuration. The trapezoidal cabinet is fitted with M10 threaded suspension points. Black DuraFlex™ finish, available in White on request.

- Response: 37Hz-2.5kHz
- Sensitivity: 103dB @ 50Hz-125Hz
- Power: 600W 8Ω x2, 1200W 4Ω
- Environmental: IP-X3, Optional IP-55 or IP-56
- Suspension: M10 x20



JBL PD700i Series.

PRECISION DIRECTIVITY DUAL-TRAP

One of the challenges in large arenas, stadiums, houses of worship and performance spaces is to provide quality sound to every seat with the volume and clarity demanded by today's sporting events, concerts, and special events. The Precision Directivity™ (PD700i and PD700i-215) line of speakers provides exactly that. The PD700i models are greatly improved over their hugely successful predecessors, the PD700 Series, with upgraded mid-frequency and high-frequency components. Two new additions further enhance the capabilities of system designers by adding full-range capabilities by adding two low-frequency drivers to the mid-high models. This allows contractors and consultants to design a fully integrated sound system that solves the audio challenges inherent to these types of large installations. Optional Weather Protection treatment is available.

PD743i

VERY HIGH OUTPUT MID-HIGH LOUDSPEAKER SYSTEM

The PD743i Precision Directivity™ loudspeaker provides high-impact sound reinforcement at throw distances that are beyond the reach of traditional single-driver designs. A single module produces greater than 104dB SPL (continuous) at distances of 50m (165 ft). The PD764i-215 may be used in clusters with other PD family modules or singly as part of a distributed system. Black DuraFlex™ finish, available in White on request.

- Dispersion: 40°x 30° HxV
- Response: 200Hz-19.5kHz
- Sensitivity: 110dB, CD, WG
- Power: 400W 4Ω
- Environmental: IP-X3, Optional IP-55 or IP-56
- Suspension: M10 x32



PD743i-215

VERY HIGH OUTPUT FULL-RANGE LOUDSPEAKER SYSTEM

- Dispersion: 40°x 30° HxV
- Response: 36.5Hz-19.5kHz
- Sensitivity: LF 103dB, MHF 110dB, CD, WG
- Power: LF 1000W 4Ω, MHF 400W 4Ω (Tri-Amp Switchable)
- Environmental: IP-X3, Optional IP-55 or IP-56
- Suspension: M10 x52
- Black DuraFlex™ finish, available in White on request



PD764i

VERY HIGH OUTPUT MID-HIGH LOUDSPEAKER SYSTEM

The PD764i-215 Precision Directivity™ loudspeaker provides high-impact sound reinforcement at throw distances that are beyond the reach of single-driver designs. A single module produces greater than 104dB SPL (continuous) at distances of 50m (165 ft). The PD764i-215 may be used in clusters with other PD family modules or singly as part of a distributed system. Black DuraFlex™ finish, available in White on request.

- Dispersion: 60°x 40° HxV
- Response: 200Hz-19.5kHz
- Sensitivity: 110dB, CD, WG
- Power: 400W 4Ω
- Environmental: IP-X3, Optional IP-55 or IP-56
- Suspension: M10 x28



PD764i-215

VERY HIGH OUTPUT FULL-RANGE LOUDSPEAKER SYSTEM

- Dispersion: 60°x 40° HxV
- Response: 36.5Hz-19.5kHz
- Sensitivity: LF 103dB, MHF 110dB, CD, WG
- Power: LF 1000W 4Ω, MHF 400W 4Ω (Tri-Amp Switchable)
- Environmental: IP-X3, Optional IP-55 or IP-56
- Suspension: M10 x52
- Black DuraFlex™ finish, available in White on request



JBL LINE ARRAY SPEAKERS.



JBL VLAi Series.

LARGE FORMAT VARIABLE LINE ARRAY SPEAKERS

JBL VLAi Series includes six large format horn-loaded modules with three horizontal horn coverage patterns (30°, 60°, and 90°). This horn-loaded modular concept provides the designer additional flexibility to vary the horizontal pattern within a vertical array by incorporating different modules with wider or narrower coverage patterns while still maintaining vertical directivity.

The JBL VLAi Series uses proven JBL components with patented Differential Drive® technology. The mid and high frequency sections are horn-loaded for maximum sensitivity and optimum pattern control. The midrange section features 2169H cone midrange compression drivers with an 8" cone diameter and dual 3" voice coils. The high-frequency section features large format 2432H compression drivers with 3" voice coil. The low-frequency section features JBL's 2265H-I Differential Drive® dual voice coil dual gap 15" woofer. This woofer features neodymium magnet and ultra-robust cone for extra-long life.

Enclosures feature 16mm (5/8") exterior grade 12-ply birch plywood. Grills are powder coated 14 gauge acoustically transparent perforated steel. For outdoor applications JBL offers two standard levels of weather resistance. WRC is for outdoor placement where the loudspeaker will be sheltered from direct exposure. WRX is for direct exposure or more extreme environments.

VLA301i THREE-WAY FULL RANGE LOUDSPEAKER

- Dispersion: 30° x 5° HxV (Varies with array length)
- Response: 39Hz-19kHz
- Sensitivity: LF 99dB, MF 105dB, HF 112dB, CD, WG
- Power: LF 1000W 4Ω, MF 400W 4Ω, HF 160W 16Ω
- Environmental: IP-X3, Optional IP-55 or IP-56
- Suspension: M10 x16
- Available in Black, available in White upon request

VLA601i THREE-WAY FULL RANGE LOUDSPEAKER

- Dispersion: 60° x 8° HxV (Varies with array length)
- Response: 41Hz-20kHz
- Sensitivity: LF 99dB, MF 107dB, HF 111dB, CD, WG
- Power: LF 1000W 4Ω, MF 400W 4Ω, HF 160W 16Ω
- Environmental: IP-X3, Optional IP-55 or IP-56
- Suspension: M10 x16
- Available in Black, available in White upon request

VLA901i THREE-WAY FULL RANGE LOUDSPEAKER

- Dispersion: 90° x 10° HxV (Varies with array length)
- Response: 41Hz-20kHz
- Sensitivity: LF 98dB, MF 106dB, HF 109dB, CD, WG
- Power: LF 1000W 4Ω, MF 400W 4Ω, HF 160W 16Ω
- Environmental: IP-X3, Optional IP-55 or IP-56
- Suspension: M10 x16
- Available in Black, available in White upon request

VLA301Hi HIGH OUTPUT VERSION

- Dispersion: 30° x 5° HxV (Varies with array length)
- Response: 39Hz-19kHz
- Sensitivity: LF 99dB, MF 112dB, HF 115dB, CD, WG
- Power: LF 1000W 4Ω, MF 550W 8Ω, HF 300W 4Ω
- Environmental: IP-X3, Optional IP-55 or IP-56
- Suspension: M10 x16
- Available in Black, available in White upon request

VLA601Hi HIGH OUTPUT VERSION

- Dispersion: 60° x 8° HxV (Varies with array length)
- Response: 41Hz-20kHz
- Sensitivity: LF 99dB, MF 104dB, HF 114dB, CD, WG
- Power: LF 1000w 4Ω, MF 550w 8Ω, HF 300w 4Ω
- Environmental: IP-X3, Optional IP-55 or IP-56
- Suspension: M10 x16
- Available in Black, available in White upon request

VLA901Hi HIGH OUTPUT VERSION

- Dispersion: 90° x 10° HxV (Varies with array length)
- Response: 41Hz-20kHz
- Sensitivity: LF 98dB, MF 102dB, HF 110dB, CD, WG
- Power: LF 1000w 4Ω, MF 550w 8Ω, HF 300w 4Ω
- Environmental: IP-X3, Optional IP-55 or IP-56
- Suspension: M10 x16
- Available in Black, available in White upon request

VLA Compact Series Line Array.

SMALL-FORMAT PROFESSIONAL SOUND SYSTEMS

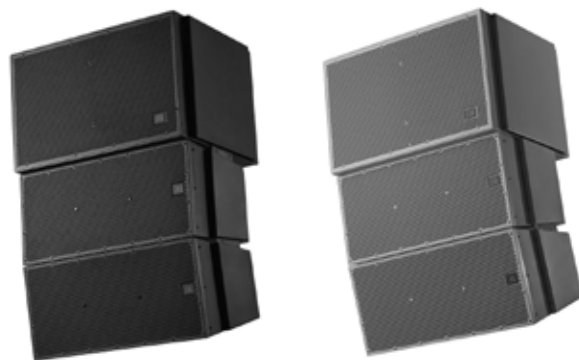

The Variable Line Array (VLA) Compact Series is a line array loudspeaker solution built upon the industry-leading VLA line array solution. Designed to fill the needs of system designers for installations requiring the long-throw capabilities of the VLA in a more compact line array solution, the VLA Compact offers advanced audio capabilities, out-of-the-box IP55-rated weather protection and a fibreglass enclosure for stadiums and arenas and any other project in need of compact, high-powered line arrays.

The modular design concept of the VLA Compact Series offers additional flexibility to vary the horizontal pattern within a vertical array by incorporating different modules with wider or narrower coverage patterns while still maintaining the vertical directivity. This provides the system designer the ability to build line array systems for large venue applications or to design smaller line array systems for use as distributed clusters in arenas, domed stadiums and larger performance spaces, including houses-of-worship.

VLA Compact is designed specifically for permanent installation applications requiring even coverage, high intelligibility and audio levels capable of overcoming crowd noise. As a fundamental design element, VLA Compact Series offers large format horn-loaded modules to provide broad bandwidth horizontal directivity and an increase in sensitivity. The full-range speakers include dual 2261 10" Differential Drive® 3" voice coil low frequency drivers, with 65° and 100° horizontal coverage options available. The VLA-C125S subwoofer has dual 2267H 15" Differential Drive® woofers.

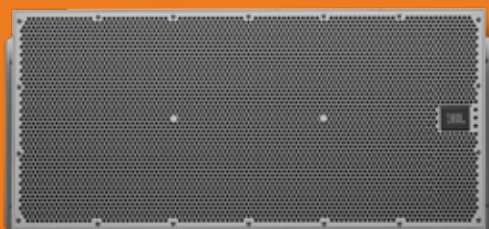

VLA-C2100

TWO-WAY FULL RANGE LOUDSPEAKER WITH 2 X 10" DIFFERENTIAL DRIVE® LF

The VLA-C2100 uses JBL proven technology components. The high frequency section is horn-loaded for maximum sensitivity and optimum pattern control and features three D2415 drivers featuring 1.5" diameter annular diaphragms, 1.5" voice coils, and neodymium motors. The low-frequency section utilises dual 2261 10" Differential Drive® 3" voice coil drivers. Enclosures feature multi-layer reinforced fibreglass and steel end-panels. Grilles are zinc plated, powder coated 14-gauge perforated steel with an acoustically transparent Black grille cloth backing, a hydrophobic mesh underlayer, and a waterproof rail system. The rigging system

is inherent to the design of the system. Inter-box angles are selected when the array is assembled. Other accessories include a rigging frame, pull-back bar, and a cardioid kit for the sub. Available in Black and Grey.

- Dispersion: 100° x 15° HxV (Varies with array length)
- Response: 86Hz-18kHz
- Sensitivity: 102dB, CD, WG
- Power: 400W 8Ω (Bi-Amp Switchable)
- Environmental: IP-55
- Suspension: M10 x8 (array rigging included)



VLA-C265

TWO-WAY FULL RANGE LOUDSPEAKER WITH 2 X 10" DIFFERENTIAL DRIVE® LF

The VLA-C265 uses JBL proven technology components. The high frequency section is horn-loaded for maximum sensitivity and optimum pattern control and features three D2415 drivers featuring 1.5" diameter annular diaphragms, 1.5" voice coils, and neodymium motors. The low-frequency section utilises dual 2261 10" Differential Drive® 3" voice coil drivers.

Enclosures feature multi-layer reinforced fibreglass and steel end-panels. Grilles are zinc plated, powder coated 14-gauge perforated steel with an acoustically transparent black grille cloth backing, a hydrophobic mesh underlayer, and a waterproof rail system.

The rigging system is inherent to the design of the system. Inter-box angles are selected when the array is assembled. Other accessories include a rigging frame, pull-back bar, and a cardioid kit for the sub. Available in Black and Grey.

- Dispersion: 65° x 10° HxV (Varies with array length)
- Response: 85Hz-19kHz
- Sensitivity: 102dB, CD, WG
- Power: 400W 8Ω (Bi-Amp Switchable)
- Environmental: IP-55
- Suspension: M10 x8 (array rigging included)



VLA-C125S

DUAL 380MM (15") SUBWOOFER WITH DIFFERENTIAL DRIVE®

The VLA-C125S uses JBL proven technology components, featuring dual 380mm (15") Differential Drive® transducers. Enclosures feature multi-layer reinforced fibreglass and steel end-panels. Grilles are zinc plated, powder coated 14-gauge perforated steel with an acoustically transparent Black grille cloth backing, a hydrophobic mesh underlayer, and a waterproof rail system.

The rigging system is inherent to the design of the system. Inter-box angles are selected when the array is assembled. Other accessories include a rigging frame, pull-back bar, and a cardioid kit. Available in Black and Grey.

- Response: 52Hz-210Hz
- Sensitivity: 98dB
- Power: 800W 8Ω
- Environmental: IP-55
- Suspension: M10 x8 (array rigging included)

JBL VRX900 Series.

SMALL-FORMAT PROFESSIONAL SOUND SYSTEMS

Delivering extraordinary power handling, clarity and flexibility, the VRX900 Series Constant Curvature line array loudspeakers feature the hallmark of all JBL products—stunning, legendary JBL sound. Designed to address the growing need for a small-format professional sound system, JBL developed the VRX900 Series for sound rental companies and fixed installations, along with musicians and DJ's looking for the ultimate in performance and portability. Providing the performance of high end line arrays in compact 8- and 12-inch formats, including a powered 12-inch format, VRX900-Series solutions are affordable, flexible and offer outstanding coverage and coherence.

Leveraging technology and components from the JBL VERTEC® Series line arrays, but with a more compact form factor, the VRX900 Series is perfectly suited for use in smaller venues and small to medium sound reinforcement projects. Despite their smaller-scale applications, VRX900 Series Constant Curvature Line Arrays are designed and built to the same high standards as the VERTEC line and uses the same advanced, concert-proven drivers. JBL's VRX900 Series speakers deliver extraordinary power handling, clarity, flexibility and, of course, stunning JBL sound in an attractive, easy to handle and affordable package.



- Constant curvature line array system for an easy to use controlled, coherent coverage pattern.
- High performance, lightweight neodymium Differential Drive Woofers
- Powered by high performance, ultra-compact Crown Class-D amplification
- Simplified rigging and quick connections ensure fast setup and takedown
- Constructed with premium birch plywood and coated in JBL's rugged DuraFlex finish
- VRX Array Tool available for the user to understand and properly deploy the array.

VRX915M

380MM (15") TWO-WAY FLOOR MONITOR

Dedicated, compact and lightweight 380mm two-way touring class floor monitor using JBL's latest neodymium transducers. Available in Black DuraFlex™.



- Dispersion: 50°x 90° HxV
- Response: 60Hz-20kHz
- Sensitivity: 98dB, CD, WG
- Power: 600W* 8Ω (Bi-Amp Switchable)

VRX915S

380MM (15") COMPACT HIGH POWER SUSPENDABLE SUBWOOFER

The VRX915S is a compact, high power suspendable subwoofer system containing a 2265G-1 neodymium magnet, patented Differential Drive®, 15" woofer in a front-loaded, vented enclosure. Available in Black DuraFlex™.



- Arrays with VRX928LA
- Response: 35Hz-250Hz
- Sensitivity: 91dB
- Power: 800W* 4Ω
- Suspension: Integrated array rigging or M10 x8. M20 pole socket

VRX928LA**200MM (8") TWO-WAY COMPACT LINE ARRAY SPEAKER SYSTEM**

Designed for use in arrays of up to six units. Ideal when line array performance is needed but the venue size doesn't call for the very long-throw characteristics of the larger VRX932LA. Available in Black DuraFlex™.



- Dispersion: 100° x 15° HxV (Varies with array length)
- Response: 70Hz-20kHz
- Sensitivity: 90dB, CD, WG
- Power: 400W* 8Ω (Bi-Amp Switchable)
- Suspension: Integrated array rigging or M10 x4 Dual angle pole socket†

VRX932LA-1**300MM (12") TWO-WAY COMPACT LINE ARRAY SPEAKER SYSTEM**

Lightweight compact and designed for use in arrays of up to six units. Available in Black DuraFlex™.



- Dispersion: 100° x 15° HxV (Varies with array length)
- Response: 57Hz-20kHz
- Sensitivity: 95dB, CD, WG
- Power: 800Ww* 8Ω (Bi-Amp Switchable)
- Suspension: Integrated array rigging or M10 x4. Dual angle pole socket

VRX932LAP**300MM (12") TWO-WAY COMPACT LINE ARRAY SPEAKER SYSTEM**

Powered version of VRX932LA-1. Available in Black DuraFlex™.



- Dispersion: 100° x 15° HxV (Varies with array length)
- Response: 57Hz-20kHz
- Power: 1750-watts Peak, 875-watts Continuous, Class D
- Suspension: Integrated array rigging or M10 x4. Dual angle pole socket

VRX918S**457MM (18") COMPACT HIGH POWER SUSPENDABLE SUBWOOFER**

The VRX918S is a compact, high power suspendable subwoofer system containing a 2268H neodymium magnet, patented Differential Drive®, 18" woofer in a front-loaded, vented enclosure. Available in Black DuraFlex™.



- Arrays with VRX932LA
- Response: 31Hz-250Hz
- Sensitivity: 95dB
- Power: 800W* 8Ω
- Suspension: Integrated array rigging or M10 x4 M20 pole socket

VRX918SP**457MM (18") POWERED HIGH POWER SUSPENDABLE SUBWOOFER**

The VRX918SP is a powered, suspendable subwoofer system containing a 2268FF neodymium magnet, patented Differential Drive®, 18" woofer in a front-loaded, vented enclosure. The VRX918SP was designed specifically for use in arrays with the VRX932LAP Line Array speaker and VRX-AF Array Frame. In addition it may also be used in arrays consisting entirely of VRX918SP subwoofers. Available in Black DuraFlex™.



- Arrays with VRX932LAP
- Response: 31Hz-250Hz
- Power: 1500W Peak, 750W Continuous, Class D
- Suspension: Integrated array rigging or M10 x4. M20 pole socket

*2 Hour IEC with 6dB Crest.

INSTALLABLE PORTABLE PA SPEAKERS.

The road to the top is long and difficult. You need a PA system that is built to take it. Before you ever plug it in, the EON600 endures JBL's legendary testing protocol, including 100 hours of playback at full power, and extreme environmental and drop tests. Sturdy cabinet materials, heavy-gauge grills, and genuine JBL transducers ensure that the EON600 delivers exceptional sound for the long haul, gig after gig. Plus, integrated Bluetooth capability gives you convenient and simple wireless control.



JBL EON600 Series.

ADVANCED ACOUSTIC TECHNOLOGY

Revolutionary Waveguides

JBL's Image Control Waveguide offers unprecedented detail, incredible high-frequency clarity and vivid imaging in nearly any acoustic environment. Its revolutionary design results in remarkably consistent sound and intelligibility over an expansive 110° coverage pattern. Optimised enclosure designs result in a considerable increase in cabinet volume for more robust acoustic results. Moreover, we design and manufacture our own transducers to the most stringent tolerances for only the best performance, every time.

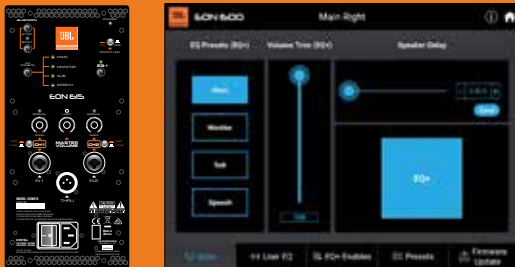

EON Connect App

EON Connect is a smart device application for controlling up to four JBL EON600 speakers via the EON's built-in bluetooth functionality. EON600's DSP parameters, which include 3 PEQs, a Hi and Lo Shelf, delay, output mixing, and preset creation are available exclusively through this app. Additionally, users can update their speakers' firmware using EON Connect.

EON600 is a true step forward in technology developed specifically to deliver the best sound possible regardless of its application. Completely rethinking how truly good an affordable self-contained, portable PA system can be, JBL engineers purposely designed and built the EON600 from the ground up featuring JBL's advanced waveguide technology, JBL designed and manufactured transducers, and convenient, wireless remote control of its onboard DSP EQ parameters via Bluetooth. This total redesign of the EON platform leverages the latest technologies in cabinet materials, acoustic science, transducer design and user friendliness that delivers the extraordinary quality of a high-end studio monitor in a fully professional, highly flexible, easy to use, portable system for today's working musicians and sound providers.

- 1000W high performance Class-D amplifier technology
- JBL designed transducers
- 25mm (1") JBL annual polymer diaphragm, neodymium compression driver
- Professional looking, utility-driven cabinet design
- Road tough enclosure with baffles protecting the grille and the back panel
- JBL Image Control Waveguide and Pattern Control Aperture deliver uniform coverage and high intelligibility throughout the entire coverage area
- 4 application based EQ presets - Main, Monitor, Speech and for use with a Subwoofer





EON610
250MM (10") TWO-WAY POWERED LOUDSPEAKER SYSTEM

The EON610 is a lightweight loudspeaker system capable of full bandwidth sound reproduction at high levels. Weighing only 11.8kg the EON610 is a fantastic solution when high quality sound is needed in many varying applications. With the Bluetooth App, the speakers can be optimised for use in various settings and users can recall those settings instantly the next time around. Available in Black.

- Dispersion: 110° x 60° HxV
- Response: 52Hz-20kHz
- Power: 1000W Peak, 500W Continuous, Class D
- Suspension: M10 x3. Pole socket



EON612
300MM (12") TWO-WAY POWERED LOUDSPEAKER SYSTEM

The EON612 is a multipurpose self-powered sound reinforcement speaker that is perfect for monitoring, side fills, and speech reinforcement. With four application presets that are available right from the back panel, the EON612 allows users to deploy the product wherever high quality sound is needed. Available in Black.

- Dispersion: 110° x 60° HxV
- Response: 48Hz-20kHz
- Power: 1000W Peak, 500W Continuous, Class D
- Suspension: M10 x3. Pole socket



EON615
380MM (15") TWO-WAY POWERED LOUDSPEAKER SYSTEM

The EON615 is a powerful portable loudspeaker that delivers high performance sound reinforcement in an acoustically optimised durable enclosure. Perfect for performing musicians, DJs, Houses of Worship, Clubs and so many others, the EON615 represents the next step forward in portable loudspeaker technology. Available in Black.

- Dispersion: 90° x 50° HxV
- Response: 39Hz-20kHz
- Power: 1000W Peak, 500W Continuous, Class D
- Suspension: M10 x3. Pole socket



EON618S
457MM (18") SELF POWERED SUBWOOFER

The EON618S is a powered portable PA subwoofer in the EON600 series from JBL Professional. It has been designed to deliver class leading performance in a variety of applications supporting EON600 and other full range systems. A lightweight, highly useful enclosure allows the speaker to be easily transported and set up wherever low frequency reinforcement is needed. Available in Black.

- Response: 31Hz-150kHz
- Power: 1000W Peak, 500W Continuous, Class D
- Suspension: M20 pole socket



JBL PRX400 Series.

PORTABLE PASSIVE LOUDSPEAKERS

PRX400 passive speakers were designed to provide the sensitivity, frequency response and power handling needed for almost any professional audio environment while still being reasonably priced. Whether you use a powered mixer or an equipment rack full of amps and signal processing, PRX400 passive speakers deliver the sound, power and bandwidth necessary to make loud music sound natural and even quiet speech intelligible. Utilising poplar and birch enclosures as well as JBL's rugged DuraFlex coating, these speakers are road tough and ready to perform in any environment.



PRX412M

300MM (12") TWO-WAY POWERED STAGE MONITOR

PRX412M is a portable, 300mm (12"), two-way speaker system designed for either main sound reinforcement or monitoring applications. Black or White DuraFlex™ finish.

- Dispersion: 90° x 50° HxV
- Response: 50Hz-20kHz
- Sensitivity: 95dB, CD, WG
- Power: 300W* 8Ω
- Suspension: M10 x12. Dual angle pole socket.



PRX415M

380MM (15") TWO-WAY PASSIVE STAGE MONITOR & LOUDSPEAKER SYSTEM

PRX415M is a portable, 380mm (15"), two-way speaker system designed for either main sound reinforcement or monitoring applications. Black or White DuraFlex™ finish.

- Dispersion: 90° x 50° HxV
- Response: 55Hz-20kHz
- Sensitivity: 98dB, CD, WG
- Power: 300W* 8Ω
- Suspension: M10 x12. Dual angle pole socket.



PRX425

380MM (15") TWO-WAY LOUDSPEAKER SYSTEM

PRX425 dual 380mm (15"), two-way is the perfect choice for DJ's and bands who need low-frequency extension from the convenience of a stand-alone cabinet. Black DuraFlex™ finish.

- Dispersion: 90° x 50° HxV
- Response: 48Hz-20kHz
- Sensitivity: 98dB, CD, WC
- Power: 600w* 4Ω
- Suspension: M10 x12



PRX418S

457MM (18") PASSIVE SUBWOOFER SYSTEM

PRX418S is an 457mm (18") subwoofer which, when combined with the two-way models, provides a sub/sat system capable of generating 135 dB of full-range, high quality audio. Black DuraFlex™ finish.

- Response: 35Hz-250Hz
- Sensitivity: 95dB
- Power: 800w* 8Ω
- Suspension: Pole socket



*2 Hour IEC with 6dB Crest.

JBL PRX800 Series.

POWERED SMALL FORMAT PA SPEAKERS

With the JBL PRX800-series, we've channeled 70-years of design experience for the world's largest stages, to create the loudest portable speakers in their class. At JBL, we believe great speakers are more than just loud – so PRX800 are engineered for clear, detailed response – even at peak SPLs. With tour grade components along with strict product validation including JBL's 100-hour full power testing, PRX800 are rugged enough to keep performing for the long haul. And with built-in Wi-Fi, the PRX-Connect app, and the new V2 firmware update, you'll set up and experience the best sound PRX800 has to offer, faster than ever.

PRX812

300MM (12") TWO-WAY FULL-RANGE MAIN SYSTEM/FLOOR MONITOR WITH WI-FI

The PRX812 is a full-range speaker designed for main system and floor monitor applications. Featuring a 12", two-way, bass-reflex design powered by a 1500-watt class-D amplifier, PRX812 delivers incredible volume in a lightweight and compact form factor.

Available in Obsidian DuraFlex™ finish.

- Dispersion: 90° x 50° HxV
- Response: 45Hz-20kHz
- Power: 750-watts x2, Class D, Bi-Amp
- Suspension: M10 x12. Dual angle pole socket



PRX815

380MM (15") TWO-WAY FULL-RANGE MAIN SYSTEM/FLOOR MONITOR WITH WI-FI

The PRX815 is a full-range speaker designed for main system and floor monitor applications. Featuring a 15", two-way, bass-reflex design powered by a 1500-watt class-D amplifier, PRX815 delivers incredible volume in a lightweight and compact form factor.

Available in Obsidian DuraFlex™ finish.

- Dispersion: 90° x 50° HxV
- Response: 43Hz-19kHz
- Power: 750-watts x2, Class D, Bi-Amp
- Suspension: M10 x12. Dual angle pole socket



PRX815XLF

380MM (15") SELF POWERED EXTENDED LF SUBWOOFER SYSTEM WITH WI-FI

A self-powered extended low-frequency subwoofer system. Featuring a JBL 15" woofer powered by a 1500W class-D amplifier, PRX815XLF delivers incredible output in a lightweight and compact form factor. Available in Obsidian DuraFlex™ finish.

- Response: 36Hz-103Hz
- Power: 1500-watts, Class D



PRX818XLF

457MM (18") SELF POWERED EXTENDED LF SUBWOOFER SYSTEM WITH WI-FI

A self-powered extended low-frequency subwoofer system. Featuring a JBL 18" woofer powered by a 1500W class-D amplifier, PRX818XLF delivers incredible output in a lightweight and compact form factor. Available in Obsidian DuraFlex™ finish.

- Response: 30Hz-103Hz
- Power: 1500-watts, Class D



PRX825

DUAL 380MM (15") TWO-WAY FULL RANGE MAIN SYSTEM WITH WI-FI

A full-range speaker designed for main system applications. Featuring a dual 380mm (15"), two-way, bass-reflex design powered by a 1500W class-D amplifier, PRX825 delivers incredible volume in a lightweight and compact form factor. Available in Obsidian DuraFlex™ finish.

- Dispersion: 90° x 50° HxV
- Response: 40Hz-18kHz
- Power: 750-watts x2, Class D, Bi-Amp
- Suspension: M10 x9



PRX835

380MM (15") THREE-WAY FULL RANGE MAIN SYSTEM WITH WI-FI

A full-range speaker designed for main system applications. Featuring a 380mm (15") woofer, 6.5" midrange transducer, and 1.5" compression driver powered by a 1500W class-D amplifier, PRX835 delivers incredible volume in a lightweight and compact form factor. Available in Obsidian DuraFlex™ finish.

- Dispersion: 90° x 50° HxV
- Response: 34Hz-20kHz
- Power: 750-watts x2, Class D, Bi-Amp
- Suspension: M10 x12



JBL SRX800 Series.

PASSIVE & SELF POWERED LARGE FORMAT LOUDSPEAKER SYSTEMS

SRX800 Passive

This line of premium portable speakers deliver the best sound quality, power handling, and workmanship in it's class. Custom built, industry leading JBL transducers and enclosures give SRX800 the power and ruggedness to stand up to a variety of demanding applications.

JBL Professional has made a name for itself by producing great sounding, long lasting portable PA systems. With the incorporation of tunings available for Crown amplifiers and dbx signal processors, SRX800 is an optimal choice for a fully integrated Harman Professional sound system controlled through Audio Architect.

Integrating industry-leading levels of sound quality, power, control, and durability, SRX800 is a perfect all in one solution wherever high performance, comprehensive control, and pristine sound are required. Each component in the SRX800 Series was purposefully designed and thought through to deliver a perfectly tuned system that is powerful, easy to use, and rugged enough for the most demanding applications. M10 suspension points, indexed feet, and pole/ tripod mounts support a wide, flexible array of configurations.



SRX800 Powered

JBL Professional has made a name for itself by producing great sounding, long lasting portable PA systems. With the introduction of the SRX800 line of powered portable PA loudspeakers, JBL has set the standard for what a fully professional powered PA system should be. SRX800 breaks new ground, bringing together JBL's premium transducers and enclosures, Crown's Proprietary Front-End DriveCore Technology, user-configurable DSP, and full HiQnet Network control compatible with a variety of platforms. Integrating industry-leading levels of sound quality, power, control, and durability, SRX800 is a perfect all in one solution wherever high performance, comprehensive control, and pristine sound are required. Each component in the SRX800 Series was purposefully designed and thought through to deliver a perfectly tuned system that is powerful, easy to use, and rugged enough for the most demanding applications.

SRX812**300MM (12") TWO-WAY BASS REFLEX PASSIVE SYSTEM**

SRX812 is a two-way full range passive portable speaker with a 12" woofer made for use as a light-duty main PA, monitor, or rear or side fill. Tunings and presets are available for Crown I Tech HD. Available in Obsidian DuraFlex™ finish.

Also available: SRX812P Self Powered System with Crown amplification.

- Dispersion: 90° x 50° HxV
- Response: 50Hz-20kHz
- Sensitivity: 94dB, CD, WG
- Power: 300W* 8Ω (Bi-Amp Switchable)
- Suspension: M10 x12. Dual angle pole socket

**SRX815****380MM (15") TWO-WAY BASS REFLEX PASSIVE SYSTEM**

SRX815 is a two-way full range passive portable speaker with a 15" woofer made for use as a light-duty main PA, monitor, or rear or side fill. Tunings and presets are available for Crown I Tech HD. Available in Obsidian DuraFlex™ finish.

Also available: SRX815P Self Powered System with Crown amplification.

- Dispersion: 90° x 50° HxV
- Response: 50Hz-20kHz
- Sensitivity: 95dB, CD, WG
- Power: 800W* 8Ω (Bi-Amp Switchable)
- Suspension: M10 x12. Dual angle pole socket

**SRX835****380MM (15") THREE-WAY BASS REFLEX PASSIVE SYSTEM**

SRX835 is a three-way full range speaker with a 15" woofer made for use as a medium duty main PA, or rear or side fill. Tunings and presets are available for Crown I Tech HD. Available in Obsidian DuraFlex™ finish.

Also available: SRX835P Self Powered System with Crown amplification.

- Dispersion: 60° x 40° HxV
- Response: 32Hz-20kHz
- Sensitivity: 98dB, CD, WG
- Power: 800W* 8Ω
- Suspension: M10 x12. Pole socket

**SRX818S****457MM (18") PASSIVE SUBWOOFER SYSTEM**

SRX818S is a single 18" subwoofer for concert, touring, or installed use. Featuring a standard M20 pole cup for use with top boxes, indexing feet for stacking in both the standard and cardioid position, and a 136dB max SPL, the SRX818S is an ideal solution for musicians, bands, and DJs, concert use, public speaking, or in performance venues, corporate spaces, educational facilities or houses of worship. Tunings and presets are available for Crown I Tech HD. Available in Obsidian DuraFlex™ finish.

Also available: SRX812SP Self Powered System with Crown amplification.

- Response: 28Hz-150Hz
- Sensitivity: 95dB
- Power: 600W* 8Ω
- Suspension: M20 Pole socket

**SRX828S****457MM (18") DUAL SUBWOOFER**

SRX828S is a dual 18" subwoofer for concert, touring, or installed use. Featuring a wide stance for splaying top boxes, indexing feet for stacking in both the standard and cardioid position, and a 141dB max SPL, the SRX828S is an ideal solution for musicians, bands, and DJs, concert use, public speaking, or in performance venues, corporate spaces, educational facilities or houses of worship. Tunings and presets are available for Crown I Tech HD. Available in Obsidian DuraFlex™ finish.

Also available: SRX828P Self Powered System with Crown amplification.

- Response: 30Hz-150Hz
- Sensitivity: 98dB
- Power: 1200W* 4Ω
- Suspension: M20 Pole socket



*2 Hour IEC with 6dB Crest.

JBL BRX300 Series.

SELF POWERED MODULAR PORTABLE LINE ARRAY SYSTEM

The BRX300 Series is a versatile line array for bands, DJs, rental firms, houses of worship and anyone who needs a compact, portable system that provides superior fidelity, high output and consistent coverage in a range of sound-reinforcement scenarios.

The modular BRX300 Series makes the power of line array technology accessible to customers who are not trained audio engineers, thanks to its plug-and-play simplicity, built-in corrective signal processing, smart transport system and hassle-free rigging hardware. Deploy in minutes and enjoy optimal sound out of the box with components engineered for fidelity and ease of use.

Superior JBL Acoustics out of the Box

Professional JBL performance with high SPL capabilities and ultrawide 110° horizontal dispersion; built-in amplification and plug-and-play DSP for easy setup.

Modular & Scalable Configuration Options

System can be expanded as needed and supports up to 1 sub x 2 tops when pole-mounted, up to 1 sub x 4 tops when groundstacked or up to 2 ground-stacked subs x 8 tops when flown with the optional Array Frame.

Portable & Rugged

Subwoofer and optional Transporter Kit include casters for easy transport; tour-tested cabinets feature all-wood construction with a Duraflex coating that protects against wear and tear.

BRX308-2LA/BRX-308-4LA

SELF POWERED MODULAR PORTABLE LINE ARRAY SYSTEM

The BRX308-2LA and BRX308-4LA systems comprise the BRX308-LA Line Array Element and BRX325SP Powered Subwoofer, which draw from JBL's legendary touring technologies to deliver wide coverage and class-leading SPLs while reproducing every sonic detail with superior depth and clarity, thanks to proprietary drivers that are engineered for maximum performance matched with the BRX325SP's built-in amplifier.

Systems are available in minimum one-subwoofer/two-top (BRX308-2LA) or one-subwoofer/four-top (BRX308-4LA) configurations, or subwoofers and tops can be purchased separately. Supported mounting options include groundstacking, pole mounting or flying, providing seamless coverage in a range of applications. Available in a Matte Black Duraflex™ finish.

- 2x 308+325 in an array / 4x 308+325 in an array, individual product specs apply





BRX325-SP

MODULAR PORTABLE LINE ARRAY SUBWOOFER WITH 6-CHANNEL AMPLIFIER

The BRX325SP Powered Subwoofer draws from JBL's legendary touring technologies to deliver class-leading SPLs while reproducing every sonic detail with superior depth and clarity, thanks to proprietary drivers that are engineered for maximum performance matched with the BRX325SP's built-in amplifier. Available in a Matte Black Duraflex™ finish.

- Powered Sub Includes DSP & Power for up to 4x BRX308-LA
- Response: 32Hz-250Hz
- Power: BRX325SP 2000-watts, 4x BRX308-LA 4000-watts, Class D.
- Suspension: Integrated rigging for suspension or ground stack. Threaded pole socket



BRX308-LA

MODULAR PORTABLE LINE ARRAY SPEAKER

The BRX308-LA Line Array Element draws from JBL's legendary touring technologies to deliver wide coverage and class-leading SPLs while reproducing every sonic detail with superior depth and clarity, thanks to proprietary drivers that are engineered for maximum performance matched with the BRX325SP Powered Subwoofer's built-in amplifier. Available in a Matte Black Duraflex™ finish.

- Dispersion: 110° x 12° HxV (Varies with array length)
- Response: 80Hz-20kHz
- Sensitivity: TBC dB, CD, WG
- Power: Provided by multi-channel amplifier in BRX325SP
- Suspension: Integrated suspension frame rigging



ACCESSORIES

BRX308-ACC - Accessory kit including transporter and lid for 4 x BRX308LA, padded cover for transporter and BRX325SP, speaker cables

BRX308-AF - Array frame to suspend BRX325SP or 8 x BRX308-LA

BRX308-PM - Pole and adapter to mount 2 x BRX308-LA on BRX325SP subwoofer

STUDIO MONITORS.



JBL 3 Series MKII.

POWERED STUDIO MONITORS

The 3 Series Powered Studio Monitors are the first to incorporate JBL's groundbreaking Image Control Waveguide from our flagship M2 Master Reference Monitors. Unprecedented detail, imaging and depth clearly reveal micro-dynamics in reverb tails, subtleties of mic placement, and a tangible sense of a centre channel speaker. A broad, room-friendly sweet spot ensures equal dimension and transparency for everyone in the room. With legendary JBL transducers and custom-designed power amplifiers, the 3 Series will boost the image in your studio. With three different models to choose from, there's a 3 Series monitor to fit your studio and budget.

305P MKII

127MM (5") POWERED TWO-WAY STUDIO MONITOR

The 127mm (5") 305P MkII offers a remarkably full sound in an enclosure small enough to fit in the tightest workspace. Available in Matte Black pvc finish.

- Dispersion: 120° x 90° HxV
- Response: 43Hz-24kHz
- Power: 41-watts x2, Class D, Bi-Amp



306P MKII

165MM (6.5") POWERED TWO-WAY STUDIO MONITOR

The 165mm (6.5") 306P MkII is perfect if you need even more volume and bass response while still maintaining a compact footprint. Available in Matte Black pvc finish.

- Dispersion: 120° x 90° HxV
- Response: 39Hz-24kHz
- Power: 56-watts x2, Class D, Bi-Amp



308P MKII

200MM (8") POWERED TWO-WAY STUDIO MONITOR

The 200mm (8") 308P MkII is the largest and most powerful of the three models in the series, offering impressive low end, high output and excellent dynamic range. Available in Matte Black pvc finish.

- Dispersion: 120° x 90° HxV
- Response: 37Hz-24kHz
- Power: 56-watts x2, Class D, Bi-Amp



LSR310S

254MM (10") POWERED STUDIO SUBWOOFER WITH XLF

Extend your system LF all the way down! The LSR310S subwoofer incorporates JBL's patented Slip Stream™ Port working in concert with a custom 10" down-firing driver and a 200 Watt amplifier to add deep, powerful bass to any studio monitor system. A JBL first, the XLF Extended Low Frequency setting lets you hear your tracks with the augmented bass tuning used in today's dance clubs. Available in Matte Black pvc finish.

- Response: 27Hz-80Hz
- Power: 200-watts, Class D



JBL COMMERCIAL SERIES.



JBL® Commercial Series, a dynamic blend of the best HARMAN brands, knows for any business, the audio system is essential to keeping your customers informed and captivated.

Leveraging the expertise honed by years of precision sound reproduction and technical innovation by JBL and other HARMAN brands, JBL Commercial crafts top-quality components to offer you high-performance yet affordable sound systems.

By providing a premium listening experience for decades in everything from large arenas to private homes, JBL is one of the most recognised and respected brands in the audio industry. Capitalising on JBL's legendary achievements in audio engineering and technology enables JBL Commercial to set new standards in sound.

That means you'll find that our integrated array of mixer-amplifiers, amps, mixers, speakers, microphones, and wall controllers delivers precise, reliable sound in any commercial application, from soothing spas to bustling bars.

As your single-brand source, JBL Commercial Series simplifies the search for high-performance, comprehensive and versatile audio solutions for your business.

Visit www.jblcommercialproducts.com for more information.



JBL Amplifiers.

COMMERCIAL SERIES AMPLIFIERS



CSA140Z/180Z/1120Z

1 X 40/80/120W AUDIO AMPLIFIERS

CSA240Z/280Z/2120Z

2 X 40/80/120W AUDIO AMPLIFIERS

DRIVECORE™



By combining years of innovation, invention and insight from HARMAN brands, JBL® Commercial Series Amplifiers (CSA) go well beyond the expected in generating powerful sound. From the switch-mode universal power supply to the efficient performance of Crown’s DriveCore’s Technology, we continue to set new standards in commercial power amplifier technology.

Simple to configure, the CSA amplifiers provide a DriveCore-based sound solution. This replaces up to 500 parts with one small chip, significantly reducing the part count and increasing reliability while maintaining superb performance.

Supporting 70V and 100V installations out of the box, CSA amplifiers include RJ45 connectors for use with JBL CSR-V in-wall volume controls. Its universal power supply allows every CSA amp to accept AC voltages from 100 to 240 VAC, 50/60 Hz. And with HARMAN’s GreenEdge™ environmental initiative, CSA amplifiers quickly pay for themselves in energy savings.



- 1 or 2 output channels with 40W, 80W, 120W per channel
- Built-in 70V and 100V
- Fanless, space-saving 1U design
- Sleep mode disable function
- Energy-efficient amplifier
- Sleek industrial look with illuminated rings making knobs easy to see and use
- Supports the JBL CSR-V wall controller via Ethernet cable
- Universal power supply

SPECIFICATIONS			
Model	Power Output (per channel)	Output Channels	Size
CSA140Z	40W	1	1U Half-Rack
CSA180Z	80W	1	1U Half-Rack
CSA1120Z	120W	1	1U Half-Rack
CSA240Z	40W	2	1U Half-Rack
CSA280Z	80W	2	1U Half-Rack
CSA2120Z	120w	2	1U Half-Rack

Visit www.jblcommercialproducts.com for full specifications



CSA-2120 2 X 120W AUDIO AMPLIFIER

A professional-grade, two-channel model, the CSA-2120 power amplifier provides simple analogue front-end processing. Delivering 2 x 120W at 4 and 8 ohms, this efficient, lightweight unit is convection-cooled and has an auto-standby mode to save energy. The CSA-2120 is a professional-grade power amplifier built for commercial and installed sound applications. The amplifier is a two-channel model providing simple analogue front-end processing with a switch-mode universal power supply.

- Auto-standby mode for energy savings
- Balanced (Euroblock) and unbalanced (RCA) mono-summing inputs
- 1U lightweight design
- Plenum rated
- Over-heat auto protection
- Switch-mode universal power supply
- 2 x 120W at 4 and 8 ohms
- Compact size (1.75"H x 8.2"W x 9"D) Lightweight (under 4 lbs.)
- Optional Transformer Kit: CST-2120 for Hi-Z applications.

SPECIFICATIONS	
CSA Output Power	120W Per Channel
CSA Channels	2
CSA Sensitivity (8 ohms load)	1.4 Vrms
CSA Signal to Noise Ratio	>100dB
Weight & Size	1.3kg, 1U, Half Rack



CST-2120 70V/100V TRANSFORMER KIT

The JBL CST-2120 transformer module comes with a rack mounting kit so you can install it to a cabinet or wall. It supplies impedance and voltage matching from the CSA-2120 amplifier (with 4 and 8 ohms outputs) to drive 70V and 100V distributed speaker systems.

- Providing two channels for constant voltage operation
- 70V/100V Outputs
- Rack-mountable with CSA2120
- Detachable block input and output connectors.



Visit www.jblcommercialproducts.com for full specifications

JBL Mixer/Amplifiers.

COMMERCIAL SERIES MIXER/AMPLIFIERS

VMA 160 / 1120 / 1240

COMMERCIAL MIXER AMPLIFIERS



The JBL VMA Series is a cost-effective line of Mixer/Amplifiers with low impedance functionality (4Ω, 8Ω) and high impedance 70V and 100V output. They are designed with convenient and flexible features to be used by commercial integrators worldwide.

- 5 inputs with 1 output of 60, 120, or 240W of power
- Independent bass and treble controls for each output channel
- 100V and 70V output, or 4Ω/8Ω
- Paging Chime, and Priority muting
- Works with JBL CSR-V wall controllers
- Balanced mic/line inputs; RCA (.775V) inputs
- Rack mounting hardware included



SPECIFICATIONS				
Model	Power Output (per channel)	Inputs	Output Channels	Size
VMA160	60W	5	1	2U Full Rack
VMA1120	120W	5	1	2U Full Rack
VMA1240	240W	5	1	2U Full Rack

Visit jblcommercialproducts.com for full specifications



VMA 260 / 2120 COMMERCIAL MIXER AMPLIFIERS



The JBL VMA Series is a cost-effective line of Mixer/Amplifiers with low impedance functionality (4Ω, 8Ω) and high impedance 70V and 100V output. They are designed with convenient and flexible features to be used by commercial integrators worldwide.

- 8 inputs with 2 outputs of 60 or 120W of power
- Independent bass and treble controls for each output channel
- 100V and 70V output, or 4Ω/8Ω
- Paging Chime, and Priority muting
- Works with JBL CSR-V wall controllers
- Balanced mic/line inputs; RCA (.775V) inputs
- Rack mounting hardware included



SPECIFICATIONS

Model	Power Output (per channel)	Inputs	Output Channels	Size
VMA260	60W	8	2	2U Full Rack
VMA2120	120W	8	2	2U Full Rack

JBL Mixer/Amplifiers.

COMMERCIAL SERIES MIXER/AMPLIFIERS

CSMA 180 / 1120 / 240 / 280 / 2120 COMMERCIAL MIXER AMPLIFIERS

DRIVECORE™



Innovation is always evident throughout the JBL Commercial Series product lineup, and our new high-performance, energy-efficient Commercial Series Mixer-Amplifiers (CSMA) represents the latest example.

Manufactured using HARMAN's Green Edge™ clean standards, including a low-energy powder coat that uses 33% less energy, CSMA units conform to lead-free RoHS standards. By incorporating Crown's exclusive DriveCore technology, they also deliver unsurpassed reliability, thermal management and power efficiency.

Offering unmatched ease of use and driving 8 ohm and 4 ohm loads, CSMA units include balanced mic/line inputs, unbalanced RCA inputs and speaker connections, and RJ45 connectors to use with JBL CSR-V in-wall volume controls.



- Fanless, space-saving 1U design
- Configurable output routing (2 channel only) Independent bass/treble controls for each output channel Euro-block type mic/line input and output connectors, and unbalanced RCA inputs for consumer connection
- Supports 70V and 100V distributed audio systems without needing a separate transformer
- Remote volume control capability using JBL CSR-V module and standard Ethernet cable
- Priority muting, VOX ducking, and phantom power for all models



SPECIFICATIONS				
Model	Power Output (per channel)	Inputs	Output Channels	Size
CSMA180	80W	4	1	1U Half-Rack
CSMA1120	120W	4	1	1U Half-Rack
CSMA240	40W	8	2	1U Full-Rack
CSMA280	80W	8	2	1U Full-Rack
CSMA2120	120W	8	2	1U Full-Rack

JBL Mixers.

COMMERCIAL MIXER & PUBLIC ADDRESS MIXER

Easily configured for a range of applications, such as background music, security, and paging, CSM units are designed for everything from schools and hospitals to restaurants and fitness facilities. They feature RJ45 connectors for use with JBL CSR-V in-wall volume controls, and a universal power supply that accepts AC voltages from 100 to 240 VAC, 50/60 Hz. Plus, they're built using HARMAN's GreenEdge™ clean standards to offer numerous energy-efficient benefits, including a lighter weight, space-saving design, and conforming to RoHS standards.

CSM-14 & CSM-28 COMMERCIAL MIXERS



The JBL® Commercial Series CSM-21 and CSM-32 Mixers offer a wide array of processing tools, including priority override, page ducking, source and zone EQ, and a built-in crossover.

Helping maintain optimum levels through the system, LevelGuard™ automatically applies the right amount of compression to the source signals based upon the incoming level.

AutoWarmth™ automatically adjusts the tonal balance within a zone based upon the zone output level, preventing music from sounding thin at lower levels or excessively resonant at higher levels.

- Fanless, space-saving 1U design
- Independent base/treble controls
- Euro-block type mic/line input and output connectors, and unbalanced RCA inputs for consumer connection
- Sleek industrial look with illuminated rings making them easy to see and use
- Configurable output routing (2 channel models only)
- Supports JBL CSR-V wall controller via Ethernet cable
- Priority muting, VOX ducking, and phantom power for all models



SPECIFICATIONS			
Model	Inputs	Output Channels	Size
CSM-14	4	1	1U Half-Rack
CSM-28	8	2	1U Full-Rack

CSM-21 & CSM-32 PUBLIC ADDRESS MIXERS

The JBL® Commercial Series CSM-21 and CSM-32 Mixers offer a wide array of processing tools, including priority override, page ducking, source and zone EQ, and a built-in crossover.

Helping maintain optimum levels through the system, LevelGuard™ automatically applies the right amount of compression to the source signals based upon the incoming level.

AutoWarmth™ automatically adjusts the tonal balance within a zone based upon the zone output level, preventing music from sounding thin at lower levels or excessively resonant at higher levels.



SPECIFICATIONS									
Model	Stereo Source Inputs	Paging Microphone Input	Direct Input	Stereo Zone Outputs	Dedicated Subwoofer Output	Music-on-hold Output	Stereo/Mono Operation	Music Mute	Page Assign
CSM-21	2	Yes	Yes	1	Yes	-	Yes	Yes	Yes
CSM-32	3	Yes	Yes	2	Yes	Yes	Yes	Yes	Yes

Visit jblcommercialproducts.com for full specifications

JBL Wall Controllers.

SOLID CONTROL AT YOUR FINGERTIPS



The JBL Commercial Series remote wall controllers offer source selection and/or volume control from an elegant user interface. Using Cat. 5 cable and installation-friendly RJ-45 connectors, the controllers can be placed up to 1000' (305m) from the CSM mixer.

CSR-V 1-ZONE WALL CONTROLLER

- Volume Control
- RJ-45 / Cat. 5 Connection
- Up to 1000' (305m) from CSM device
- For use with all CSMA, CSM, and CSA (Z) models
- Available in Black or White



CSR-2SV 2-ZONE WALL CONTROLLER

- Volume Control
- Source Selection (2 Sources)
- RJ-45 / Cat. 5 Connection
- Up to 1000' (305m) from CSM device
- For use with CSM-21 and CSM-32
- Available in Black or White



CSR-3SV 3-ZONE WALL CONTROLLER

- Volume Control
- Source Selection (3 Sources)
- RJ-45 / Cat. 5 Connection
- Up to 1000' (305m) from CSM device
- For use with CSM-32
- Available in Black or White



Visit jblcommercialproducts.com for full specifications

TRAINING.



HARMAN PROFESSIONAL TRAINING

Take the time to upskill and expand your knowledge by leveraging the learning sessions on offer by HARMAN Professional Training. Facilitated by leading industry experts and HARMAN product specialists, HARMAN Professional Training provides the information, training or certifications needed to understand, sell, plan, design, install, program, and configure HARMAN Professional products and solutions accurately and effectively.

The training modules range from short bite-sized videos on specific products and technologies, through to face to face, instructor-led training, detailed webinars and certification courses. Whether you are just starting your career in audio, or you are an industry professional looking to maintain or develop your qualifications, the Certification pathway is structured to suit you.

You can either follow the learning pathway from foundation learning through to examination, or you can jump straight to final examinations if you have the capability and confidence. Instructor-led courses which are eligible for 8 InfoComm / AVIXA RU Credits include HARMAN Pro Audio Designer and Audio Programmer (Audio Architect).

EXPLORE THE ALL NEW TRAINING PROGRAMME



ONLINE COURSES



INSTRUCTOR LED



CERTIFICATION



WEBINARS

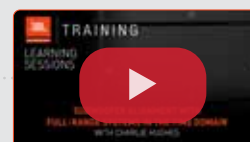

PRODUCT VIDEOS

VISIT WWW.HARMAN.REMOTE-LEARNER.NET/ TO DEVELOP YOUR LEARNING JOURNEY

CBT Calculator.

JBL's CBT Calculator software is a precision engineering tool allowing audio professionals to design JBL's CBT Constant Beamwidth Technology line array column loudspeakers into a wide variety of venues.



CBT Calculator shows the vertical coverage of CBT models in venues via a cross-sectional sound level coverage display. The program allows the use of up to 3 CBT speakers and virtual adjustment of their various adjustable settings for vertical coverage (narrow or broad) and voicing (speech or music/flat), in a space with up to 4 independent listening planes.

In addition to the SPL vertical coverage mapping of a proposed design, the CBT Calculator also shows the frequency response for up to 6 listener locations as well as an SPL summary of the listener locations over user-defined frequency bands.

It helps designers to determine the best CBT model selection, the proper vertical coverage and voicing settings, mounting height and the down-angle, allowing audio professionals to design CBT column line array speakers into many venue-application types.

Ceiling Speaker Configurator (CSC) and Distributed System Design (DSD) Software

CSC is a general sales estimation tool for basic projects. It comes up with a few ideas about which ceiling speaker could be used and approximately how many. This free utility program helps select the most economical JBL ceiling speaker to use based on various characteristics of the project, based on desired music level (for music systems) or background noise level (for paging systems).

The intention is that the user will then model the project more completely in the DSD Distributed System Design software to determine how/whether the various possibilities from CSC might work for the project. DSD allows the user to change the design for "what if" scenarios: What will happen if we change the design to a different loudspeaker model, to a different tap setting, to a different density factor, etc? What happens if we trim the pendant speakers at a different height? What impact would different changes have on the number of speakers required, the layout distance between speakers, the resulting sound level, the level variation throughout the space, the required amplification, etc?



VLA-C Calculator.

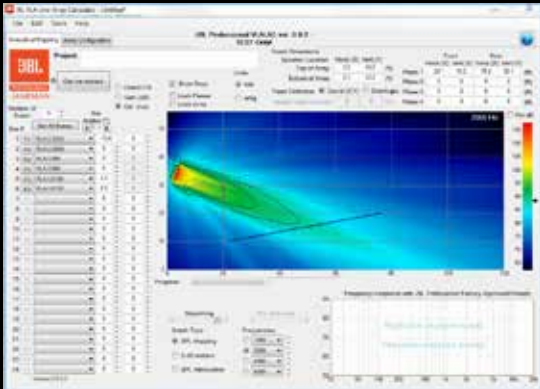

The free VLA-C Calculator is simulation software for designing and predicting JBL VLA-C Series systems.

The Acoustical Mapping tab allows for 2D sectional-view modeling of VLA-C arrays on up to four seating planes. Included are both patterns of the VLA-C full-range boxes (VLA-C265 and VLA-C2100) and the subwoofer (VLA-C125S). Mixed arrays may be modeled.

The Array Configuration tab describes the array and provides information about weight factors and centre of gravity (CG), along with mechanical validation of the array. The array weight design factor is selectable between 5:1, 7:1, and 10:1. Frame options are selectable. If the array configuration falls outside the load limits of either the speaker cabinets, the speaker interconnect system, or the suspension system, this will be indicated via an error indication. Array statistics like total weight, attach point span, and array height and depth are also calculated.

DDA (Digital Directivity Analysis).

DDA is a powerful yet intuitive Windows application for accurately predicting the electro-acoustic performance of loudspeaker systems in (semi) open or closed spaces. It includes 3D room acoustic modelling, direct sound simulation as well as statistical prediction of various acoustic parameters.

DDA supports all JBL point source loudspeakers with CLF data and all JBL Intellivox products. Intellivox makes use of JBL's advanced beam shaping (DDS) technologies. From DDA the radiation pattern of JBL Intellivox loudspeaker arrays can be controlled precisely and tailored to the shape and the acoustics of the space. In addition, DDA offers various design tools which reduce design time and help the sound designer to optimise the system performance. For installation and commissioning purposes DDA also generates FIR output filters which can be uploaded to supported DDS-controlled loudspeaker arrays using the JBL WinControl software.

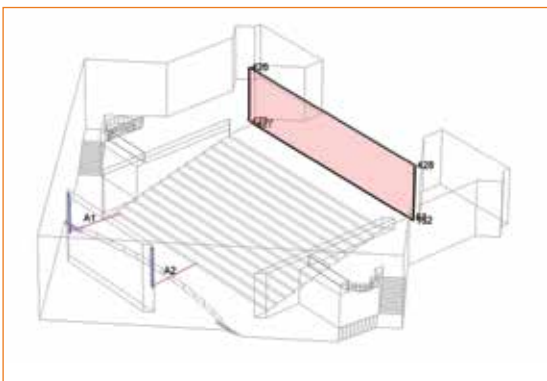



Loudspeaker Specification Notes:

Dispersion: Average above 1kHz, many JBL loudspeakers are referenced up to 16kHz. Asym= Asymmetrical.

Response: -10dB Full Frequency Bandwidth, -3dB data available on each individual specification sheet.

Sensitivity: 1watt @ 1metre or 1watt @ 1metre averaged over indicated frequency band in half space.

Icons: S= Speech, M= Music, D= HF Dome, CD= HF Compression Driver, WG= Wave Guide, R= Rotatable WG.

Power: Continuous Pink Noise for 100 hours with a 6dB Crest factor applied or *2 Hour IEC with 6dB Crest.

Environmental: Per IEC529, all plastics are treated for UV radiation. Installation accessory may be required.

Refer to MadisonAV Price List for details on product ordering quantities, as carton quantities may apply.

Connect with us.

Call 1800 00 77 80

www.madisonav.com.au

Brisbane Head Office

Level 2, Building 1
61 Metroplex Ave
Murarrie QLD 4172

Melbourne

51 Barclay Road
Derrimut VIC 3026

Sydney

149 Beaconsfield Street
Silverwater NSW 2128

Perth

56 Clavering Road
Bayswater WA 6053

