

Electrical Utility Style Selection

600V - 69kV Current & Voltage Transformers

All units meet requirements of IEEE C57.13.

This publication contains information on the most commonly used instrument transformers. There are many models and ratings not listed.

For prices, assistance in selection, and availability, please contact you nearest GE/ITI representative or visit www.geiti.com

All Electrical Utility instrument transformers are produced in our state-of-the-art manufacturing facility in Clearwater, and in Somersworth, NH. Our vertically integrated supply chain, innovative designs, & diverse engineering team, combine to give our offering a competitive edge. Our design engineers can meet nearly any special requirement, with a special emphasis on some of the alternatives below:

High Accuracy (-AC): 0.15 metering class per IEEE. Popular for increased metering revenue.

Special High Accuracy (-S): 0.15S metering class per IEEE, applicable to CT's only. The highest CT rating available per IEEE standards.

Accubute™ (-A): Legendary reliability of Hy-Bute-60™ combined with the highest IEEE accuracy classes available. High Accuracy PT's (0.15) and CT's (0.15S) with butyl rubber insulation. Available 5-69kV, most models.

Extended Range (-ER): 0.15S metering class, with rated performance down thru 1% of primary amps.

High Temperature (-OCV): 85°C ambient rating vs. the standard 55°C. Popular for padmount metering cabinets and warmer climates.

Encompass™ Wide Range CT's (-OW): The benefits of simplified ordering, billing, and inventory reduction, without the cost premium of high accuracy product. Meets standard accuracy class from a rating factor of 0.4 to 4.0.

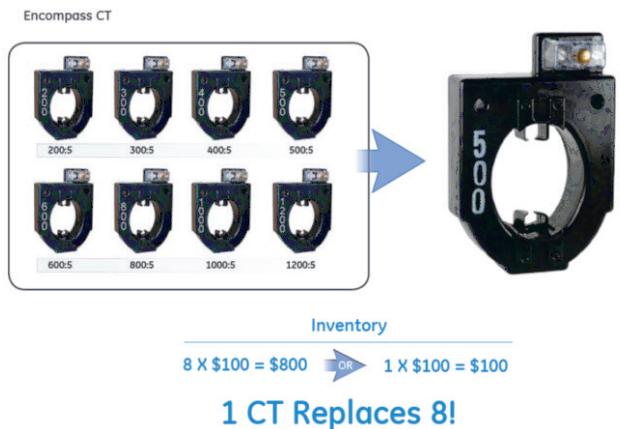

INDEX

600 Volt Current Transformers

Model	Page	Model	Page
2DARL	4	JAH-0C	14
JAB-0C	4	JAS-0C	14
JAB-0CV (High Temp)	6	JAD-0C	16
JAB-AC (High Accuracy)	6	JAD-AC (High Accuracy)	16
JAB-0W (Encompass)	6	JAD-0C	18
JCT-0C	8	JAD-0W (Encompass)	18
JCT-AC (High Accuracy)	8	JCS-0C	18
JCM-0C	8	JCB-0C	20
JCR-0C	10	JCP-0C	20
JCR-0W (Encompass)	10	JCD-0C	20
JCW-0C	10	CTM-0C (Single Bar)	22
JAK-0C	12	CTM-0C (Double Bar)	22
JAK-AC (High Accuracy)	12	JAR-0C	22
JAK-0W (Encompass)	14	200WP	24

600 Volt Voltage Transformers

Model	Page	Model	Page
PTM-0C	24	JEV-0C	28
JE-27C	26	JVM-0C	28
JVA-0C	26		

Split Core CT's

Model	Page		
606 & 608	30		

Bushing Type CT's

Model	Page	Model	Page
B07 Cast Resin	32	B07 Mylar Taped	33

5 kV thru 34.5 kV Current Transformers

Model	Page	Model	Page
JCM-2	36	JKM-5AC (High Accuracy)	44
JKC-3	36	JCM-3/-4/-5	46
JKS-3	38	JCB-3/-4/-5	46
JKM-3C	40	CTW6-125-T100/200	48
JKM-4C	40	CTWH6-125-T200	48
JKS-5	42	CTW7-150-T100/200	50
JKM-95	42	CTWH7-150-T200	50
JKM-5C	44		

5 kV thru 34.5 kV Voltage Transformers

Model	Page	Model	Page
JVM-2C/3C	52	PT6-1-125	56
JVM-95	52	PT6-2-125	58
JVM-4C/5C	54	PT7-1-150	58
JVM-4AC/5AC (High Accuracy)	56	PT7-2-150 & PT7-2-200	58

INDEX

5 kV thru 69 kV Current Transformers (Outdoor)

Model	Page	Model	Page
JCW-3 & JCW-4 & JCW-5	60	JKW-5	66
JCD-3 & JCD-4 & JCD-5	60	JKW-5AC (High Accuracy)	68
JCK-3 & JCK-4	62	JKW-5A (Special High Accuracy)	68
JKW-3 & JKW-4	62	JKW-6	70
JCK-5	64	JKW-6A (Special High Accuracy)	70
JCK-5C	64	JKW-7	72
JCK-5CER (Extended Range)	64	JKW-150 & JKW-200	74
JKW-5C	66	JKW-250 & JKW-350	74

5 kV thru 69 kV Voltage Transformers (Outdoor)

Model	Page	Model	Page
JVW-3	76	JVW-5AC (High Accuracy)	82
JVW-4 & JVW-5	78	JVW-6	82
JVW-110	78	JVW-150	84
JVW-110C	80	JVW-7	84
JVW-5C	80	JVS & JVT	86
JVW-4A & JVW-5A (High Accuracy)	82		

Overhead Primary Metering Assembly

Model	Page	Model	Page
Overhead Primary Metering Assembly	88		

Test Switch

Model	Page	Model	Page
Series RT Rack Mounted Test Switch	90	FT Test Switch & Test Plugs	90

Accessories Switches & Components

Model	Page	Model	Page
SB-1	91	ET16/17 Indicating Lamps	93
SB-9	91	ET16 LED	93
SB-10	91	Capacitor Trip Devices	93
SBM	91	Open Circuit Protectors	93
Series 95 Switches & Lockout Relays	92	EB-1/2/4 Terminal Boards	94
Multi Contact Auxiliary Relays	92	EB-25/26/27 Terminal Boards	94
		IKU Terminal Blocks	94

References

Model	Page	Model	Page
Definitions and Functions	95	CT & PT Parallelograms	102
Equivalent Circuit	96	Standard Accuracy	103
Lead Wire & Resistance Tbl	96	Encompass Accuracy	103
CT- Selection	97	Sample Test Card	103
ITI - Rule of Thumb	97	Circle Diagram	104
Utility Cross Reference	98	Metering Connections	104
Key to Type Designation	99	Relay Accuracy of a CT	105
IEEE Accuracy Standards	100-101		

600 Volt Current Transformer

Model 2DARL

Window: 1.00"

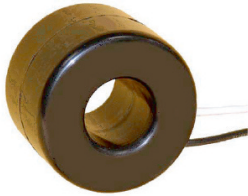

APPLICATION
Sub-metering, load control, etc. Suitable for ammeters, wattmeters and cross current compensation.

REGULATORY AGENCY APPROVALS
UL Recognized FileE93779
CSA Recognized FileLR89403

WEIGHT (approximate)0.9 lbs

INSULATION LEVEL
600 Volts, 10 kV BIL full wave.

Flexible leads are UL 1015, 1050C, CSA approved, #16 AWG, 24" long. Non-standard, lead length can be specified.

FREQUENCY
50-400 Hz

2DARL DATA TABLE

Current Ratio (Amps) Pri : Sec	IEEE Accuracy Class 60 Hz Burden					VA ± 1% Class	Secondary Winding Resistance (Ohms @ 75° C)	Continuous Thermal Current Rating Factor		Catalog Number
	B0.1	B0.2	B0.5	B0.9	B1.8			@ 30° C Amb.	@ 55° C Amb.	
50:5	4.8	--	--	--	--	2% 2.5	0.008	2.0	2.0	2DARL-500
60:5	1.2	4.8	--	--	--	2.5	0.011	2.0	2.0	2DARL-600
75:5	1.2	2.4	--	--	--	3.5	0.015	2.0	2.0	2DARL-750
80:5	1.2	2.4	4.8	--	--	4.0	0.016	2.0	2.0	2DARL-800
100:5	1.2	2.4	4.8	--	--	5.0	0.018	2.0	2.0	2DARL-101
120:5	1.2	2.4	2.4	4.8	--	5.0	0.022	2.0	2.0	2DARL-121
125:5	0.6	1.2	2.4	4.8	--	5.0	0.028	2.0	1.5	2DARL-1250
150:5	0.6	0.6	1.2	2.4	4.8	10.0	0.031	2.0	1.5	2DARL-151
200:5	0.3	0.6	1.2	1.2	2.4	12.5	0.047	1.5	1.33	2DARL-201
250:5	0.3	0.3	0.6	1.2	2.4	15.0	0.074	1.5	1.25	2DARL-251
300:5	0.3	0.3	0.6	0.6	1.2	20.0	0.089	1.5	1.0	2DARL-301

Model JAB-0C

Window: 4.50"x 3.50"



APPLICATION
Designed for indoor service; especially designed for installation over the secondary bushings of pad mounted transformers. For mounting and application information, including use at higher voltages, and matching the current rating to the pad transformer thermal capability.

IEEE METER ACCURACY CLASS, 60 Hz
0.3% class from B0.1 to the burdens shown in the table.

WEIGHT & Dimensions
Weight (approximate) 8.25 lbs
Height 8.75"
Width 6.00"
Depth 2.30"

REFERENCE DRAWINGS
Outline0121C33851
Outline (Rectangular)0121C34472
Outline (1.88" cast)0121C34503
Outline (2.00" cast)0121C34986
Outline (2.50" cast)0121C40892

INSULATION LEVEL
0.6kV; BIL 10kV full wave

FREQUENCY
50-60 Hz

JAB-0C DATA TABLE

Current Ratio (Amps) Pri : Sec	Burden	Continuous Thermal Current Rating Factor		Catalog Number (With Secondary Hardware and Cover)	Catalog Number for Rectangular cast JAB-0C
		@ 30° C Amb.	@ 55° C Amb.		
* 100:5	B0.1	4.0	4.0	750X136618	--
200:5	B0.1	4.0	2.9	750X136202	750X136302
* 200:5	B0.2	4.0	4.0	750X136668	--
* 300:5	B0.5	3.0	2.2	750X136660	--
300:5	B0.2	4.0	2.9	750X136203	750X136303
400:5	B0.2	4.0	2.9	750X136204	750X136304
*400:5	B0.5	4.0	2.9	750X136667	--
500:5	B0.5	3.0	2.2	750X136205	750X136305
600:5	B0.5	3.0	2.2	750X136206	750X136306
800:5	B0.5	3.0	2.2	750X136208	750X136308
1000:5	B0.5	2.0	1.5	750X136210	750X136310
1200:5	B0.5	2.0	1.5	750X136212	750X136312
1500:5	B0.9	2.0	1.5	750X136215	750X136315
*1500:5	B0.9	3.0	2.4	750X136465	--
2000:5	B1.8	1.5	1.1	750X136220	750X136320
3000:5	B1.8	1.33	1.0	750X136230	750X136330
4000:5	B1.8	1.0	0.7	750X136655	750X136423

* Grecian Urn Style available in cast version only. Consult factory for dimensions.

600 Volt Current Transformer

Model JAB-0CV (High Temp) Window: 4.50" x 3.50"



For High Ambient Temperature Applications

APPLICATION
Designed for indoor service. This special version of the JAB-0CV current transformer is designed for use on heavily loaded pad mount transformers operating in high temperature environments up to 85° C. For mounting and application information, including use at higher voltages, and matching the current rating to the pad transformer thermal capability.

IEEE METER ACCURACY CLASS, 60 Hz
0.3% class from B0.1 to the burdens shown in the table.

WEIGHT & Dimensions
(approximate)
Weight: 8.25 lbs
Height: 8.75"
Width: 6.00"
Depth: 2.30"

REFERENCE DRAWINGS
Outline0121C33851

INSULATION LEVEL
0.6kV; BIL 10kV full wave

FREQUENCY
50-60 Hz

JAB-0CV DATA TABLE

Current Ratio (Amps) Pri : Sec	Burden	Continuous Thermal Current Rating Factor		Catalog Number (With Secondary Hardware and Cover)
		@ 85° C Amb.		
200:5	B0.1	4.0		750X236202
300:5	B0.2	4.0		750X236203
400:5	B0.2	4.0		750X236204
500:5	B0.5	3.0		750X236205
600:5	B0.5	3.0		750X236206
800:5	B0.5	3.0		750X236208
1000:5	B0.5	2.0		750X236210
1200:5	B0.5	2.0		750X236212
1500:5	B0.9	2.0		750X236215
2000:5	B1.8	1.5		750X236220
3000:5	B1.8	1.33		750X236230

Notes: Consult factory for base plate provisions.

Model JAB-AC (High Accuracy) Window: 4.50" x 3.50"



APPLICATION
Designed for indoor service; especially designed for installation over the secondary bushings of pad mounted transformers from 75 kVA TO 3000 kVA. For mounting and application information, including use at higher voltages, and matching the current rating to the pad transformer thermal capability.

WEIGHT & Dimensions
(approximate)
Weight: 8.25 lbs
Height: 8.75"
Width: 6.00"
Depth: 2.30"

REFERENCE DRAWINGS
Outline0121C33851

INSULATION LEVEL
0.6kV; BIL 10kV full wave

FREQUENCY
50-60 Hz

JAB-AC DATA TABLE

Current Ratio (Amps) Pri : Sec	IEEE Accuracy Class 60 Hz Burden			Electronic Burdens		Continuous Thermal Current Rating Factor Ψ		Catalog Number (With Secondary Hardware and Cover)
	B0.1	B0.2	B0.5	E0.04	E0.2	@ 30° C Amb.	@ 55° C Amb.	
800:5	0.15	0.15	0.3	--	--	3.0	2.2	750X136412
1000:5	0.15	0.15	0.3	0.15	--	2.0	1.5	750X136413
1200:5	0.15	0.15	0.3	0.15	--	1.5	1.1	750X136414
1500:5	0.15	0.15	0.3	0.15	0.15	2.0	1.5	750X136415
2000:5	0.15	0.15	0.15	0.15	0.15	1.0	0.7	750X136416
3000:5	0.15	0.15	0.15	0.15	0.15	1.0	0.7	750X136417

Notes:

Ψ A high temperature version is available for use in locations with unusually high ambient temperatures. Consult factory for base plate provisions.

Model JAB-0W (Encompass) Window: 4.50" x 3.50"



APPLICATION
Designed for indoor service; especially designed for installation over the secondary bushings of pad-mounted transformers from 75 kVA to 3000 kVA. For mounting and application information, including use at higher voltages, and matching the current rating to the transformer thermal capability.

WEIGHT (approximate)
Weight 4.0 lbs

REFERENCE DRAWINGS
Outline0121C33851
Outline (cast resin)0121C40890

INSULATION LEVEL
0.6kV; BIL 10kV full wave

FREQUENCY
50-60 Hz

JAB-0W DATA TABLE

Current Ratio (Amps) Pri : Sec	IEEE Accuracy Class Burden 0.3 B0.5	Continuous Thermal Current Rating Factor		Dimensions in inches			Catalog Number
		@ 30° C Amb.	@ 55° C Amb.	Height	Width	Depth	
500:5	200:2 to 2000:20	4.0	3.0	8.75	6.00	2.30	750X136651
1500:5	600:2 to 3000:10	2.0	1.5	8.75	6.00	2.30	750X136652

JAB-0W HIGH TEMP DATA TABLE

Current Ratio (Amps) Pri : Sec	IEEE Accuracy Class Burden 0.3 B0.5	Continuous Thermal Current Rating Factor		Dimensions in inches			Catalog Number
		@ 85° C Amb.		Height	Width	Depth	
500:5	200:2 to 2000:20	4.0		9.37	6.38	2.50	750X136464
1500:5	600:2 to 3000:10	2.0		8.75	6.00	2.30	750X136463

Transformer rated meters must be investigated for use at the lower current range extension.

Brochure Available at
www.GEIT.com

600 Volt Current Transformer

Model JCT-0C



Dimensions do not include high baseplate

APPLICATION
Designed for indoor service; suitable for operating meters and instruments, on both single-phase two-wire circuits and polyphase circuits.

WEIGHT (Approximate)
Transformer, without base7.0 lbs
Low base, add0.25 lbs
High (EEI) base, add1.0 lbs

DIMENSIONS
Height5.06"
Width11.85"
Depth3.38"

REFERENCE DRAWINGS
Outline0121C33682

INSULATION LEVEL
0.6kV; BIL 10kV full wave.

FREQUENCY
50-60 Hz

JCT-0C DATA TABLE

Current Ratio (Amps) Pri : Sec	IEEE Accuracy Class 60 Hz Burden			Continuous Thermal Current Rating Factor		Catalog Number	
	B0.1	B0.2	B0.5	@ 30° C Amb.	@ 55° C Amb.	With Secondary Hardware and Cover	Without Secondary Hardware and Cover
Without Base							
100:5	0.3	0.3		4.0	3.0	750X123623	
200:5	0.3	0.3	0.6	2.0	1.5	750X123202	750X123102
400:5	0.3	0.3	0.6	2.0	1.5	750X123204	750X123104
600:5	0.3	0.3	0.3	2.0	1.5	750X123206	750X123106
800:5	0.3	0.3	0.3	1.5	1.0	750X123208	750X123108
With Low Base							
100:5	0.3	0.3		4.0	3.0	750X123616	
200:5	0.3	0.3	0.6	2.0	1.5	750X123212	750X123112
400:5	0.3	0.3	0.6	2.0	1.5	750X123214	750X123114
600:5	0.3	0.3	0.3	2.0	1.5	750X123216	750X123116
800:5	0.3	0.3	0.3	1.5	1.0	750X123218	750X123118
With High (EEI) Base							
100:5	0.3	0.3		4.0	3.0	750X123660	
200:5	0.3	0.3	0.6	2.0	1.5	750X123222	750X123122
400:5	0.3	0.3	0.6	2.0	1.5	750X123224	750X123124
600:5	0.3	0.3	0.3	2.0	1.5	750X123226	750X123126
800:5	0.3	0.3	0.3	1.5	1.0	750X123228	750X123128

Model JCT-AC (High Accuracy)



Dimensions do not include high baseplate

APPLICATION
Designed for indoor service; suitable for operating meters and instruments, on both single-phase two-wire circuits and polyphase circuits.

WEIGHT (Approximate)
Transformer, without base7.0 lbs
Low base, add0.25 lbs
High (EEI) base, add1.0 lbs

DIMENSIONS
Height5.06"
Width12.16"
Depth3.38"

REFERENCE DRAWINGS
Outline0121C42808

INSULATION LEVEL
0.6kV; BIL 10kV full wave.

FREQUENCY
50-60 Hz

JCT-AC DATA TABLE

Current Ratio (Amps) Pri : Sec	IEEE Accuracy Class 60 Hz Burden		Electronic Burden	Continuous Thermal Current Rating Factor		Catalog Number
	B0.1	B0.2	E0.04	@ 30° C Amb.	@ 55° C Amb.	With Secondary Hardware and Cover
Without Base						
600:5	0.15	0.30	0.15	2.0	1.5	750X123625
800:5	0.15	0.15	0.15	1.5	1.0	750X123626

Baseplate Models Available, Consult Factory for Catalog Number

Model JCM-0C



Dimensions do not include high baseplate

APPLICATION
Designed for indoor service. Designed to provide high accuracy in applications with high metering secondary burdens. Suitable for operating meters and instruments, on both single-phase two-wire circuits and polyphase circuits.

WEIGHT (Approximate)
Transformer, without base5.8 lbs
Low base, add0.25 lbs
High (EEI) base, add1.0 lbs

DIMENSIONS
Height5.06"
Width11.85"
Depth7.38"

REFERENCE DRAWINGS
Outline0121C33704

INSULATION LEVEL
0.6kV; BIL 10kV full wave

FREQUENCY
50-60 Hz

JCM-0C DATA TABLE

Current Ratio (Amps) Pri : Sec	IEEE Accuracy Class 60 Hz Burden			Continuous Thermal Current Rating Factor		Catalog Number	
	B0.1	B0.2	B0.5	@ 30° C Amb.	@ 55° C Amb.	With Secondary Hardware and Cover	Without Secondary Hardware and Cover
Without Base							
200:5	0.3	0.3	0.3	2.0	1.5	750X125013	750X125009
400:5	0.3	0.3	0.3	2.0	1.5	750X125014	750X125010
With Low Base							
200:5	0.3	0.3	0.3	2.0	1.5	750X125021	750X125017
400:5	0.3	0.3	0.3	2.0	1.5	750X125022	750X125018
With High (EEI) Base							
200:5	0.3	0.3	0.3	2.0	1.5	750X125029	750X125025
400:5	0.3	0.3	0.3	2.0	1.5	750X125030	750X125026

600 Volt Current Transformer

Model JCR-0C

Window: 1.12", 1.50", 2.00"



APPLICATION
Designed for both indoor and outdoor service. Suitable for operating meters and instruments, on both single-phase two-wire circuits and polyphase circuits.

WEIGHT (Approximate)
Transformer, without base
200:55.5 lbs
300:53.8 lbs
400:53.3 lbs
Low base, add0.5 lbs
High (EEI) base, add1.0 lbs

DIMENSIONS
Height5.80" w/low baseplate
Width3.96" w/low baseplate
Depth3.87" w/o baseplate

REFERENCE DRAWINGS
Outline0121C33753
Low Base Assembly0221C36157
High Base Assembly0221C36158

INSULATION LEVEL
0.6kV; BIL 10kV full wave

FREQUENCY
50-60 Hz

Model JCR-0W (Encompass)

Window: 2.00"



Brochure Available at
www.GEITL.com

APPLICATION
Designed for both indoor and outdoor service. Suitable for operating meters and instruments, on both single-phase two-wire circuits and polyphase circuits.

WEIGHT (approximate)
Transformer,
Low Base4.0 lbs
High Base5.0 lbs

DIMENSIONS
Height5.65" w/base
Width3.96"
Depth3.00", 5.26" w/base

REFERENCE DRAWINGS
Outline0121C36111

INSULATION LEVEL
0.6kV; BIL 10kV full wave

FREQUENCY
50-60 Hz

Model JCW-0C

Window: 1.12", 1.50", 2.00"



APPLICATION
Designed for both indoor and outdoor service. Designed to provide high accuracy in applications with high metering secondary burdens. Suitable for operating meters and instruments, on both single phase two-wire circuits and polyphase circuits.

WEIGHT (approximate)
Transformer, without base
200:56.0 lbs
300:54.8 lbs
400:54.0 lbs
Low Base, add0.5 lbs
High (EEI) Base, add1.0 lbs

DIMENSIONS
Height5.80" w/low baseplate
Width3.96" w/low baseplate
Depth3.87" w/o baseplate

REFERENCE DRAWINGS
Outline0121C33754
Bar Assembly (600-800A)0821B38057
Bar Assembly (400A)0821B38093
Bar Assembly (200-300A)0821B38639
Bar Assembly (100A)0821B38662
Low Base Assembly0221A36157
High Base Assembly0221A36158

INSULATION LEVEL
0.6kV; BIL 10kV full wave

FREQUENCY
50-60 Hz

JCR-0C DATA TABLE

Current Ratio (Amps) Pri : Sec	IEEE Accuracy Class 60 Hz Burden			Continuous Thermal Current Rating Factor		Window I.D. (inches)	Catalog Number	
	B0.1	B0.2	B0.5	@ 30° C Amb.	@ 55° C Amb.		With Secondary Hardware and Cover	Without Secondary Hardware and Cover
Without Base								
100:5	0.3	0.3	1.2	4.0	3.0	1.125	750X134072	750X134071
200:5	0.3	0.3	0.6	3.0	2.0	1.50	750X134053	750X134052
300:5	0.3	0.3	0.6	2.0	1.5	2.00	750X134022	750X134021
400:5	0.3	0.3	0.6	2.0	1.5	2.00	750X134004	750X134002
With Low Base								
100:5	0.3	0.3	1.2	4.0	3.0	1.125	750X134074	750X134073
200:5	0.3	0.3	0.6	3.0	2.0	1.50	750X134055	750X134054
300:5	0.3	0.3	0.6	2.0	1.5	2.00	750X134024	750X134023
400:5	0.3	0.3	0.6	2.0	1.5	2.00	750X134008	750X134006
With High (EEI) Base								
100:5	0.3	0.3	1.2	4.0	3.0	1.125	750X134076	750X134075
200:5	0.3	0.3	0.6	3.0	2.0	1.50	750X134057	750X134056
300:5	0.3	0.3	0.6	2.0	1.5	2.00	750X134026	750X134025
400:5	0.3	0.3	0.6	2.0	1.5	2.00	750X134012	750X134010

JCR-0W DATA TABLE

Current Ratio (Amps) Pri : Sec	IEEE Accuracy Class 60 Hz Burden 0.3 B0.2	Window Size (Inside Dia.)	Continuous Thermal Current Rating Factor		Catalog Number Without Base	
			@ 30° C Amb.	@ 55° C Amb.	With Secondary Hardware and Cover	Without Secondary Hardware and Cover
250:5	100:2 to 1000:20	2.0"	4.0	3.0	750X134608	750X134611
With Low Base						
250:5	100:2 to 1000:20	2.0"	4.0	3.0	750X134609	750X134612
With High Base						
250:5	100:2 to 1000:20	2.0"	4.0	3.0	750X134610	750X134613

JCW-0C DATA TABLE

Current Ratio (Amps) Pri : Sec	IEEE Accuracy Class 60 Hz Burden			Continuous Thermal Current Rating Factor		Window I.D. (inches)	Catalog Number (With Secondary Hardware and Cover)	Catalog Number (With Primary Bar)
	B0.1	B0.2	B0.5	@ 30° C Amb.	@ 55° C Amb.			
Without Base								
100:5	0.3	0.3	1.2	4.0	3.0	1.125	750X132623	750X132626
200:5	0.3	0.3	0.3	4.0	3.0	1.50	750X132638	750X132639
200:5	0.3	0.3	0.3	3.0	2.0	1.50	750X132203	750X132629
300:5	0.3	0.3	0.3	2.0	1.5	2.00	750X132206	750X132632
400:5	0.3	0.3	0.3	2.0	1.5	2.00	750X132204	750X132635
600:5	0.3	0.3	0.3	2.0	1.5	2.00	750X132616	750X132611
800:5	0.3	0.3	0.3	1.5	1.0	2.00	750X132620	750X132613
With Low Base								
100:5	0.3	0.3	1.2	4.0	3.0	1.125	750X132624	750X132627
200:5	0.3	0.3	0.3	4.0	3.0	1.50	750X132640	750X132641
200:5	0.3	0.3	0.3	3.0	2.0	1.50	750X132213	750X132630
300:5	0.3	0.3	0.3	2.0	1.5	2.00	750X132220	750X132633
400:5	0.3	0.3	0.3	2.0	1.5	2.00	750X132214	750X132636
600:5	0.3	0.3	0.3	2.0	1.5	2.00	750X132614	750X132612
800:5	0.3	0.3	0.3	1.5	1.0	2.00	750X132621	750X132618
With High (EEI) Base								
100:5	0.3	0.3	1.2	4.0	3.0	1.125	750X132625	750X132628
200:5	0.3	0.3	0.3	4.0	3.0	1.50	750X132642	750X132643
200:5	0.3	0.3	0.3	3.0	2.0	1.50	750X132223	750X132631
300:5	0.3	0.3	0.3	2.0	1.5	2.00	750X132226	750X132634
400:5	0.3	0.3	0.3	2.0	1.5	2.00	750X132224	750X132637
600:5	0.3	0.3	0.3	2.0	1.5	2.00	750X132617	750X132615
800:5	0.3	0.3	0.3	1.5	1.0	2.00	750X132622	750X132619

600 Volt Current Transformer

Model JAK-0C

Window: 1.50", 2.60", 3.06"

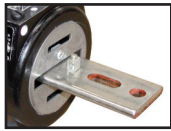

APPLICATION
Designed for both indoor and outdoor service. Suitable for operating meters and instruments, on both single phase two-wire circuits and polyphase circuits. The window type transformer can also be used on three-wire single-phase circuits. For use on higher voltage circuits with an insulated primary conductor.

IEEE METER ACCURACY CLASS, 60 Hz
0.3% class from B0.1 to the burdens shown in the table.

WEIGHT (approximate)
Window-Type Transformer12 lbs
Primary Bar-Type Transformers15 lbs
Low Base, add0.7 lbs
High Base, add1.0 lbs

DIMENSIONS
Height6.86" w/low baseplate
Width5.13" w/low baseplate
Depth4.20", 5.0"

REFERENCE DRAWINGS
Outline (100-800:5) (Pri Bar)0121C38912
Outline (1000-2000:5)0121C36235
Outline (3000:5)0121C39069
Outline (100-800:5)0121C33607
Outline (dual ratio)0121C34087

Dimensions do not include baseplates

JAK-0C DATA TABLE

Current Ratio (Amps) Pri : Sec	Continuous Thermal Current Rating Factor		Win I.D."	Burden	Catalog Number				11.88" Primary Bar Assembly
	@ 30° C Amb.	@ 55° C Amb.			No Base	Low Base	Wide Base	High Base	
Window-Type, Single Ratio									
100:5	4.0	4.0	1.50	B0.2	750X133635	750X133645	750X133637	750X133638	0821C34762-7
**100:5	4.0	4.0	2.60	B0.1	750X133673	750X133636	750X133674	750X133675	0821C34762-1
200:5	4.0	4.0	2.60	B0.5	750X133301	750X133311	750X133351	750X133321	0821C34762-5
200:5	4.0	2.9	2.60	B0.2	750X133976	750X133977	750X133978	750X133979	0821C34762-5
200:5	4.0	2.9	3.062	B0.1	750X133972	750X133973	750X133974	750X133975	0821C34762-5
**300:5	4.0	2.9	3.062	B0.5	750X133302	750X133312	750X133352	750X133322	0821C34762-9
400:5	4.0	2.9	3.062	B0.5	750X133303	750X133313	750X133353	750X133323	0821C34762-4
500:5	3.0	2.4	3.062	B0.5	750X133304	750X133314	750X133354	750X133324	0821C34762-4
600:5	2.0	1.8	3.062	B0.5	750X133305	750X133315	750X133355	750X133325	0821C34762-4
800:5	2.0	1.5	3.062	B0.5	750X133306	750X133316	750X133356	750X133326	0821C34762-4
1000:5	2.0	1.5	3.062	B0.5	750X133546	750X133547	750X133548	750X133549	0821C34762-10
1200:5	1.5	1.1	3.062	B1.8	750X133500	750X133501	750X133502	750X133503	0821C34762-10
1500:5	1.5	1.1	3.062	B1.8	750X133504	750X133505	750X133506	750X133507	0821C34762-11
2000:5	1.0	0.7	3.062	B1.8	750X133508	750X133509	750X133510	750X133511	0821C34762-10
3000:5	1.0	0.7	3.062	B1.8	750X133512	750X133513	750X133514	750X133515	0821B38171
Window-Type, Dual Ratio									
200/400:5**	2.0/2.0	1.5/1.5	2.60	B0.5	750X133307	750X133317	--	--	0821C34762-1
300/600:5**	2.0/2.0	1.5/1.5	3.062	B0.5	750X133308	750X133318	--	--	0821C34762-9
400/800:5	2.0/2.0	1.5/1.5	3.062	B0.5	750X133309	750X133319	--	--	0821C34762-2
1000/2000:5	1.5/1.0	1.1/0.7	3.062	B0.5/B1.8	750X133516	750X133517	--	--	0821C34762-10
1500/3000:5	1.3/1.0	1.0/0.7	3.062	B0.9/B1.8	750X133518	750X133519	--	--	0821B38171
Primary Bar-Type, Single Ratio									
100:5	4.0	4.0	1.50	B0.2	--	750X133639	--	750X133640	0821C34762-7
200:5	4.0	4.0	2.60	B0.5	--	750X133331	--	750X133341	0821C34762-5
**300:5	4.0	2.9	3.062	B0.5	--	750X133332	--	750X133342	0821C34762-9
400:5	4.0	2.9	3.062	B0.5	--	750X133333	--	750X133343	0821C34762-4
500:5	3.0	2.4	3.062	B0.5	--	750X133334	--	750X133344	0821C34762-4
600:5	2.0	1.8	3.062	B0.5	--	750X133335	--	750X133345	0821C34762-2
800:5	2.0	1.5	3.062	B0.5	--	750X133336	--	750X133346	0821C34762-4
1000:5	2.0	1.5	3.062	B0.5	--	750X133550	--	750X133551	0821C34762-10
1200:5	1.5	1.1	3.062	B1.8	--	750X133520	--	750X133521	0821C34762-10
1500:5	1.5	1.1	3.062	B1.8	--	750X133522	--	750X133523	0821C34762-11
2000:5	1.0	0.7	3.062	B1.8	--	750X133524	--	750X133525	0821C34762-10
3000:5	1.0	0.7	3.062	B1.8	--	750X133526	--	750X133527	0821B38171

** Available only in 5" depth, reference outline for all other depths.
 † 14.5" length also available for 1000-3000:5

Model JAK-AC (High Accuracy)

Window: 3.06"



APPLICATION
Designed for both indoor and outdoor service. Suitable for operating meters and instruments, on both single phase two-wire circuits and polyphase circuits. The window type transformer can also be used on three-wire single-phase circuits. For use on higher voltage circuits with an insulated primary conductor.

WEIGHT (approximate)
Window-Type Transformer12 lbs
Primary Bar-Type Transformers15 lbs
Low Base, add0.7 lbs
High Base, add1.0 lbs

DIMENSIONS
Height7.184" w/low baseplate
Width5.625" w/low baseplate
Depth2.625", 4.20", 5.0"

REFERENCE DRAWINGS
Outline0121C33607
Bus Bar Assembly (400-800:5)0821C34762-4
Bus Bar Assembly (1000-3000:5)1521C37743

JAK-AC DATA TABLE

Current Ratio (Amps) Pri : Sec	Continuous Thermal Current Rating Factor		Max. Burden for 0.15 Accuracy	Electronic Burdens		Catalog Number			
	@ 30° C Amb.	@ 55° C Amb.		E0.04	E0.2	No Base	Low Base	Wide Base	High Base
Window-Type, Single Ratio									
400:5	3.0	2.2	B0.1	--	--	750X133567	750X133575		
500:5	2.0	1.5	B0.2	--	--	750X133568	750X133576		750X133XXX
600:5	1.5	1.1	B0.2	--	--	750X133569	750X133577		750X133XXX
800:5	1.5	1.1	B0.2	--	--	750X133570	750X133578		750X133XXX
1200:5	1.5	1.1	B0.5	0.15	0.15	750X133571	750X133579		750X133XXX
1500:5	1.5	1.1	B0.5	0.15	0.15	750X133572	750X133580		750X133XXX
2000:5	1.0	0.7	B0.5	0.15	0.15	750X133573	750X133581		750X133XXX
3000:5	1.0	0.7	B0.5	0.15	0.15	750X133574	750X133582		750X133XXX
Primary Bar-Type, Single Ratio									
400:5	3.0	2.2	B0.1	--	--	750X133583	750X133591	750X133XXX	750X133XXX
500:5	2.0	1.5	B0.2	--	--	750X133584	750X133592	750X133XXX	750X133XXX
600:5	1.5	1.1	B0.2	--	--	750X133585	750X133593	750X133XXX	750X133XXX
800:5	1.5	1.1	B0.2	--	--	750X133586	750X133594	750X133XXX	750X133XXX
1200:5	1.5	1.1	B0.5	0.15	0.15	750X133587	750X133595	750X133XXX	750X133XXX
1500:5	1.5	1.1	B0.5	0.15	0.15	750X133588	750X133596	750X133XXX	750X133XXX
2000:5	1.0	0.7	B0.5	0.15	0.15	750X133589	750X133597	750X133XXX	750X133XXX
3000:5	1.0	0.7	B0.5	0.15	0.15	750X133590	750X133598	750X133XXX	750X133XXX

600 Volt Current Transformer

Model JAK-0W (Encompass)

Window: 3.06"



Brochure Available at
www.GEITL.com

APPLICATION
Designed for both indoor and outdoor service. Suitable for operating meters and instruments, on both single-phase two-wire circuits and polyphase circuits. The window type transformer can also be used on three-wire single-phase circuits. For use on higher voltage circuits with an insulated primary conductor.

IEEE METER ACCURACY CLASS, 60Hz
B0.1 through B0.50.3, All Models

WEIGHT (approximate)
Window Type Transformer12 lbs
Primary Bar, add3.0 lbs
Low Base, add0.7 lbs
High Base, add1.0 lbs
Height7.185" w/base
Width5.125" w/base 5.63"
Depth2.625"

REFERENCE DRAWINGS
Outline0121C36118

INSULATION LEVEL
0.6kV; BIL 10kV full wave

FREQUENCY
50-60 Hz

JAK-0W DATA TABLE

Current Ratio (Amps) Pri : Sec	IEEE Accuracy Class 60 Hz Burden 0.3 B0.5	Continuous Thermal Current Rating Factor**		Primary Bar	Catalog Number		
		@ 30° C Amb.	@ 55° C Amb.		Low Base	Wide Base	High Base
500:5	200:2 to 2000:20	4.0	3.0	No	750X133629	750X133631	750X133633
500:5	200:2 to 2000:20	4.0	3.0	Yes	750X133630	750X133632	750X133634

** Transformer rated meters must be investigated for use at the lower current range extension.

Model JAH-0C

Window: 4.00"/ 5.75"



APPLICATION
Designed for indoor service. Suitable for operating meters, relays and control devices, on circuits not exceeding 600V line-to-line. It may be used on higher voltage circuits with an insulated conductor.

REGULATORY AGENCY APPROVALS
UL Recognized FileE93779

WEIGHT (approximate)
Transformers with 4.00" window.....11 lbs
Transformers with 5.75" window.....9.5 lbs

DIMENSIONS
Height8.93"
Width8.50"
Depth2.17"

REFERENCE DRAWINGS
Outline0121C33700
Base Assembly0221B00185

INSULATION LEVEL
0.6kV; BIL 10kV full wave.

FREQUENCY
50-60 Hz

JAH-0C DATA TABLE

Current Ratio (Amps) Pri : Sec	IEEE Accuracy Class 60 Hz Burden		Continuous Thermal-Current Rating Factor		Window Diameter (inches)	Catalog Number
	Meter Class	Relay Class	30° C Ambient	55° C Ambient		
200:5	1.2 thru B0.2	C 10	2.0	2.0	4.00	750X114012
250:5	0.6 thru B0.2	C 10	2.0	2.0	4.00	750X114017
300:5	0.3 thru B0.2	C 10	2.0	2.0	4.00	750X114013
400:5	0.3 thru B0.2	C 20	2.0	2.0	4.00	750X114001
500:5	0.3 thru B0.5	C 20	2.0	1.5	4.00	750X114002
600:5	0.3 thru B0.5	C 20	2.0	1.5	4.00	750X114003
800:5	0.3 thru B1.8	C 20	1.5	1.33	4.00	750X114004
1000:5	0.3 thru B1.8	C 20	1.5	1.5	5.75	750X114005
1200:5	0.3 thru B1.8	C 20	1.5	1.33	5.75	750X114006
1500:5	0.3 thru B1.8	C 50	1.5	1.0	5.75	750X114007
2000:5	0.3 thru B1.8	C 50	1.33	1.0	5.75	750X114008
2500:5	0.3 thru B1.8	C 50	1.0	0.8	5.75	750X114009
3000:5	0.3 thru B1.8	C 50	1.0	0.8	5.75	750X114010
4000:5	0.3 thru B1.8	C 50	1.0	0.8	5.75	750X114011

Model JAS-0C

Window: 4.00"



APPLICATION
Designed for indoor service. Suitable for operating meters, relays and control devices, on circuits not exceeding 600V line-to-line. It is intended for use in switchboards and in switchgear equipment. It may be used on higher voltage circuits with an insulated conductor.

REGULATORY AGENCY APPROVALS
UL Recognized FileE93779

CONTINUOUS THERMAL CURRENT RATING FACTOR
30° C Ambient1.33
55° C Ambient1.00

WEIGHT (approximate)
Transformer9 lbs

DIMENSIONS
Height5.89"
Width6.23"
Depth3.28"

REFERENCE DRAWINGS
Outline0121C33703

INSULATION LEVEL
0.6kV; BIL 10kV full wave.

FREQUENCY
50-60 Hz

JAS-0C DATA TABLE

Current Ratio (Amps) Pri : Sec	IEEE Accuracy Class 60 Hz Burden		Secondary Winding Resistance (Ohms @ 75° C)	Catalog Number
	Meter Class	Relay Class		
150:5	1.2 thru B0.2	C 10	0.085	750X114107
200:5	0.6 thru B0.2	C 15	0.113	750X114108
300:5	0.3 thru B0.2	C 25	0.170	750X114109
400:5	0.3 thru B0.5	C 35	0.227	750X114110
500:5	0.3 thru B0.5	C 45	0.283	750X114111
600:5	0.3 thru B1.8	C 50	0.340	750X114101
800:5	0.3 thru B1.8	C 70	0.360	750X114102
1000:5	0.3 thru B1.8	C 80	0.450	750X114103
1200:5	0.3 thru B1.8	C 50	0.680	750X114104
1500:5	0.3 thru B1.8	C 20	0.487	750X114105
1600:5	0.3 thru B1.8	C 20	0.519	750X114112
2000:5	0.3 thru B1.8	C 20	0.649	750X114106

600 Volt Current Transformer

Model JAD-0C

Window: 5.75"

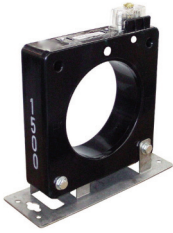

Dimensions do not include Primary Bars

APPLICATION
Designed for both indoor and outdoor service. Suitable for operating meters, instruments and control devices. For use on higher voltage circuits with an insulated primary conductor.

WEIGHT & DIMENSIONS
(approximate)
Transformer, Window Type13 lbs
Transformer, Primary-Bar Type17 lbs
Mounting Base, add 2 lbs
Height 9.87" w/o base
Width 8.50" w/o base
Depth 2.27" w/o base

REFERENCE DRAWINGS
Single Ratio Outline0121C34994
Dual Ratio Outline0121C35099
Bar Assembly 11 7/8" 1 Bar0821C35021-1
2 Bar0821C35021-2
3 Bar0821C35021-3
4 Bar0821C35021-4
Bar Assembly 14 1/2" 1 Bar0821C35021-7
2 Bar0821C35021-8
3 Bar0821C35021-9
4 Bar0821C35021-10
Base Assembly0221A36647
Flushmount Bracket Kit0221A38343

INSULATION LEVEL
0.6kV; BIL 10kV full wave

FREQUENCY
50-60 Hz

JAD-0C DATA TABLE - Window Type

Current Ratio (Amps) Pri : Sec	IEEE Accuracy Class 60 Hz Burden					Continuous Thermal Current Rating Factor		Catalog Number Without Mounting Base	Catalog Number Stainless Steel Base Assembled
	B0.1	B0.2	B0.5	B0.9	B1.8	@ 30°C Amb.	@ 55°C Amb.		
Single Ratio									
200:5	0.6	1.2	--	--	--	4.0	3.0	750X120240	750X120260
300:5	0.3	0.6	1.2	--	--	4.0	3.0	750X120241	750X120261
400:5	0.3	0.3	0.6	--	--	4.0	3.0	750X120242	750X120262
500:5	0.3	0.3	0.6	--	--	4.0	3.0	750X120243	750X120263
600:5	0.3	0.3	0.3	--	--	3.0	2.0	750X120244	750X120264
800:5	0.3	0.3	0.3	--	--	3.0	2.0	750X120001	750X120154
1000:5	0.3	0.3	0.3	0.3	--	2.0	1.5	750X120002	750X120155
1200:5	0.3	0.3	0.3	0.3	--	2.0	1.5	750X120003	750X120156
1500:5	0.3	0.3	0.3	0.3	--	3.0	2.0	750X120180	750X120181
2000:5	0.3	0.3	0.3	0.3	0.3	2.0	1.5	750X120005	750X120158
2500:5	0.3	0.3	0.3	0.3	0.3	1.5	1.0	750X120006	750X120159
3000:5	0.3	0.3	0.3	0.3	0.3	1.5	1.0	750X120007	750X120160
4000:5	0.3	0.3	0.3	0.3	0.3	1.5	1.0	750X120008	750X120161
Dual Ratio									
600/1200:5	0.3	0.3	--	--	--	2.0	1.5	750X120025	750X120162
800/1600:5	0.3	0.3	--	--	--	2.0	1.5	750X120026	750X120163
1000/2000:5	0.3	0.3	0.3	--	--	2.0	1.5	750X120027	750X120164
1500/3000:5	0.3	0.3	0.3	0.3	0.3	1.5	1.0	750X120028	750X120165
2000/4000:5	0.3	0.3	0.3	0.3	0.3	1.5	1.0	750X120029	750X120166

JAD-0C DATA TABLE - Primary-Bar Type

Current Ratio (Amps) Pri : Sec	IEEE Accuracy Class 60 Hz Burden					Continuous Thermal Current Rating Factor		Catalog Number Without Mounting Base		Catalog Number Stainless Steel Base Assembled	
	B0.1	B0.2	B0.5	B0.9	B1.8	@ 30°C Amb.	@ 55°C Amb.	11 7/8" Bar	14 1/2" Bar	11 7/8" Bar	14 1/2" Bar
800:5	0.3	0.3	0.3	--	--	2.0	1.5	750X120201	750X120221	750X120211	750X120231
1000:5	0.3	0.3	0.3	0.3	--	2.0	1.5	750X120202	750X120222	750X120212	750X120232
1200:5	0.3	0.3	0.3	0.3	--	1.5	1.0	750X120203	750X120223	750X120213	750X120233
1500:5	0.3	0.3	0.3	0.3	--	1.5	1.0	750X120204	750X120224	750X120214	750X120234
2000:5	0.3	0.3	0.3	0.3	0.3	1.5	1.0	750X120205	750X120225	750X120215	750X120235
3000:5	0.3	0.3	0.3	0.3	0.3	1.33	1.0	750X120207	750X120227	750X120217	750X120237
4000:5	0.3	0.3	0.3	0.3	0.3	1.2	0.8	750X120208	750X120228	750X120218	750X120238

Model JAD-AC (High Accuracy)

Window: 5.75"



Dimensions do not include Primary Bars

APPLICATION
Designed for both indoor and outdoor service. Suitable for operating meters, instruments and control devices. For use on higher voltage circuits with an insulated primary conductor.

REGULATORY AGENCY APPROVALS
UL RecognizedFile E93779

WEIGHT & DIMENSIONS
(approximate)
Transformer, Window Type13 lbs
Transformer, Primary-Bar Type17 lbs
Mounting Base, add 2 lbs
Height 9.87" w/o base
Width 8.50" w/o base
Depth 2.27" w/o base

REFERENCE DRAWINGS
Single Ratio Outline0121C34994
Dual Ratio Outline0121C35099
Bar Assembly 11 7/8" 1 Bar0821C35021-1
2 Bar0821C35021-2
3 Bar0821C35021-3
4 Bar0821C35021-4
Bar Assembly 14 1/2" 1 Bar0821C35021-7
2 Bar0821C35021-8
3 Bar0821C35021-9
4 Bar0821C35021-10
Base Assembly0221A36647
Flushmount Bracket Kit0221A38343

INSULATION LEVEL
0.6kV; BIL 10kV full wave

FREQUENCY
50-60 Hz

JAD-AC DATA TABLE - Window Type

Current Ratio (Amps) Pri : Sec	IEEE Accuracy Class 60 Hz Burden					Electronic Burden	Continuous Thermal Current Rating Factor		Catalog Number Without Mounting Base	Catalog Number Stainless Steel Base Assembled
	B0.1	B0.2	B0.5	E0.04	E0.2	@ 30°C Amb.	@ 55°C Amb.			
800:5	0.15	0.3	0.3	--	--	3.0	2.0	750X120700	750X120708	
1000:5	0.15	0.15	0.3	0.15	--	2.0	1.5	750X120701	750X120709	
1200:5	0.15	0.15	0.3	0.15	0.15	2.0	1.5	750X120702	750X120710	
1500:5	0.15	0.15	0.15	0.15	0.15	2.0	1.5	750X120703	750X120713	
2000:5	0.15	0.15	0.15	0.15	0.15	2.0	1.5	750X120704	750X120717	
2500:5	0.15	0.15	0.15	0.15	0.15	1.5	1.0	750X120705	750X120718	
3000:5	0.15	0.15	0.15	0.15	0.15	1.5	1.0	750X120706	750X120719	
4000:5	0.15	0.15	0.15	0.15	0.15	1.5	1.0	750X120707	750X120720	

JAD-AC DATA TABLE - Primary-Bar Type

Current Ratio (Amps) Pri : Sec	IEEE Accuracy Class 60 Hz Burden					Electronic Burden	Continuous Thermal Current Rating Factor		Number of Primary Bar	Catalog Number Without Mounting Base		Catalog Number Stainless Steel Base Assembled	
	B0.1	B0.2	B0.5	E0.04	E0.2	@ 30°C Amb.	@ 55°C Amb.	11 7/8" Bar		14 1/2" Bar	11 7/8" Bar	14 1/2" Bar	
800:5	0.15	0.3	0.3	--	--	2.0	1.5	1	750X120721	750X120748	750X120834	750X120841	
1000:5	0.15	0.15	0.3	0.15	--	2.0	1.5	1	750X120722	750X120749	750X120835	750X120842	
1200:5	0.15	0.15	0.3	0.15	0.15	1.5	1.0	1	750X120723	750X120811	750X120836	750X120843	
1500:5	0.15	0.15	0.15	0.15	0.15	1.5	1.0	1	750X120724	750X120812	750X120837	750X120844	
2000:5	0.15	0.15	0.15	0.15	0.15	1.5	1.0	2	750X120725	750X120817	750X120838	750X120845	
3000:5	0.15	0.15	0.15	0.15	0.15	1.3	1.0	3	750X120736	750X120832	750X120839	750X120846	
4000:5	0.15	0.15	0.15	0.15	0.15	1.2	0.8	4	750X120738	750X120833	750X120840	750X120847	

600 Volt Current Transformer

Model JAD-0C

Window: Cross Shaped



APPLICATION
Designed for both indoor and outdoor service. Suitable for operating meters, instruments and control devices. For use on higher voltage circuits with an insulated primary conductor.

WEIGHT & DIMENSIONS
(approximate)
Transformer, Window Type13 lbs
Mounting Base, add2 lbs
Height9.87" w/o base
Width8.50" w/o base
Depth2.27" w/o base

REFERENCE DRAWINGS
Outline0121C35734
Bar Assembly0221A36647
Flushmount Bracket Kit0221A38343

INSULATION LEVEL
0.6kV; BIL 10kV full wave

FREQUENCY
50-60 Hz

Model JAD-0W (Encompass)

Window: 5.75"



Brochure Available at
www.GEIT.com

APPLICATION
Designed for both indoor and outdoor service. Suitable for operating meters, instruments and control devices. For use on higher voltage circuits with an insulated primary conductor.

REGULATORY AGENCY APPROVALS
UL RecognizedFile E93779

WEIGHT & DIMENSIONS
(approximate)
Transformer, Window Type13 lbs
Transformer, Primary-Bar Type17 lbs
Mounting Base, add2 lbs
Height9.87" w/o base
Width8.50" w/o base, 10.75" w/o base
Depth2.27" w/o base, 3.81" w/o base

REFERENCE DRAWINGS
Outline0121C33743

INSULATION LEVEL
0.6kV; BIL 10kV full wave

FREQUENCY
50-60 Hz

Model JCS-0C

Window: 2.50", 4.88", 5.25"



APPLICATION
Designed for indoor service; suitable for operating meters, relays and control devices, on circuits not exceeding 600V line-to-line. It may be used on higher voltage circuits with an insulated conductor.

REGULATORY AGENCY APPROVALS
UL RecognizedFile E93779

WEIGHT (Approximate)
Transformer, Cat No. 750X11003847 lbs.
Transformer, Cat No. 750X110039-04534 lbs.
Transformer, Cat No. 750X110046-07228 lbs.
Optional base plate1.5 lbs.

DIMENSIONS
Height10.15"
Width8.38"
Depth4.62"

REFERENCE DRAWINGS
Outline0121C33697

INSULATION LEVEL
0.6kV; BIL 10kV full wave

FREQUENCY
50-60 Hz

JAD-0C DATA TABLE

Current Ratio (Amps) Pri : Sec	IEEE Accuracy Class 60 Hz Burden					Continuous Thermal Current Rating Factor		Catalog Number Without Mounting Base	Catalog Number Stainless Steel Base Assembled
	B0.1	B0.2	B0.5	B0.9	B1.8	@ 30°C Amb.	@ 55°C Amb.		
Single Ratio									
800:5	0.3	0.3	0.3	--	--	3.0	2.0	750X12009	750X120663
1000:5	0.3	0.3	0.3	0.3	--	2.0	1.5	750X12010	750X120664
1200:5	0.3	0.3	0.3	0.3	--	2.0	1.5	750X12011	750X120665
1500:5	0.3	0.3	0.3	0.3	--	3.0	2.0	750X12013	750X120666
2000:5	0.3	0.3	0.3	0.3	0.3	2.0	1.5	750X12013	750X120667
2500:5	0.3	0.3	0.3	0.3	0.3	1.5	1.0	750X12014	750X120668
3000:5	0.3	0.3	0.3	0.3	0.3	1.5	1.0	750X12015	750X120669
4000:5	0.3	0.3	0.3	0.3	0.3	1.5	1.0	750X12016	750X120670
Dual Ratio									
600/1200:5	0.3	0.3	--	--	--	2.0	1.5	750X12030	750X120671
	0.3	0.3	0.3	--	--	2.0	1.5		
800/1600:5	0.3	0.3	--	--	--	2.0	1.5	750X12031	750X120672
	0.3	0.3	0.3	--	--	2.0	1.5		
1000/2000:5	0.3	0.3	0.3	--	--	2.0	1.5	750X12032	750X120673
	0.3	0.3	0.3	0.3	0.3	1.5	1.0		
1500/3000:5	0.3	0.3	0.3	--	--	2.0	1.5	750X12033	750X120674
	0.3	0.3	0.3	0.3	0.3	1.5	1.0		
2000/4000:5	0.3	0.3	0.3	--	--	2.0	1.5	750X12034	750X120675
	0.3	0.3	0.3	0.3	0.3	1.5	1.0		

JAD-0W DATA TABLE - Window Type

Current Ratio (Amps) Pri : Sec	IEEE Accuracy Class 60 Hz** Burden 0.3 B0.5	Number of Primary Bars	Continuous Thermal Current Rating Factor		Catalog Number	
			@ 30°C Amb.	@ 55°C Amb.	Without Mounting Base	Base Assembled
1000:5	400:2 to 4000:20	Window	4.0	3.0	750X120609	750X120611
1000:5	400:2 to 4000:20	4*	4.0	3.0	750X120610	750X120612

* Bus bars can be removed. Use one bar to 1500 amp ratio, two bars to 2000 amps, three to 3000 amps and four to 4000 amps.

** Transformer rated meters must be investigated for use at the lower current range extension.

JCS-0C DATA TABLE

Current Ratio (Amps) Pri : Sec	IEEE Accuracy Class 60 Hz Burden		Continuous Thermal Current Rating Factor		Window Diameter (inches)	Catalog Number	
	Meter Class	Relay Class	@ 30°C Amb.	@ 55°C Amb.		With Base	Without Base
Single-Ratio							
50:5	2.4 thru B0.2	C20	2.0	2.0	2.50	750X110038	750X110001
100:5	2.4 thru B0.2	C10	2.0	2.0	4.88	750X110039	750X110002
200:5	0.6 thru B0.2	C20	2.0	2.0	4.88	750X110041	750X110004
300:5	0.3 thru B0.2	C50	2.0	2.0	4.88	750X110042	750X110005
400:5	0.3 thru B0.5	C50	2.0	2.0	4.88	750X110043	750X110006
600:5	0.3 thru B0.5	C100	2.0	2.0	4.88	750X110045	750X110008
800:5	0.3 thru B0.9	C100	2.0	2.0	5.25	750X110046	750X110009
1000:5	0.3 thru B0.9	C100	2.0	2.0	5.25	750X110047	750X110010
1200:5	0.3 thru B1.8	C200	2.0	1.5	5.25	750X110048	750X110011
1500:5	0.3 thru B1.8	C200	1.5	1.0	5.25	750X110049	750X110012
1600:5	0.3 thru B1.8	C200	1.33	1.0	5.25	750X110050	750X110013
2000:5	0.3 thru B1.8	C200	1.0	0.8	5.25	750X110051	750X110014
2500:5	0.3 thru B1.8	C200	1.0	0.8	5.25	750X110052	750X110015
3000:5	0.3 thru B1.8	C200	1.0	0.8	5.25	750X110053	750X110016
4000:5	0.3 thru B1.8	C100	1.0	0.8	5.25	750X110054	750X110017
Multi-Ratio (IEEE C57.13)							
1200:5MR	0.3 thru B1.8	C200	2.0	1.5	5.25	750X110069	---
2000:5MR	0.3 thru B1.8	C200	1.0	0.8	5.25	750X110070	---
*2000:5	0.3 thru B1.8	C200	1.0	0.8	5.25	750X110073	---
3000:5MR	0.3 thru B1.8	C200	1.0	0.8	5.25	750X110071	---
4000:5MR	0.3 thru B1.8	C100	1.0	0.8	5.25	750X110072	---

ψ Other window diameters are available for special applications, consult factory

φ Other ratios are available for special applications, consult factory

* Non-standard taps 200/400/600/800/1200/1400/1600/1800/2000:5

600 Volt Current Transformer

Model JCB-0C

Window: 7.25" to 8.125"



APPLICATION
Designed for indoor service. Suitable for operating meters, relays and control devices, on circuits not exceeding 600V line-to-line. It may be used on higher voltage circuits with an insulated conductor.

WEIGHT
Approximate with baseplate8.25 lbs

DIMENSIONS
Height11.25"
Width11.00"
Depth6.00" Max

REFERENCE DRAWINGS
Outline.....0121C33807

INSULATION LEVEL
0.6kV; BIL 10kV full wave

FREQUENCY
50-60 Hz

Model JCP-0C

Window: 5.38"

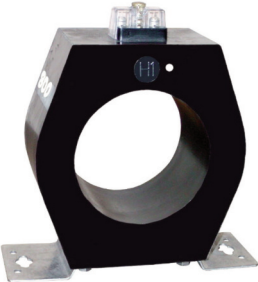

APPLICATION
Designed for indoor and outdoor service. Suitable for operating meters, relays and control devices, on circuits not exceeding 600V line-to-line. It may be used on higher voltage circuits with an insulated conductor.

REGULATORY AGENCY APPROVALS
UL RecognizedFile E93779

WEIGHT (Approximate)
Transformer with baseplate28 lbs

DIMENSIONS
Height11.06"
Width10.75"
Depth4.65"

REFERENCE DRAWINGS
Outline: Single Ratio0121C34439
Outline: Dual Ratio0121C33763

INSULATION LEVEL
0.6kV; BIL 10kV full wave

FREQUENCY
50-60 Hz

Model JCD-0C

Window: 8.13"



APPLICATION
Designed for both indoor and outdoor service. Suitable for operating meters, instruments and control devices. For use on higher voltage circuits with an insulated primary conductor.

REGULATORY AGENCY APPROVALS
UL RecognizedFile E93779

WEIGHT (Approximate)
Transformer, Window Type20 lbs
Mounting Base, add2 lbs

DIMENSIONS
Height12.62"
Width11.00"
Depth3.00"

REFERENCE DRAWINGS
Outline0121C33762

INSULATION LEVEL
0.6kV; BIL 10kV full wave

FREQUENCY
50-60 Hz

JCB-0C DATA TABLE

Current Ratio (Amps) Pri : Sec	IEEE Accuracy Class 60 Hz Burden		Continuous Thermal Current Rating Factor		Catalog Number
	Meter Class	Relay Class	@ 30° C Amb.	@ 55° C Amb.	
Single Ratio					
50:5	2.4 thru B0.1	C10	1.5	1.0	750X211001
100:5	1.2 thru B0.2	C10	1.5	1.0	750X211002
400:5	0.6 thru B0.1	C10	1.5	1.0	750X211003
500:5	0.3 thru B0.1	C20	1.5	1.0	750X211004
600:5	0.3 thru B0.2	C20	1.5	1.0	750X211005
800:5	0.3 thru B0.2	C50	1.5	1.0	750X211006
1000:5	0.3 thru B0.5	C50	1.5	1.0	750X211007
1200:5	0.3 thru B0.5	C50	1.5	1.0	750X211008
1500:5	0.3 thru B0.9	C100	1.5	1.0	750X211009
2000:5	0.3 thru B1.8	C100	1.5	1.0	750X211010
2500:5	0.3 thru B1.8	C100	1.5	1.0	750X211011
3000:5	0.3 thru B1.8	C100	1.5	1.0	750X211012
4000:5	0.3 thru B1.8	C100	1.5	1.0	750X211014
5000:5	0.3 thru B1.8	C100	1.33	1.0	750X211015
6000:5	0.3 thru B1.8	C100	1.0	0.75	750X211016
Multi-Ratio (IEEE C57.13)					
1200:5MR	0.3 thru B0.5	C50	1.5	1.0	750X211021
2000:5MR	0.3 thru B0.5	C100	1.5	1.0	750X211022
3000:5MR	0.3 thru B0.5	C100	1.5	1.0	750X211023
4000:5MR	0.3 thru B0.5	C100	1.5	1.0	750X211024

JCP-0C DATA TABLE

Current Ratio (Amps) Pri : Sec	IEEE Accuracy Class 60 Hz Burden			Relay Class	Continuous Thermal Current Rating Factor @ 30° C Amb.	Catalog Number
	B0.1 to B0.5	B0.9	B1.8			
Single Ratio						
600:5	0.3	0.3	0.3	C100	2.0	750X115002
800:5	0.3	0.3	0.3	C100	2.0	750X115003
1200:5	0.3	0.3	0.3	C200	2.0	750X115005
1500:5	0.3	0.3	0.3	C200	2.0	750X115006
2000:5	0.3	0.3	0.3	C200	1.5	750X115007
3000:5	0.3	0.3	0.3	C200	1.33	750X115009
4000:5	0.3	0.3	0.3	C200	1.33	750X115010
Dual Ratio						
1000/2000:5	0.3	0.6	0.6	C100	2.0	750X115011
	0.3	0.3	0.3	C200	1.5	
1500/3000:5	0.3	0.3	0.6	C100	2.0	750X115012
	0.3	0.3	0.3	C200	1.33	
2000/4000:5	0.3	0.3	0.6	C100	1.5	750X115013
	0.3	0.3	0.6	C100	1.5	

JCD-0C DATA TABLE

Current Ratio (Amps) Pri : Sec	IEEE Accuracy Class 60 Hz Burden		Relay Class	Continuous Thermal Current Rating Factor @ 30° C Amb.	Catalog Number	
	B0.1 to B0.9	B1.8			Without Mounting Feet	Stainless Steel Feet Assembled
Single Ratio						
1500:5	0.3	0.3	C50	3.0	750X131124	750X131125
2000:5	0.3	0.3	C100	2.0	750X131007	750X131033
3000:5	0.3	0.3	C100	2.0	750X131009	750X131035
4000:5	0.3	0.3	C100	1.5	750X131010	750X131036
5000:5	0.3	0.3	C100	1.0	750X131011	750X131037
6000:5	0.3	0.3	C100	1.0	750X131012	750X131038
8000:5	0.3	0.3	C100	1.0	750X131014	750X131040
Dual Ratio						
1000/2000:5	0.3	0.6	C50	2.0	750X131016	750X131042
	0.3	0.3	C100	2.0		
1500/3000:5	0.3	0.6	C50	2.0	750X131017	750X131043
	0.3	0.3	C100	2.0		
2000/4000:5	0.3	0.6	C50	2.0	750X131018	750X131044
	0.3	0.3	C100	1.5		
3000/6000:5	0.3	0.6	C50	1.33	750X131019	750X131032
	0.3	0.3	C100	1.0		

600 Volt Current Transformer

Model CTM-0C SINGLE BAR



APPLICATION
Designed for indoor service. Suitable for operating meters, relays and control devices.

WEIGHT
(approximate)7 lbs

DIMENSIONS
Height4.78"
Width9.38"
Depth3.75"

REFERENCE DRAWINGS (Outlines)
50-400A0121C42881
500-1200A0121C42882

INSULATION LEVEL
0.6kV; BIL 10kV full wave

FREQUENCY
60 Hz

Model CTM-0C DOUBLE BAR

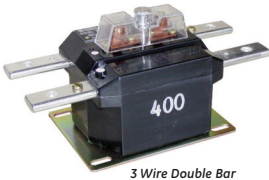

3 Wire Double Bar

APPLICATION
Designed for indoor service. Suitable for operating meters, relays and control devices.

WEIGHT
(approximate)9 lbs

DIMENSIONS
Height4.56"
Width9.37"
Depth4.62"

REFERENCE DRAWINGS (Outlines)
50-400A0121C42883
500-1200A0121C42884

INSULATION LEVEL
0.6kV; BIL 10kV full wave

FREQUENCY
60 Hz

Model JAR-0C Auxiliary CT



APPLICATION
Designed for indoor service; for connection in the secondary circuit of a main current transformer to change the effective ratio seen by meters and relays. Its accuracy is suitable for use with totalizing meters and relays. It is designed for use on circuits not exceeding 600V to ground.

REGULATORY AGENCY APPROVALS
UL RecognizedFile E93779

WEIGHT (approximate)
Transformer10 lbs

DIMENSIONS
Height5.44"
Width5.29"
Depth5.29"

REFERENCE DRAWINGS
Outline0121C33696

INSULATION LEVEL
Because it is used in the secondary circuit of another transformer, it has no voltage rating. These transformers receive a 60Hz, 2.5 kV high potential factory test between each winding and between the windings and ground.

FREQUENCY
50-60 Hz

CTM-0C SINGLE BAR DATA TABLE

Current Ratio (Amps) Pri : Sec	IEEE Accuracy Class 60 Hz Burden	Continuous Thermal Current Rating Factor	Approval Number from CCAC	Catalog Number
	B0.1 to B0.9	@ 30°C Amb.		
5:5*	0.3	1.5	-	430-001
10:5*	0.3	1.5	-	430-002
15:5*	0.3	1.5	-	430-003
20:5*	0.3	1.5	-	430-004
25:5*	0.3	1.5	-	430-005
30:5*	0.3	1.5	-	430-006
40:5*	0.3	1.5	-	430-007
50:5	0.3	1.5	T172-1	430-008
60:5	0.3	1.5	T172-1	430-009
75:5	0.3	1.5	T172-1	430-010
100:5	0.3	1.5	T172-1	430-011
150:5	0.3	1.5	T172-1	430-012
200:5	0.3	1.5	T172-1	430-013
250:5	0.3	1.5	T172-1	430-014
300:5	0.3	1.5	T172-1	430-015
400:5	0.3	1.5	T172	430-016
500:5*	0.3	1.5	-	430-017
600:5*	0.3	1.5	-	430-018
800:5*	0.3	1.5	-	430-019
1000:5*	0.3	1.2	-	430-020
1200:5*	0.3	1.0	-	430-021

* For these models please contact factory for availability and approval number from CCAC for revenue metering application.

CTM-0C DOUBLE BAR DATA TABLE

Current Ratio (Amps) Pri : Sec	IEEE Accuracy Class 60 Hz Burden	Continuous Thermal Current Rating Factor	Approval Number from CCAC	Catalog Number
	B0.1 to B0.2	@ 30°C Amb.		
50/50:5	0.3	1.5	T-156	440-001
100/100:5	0.3	1.5	T-156	440-002
150/150:5	0.3	1.5	T-156	440-003
200/200:5	0.3	1.5	T-156	440-004
300/300:5	0.3	1.5	T-156	440-005
400/400:5	0.3	1.5	T-156	440-006
500/500:5	0.3	1.5	T-286	440-007
600/600:5	0.3	1.5	T-286	440-008
800/800:5	0.3	1.5	T-286	440-009
1000/1000:5*	0.3	1.2	-	440-010
1200/1200:5*	0.3	1.0	-	440-011

* For these models please contact factory for availability and approval number from CCAC for revenue metering application.

JAR-0C DATA TABLE

Continuous Thermal Current Rating Factor 1.5 @ 30°C Ambient, 1.1 @ 55°C Ambient					
IEEE Meter Accuracy Classification, 60 Hz			All Models 0.3 at B0.1 and B0.2		
Current Ratio (in Amps) Pri:Sec ↓	Internal Burden (Short-Circuit Impedance) VA at Rated Current	Catalog Number	Current Ratio (in Amps) Pri:Sec ↓	Internal Burden (Short -Circuit Impedance) VA at Rated Current	Catalog Number
5:0.100	6.0	750X101126	5:6.250	ψ	750X101369
5:0.200	5.7	750X101120	5:7.500	7.3	750X101010
5:0.250	6.8	750X101118	5:8.000	7.7	750X101009
5:0.500	7.0	750X101106	5:10.000	8.5	750X101003
5:0.625	7.2	750X101101	5:12.500	8.9	750X101002
5:1.000	7.8	750X101088	5:15.000	10.7	750X101001
5:1.250	7.8	750X101082	1:000:5	6.8	750X101029
5:1.667	7.8	750X101067	1:667:5	9.0	750X101026
5:2.000	7.8	750X101060	2:500:5	8.2	750X101024
5:2.395	7.8	750X101056	2:875:5	7.0	750X101330
5:2.500	7.3	750X101054	7:500:5	9.1	750X101019
5:2.890	7.1	750X101051	10:000:5	8.5	750X101015
5:3.000	7.8	750X101049	0:500:1	ψ	750X101308
5:3.330	7.5	750X101042	0:923:1	ψ	750X101335
5:3.750	8.0	750X101038	4:000:10	8.3	750X101004
5:4.000	8.5	750X101036	5:6:5 *	8.2	750X101133
5:5.000	8.5	750X101020	5:6:5:5:5 *	8.2	750X101131
5:5.330	8.5	750X101309	5:6:5:5:5:5 *	8.2	750X101129

ψ Refer to factory

↓ Common ratios are listed in the data table; other ratios are available, consult factory.

* Up to six secondary currents can be totalized. Equal or unequal line current transformers can be summed with these transformers. Consult factory with the ratios of the line current transformers to be totalized.

600 Volt Current Transformer

Model 200WP

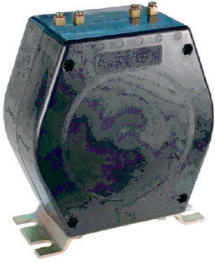

APPLICATION
Designed for indoor service; for connection in the secondary circuit of a main current transformer to change the effective ratio seen by meters and relays. Its accuracy is suitable for use with totalizing meters and relays. It is designed for use on circuits not exceeding 600V to ground.

REGULATORY AGENCY APPROVALS
UL RecognizedFile E93779

WEIGHT (approximate)
Transformer46 lbs

DIMENSIONS
Height9.71"
Width8.38"
Depth4.62"

INSULATION LEVEL
Because it is used in the secondary circuit of another transformer, it has no voltage rating. These transformers receive a 60Hz, 2.5 kV high potential factory test between each winding and between the windings and ground.

FREQUENCY
50-400 Hz

200WP DATA TABLE

Catalog Number	VA ±1% Class	Relay Class	IEEE Accuracy Class 60 Hz Burden				
			B0.1	B0.2	B0.5	B0.9	B1.8
200WP-1-XXX	150	C100	0.3	0.3	0.3	0.3	0.6
200WP-2-XXX	500	C200	0.3	0.3	0.3	0.3	0.3

Ratio	1:5	2.5:5	5:5	7.5:5	10:5	15:5	20:5	25:5	30:5	40:5	50:5
Suffix	001	0025	005	0075	010	015	020	025	030	040	050
									*	*	*

* 1/4-20 Stud terminals

600 Volt Voltage Transformer

Model PTM-0C



APPLICATION
Designed for indoor service; suitable for operating meters, instruments, relays and control devices.

THERMAL RATING (VOLT-AMPERES)
55°C Rise above 30°C Ambient200 VA

WEIGHT (Approximate)
Unfused12.5 lbs

DIMENSIONS
Height4.44"
Width4.38"
Depth4.75"

REFERENCE DRAWINGS
Outline0122C02910

INSULATION LEVEL
0.6kV; BIL 10kV full wave

FREQUENCY
60 Hz

PTM-0C DATA TABLE

Transformer Rating		IEEE Accuracy Class 60 Hz Burden		Approval number from CCAC	Catalog Number
Primary Voltage	Ratio	W	X		
120	1:1	0.3	0.6	T-148-2	420-001
240	2:1	0.3	0.6	T-148-2	420-002
300	2.5:1	0.3	0.6	T-148-2	420-003
360	3:1	0.3	0.6	T-148	420-004
480	4:1	0.3	0.6	T-148-1	420-005
600	5:1	0.3	0.6	T-148	420-006

* For these models please contact factory for availability and approval number from CCAC for revenue metering application.

600 Volt Voltage Transformer

Model JE-27C

Fused & Unfused



APPLICATION
Designed for indoor service; suitable for operating meters, instruments, relays and control devices.

REGULATORY AGENCY APPROVALS
UL RecognizedFile E93779

THERMAL RATING (VOLT-AMPERES)
55°C Rise above 30°C Ambient150 VA
30°C Rise above 55°C Ambient100 VA

WEIGHT
(Approximate)7.8 lbs

DIMENSIONS
Height3.64" unfused, 4.75" w/o cover, 4.88" w/cover
Width4.44" unfused, 4.32" fused
Depth4.75" unfused, 4.32" fused

REFERENCE DRAWINGS
Outline0122C33698

INSULATION LEVEL
0.6kV; BIL 10kV full wave

FREQUENCY
60 Hz

Cover for fused style

Unfused style

JE-27C DATA TABLE

Circuit Line to Line Voltage	Permissible Transformer Primary Connection	Transformer Rating		IEEE Accuracy Class 60 Hz Burden		Catalog Number			Recom Primary Fuse Rating Amps
		Primary Voltage (1)	Ratio	Operated at Rated Voltage	Operated at 58% of Rated Voltage	Not Fused	Primary Fuses Only	Primary and Secondary Fuses	
120	Y only	69.3	0.578:1	0.6W/1.2X	2.4 X	760X190001	760X190021	760X190041	5.0
120/208	Δ or Y/Y only	120	1:1	0.6W/1.2X	2.4 X	760X190002	760X190022	760X190042	4.0
120/208	Δ or Y/Y only	120	1.732:1	0.6W/1.2X	2.4 X	760X190003	760X190023	760X190043	2.0
208	Δ or Y	207.8	1.732:1	0.6W/1.2X	2.4 X	760X190004	760X190024	760X190044	2.0
240/416	Δ or Y/Y only	240	2:1	0.6W/1.2X	2.4 X	760X190005	760X190025	760X190045	2.0
480	Y only	288	2.4:1	0.6W/1.2X	2.4 X	760X190007	760X190027	760X190047	1.5
480	Y only	300	2.5:1	0.6W/1.2X	2.4 X	760X190008	760X190028	760X190048	1.5
480/832	Δ or Y/Y only	480 ψ	4:1	0.6W/1.2X	2.4 X	760X190009	760X190029	760X190049	1.0
600/1040	Δ or Y/Y only	600 ψ	5:1	0.6W/1.2X	2.4 X	760X190010	760X190030	760X190050	0.75

Notes:

For continuous operation, the transformer rated primary voltage should not be exceeded by more than 10%. Under emergency conditions, over-voltage must be limited to 1.25 times the transformer primary voltage rating, except those marked ψ , which must not exceed 110% rated voltage.

Model JVA-0C

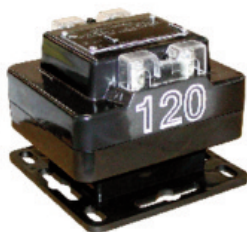

APPLICATION
Designed for indoor and outdoor service; suitable for operating meters, instruments, relays and control devices.

THERMAL RATING (VOLT-AMPERES)
55°C Rise above 30°C Ambient500 VA
30°C Rise above 55°C Ambient300 VA

WEIGHT (Approximate)
Unfused12.5 lbs

DIMENSIONS
Height4.85"
Width6.14"
Depth6.00"

REFERENCE DRAWINGS
Outline0122C34133

FREQUENCY
50/60 Hz

JVA-0C DATA TABLE

Circuit Line to Line Voltage Permissible	Transformer Rating (3)			IEEE Accuracy Class 60 Hz Burden				Catalog Number	Recommended Primary Fuse Rating Amps	
				Burden (1)		Burden (2)				
Δ (1)	ψ (2)	ψ (4)	Primary Voltage	Ratio	W,X,M	Y	W	X		
120	120	208	120	1:1	0.3	0.6	0.3	0.6	760X134001	10.0
240	240	416	240	2:1	0.3	0.6	0.3	0.6	760X134002	6.0
---	---	480	288	2.4:1	0.3	0.6	---	---	760X134004	6.0
---	---	480	300	2.5:1	0.3	0.6	---	---	760X134005	6.0
480	480	---	480	4:1	0.3	0.6	0.3	0.6	760X134006	3.0
600	600	---	600	5:1	0.3	0.6	0.3	0.6	760X134007	3.0

(1) Operated at rated voltage; secondary at 120 V.

(2) Operated at 58% of rated voltage; secondary at 69.3 V.

(3) For continuous operation, the transformer rated primary voltage should not be exceeded by more than 10%. Under emergency conditions, over-voltage must be limited to 1.25 times the transformer primary voltage rating.

(4) For Y connections, it is preferred practice to connect one lead from each voltage transformer directly to the grounded neutral, using a fuse only in the line side of the primary. By this connection a transformer can never be "alive" from the line side by reason of a blown fuse on the grounded side.

* Comes standard with molded base. Contact factory for stainless steel base option.

600 Volt Voltage Transformer

Model JEV-0C Fused

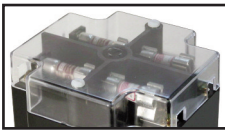

Clear Plastic Cover

APPLICATION
Designed for indoor service; suitable for operating meters, instruments, relays and control devices.

REGULATORY AGENCY APPROVALS
UL RecognizedFile E93779

THERMAL RATING (VOLT-AMPERES)
55°C Rise above 30°C Ambient300 VA
30°C Rise above 55°C Ambient200 VA

WEIGHT
(Approximate)12.5 lbs

DIMENSIONS
Height6.33" w/o cover, 6.50" w/cover
Width4.75"
Depth4.38"

REFERENCE DRAWINGS
Outline0122C33699

INSULATION LEVEL
0.6kV; BIL 10kV full wave

FREQUENCY
60 Hz

JEV-0C DATA TABLE

Circuit Line to Line Voltage	Permissible Transformer Primary Connection	Transformer Rating		IEEE Accuracy Class 60 Hz Burden		Catalog Number			Recom Primary Fuse Rating
		Primary Voltage (1)	Ratio	Operated at Rated Voltage	Operated at 58% of Rated Voltage	Not Fused	Primary Fuses Only	Primary and Secondary Fuses	Amps
120	Y only	69.3	0.578:1	0.3W, 0.6X, 1.2M	0.6W, 1.2X	760X235001	760X235021	760X235041	10.0
120/208	Δ or Y / Y only	120	1:1	0.3W, 0.6X, 1.2M	0.6W, 1.2X	760X235002	760X235022	760X235042	6.0
208	Δ or Y	207.8	1.732:1	0.3W, 0.6X, 1.2M	0.6W, 1.2X	760X235003	760X235023	760X235043	4.0
240/416	Δ or Y / Y only	240	2:1	0.3W, 0.6X, 1.2M	0.6W, 1.2X	760X235004	760X235024	760X235044	4.0
480	Y only	288	2.4:1	0.3W, 0.6X, 1.2M	0.6W, 1.2X	760X235005	760X235025	760X235045	3.0
480	Y only	300	2.5:1	0.3W, 0.6X, 1.2M	0.6W, 1.2X	760X235006	760X235026	760X235046	3.0
480/832	Δ or Y / Y only	480 ψ	4:1	0.3W, 0.6X, 1.2M	0.6W, 1.2X	760X235008	760X235028	760X235048	2.0
600/1040	Δ or Y / Y only	600 ψ	5:1	0.3W, 0.6X, 1.2M	0.6W, 1.2X	760X235009	760X235029	760X235049	1.5

Notes:

For continuous operation, the transformer rated primary voltage should not be exceeded by more than 10%. Under emergency conditions, over-voltage must be limited to 1.25 times the transformer primary voltage rating; except those marked ψ , which must not exceed 110% rated voltage.

Model JVM-0C Fused & Unfused



Unfused Version



1 Fuse Version



2 Fuse Version

APPLICATION
Designed for indoor service; suitable for operating meters, instruments, relays and control devices. Unfused models are suitable for outdoor service.

REGULATORY AGENCY APPROVALS
UL RecognizedFile E93779

THERMAL RATING (VOLT-AMPERES)
55°C Rise above 30°C Ambient750 VA
30°C Rise above 55°C Ambient500 VA

WEIGHT
(Approximate)25 lbs

DIMENSIONS
Height6.12" unfused
.....7.38" fused w/o cover
.....7.50" fused w cover
Width6.00"
Depth6.54"

REFERENCE DRAWINGS
Outline0122C33702

INSULATION LEVEL
0.6kV; BIL 10kV full wave

FREQUENCY
60 Hz

JVM-0C DATA TABLE

Circuit Line to Line Voltage	Permissible Transformer Primary Connection	Transformer Rating		IEEE Accuracy Class 60 Hz Burden		Catalog Number			Recom Primary Fuse Rating
		Primary Voltage (1)	Ratio	Operated at Rated Voltage	Operated at 58% of Rated Voltage	Not Fused	Primary Fuses Only	Primary and Secondary Fuses	Amps
120	Y only	69.3	0.578:1	0.3W, 0.6X, M&Y	0.6W, 1.2M	760X133001	760X133021	760X133041	15.0
120/208	Δ or Y / Y only	120	1:1	0.3W, 0.6X, M&Y	0.6W, 1.2M	760X133002	760X133022	760X133042	10.0
120/208	Δ or Y / Y only	120	1.732:1	0.3W, 0.6X, M&Y	0.6W, 1.2M	760X133003	760X133023	760X133043	10.0
208	Δ or Y	207.8	1.732:1	0.3W, 0.6X, M&Y	0.6W, 1.2M	760X133004	760X133024	760X133044	8.0
240/416	Δ or Y / Y only	240	2:1	0.3W, 0.6X, M&Y	0.6W, 1.2M	760X133005	760X133025	760X133045	8.0
480	Y only	288	2.4:1	0.3W, 0.6X, M&Y	0.6W, 1.2M	760X133006	760X133026	760X133046	6.0
480	Y only	300	2.5:1	0.3W, 0.6X, M&Y	0.6W, 1.2M	760X133007	760X133027	760X133047	6.0
480/832	Δ or Y / Y only	480 ψ	4:1	0.3W, 0.6X, M&Y	0.6W, 1.2M	760X133008	760X133028	760X133048	4.0
600/1040	Δ or Y / Y only	600 ψ	5:1	0.3W, 0.6X, M&Y	0.6W, 1.2M	760X133009	760X133029	760X133049	3.0

Notes:

(1) For continuous operation, the transformer's rated primary voltage should not be exceeded by more than 10%. Under emergency conditions, over-voltage must be limited to 1.25 times the transformer primary voltage rating; except those marked ψ , which must not exceed 110% rated voltage.

Split Core CT

Models 606 & 608 Split Core



REGULATORY AGENCY APPROVALS



Manufactured to meet the requirements of ANSI/IEEE C57.13. Classified by U.L. in accordance with IEC 44-1

APPLICATION
For energy management systems and instrumentation.

FREQUENCY:
50-400 Hz

INSULATION LEVEL:
0.6 kv, BIL 10 kv full wave.

CONTINUOUS THERMAL CURRENT RATING FACTOR:
Model 606:
1.33 at 30°C. amb., 1.0 at 55°C. amb.

Model 608-501 thru 608-202:
1.33 at 30°C. amb., 1.0 at 55°C. amb.

Model 608-252 thru 608-322:
1.0 at 30°C. amb., 0.7 at 55°C. amb.

WEIGHT
Model 606 (Approximate).....4.5 lbs
Model 608 (Approximate).....7.5 lbs

Secondary Cable: Two No. 16 AWG 6 feet long,
Direct Burial, U.V. Res. U.L. Type TC.

These current transformers are a weather proof design suitable for use outdoor or in direct burial applications. The transformer cases are UV stabilized thermoplastic and filled with polyurethane resin. The mating surfaces of the transformer core are protected by a rubber "O" ring.

These transformers are designed for assembly to an existing electrical installation without the need for dismantling the primary bus or cables.

Caution:
Proper safety precautions must be followed during installation by a trained electrician. Never install while bus is energized.

The current transformer must have its secondary terminals short circuited or the burden connected, before energizing the primary circuit.

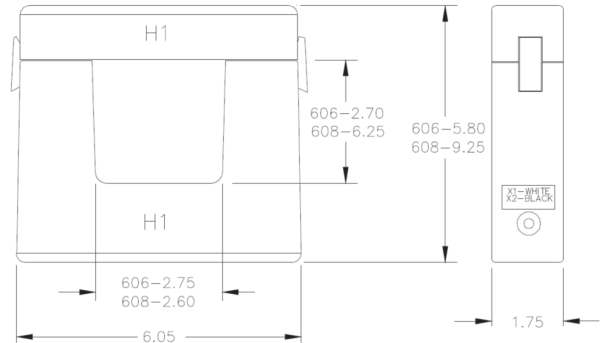

MODEL 606			
CATALOG NUMBER	CURRENT RATIO	BURDEN VA	ACCURACY AT 60 HZ
606-201	200:5	2.5	2 %
606-251	250:5	3.0	1 %
606-301	300:5	3.5	1 %
606-351	350:5	4.0	1 %
606-401	400:5	5.0	1 %
606-501	500:5	6.0	1 %
606-601	600:5	8.0	1 %
606-751	750:5	10.0	1 %
606-801	800:5	12.0	1 %
606-102	1000:5	15.0	1 %
606-122	1200:5	20.0	1 %

MODEL 608			
CATALOG NUMBER	CURRENT RATIO	BURDEN VA	ACCURACY AT 60 HZ
608-501	500:5	6.0	1 %
608-601	600:5	8.0	1 %
608-801	800:5	12.0	1 %
608-102	1000:5	13.0	1 %
608-122	1200:5	16.0	1 %
608-152	1500:5	25.0	1 %
608-162	1600:5	27.0	1 %
606-202	2000:5	33.0	1 %
608-252	2500:5	42.0	1 %
608-302	3000:5	50.0	1 %
608-322	3200:5	54.0	1 %

BUSHING-TYPE CT'S (BCT)

TYPE B07 CAST RESIN



Brochure Available at
www.GEITL.com

APPLICATION

Type B07- Current Transformers are for use over outdoor bushings of Power Transformers, Bulk Oil Circuit Breakers and other Dead -Tank Circuit Breakers.

The B07 bushing type mounts externally over the apparatus bushing on the cover of the apparatus. These transformers are used primarily for relaying but may also be used for metering where rating allows.

FEATURES

Conforms to IEEE Std., C57.13 or IEC, 60044-1.

Weather proof glass polyester outdoor terminal box

Conduit connections - Two 1" threaded hubs for horizontal take-off and a 1" IPS knockout in the bottom

Stainless steel or aluminum, nameplate

Broad range of sizes and ratios

Weather resistant

High mechanical impact and dielectric strength

Completely encapsulated in polyurethane

Easily installed

Clearly identified secondary terminals

Mounting clamps included

CUSTOM TAPED DESIGN

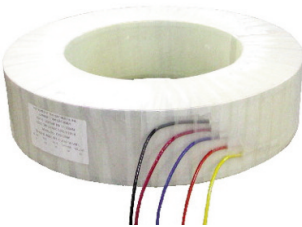

Mylar Tape Construction Shown

Application

May be used in oil, above oil, under cans, or indoor applications

Tape Wrapped BCTS

600 V Class, 10 kV BIL, 60 Hz
Oil = Taped & varnish construction
Non Oil = Mylar construction

Features

Economical design for custom-fit to purchaser's size and electrical rating requirements

For use around apparatus bushings indoor, or internally mounted applications in transformer oil, or above the oil, inside of circuit breakers or power transformers. Design manufactured for custom-fit applications in current transformer pocket areas inside of electrical equipment.

Ratios may be supplied as single-ratios, dual-ratio, or multi-ratio per standard IEEE taps. (Non-standard taps also available)

Nameplate affixed to unit, with pertinent information and polarity marking

Conforms to IEEE Standard C57.13

Typical excitation data available upon request

Lead wire length per customer specification

B07 Standard Current Transformers Selection Guide

Catalog Number	Ratio	Relaying Accuracy	Inside Dia.	Outside Dia.	Height Max.	Approx. Weight
B07-601-12	600:5MR	C400	12.00	24.75	4.50	245 lbs.
B07-601-18	600:5MR	C400	18.00	31.00	4.50	340 lbs.
B07-601-20	600:5MR	C400	20.00	33.00	4.25	355 lbs.
B07-601-22	600:5MR	C400	22.00	35.00	4.25	385 lbs.
B07-601-26	600:5MR	C400	26.00	39.00	4.25	425 lbs.
B07-601-28	600:5MR	C400	28.00	40.75	4.25	450 lbs.
B07-601-32	600:5MR	C400	32.00	43.50	5.00	475 lbs.
B07-122-12	1200:5MR	C800	12.00	24.75	4.50	233 lbs.
B07-122-18	1200:5MR	C800	18.00	30.75	4.50	307 lbs.
B07-122-20	1200:5MR	C800	20.00	32.75	4.50	331 lbs.
B07-122-22	1200:5MR	C800	22.00	34.75	4.50	356 lbs.
B07-122-26	1200:5MR	C800	26.00	38.75	4.50	406 lbs.
B07-122-28	1200:5MR	C800	28.00	40.75	4.50	429 lbs.
B07-122-32	1200:5MR	C800	32.00	43.50	4.75	460 lbs.
B07-202-12	2000:5MR	C800	12.00	24.75	3.75	200 lbs.
B07-202-18	2000:5MR	C800	18.00	30.75	3.75	240 lbs.
B07-202-20	2000:5MR	C800	20.00	32.75	3.75	255 lbs.
B07-202-22	2000:5MR	C800	22.00	31.00	3.75	275 lbs.
B07-202-26	2000:5MR	C800	26.00	38.75	3.75	315 lbs.
B07-202-28	2000:5MR	C800	28.00	40.75	3.75	325 lbs.
B07-202-32	2000:5MR	C800	32.00	43.50	3.75	355 lbs.
B07-302-12	3000:5MR	C800	12.00	24.75	3.75	144 lbs.
B07-302-18	3000:5MR	C800	18.00	30.75	3.75	189 lbs.
B07-302-20	3000:5MR	C800	20.00	32.75	3.75	202 lbs.
B07-302-22	3000:5MR	C800	22.00	34.75	3.75	215 lbs.
B07-302-26	3000:5MR	C800	26.00	38.75	3.75	243 lbs.
B07-302-28	3000:5MR	C800	28.00	40.75	3.75	257 lbs.
B07-302-32	3000:5MR	C800	32.00	43.50	3.75	268 lbs.

* CONSULT FACTORY FOR OTHER SIZES & RATINGS

** ALL DIMENSIONS ARE ± 0.25 TOLERANCE.

B07 Standard Multi-Ratio Taps

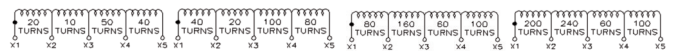

Nominal Ratio - 600:5

Nominal Ratio - 1200:5

Nominal Ratio - 2000:5

Nominal Ratio - 3000:5

Ratio	Secondary Taps	Ratio	Secondary Taps	Ratio	Secondary Taps	Ratio	Secondary Taps
600.5	X1-X5	1200.5	X1-X5	2000.5	X1-X5	3000.5	X1-X5
500.5	X2-X5	1000.5	X2-X5	1600.5	X2-X5	2500.5	X1-X4
450.5	X3-X5	900.5	X3-X5	1500.5	X1-X4	2200.5	X1-X3
400.5	X1-X4	800.5	X1-X4	1200.5	X1-X3	2000.5	X2-X5
300.5	X2-X4	600.5	X2-X4	1100.5	X2-X4	1500.5	X2-X4
250.5	X3-X4	500.5	X3-X4	800.5	X2-X3	1200.5	X2-X3
200.5	X4-X5	400.5	X4-X5	500.5	X4-X5	1000.5	X1-X2
150.5	X1-X3	300.5	X1-X3	400.5	X1-X2	800.5	X3-X5
100.5	X1-X2	200.5	X1-X2	300.5	X3-X4	500.5	X4-X5
50.5	X2-X3	100.5	X2-X3			300.5	X3-X4

* NON-STANDARD ANSI TAPS ARE ALSO AVAILABLE

Medium Voltage Instrument Transformers 5-69kV

GE MV Insulations:

POLYURETHANE - Ideal for Indoor applications, 600V - 35kV

HCEP - Hydrophobic Cycloaliphatic Epoxy - Ideal for outdoor applications, 15kV.

HY-BUTE-60 - Over 50 year's of dependable service. Ideal for outdoor applications from 5-69kV. Available in Accubute™, offering improved accuracy and extended range performance.

SUPER-BUTE® - Premium outdoor product, combining the best of epoxy and HY-BUTE insulations to create the highest flexibility, quality and performance for 25 - 69kV. Ideal for substations, with better characteristics than oil-filled options including:

- Less Maintenance
- Compact Size
- Low Weight
- Mounting Flexibility
- Improved Safety
- High Reliability
- High Over-current Capability
- Higher Thermal Ratings



Visit www.geiti.com to view product information and learn more about our diverse MV offerings.

Available Accubute® and Super-Accubute® Instrument Transformers*

Voltage Transformers						Current Transformers					
Indoor			Outdoor			Indoor			Outdoor		
BIL (kV)	NSV (kV)	Model	BIL (kV)	NSV (kV)	Model	BIL (kV)	NSV (kV)	Model	BIL (kV)	NSV (kV)	Model
75	7.2	JVM-4A	75	7.2	JVW-4A	60	5	JCM-3A	60	5	JCW-3A
110	14.4	JVM-5A	110	14.4	JVW-5A	60	5	JKM-3A	60	5	JKW-3A
125	24	JVM-6A	125	24	JVW-6A	60	5	JCB-3A	60	5	JCD-3A
			150	34.5	JVW-7A	75	8.7	JKM-4A	75	8.7	JKW-4A
			150	24	JVT / JVS	75	8.7	JCM-4A	75	8.7	JCW-4A
			200	34.5	JVT / JVS	75	8.7	JCB-4A	75	8.7	JCD-4A
			250	46	JVT / JVS	110	15	JKM-5A	110	15	JKW-5A
			350	69	JVT / JVS	110	15	JCM-5A	110	15	JCW-5A
						110	15	JCB-5A	110	15	JCD-5A
									150	25	JKW-6A
									150	24	JKW-150A
									200	34.5	JKW-200A
									250	46	JKW-250A
									350	69	JKW-350A

Since its introduction in 1991, GE's Accubute portfolio has expanded to include all voltage and BIL classes shown. Many versions of GE's 24-69 kV substation Super-Bute® line are offered as high accuracy Super-Accubute® transformers. Additional models and voltage classes may be available with Accubute technology upon request.



An industry leader in high accuracy since 1991.



High accuracy in a dry-type substation transformer since 1994.

ITI Disclaimer

Please note, as part of our continuing effort to offer innovative products, GE reserves the right to change details contained in this publication at our discretion and without notice. While every effort has been made to provide accurate information, GE is not responsible for any potential errors, misrepresentation or missing information. Please verify all specifications with your local GE representative prior to placing a purchase order.

Medium Voltage Current Transformers

Model JCM-2

2.5kV, 45kV BIL, 1200-4000A

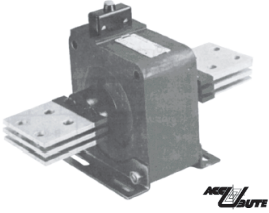

APPLICATION
Designed for indoor service; Suitable for operating meters, instruments and control devices.

WEIGHT
(Approximate, in pounds)
Transformer, without base37

DIMENSIONS
Height8.75"
Width7.00"
Length14.50"

INSULATION
Hy-Bute-60

FREQUENCY
50-60 Hz

JCM-2 DATA TABLE

Current Ratio (Amps) Pri : Sec	IEEE Accuracy Class, 60 Hz		Continuous Thermal Current Rating Factor	Catalog Number
	IEEE Accuracy Class 60 Hz Burden	Relay Class		
	B0.1 to B2.0		@ 30° C Amb.	
Single Ratio				
400:5	0.3	C200	1.33	752X020001
500:5	0.3	C200	1.33	752X020002
600:5	0.3	C200	1.33	752X020003
800:5	0.3	C200	1.33	752X020004
1000:5	0.3	C200	1.33	752X020005
1200:5	0.3	C200	1.33	752X020006
1500:5	0.3	C200	1.33	752X020007
2000:5	0.3	C200	1.33	752X020008
3000:5	0.3	C200	1.33	752X020010
4000:5	0.3	C200	1.0	752X020011

Model JKC-3

5kV, 60kV BIL, 10-1200A



APPLICATION
Designed for indoor service; Suitable for operating meters, instruments and control devices.

WEIGHT
(Approximate, in pounds)
Transformer, without base16

DIMENSIONS
Height6.625"
Width5.813"
Length13.00"

INSULATION
Hy-Bute-60

FREQUENCY
50-60 Hz

JKC-3 DATA TABLE

Current Ratio (Amps) Pri : Sec	IEEE Accuracy Class 60 Hz Burden		Continuous Thermal Current Rating Factor		Mech. Limit Amps 1.285	One Second Thermal Limit, Amps	Catalog Number
	Meter Class	Relay Class					
	B0.1 to B0.5		@ 30° C Amb.	@ 55° C Amb.			
Single Ratio							
10:5	0.3	T50	1.5	1.0	1285	700	753X002001
15:5	0.3	T50	1.5	1.0	1260	1050	753X002002
20:5	0.3	T50	1.5	1.0	2780	1400	753X002003
25:5	0.3	T50	1.5	1.0	3700	1750	753X002004
30:5	0.3	T50	1.5	1.0	4040	2100	753X002005
40:5	0.3	T50	1.5	1.0	5340	2800	753X002006
50:5	0.3	T50	1.5	1.0	5310	3500	753X002007
75:5	0.3	T50	1.5	1.0	8950	5250	753X002008
100:5	0.3	T50	1.5	1.0	11900	7000	753X002009
150:5	0.3	T50	1.5	1.0	18350	12000	753X002010
200:5	0.3	T50	1.5	1.0	24400	14000	753X002011
300:5	0.3	T50	1.5	1.0	36700	22500	753X002012
400:5	0.3	T50	1.5	1.0	49300	26400	753X002013
600:5	0.3	T50	1.5	1.0	104000	56400	753X002014
800:5	0.3	T50	1.5	1.0	104000	52800	753X002015
1200:5	0.3	T50	1.0	0.75	108000	56400	753X002017

Medium Voltage Current Transformers

Model JKS-3

5kV, 60kV BIL, 15-800A



APPLICATION
 Designed for indoor service; suitable for operating relays and control devices. It has been designed with extra-high mechanical and thermal ratings to adapt it to this application.

Weight - Net (approximate, in pounds)
 Single-Secondary30
 Dual-Secondary62
 Tapped-Secondary30

DIMENSIONS
 Height7.625"
 Width5.50"
 Length15.00"

INSULATION
 Hy-Bute-60

FREQUENCY
 50-60 Hz

JKS-3 DATA TABLE

Current Ratio (Amps) Pri : Sec	IEEE Accuracy Class 60 Hz Burden				Relay Class	Continuous Thermal Current Rating Factor		Mech. Limit Amps	One Second Thermal Limit, Amps		Catalog Number
	Meter Class					@ 30°C Amb.	@ 55°C Amb.		With Secondary Short-Circuited	With Burden 8-0.2 or Greater	
	B0.1	B0.5	B2.0								
Single Ratio											
15:5	0.6	1.2	---	T10	1.5	1.0	12500	1700	6400	753X001001	
20:5	0.6	1.2	---	T20	1.5	1.0	12500	2000	6400	753X001002	
25:5	0.6	1.2	---	T10	1.5	1.0	22000	2500	12800	753X001003	
30:5	0.6	1.2	---	T20	1.5	1.0	22000	3000	12800	753X001004	
40:5	0.3	0.6	---	T20	1.5	1.0	22000	4000	12800	753X001005	
50:5	0.6	1.2	---	T10	1.5	1.0	44000	5000	25200	753X001006	
75:5	0.6	1.2	---	T20	1.5	1.0	59000	7500	35300	753X001007	
100:5	0.3	0.6	---	T20	1.5	1.0	59000	10000	35300	753X001008	
150:5	0.3	0.3	---	T50	1.5	1.0	66000	15000	35300	753X001009	
200:5	0.3	0.3	1.2	T50	1.5	1.0	66000	20000	35300	753X001010	
300:5	0.3	0.3	1.2	T50	1.5	1.0	77000	30000	35300	753X001012	
400:5	0.3	0.3	0.3	T100	1.5	1.0	77000	35300	35300	753X001013	
600:5	0.3	0.3	0.3	T100	1.5	1.0	108000	50400	50400	753X001015	
800:5	0.3	0.3	1.2	T50	1.5	1.0	280000	59200	59200	753X001016	
Dual-Secondary											
15:5 //5	0.6	1.2	---	T10	1.5	1.1	12500	1700	6400	753X001024	
20:5 //5	0.6	1.2	---	T20	1.5	1.1	12500	2000	6400	753X001025	
25:5 //5	0.6	1.2	---	T10	1.5	1.1	22000	2500	12800	753X001026	
30:5 //5	0.6	1.2	---	T20	1.5	1.1	22000	3000	12800	753X001027	
40:5 //5	0.3	0.6	---	T20	1.5	1.1	22000	4000	12800	753X001028	
50:5 //5	0.6	1.2	---	T10	1.5	1.1	44000	5000	25200	753X001029	
75:5 //5	0.6	1.2	---	T20	1.5	1.1	59000	7500	35300	753X001030	
100:5 //5	0.3	0.6	---	T20	1.5	1.1	59000	10000	35300	753X001031	
150:5 //5	0.3	0.6	---	T50	1.5	1.1	66000	15000	35300	753X001032	
200:5 //5	0.3	0.3	1.2	T50	1.5	1.1	66000	20000	35300	753X001033	
300:5 //5	0.3	0.3	1.2	T50	1.5	1.1	77000	30000	35300	753X001035	
400:5 //5	0.3	0.3	0.3	T100	1.5	1.1	77000	35300	35300	753X001036	
600:5 //5	0.3	0.3	0.3	T100	1.5	1.1	108000	50400	50400	753X001038	
800:5 //5	0.3	0.3	1.2	T50	1.5	1.1	280000	59200	59200	753X001039	
Tapped-Secondary											
50/100:5	1.2	2.4	---	T10	1.5	1.1	44000	Refer to Factory for Values		753X001017	
	0.6	0.6	---	T20	1.5	1.1	44000				
75/150:5	0.6	1.2	---	T20	1.5	1.1	59000			753X001018	
	0.3	0.6	---	T50	1.5	1.1	59000				
100/200:5	0.6	1.2	---	T20	1.5	1.1	59000			753X001019	
	0.3	0.3	1.2	T50	1.5	1.1	59000				
150/300:5	0.3	0.6	2.4	T20	1.5	1.1	66000			753X001020	
	0.3	0.3	1.2	T50	1.5	1.1	66000				
200/400:5	0.3	0.6	2.4	T50	1.5	1.1	66000			753X001021	
	0.3	0.3	0.3	T100	1.5	1.1	66000				
300/600:5	0.3	0.6	2.4	T50	1.5	1.1	77000			753X001022	
	0.3	0.3	0.3	T100	1.5	1.1	77000				
400/800:5	0.6	1.2	---	T20	1.5	1.1	77000	753X001023			
	0.3	0.3	1.2	T50	1.5	1.1	77000				

Medium Voltage Current Transformers

Model JKM-3C

5kV, 60kV BIL, 5-800A

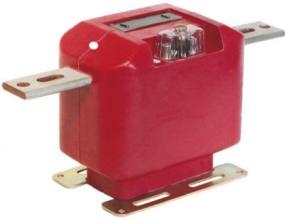

APPLICATION
Designed for indoor service; Suitable for operating meters, instruments and control devices.

WEIGHT
(Approximate)30 lbs

DIMENSIONS
Height8.00" unfused
Width15.00"
Depth5.50"

REFERENCE DRAWINGS
Outline0163C34456

INSULATION LEVEL
5kV; BIL 60kV full wave

INSULATION
Polyurethane

FREQUENCY
50-60 Hz

* Higher current ratios available. Contact factory for more information

* Also available in premium Hy-Bute-60

Model JKM-4C

8.7kV, 75kV BIL, 5-800A

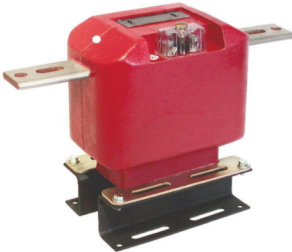

APPLICATION
Designed for indoor service; Suitable for operating meters, instruments and control devices.

WEIGHT
(Approximate)42 lbs

DIMENSIONS
Height10.25"
Width16.00"
Depth5.20"

REFERENCE DRAWINGS
Outline0163C34461

INSULATION LEVEL
8.7kV; BIL 75kV full wave

INSULATION
Polyurethane

FREQUENCY
50-60 Hz

* Higher current ratios available. Contact factory for more information

* Also available in premium Hy-Bute-60

JKM-3C DATA TABLE

Current Ratio (Amps) Pri : Sec	IEEE Accuracy Class 60 Hz Burden		Relay Class	Continuous Thermal Current Rating Factor		Primary Bar Size		One Second Thermal Limit, Amps	Mech. Limit Amps	Catalog Number
	Meter Class			@ 30° C Amb.	@ 55° C Amb.	Width ins.	Thick ins.			
	B0.1 to B0.5	B0.9 to 1.8		Single Ratio						
5:5	0.3	0.3	T100	1.5	1.0	1.50	0.188	465	550	753X140023
10:5	0.3	0.3	T100	1.5	1.0	1.50	0.188	930	1100	753X140024
15:5	0.3	0.3	T100	1.5	1.0	1.50	0.188	1470	1650	753X140025
20:5	0.3	0.3	T100	1.5	1.0	1.50	0.188	1850	2200	753X140026
25:5	0.3	0.3	T100	1.5	1.0	1.50	0.188	2300	2750	753X140027
30:5	0.3	0.3	T100	1.5	1.0	1.50	0.188	2450	3300	753X140028
40:5	0.3	0.3	T100	1.5	1.0	1.50	0.188	3700	4400	753X140029
50:5	0.3	0.3	T100	1.5	1.0	1.50	0.188	4600	5500	753X140030
75:5	0.3	0.3	T100	1.5	1.0	1.50	0.188	6400	8250	753X140032
100:5	0.3	0.3	T100	1.5	1.0	1.50	0.188	8600	11000	753X140033
150:5	0.3	0.3	T100	1.5	1.0	1.50	0.188	12800	16500	753X140035
200:5	0.3	0.3	T100	1.5	1.0	2.00	0.25	17300	22000	753X140036
300:5	0.3	0.3	T100	1.5	1.0	2.00	0.25	25700	33000	753X140038
400:5	0.3	0.3	T100	1.5	1.0	2.00	0.25	36000	44000	753X140039
500:5	0.3	0.3	T100	1.33	1.0	2.00	0.38	43100	47000	753X140040
600:5	0.3	0.3	T100	1.5	1.0	2.00	0.38	51500	66000	753X140041
800:5	0.3	0.3	T100	1.33	1.0	2.00	0.38	63300	70500	753X140042
Tapped Secondary										
50/100:5	0.3	---	T50	2.0	1.5	1.50	0.188	4300	11000	753X140016
	0.3	0.3	T100	1.5	1.0			8600		
75/150:5	0.3	---	T50	2.0	1.5	1.50	0.188	6400	16500	753X140017
	0.3	0.3	T100	1.5	1.0			12800		
100/200:5	0.3	---	T50	2.0	1.5	2.00	0.25	8650	22000	753X140018
	0.3	0.3	T100	1.5	1.0			17300		
150/300:5	0.3	---	T50	2.0	1.5	2.00	0.25	13750	33000	753X140019
	0.3	0.3	T100	1.5	1.0			27500		
200/400:5	0.3	---	T50	2.0	1.5	2.00	0.25	18000	44000	753X140020
	0.3	0.3	T100	1.5	1.0			36000		
300/600:5	0.3	---	T50	2.0	1.5	2.00	0.38	25750	66000	753X140021
	0.3	0.3	T100	1.5	1.0			51500		
400/800:5	0.3	---	T50	2.0	1.5	2.00	0.38	31650	70500	753X140022
	0.3	0.3	T100	1.33	1.0			63300		

JKM-4C DATA TABLE

Current Ratio (Amps) Pri : Sec	IEEE Accuracy Class 60 Hz Burden		Relay Class	Continuous Thermal Current Rating Factor		Primary Bar Size		One Second Thermal Limit, Amps	Mech. Limit Amps	Catalog Number	
	Meter Class			@ 30° C Amb.	@ 55° C Amb.	Width ins.	Thick ins.			Transformer Only	With Base Extension
	B0.1 to B1.8										
5:5	0.3		T100	1.5	1.0	1.50	0.188	465	550	754X140001	754X140019
10:5	0.3		T100	1.5	1.0	1.50	0.188	930	1100	754X140002	754X140020
15:5	0.3		T100	1.5	1.0	1.50	0.188	1470	1650	754X140003	754X140021
20:5	0.3		T100	1.5	1.0	1.50	0.188	1850	2200	754X140004	754X140022
25:5	0.3		T100	1.5	1.0	1.50	0.188	2300	2750	754X140005	754X140023
30:5	0.3		T100	1.5	1.0	1.50	0.188	2450	3300	754X140006	754X140024
40:5	0.3		T100	1.5	1.0	1.50	0.188	3700	4400	754X140007	754X140025
50:5	0.3		T100	1.5	1.0	1.50	0.188	4600	5500	754X140008	754X140026
75:5	0.3		T100	1.5	1.0	1.50	0.188	6400	8250	754X140009	754X140027
100:5	0.3		T100	1.5	1.0	1.50	0.188	8600	11000	754X140010	754X140028
150:5	0.3		T100	1.5	1.0	1.50	0.188	12800	16500	754X140011	754X140029
200:5	0.3		T100	1.5	1.0	2.00	0.25	17300	22000	754X140012	754X140030
300:5	0.3		T100	1.5	1.0	2.00	0.25	25700	33000	754X140014	754X140032
400:5	0.3		T100	1.5	1.0	2.00	0.25	36000	44000	754X140015	754X140033
500:5	0.3		T100	1.33	1.0	2.00	0.38	43100	47000	754X140016	754X140034
600:5	0.3		T100	1.5	1.0	2.00	0.38	51500	66000	754X140017	754X140035
800:5	0.3		T100	1.33	1.0	2.00	0.38	63300	70500	754X140018	754X140036

Medium Voltage Current Transformers

Model JKS-5

15kV, 95kV BIL, 15-800A



JKS-5 transformer, single ratio

APPLICATION
Designed for indoor service; suitable for operating relays and control devices. It has been designed with extra-high mechanical and thermal ratings to adapt it to this application.

Weight - Net (approximate, in pounds)
Single-Secondary50
Dual-Secondary.....102
Tapped-Secondary50

DIMENSIONS
Height10.125"
Width6.00"
Length21.625"

INSULATION
Hy-Bute-60

FREQUENCY
50-60 Hz

JKS-5 DATA TABLE

Current Ratio (Amps) Pri : Sec	IEEE Accuracy Class 60 Hz Burden			Relay Class	Continuous Thermal Current Rating Factor		One Second Thermal Limit, Amps		Catalog Number								
	Meter Class				@ 30°C Amb.	@ 55°C Amb.	With Secondary Short-Circuited	With Burden B-0.2 or Greater									
	B0.1	B0.5	B2.0														
Single Ratio																	
15:5	---	---	---	T10	1.5	1.0	13000	13000	755X001001								
20:5	1.2	---	---	T10	1.5	1.0	13000	13000	755X001002								
25:5	1.2	1.2	---	T10	1.5	1.0	10000	13000	755X001003								
30:5	0.6	1.2	---	T20	1.5	1.0	6000	13000	755X001004								
40:5	1.2	---	---	T10	1.5	1.0	25200	25200	755X001005								
50:5	0.6	---	---	T10	1.5	1.0	15000	25200	755X001006								
75:5	0.6	1.2	---	T20	1.5	1.0	15000	33500	755X001007								
100:5	0.3	0.6	---	T20	1.5	1.0	10000	33500	755X001008								
150:5	0.3	0.3	1.2	T50	1.5	1.0	21000	33500	755X001010								
200:5	0.3	0.3	1.2	T50	1.5	1.0	26000	44000	755X001011								
300:5	0.3	0.3	1.2	T50	1.5	1.0	35000	44000	755X001013								
400:5	0.3	0.3	0.3	T200	1.5	1.0	44000	44000	755X001014								
600:5	0.3	0.3	0.3	T200	1.5	1.0	55000	55000	755X001016								
800:5	0.3	0.3	1.2	T50	1.5	1.0	59000	59000	755X001017								
Dual-Secondary																	
15:5 //5	---	---	---	T10	1.5	1.1	13000	13000	755X001025								
20:5 //5	1.2	---	---	T10	1.5	1.1	13000	13000	755X001026								
25:5 //5	1.2	1.2	---	T10	1.5	1.1	10000	13000	755X001027								
30:5 //5	0.6	1.2	---	T20	1.5	1.1	6000	13000	755X001028								
40:5 //5	1.2	---	---	T10	1.5	1.1	25200	25200	755X001029								
50:5 //5	0.6	---	---	T10	1.5	1.1	15000	25200	755X001030								
75:5 //5	0.6	1.2	---	T20	1.5	1.1	15000	33500	755X001031								
100:5 //5	0.3	0.6	---	T20	1.5	1.1	10000	33500	755X001032								
150:5 //5	0.3	0.3	1.2	T50	1.5	1.1	21000	33500	755X001033								
200:5 //5	0.3	0.3	1.2	T50	1.5	1.1	26000	44000	755X001034								
300:5 //5	0.3	0.3	1.2	T50	1.5	1.1	35000	44000	755X001035								
400:5 //5	0.3	0.3	0.3	T100	1.5	1.1	44000	44000	755X001036								
600:5 //5	0.3	0.3	0.3	T100	1.5	1.1	55000	55000	755X001037								
800:5 //5	0.3	0.3	1.2	T50	1.5	1.1	59000	59000	755X001038								
Tapped-Secondary																	
50/100:5	1.2	2.4	---	T10	1.5	1.1	Refer to Factory for Application Information		755X001018								
	0.3	0.6	2.4	T20	1.5	1.1											
75/150:5	0.6	1.2	---	T20	1.5	1.1					755X001019						
	0.3	0.3	1.2	T50	1.5	1.1											
100/200:5	0.6	1.2	---	T20	1.5	1.1							755X001020				
	0.3	0.3	1.2	T50	1.5	1.1											
150/300:5	0.3	0.6	2.4	T20	1.5	1.1									755X001021		
	0.3	0.3	1.2	T50	1.5	1.1											
200/400:5	0.3	0.6	1.2	T50	1.5	1.1											755X001022
	0.3	0.3	0.3	T100	1.5	1.1											
300/600:5	0.3	0.6	2.4	T50	1.5	1.1											755X001023
	0.3	0.3	0.3	T100	1.5	1.1											
400/800:5	0.6	1.2	---	T20	1.5	1.1											755X001024
	0.3	0.3	1.2	T50	1.5	1.1											

Model JKM-95

15kV, 95kV BIL, 5-200A

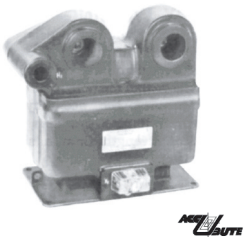

APPLICATION
The Type JKM-95 is a metering current transformer to be used in conjunction with the Type JKM-95 voltage transformer for primary metering of underground distribution systems. It is suitable for use with watt-hour meters, on circuits not exceeding 15,000 Volts line-to-line

Weight - Net (approximate, in pounds)
Transformer56

DIMENSIONS
Height11.31"
Width7.69"
Length11.94"

INSULATION
Hy-Bute-60

FREQUENCY
50-60 Hz

JKM-95 DATA TABLE

Current Ratio (Amps) Pri : Sec	IEEE Accuracy Class 60 Hz Burden		Continuous Thermal Current Rating Factor		Mech. Limit Amps 1.285	One Second Thermal Limit, Amps	Catalog Number
	Meter Class		@ 30°C Amb.	@ 55°C Amb.			
	B0.1 to B0.5						
Single Ratio							
5:5	0.3		3.0	2.0	1850	925	755X044001
10:5	0.3		3.0	2.0	3700	1850	755X044002
15:5	0.3		3.0	2.0	5550	2775	755X044003
20:5	0.3		3.0	2.0	7400	3700	755X044004
25:5	0.3		3.0	2.0	9250	4625	755X044005
30:5	0.3		3.0	2.0	11100	5550	755X044006
50:5	0.3		3.0	2.0	12500	9250	755X044007
75:5	0.3		2.5 ¹	2.0	18750	13875	755X044008
100:5	0.3		2.0 ¹	2.0	25000	18500	755X044009
150:5	0.3		1.33 ¹	1.33 ¹	37500	27750	755X044010
200:5	0.3		1.0 ¹	1.0 ¹	50000	37000	755X044011

Note
¹ The transformer rating factor is limited by the cable connection modules to 200 Amperes rms continuous

Medium Voltage Current Transformers

Model JKM-5C

15kV, 110kV BIL, 5-800A



JKM-5C



JKM-5

APPLICATION
Designed for indoor service; Suitable for operating meters, instruments and control devices.

WEIGHT
(Approximate)53 lbs

DIMENSIONS

Height10.78"
Width23.00"
Depth6.38"

REFERENCE DRAWINGS

Outline0162C34108

INSULATION LEVEL

15.5kV; BIL 110kV full wave

INSULATION

Polyurethane

FREQUENCY

50-60 Hz

* Higher current ratios available.
Contact factory for more information

* Also available in premium Hy-Bute-60.
Contact factory for part numbers.



JKM-5C DATA TABLE

Current Ratio (Amps) Pri : Sec	IEEE Accuracy Class 60 Hz Burden			Continuous Thermal Current Rating Factor		Primary Bar Size		Mech. Limit Amps	One Second Thermal Limit, Amps	Catalog Number
	Meter Class		Relay Class	@ 30° C Amb.	@ 55° C Amb.	Width ins.	Thick ins.			
	B0.1 to B0.5	B0.9 to 1.8								
Single Ratio										
5:5	0.3	0.3	T200	1.5	1.33	1.50	0.188	625	465	755X142001
10:5	0.3	0.3	T200	1.5	1.33	1.50	0.188	1250	930	755X142002
15:5	0.3	0.3	T200	1.5	1.33	1.50	0.188	1875	1470	755X142003
20:5	0.3	0.3	T200	1.5	1.33	1.50	0.188	2500	1850	755X142004
25:5	0.3	0.3	T200	1.5	1.33	1.50	0.188	3125	2300	755X142005
30:5	0.3	0.3	T200	1.5	1.33	1.50	0.188	3750	2460	755X142006
40:5	0.3	0.3	T200	1.5	1.33	1.50	0.188	5000	3720	755X142007
50:5	0.3	0.3	T200	1.5	1.33	1.50	0.188	6250	4600	755X142008
75:5	0.3	0.3	T200	1.5	1.33	1.50	0.188	9375	6375	755X142009
100:5	0.3	0.3	T200	1.5	1.33	1.50	0.188	12500	8600	755X142010
150:5	0.3	0.3	T200	1.5	1.33	1.50	0.188	18750	12750	755X142011
200:5	0.3	0.3	T200	1.5	1.33	2.00	0.25	25000	17200	755X142012
300:5	0.3	0.3	T200	1.5	1.33	2.00	0.25	37500	25800	755X142014
400:5	0.3	0.3	T200	1.5	1.33	2.00	0.25	50000	36000	755X142015
500:5	0.3	0.3	T200	1.5	1.33	2.00	0.38	53500	42000	755X142016
600:5	0.3	0.3	T200	1.5	1.33	2.00	0.38	75000	51600	755X142017
800:5	0.3	0.3	T200	1.2	0.85	2.00	0.38	80000	63200	755X142018
Tapped Secondary										
50/100:5	0.3	---	T100	2.0	1.5	1.50	0.188	12500	4300	755X142039
	0.3	---	T200	1.5	1.0				8600	
75/150:5	0.3	---	T100	2.0	1.5	1.50	0.188	18750	6375	755X142040
	0.3	---	T200	1.5	1.0				12750	
100/200:5	0.3	---	T100	2.0	1.5	2.00	0.25	25000	8600	755X142041
	0.3	---	T200	1.5	1.0				17200	
150/300:5	0.3	---	T100	2.0	1.5	2.00	0.25	37500	12900	755X142042
	0.3	---	T200	1.5	1.0				25800	
200/400:5	0.3	---	T100	2.0	1.5	2.00	0.25	50000	18000	755X142043
	0.3	---	T200	1.5	1.0				36000	
300/600:5	0.3	---	T100	2.0	1.5	2.00	0.38	75000	25800	755X142044
	0.3	---	T200	1.5	1.0				51600	
400/800:5	0.3	---	T100	2.0	1.5	2.00	0.38	80000	31600	755X142045
	0.3	---	T200	1.2	0.85				63200	

Model JKM-5AC (High Accuracy) 15kV,110kV BIL, 5-600A



JKM-5AC



JKM-5A

APPLICATION
Designed for indoor service; Suitable for operating meters, instruments and control devices. The JKM-5AC features 0.15 accuracy from 5% of nameplate amps through rating factor amps when applied within its burden capability.

WEIGHT
(Approximate)53 lbs

DIMENSIONS

Height10.78"
Width23.00"
Depth6.38"

REFERENCE DRAWINGS

Outline0163C35151

INSULATION LEVEL

15.5kV; BIL 110kV full wave.

INSULATION

Polyurethane

FREQUENCY

50-60 Hz

* Also available in premium Hy-Bute-60.
Contact factory for part numbers.

JKM-5AC DATA TABLE

Current Ratio (Amps) Pri : Sec	IEEE Accuracy Class 60 Hz Burden			Continuous Thermal Current Rating Factor		Primary Bar Size		One Second Thermal Limit, Amps	Catalog Number
	B0.1 to B0.5	B0.9 to 1.8	Relay Class	@ 30° C Amb.	@ 55° C Amb.	Width ins.	Thick ins.		
5:5	0.15	0.3	T200	1.5	1.00	1.50	0.188	465	755X145001
10:5	0.15	0.3	T200	1.5	1.00	1.50	0.188	930	755X145002
15:5	0.15	0.3	T200	1.5	1.00	1.50	0.188	1470	755X145003
20:5	0.15	0.3	T200	1.5	1.00	1.50	0.188	1860	755X145004
25:5	0.15	0.3	T200	1.5	1.00	1.50	0.188	2300	755X145005
30:5	0.15	0.3	T200	1.5	1.00	1.50	0.188	2460	755X145006
40:5	0.15	0.3	T200	1.5	1.00	1.50	0.188	3720	755X145007
50:5	0.15	0.3	T200	1.5	1.00	1.50	0.188	4600	755X145008
75:5	0.15	0.3	T200	1.5	1.00	1.50	0.188	6375	755X145009
100:5	0.15	0.3	T200	1.5	1.00	1.50	0.188	8600	755X145010
150:5	0.15	0.3	T200	1.5	1.00	1.50	0.188	12750	755X145011
200:5	0.15	0.3	T200	1.5	1.00	2.00	0.25	17200	755X145012
300:5	0.15	0.3	T200	1.5	1.00	2.00	0.25	25800	755X145014
400:5	0.15	0.3	T200	1.5	1.00	2.00	0.25	36000	755X145015
600:5	0.15	0.3	T200	1.5	1.00	2.00	0.38	51600	755X145017

Medium Voltage Current Transformers

Model JCM-3/-4/-5 5 to 15kV, 60 to 110kV BIL, 600-4000A

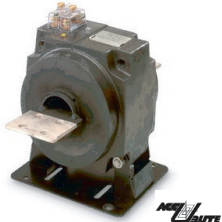

JCM-3 -4,

APPLICATION
Designed for indoor service; suitable for operating meters, relays and control devices.

Weight - Net
(approximate, in pounds)
Transformer, without base, JCM-3 and JCM-4 ...72
Transformer, without base, JCM-5109

DIMENSIONS
JCM-3 -4 -5
Height11.94", 11.94", 11.94"
Width9.50", 9.50", 9.50"
Length15.00", 16.00", 27.00"

INSULATION
Hy-Bute-60

FREQUENCY
50-60 Hz

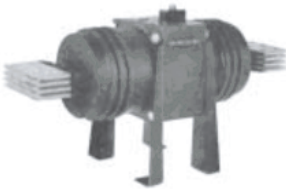

JCM-5

JCM-3/ JCM-4/ JCM-5 DATA TABLE

Current Ratio (Amps) Pri : Sec	IEEE Accuracy Class 60 Hz Burden			Continuous Thermal Current Rating Factor		One Second Thermal Limit, Amps	Catalog Number		
	Meter Class			@ 30° C Amb.	@ 55° C Amb.		JCM-3 5,000 V BIL 60 kV	JCM-4 8,700 V BIL 75 kV	JCM-5 15,000 V BIL 110 kV
	B0.1 thru B1.0	B2.0	Relay Class						
1200:5	0.3	0.3	C200	1.33	1.0	55000	753X020003	754X020003	755X020003
1500:5	0.3	0.3	C200	1.33	1.0	69000	753X020004	754X020004	755X020004
2000:5	0.3	0.3	C200	1.33	1.0	148000	753X020005	754X020005	755X020005
3000:5	0.3	0.3	C200	1.33	1.0	279000	753X020007	754X020007	755X020007
4000:5	0.3	0.3	C200	1.0	0.75	459000	753X020008	754X020008	755X020008
600/1200:5	0.3	0.6	C100	2.0	1.5	55000	753X020009	754X020009	755X020009
	0.3	0.3	C200	1.33	1.0	55000			
750/1500:5	0.3	0.6	C100	2.0	1.5	69000	753X020010	754X020010	755X020010
	0.3	0.3	C200	1.33	1.0	69000			
1000/2000:5	0.3	0.6	C100	2.0	1.5	148000	753X020011	754X020011	755X020011
	0.3	0.3	C200	1.33	1.0	148000			
1500/3000:5	0.3	0.3	C100	2.0	1.5	279000	753X020012	754X020012	755X020012
	0.3	0.3	C200	1.33	1.0	279000			
2000/4000:5	0.3	0.3	C100	2.0	1.0	456000	753X020013	754X020013	755X020013
	0.3	0.3	C200	1.0	0.75	456000			

Model JCB-3/-4/-5 5.56" Window 5 to 15kV, 60 to 110kV BIL, 600-4000A

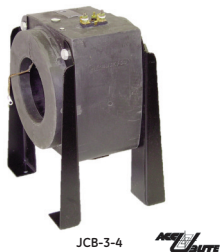

JCB-3-4

APPLICATION
Designed for indoor service; suitable for operating meters, relays and control devices.

Weight - Net
(approximate, in pounds)
Transformer, without base, JCB-3, JCB-485
Transformer without base, JCB-5110

DIMENSIONS
JCB-3 -4 -5
Height17.31", 17.31", 17.31"
Width12.50", 12.00", 12.50"
Length10.00", 9.00", 18.00"

INSULATION
Hy-Bute-60

FREQUENCY
50-60 Hz



JCB-5

JCB-3/ JCB-4/ JCB-5 DATA TABLE

Current Ratio (Amps) Pri : Sec	IEEE Accuracy Class 60 Hz Burden				Continuous Thermal Current Rating Factor		One Second Thermal Limit, Amps	Catalog Number		
	Meter Class			Relay Class	@ 30° C Amb.	@ 55° C Amb.		JCB-3 5,000 V BIL 60 kV	JCB-4 8,700 V BIL 75 kV	JCB-5 15,000 V BIL 110 kV
	B0.1 B0.2 B0.5	B1.0	B2.0							
1200:5	0.3	0.3	0.3	C200	1.33	1.0	88800	753X021008	754X021008	755X021008
1500:5	0.3	0.3	0.3	C200	1.33	1.0	111000	753X021009	754X021009	755X021009
2000:5	0.3	0.3	0.3	C400	1.33	1.0	148000	753X021011	754X021011	755X021011
3000:5	0.3	0.3	0.3	C400	1.33	1.0	282000	753X021013	754X021013	755X021013
4000:5	0.3	0.3	0.3	C200	1.33	1.0	296000	753X021014	754X021014	755X021014
600/1200:5	0.3	0.6	---	C100	2.0	1.5	88800	753X021016	754X021016	755X021016
	0.3	0.3	0.3	C200	1.33	1.0	88800			
750/1500:5	0.3	0.3	0.6	C100	2.0	1.5	111000	753X021017	754X021017	755X021017
	0.3	0.3	0.3	C200	1.33	1.0	111000			
1000/2000:5	0.3	0.3	0.6	C200	2.0	1.5	148000	753X021018	754X021018	755X021018
	0.3	0.3	0.3	C400	1.33	1.0	148000			
1500/3000:5	0.3	0.3	0.3	C200	2.0	1.5	282000	753X021019	754X021019	755X021019
	0.3	0.3	0.3	C400	1.33	1.0	282000			
2000/4000:5	0.3	0.3	0.3	C100	2.0	1.5	296000	753X021020	754X021020	755X021020
	0.3	0.3	0.3	C200	1.33	1.0	296000			

Medium Voltage Current Transformers

Model CTW6-125-T100/200 25.5kV, 125kV BIL, 10.5-600A



APPLICATION:
Metering and relaying.

FREQUENCY:
50-400 Hz.

MAXIMUM SYSTEM VOLTAGE:
25.5kV, BIL 125kV full wave.

CONTINUOUS THERMAL CURRENT RATING FACTOR:
1.50 at 30°C amb., 1.33 at 55°C. amb.

WEIGHT(Approximate)
T100 - 95 lbs.
T200 - 115 lbs.

DIMENSIONS
Height10.78"
Width23.00"
Depth6.38"

Primary terminals 1/2-13 bolts with one Belleville washer.

Secondary terminals are brass screws No. 10-32 with one flatwasher and lockwasher.

INSULATION
Polyurethane

CTW6 DATA TABLE

Catalog Number	Current Ratio	Relay Class	IEEE Accuracy Class 60 Hz Burden					Thermal Current Rating 1 Second RMS Amps
			B0.1	B0.2	B0.5	B0.9	B1.8	
CTW6-125-T100								
CTW6-125-T100-100	10:5	T100	0.3	0.3	0.3	0.3	0.6	900*
CTW6-125-T100-150	15:5	T100	0.3	0.3	0.3	0.3	0.6	1700*
CTW6-125-T100-250	25:5	T100	0.3	0.3	0.3	0.3	0.6	2700*
CTW6-125-T100-500	50:5	T100	0.3	0.3	0.3	0.3	0.6	4700*
CTW6-125-T100-750	75:5	T100	0.3	0.3	0.3	0.3	0.6	12900*
CTW6-125-T100-101	100:5	T100	0.3	0.3	0.3	0.3	0.6	12900*
CTW6-125-T100-151	150:5	T100	0.3	0.3	0.3	0.3	0.6	23000*
CTW6-125-T100-201	200:5	T100	0.3	0.3	0.3	0.3	0.6	28200*
CTW6-125-T100-301	300:5	T100	0.3	0.3	0.3	0.3	0.6	48900*
CTW6-125-T100-401	400:5	T100	0.3	0.3	0.3	0.3	0.6	66200*
CTW6-125-T100-601	600:5	T100	0.3	0.3	0.3	0.3	0.6	66200*
CTW6-125-T200								
CTW6-125-T200-100	10:5	T200	0.3	0.3	0.3	0.3	0.3	900**
CTW6-125-T200-150	15:5	T200	0.3	0.3	0.3	0.3	0.3	1700**
CTW6-125-T200-250	25:5	T200	0.3	0.3	0.3	0.3	0.3	2700**
CTW6-125-T200-500	50:5	T200	0.3	0.3	0.3	0.3	0.3	4700**
CTW6-125-T200-750	75:5	T200	0.3	0.3	0.3	0.3	0.3	12900**
CTW6-125-T200-101	100:5	T200	0.3	0.3	0.3	0.3	0.3	12900**
CTW6-125-T200-151	150:5	T200	0.3	0.3	0.3	0.3	0.3	23000**
CTW6-125-T200-201	200:5	T200	0.3	0.3	0.3	0.3	0.3	28200**
CTW6-125-T200-301	300:5	T200	0.3	0.3	0.3	0.3	0.3	48900**
CTW6-125-T200-401	400:5	T200	0.3	0.3	0.3	0.3	0.3	66200**
CTW6-125-T200-601	600:5	T200	0.3	0.3	0.3	0.3	0.3	66200**

* With a burden of B0.2 or greater connected to the secondary.
** With a burden of B0.5 or greater connected to the secondary.

Model CTWH6-125-T200 25.5kV, 125kV BIL, 800-3000A



APPLICATION:
Metering and relaying.

FREQUENCY:
50-400 Hz.

MAXIMUM SYSTEM VOLTAGE:
25.5kV, BIL 125kV full wave.

CONTINUOUS THERMAL CURRENT RATING FACTOR:
1.50 at 30°C amb., 1.33 at 55°C. amb.
2000:5 = 1.33 at 30°C. amb., 1.00 at 55°C. amb.
2500:5 and 3000:5 = 1.00 at 30°C. amb., 0.85 at 55°C. amb.

WEIGHT
Approximate.....150 lbs.

DIMENSIONS
Height16.88"
Width16.00"
Depth9.50"

Primary terminals are plated copper bars, configured as specified.
Secondary terminals are brass screws No. 10-32 with one flatwasher and lockwasher.
Vacuum cast polyurethane resin.
Dual bars spacing is 1/2 inch.

INSULATION
Polyurethane

CTWH6 DATA TABLE

Catalog Number	Current Ratio	Relay Class	IEEE Accuracy Class 60 Hz Burden					* Thermal Current Rating 1 Second RMS Amps
			B0.1	B0.2	B0.5	B0.9	B1.8	
CTWH6-125-T200-801-**	800:5	T200	0.3	0.3	0.3	0.3	0.3	87000
CTWH6-125-T200-200-**	1000:5	T200	0.3	0.3	0.3	0.3	0.3	13300
CTWH6-125-T200-122-**	1200:5	T200	0.3	0.3	0.3	0.3	0.3	13300
CTWH6-125-T200-152-**	1500:5	T200	0.3	0.3	0.3	0.3	0.3	266000
CTWH6-125-T200-202-**	2000:5	T200	0.3	0.3	0.3	0.3	0.3	266000
CTWH6-125-T200-252-**	2500:5	T200	0.3	0.3	0.3	0.3	0.3	266000
CTWH6-125-T200-302-**	3000:5	T200	0.3	0.3	0.3	0.3	0.3	358000

* With a burden of B0.1 or greater connected to the secondary.
** Specify primary bus arrangement number (1 through 8).

Medium Voltage Current Transformers

Model CTW7-150-T100/200 36.5kV, 150kV BIL, 10-600A



Note: 200kV BIL is available for 600:5 only

APPLICATION: Metering and relaying.
FREQUENCY: 50-400 Hz.
MAXIMUM SYSTEM VOLTAGE: 36.5kV, BIL 150kV full wave.
CONTINUOUS THERMAL CURRENT RATING FACTOR: 1.50 at 30°C amb., 1.33 at 55°C. amb.
WEIGHT (Approximate) T100 - 95 lbs. T200 - 115 lbs.
DIMENSIONS Height15.10" Width13.75" Depth8.50"
Primary terminals 1/2-13 bolts with one Belleville washer.
Secondary terminals are brass screws No. 10-32 with one flatwasher and lockwasher.
INSULATION Polyurethane

CTW7 DATA TABLE

Catalog Number	Current Ratio	Relay Class	IEEE Accuracy Class 60 Hz Burden					Thermal Current Rating 1 Second RMS Amps
			B0.1	B0.2	B0.5	B0.9	B1.8	
CTW7-150-T100								
CTW7-150-T100-100	10:5	T100	0.3	0.3	0.3	0.3	0.6	900*
CTW7-150-T100-150	15:5	T100	0.3	0.3	0.3	0.3	0.6	1700*
CTW7-150-T100-250	25:5	T100	0.3	0.3	0.3	0.3	0.6	2700*
CTW7-150-T100-500	50:5	T100	0.3	0.3	0.3	0.3	0.6	4700*
CTW7-150-T100-750	75:5	T100	0.3	0.3	0.3	0.3	0.6	12900*
CTW7-150-T100-101	100:5	T100	0.3	0.3	0.3	0.3	0.6	12900*
CTW7-150-T100-151	150:5	T100	0.3	0.3	0.3	0.3	0.6	23000*
CTW7-150-T100-201	200:5	T100	0.3	0.3	0.3	0.3	0.6	28200*
CTW7-150-T100-301	300:5	T100	0.3	0.3	0.3	0.3	0.6	48900*
CTW7-150-T100-401	400:5	T100	0.3	0.3	0.3	0.3	0.6	66200*
CTW7-150-T100-601	600:5	T100	0.3	0.3	0.3	0.3	0.6	66200*
CTW7-150-T200								
CTW7-150-T200-100	10:5	T200	0.3	0.3	0.3	0.3	0.3	900**
CTW7-150-T200-150	15:5	T200	0.3	0.3	0.3	0.3	0.3	1700**
CTW7-150-T200-250	25:5	T200	0.3	0.3	0.3	0.3	0.3	2700**
CTW7-150-T200-500	50:5	T200	0.3	0.3	0.3	0.3	0.3	4700**
CTW7-150-T200-750	75:5	T200	0.3	0.3	0.3	0.3	0.3	12900**
CTW7-150-T200-101	100:5	T200	0.3	0.3	0.3	0.3	0.3	12900**
CTW7-150-T200-151	150:5	T200	0.3	0.3	0.3	0.3	0.3	23000**
CTW7-150-T200-201	200:5	T200	0.3	0.3	0.3	0.3	0.3	28200**
CTW7-150-T200-301	300:5	T200	0.3	0.3	0.3	0.3	0.3	48900**
CTW7-150-T200-401	400:5	T200	0.3	0.3	0.3	0.3	0.3	66200**
CTW7-150-T200-601	600:5	T200	0.3	0.3	0.3	0.3	0.3	66200**

* With a burden of B0.2 or greater connected to the secondary.
** With a burden of B0.5 or greater connected to the secondary.

Model CTWH7-150-T200 36.5kV, 150kV BIL, 800-3000A



Note: 200kV BIL is available except for 2500:5 only

APPLICATION: Metering and relaying.
FREQUENCY: 50-400 Hz.
MAXIMUM SYSTEM VOLTAGE: 36.5kV, BIL 150kV full wave.
CONTINUOUS THERMAL CURRENT RATING FACTOR: 1.50 at 30°C amb., 1.33 at 55°C. amb. 2000:5 = 1.33 at 30°C. amb., 1.00 at 55°C. amb. 2500:5 and 3000:5 = 1.00 at 30°C. amb., 0.85 at 55°C. amb.
WEIGHT Approximate.....180 lbs.
DIMENSIONS Height18.38" Width16.00" Depth9.50"
Primary terminals are plated copper bars, configured as specified.
Secondary terminals are brass screws No. 10-32 with one flatwasher and lockwasher. Dual bars spacing is 1/2 inch.
INSULATION Polyurethane

CTWH7 DATA TABLE

Catalog Number	Current Ratio	Relay Class	IEEE Accuracy Class 60 Hz Burden					* Thermal Current Rating 1 Second RMS Amps
			B0.1	B0.2	B0.5	B0.9	B1.8	
CTWH7-150-T200-801-**	800:5	T200	0.3	0.3	0.3	0.3	0.3	87000
CTWH7-150-T200-200-**	1000:5	T200	0.3	0.3	0.3	0.3	0.3	13300
CTWH7-150-T200-122-**	1200:5	T200	0.3	0.3	0.3	0.3	0.3	13300
CTWH7-150-T200-152-**	1500:5	T200	0.3	0.3	0.3	0.3	0.3	266000
CTWH7-150-T200-202-**	2000:5	T200	0.3	0.3	0.3	0.3	0.3	266000
CTWH7-150-T200-252-**	2500:5	T200	0.3	0.3	0.3	0.3	0.3	266000
CTWH7-150-T200-302-**	3000:5	T200	0.3	0.3	0.3	0.3	0.3	358000

* With a burden of B0.1 or greater connected to the secondary.
** See complete catalog sheet for primary bus arrangement number

Medium Voltage Voltage Transformers

Model JVM-2C/3C

60kV BIL, 2400-4800V



APPLICATION
Designed for indoor service; suitable for operating meters, instruments, relays and control devices.

REGULATORY AGENCY APPROVALS
UL RecognizedFile E145172

THERMAL RATING (VOLT-AMPERES)
55°C Rise above 30°C Ambient750 VA
30°C Rise above 55°C Ambient500 VA

WEIGHT (Approximate)
Unfused34 lbs
Fused37 lbs

DIMENSIONS
Height7.07"
Width10.85"
Depth6.38"

REFERENCE DRAWINGS
Outline0142C33852

INSULATION
Polyurethane

* Also available in premium Hy-Bute-60.

JVM-2C/3C DATA TABLE

Circuit Line to Line Voltage	Permissible Transformer Primary Connection	Transformer Rating		IEEE Accuracy Class 60 Hz Burden		Catalog Number	Primary Fuse Rating	
		Primary Voltage ①	Ratio	Operated at Rated Voltage	Operated at 58% of Rated Voltage		Amps	Volts
Unfused								
2400/4160	Δ or Y/ Y only	2400	20:1	0.3 W,X,M,Y & 1.2Z	0.3 W,X & 1.2 M,Y	763X121001	---	---
4200	Δ or Y	4200	35:1	0.3 W,X,M,Y & 1.2Z	0.3 W,X & 1.2 M,Y	763X121002	---	---
4800	Δ or Y	4800	40:1	0.3 W,X,M,Y & 1.2Z	0.3 W,X & 1.2 M,Y	763X121003	---	---
With One Primary Fuse								
2400	Y only	2400 ①	20:1	---	0.3 W,X & 1.2 M,Y	763X121042	2 A	2400
4160	Y only	2400 ①	20:1	0.3 W,X,M,Y & 1.2Z	---	763X121033	2 A	4800
4200	Y only	4200	35:1	---	0.3 W,X & 1.2 M,Y	763X121031	1 A	4800
4800	Y only	4800	40:1	---	0.3 W,X & 1.2 M,Y	763X121032	1 A	4800
With Two Primary Fuses								
2400	Δ or Y ③	2400 ①	20:1	0.3 W,X,M,Y & 1.2Z	0.3 W,X & 1.2 M,Y	763X121040	2 A	2400
4160	Y only	2400 ①	20:1	0.3 W,X,M,Y & 1.2Z	---	763X121024	2 A	4800
4200	Δ or Y ③	4200	35:1	0.3 W,X,M,Y & 1.2Z	0.3 W,X & 1.2 M,Y	763X121018	1 A	4800
4800	Δ or Y ③	4800	40:1	0.3 W,X,M,Y & 1.2Z	0.3 W,X & 1.2 M,Y	763X121019	1 A	4800

Notes:

- ① For continuous operation, the transformer's rated primary voltage should not be exceeded by more than 10%. Under emergency conditions, over-voltage must be limited to 1.25 times the transformer primary voltage rating.
- ③ For Y connections, it is preferred practice to connect one lead from each voltage transformer directly to the grounded neutral, using a fuse only in the line side of the primary. By this connection a transformer can never be "alive" from the line side by reason of a blown fuse on the grounded side.
- ④ Although these pairs of transformers have the same voltage rating and turns ratio and are otherwise identical, they are supplied with fuses having different voltage ratings to suit the operating voltage of the application. This difference necessitates a separate catalog number to differentiate them.

Model JVM-95

95kV BIL, 7200-14400V



APPLICATION
The Type JVM-95 is a metering voltage transformer to be used in conjunction with the Type JKM-95 current transformer for primary metering of underground distribution systems.

Weight - Shipping/Net
(approximate, in pounds)
Transformer115/95

DIMENSIONS
Height11.31"
Width7.69"
Length11.94"

INSULATION
Hy-Bute-60

FREQUENCY
50-60 Hz

JVM-95 DATA TABLE

Line-To-Line Circuit Voltage For Permissible Primary Connection			Transformer Rating ①		IEEE Accuracy Class 60 Hz Burden		Catalog Number		
							18-Inch Connector	24-Inch Connector	36-Inch Connector
Δ	Y	Y Only	Primary Voltage	Ratio	Operated at Rated Voltage	Operated at 58% of Rated Voltage			
With Two Insulated High Voltage Terminals									
7200	7200	12470	7200	60:1	0.3 W,X,M,Y	0.3 W,X,M; 0.6 Y	765X022024	765X022034	765X022044
8400	8400	14560	8400	70:1	0.3 W,X,M,Y	0.3 W,X,M; 0.6 Y	765X022023	765X022033	765X022043
12000	12000	---	12000	100:1	0.3 W,X,M,Y	0.3 W,X,M; 0.6 Y	765X022022	765X022032	765X022042
14400	14400	---	14400	120:1	0.3 W,X,M,Y	0.3 W,X,M; 0.6 Y	765X022021	765X022031	765X022041
With One Insulated High Voltage Terminal and One Grounded Terminal									
---	7200	12470	7200	60:1	0.3 W,X,M,Y	0.3 W,X,M; 0.6 Y	765X022028	765X022038	765X022048
---	8400	14560	8400	70:1	0.3 W,X,M,Y	0.3 W,X,M; 0.6 Y	765X022027	765X022037	765X022047
---	---	12000	12000	100:1	0.3 W,X,M,Y	0.3 W,X,M; 0.6 Y	765X022026	765X022036	765X022046
---	---	14400	14400	120:1	0.3 W,X,M,Y	0.3 W,X,M; 0.6 Y	765X022025	765X022035	765X022045

Notes:

- ① For continuous operation, the transformer-rated primary voltage should not be exceeded by more than 10%. Under emergency conditions, over-voltage must be limited to 1.25 times the transformer primary-voltage rating.

Medium Voltage Voltage Transformers

Model JVM-4C/5C

75-110kV BIL, 4200-14400V



JVM-5C



JVM-5

APPLICATION
Designed for indoor service; suitable for operating meters, instruments, relays and control devices.

REGULATORY AGENCY APPROVALS
UL RecognizedFile E145172

THERMAL RATING (VOLT-AMPERES)
55°C Rise above 30°C Ambient1500 VA
30°C Rise above 55°C Ambient1000 VA

WEIGHT (Approximate)
Unfused85 lbs
Fused88 lbs

DIMENSIONS
Height11.50"
Width11.63"
Depth10.63"

REFERENCE DRAWINGS
Outline0162C33853

INSULATION
Polyurethane

* Also available in premium Hy-Bute-60.
With lattice wound primary.
Contact factory for part numbers.

JVM-4C/5C DATA TABLE

Circuit Line to Line Voltage	Permissible Transformer Primary Connection	Transformer Rating		IEEE Accuracy Class 60 Hz Burden		BIL	Catalog Number Supplied with Fuses	Catalog Number Supplied without Fuses	Primary Fuse Rating	
		Primary ⁽¹⁾ Voltage	Ratio	Operated at Rated Voltage	Operated at 58% of Rated Voltage				Amps	Volts
JVM-4C Unfused										
4200/7200	Δ or Y/ Y only	4200	35:1	Acc 1	Acc 2	75 kV	---	764X120001	---	---
4800/8320	Δ or Y/ Y only	4800	40:1	Acc 1	Acc 2	75 kV	---	764X120002	---	---
7200	Δ or Y	7200	60:1	Acc 1	Acc 2	75 kV	---	764X120003	---	---
JVM-4C With One Primary Fuse										
4200	Y only	4200 ⁽⁴⁾	35:1	---	Acc 2	75 kV	764X120021	---	2 A	4800
7200	Y only	4200 ⁽⁴⁾	35:1	Acc 1	---	75 kV	764X120023	764X120025	2 A	7200
4800	Y only	4800	40:1	---	Acc 2	75 kV	764X120022	764X120026	2 A	4800
7200	Y only	7200	60:1	---	Acc 2	75 kV	764X120024	764X120028	1 A	7200
JVM-4C With Two Primary Fuses										
4200	Δ or Y ⁽³⁾	4200 ⁽⁴⁾	35:1	Acc 1	Acc 2	75 kV	764X120012	---	2 A	4800
4200	Δ Y only ⁽³⁾	4200 ⁽⁴⁾	35:1	Acc 1	---	75 kV	764X120015	764X120018	2 A	7200
4800	Δ or Y ⁽³⁾	4800	40:1	Acc 1	Acc 2	75 kV	764X120013	764X120019	2 A	4800
7200	Δ or Y ⁽³⁾	7200	60:1	Acc 1	Acc 2	75 kV	764X120016	764X120020	1 A	7200
JVM-5C Unfused										
7200/12470	Δ or Y/ Y only	7200	60:1	Acc 1	Acc 2	110 kV	---	765X121001	---	---
8400/14400	Δ or Y/ Y only	8400	70:1	Acc 1	Acc 2	110 kV	---	765X121002	---	---
12000	Δ or Y	12000	100:1	Acc 1	Acc 2	110 kV	---	765X121003	---	---
14400	Δ or Y	14400	120:1	Acc 1	Acc 2	110 kV	---	765X121004	---	---
JVM-5C With One Primary Fuse										
7200	Y only	7200 ⁽⁴⁾	60:1	---	Acc 2	110 kV	765X121053	765X121061	1 A	7200
12470	Y only	7200 ⁽⁴⁾	60:1	Acc 1	---	110 kV	765X121048	765X121056	1 A	14400
14400	Y only	8400	70:1	Acc 1	---	110 kV	765X121049	765X121057	1 A	14400
12000	Y only	12000	100:1	---	Acc 2	110 kV	765X121050	765X121058	0.5 A	14400
14400	Y only	14400	120:1	---	Acc 2	110 kV	765X121051	765X121059	0.5 A	14400
JVM-5C With Two Primary Fuses										
7200	Δ or Y ⁽³⁾	7200 ⁽⁴⁾	60:1	Acc 1	Acc 2	110 kV	765X121031	765X121047	1 A	7200
12470	Y only ⁽³⁾	7200 ⁽⁴⁾	60:1	Acc 1	---	110 kV	765X121027	765X121043	1 A	14400
8400/14400	Δ or Y/ Y only ⁽³⁾	8400	70:1	Acc 1	Acc 2	110 kV	765X121028	765X121044	1 A	14400
12000	Δ or Y ⁽³⁾	12000	100:1	Acc 1	Acc 2	110 kV	765X121029	765X121045	0.5 A	14400
14400	Δ or Y ⁽³⁾	14400	120:1	Acc 1	Acc 2	110 kV	765X121030	765X121046	0.5 A	14400
Acc 1						Acc 2				
Operated at Rated Voltage						Operated at 58% of Rated Voltage				
0.3 W, X, M, Y, Z & 1.2 ZZ						0.3 W, X, M, Y & 1.2 Z				

Notes:

- (1) For continuous operation, the transformer's rated primary voltage should not be exceeded by more than 10%. Under emergency conditions, over-voltage must be limited to 1.25 times the transformer primary voltage rating.
- (3) For Y connections, it is preferred practice to connect one lead from each voltage transformer directly to the grounded neutral, using a fuse only in the line side of the primary. By this connection a transformer can never be "alive" from the line side by reason of a blown fuse on the grounded side.
- (4) Although these pairs of transformers have the same voltage rating and turns ratio and are otherwise identical, they are supplied with fuses having different voltage ratings to suit the operating voltage of the application. This difference necessitates a separate catalog number to differentiate them.

Medium Voltage Voltage Transformers

Model JVM-4AC/5AC (High Acc) 75-110kV BIL, 4200-14400V



JVM-5AC



JVM-5A

* Also available in premium Hy-Bute-60. With lattice wound primary. Contact factory for part numbers.



APPLICATION
Designed for indoor service; suitable for operating meters, instruments, relays and control devices.

REGULATORY AGENCY APPROVALS
UL RecognizedFile E145172

THERMAL RATING (VOLT-AMPERES)
55°C Rise above 30°C Ambient2000 VA
30°C Rise above 55°C Ambient1400 VA

WEIGHT (Approximate)
Unfused85 lbs
Fused88 lbs

DIMENSIONS
Height11.50"
Width11.63"
Depth10.63"

REFERENCE DRAWINGS
Outline0162C33853

INSULATION
Polyurethane

JVM-4AC/5AC DATA TABLE

Circuit Line to Line Voltage	Permissible Transformer Primary Connection	Transformer Rating		IEEE Accuracy Class 60 Hz Burden		BIL	Catalog Number Supplied without Fuses	Primary Fuse Rating	
		Primary ⁽¹⁾ Voltage	Ratio	Operated at Rated Voltage	Operated at 58% of Rated Voltage			Amps	Volts
JVM-4AC Unfused									
4200/7200	Δ or Y/Y only	4200	35:1	0.15 Y	0.3 Z	75 kV	764X121001	---	---
4800/8320	Δ or Y/Y only	4800	40:1	0.15 Y	0.3 Z	75 kV	764X121002	---	---
7200	Δ or Y	7200	60:1	0.15 Y	0.3 Z	75 kV	764X121003	---	---
JVM-4AC With One Primary Fuse									
4200	Y only	4200 ⁽⁴⁾	35:1	0.15 Y	0.3 Z ⁽²⁾	75 kV	764X121010	2 A	4800
7200	Y only	4200 ⁽⁴⁾	35:1	0.15 Y	0.3 Z	75 kV	764X121011	2 A	7200
4800	Y only	4800	40:1	0.15 Y	0.3 Z ⁽²⁾	75 kV	764X121012	2 A	4800
7200	Y only	7200	60:1	0.15 Y	0.3 Z ⁽²⁾	75 kV	764X121013	1 A	7200
JVM-4AC With Two Primary Fuses									
4200	Δ Y only ⁽³⁾	4200	35:1	0.15 Y	0.3 Z	75 kV	764X121021	2 A	4800
4800	Δ or Y ⁽³⁾	4800	40:1	0.15 Y	0.3 Z	75 kV	764X121022	2 A	4800
7200	Δ or Y ⁽³⁾	7200	60:1	0.15 Y	0.3 Z	75 kV	764X121023	1 A	7200
JVM-5AC Unfused									
7200/12470	Δ or Y/Y only	7200	60:1	0.15 Y	0.3 Z	110 kV	765X123001	---	---
7620/13200	Δ or Y/Y only	7620	63.5:1	0.15 Y	0.3 Z	110 kV	765X123002	---	---
8400/14400	Δ or Y/Y only	8400	70:1	0.15 Y	0.3 Z	110 kV	765X123003	---	---
12000	Δ or Y	12000	100:1	0.15 Y	0.3 Z	110 kV	765X123004	---	---
13200	Δ or Y	13200	110:1	0.15 Y	0.3 Z	110 kV	765X123005	---	---
14400	Δ or Y	14400	120:1	0.15 Y	0.3 Z	110 kV	765X121006	---	---
JVM-5AC With One Primary Fuse									
7200	Y only	7200 ⁽⁴⁾	60:1	0.15 Y	0.3 Z ⁽²⁾	110 kV	765X123010	1 A	7200
12470	Y only	7200 ⁽⁴⁾	60:1	0.15 Y	0.3 Z	110 kV	765X123011	1 A	14400
7620	Y only	7620	63.5:1	0.15 Y	0.3 Z	110 kV	765X123012	1 A	14400
8400	Y only	8400	70:1	0.15 Y	0.3 Z	110 kV	765X123013	1 A	14400
12000	Y only	12000	100:1	0.15 Y	0.3 Z ⁽²⁾	110 kV	765X123014	1 A	14400
13200	Y only	13200	110:1	0.15 Y	0.3 Z ⁽²⁾	110 kV	765X123015	1 A	14400
14400	Y only	14400	120:1	0.15 Y	0.3 Z ⁽²⁾	110 kV	765X123016	0.5 A	14400
JVM-5AC With Two Primary Fuses									
7200	Δ or Y only ⁽³⁾	7200	60:1	0.15 Y	0.3 Z	110 kV	765X123020	1 A	7200
12000	Δ or Y only ⁽³⁾	12000	100:1	0.15 Y	0.3 Z	110 kV	765X123024	1 A	14400
13200	Δ or Y only ⁽³⁾	13200	110:1	0.15 Y	0.3 Z	110 kV	765X123025	1 A	14400
14400	Δ or Y only ⁽³⁾	14400	120:1	0.15 Y	0.3 Z	110 kV	765X123026	0.5 A	14400

Notes:

- (1) For continuous operation, the transformer's rated primary voltage should not be exceeded by more than 10%. Under emergency conditions, over-voltage must be limited to 1.25 times the transformer primary voltage rating.
- (2) With ANSI 69 Volt burden.
- (3) For Y connections, it is preferred practice to connect one lead from each voltage transformer directly to the grounded neutral, using a fuse only in the line side of the primary. By this connection a transformer can never be "alive" from the line side by reason of a blown fuse on the grounded side.
- (4) Although these pairs of transformers have the same voltage rating and turns ratio and are otherwise identical, they are supplied with fuses having different voltage ratings to suit the operating voltage of the application. This difference necessitates a separate catalog number to differentiate them.

Model PT6-1-125

125kV BIL, 10200-24000V



JVM-6

APPLICATION
Designed for indoor service; suitable for operating meters, instruments, relays and control devices.

REGULATORY AGENCY APPROVALS
UL RecognizedFile E145172

THERMAL RATING (VOLT-AMPERES)
55°C Rise above 30°C Ambient1500 VA
30°C Rise above 55°C Ambient1000 VA

ACCURACY CLASS
0.3 W, X, M, Y, Z & 1.2 Z² at 100% rated voltage with 120V based IEEE burden.
0.3 W, X, M, Y & 1.2Z at 58% rated voltage with 69.3V based IEEE burden

WEIGHT (Approximate)
Unfused125 lbs

DIMENSIONS
Height13.44"
Width13.75"
Depth9.50"

INSULATION
Polyurethane

FREQUENCY:
60 Hz.

* Also available in premium Hy-Bute-60.

PT6-1-125 DATA TABLE

PRIMARY VOLTAGE	RATIO	SECONDARY VOLTAGE	CATALOG NUMBERS	R FR
10200	85:1	120	PT6-1-125-1022	86 ohms
*12000	100:1	120	PT6-1-125-123	86 ohms
13200	110:1	120	PT6-1-125-1322	86 ohms
13800	115:1	120	PT6-1-125-1382	86 ohms
*14400	120:1	120	PT6-1-125-1442	86 ohms
*18000	150:1	120	PT6-1-125-183	48 ohms
*21000	175:1	120	PT6-1-125-213	48 ohms
*24000	200:1	120	PT6-1-125-243	48 ohms

NOTE: All primary voltages marked with an asterisk (*) are approved for revenue metering in Canada by industry Canada, Approval No. AE-0676 Rev.2

Medium Voltage Voltage Transformers

Model PT6-2-125

125kV BIL, 18000-24000V

 E145172



APPLICATION
Designed for indoor service; suitable for operating meters, instruments, relays and control devices.

MAXIMUM SYSTEM VOLTAGE:
25.5kV, BIL 125kV full wave.

THERMAL RATING (VOLT-AMPERES)
55°C Rise above 30°C Ambient1500 VA
30°C Rise above 55°C Ambient1000 VA

ACCURACY CLASS
0.3 W, X, M, Y, Z & 1.2 ZZ at 100% rated voltage with 120V based IEEE burden.
0.3 W, X, M, Y & 1.2Z at 58% rated voltage with 69.3V based IEEE burden

WEIGHT (Approximate)
Unfused125 lbs

DIMENSIONS
Height13.44"
Width13.75"
Depth9.50"

INSULATION
Polyurethane

FREQUENCY:
60 Hz.

PT6-2-125 DATA TABLE

PRIMARY VOLTAGE	RATIO	SECONDARY VOLTAGE	125 kV BIL CATALOG NUMBERS
18000	150:1	120	PT6-2-125-183
21000	175:1	120	PT6-2-125-213
24000	200:1	120	PT6-2-125-243

Approved for revenue metering in Canada by industry Canada, Approval No. AE-0676 Rev.2

Model PT7-1-150

150-200kV BIL, 15240-34500V

 E145172



APPLICATION
Designed for indoor service; suitable for operating meters, instruments, relays and control devices.

MAXIMUM SYSTEM VOLTAGE:
36.5kV, BIL 150kV full wave.

THERMAL RATING (VOLT-AMPERES)
55°C Rise above 30°C Ambient1500 VA
30°C Rise above 55°C Ambient1000 VA

ACCURACY CLASS
0.3 W, X, M, Y, Z & 1.2 ZZ at 100% rated voltage with 120V based IEEE burden.
0.3 W, X, M, Y & 1.2Z at 58% rated voltage with 69.3V based IEEE burden

WEIGHT (Approximate)
Unfused140 lbs

DIMENSIONS
Height13.44"
Width13.75"
Depth9.50"

INSULATION
Polyurethane

FREQUENCY:
60 Hz.

PT7-1-150 DATA TABLE

PRIMARY VOLTAGE	RATIO	SECONDARY VOLTAGE	** 150kV BIL CATALOG NUMBERS	R FR
15240	127:1	120	PT7-1-150-SD01967	86 ohms
15600	130:1	120	PT7-1-150-SD03259	86 ohms
*16800	140:1	120	PT7-1-150-SD02381	86 ohms
19920	166:1	120	PT7-1-150-SD01620	86 ohms
*20125	175:1	115	PT7-1-150-2012A	86 ohms
24000	200:1	120	PT7-1-150-SD03289	48 ohms
26400	220:1	120	PT7-1-150-SD02085	48 ohms
27000	225:1	120	PT7-1-150-SD03158	48 ohms
27600	240:1	115	PT7-1-150-SD03449	48 ohms
34500	300:1	115	PT7-1-150-SD01617	48 ohms

NOTE: All primary voltages marked with an asterisk (*) are approved for revenue metering in Canada by industrial Canada, Approval No. AE-0677 Rev. 1

** Consult factory for 200kV BIL catalog numbers.

Models PT7-2-150 & PT7-2-200 150-200kV BIL, 24000-34500V

 E145172



APPLICATION
Designed for indoor service; suitable for operating meters, instruments, relays and control devices.

MAXIMUM SYSTEM VOLTAGE:
36.5kV, BIL 200kV full wave.

THERMAL RATING (VOLT-AMPERES)
55°C Rise above 30°C Ambient1500 VA
30°C Rise above 55°C Ambient1000 VA

ACCURACY CLASS
0.3 W, X, M, Y, Z & 1.2 ZZ at 100% rated voltage with 120V based IEEE burden.
0.3 W, X, M, Y & 1.2Z at 58% rated voltage with 69.3V based IEEE burden

WEIGHT (Approximate)
Unfused140 lbs

DIMENSIONS
Height13.44"
Width13.75"
Depth9.50"

INSULATION
Polyurethane

FREQUENCY:
60 Hz.

PT7-2-150 & PT7-2-200 DATA TABLE

PRIMARY VOLTAGE	RATIO	SECONDARY VOLTAGE	150 kV BIL CATALOG NUMBERS	200 kV BIL CATALOG NUMBERS	*150 kV BIL CATALOG NUMBERS
24000	200:1	120	PT7-2-150-243	PT7-2-200-243	PTS7-2-150-243
27600	240:1	115	PT7-2-150-2762	PT7-2-200-2762	PTS7-2-150-2762
34500	300:1	115	PT7-2-150-3452	PT7-2-200-3452	PTS7-2-150-3452

NOTE: Approved for revenue metering in Canada by industrial Canada, Approval No. AE-0677 Rev. 1
* Reduced width dimension for roll-out drawer or truck mounted installations.

5kV Thru 69kV Current Transformers (Outdoor)

**Models JCW-3 / JCW-4 / JCW-5
5kV to 15kV, 60kV to 110kV BIL 600A to 1200A**

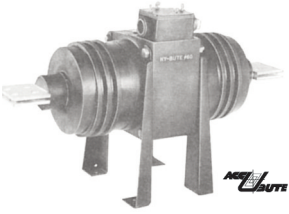

JCW-3 & JCW-4

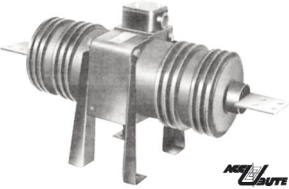

JCW-5

APPLICATION
Designed for outdoor service; suitable for operating meters, relays and control devices.

Weight - Shipping/Net
(approximate, in pounds)
Transformer123/111

DIMENSIONS
JCW-3 -4 -5
Height16.19", 16.19", 16.19"
Width10.00", 10.00", 10.00"
Length27.00", 27.00", 32.00"

INSULATION
Hy-Bute-60

FREQUENCY
50-60 Hz

JCW-3/ JCW-4/ JCW-5 DATA TABLE

Current Ratio (Amps) Pri : Sec	IEEE Accuracy Class 60 Hz Burden		Continuous Thermal Current Rating Factor	One Second Thermal Limit, Amps	Catalog Number		
	Meter Class				JCW-3 5,000 V BIL 60 kV	JCW-4 8,700 V BIL 75 kV	JCW-5 15,000 V BIL 110 kV
	B2.0	Relay Class	@ 30° C Amb.				
Single Ratio							
1200:5	0.3	C200	1.33	55000	753X030003	754X030003	755X030003
1500:5	0.3	C200	1.33	69000	753X030004	754X030004	755X030004
2000:5	0.3	C200	1.33	148000	753X030005	754X030005	755X030005
3000:5	0.3	C200	1.33	279000	753X030007	754X030007	755X030007
4000:5	0.3	C200	1.0	456000	753X030008	754X030008	755X030008
Dual Ratio							
600/1200:5	0.6	C100	2.0	55000	753X030009	754X030009	755X030009
	0.3	C200	1.33	55000			
750/1500:5	0.6	C100	2.0	69000	753X030010	754X030010	755X030010
	0.3	C200	1.33	69000			
1000/2000:5	0.6	C100	2.0	148000	753X030011	754X030011	755X030011
	0.3	C200	1.33	148000			
1500/3000:5	0.3	C100	2.0	279000	753X030012	754X030012	755X030012
	0.3	C200	1.33	279000			
	0.3	C100	2.0	456000			
2000/4000:5	0.3	C100	2.0	456000	753X030013	754X030013	755X030013
	0.3	C200	1.0	456000			

**Models JCD-3 / JCD-4 / JCD-5 5.56" Window
5kV to 15kV, 60kV to 110kV BIL 600A to 1200A**

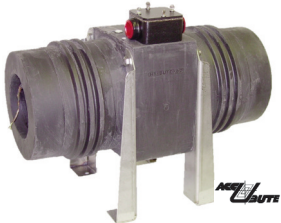

JCD-5

APPLICATION
Designed for outdoor service; suitable for operating meters, relays and control devices.

Weight - Shipping/Net
(approximate, in pounds)
Transformer, JCD-3, JCD-4.....120/110
Transformer, JCD-5.....150/135

DIMENSIONS
JCW-3 -4 -5
Height18.47", 18.47", 18.47"
Width12.50", 12.50", 12.50"
Length18.00", 18.00", 23.00"

INSULATION
Hy-Bute-60

FREQUENCY
50-60 Hz

JCD-3/ JCD-4/ JCD-5 DATA TABLE

Current Ratio (Amps) Pri : Sec	IEEE Accuracy Class 60 Hz Burden		Continuous Thermal Current Rating Factor	One Second Thermal Limit, Amps	Catalog Number		
	Meter Class				JCD-3 5,000 V BIL 60 kV	JCD-4 8,700 V BIL 75 kV	JCD-5 15,000 V BIL 110 kV
	B2.0	Relay Class	@ 30° C Amb.				
Single Ratio							
1200:5	0.3	C200	1.33	88800	753X031008	754X031008	755X031008
1500:5	0.3	C200	1.33	111000	753X031009	754X031009	755X031009
2000:5	0.3	C400	1.33	148000	753X031011	754X031011	755X031011
3000:5	0.3	C400	1.33	282000	753X031013	754X031013	755X031013
4000:5	0.3	C200	1.33	296000	753X031014	754X031014	755X031014
Dual Ratio							
600/1200:5	---	C100	2.0	88800	753X031016	754X031016	755X031016
	0.3	C200	1.33	88800			
750/1500:5	0.6	C100	2.0	111000	753X031017	754X031017	755X031017
	0.3	C200	1.33	111000			
1000/2000:5	0.6	C200	2.0	148000	753X031018	754X031018	755X031018
	0.3	C400	1.33	148000			
1500/3000:5	0.3	C200	2.0	282000	753X031019	754X031019	755X031019
	0.3	C400	1.33	282000			
	0.3	C100	2.0	296000			
2000/4000:5	0.3	C100	2.0	296000	753X031020	754X031020	755X031020
	0.3	C200	1.33	296000			

5kV Thru 69kV Current Transformers (Outdoor)

Models JCK-3 /JCK-4

5kV to 8.7kV, 60kV to 75kV BIL 5A to 800A



APPLICATION
Designed for outdoor service; suitable for metering applications.

Weight - Shipping/Net
(approximate, in pounds)
Transformer, without base 43/35

DIMENSIONS
JCK-3 -4
Height13.63"
Width7.88"
Length11.00

Accessories Catalog Number
Mounting Hardware:
"L" Mounting Brackets8944634001
Auxiliary "L" Mounting Bracket 8944270001
Channel Bracket 5466227001
Suspension Hooks 8944630001
Secondary Conduit Box9689897001

INSULATION
Hy-Bute-60

FREQUENCY
50-60 Hz

JCK-3/ JCK-4/ DATA TABLE

Current Ratio (Amps) Pri : Sec	IEEE Accuracy Class 60 Hz Burden		Continuous Thermal Current Rating Factor	Mechanical Limit, Amps	One Second Thermal Limit, Amps	Catalog Number	
	Meter Class					JCK-3 5,000 V BIL 60 kV	JCK-4 8,700 V BIL 75 kV
	B0.1	B0.2	@ 30° C Amb.				
Single Ratio							
5:5	0.3	0.3 ¹	3.0	3400	1900	753X051001	754X051001
10:5	0.3	0.3	3.0	3400	1900	753X051002	754X051002
15:5	0.3	0.3	3.0	5100	2850	753X051003	754X051003
20:5	0.3	0.3	3.0	6800	3825	753X051004	754X051004
25:5	0.3	0.3	3.0	8500	4775	753X051005	754X051005
30:5	0.3	0.3	3.0	10200	5725	753X051006	754X051006
40:5	0.3	0.3	3.0	13600	7650	753X051007	754X051007
50:5	0.3	0.3	3.0	17000	9550	753X051008	754X051008
75:5	0.3	0.3	3.0	21250	11775	753X051009	754X051009
100:5	0.3	0.3	3.0	34000	19125	753X051010	754X051010
150:5	0.3	0.3	3.0	42500	23575	753X051011	754X051011
200:5	0.3	0.3	3.0	56100	38250	753X051012	754X051012
300:5	0.3	0.3	3.0	85000	46750	753X051013	754X051013
400:5	0.3	2.5	2.5	85000	47600	753X051014	754X051014
600:5	0.3	2.0	2.0	85000	51000	753X051015	754X051015
800:5	0.3	1.5	1.5	85000	51000	753X051016	754X051016

NOTE
¹ Contact factory for B0.5 rating

Models JKW-3 & JKW-4

5kV to 8.7kV, 60kV to 75kV BIL 5 to 800A



APPLICATION
Designed for outdoor service; suitable for operating meters, relays, and control devices.

Weight - Shipping/Net
(approximate, in pounds)
Transformer, without base 48/40

DIMENSIONS
JKW-3 -4
Height12.94"
Width9.38"
Length7.88"

Accessories Catalog Number
Mounting Hardware:
"L" Mounting Brackets8944634001
Auxiliary "L" Mounting Bracket 8944270001
Channel Bracket 5466227001
Suspension Hooks 8944630001
Secondary Conduit Box9689897001

INSULATION
Hy-Bute-60

FREQUENCY
50-60 Hz

JKW-3 & JKW-4 DATA TABLE

Current Ratio (Amps) Pri : Sec ①	IEEE Accuracy Class 60 Hz Burden		Continuous Thermal Current Rating Factor	One Second Thermal Limit, Amps	Mechanical Limit, Amps		Catalog Number	
	Meter Class				JKW-3	JKW-4	JKW-3 BIL 60kV	JKW-4 BIL 75kV
	B0.1 Thru B1.8	Relay Class	@ 30° C Amb.					
Single Ratio								
5:5	0.3	T100	1.5	465	900	---	753X050008	---
10:5	0.3	T100	1.5	930	1800	1100	753X050009	754X050002
15:5	0.3	T100	1.5	1470	2700	1650	753X050010	754X050003
20:5	0.3	T100	1.5	1850	3600	2200	753X050011	754X050004
25:5	0.3	T100	1.5	2300	4500	2750	753X050012	754X050005
30:5	0.3	T100	1.5	2450	5400	3300	753X050013	754X050006
40:5	0.3	T100	1.5	3700	7200	4400	753X050014	754X050007
50:5	0.3	T100	1.5	4600	9000	5500	753X050015	754X050008
75:5	0.3	T100	1.5	6400	13500	8250	753X050016	754X050009
100:5	0.3	T100	1.5	8600	18000	11000	753X050017	754X050010
150:5	0.3	T100	1.5	12800	27000	16500	753X050018	754X050011
200:5	0.3	T100	1.5	17300	36000	22000	753X050019	754X050012
300:5	0.3	T100	1.5	25700	54000	33000	753X050021	754X050014
400:5	0.3	T100	1.5	36000	72000	44000	753X050022	754X050015
600:5	0.3	T100	1.5	51500	108000	66000	753X050024	754X050017
800:5	0.3	T100	1.25	67000	108000	80000	753X050025	754X050018

Note
① Dual-ratio models with tapped-secondary are available. Please contact the factory for information.

5kV Thru 69kV Current Transformers (Outdoor)

Models JCK-5 15kV, 110kV BIL 5 to 800A



APPLICATION
Designed for outdoor service; suitable for metering applications.

Weight - Shipping/Net
(approximate, in pounds)
Transformer, without base 43/35

DIMENSIONS
JCK-3 -4
Height13.63"
Width9.38"
Length11.00

Accessories Catalog Number
Mounting Hardware:
"L" Mounting Brackets8944634002
Auxiliary "L" Mounting Bracket 8944270001
Channel Bracket 5466227001
Suspension Hooks 8944630001
Secondary Conduit Box9689897001

INSULATION
Hy-Bute-60

FREQUENCY
50-60 Hz

JCK-5 DATA TABLE

Current Ratio (Amps) Pri : Sec	IEEE Accuracy Class 60 Hz Burden		Continuous Thermal Current Rating Factor	Mechanical Limit, Amps	One Second Thermal Limit, Amps	Catalog Number
	Meter Class					
	B0.1 B0.2	B0.5	@ 30° C Amb.			JCK-5 15,000 V BIL 110 kV
Single Ratio						
5:5	0.3	0.3 ¹	3.0	4000	2250	755X052016
10:5	0.3	0.3	3.0	4000	2250	755X052001
15:5	0.3	0.3	3.0	6000	3375	755X052002
20:5	0.3	0.3	3.0	8000	4500	755X052003
25:5	0.3	0.3	3.0	10000	5625	755X052004
30:5	0.3	0.3	3.0	12000	6750	755X052005
40:5	0.3	0.3	3.0	16000	9000	755X052006
50:5	0.3	0.3	3.0	20000	11250	755X052007
75:5	0.3	0.3	3.0	25000	13875	755X052008
100:5	0.3	0.3	3.0	40000	22500	755X052009
150:5	0.3	0.3	3.0	50000	27750	755X052010
200:5	0.3	0.3	3.0	66000	45000	755X052011
300:5	0.3	0.3	3.0	100000	55500	755X052012
400:5	0.3	2.5	2.5	100000	56000	755X052013
600:5	0.3	2.0	2.0	100000	60000	755X052014
800:5	0.3	1.5	1.5	100000	60000	755X052015

NOTE
¹ Contact factory for B0.5 rating

Models JCK-5C 15kV, 110kV BIL 5 to 1200 A



APPLICATION
Designed for outdoor service; suitable for operating meters, instruments, relays and control devices.

DIMENSIONS/WEIGHT
Height: 14.55"
Depth: 12.37"
Width: 10.88"
Weight (Approximate).....40 lbs

INSULATION LEVEL
15.5kV; BIL: 110kV per C57.13

INSULATION
HCEP

FREQUENCY
60Hz

JCK-5C DATA TABLE

Current Ratio	IEEE Accuracy Class 60 Hz Burden		Rating Factor	Catalog Number
	Metering Class	Relay Class		
5:5	0.3 B-0.5	C40	3.0	755C152001
10:5	0.3 B-0.5	C40	3.0	755C152002
15:5	0.3 B-0.5	C40	3.0	755C152003
20:5	0.3 B-0.5	C40	3.0	755C152004
25:5	0.3 B-0.5	C40	3.0	755C152005
30:5	0.3 B-0.5	C40	3.0	755C152006
40:5	0.3 B-0.5	C40	3.0	755C152007
50:5	0.3 B-0.5	C40	3.0	755C152008
75:5	0.3 B-0.5	C40	3.0	755C152009
100:5	0.3 B-0.5	C40	3.0	755C152010
150:5	0.3 B-0.5	C40	3.0	755C152011
200:5	0.3 B-0.5	C40	3.0	755C152012
300:5	0.3 B-0.5	C40	3.0	755C152013
400:5	0.3 B-0.5	C40	3.0	755C152014
600:5	0.3 B-0.5	C40	2.0	755C152015
800:5	0.3 B-0.5	C40	1.5	755C152016
1000:5	0.3 B-0.5	C40	1.2	755C152017
1200:5	0.3 B-0.5	C40	1.0	755C152018

Models JCK-5CER Extended Range 15kV, 110kV BIL



APPLICATION
Designed for outdoor service; suitable for high accuracy metering.

DIMENSIONS/WEIGHT
Height: 14.55"
Depth: 12.37"
Width: 10.88"
Weight (Approximate).....40 lbs

INSULATION LEVEL
15.5kV; BIL: 110kV per C57.13

INSULATION
HCEP

FREQUENCY
60Hz

JCK-5CER DATA TABLE

Current Ratio	IEEE Accuracy Class 60 Hz Burden*	Rating Factor	Rated Performance Range	Catalog Number
200:5	0.15S B1.8	1.5	2A to 300A	755C153001
1000:5	0.15S B1.8	1.5	10A to 1500A	755C153002

*GE Extended Range: ±0.15% Accuracy from 1% Inom through Rating Factor

5kV Thru 69kV Current Transformers (Outdoor)

Models JKW-5C 15kV, 110kV BIL 5 to 1200 A

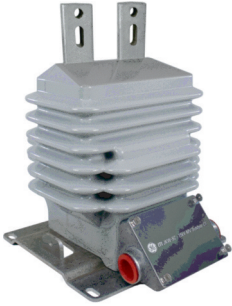

APPLICATION
Designed for outdoor service; suitable for operating meters, instruments, relays and control devices.

DIMENSIONS/WEIGHT
Height: 14.55"
Depth: 12.37"
Width: 10.88"
Weight (Approximate).....66 lbs

INSULATION LEVEL
15.5kV; BIL: 110kV per C57.13

INSULATION
HCEP

FREQUENCY
60Hz

JKW-5C DATA TABLE

Catalog Number	Current Ratio	IEEE Accuracy Class 60 Hz Burden		Rating Factor
		Relay Class	Metering Class	
Single Ratio				
755C150001	5:5	C200	0.3 B1.8	1.5
755C150002	10:5	C200	0.3 B1.8	1.5
755C150003	15:5	C200	0.3 B1.8	1.5
755C150004	20:5	C200	0.3 B1.8	1.5
755C150005	25:5	C200	0.3 B1.8	1.5
755C150006	30:5	C200	0.3 B1.8	1.5
755C150007	40:5	C200	0.3 B1.8	1.5
755C150008	50:5	C200	0.3 B1.8	1.5
755C150009	75:5	C200	0.3 B1.8	1.5
755C150010	100:5	C200	0.3 B1.8	1.5
755C150011	150:5	C200	0.3 B1.8	1.5
755C150012	200:5	C200	0.3 B1.8	1.5
755C150013	300:5	C200	0.3 B1.8	1.5
755C150014	400:5	C200	0.3 B1.8	1.5
755C150015	600:5	C200	0.3 B1.8	1.5
755C150016	800:5	C200	0.3 B1.8	1.33
755C150017	1000:5	C150	0.3 B1.8	1.33
755C150018	1200:5	C200	0.3 B1.8	1.1
Dual Ratio				
755C150202	5/10:5	C100 / C200	0.3 B0.9 / 0.3 B1.8	2.0 / 1.5
755C150204	10/20:5	C100 / C200	0.3 B0.9 / 0.3 B1.8	2.0 / 1.5
755C150207	20/40:5	C100 / C200	0.3 B0.9 / 0.3 B1.8	2.0 / 1.5
755C150208	25/50:5	C100 / C200	0.3 B0.9 / 0.3 B1.8	2.0 / 1.5
755C150210	50/100:5	C100 / C200	0.3 B0.9 / 0.3 B1.8	2.0 / 1.5
755C150211	75/150:5	C100 / C200	0.3 B0.9 / 0.3 B1.8	2.0 / 1.5
755C150212	100/200:5	C100 / C200	0.3 B0.9 / 0.3 B1.8	2.0 / 1.5
755C150213	150/300:5	C100 / C200	0.3 B0.9 / 0.3 B1.8	2.0 / 1.5
755C150214	200/400:5	C100 / C200	0.3 B0.9 / 0.3 B1.8	2.0 / 1.5
755C150215	300/600:5	C100 / C200	0.3 B0.9 / 0.3 B1.8	2.0 / 1.5
755C150216	400/800:5	C100 / C200	0.3 B0.9 / 0.3 B1.8	2.0 / 1.33
755C150218	600/1200:5	C100 / C200	0.3 B0.9 / 0.3 B1.8	2.0 / 1.1

Model JKW-5 15kV, 110kV BIL, 5-1200A



APPLICATION
Designed for outdoor service; suitable for operating meters, relays, and control devices.

Weight - Shipping/Net (approximate, in pounds)
Transformer75/60

DIMENSIONS
Height15.69"
Width10.88"
Length12.75"

Accessories Catalog Number
Mounting Hardware
"L" Mounting Brackets 8944634002
Channel Bracket 5466227001
Suspension Hooks 8944630001
Secondary Conduit Box9689897001

INSULATION
Hy-Bute-60

FREQUENCY
50-60 Hz

JKW-5 DATA TABLE

Current Ratio (Amps) Pri : Sec	IEEE Accuracy Class 60 Hz Burden		Continuous Thermal Current Rating Factor@ 30° C Amb.	Mechanical Limit, Amps	One Second Thermal Limit, Amps	Catalog Number
	Metering Class	Relay Class				
Single Ratio						
5:5	0.3 B1.8	T200	1.5	625	425	755X050101
10:5	0.3 B1.8	T200	1.5	1250	930	755X050102
15:5	0.3 B1.8	T200	1.5	1875	1470	755X050103
20:5	0.3 B1.8	T200	1.5	2500	1860	755X050104
25:5	0.3 B1.8	T200	1.5	3125	2300	755X050105
30:5	0.3 B1.8	T200	1.5	3750	2460	755X050106
40:5	0.3 B1.8	T200	1.5	5000	3720	755X050107
50:5	0.3 B1.8	T200	1.5	6250	4600	755X050108
75:5	0.3 B1.8	T200	1.5	9375	6375	755X050109
100:5	0.3 B1.8	T200	1.5	12500	8600	755X050110
150:5	0.3 B1.8	T200	1.5	18750	12750	755X050111
200:5	0.3 B1.8	T200	1.5	25000	17200	755X050112
300:5	0.3 B1.8	T200	1.5	37500	25800	755X050114
400:5	0.3 B1.8	T200	1.5	50000	36000	755X050115
600:5	0.3 B1.8	T200	1.5	75000	51600	755X050117
800:5	0.3 B1.8	T200	1.2	80000	63200	755X050118
1000:5	0.3 B1.8	T180	1.0	100000	82000	755X050119
1200:5	0.3 B1.8	T200	1.0	100000	82000	755X050120
Dual-Secondary						
50/100:5	0.3 B0.9 / 0.3 B1.8	T100 / T200	2.0 / 1.5	12500 / 12500	4300 / 8600	755X050124
75/150:5	0.3 B0.9 / 0.3 B1.8	T100 / T200	2.0 / 1.5	18750 / 18750	6375 / 12750	755X050125
100/200:5	0.3 B0.9 / 0.3 B1.8	T100 / T200	2.0 / 1.5	25000 / 25000	8600 / 17200	755X050126
150/300:5	0.3 B0.9 / 0.3 B1.8	T100 / T200	2.0 / 1.5	37500 / 37500	12900 / 25800	755X050127
200/400:5	0.3 B0.9 / 0.3 B1.8	T100 / T200	2.0 / 1.5	50000 / 50000	18000 / 36000	755X050128
300/600:5	0.3 B0.9 / 0.3 B1.8	T100 / T200	2.0 / 1.5	75000 / 75000	25800 / 51600	755X050129
400/800:5	0.3 B0.9 / 0.3 B1.8	T100 / T200	2.0 / 1.2	80000 / 80000	31600 / 63200	755X050130
600/1200:5	0.3 B0.9 / 0.3 B1.8	T100 / T200	1.5 / 1.0	80000 / 80000	31600 / 63200	755X050720

5kV Thru 69kV Current Transformers (Outdoor)

Models JKW-5AC High Accuracy 15kV, 110kV BIL 5 to 1200 A

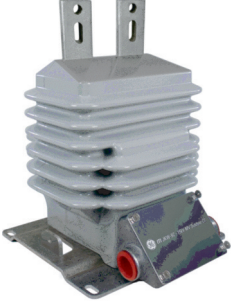

APPLICATION
Designed for outdoor service; suitable for operating meters, instruments, relays and control devices.

DIMENSIONS/WEIGHT
Height: 14.55"
Depth: 12.37"
Width: 10.88"
Weight (Approximate).....66 lbs

INSULATION LEVEL
15.5kV; BIL: 110kV per C57.13

INSULATION
HCEP

FREQUENCY
60Hz

JKW-5AC DATA TABLE

Catalog Number	Current Ratio	IEEE Accuracy Class 60 Hz Burden		Rating Factor
		Relay Class	Metering Class	
Single Ratio				
755C151001	5:5	C200	0.15 B0.9	1.5
755C151002	10:5	C200	0.15 B0.9	1.5
755C151003	15:5	C200	0.15 B0.9	1.5
755C151004	20:5	C200	0.15 B0.9	1.5
755C151005	25:5	C200	0.15 B0.9	1.5
755C151006	30:5	C200	0.15 B0.9	1.5
755C151007	40:5	C200	0.15 B0.9	1.5
755C151008	50:5	C200	0.15 B0.9	1.5
755C151009	75:5	C200	0.15 B0.9	1.5
755C151010	100:5	C200	0.15 B0.9	1.5
755C151011	150:5	C200	0.15 B0.9	1.5
755C151012	200:5	C200	0.15 B0.9	1.5
755C151013	300:5	C200	0.15 B0.9	1.5
755C151014	400:5	C200	0.15 B0.9	1.5
755C151015	600:5	C200	0.15 B0.9	1.5
755C151016	800:5	C200	0.15 B0.9	1.33
755C151017	1000:5	C150	0.15 B0.9	1.33
755C151018	1200:5	C200	0.15 B0.9	1.1

Model JKW-5A Special High Accuracy 15kV, 110kV BIL



APPLICATION
Designed for outdoor service; suitable for operating meters, relays, and control devices. The Type JKW-5A features 0.15 accuracy from 5% of primary current through Rating Factor Amps when applied within its burden capability.

Weight - Shipping/Net (approximate, in pounds)
Transformer75/60

DIMENSIONS
Height15.69"
Width10.88"
Length12.75"

Accessories Catalog Number
Mounting Hardware8944634002
"L" Mounting Brackets5466227001
Channel Bracket8944630001
Suspension Hooks9689897001
Secondary Conduit Box9689897001

INSULATION
Hy-Bute-60

FREQUENCY
50-60 Hz

JKW-5A DATA TABLE

Current Ratio (Amps) Pri : Sec	IEEE Accuracy Class 60 Hz. Burden	Continuous Thermal Current Rating Factor@ 30° C Amb.	Mechanical Limit; Amperes	One-Second Thermal Limit, Amperes	Catalog Number
5:5	0.15S B0.5	1.5	625	465	755X053101
10:5	0.15S B0.5	1.5	1250	930	755X053102
15:5	0.15S B0.5	1.5	1875	1470	755X053103
20:5	0.15S B0.5	1.5	2500	1860	755X053104
25:5	0.15S B0.5	1.5	3125	2300	755X053105
30:5	0.15S B0.5	1.5	3750	2460	755X053106
40:5	0.15S B0.5	1.5	5000	3720	755X053107
50:5	0.15S B0.5	1.5	6250	4600	755X053108
75:5	0.15S B0.5	1.5	9375	6375	755X053109
100:5	0.15S B0.5	1.5	12500	8600	755X053110
150:5	0.15S B0.5	1.5	18750	12750	755X053111
200:5	0.15S B0.5	1.5	25000	17200	755X053112
300:5	0.15S B0.5	1.5	37500	25800	755X053114
400:5	0.15S B0.5	1.5	50000	36000	755X053115
600:5	0.15S B0.5	1.5	75000	51600	755X053117
800:5	0.15S B0.5	1.2	80000	63200	755X053118
1200:5	0.15S B0.5	1.0	100000	82000	755X053120

5kV Thru 69kV Current Transformers (Outdoor)

Model JKW-6

25kV, 150kV BIL, 5-1200A



APPLICATION
Designed for outdoor service; suitable for operating meters, relays, and control devices.

Weight - Shipping/Net (approximate, in pounds)
Transformer95/80

DIMENSIONS
Height15.94"
Width10.88"
Length12.38"

Accessories Catalog Number
Mounting Hardware:
"L" Mounting Brackets8944634001
Auxiliary "L" Mounting Bracket 8944270001
Channel Bracket 5466227001
Suspension Hooks 8944630001
Secondary Conduit Box9689897001

INSULATION
Hy-Bute-60

FREQUENCY
50-60 Hz

JKW-6 DATA TABLE

Current Ratio (Amps) Pri : Sec	IEEE Accuracy Class 60 Hz Burden			Continuous Thermal Current Rating Factor@ 30°C Amb.	Mechanical Limit, Amps	One Second Thermal Limit, Amps	Catalog Number
	Meter Class B0.1 thru B0.9	B1.8	Relay Class				
Single Ratio							
5:5	0.3	---	T100	3.0	1850	1000	756X050001
10:5	0.3	---	T100	3.0	3700	2000	756X050002
15:5	0.3	---	T100	3.0	5550	3000	756X050003
20:5	0.3	---	T100	3.0	7400	4000	756X050004
25:5	0.3	---	T100	3.0	9250	5000	756X050005
50:5	0.3	---	T100	3.0	12500	10000	756X050006
75:5	0.3	---	T100	3.0	18750	15000	756X050007
100:5	0.3	---	T100	3.0	25000	20000	756X050008
150:5	0.3	---	T100	3.0	37500	30000	756X050009
200:5	0.3	---	T100	3.0	50000	40000	756X050010
300:5	0.3	---	T100	2.8	75000	60000	756X050011
400:5	0.3	---	T100	2.5	80000	64000	756X050012
600:5	0.3	---	T100	2.0	100000	64000	756X050013
800:5	0.3	---	T100	1.5	100000	64000	756X050014
Single Ratio							
10:5	0.3	0.3	T200	1.5	1850	1000	756X050022
15:5	0.3	0.3	T200	1.5	2775	1500	756X050023
20:5	0.3	0.3	T200	1.5	3700	2000	756X050024
25:5	0.3	0.3	T200	1.5	4625	2500	756X050025
50:5	0.3	0.3	T200	1.5	9250	5000	756X050026
75:5	0.3	0.3	T200	1.5	9375	7500	756X050027
100:5	0.3	0.3	T200	1.5	12500	10000	756X050028
150:5	0.3	0.3	T200	1.5	18750	15000	756X050029
200:5	0.3	0.3	T200	1.5	25000	20000	756X050030
300:5	0.3	0.3	T200	1.5	37500	30000	756X050031
400:5	0.3	0.3	T200	1.5	50000	40000	756X050032
600:5	0.3	0.3	T200	1.5	75000	60000	756X050033
800:5	0.3	0.3	T200	1.25	80000	64000	756X050034
1200:5	0.3	0.3	T200	1.0	150000	120000	756X050035
Dual-Secondary							
10/20:5	0.3	---	T100	2.0	3700	1000	756X050041
	0.3	0.3	T200	1.5	3700	2000	
25/50:5	0.3	---	T100	2.0	9250	2500	756X050042
	0.3	0.3	T200	1.5	9250	5000	
50/100:5	0.3	---	T100	2.0	12500	5000	756X050043
	0.3	0.3	T200	1.5	12500	10000	
75/150:5	0.3	---	T100	2.0	18750	7500	756X050044
	0.3	0.3	T200	1.5	18750	15000	
100/200:5	0.3	---	T100	2.0	25000	10000	756X050045
	0.3	0.3	T200	1.5	25000	20000	
150/300:5	0.3	---	T100	2.0	37500	15000	756X050046
	0.3	0.3	T200	1.5	37500	30000	
200/400:5	0.3	---	T100	2.0	50000	20000	756X050047
	0.3	0.3	T200	1.5	50000	40000	
300/600:5	0.3	---	T100	2.0	75000	30000	756X050048
	0.3	0.3	T200	1.5	75000	60000	
400/800:5	0.3	---	T100	1.5	100000	40000	756X050049
	0.3	0.3	T200	1.25	100000	80000	
600/1200:5	0.3	---	T100	1.5	125000	50000	756X050050
	0.3	0.3	T200	1.25	125000	100000	

Model JKW-6A Special High Accuracy 25kV, 150kV BIL



APPLICATION
Designed for outdoor service; suitable for operating meters, relays and control devices. The Type JKW-6A features 0.15 accuracy from 5% of primary current through Rating Factor Amps when applied within its burden capability.

Weight - Shipping/Net (approximate, in pounds)
Transformer90/75

DIMENSIONS
Height15.94"
Width10.88"
Length12.38"

Accessories Catalog Number
Mounting Hardware:
"L" Mounting Brackets8944634002
Channel Bracket 5466227001
Suspension Hooks 8944630001
Secondary Conduit Box9689897001

INSULATION
Hy-Bute-60

FREQUENCY
50-60 Hz

JKW-6A DATA TABLE

Current Ratio (Amps) Pri : Sec	IEEE Accuracy Class 60 Hz. Burden	Continuous Thermal Current Rating Factor@ 30°C Amb.	Mechanical Limit, Amperes	One-Second Thermal Limit, Amperes	Catalog Number
5:5	0.15S B0.5	1.5	925	500	756X051021
10:5	0.15S B0.5	1.5	1850	1000	756X051022
15:5	0.15S B0.5	1.5	2775	1500	756X051023
20:5	0.15S B0.5	1.5	3700	2000	756X051024
25:5	0.15S B0.5	1.5	4625	2500	756X051025
50:5	0.15S B0.5	1.5	9250	5000	756X051026
75:5	0.15S B0.5	1.5	9375	7500	756X051027
100:5	0.15S B0.5	1.5	12500	10000	756X051028
155:5	0.15S B0.5	1.5	18750	15000	756X051029
200:5	0.15S B0.5	1.5	25000	20000	756X051030
300:5	0.15S B0.5	1.5	37500	30000	756X051031
400:5	0.15S B0.5	1.5	50000	40000	756X051032
600:5	0.15S B0.5	1.5	75000	60000	756X051033
800:5	0.15S B0.5	1.0	100000	80000	756X051034
1200:5	0.15S B0.5	1.0	150000	120000	756X051035

5kV Thru 69kV

Current Transformers (Outdoor)

Model JKW-7

34.5kV, 200kV BIL, 10-800A



APPLICATION
Designed for outdoor service; suitable for metering applications.

Weight - Shipping/Net (approximate, in pounds)
Transformer78/72

DIMENSIONS
Height19.88"
Width10.88"
Length12.75"

Accessories Catalog Number
Mounting Hardware:
"L" Mounting Brackets8944634002
Channel Bracket 5466227001
Suspension Hooks 8944630
Secondary Conduit Box9689897001

INSULATION
Hy-Bute-60

FREQUENCY
50-60 Hz

JKW-7 DATA TABLE

Current Ratio (Amps) Pri : Sec	IEEE Accuracy Class 60 Hz Burden			Continuous Thermal Current Rating Factor@ 30° C Amb.	Mechanical Limit, Amps	One Second Thermal Limit, Amps	Catalog Number
	Meter Class						
	B0.1 & B0.2	B0.5	B0.9				
Single Ratio							
10:5	0.3	0.3	0.6	3.0	4000	2250 Ⓞ	757X050001
15:5	0.3	0.3	0.6	3.0	6000	3375 Ⓞ	757X050002
20:5	0.3	0.3	0.6	3.0	8000	4500 Ⓞ	757X050003
25:5	0.3	0.3	0.6	3.0	10000	5625 Ⓞ	757X050004
30:5	0.3	0.3	0.6	3.0	12000	6750 Ⓞ	757X050005
40:5	0.3	0.3	0.6	3.0	16000	9000 Ⓞ	757X050006
50:5	0.3	0.3	0.6	3.0	20000	11250 Ⓞ	757X050007
75:5	0.3	0.3	0.6	3.0	24975	13875 Ⓞ	757X050008
100:5	0.3	0.3	0.6	3.0	40000	22500 Ⓞ	757X050009
150:5	0.3	0.3	0.6	3.0	49950	27750 Ⓞ	757X050010
200:5	0.3	0.3	0.6	3.0	66600	45000 Ⓞ	757X050011
300:5	0.3	0.3	0.6	3.0	100000	55500 Ⓞ	757X050012
400:5	0.3	0.3	0.6	2.5	100000	56000 Ⓞ	757X050013
600:5	0.3	0.3	0.6	2.0	100000	60000 Ⓞ	757X050014
800:5	0.3	0.3	0.6	1.5	100000	60000 Ⓞ	757X050015
Dual-Secondary							
10/20:5	0.3	---	---	3.0	4780	2250 Ⓞ	757X050018
	0.3	0.3	0.6	2.0	4780	2760 Ⓞ	
15/30:5	0.3	---	---	3.0	7980	3375 Ⓞ	757X050019
	0.3	0.3	0.6	2.0	7980	4500 Ⓞ	
20/40:5	0.3	---	---	3.0	10320	4500 Ⓞ	757X050020
	0.3	0.3	0.6	2.0	10320	5600 Ⓞ	
25/50:5	0.3	---	---	3.0	12150	5625 Ⓞ	757X050021
	0.3	0.3	0.6	2.0	12150	6750 Ⓞ	
50/100:5	0.3	---	---	3.0	24900	11250 Ⓞ	757X050022
	0.3	0.3	0.6	2.0	24900	15000 Ⓞ	
75/150:5	0.3	---	---	3.0	39900	16875 Ⓞ	757X050023
	0.3	0.3	0.6	2.0	39900	21000 Ⓞ	
100/200:5	0.3	---	---	3.0	49800	22500 Ⓞ	757X050024
	0.3	0.3	0.6	2.0	49800	25000 Ⓞ	
150/300:5	0.3	---	---	3.0	66600	33750 Ⓞ	757X050025
	0.3	0.3	0.6	2.0	66600	40500 Ⓞ	
200/400:5	0.3	---	---	3.0	66400	40000 Ⓞ	757X050026
	0.3	0.3	0.3	2.0	66400	40000 Ⓞ	
300/600:5	0.3	---	---	3.0	99600	63000 Ⓞ	757X050027
	0.3	0.3	0.6	2.0	99600	63000 Ⓞ	
400/800:5	0.3	0.3	---	2.0	100000	64000 Ⓞ	757X050028
	0.3	0.3	0.3	1.5	100000	64000 Ⓞ	

Note
Ⓞ With burden of 80.1 or greater

5kV Thru 69kV Current Transformers (Outdoor)

Model JKW-150 & JKW-200
25kV to 34.5kV, 150kV to 200kV BIL, 25-3000A



JKW-200 Shown



Application
 Designed for outdoor service; suitable for operating meters, relays and control devices.

IEEE Meter Accuracy Class, 60 Hz
 B0.1 through B1.8; all models - 0.3
 Contact factory for 0.15, 0.15S, and extended range options.

One-Second Thermal Overcurrent Capability
 All models 75 x normal

Two-cycle Mechanical Capability
 Low ratio; minimum 170 x normal
 High ratio; minimum 85 x normal

Weight - Shipping/Net
 (approximate, in pounds)
 Transformer, JKW-150 378/323
 Transformer, JKW-200 403/438

INSULATION
 Super-Bute

FREQUENCY
 50-60 Hz



JKW-150 & JKW-200 DATA TABLE

Current Ratio (Amps) Pri : Sec	IEEE Accuracy Class 60 Hz Burden		Continuous Thermal Current Rating Factor@ 30° C Amb. Ⓞ	Catalog Number	
	Metering Class	Relay Class		JKW-150 25000 V BIL 150 kV	JKW-200 34500 V BIL 200 kV
25/50:5	0.3 B1.8	T200/T400	2.0/1.5	756X030013	757X030013
50/100:5	0.3 B1.8	T200/T400	2.0/1.5	756X030012	757X030012
75/150:5	0.3 B1.8	T200/T400	2.0/1.5	756X030011	757X030011
100/200:5	0.3 B1.8	T200/T400	2.0/1.5	756X030010	757X030010
150/300:5	0.3 B1.8	T200/T400	2.0/1.5	756X030009	757X030009
200/400:5	0.3 B1.8	T200/T400	2.0/1.5	756X030008	757X030008
300/600:5	0.3 B1.8	T200/T400	2.0/1.5	756X030007	757X030007
400/800:5	0.3 B1.8	T200/T400	2.0/1.5	756X030006	757X030006
500/1000:5	0.3 B1.8	T200/T400	2.0/1.5	756X030005	757X030005
600/1200:5	0.3 B1.8	T200/T400	2.0/1.5	756X030004	757X030004
800/1600:5	0.3 B1.8	T200/T400	2.0/1.5	756X030003	757X030003
1000/2000:5	0.3 B1.8	T200/T400	2.0/1.5	756X030002	757X030002
1500/3000:5	0.3 B1.8	T400/T800	1.5/1.33	756X030001	757X030001

Note

Ⓞ First number given is for lower primary Ampere rating (tapped secondary); second number is for higher primary Ampere rating (full secondary)
 Single ratios available, contact factory

Model JKW-250 & JKW-350
46kV to 69kV, 250kV to 350kV BIL, 25-3000A



JKW-350 Shown



Application
 Designed for outdoor service; suitable for operating meters, relays and control devices.

IEEE Meter Accuracy Class, 60 Hz
 B0.1 through B1.8; all models - 0.3
 Contact factory for 0.15, 0.15S, and extended range options.

One-Second Thermal Overcurrent Capability
 All models 75 x normal

Two-cycle Mechanical Capability
 Low ratio; minimum 170 x normal
 High ratio; minimum 85 x normal

Weight - Shipping/Net
 (approximate, in pounds)
 Transformer, JKW-250 633/543
 Transformer, JKW-350 683/593

INSULATION
 Super-Bute

FREQUENCY
 50-60 Hz



JKW-250 & JKW-350 DATA TABLE

Current Ratio (Amps) Pri : Sec	IEEE Accuracy Class 60 Hz Burden		Continuous Thermal Current Rating Factor@ 30° C Amb. Ⓞ	Catalog Number	
	Metering Class	Relay Class		JKW-250 46000 V BIL 250 kV	JKW-350 69000 V BIL 350 kV
25/50:5	0.3 B1.8	T200/T400	2.0/1.5	758X030013	759X030013
50/100:5	0.3 B1.8	T200/T400	2.0/1.5	758X030012	759X030012
75/150:5	0.3 B1.8	T200/T400	2.0/1.5	758X030011	759X030011
100/200:5	0.3 B1.8	T200/T400	2.0/1.5	758X030010	759X030010
150/300:5	0.3 B1.8	T200/T400	2.0/1.5	758X030009	759X030009
200/400:5	0.3 B1.8	T200/T400	2.0/1.5	758X030008	759X030008
300/600:5	0.3 B1.8	T200/T400	2.0/1.5	758X030007	759X030007
400/800:5	0.3 B1.8	T200/T400	2.0/1.5	758X030006	759X030006
500/1000:5	0.3 B1.8	T200/T400	2.0/1.5	758X030005	759X030005
600/1200:5	0.3 B1.8	T200/T400	2.0/1.5	758X030004	759X030004
800/1600:5	0.3 B1.8	T200/T400	2.0/1.5	758X030003	759X030003
1000/2000:5	0.3 B1.8	T200/T400	2.0/1.5	758X030002	759X030002
1500/3000:5	0.3 B1.8	T400/T800	1.5/1.33	758X030001	759X030001

Note

Ⓞ First number given is for lower primary Ampere rating (tapped secondary); second number is for higher primary Ampere rating (full secondary)
 Single ratios available, contact factory

5kV Thru 69kV Voltage Transformers (Outdoor)

Models JVV-3 60kV BIL, 2400-4800V

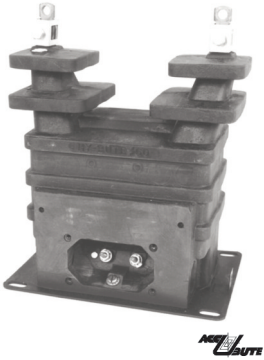

APPLICATION
Designed for outdoor service; suitable for operating meters, instruments, relays, and control devices.

THERMAL RATING (VOLT-AMPERES)
750VA @ 30°C Ambient

DIMENSIONS/WEIGHT
Height: 12.75"
Width: 10.50"
Length: 7.56"

Weight - Shipping/Net
(approximate, in pounds)
Transformer48/44

Accessories Catalog Number
Mounting Hardware
"L" Mounting Brackets8944634001
Auxiliary "L" Mounting Brackets 8944270
Suspension Hooks 8944630
Channel Bracket 5466227001
Secondary Conduit Box9689897001

INSULATION
Hy-Bute-60

FREQUENCY
50/60Hz

JVV-3 DATA TABLE

Line-To-Line Circuit Voltage For Permissible Primary Connection			Transformer Rating ❶		IEEE Accuracy Class 60 Hz Burden		Catalog Number
Δ	Y	Y Only	Primary Voltage	Ratio	Operated at Rated Voltage	Operated at 58% of Rated Voltage ❷	
2400	2400	4160	2400	20:1	0.3 W,X,M,Y	0.3 W,X	763X030001
4200	4200	---	4200	35:1	0.3 W,X,M,Y	0.3 W,X	763X030002
4800	4800	---	4800	40:1	0.3 W,X,M,Y	0.3 W,X	763X030003

Notes:
 ❶ For continuous operation, the transformer-rated primary voltage should not be exceeded by more than 10%. Under emergency conditions, over-voltage must be limited to 1.25 times the transformer primary-voltage rating.
 ❷ Applies to transformers connected Y-Y on a circuit in which the line-to-line voltage is the same as the transformer-rated primary voltage. In each case, the transformer is operated with reduced voltage and reduced excitation (58% of normal). In determining the accuracy classification under such conditions, the Volt-Ampere rating of the burden is maintained constant, regardless of the transformer secondary voltage.

5kV Thru 69kV Voltage Transformers (Outdoor)

Models JVW-4 & JVW-5 75kV to 110kV BIL, 2400-14400V



APPLICATION
Designed for outdoor service; suitable for operating meters, instruments, relays, and control devices.

THERMAL RATING (VOLT-AMPERES)
1500VA @ 30°C Ambient

ANSI Meter Accuracy Classification, 60 Hz

DIMENSIONS/WEIGHT
Height: 16.88"
Width: 14.25"
Length: 13.19"

Weight - Shipping/Net
(approximate, in pounds)
Transformer120/105

Accessories Catalog Number
Mounting Hardware
"L" Mounting Brackets8944634002
Channel Bracket 5466227001
Suspension Hooks 8944630001
Secondary Conduit Box9689897001

INSULATION
Hy-Bute-60

FREQUENCY
60Hz

JVW-4 & JVW-5 DATA TABLE

Line-To-Line Circuit Voltage For Permissible Primary Connection				Transformer Rating ①		IEEE Accuracy Class 60 Hz Burden		Catalog Number		
								JVW-4	JVW-5	
Δ	Y	Y Only	GY Only ④	Primary Voltage	Ratio	Operated at Rated Voltage	Operated at 58% of Rated Voltage ②	BIL 75 kV	BIL 110 kV	
								Two Bushing	Single Bushing	Two Bushing
2400	2400	4160	---	2400	20:1	0.3 W,X,M,Y,Z	0.3 W,X,M,Y,Z	764X030011	---	---
4200	4200	7280	---	4200	35:1	0.3 W,X,M,Y,Z	0.3 W,X,M,Y,Z	764X030012	---	---
4800	4800	8320	---	4800	40:1	0.3 W,X,M,Y,Z	0.3 W,X,M,Y,Z	764X030013	---	---
7200	7200	---	---	7200	60:1	0.3 W,X,M,Y,Z	0.3 W,X,M,Y,Z	764X030014	---	---
---	---	---	7200 ⑤	7200	60:1	0.3 W,X,M,Y,Z	0.3 W,X,M,Y,Z	---	765X030051	765X030042
---	---	---	8400 ⑥	8400	70:1	0.3 W,X,M,Y,Z	0.3 W,X,M,Y,Z	---	765X030052	765X030044
12000	12000	12000	---	12000	100:1	0.3 W,X,M,Y,Z	0.3 W,X,M,Y,Z	---	---	765X030045
14400	14400	14400	---	14400	120:1	0.3 W,X,M,Y,Z	0.3 W,X,M,Y,Z	---	---	765X030046

- Notes:**
- ① For continuous operation, the transformer-rated primary voltage should not be exceeded by more than 10%. Under emergency conditions, over-voltage must be limited to 1.25 times the transformer primary-voltage rating for two-bushing models, and 1.40 times the rating for single-bushing models.
 - ② Applies to transformers connected Y-Y on a circuit in which the line-to-line voltage is the same as the transformer-rated primary voltage. In each case, the transformer is operated with reduced voltage and reduced excitation (58% of normal). In determining the accuracy classification under such conditions, the Volt-Ampere rating of the burden is maintained constant, regardless of the transformer secondary voltage.
 - ④ Single-bushing design with removable grounding strap.
 - ⑤ 12,470 in Y configuration.
 - ⑥ 14,560 in Y configuration.

Models JVW-110 110kV BIL, 7200-14400V



APPLICATION
Designed for outdoor service; the Type JVW-110 is a metering voltage transformer specifically designed to meet the requirements of 15 kV outdoor metering applications.

THERMAL RATING (VOLT-AMPERES)
750VA @ 30°C Ambient

DIMENSIONS/WEIGHT
Height: 16.88"
Width: 14.50"
Length: 13.19"

Weight - Shipping/Net
(approximate, in pounds)
Transformer120/105

Accessories Catalog Number
Mounting Hardware
"L" Mounting Brackets8944634002
Channel Bracket 5466227001
Suspension Hooks 8944630001
Secondary Conduit Box9689897001

INSULATION
Hy-Bute-60

FREQUENCY
60Hz

JVW-110 DATA TABLE

Line-To-Line Circuit Voltage For Permissible Primary Connection				Transformer Rating ①		IEEE Accuracy Class 60 Hz Burden		Catalog Number	
								Single Bushing	Two Bushing
Δ	Y	Y Only	GY Only ④	Primary Voltage	Ratio	Operated at Rated Voltage	Operated at 58% of Rated Voltage ②	Single Bushing	Two Bushing
---	---	---	7200 ⑤	7200	60:1	0.3 W,X,M,Y	0.3 W,X,M,Y	765X031115	765X031111
---	---	---	8400 ⑥	8400	70:1	0.3 W,X,M,Y	0.3 W,X,M,Y	765X031116	765X031112
12000	12000	12000	---	12000	100:1	0.3 W,X,M,Y	0.3 W,X,M,Y	---	765X031113
14400	14400	14400	---	14400	120:1	0.3 W,X,M,Y	0.3 W,X,M,Y	---	765X031114

- Notes:**
- ① For continuous operation, the transformer-rated primary voltage should not be exceeded by more than 10%. Under emergency conditions, over-voltage must be limited to 1.25 times the transformer primary-voltage rating for two-bushing models, and 1.40 times the rating for single-bushing models.
 - ② Applies to transformers connected Y-Y on a circuit in which the line-to-line voltage is the same as the transformer-rated primary voltage. In each case, the transformer is operated with reduced voltage and reduced excitation (58% of normal). In determining the accuracy classification under such conditions, the Volt-Ampere rating of the burden is maintained constant, regardless of the transformer secondary voltage.
 - ④ Single-bushing design with removable grounding strap.
 - ⑤ 12,470 in Y configuration.
 - ⑥ 14,560 in Y configuration.

5kV Thru 69kV Voltage Transformers (Outdoor)

Models JVW-110C 110kV BIL, 7200-14400V



APPLICATION
Designed for outdoor service; suitable for operating meters, instruments, relays and control devices.

THERMAL RATING (VOLT-AMPERES)
1000VA @ 30°C Ambient

DIMENSIONS/WEIGHT
Height: 16.34"
Depth: 13.60"
Width: 11.50"
Weight (Approximate).....62 lbs

INSULATION LEVEL
15.5kV; BIL: 110kV per C57.13

INSULATION
HCEP

FREQUENCY
60Hz

JVW-110C DATA TABLE					
Rated Primary Voltage	Ratio	IEEE Accuracy Class	Rated Voltage Factor	Thermal Rating (VA @ 30° C. amb)	Catalog Number
		60 Hz Burden Metering Class			
Single Bushing Style					
7200/12470GY	60:1	0.3 W,X,M,Y	1.1	1000	765C131101
7620/13200GY	63.5:1	0.3 W,X,M,Y	1.1	1000	765C131102
8400/14560GY	70:1	0.3 W,X,M,Y	1.1	1000	765C131103
Double Bushing Style					
7200/12470Y	60:1	0.3 W,X,M,Y	1.1	1000	765C131201
7620/13200Y	63.5:1	0.3 W,X,M,Y	1.1	1000	765C131202
8400/14560Y	70:1	0.3 W,X,M,Y	1.1	1000	765C131203
12000/12000Y	100:1	0.3 W,X,M,Y	1.1	1000	765C131204
13200/13200Y	110:1	0.3 W,X,M,Y	1.1	1000	765C131205
14400/14400Y	120:1	0.3 W,X,M,Y	1.1	1000	765C131206

Models JVW-5C 110kV BIL, 7200-14400V



APPLICATION
Designed for outdoor service; suitable for operating meters, instruments, relays and control devices.

THERMAL RATING (VOLT-AMPERES)
1500VA @ 30°C Ambient

DIMENSIONS/WEIGHT
Height: 15.65"
Depth: 13.36"
Width: 11.50"
Weight (Approximate).....80 lbs

INSULATION LEVEL
15.5kV; BIL: 110kV per C57.13

INSULATION
HCEP

FREQUENCY
60Hz

JVW-5C DATA TABLE					
Rated Primary Voltage	Ratio	IEEE Accuracy Class	Rated Voltage Factor	Thermal Rating (VA @ 30° C. amb)	Catalog Number
		60 Hz Burden Metering Class			
Single Bushing Style					
7200/12470GY	60:1	0.3 W,X,M,Y,Z	1.1	1500	765C130101
7620/13200GY	63.5:1	0.3 W,X,M,Y,Z	1.1	1500	765C130102
8400/14560GY	70:1	0.3 W,X,M,Y,Z	1.1	1500	765C130103
12000/12000Y	100:1	0.3 W,X,M,Y,Z	1.1	1500	765C130104
13200/13200Y	110:1	0.3 W,X,M,Y,Z	1.1	1500	765C130105
14400/14400Y	120:1	0.3 W,X,M,Y,Z	1.1	1500	765C130106
Double Bushing Style					
7200/12470Y	60:1	0.3 W,X,M,Y,Z	1.1	1500	765C130201
7620/13200Y	63.5:1	0.3 W,X,M,Y,Z	1.1	1500	765C130202
8400/14560Y	70:1	0.3 W,X,M,Y,Z	1.1	1500	765C130203
12000/12000Y	100:1	0.3 W,X,M,Y,Z	1.1	1500	765C130204
13200/13200Y	110:1	0.3 W,X,M,Y,Z	1.1	1500	765C130205
14400/14400Y	120:1	0.3 W,X,M,Y,Z	1.1	1500	765C130206

5kV Thru 69kV Voltage Transformers (Outdoor)

Models JVV-4A/JVV-5A High Accuracy 75-110kV BIL



APPLICATION
Designed for outdoor service; suitable for operating meters, instruments, relays, and control devices. These transformers have 0.15 accuracy when operated within ±10 percent of rated voltage within their burden capability.

THERMAL RATING (VOLT-AMPERES)
2000VA @ 30°C Ambient

DIMENSIONS/WEIGHT
Height: 16.88"
Width: 14.25"
Length: 13.19"
Weight (Approximate).....120/105 lbs

INSULATION LEVEL
15.5kV; BIL: 110kV per C57.13

INSULATION
Hy-Bute-60

FREQUENCY
60Hz



JVV-4A/JVV-5A DATA TABLE								
Line-To-Line Circuit Voltage For Permissible Primary Connection		IEEE Accuracy Class 60 Hz Burden	Transformer Rating ¹		Catalog Number			
					JVV-4A		JVV-5A	
					BIL 75kV		BIL 110kV	
Δ	Y	Y Only	Metering Class	Primary Voltage	Ratio	Single-Bushing Model	Single-Bushing Model	Two-Bushing Model
2400	2400	4160	0.15 W,X,M,Y	2400	20:1	764X031011	--	--
4200	4200	7280	0.15 W,X,M,Y	4200	35:1	764X031012	--	--
4800	4800	8320	0.15 W,X,M,Y	4800	40:1	764X031013	--	765X032041
7200	7200	--	0.15 W,X,M,Y	7200	60:1	764X031014	--	--
7200	7200	12470	0.15 W,X,M,Y	7200	60:1	--	765X032051	765X032042
7620	7620	13200	0.15 W,X,M,Y	7620	63.5:1	--	--	765X032043
8400	8400	14550	0.15 W,X,M,Y	8400	70:1	--	765X032052	765X032044
--	--	12000	0.15 W,X,M,Y	12000	100:1	--	--	765X032045
14400	14400	14400	0.15 W,X,M,Y	--	120:1	--	--	765X032046

Note

¹ For continuous operation, the transformer-rated primary voltage should not be exceeded by more than 10%. Under emergency conditions, over-voltage must be limited to 1.25 times the transformer primary-voltage rating for two-bushing models, and 1.40 times the rating for single-bushing models.

Models JVV-5AC High Accuracy 110kV BIL, 7200-14400V



APPLICATION
Designed for outdoor service; suitable for operating meters, instruments, relays and control devices.

THERMAL RATING (VOLT-AMPERES)
1500VA @ 30°C Ambient

DIMENSIONS/WEIGHT
Height: 15.65"
Depth: 13.36"
Width: 11.50"
Weight (Approximate).....80 lbs

INSULATION LEVEL
15.5kV; BIL: 110kV per C57.13

INSULATION
HCEP

FREQUENCY
60Hz

JVV-5AC DATA TABLE					
Rated Primary Voltage	Ratio	IEEE Accuracy Class 60 Hz Burden	Rated Voltage Factor	Thermal Rating (VA @ 30° C. amb)	Catalog Number
		Metering Class			
Single Bushing Style					
7200/12470GY	60:1	0.15 W,X,M,Y	1.1	1500	765C132101
7620/13200GY	63.5:1	0.15 W,X,M,Y	1.1	1500	765C132102
8400/14560GY	70:1	0.15 W,X,M,Y	1.1	1500	765C132103
12000/12000Y	100:1	0.15 W,X,M,Y	1.1	1500	765C132104
13200/13200Y	110:1	0.15 W,X,M,Y	1.1	1500	765C132105
14400/14400Y	120:1	0.15 W,X,M,Y	1.1	1500	765C132106
Double Bushing Style					
7200/12470Y	60:1	0.15 W,X,M,Y	1.1	1500	765C132201
7620/13200Y	63.5:1	0.15 W,X,M,Y	1.1	1500	765C132202
8400/14560Y	70:1	0.15 W,X,M,Y	1.1	1500	765C132203
12000/12000Y	100:1	0.15 W,X,M,Y	1.1	1500	765C132204
13200/13200Y	110:1	0.15 W,X,M,Y	1.1	1500	765C132205
14400/14400Y	120:1	0.15 W,X,M,Y	1.1	1500	765C132206

Models JVV-6 125-150kV BIL, 12000-24000V



APPLICATION
Designed for outdoor service; the Type JVV-6 is a metering voltage transformer specifically designed to meet the requirements of 25 kV outdoor metering applications.

THERMAL RATING (VOLT-AMPERES)
55°C Rise above 30°C Ambient 750

DIMENSIONS/WEIGHT
Height: 18.25"
Width: 14.50"
Length: 13.19"

Weight - Shipping/Net
(approximate, in pounds)
Transformer120/105

Accessories Catalog Number
Mounting Hardware:
"L" Mounting Brackets 8944634002
Channel Bracket 5466227001
Suspension Hooks 8944630001
Secondary Conduit Box 9689897001

INSULATION
Hy-Bute-60

FREQUENCY
60Hz



JVV-6 DATA TABLE				
Transformer Rating		IEEE Accuracy Class 60 Hz Burden	Catalog Number	
Rated Primary Voltage	Ratio		125kV BIL	150kV BIL
Single Bushing Style¹				
12000/20780GY	100:1	0.3 W, X, M, Y	766X031001	766X035001
14400/24940GY	120:1	0.3 W, X, M, Y	766X031002	766X035002
Double Bushing Style²				
12000/20780Y	100:1	0.3 W, X, M, Y	766X031708	--
14400/24940Y	120:1	0.3 W, X, M, Y	766X031006	--
18000/18000Y	150:1	0.3 W, X, M, Y	766X031003	--
24000/24000Y	200:1	0.3 W, X, M, Y	766X031004	--
Double Bushing, Dual Ratio				
14400/24940Y ³	60/120:1	0.3Y / 0.3M	766X031013	--

Notes:

- Single bushing transformers are suitable for application to grounded systems, for operation line-to-ground only. They will operate without damage connected line-to-ground at 1.40 times the transformer-rated voltage for one minute. If it should become necessary to apply these grounded wye voltage transformers to an ungrounded system, refer to the nearest General Electric Sales Office for a system analysis study.
- Double bushing transformers are designed for operation line-to-line. They may also be operated line-to-ground or line-to-neutral at reduced voltage (58% of rated voltage). Contact GE for accuracy rating detail at 58% of rated voltage.
- Can operate as 14400/24940Y when using full secondary or 7200/12470Y when using tap

5kV Thru 69kV Voltage Transformers (Outdoor)

Models JVV-150 150kV BIL, 12000-24000V



APPLICATION

Designed for outdoor service; the Type JVV-150 is a metering voltage transformer specifically designed to meet the requirements of 25 kV outdoor metering applications.

THERMAL RATING (VOLT-AMPERES)

55°C Rise above 30°C Ambient 750

DIMENSIONS/WEIGHT

Height: 19.00"
Width: 14.88"
Length: 17.88"

Weight - Shipping/Net

(approximate, in pounds)
Transformer 155/140

Accessories Catalog Number

Mounting Hardware:
"L" Mounting Brackets 8944634002
Channel Bracket 5466227001
Suspension Hooks 8944630001
Secondary Conduit Box 9689970001

INSULATION

Hy-Bute-60

FREQUENCY

60Hz

JVV-150 DATA TABLE

Line-To-Line Circuit Voltage For Permissible Primary Connection				Transformer Rating ①		IEEE Accuracy Class 60 Hz Burden		Catalog Number
Δ	Y	Y Only	GY Only ②	Primary Voltage	Ratio	Operated at Rated Voltage	Operated at 58% of Rated Voltage	Two Bushing
---	---	---	12000 ③	12000	100:1	0.3 W,X,M,Y	0.3 W,X; 1.2 M,Y	---
---	---	---	14400 ③	14400	120:1	0.3 W,X,M,Y	0.3 W,X; 1.2 M,Y	766X034006
18000 ④	18000 ④	18000 ④	---	18000	150:1	0.3 W,X,M,Y	0.3 W,X; 1.2 M,Y	766X034003
24000 ④	24000 ④	24000 ④	---	24000	200:1	0.3 W,X,M,Y	0.3 W,X; 1.2 M,Y	766X034004

Notes:

① These single bushing transformers are suitable for application to grounded systems, for operation line-to-ground only. They will operate without damage connected line-to-ground at 1.40 times the transformer-rated voltage for one minute. If it should become necessary to apply these grounded wye voltage transformers to an ungrounded system, refer to the nearest General Electric Sales Office for a system analysis study.

② These two-bushing transformers are designed for operation line-to-line. They may also be operated line-to-ground or line-to-neutral at reduced voltage (58% of rated voltage).

③ 20,780 in Y configuration.

④ 24,940 in Y configuration.

Models JVV-7 150-200kV BIL, 20125-34500V



APPLICATION

Designed for outdoor service; the Type JVV-7 is a metering voltage transformer specifically designed to meet the requirements of outdoor metering applications.

THERMAL RATING (VOLT-AMPERES)

750VA @ 30°C Ambient

DIMENSIONS/WEIGHT

Height: 19.00"
Width: 14.88"
Length: 17.88"

Weight - Shipping/Net

(approximate, in pounds)
Transformer 155/140

Accessories Catalog Number

Mounting Hardware:
"L" Mounting Brackets 8944634002
Channel Bracket 5466227001
Suspension Hooks 8944630001
Secondary Conduit Box 9689970001

INSULATION

Hy-Bute-60

FREQUENCY

60Hz

JVV-7 DATA TABLE

Line-To-Line Circuit Voltage For Permissible Primary Connection				Transformer Rating ①		IEEE Accuracy Class 60 Hz Burden		Catalog Number	
Δ	Y	Y Only	GY Only ②	Primary Voltage	Ratio	BIL (kV)	Operated at Rated Voltage	Operated at 58% of Rated Voltage	Two Bushing
Single Bushing									
---	---	---	34500	20125	175:1	200	0.3 W,X,M,Y	---	767X031001
---	---	---	34500	20125	175/300:1	200	0.3 W,X,M,Y	---	767X031011
---	---	---	34500	20125	175 & 300:1	200	0.3 W,X,M,Y	---	767X031012
Two Bushing									
27600 ④	27600 ④	---	---	27600	240:1	150	0.3 W,X,M,Y	0.3 W,X; 1.2 M,Y	767X031002
34500 ④	34500 ④	---	---	34500	300:1	150	0.3 W,X,M,Y	0.3 W,X; 1.2 M,Y	767X031003
23000 ④	23000 ④	---	---	23000	200:1	150	0.3 W,X,M,Y	0.3 W,X; 1.2 M,Y	767X031004
27600 ④	27600 ④	---	---	27600	240 & 240:1	150	0.3 W,X,M,Y	0.3 W,X; 1.2 M,Y	767X031005
34500 ④	34500 ④	---	---	34500	300 & 300:1	150	0.3 W,X,M,Y	0.3 W,X; 1.2 M,Y	767X031006
23000 ④	23000 ④	---	---	23000	200 & 200:1	150	0.3 W,X,M,Y	0.3 W,X; 1.2 M,Y	767X031007

Notes:

① These single bushing transformers are suitable for application to grounded systems, for operation line-to-ground only. They will operate without damage connected line-to-ground at 1.40 times the transformer-rated voltage for one minute. If it should become necessary to apply these grounded wye voltage transformers to an ungrounded system, refer to the nearest General Electric Sales Office for a system analysis study.

② These two-bushing transformers are designed for operation line-to-line. They may also be operated line-to-ground or line-to-neutral at reduced voltage (58% of rated voltage).

5kV Thru 69kV Voltage Transformers (Outdoor)

Models JVS & JVT 150-350kV BIL, 24000-69000V



JVS-200



APPLICATION
Designed for outdoor service; suitable for operating meters, relays, and control devices.

Dimensions & Outline
Superbute™ units are up to 30% lower profile than oil-filled designs, yet even with less height, units come standard with creepage distance which exceeds leading oil-filled designs. This allows standard units to be used in environmentally severe and high altitude applications (10,000ft).

BIL (kV).....Superbute Creepage™ Distance
150 26"
200 35"
250 48"
350 64"

Contact factory for outline drawings.

INSULATION
Super-Bute

FREQUENCY
60Hz



JVT-350



JVS-350



JVS & JVT DATA TABLE

Model	BIL (kV)	Rated Primary Voltage	Nominal System Voltage	Ratio (Pri:Sec)	Thermal Rating 30°C Amb.	Approx. Weight (lb.)	IEEE Accuracy Class ⁵ 60Hz	Catalog Number ⁶
						(Ship/Net)		
Single Bushing, JVS (for line-to-ground connection, only) ¹								
JVS-150	150	14400	24000	120/200 & 120/200:1	3000VA	270/230	0.3 ZZ	766x030002
JVS-200	200	20125	34500	175/300 & 175/300:1	3000VA	280/240	0.3 ZZ	767x030002
JVS-250	250	27600	46000	240/400 & 240/400:1	5000VA ³	480/420	0.3 ZZ	768x030002
JVS-350	350	40250	69000	350/600 & 350/600:1	5000VA ³	490/430	0.3 ZZ	769x030002
Two Bushing, JVT (for line-to-line connection) ²								
JVT-150	150	24000	24000	200 & 200:1	3000VA ⁴	265/225	0.3 ZZ	766x030001
JVT-200	200	34500	34500	300 & 300:1	3000VA ⁴	275/235	0.3 ZZ	767x030001
JVT-250	250	46000	46000	400:1	4500VA	580/520	0.3 ZZ	768x030001
JVT-350	350	69000	69000	600:1	4500VA	620/560	0.3 ZZ	769x030001

Notes:

- (1) Designed for operation line-to-ground only, on grounded systems. If it should become necessary to apply to systems which are ungrounded or provided through high impedance, contact GE for analysis. These voltage transformers are capable of operating at 173% of rated voltage for one minute without exceeding 175degC temperature rise.
- (2) Designed for operation line-to-line. May also be operated line-to-ground or line-to-neutral at reduced voltage (58% of rated voltage). Contact GE for reduced voltage accuracy rating.
- (3) To achieve 5000VA when using a 67.08 volt tap, loading must not exceed 3000VA on the 67.08 volt tap. If all load is on one 67.08 volt tap, thermal rating is 4000VA.
- (4) With both secondary windings in parallel. When windings are used separately, the rating is 1500VA per winding. If only one winding is used separately, the rating is 2000VA.
- (5) High Accuracy class (0.15) available, contact factory.
- (6) Other ratios available, contact factory.

Overhead Primary Metering Assembly



APPLICATION
Designed for outdoor service for three phase, pole mounted, primary metering

INSULATION
Dry Type, Hydrophobic Cycloaliphatic Epoxy (HCEP) or Hy-Bute-60
60kV – 200 kV BIL available

FREQUENCY
60Hz

CONFIGURATIONS
Three-phase, Four-wire
3 CT & 3 VT
3 CT & 2 VT
Three-phase, Three-wire
2 CT & 2 VT
Single-phase
1 CT & 1VT

OVERHEAD PRIMARY METERING TABLE

OPMA Rating	VT Types Available	CT Types Available
5	JVV-3/JVV-4	JCK-3/JCK-4/JKW-3/JKW-4
15	JVV-110/JVV-110C/JVV-5/JVV-5C	JCK-5/JCK-5C/JKW-5/JKW-5C
25	JVV-6/JVV-150	JKW-6
34.5	JVV-7	JKW-7

Contact factory for more information
High Accuracy options available upon request

Series RT Rack Mounted Test Switches

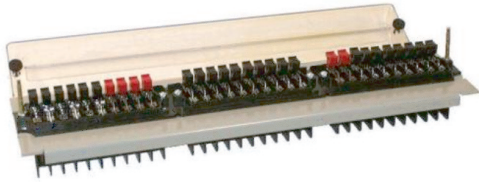

Up to three Series FT switches mounted on various size 19" wide panels. Individual & single clear/black cover options. Panels available in choice of colors and materials, typically rack mounted in relay panels. UL & cUL listed.

For more information on Accessories see details at www.GEGridSolutions.com/iti

Series FT Test Switches & Test Plugs

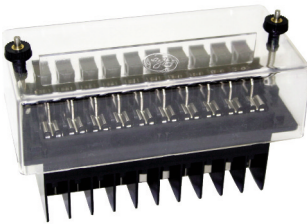

An industry standard for CT & VT isolation for instrument transformer and connected device testing.

Up to 10 poles; Numerous configurations available.

Typically mounted on switchgear and relay panels.

10 pole test plug available

UL and cUL listed

Rated 600 volts and 30 amps continuous.

Clear & black cover options

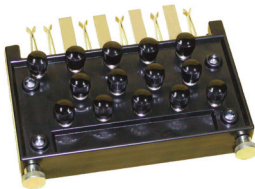

Refer to Online Switch Configurator www.GEGridSolutions.com/iti (Configure A FT Switch)

Accessories

SB Control & Transfer Switches

SB Control and Transfer Switches

Compact, positive acting switches for control and transfer service on panels and switchboards.
600 VAC, 20A (250 A fro 3.5)
Compact design
Rotary operation
Lateral push/pull operation available
Select panel thickness
Select number of stages
UL & cUL recognized

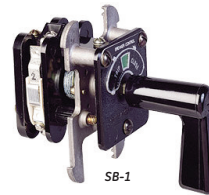

SB-1

Control of electrically operated circuit breakers, valves, motors etc...
Transfer current and potential to instruments and relays
Standard mounts on panels up to 3/16" (up to 2" available)
Up to 16 stages (32 contacts)
Tandem mechanisms available
Silver to silver positive wiping action contracts
Palladium contacts for low level instrument circuits available
Up to 12 positions, 360° rotation
Maintained or spring return action

SB-9

Power plants, steel mills, petroleum/chemical plants, heavy industries
Repetitive positive positioning operation (thousands/week)
More positive positioning than SB-1
Better insulation to ground than SB-1
More substantial bearings than SB-1
Control of electrically operated circuit breakers, valves, motors, etc.
Transfer current and potential to instrument relays
Lateral action eliminates second separate switch

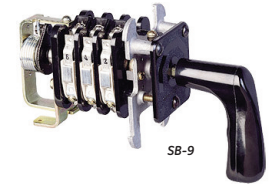

SB-10

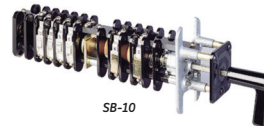

Control of electrically operated circuit breakers, valves, motors, etc.
Transfer current and potential to instrument relays
Lateral action eliminates second separate switch
2 electrically separate & mechanically independent switches in one device
Up to 12 stages (24 contacts) of rotary contacts (includes lateral and rotary)
Up to 4 stages (8 contacts) of lateral contacts (in-out action)
Lateral action interlock with rotary position available
Tandem mechanisms available

SBM

Limited space applications
Control of electrically operated circuit breakers, valves, motors, etc.
Transfer current and potential to instrument relays

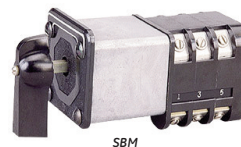

Standard mounts on panels up to 3/4" (up to 1.5" available)
Up to 10 stages (20 contacts)
Double surface cams (one cam per contact)
Electrically separate and mechanically independent double-break contacts

Accessories

Series 95 Selector Switches & Lockout Relays

Heavy industrial construction
Rotary/ Double wiping knife blade design
600 VAC, 30 amp continuous
UL/ cUL recognized.

Typically used in low & medium voltage switchgear, MCC's, and relay and control panels. Now available with LED lighted escutcheon plates. Available with 1, 2, or 3 replaceable LEDs Flexibility for LEDs to be wired to any desired event Integrated LOR coil monitoring with LEDs and SCADA feedback eliminates the installation of indicating lamps – saving panel space LED indication of existing fault signal on LOR

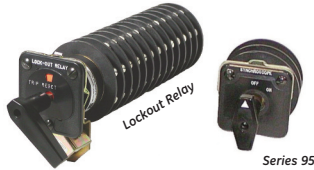

Multi Contact Auxiliary Relays

HSA Multi-contact Auxiliary
Multi-contact hand reset relay to perform auxiliary functions on AC and DC circuits
Contact multiplication
Trip and/or block close circuit breaker control
Electrically separate contact outputs available in 9, 13, or 19
Universal target dropping
Mechanical target
High seismic capability
600 VAC, 20A



HEA Multi-contact Auxiliary
Multi-contact hand reset relay to perform auxiliary functions on AC and DC circuits
Contact multiplication
Trip and/or block close circuit breaker control
Electrically separate contact outputs available in 6, 10, or 16
Locks equipment out of service
600 VAC, 20A

Accessories

ET-16/17 Indicating Lamps

The ET-16 (Incandescent) and ET-17 (Neon) indicating lamps are designed for application on switchboard panels up to and including 1/4-inch thickness. The lamps economize on space and permit easy replacement of bulb and resistor.

- Simple "push-twist" type plug
- GE extra-long-life bulbs
- Caps are available in various colors



ET-16 Light Emitting Diodes

The ET-16 Light Emitting Diodes (LED's) are designed for application on control panels up to and including a 1/4 inch thickness. This assembly economizes on space and permits ease of replacement for bulbs and resistors.



Capacitor Trip Devices

Provide a temporary source of energy for circuit breaker or switch trip coil operation during a loss of AC control power. Battery backup model available.



Open Circuit Protectors

Connect across CT secondary terminals to prevent inadvertent open circuit conditions. C100 to C800. Single and three element options available.

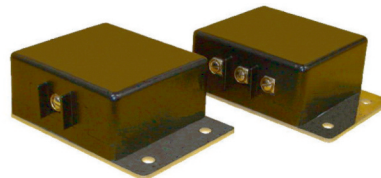

Accessories

EB-1/2/4 Terminal Boards



The EB-1 is a one piece molded terminal board, equipped with binding screws for circuit wire connections and a white marking strip for circuit identification. The EB-2 includes clamp (pressure) type connectors for circuit wire connections. Both the EB-1 and EB-2 will accommodate wires up to and including Number 4.

EB-25/26/27 Terminal Boards

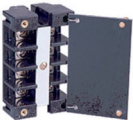

The EB-25, -26, and -27 terminal blocks are molded one piece design available in 4, 6, and 12 points and are furnished with washer-less head binding screws (#10-32) for circuit wire connections. The blocks are supplied with a black marking strip with white numbers on one side, and white unmarked on the reverse side for circuit identification.

IKU Terminal Blocks



Applications:
Control and power wire termination. Short circuiting versions for meter servicing, CT tap changing, etc.
Rating: 600 VAC, 50 A
Wire range: 18-10 AWG

DEFINITIONS AND FUNCTIONS

The name instrument transformer is a general classification applied to current and voltage devices used to change currents and voltages from one magnitude to another or to perform an isolating function, that is, to isolate (or insulate) the utilization current or voltage from the supply voltage for safety to both the operator and the end device in use. Instrument transformers are designed specifically for use with electrical equipment falling into the broad category of devices commonly called instruments such as voltmeters, ammeters, wattmeters, watt-hour meters, protection relays, etc.

Figure 1 below shows some of the most basic uses for instrument transformers. Voltage transformers are most commonly used to lower the high line voltages down to 120 volts on the secondary to be connected to a voltmeter, watt-hour meter, or protection relay. Similarly, current transformers take a high current and reduce it to 5 amps on the secondary winding so that it can be used with a watt-hour meter, ammeter, or protection relay.

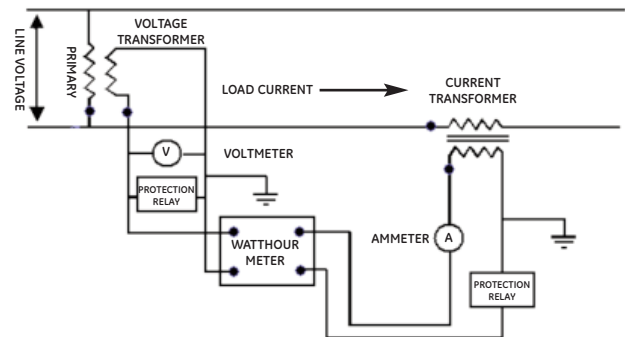
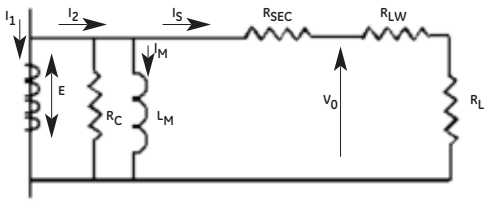

Figure 1

EQUIVALENT CIRCUIT



$I_2 = I_S + I_M$
 I_1 = Primary Current
 I_2 = Secondary Current for ideal transformer
 I_S = Secondary Current seen on transformer
 I_M = Magnetization Current
 E = Induced Electromotive Force
 V_0 = Secondary Voltage
 L_M = Magnetizing Inductance
 R_C = Core Loss
 R_{SEC} = Resistance of secondary
 R_{LW} = Resistance of lead wire
 R_L = Resistance of load

LEAD WIRE & RESISTANCE TABLE

Solid Conductors	
Size (AWG)	DC Resistance at 75 Degrees C (ohm/kFT)
18	7.77
16	4.89
14	3.07
12	1.93
10	1.21
8	0.764
Stranded Conductors	
Size (AWG)	DC Resistance at 75 Degrees C (ohm/kFT)
18	7.95
16	4.99
14	3.14
12	1.98
10	1.24
8	0.778
6	0.491
Insulated Conductors	
Size (THHN)	DC Resistance at 75 Degrees C (ohm/kFT)
14	0.111
12	0.13
10	0.164
8	0.216
6	0.254

CT SELECTION - WHAT TO KNOW BEFORE ORDERING

B	Burden	Load on the secondary side of the transformer (lead wire, meters etc.) See Burden table for different values
R	Ratio	Input/Output, Voltage or Current. Normal output values for CTs is 5 amps, and 120Vs for VTs. For multi ratio units a forward slash indicates the added ratio, for example: 1000/2000:5.
A	Accuracy	Measure of how closely the secondary output matches the primary input. % allowable variance from an ideal transformer (0.3, 0.6, 1.2%). Measurement for revenue requires a +/- 0.3% Accuracy. Standard Accuracy of 0.3 signifies 0.3% accuracy from 100% of rated current to the extended range of the rating factor and 0.6% accuracy down to 10% of rated current.
V	Voltage Class	Insulation Level of the CT (600V thru 35kV)
E	Etc. (Window Size, Mounting)	Misc. items such as window size, mounting brackets to be specified
R	Rating Factor	The amount by which the primary load current may be increased over its nameplate rating without exceeding the allowable temperature rise. Standard Rating Factors (RF) are 1.0, 1.33, 1.5, 2, 3, 4. Typical maximum temperature rise is 55 degrees C over a 30 degree C ambient temperature

INSTRUMENT TRANSFORMERS - RULES OF THUMB

- Never open circuit a current transformer secondary while the primary is energized.
- Never short circuit the secondary of an energized VT.
- Metering applications do not require a "C" class CT.
- CT secondary leads must be added to the CT burden.
- Never use a 60 Hz rated VT on a 50 Hz System.
- Exercise caution when connecting grounded VTs to ungrounded systems.

UTILITY CROSS REFERENCE GUIDE

VOLTAGE TRANSFORMERS INDOOR TYPE

Transformer Class	GE-ITI	ABB	ASSOCIATED	ASTRA	ITRON
1500 VA	JVM-5C	VIZ-11	N/A	N/A	N/A
750 VA	JVM-3C	VIV-60	N/A	N/A	N/A
750 VA	JVM-0C	N/A	N/A	DA	T7R
500 VA	JVA-0C	PPM	CL-707	DB	T6R
300 VA	JEV-0C	PPW	N/A	DF	T5R

VOLTAGE TRANSFORMERS OUTDOOR TYPE

Transformer Class	GE-ITI	ABB	AREVA / RITZ	KUHLMAN
15kv	JVW-5C, JVW-110C, JVW-5, JVW-110	VOZ-75, 11, 11M, VOY-11, VOG-11	VZF/VEF 15-10/20	PTT-110-977/8/G
25kv	JVW-6C, JVW-6	VOY, VOG-12	VZF/VEF 25-10	N/A
34.5kv	JVW-7C, JVW-7	VOY-15, 15G, VOHD200/G	VZF/VEF 36-10	PTT-150-979/G, PTT-200-9710/G

CURRENT TRANSFORMERS INDOOR TYPE

Transformer Class	GE-ITI	ABB	ASSOCIATED	ASTRA	ITRON
5 kv	JKM-3C, JKM-3	KIR-60	N/A	N/A	N/A
8.7 kv	JKM-4C, JKM-4	KIR-75	N/A	N/A	N/A
15 kv	JKM-5C, JKM-5	KIR-11	N/A	N/A	N/A
Miniature	JCR-0C	CSF	HA-678	TCW	R6SA
Miniature	JCW-0C	CSH	HA-781	TFW	R6S
Miniature - Bar	JCM-0C	CBT-H	N/A	TAB	R6B
Miniature - Bar	JCT-0C	CBT/1	N/A	TCB	R6BA
Intermediate	JAK-0C	CMF	WEO-601	AB	R6M
Large - Type I	JAD-0C	CLC/RLC	DEH-705	AD	R6L
Large Type II	JCD-0C	CLE	CEH-636	ACL	N/A
Pad Mount	JAB-0C	CMV	GM-713	AP	R6P
Large - Relay	JCP-0C	RLC	N/A	AD	N/A

CURRENT TRANSFORMERS OUTDOOR TYPE

Transformer Class	GE-ITI	ABB	AREVA / RITZ	KUHLMAN
15kv RF 1.5	JKW-5C, JKW-5	KOR-60, 75, 11	GIFU 15-01	BB-15-971
15kv RF 3.0	JCK-5C, JCK-5	KON-11	GIFU 15-01L	BB-15-972
25kv	JKW-6C, JKW-6	KOR-15C	GIFU 25-01	BB-25-973
34.5kv	JKW-7C, JKW-7	KOR-20	GIF/S 36-55	BB-34-975/6

KEY TO TYPE DESIGNATION

Low Voltage CT	Catalog Number
JAB-0C	750X136XXX
JAB-0C High Temp	750X236XXX
JAD-0C	750X120XXX
JAK-0C	750X133XXX
JCB-0CC	750X211XXX
JCD-0C	750X131XXX
JCM-0C/JCT-0C	750X125XXX/750X123XXX
JCP-0C	750X115XXX
JCR-0C/JCW-0C	750X134XXX/750X132XXX
JAH-0C	750X114XXX
JAI-0C	750X193XXX
JAU-0C	750X191XXX
JAR-0C	750X101XXX
JAS-0C	750X114XXX
JCA-0C	750X130XXX
JCS-0C	750X110XXX

Medium Voltage CT	Catalog Nbr	Medium Voltage CT - Accubute	Catalog Nbr
JKM-3C	753X140XXX	JCB-3A	753X023XXX
JKM-4C	754X140XXX	JCB-4A	754X023XXX
JKM-5C	755X142XXX	JCB-5A	755X023XXX
JKM-5AC	755X145XXX	JCD-3A	753X033XXX
JCK-3	753X051XXX	JCD-4A	754X033XXX
JCK-5C	755C152XXX	JCD-5A	755X033XXX
JKW-3	753X050XXX	JCM-3A	753X022XXX
JKW-5C	755C150XXX	JCM-4A	754X022XXX
JKW-6C	756C150XXX	JCM-5A	755X022XXX
JKW-7C	757C150XXX	JCW-3A	753X032XXX
JCB-3	753X021XXX	JCW-4A	754X032XXX
JCB-4	754X021XXX	JCW-5A	755X032XXX
JCB-5	755X021XXX	JKM-3A	753X042XXX
JCD-3	753X031XXX	JKM-4A	754X042XXX
JCD-4	754X031XXX	JKM-5A	755X045XXX
JCD-5	754X031XXX	JKW-150A	756X033XXX
JCM-2	752X020XXX	JKW-200A	757X033XXX
JKS-3	753X002XXX	JKW-250A	758X033XXX
JKS-5	755X001XXX	JKW-350A	759X033XXX
JKM-95	755X044XXX	JKW-3A	753X052XXX
JCM-3	753X020XXX	JKW-4A	754X052XXX
JCM-4	754X020XXX	JKW-5A	755X053XXX
JCM-5	755X020XXX	JKW-6A	756X051XXX
JCW-3	753X030XXX		
JCW-4	754X030XXX		
JCW-5	755X030XXX		
JCK-4	754X051XXX		
JKW-4	754X050XXX		
JKW-150	756X030XXX		
JKW-200	757X030XXX		
JKW-250	758X030XXX		
JKW-350	759X030XXX		

Low Voltage VT	Catalog Nbr
JVA-0C	760X134XXX
JEV-0C	760X235XXX
JE-27C	760X190XXX

Medium Voltage VT	Catalog Nbr	Medium Voltage VT - Accubute	Catalog Nbr
JVM-0C	760X133XXX	JVS-150A	766X033XXX
JVM-2C/JVM-3C	763X121XXX	JVT-200A	767X033XXX
JVM-4C/JVM-5C	764X121XXX/765X121XXX	JVT-250A	768X033XXX
JVW-110C	765C131XXX	JVT-350A	769X033XXX
JVW-5C	765C130XXX	JVW-4A	764X032XXX
JVW-6C	766C131XXX	JVW-5A	765X032XXX
JVW-7C	767C131XXX	JVW-6A	766X032XXX
JVM-95	765X022XXX	JVW-7A	767X032XXX
JVW-3	763X030XXX		
JVW-4	764X030XXX		
JVW-150	766X034XXX		
JVS/JVT-150	766X030XXX		
JVS/JVT-200	767X030XXX		
JVS/JVT-250	768X030XXX		
JVS/JVT-350	769X030XXX		

ITI equivalent part number: 750X133XXX
 Digit 1: 7 = Instrument Transformer
 Digit 2: 5 = Current Transformer, 6 = Voltage Transformer
 Digit 3: KV/BIL, 0 = 0.6/10, 3 = 5/60, 4 = 8.7/75, 5 = 15/110, 6 = 25/150, 7 = 35/200
 Digit 4-5: C1 = Clearwater, X1-X2 = Clearwater, X0 = Somersworth
 Digits 5-7: Model
 Digits 7-10: Individual Transformer

Accuracy Standards (IEEE C57.13)

IEEE Accuracy Standards for Voltage Transformers - For VT's with Rated Secondary Voltage Approx. 120 or 69.3 Volts

The method of classifying voltage transformers as to accuracy is as follows: Since the accuracy is dependent on the burden, standard burdens have been designated, and these are the burdens at which the accuracy is to be classified. The standard burdens have been chosen to cover the range normally encountered in service and are identified by the letters W, X, M, Y, Z, and ZZ as given in Table 1.

**Table 1
IEEE Standard Burdens*
for Voltage Transformers**

Burden	Volt-amperes at 120 or 69.3 Secondary Volts	Burden Power Factor
W	12.5	0.10
X	25.0	0.70
M	35.0	0.20
Y	75.0	0.85
Z	200.0	0.85
ZZ	400.0	0.85

* Burden designations have no significance except at 60 Hz.

It should be pointed out that the burden of any specific meter or instrument may approximate, but seldom is the same as, any one of the standard burdens. The standard burden serves merely as a standardized reference point at which the accuracy of the transformer may be stated. It should also be noted that each standard burden has the same VA at 120 or 69.3 secondary volts, and therefore has different impedances at the two voltages. The accuracy classes with their limits of ratio correction factor and transformer correction factor are given in Table 2.

**Table 2
IEEE Accuracy Classes
for Voltage Transformers**

Accuracy Class	Limits of Correction Factor and Transformer Correction Factor*		Limits of Power Factor (Lagging) of Metered Power Load
	Minimum	Maximum	
0.3	0.997	1.003	0.6-1.0
0.6	0.994	1.006	0.6-1.0
1.2	0.988	1.012	0.6-1.0

* The limits given for each accuracy class apply from 10 percent above rated voltage to 10 percent below rated voltage, at rated frequency, and from no burden on the voltage transformer to the specified burden, maintaining the power factor of the specified burden.

IEEE Metering Accuracy Standards for Current Transformers- For CT's with Rated Secondary Current of 5 Amperes

The method of classifying current transformers as to accuracy is as follows: Since the accuracy is dependent upon the burden, standard burdens have been designated. These are the burdens at which the accuracies are to be classified. The standard burdens have been chosen to cover the range normally encountered in service and are designated as B-0.1, B-0.2, etc. as given in Table 3.

**Table 3
IEEE Standard Burdens*
for Current Transformers with 5 Ampere Secondaries**

Burden	Volt-amperes (at 5 Amp)	Power Factor	Resistance (Ohms)	Inductance (Milli-henrys)	Impedance (Ohms)
B0.1	2.5	0.9	0.09	0.116	0.1
B0.2	5.0	0.9	0.18	0.232	0.2
B0.5	12.5	0.9	0.45	0.580	0.5
B0.9	22.5	0.9	0.81	1.04	0.9
B1.8	45.0	0.9	1.62	2.08	1.8
B-1	25.0	0.5	0.5	2.3	1.0
B-2	50.0	0.5	1.0	4.6	2.0
B-4	100.0	0.5	2.0	9.2	4.0
B-8	200.0	0.5	4.0	18.4	8.0

* Burden designations have no significance except at 60 Hz.

It should be pointed out that the burden of any specific meter or instrument may approximate, but seldom is the same as, any one of the standard burdens. The standard burden serves merely as a standardized reference point at which the accuracy of the transformer may be stated. The accuracy classes with their limits of ratio correction factor and transformer correction factor are given in Table 4.

**Table 4
IEEE Metering Accuracy Classes
for Current Transformers**

Accuracy Class	Limits of Ratio Correction Factor and Transformer Correction Factor				Limits of Power Factor (Lagging) of Metered Power Load
	100% Rated Current*		10% Rated Current		
	Minimum	Maximum	Minimum	Maximum	
0.3	0.997	1.003	0.994	1.006	0.6-1.0
0.6	0.994	1.006	0.988	1.012	0.6-1.0
1.2	0.988	1.012	0.976	1.024	0.6-1.0

* These limits also apply at the maximum continuous-thermal current, which is the product of rated current and the continuous-thermal-current rating factor.

Consult Factory for Questions Concerning
IEC & Other Standards

CT & PT PARALLELOGRAM'S

IEEE Std. C57.13 limits of accuracy class for current transformers for metering 0.3 accuracy class

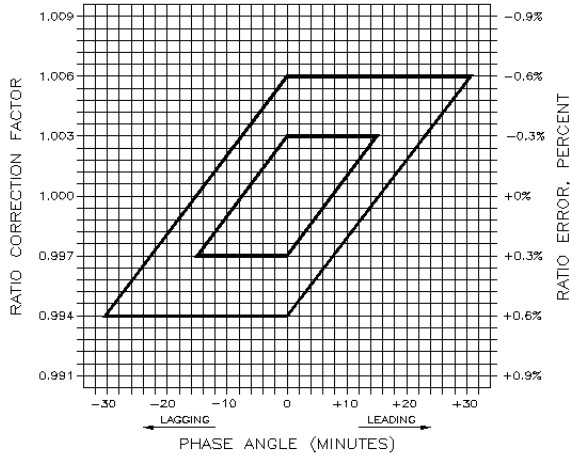

The parallelogram serves as a useful tool to verify the accuracy of instrument transformers. To meet the 0.3% accuracy classification for current transformers the phase angle and the ratio error must fall within the center parallelogram (above). To meet the 0.6% accuracy the phase angle and error must fall within the outer parallelogram. Similarly for voltage transformers the parallelogram (below) is a mirror image of the current transformer. To classify as a 0.3% accuracy class voltage transformer the phase angle and ratio error must fall within the parallelogram.

IEEE Std. C57.13 limits of accuracy class for potential transformers for metering 0.3 accuracy class

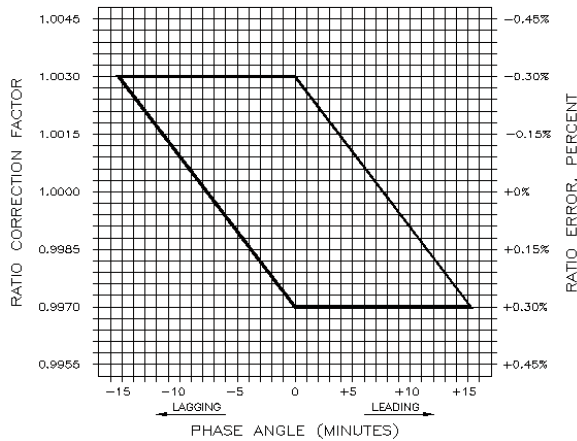

STANDARD ACCURACY

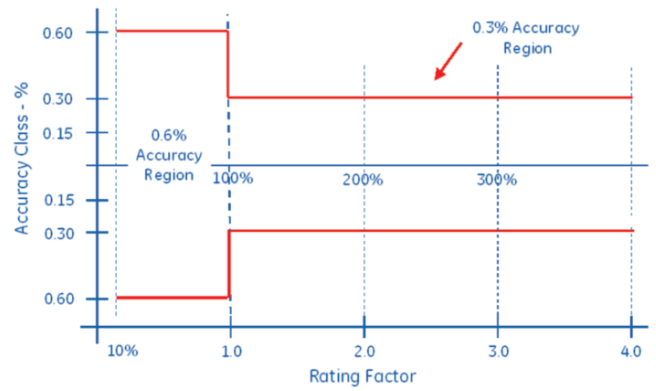

ENCOMPASS ACCURACY

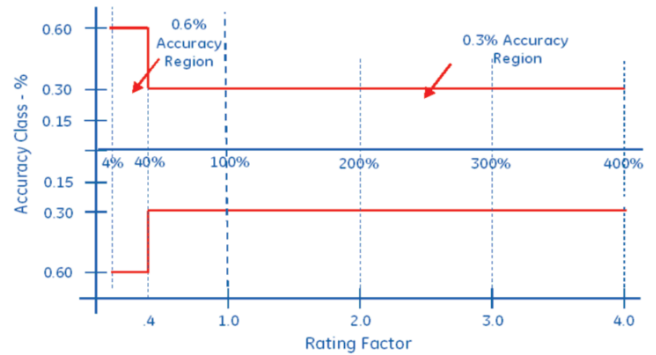

SAMPLE TEST CARD

Type: JAB-0C Catalog No: 750X136208
 Ratio: 800:5 Serial No: xxxxxxxx

Secondary Burden	Secondary Amps	Ratio Correction Factor	Phase Angle (Minutes)
B0.5	5	1.0015	4.4
	0.5	1.0024	9.7

Date: xx/xx/xxxx
 Tested by: xx

Instrument Transformer
 Calibration and accuracy test results were received in accordance with IEEE Std. C57.13-1996 in conformity with the original IEEE Std. C57.13-1980 presented on file to the National Institute of Standards and Technology.

The limit of permissible error in a current transformer accuracy class has one value at 100% rated current and allows twice that amount of error at 10% rated current. Typically 0.3% error is acceptable for watt-hour metering, 0.6% to 1.2% error for indicating instruments and 10% error for relaying. The figure below shows the performance limits of a standard metering 0.3% accuracy CT with a rating factor of 4.0.

CIRCLE DIAGRAM

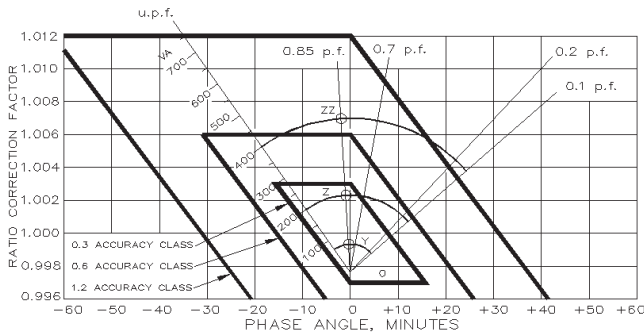

The circle diagram can be used to predict the performance of a transformer for various loads and power factors. A convenient scale of volt-ampere is shown on the unity power factor line (u.p.f.) and commences at the zero or no-load locus. To use the diagram, measure the known V.A. and scribe an arc about the "Zero" locus of a length that contains the angle of the burden power factor. The point at which the arc terminates is the error locus in phase angle minutes and ratio correction factor.

METERING CONNECTIONS

Typical Examples

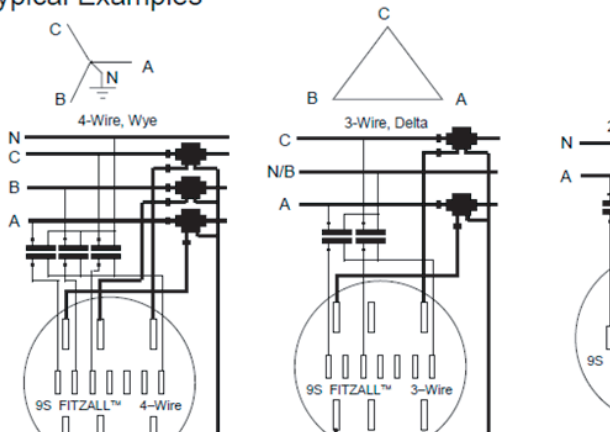

RELAY ACCURACY OF A CURRENT TRANSFORMER

Current transformers that are used to operate relays for control and system protection must have certain accuracy under over-current conditions. The transformer must be able to not only withstand the high currents involved, but must also transformer current to a lower value suitable for application to the relay terminals, and do this with a reasonable accuracy. A typical relay accuracy classification might be C200 or T200. A table is provided below showing the standard burden with each associated relay class.

Relay Class & Associated Burdens	
Secondary Terminal Voltage	Standard Burden
C10	B-0.1
C20	B-0.2
C50	B-0.5
C100	B-1
C200	B-2
C400	B-4
C800	B-8

The last number is the secondary voltage that can be developed at the secondary terminals w/ 10% max error.

C200 would be (10% accuracy inferred at 20 X normal current X secondary impedance)

The figure below shows a typical excitation curve of a relay class CT. The curve is used to determine the performance of a CT over the entire range of secondary voltage and current.

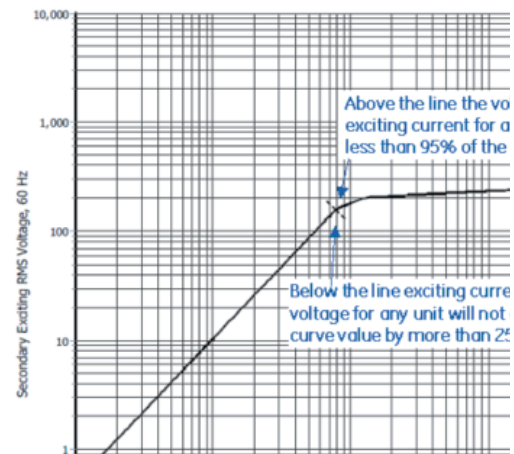

NOTES

NOTES

NOTES