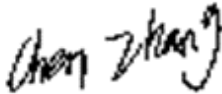

TEST REPORT

Product Name: Super charger
FCC ID: 2A59PKP-SUPER7
Trademark: Koo-Power
Model Number: KP-Super7
Prepared For: Shenzhen Huani electronics Co., Ltd
Address: 3rd Floor, Building B, Jinkaijin Industrial Zone, Shilongzai, Shiyan, Bao'an, Shenzhen, GD, CN, 518108
Manufacturer: Shenzhen Blue Times Technology Co.,Ltd
Address: B Block, Taixinglong Technology Zone, Hezhou, Xixiang Town, BaoAn District, Shenzhen 518126, China
Prepared By: Shenzhen CTB Testing Technology Co., Ltd.
Address: Floor 1&2, Building A, No. 26 of Xinhe Road, Xinqiao Street, Baoan District, Shenzhen China
Sample Received Date: Mar. 22, 2022
Sample tested Date: Mar. 22, 2022 to Mar. 29, 2022
Issue Date: Mar. 29, 2022
Report No.: CTB220329008RFX
Test Standards FCC Part 15 C
Test Results PASS
Remark: This is wireless charger radio test report.

Compiled by:

Chen Zheng

Reviewed by:

Arron Liu

Approved by:

Bin Wang

The test report is effective only with both signature and specialized stamp. This result(s) shown in this report refer only to the sample(s) tested. Without written approval of Shenzhen CTB Testing Technology Co., Ltd. this report can't be reproduced except in full. The tested sample(s) and the sample information are provided by the client.

TABLE OF CONTENTS

1. GENERAL INFORMATION	3
1.1. Report information.....	3
1.2. Measurement Uncertainty	3
1.3. Test Facility	3
1.4. Test Uncertainty	4
2. PRODUCT DESCRIPTION	5
2.1. EUT Description	5
2.2. Block Diagram of EUT Configuration.....	5
2.3. Test Conditions.....	5
2.4. Description Of Support Units (Conducted Mode)	6
3. TEST RESULTS SUMMARY	6
4. TEST EQUIPMENT USED	7
4.1. MEASUREMENT INSTRUMENTS LIST	7
5. CONDUCTED EMISSION TEST	9
5.1. Block Diagram of Test Setup	9
5.2. Test Standard	9
5.3. Conducted Emission Limit	9
5.4. EUT Configuration on Test	9
5.5. Operating Condition of EUT.....	10
5.6. Test Procedure	10
5.7. Test Result.....	10
6. RADIATED EMISSION MEASUREMENT	13
6.1. Block Diagram of Test Setup.....	13
6.2. Test Standard	14
6.3. EMI Test Receiver Setup	14
6.4. Test Procedure	14
6.5. Test Result.....	14
7. OCCUPIED BANDWIDTH	18
7.1. Block Diagram of Test Setup.....	18
7.2. Rules and specifications.....	18
7.3. Test Procedure	18
7.4. Test Result.....	18
8. ANTENNA REQUIREMENT.....	20
9. EUT TEST PHOTOS.....	21

1. GENERAL INFORMATION

1.1. Report information

- 1.1.1. This report is not a certificate of quality; it only applies to the sample of the specific product/equipment given at the time of its testing. The results are not used to indicate or imply that they are application to the similar items. In addition, such results must not be used to indicate or imply that CTB approves recommends or endorses the manufacture, supplier or use of such product/equipment, or that CTB in any way guarantees the later performance of the product/equipment.
- 1.1.2. The sample/s mentioned in this report is/are supplied by Applicant, CTB therefore assumes no responsibility for the accuracy of information on the brand name, model number, origin of manufacture or any information supplied.
- 1.1.3. Additional copies of the report are available to the Applicant at an additional fee. No third part can obtain a copy of this report through CTB, unless the applicant has authorized CTB in writing to do so.

1.2. Measurement Uncertainty

Available upon request.

1.3. Test Facility

Site Description
Name of Firm : Shenzhen CTB Testing Technology Co., Ltd.

Site Location : Floor 1&2, Building A, No. 26 of Xinxhe Road, Xinqiao Community, Xinqiao Street, Baoan District, Shenzhen, Guangdong China

1.4. Test Uncertainty

Item	Uncertainty
Occupancy bandwidth	54.3kHz
Conducted output power Above 1G	0.9dB
Conducted output power below 1G	0.9dB
Power Spectral Density , Conduction	0.9dB
Conduction spurious emissions	2.0dB
Out of band emission	2.0dB
3m chamber Radiated spurious emission(9K-30MHz)	4.8dB
3m chamber Radiated spurious emission(30MHz-1GHz)	4.6dB
3m chamber Radiated spurious emission(1GHz-18GHz)	5.1dB
3m chamber Radiated spurious emission(18GHz-40GHz)	3.4dB
humidity uncertainty	5.5%
Temperature uncertainty	0.63°C
frequency	1×10 ⁻⁷
Conducted Emission (150KHz-30MHz)	3.2 dB
Radiated Emission(30MHz ~ 1000MHz)	4.8 dB
Radiated Emission(1GHz ~6GHz)	4.9 dB

2. PRODUCT DESCRIPTION

2.1. EUT Description

Description : Super charger
Model Number : KP-Super7
Serial Model : N/A
Model : N/A
Difference : N/A
Power Supply : Input: AC 100-240V, 50/60Hz, 0.5A
Output: Type C & Lighting Cable: PD 5V/2.4A, 9V/2.22A, 12V/1.5A
2*USB: DC 4.5V/5A, 5V/4.5A, 9V/2A, 12V/1.5A
Wireless:15W/10W/7.5W/5W
Battery capacity: 20000mAh/77Wh(Max.)
Work Frequency : 110-205KHz

2.2. Block Diagram of EUT Configuration

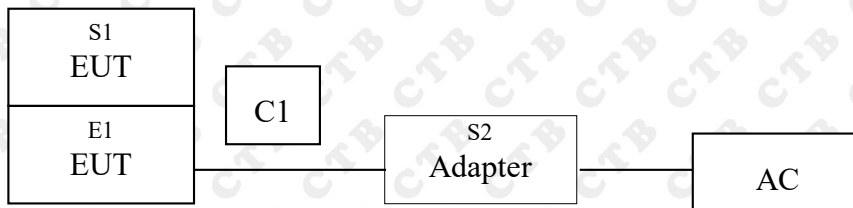

2.3. Test Conditions

Temperature: 23~25°C
Relative Humidity: 55~63 %

Test Mode	Description	Remark
TM1	Wireless Charging	Output: 5W
TM2	Wireless Charging	Output: 7.5W
TM3	Wireless Charging	Output: 10W
TM4	Wireless Charging	Output: 15W

2.4. Description Of Support Units (Conducted Mode)

The EUT has been tested as an independent unit together with other necessary accessories or support units. The following support units or accessories were used to form a representative test configuration during the tests.

Item	Equipment	Mfr/Brand	Model/Type No.	Series No.	Note
E1	Super charger	Koo-Power	KP-Super7	N/A	EUT
S1	Adapter	N/A	HP18A-09020000-AU	N/A	auxiliary equipment
S2	I Phone	N/A	A12	N/A	auxiliary equipment

Item	Shielded Type	Ferrite Core	Length	Note

Note:

- (1) The support equipment was authorized by Declaration of Confirmation.
- (2) For detachable type I/O cable should be specified the length in cm in 『Length』 column.
- (3) “YES” is means “shielded” “with core”; “NO” is means “unshielded” “without core”.

3. TEST RESULTS SUMMARY

Table 1 Test Results Summary

Section	Test Items	Test Results
15.207	Conducted disturbance	Pass
15.209(a)(f)	Radiated disturbance	Pass
15.215	20 d B Bandwidth	Pass

Remark: “N/A” means “Not applicable.”

4. TEST EQUIPMENT USED

4.1. MEASUREMENT INSTRUMENTS LIST

Item	Equipment	Manufacturer	Type No.	Serial No.	Last calibration	Calibrated until
1	Spectrum Analyzer	Agilent	N9020A	MY52090073	2021.09.27	2022.08.05
2	Power Sensor	Agilent	U2021XA	MY56120032	2021.09.27	2022.08.05
3	Power Sensor	Agilent	U2021XA	MY56120034	2021.09.27	2022.08.05
4	Communication test set	R&S	CMW500	108058	2021.09.27	2022.08.05
5	Spectrum Analyzer	R&S	FSP40	100550	2021.09.27	2022.08.05
6	Signal Generator	Agilent	N5181A	MY49060920	2021.09.27	2022.08.16
7	Signal Generator	Agilent	N5182A	MY47420195	2021.09.27	2022.08.05
8	Communication test set	Agilent	E5515C	MY50102567	2021.09.27	2022.08.16
9	band rejection filter	Shenxiang	MSF2400-24 83.5MS-1154	20181015001	2021.09.27	2022.08.05
10	band rejection filter	Shenxiang	MSF5150-58 50MS-1155	20181015001	2021.09.27	2022.08.05
11	band rejection filter	Xingbo	XBLBQ-DZA 120	190821-1-1	2021.09.27	2022.08.05
12	BT&WI-FI Automatic test software	Microwave	MTS8310	Ver. 2.0.0.0	\	\
13	Rohde & Schwarz SFU Broadcast Test System	R&S	SFU	101017	2021.09.27	2022.08.05
14	Temperature humidity chamber	Hongjing	TH-80CH	DG-15174	2021.09.27	2022.08.05
15	234G Automatic test software	Microwave	MTS8200	Ver. 2.0.0.0	\	\
16	966 chamber	C.R.T.	966 Room	966	2021.09.27	2024.08.11
17	Receiver	R&S	ESPI	100362	2021.09.27	2022.08.05
18	Amplifier	HP	8447E	2945A02747	2021.09.27	2022.08.05
19	Amplifier	Agilent	8449B	3008A01838	2021.09.27	2022.08.05
20	TRILOG Broadband Antenna	Schwarzbeck	VULB 9168	00869	2021.09.27	2022.08.07
21	Horn Antenna	Schwarzbeck	BBHA9120D	1911	2021.09.27	2022.08.08
22	Software	Fala	EZ-EMC	FA-03A2 RE	\	\
23	3-Loop Antenna	Daze	ZN30401	17014	2021.09.27	2022.08.05

24	loop antenna	ZHINAN	ZN30900A	/	2021.09.27	2022.08.05
25	Horn antenna	A/H/System	SAS-574	588	2021.09.27	2022.08.05
26	Amplifier	AEROFLEX	/	S/N/ 097	2021.09.27	2022.08.05

Conducted emissions Test					
Equipment	Manufacturer	Model#	Serial#	Last Cal.	Next Cal.
AMN	ROHDE&SCHW ARZ	ESH3-Z5	100318	2021.09.27	2022.08.05
Pulse limiter	ROHDE&SCHW ARZ	ESH3Z2	357881052	2021.09.27	2022.08.05
EMI TEST RECEIVER	ROHDE&SCHW ARZ	ESCS30	834115/006	2021.09.27	2022.08.05
Coaxial cable	ZDECL	Z302S	18091804	2021.09.27	2022.08.05
ISN	TESEQ	NTFM815 8	183	2021.09.27	2022.08.05
EMI TEST RECEIVER	ROHDE&SCHW ARZ	ESCI	100428/003	2021.09.27	2022.08.05
Software	Fala	EZ-EMC	EMC-CON 3A1.1	\	\

Equipment	Manufacturer	Model No.	Serial No.	Last Cal.	Next Cal.
Double Ridged Broadband Horn Antenna	Schwarzbeck	BBHA 9120D	1911	2021.09.27	2022.08.08
TRILOG Broadband Antenna	Schwarzbeck	VULB 9168	869	2021.09.27	2022.08.05
Amplifier	Agilent	8449B	3008A01838	2021.09.27	2022.08.05
Amplifier	HP	8447E	2945A02747	2021.09.27	2022.08.05
EMI TEST RECEIVER	ROHDE&SCHWARZ	ESPI7	100362	2021.09.27	2022.08.05
Coaxial cable	ETS	RFC-SNS-100-NMS-80 NI	/	2021.09.27	2022.08.05
Coaxial cable	ETS	RFC-SNS-100-NMS-20 NI	/	2021.09.27	2022.08.05
Coaxial cable	ETS	RFC-SNS-100-SMS-20 NI	/	2021.09.27	2022.08.05
Coaxial cable	ETS	RFC-NNS-100-NMS-300 NI	/	2021.09.27	2022.08.05
Communication test set	Agilent	E5515C	MY50102567	2021.09.27	2022.08.16
Communication test set	R&S	CMW500	108058	2021.09.27	2022.08.05
EZ-EMC	Frad	EMC-con3A1.1	/	/	/

5. CONDUCTED EMISSION TEST

5.1. Block Diagram of Test Setup

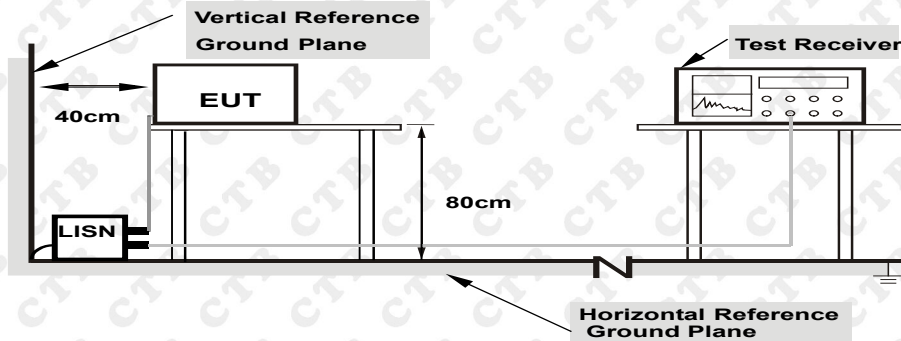

Note: 1. Support units were connected to second LISN.
2. Both of LISNs (AMN) are 80 cm from EUT and at least 80 cm from other units and other metal planes

The setup of EUT is according with per ANSI C63.10-2013 measurement procedure. The specification used was with the FCC Part 15.207 limits.

5.2. Test Standard

FCC§15.207

5.3. Conducted Emission Limit

Frequency MHz	Limits dB(μ V)	
	Quasi-peak Level	Average Level
0.15 ~ 0.50	66 ~ 56*	56 ~ 46*
0.50 ~ 5.00	56	46
5.00 ~ 30.00	60	50

Notes: 1. *Decreasing linearly with logarithm of frequency.

5.4. EUT Configuration on Test

The following equipments are installed on conducted emission test to meet FCC Part 15.207 requirement and operating in a manner, which tends to maximize its emission characteristics in a normal application.

5.5. Operating Condition of EUT

5.5.1. Setup the EUT and simulators as shown in Section 5.1.

5.5.2. Turn on the power of all equipments.

5.5.3. Let the EUT work in test modes (EUT Working) and test it.

5.6. Test Procedure

The EUT is put on a table of non-conducting material that is 80cm high. The vertical conducting wall of shielding is located 40cm to the rear of the EUT. The power line of the EUT is connected to the AC mains through a Artificial Mains Network (A.M.N.). A EMI test receiver (R&S Test Receiver ESHS30) is used to test the emissions form both sides of AC line. The bandwidth of EMI test receiver is set at 9kHz.

The bandwidth of the test receiver (R&S Test Receiver ESHS30) is set at 10kHz.

We pretest AC 120V and AC 240V, the worst voltage was AC 120V and the data recording in the report.

5.7. Test Result

PASS

Please refer to the following pages.

Temperature:	26 °C	Relative Humidity:	54%
Pressure:	1010hPa	Phase :	L
Test Voltage :	AC 120V/60Hz	Test Mode:	TM3

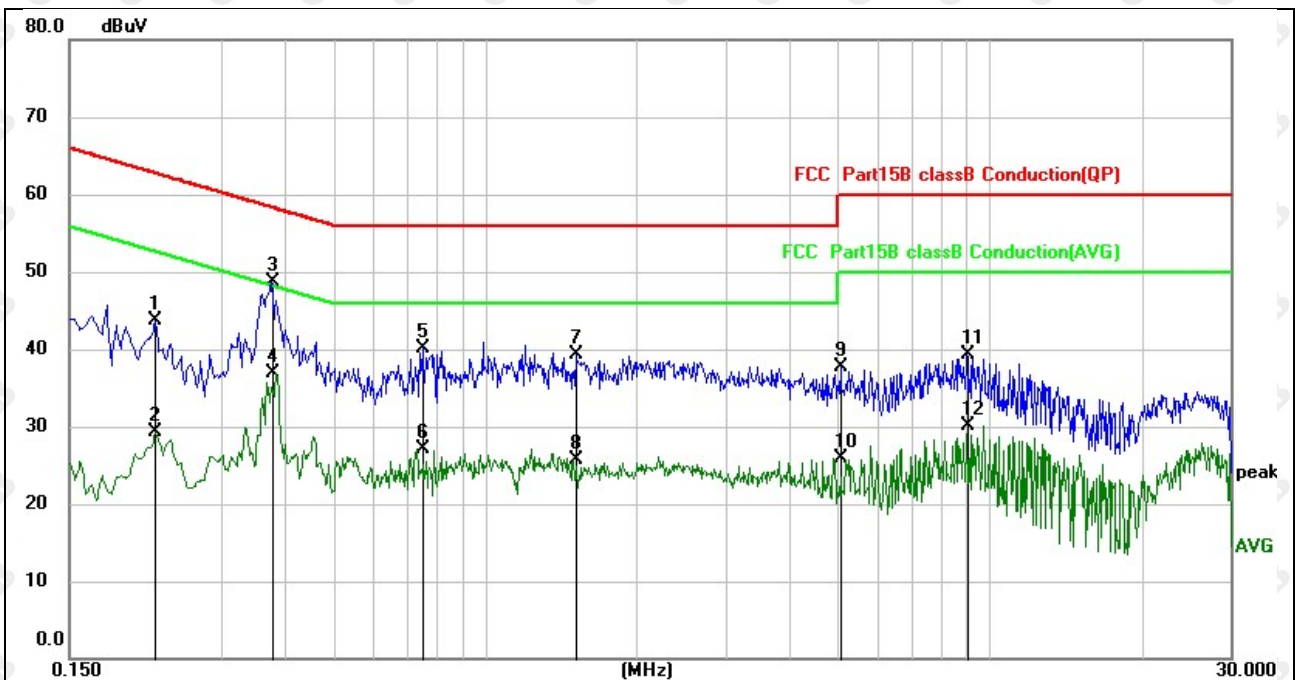

Remark:

1. All readings are Quasi-Peak and Average values.
2. Factor = Insertion Loss + Cable Loss.

No.	Mk.	Freq. MHz	Reading Level dBuV	Correct Factor dB	Measure- ment dBuV	Limit dBuV	Margin dB	Detector
1		0.2220	32.94	10.68	43.62	62.74	-19.12	QP
2		0.2220	18.56	10.68	29.24	52.74	-23.50	AVG
3	*	0.3780	38.15	10.59	48.74	58.32	-9.58	QP
4		0.3780	26.33	10.59	36.92	48.32	-11.40	AVG
5		0.7539	29.63	10.57	40.20	56.00	-15.80	QP
6		0.7539	16.60	10.57	27.17	46.00	-18.83	AVG
7		1.5140	28.78	10.62	39.40	56.00	-16.60	QP
8		1.5140	15.09	10.62	25.71	46.00	-20.29	AVG
9		5.0660	27.00	10.65	37.65	60.00	-22.35	QP
10		5.0660	15.30	10.65	25.95	50.00	-24.05	AVG
11		9.0500	28.51	10.79	39.30	60.00	-20.70	QP
12		9.0500	19.32	10.79	30.11	50.00	-19.89	AVG

Temperature:	26 °C	Relative Humidity:	54%
Pressure:	1010hPa	Phase :	N
Test Voltage :	AC 120V/60Hz	Test Mode:	TM3

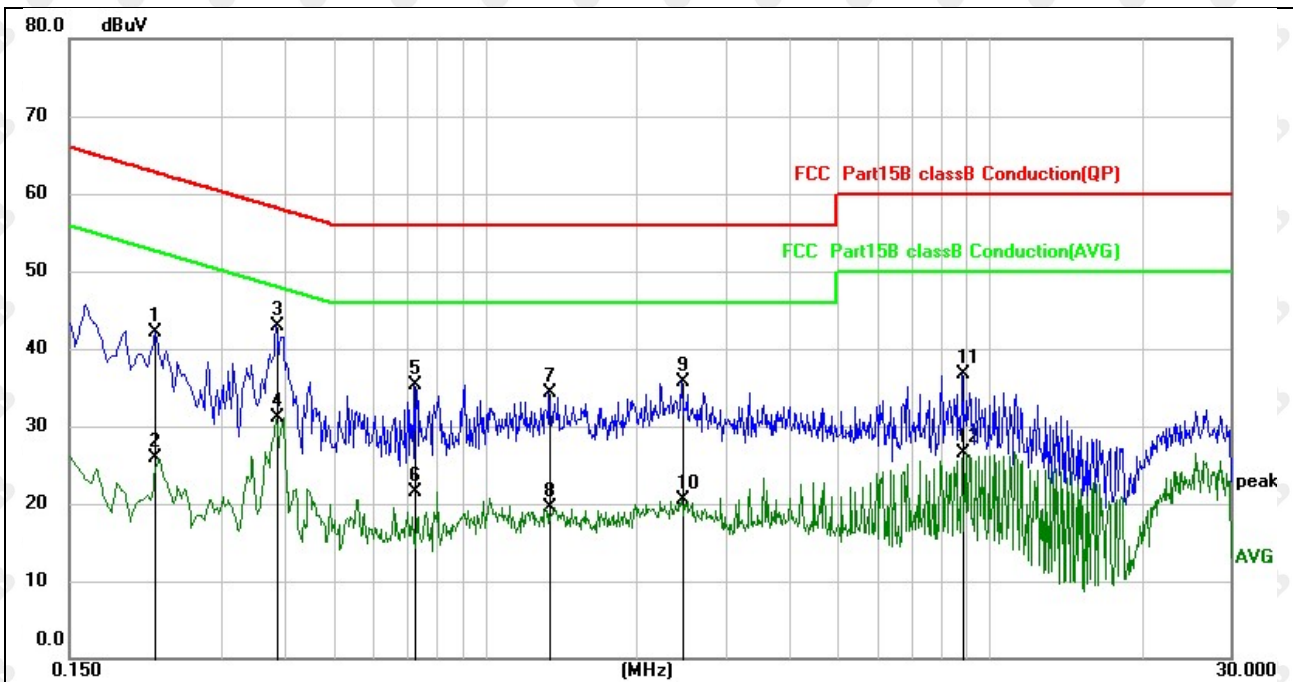

Remark:

1. All readings are Quasi-Peak and Average values.
2. Factor = Insertion Loss + Cable Loss.

No.	Mk.	Freq. MHz	Reading Level dBuV	Correct Factor dB	Measure- ment dBuV	Limit dBuV	Margin dB	Detector
1		0.2220	31.39	10.68	42.07	62.74	-20.67	QP
2		0.2220	15.18	10.68	25.86	52.74	-26.88	AVG
3	*	0.3860	32.26	10.59	42.85	58.15	-15.30	QP
4		0.3860	20.60	10.59	31.19	48.15	-16.96	AVG
5		0.7260	24.66	10.57	35.23	56.00	-20.77	QP
6		0.7260	10.99	10.57	21.56	46.00	-24.44	AVG
7		1.3420	23.75	10.62	34.37	56.00	-21.63	QP
8		1.3420	8.81	10.62	19.43	46.00	-26.57	AVG
9		2.4539	25.16	10.63	35.79	56.00	-20.21	QP
10		2.4539	9.81	10.63	20.44	46.00	-25.56	AVG
11		8.8340	25.92	10.78	36.70	60.00	-23.30	QP
12		8.8340	15.72	10.78	26.50	50.00	-23.50	AVG

6. RADIATED EMISSION MEASUREMENT

6.1. Block Diagram of Test Setup

6.1.1. Block Diagram of connection between the EUT and the simulators

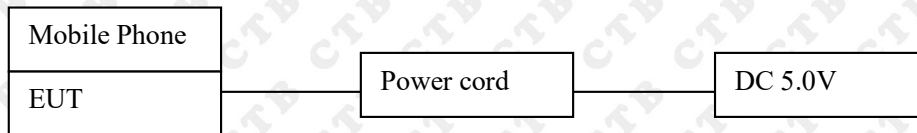

6.1.2. Anechoic Chamber Test Setup Diagram

(A) Radiated Emission Test-Up Frequency Below 30MHz

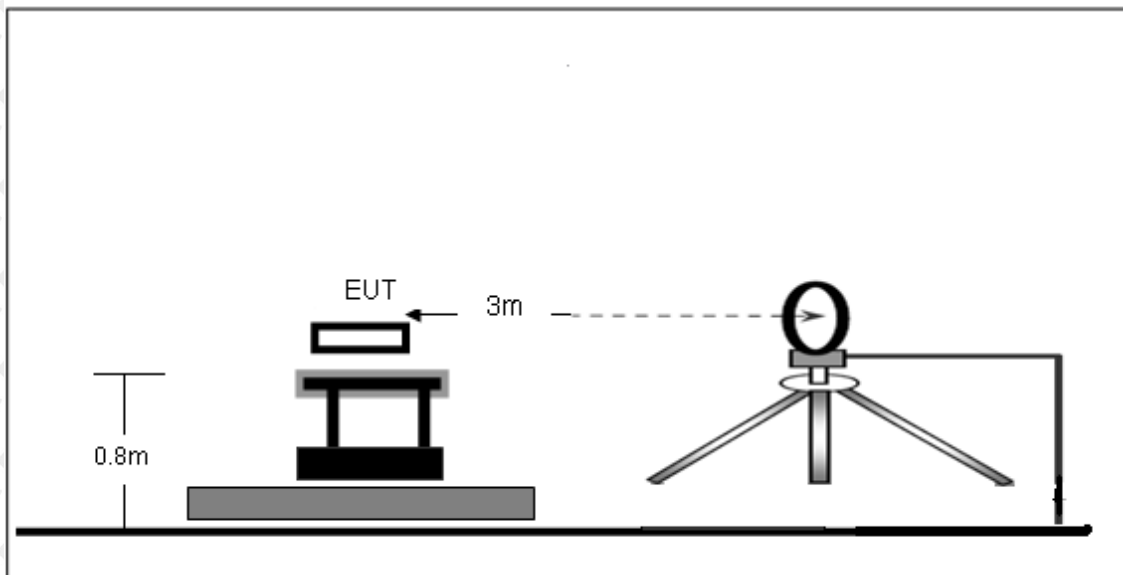

(B) Radiated Emission Test-Up Frequency 30MHz~1GHz

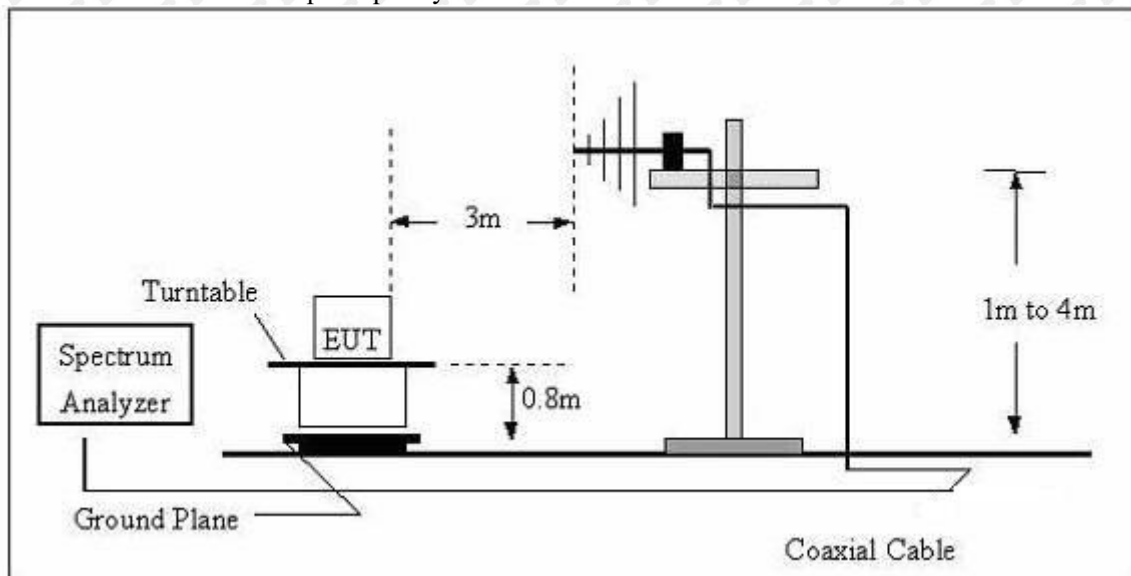

The radiated emission tests were performed in the 3 meters chamber test site, using the setup accordance with the ANSI C63.10-2013. The specification used was the FCC 15.209 and FCC 15.205 limits.

6.2. Test Standard

FCC §15.209; §15.205

6.3. EMI Test Receiver Setup

The system was investigated from 9kHz to1GHz.

During the radiated emission test, the EMI test receiver setup was set with the following configurations:

Frequency Range	RBW	Video B/W	Detector
9 kHz – 150 kHz	200 kHz	1 kHz	QP
150 kHz – 30MHz	9kHz	30kHz	QP
30 MHz – 1000 MHz	120 kHz	300 kHz	QP

Note: For the frequency bands 9-90 kHz and 110-490 kHz, the test was based on average detector.

6.4. Test Procedure

The EUT is placed on a turn table which is 0.8 meter above ground. The turn table can rotate 360 degrees to determine the position of the maximum emission level. The EUT is set 3 meters away from the receiving antenna which is mounted on a antenna tower. The antenna can move up and down between 1 to 4 meters to find out the maximum emission level. Broadband antenna (calibrated by dipole antenna) are used as a receiving antenna. Both horizontal and vertical polarization of the antenna are set on measurement.

6.5. Test Result

PASS

Please refer to the following pages.

9kHz-30MHz

Temperature:	26 °C	Relative Humidity:	54%
Pressure:	1010 hPa	Polarization :	Horizontal
Test Voltage :	AC120V/60Hz	Test Mode :	TM4

Freq. (MHz)	Detector Mode (PK/QP/AV)	Corrected Amplitude (dBuV)	Turntable Degree	Height (m)	Limits 3m (dBuV/m)	Margin (dBuV/m)
0.204	PEAK	59.93	20.47	80.40	102.2	-21.80
0.338	PEAK	35.60	20.03	55.63	97	-41.37
0.566	PEAK	20.06	19.63	39.69	72.5	-32.81
0.802	PEAK	21.91	19.58	41.49	69.5	-28.01
1.058	PEAK	31.95	19.87	51.82	67.1	-15.28
2.214	PEAK	29.58	19.65	49.23	69.5	-20.27

Note:

Pre-scan in the all of mode, the worst case in of was recorded.

Factor = antenna factor + cable loss – pre-amplifier.

Margin = Limit - Emission Level.

30MHz-1GHz

Temperature:	26 °C	Relative Humidity:	54%
Pressure:	1010 hPa	Polarization :	Horizontal
Test Voltage :	AC120V/60Hz	Test Mode :	TM3

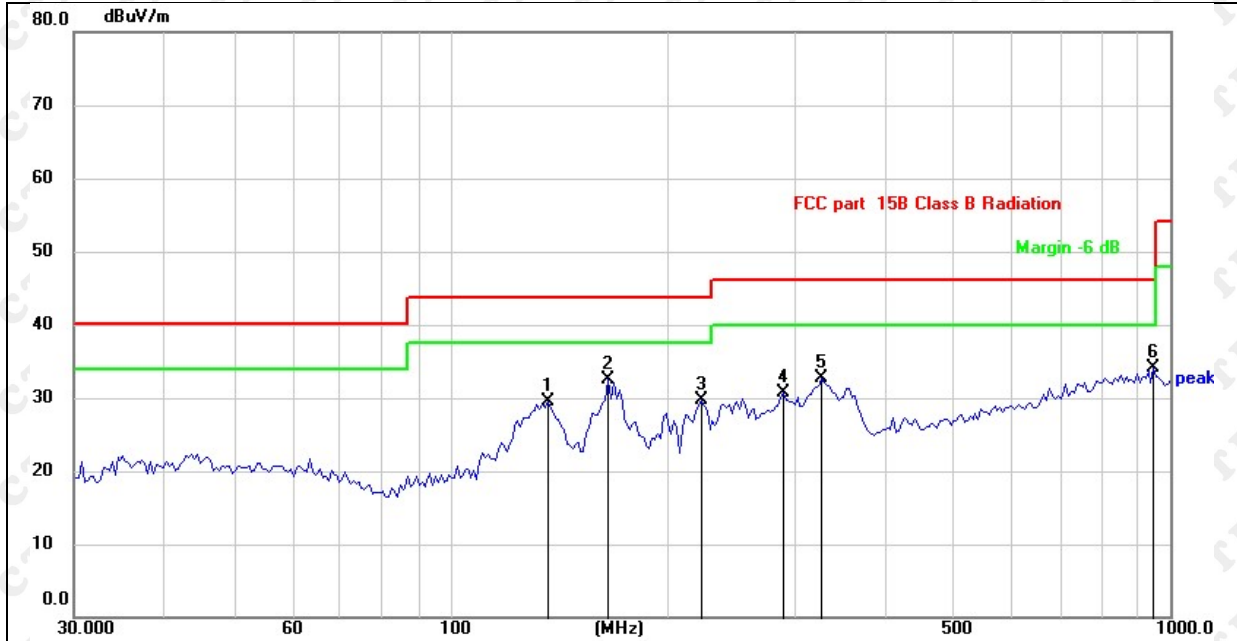

Remark:

Factor = Antenna Factor + Cable Loss – Pre-amplifier, Margin = Measurement– Limit.

No.	Mk.	Freq.	Reading Level	Correct Factor	Measurement	Limit	Over	Detector
		MHz	dBuV	dB	dBuV/m	dB/m	dB	
1		136.6993	35.18	-5.67	29.51	43.50	-13.99	QP
2	*	165.7771	38.44	-5.91	32.53	43.50	-10.97	QP
3		223.3414	36.19	-6.42	29.77	43.50	-13.73	QP
4		290.5261	35.94	-5.31	30.63	46.00	-15.37	QP
5		328.4626	36.90	-4.21	32.69	46.00	-13.31	QP
6		948.7609	28.12	5.91	34.03	46.00	-11.97	QP

Temperature:	26 °C	Relative Humidity:	54%
Pressure:	1010 hPa	Polarization :	Vertical
Test Voltage :	AC120V/60Hz	Test Mode :	TM3

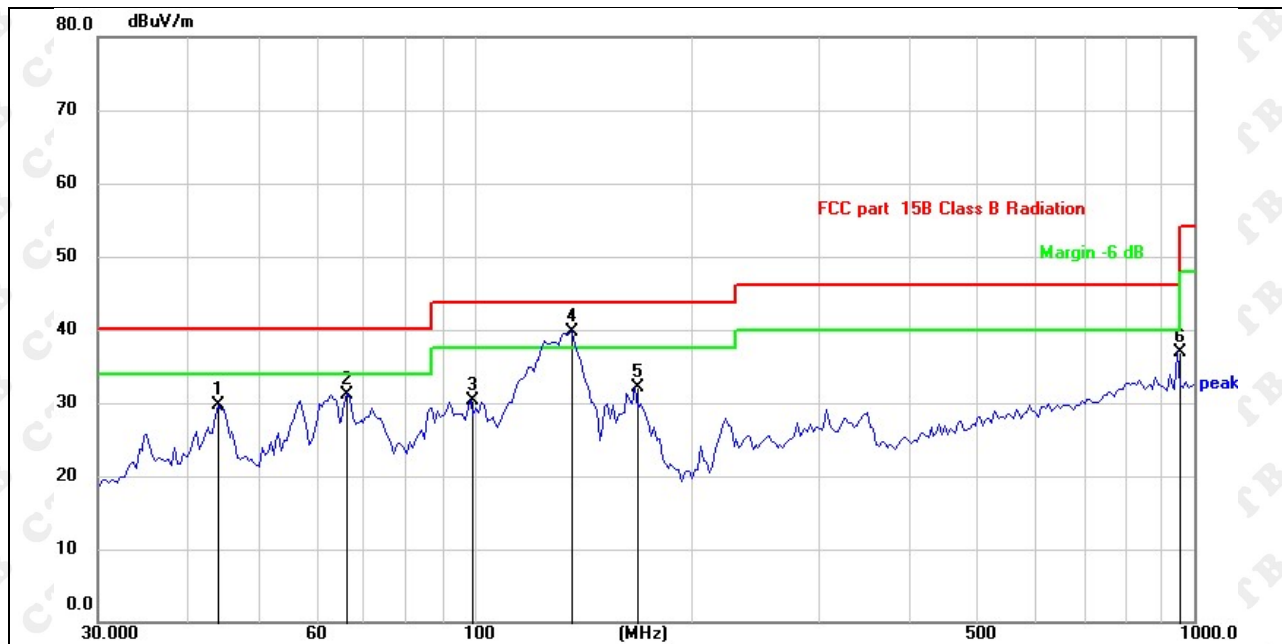

Remark:
Factor = Antenna Factor + Cable Loss – Pre-amplifier, Margin = Measurement– Limit.

No.	Mk.	Freq. MHz	Reading Level dBuV	Correct Factor dB	Measure- ment dBuV/m	Limit dB/m	Over dB	Detector
1		44.1202	35.10	-5.42	29.68	40.00	-10.32	QP
2		66.6156	38.53	-7.33	31.20	40.00	-8.80	QP
3		98.8326	39.11	-8.77	30.34	43.50	-13.16	QP
4	*	136.6993	45.43	-5.67	39.76	43.50	-3.74	QP
5		167.2368	38.09	-5.99	32.10	43.50	-11.40	QP
6		948.7610	31.02	5.91	36.93	46.00	-9.07	QP

7. OCCUPIED BANDWIDTH

7.1. Block Diagram of Test Setup

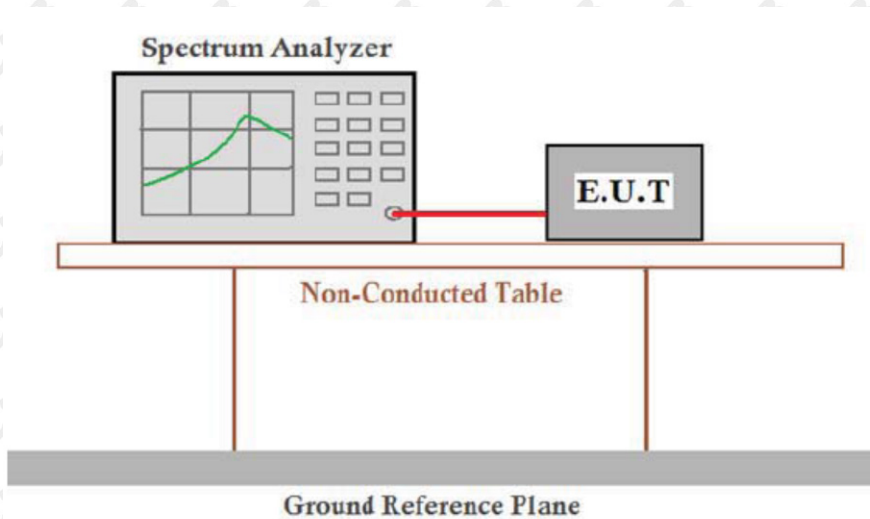

7.2. Rules and specifications

CFR 47 Part 15.215(c)
ANSI C63.10-2013

7.3. Test Procedure

Intentional radiators operating under the alternative provisions to the general emission limits, as contained in §§15.217 through 15.257 and in subpart E of this part, must be designed to ensure that 20dB bandwidth of the emission, or whatever bandwidth may otherwise be specified in the specific rule section under which the equip compliance with the 20dB attenuation specification may base on measurement at the intentional radiator's antenna output terminal unless the intentional radiator uses a permanently attached antenna, in which case compliance shall be demonstrated by measuring the radiated emissions.

7.4. Test Result

PASS

Mode	Freq (KHz)	20dB Bandwidth (Hz)	Limit (kHz)	Conclusion
Tx Mode	139.3	282	/	PASS

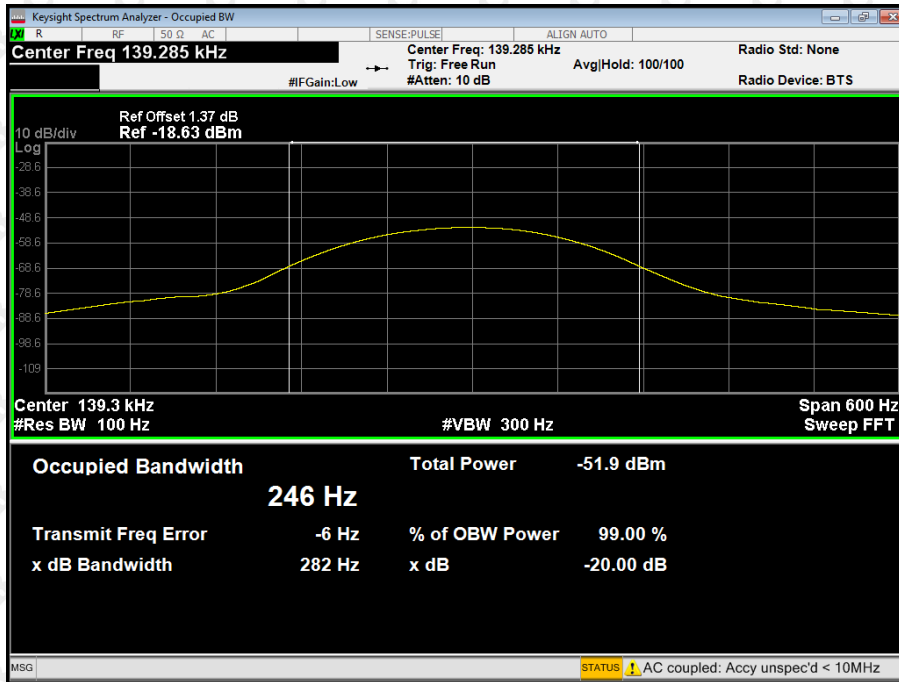

8. ANTENNA REQUIREMENT

15.203 requirement:

An intentional radiator shall be designed to ensure that no antenna other than that furnished by the responsible party shall be used with the device. The use of a permanently attached antenna or of an antenna that uses a unique coupling to the intentional radiator, the manufacturer may design the unit so that a broken antenna can be replaced by the user, but the use of a standard antenna jack or electrical connector is prohibited.

15.247(b) (4) requirement:

The conducted output power limit specified in paragraph (b) of this section is based on the use of antennas with directional gains that do not exceed 6 dBi. Except as shown in paragraph (c) of this section, if transmitting antennas of directional gain greater than 6 dBi are used, the conducted output power from the intentional radiator shall be reduced below the stated values in paragraphs (b)(1), (b)(2), and (b)(3) of this section, as appropriate, by the amount in dB that the directional gain of the antenna exceeds 6 dBi.

EUT Antenna:

The antenna is Internal Antenna. The best case gain of the antenna is 1dBi.

9. EUT TEST PHOTOS

Conducted Measurement Photos

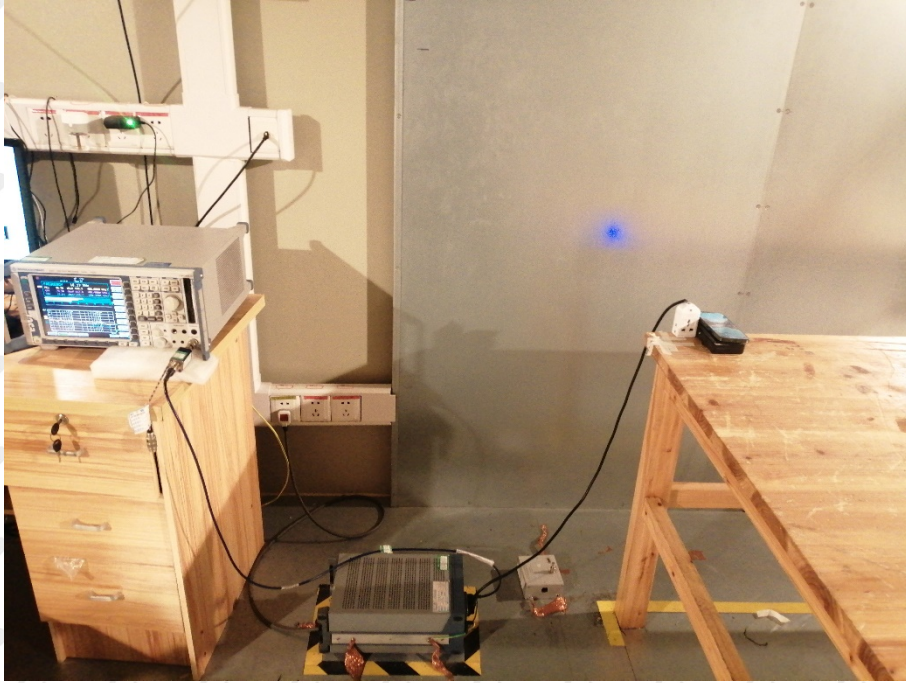

Radiated Measurement Photos
30MHz-1GHz

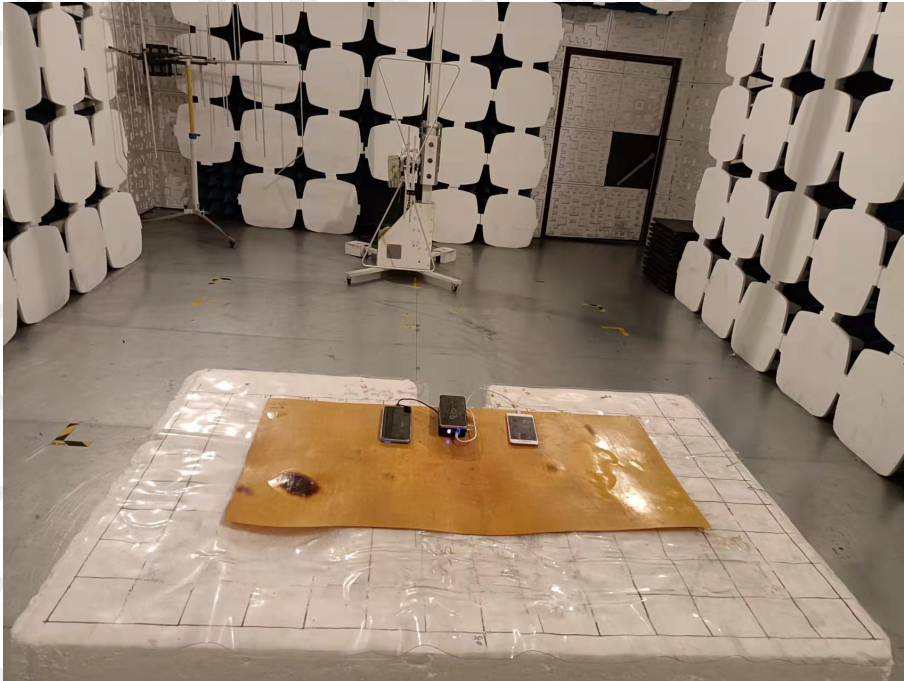

9KHz-30MHz



***** END OF REPORT
