



# FCC Part 15C Test Report

## FCC ID:2AFHY-CB188WSH

Product Name:	WiFi Doorbell
Trademark:	HUANSO
Model Name :	CB188W-SH CB288W-SH, CB388W-SH, CB488W-SH, CB588W-SH, CB688W-SH, CB788W-SH, CB888W-SH, CB988W-SH
Prepared For :	ZHUHAI HUANSO INDUSTRIAL CO., LTD.
Address :	2F, No.8, Jingyuan Road, Jida Industrial Park Jida, 519015, Xiangzhou, Zhuhai, China
Prepared By :	Shenzhen BCTC Testing Co., Ltd.
Address :	BCTC Building & 1-2F, East of B Building, Pengzhou Industrial, Fuyuan 1st Road, Qiaotou Community, Fuyong Street, Bao'an District, Shenzhen, China
Test Date:	Jul. 04 – Jul. 16, 2018
Date of Report :	Jul. 16, 2018
Report No.:	BCTC-FY180603592-2E



### VERIFICATION OF COMPLIANCE

**Applicant's name** ..... ZHUHAI HUANSO INDUSTRIAL CO., LTD.  
Address ..... 2F, No.8, Jingyuan Road, Jida Industrial Park Jida, 519015,  
Xiangzhou, Zhuhai, China

**Manufacture's Name**... ZHUHAI HUANSO INDUSTRIAL CO., LTD.  
Address ..... 2F, No.8, Jingyuan Road, Jida Industrial Park Jida, 519015,  
Xiangzhou, Zhuhai, China

**Product description**

Product name ..... WiFi Doorbell  
Trademark: HUANSO  
CB188W-SH  
Model Name: CB288W-SH, CB388W-SH, CB488W-SH, CB588W-SH, CB688W-SH,  
CB788W-SH, CB888W-SH, CB988W-SH  
FCC Part15.231  
Test Standards: ANSI C63.10-2013

This device described above has been tested by BCTC, and the test results show that the equipment under test (EUT) is in compliance with the FCC requirements. And it is applicable only to the tested sample identified in the report.

This report shall not be reproduced except in full, without the written approval of BCTC, this document may be altered or revised by BCTC, personal only, and shall be noted in the revision of the document.

Test Result..... **Pass**

Prepared by(Engineer):	Lake Xie	<u>Lake Xie</u>
Reviewer(Supervisor):	Rita Xiao	<u>Rita Xiao</u>
Approved(Manager):	Carson Zhang	<u>Carson Zhang</u>





<b>Table of Contents</b>	<b>Page</b>
<b>1 . SUMMARY OF TEST RESULTS</b>	<b>5</b>
1.1 TEST FACILITY	6
1.2 MEASUREMENT UNCERTAINTY	6
<b>2 . GENERAL INFORMATION</b>	<b>7</b>
2.1 GENERAL DESCRIPTION OF EUT	7
2.2 DESCRIPTION OF TEST MODES	8
2.3 BLOCK DIGRAM SHOWING THE CONFIGURATION OF SYSTEM TESTED	8
2.4 DESCRIPTION OF SUPPORT UNITS(CONDUCTED MODE)	8
2.5 EQUIPMENTS LIST FOR ALL TEST ITEMS	9
<b>3 . EMC EMISSION TEST</b>	<b>10</b>
3.1 CONDUCTED EMISSION MEASUREMENT	10
3.1.1 POWER LINE CONDUCTED EMISSION LIMITS	10
3.1.2 TEST PROCEDURE	11
3.1.3 DEVIATION FROM TEST STANDARD	11
3.1.4 TEST SETUP	11
3.1.5 EUT OPERATING CONDITIONS	11
3.1.6 TEST RESULTS	12
3.2 RADIATED EMISSION MEASUREMENT	14
3.2.1 RADIATED EMISSION LIMITS	14
3.2.2 TEST PROCEDURE	15
3.2.3 TEST SETUP	16
3.2.4 EUT OPERATING CONDITIONS	17
3.2.5 TEST RESULTS	18
<b>4 . BANDWIDTH TEST</b>	<b>24</b>
4.1 APPLIED PROCEDURES / LIMIT	24
4.1.1 TEST PROCEDURE	24
4.1.2 DEVIATION FROM STANDARD	24
4.1.3 TEST SETUP	24
4.1.4 EUT OPERATION CONDITIONS	24
4.1.5 TEST RESULTS	25
<b>5 . CALCULATION OF AVERAGE FACTOR</b>	<b>26</b>
<b>6 . DWELL TIME</b>	<b>29</b>
6.1 DEVIATION FROM STANDARD	29
6.2 TEST SETUP	29



<b>Table of Contents</b>	<b>Page</b>
6.3 EUT OPERATION CONDITIONS	29
6.4 TEST RESULTS	30
7 . ANTENNA REQUIREMENT	31
7.1 STANDARD REQUIREMENT	31
7.2 EUT ANTENNA	31
8 . EUT TEST PHOTO	32
9 . EUT PHOTO	34
APPENDIX-PHOTOGRAPHS OF EUT CONSTRUCTIONAL DETAILS	



## 1. SUMMARY OF TEST RESULTS

Test procedures according to the technical standards:

<b>FCC Part15 (15.231) , Subpart C</b>			
<b>Standard Section</b>	<b>Test Item</b>	<b>Judgment</b>	<b>Remark</b>
15.207	Conducted Emission	PASS	
15.209,15.231b	Fundamental &Radiated Spurious Emission Measurement	PASS	
15.231c	Occupy Bandwidth	PASS	
15.231a	Dwell time	PASS	
15.203	Antenna Requirement	PASS	

**NOTE:**

(1) "N/A" denotes test is not applicable in this Test Report



## 1.1 TEST FACILITY

Shenzhen BCTC Testing Co., Ltd.

Add.: BCTC Building & 1-2F, East of B Building, Pengzhou Industrial, Fuyuan 1st Road, Qiaotou Community, Fuyong Street, Bao'an District, Shenzhen, China

FCC Test Firm Registration Number: 712850

IC Registered No.: 23583

## 1.2 MEASUREMENT UNCERTAINTY

The reported uncertainty of measurement  $y \pm U$ , where expanded uncertainty  $U$  is based on a standard uncertainty multiplied by a coverage factor of  $k=2$ , providing a level of confidence of approximately **95 %**.

No.	Item	Uncertainty
1	Conducted Emission Test	$\pm 1.38\text{dB}$
2	RF power,conducted	$\pm 0.16\text{dB}$
3	Spurious emissions,conducted	$\pm 0.21\text{dB}$
4	All emissions,radiated(<1G)	$\pm 4.68\text{dB}$
5	All emissions,radiated(>1G)	$\pm 4.89\text{dB}$
6	Temperature	$\pm 0.5^{\circ}\text{C}$
7	Humidity	$\pm 2\%$



## 2. GENERAL INFORMATION

### 2.1 GENERAL DESCRIPTION OF EUT

Equipment	WiFi Doorbell
Trade Name	HUANSO
Model Name	CB188W-SH
Serial Model	CB288W-SH, CB388W-SH, CB488W-SH, CB588W-SH, CB688W-SH, CB788W-SH, CB888W-SH, CB988W-SH
Model Difference	All the model are the same circuit and RF module, except model names.
Product Description	Operation Frequency: 433.92MHz
	Modulation Type: ASK
	Antenna Gain 1dBi
	Based on the application, features, or specification exhibited in User's Manual, the EUT is considered as an ITE/Computing Device. More details of EUT technical specification, please refer to the User's Manual.
Battery	Battery DC 3.7V, 4000mAh DC 5V USB from adapter
Connecting I/O Port(s)	Please refer to the User's Manual
hardware version	N/A
Software version	N/A
Serial number	N/A

Note:

1. For a more detailed features description, please refer to the manufacturer's specifications or the User's Manual.



**2.2 DESCRIPTION OF TEST MODES**

For All Emission	
Final Test Mode	Description
Mode 1	TX Mode

Note:

- (1) Fully-charged battery is used during the test

**2.3 BLOCK DIGRAM SHOWING THE CONFIGURATION OF SYSTEM TESTED**

Conducted Emission Test

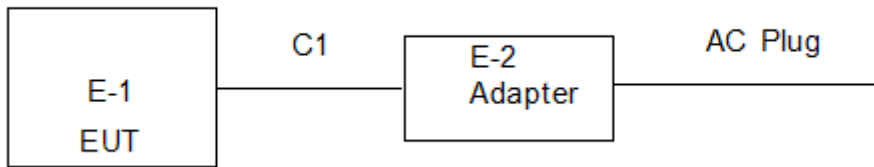

Spurious emissions

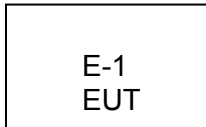

**2.4 DESCRIPTION OF SUPPORT UNITS(CONDUCTED MODE)**

The EUT has been tested as an independent unit together with other necessary accessories or support units. The following support units or accessories were used to form a representative test configuration during the tests.

Item	Equipment	Mfr/Brand	Model/Type No.	Series No.	Note
E-1	WiFi Doorbell	HUANSO	CB188W-SH	N/A	EUT
E-2	Adaptor	N/A	XHY050150U CC	N/A	Auxiliary

Note:

- (1) The support equipment was authorized by Declaration of Confirmation.
- (2) For detachable type I/O cable should be specified the length in cm in 『Length』 column.
- (3) “YES” is means “shielded” “with core”; “NO” is means “unshielded” “without core”.





## 2.5 EQUIPMENTS LIST FOR ALL TEST ITEMS

### Radiation Test equipment

Item	Equipment	Manufacturer	Type No.	Serial No.	Last calibration	Calibrated until
1	Spectrum Analyzer (9kHz-26.5GHz)	Agilent	E4407B	MY45108040	2017.08.27	2018.08.26
2	Test Receiver (9kHz-7GHz)	R&S	ESPI	101318	2017.08.27	2018.08.26
3	Bilog Antenna (30MHz-1GHz)	R&S	VULB 9168	VULB91 68-438	2017.08.27	2018.08.26
4	Horn Antenna (1GHz-18GHz)	SCHWARZBECK	BBHA9120D	1201	2017.09.03	2018.09.02
5	Horn Antenna (14GHz-40GHz)	SCHWARZBECK	BBHA 9170	9170-181	2017.09.03	2018.09.02
6	Amplifier (9KHz-6GHz)	SCHWARZBECK	BBV9744	9744-0037	2017.08.27	2018.08.26
7	Amplifier (1GHz-18GHz)	SCHWARZBECK	BBV9718	9718-309	2017.08.27	2018.08.26
8	Amplifier (18GHz-40GHz)	SCHWARZBECK	BBV 9721	9721-205	2017.08.27	2018.08.26
9	Loop Antenna (9KHz-30MHz)	SCHWARZBECK	FMZB1519B	00014	2017.09.03	2018.09.02
10	RF cables1 (9kHz-1GHz)	R&S	R203	R20X	2017.08.27	2018.08.26
11	RF cables2 (1GHz-40GHz)	R&S	R204	R21X	2017.08.27	2018.08.26
12	Antenna connector	Florida RF Labs	N/A	RF 01#	2017.08.27	2018.08.26
13	Power Metter	ANRITSU	ML2487A	6K00001568	2017.08.27	2018.08.26
14	Power Sensor (AV)	ANRITSU	ML2491A	030989	2017.08.27	2018.08.26
15	Signal Analyzer 9kHz-26.5GHz	Agilent	N9010A	MY48030494	2017.08.27	2018.08.26
16	Test Receiver 20kHz-40GHz	R&S	ESU 40	100376	2017.08.27	2018.08.26
17	D.C. Power Supply	LongWei	PS-305D	010964729	2017.08.27	2018.08.26

### Conduction Test equipment

Item	Equipment	Manufacturer	Type No.	Serial No.	Last calibration	Calibrated until
1	Test Receiver	R&S	ESCI	1166.5950K03-1011 65-ha	2017.08.27	2018.08.26
2	LISN	SCHWARZBECK	NSLK8127	8127739	2017.08.27	2018.08.26
3	LISN	R&S	NSLK8126	8126487	2017.08.27	2018.08.26
4	RF cables	R&S	R204	R20X	2017.08.27	2018.08.26
5	Attenuator	R&S	ESH3-Z2	143206	2017.08.27	2018.08.26



### 3. EMC EMISSION TEST

#### 3.1 CONDUCTED EMISSION MEASUREMENT

##### 3.1.1 POWER LINE CONDUCTED EMISSION Limits (Frequency Range 150KHz-30MHz)

FREQUENCY (MHz)	Limit (dBuV)		Standard
	Quasi-peak	Average	
0.15 -0.5	66 - 56 *	56 - 46 *	FCC
0.50 -5.0	56.00	46.00	FCC
5.0 -30.0	60.00	50.00	FCC

Note:

- (1) The tighter limit applies at the band edges.
- (2) The limit of " \* " marked band means the limitation decreases linearly with the logarithm of the frequency in the range.

The following table is the setting of the receiver

Receiver Parameters	Setting
Attenuation	10 dB
Start Frequency	0.15 MHz
Stop Frequency	30 MHz
IF Bandwidth	9 kHz

### 3.1.2 TEST PROCEDURE

- The EUT was placed 0.8 meters from the horizontal ground plane with EUT being connected to the power mains through a line impedance stabilization network (LISN). All other support equipments powered from additional LISN(s). The LISN provide 50 Ohm/ 50uH of coupling impedance for the measuring instrument.
- Interconnecting cables that hang closer than 40 cm to the ground plane shall be folded back and forth in the center forming a bundle 30 to 40 cm long.
- I/O cables that are not connected to a peripheral shall be bundled in the center. The end of the cable may be terminated, if required, using the correct terminating impedance. The overall length shall not exceed 1 m.
- LISN at least 80 cm from nearest part of EUT chassis.
- For the actual test configuration, please refer to the related Item –EUT Test Photos.

### 3.1.3 DEVIATION FROM TEST STANDARD

No deviation

### 3.1.4 TEST SETUP

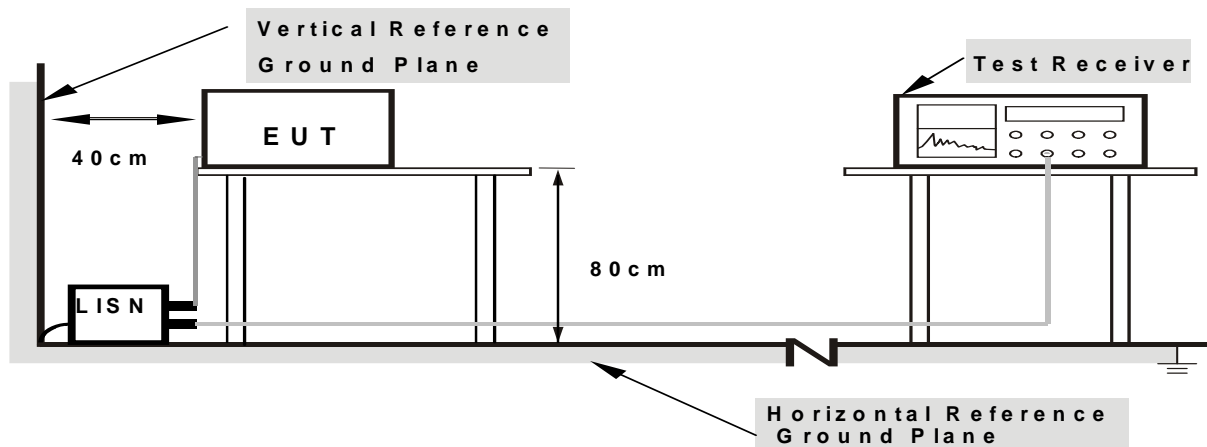

- Note: 1.Support units were connected to second LISN.  
2.Both of LISNs (AMN) are 80 cm from EUT and at least 80 cm from other units and other metal planes

### 3.1.5 EUT OPERATING CONDITIONS

The EUT was configured for testing in a typical fashion (as a customer would normally use it). The EUT has been programmed to continuously transmit during test. This operating condition was tested and used to collect the included data.



3.1.6 TEST RESULTS

Temperature :	26 °C	Relative Humidity :	55%
Pressure :	101kPa	Phase :	L
Test Voltage :	AC 120V/60Hz	Test Mode :	Mode 1

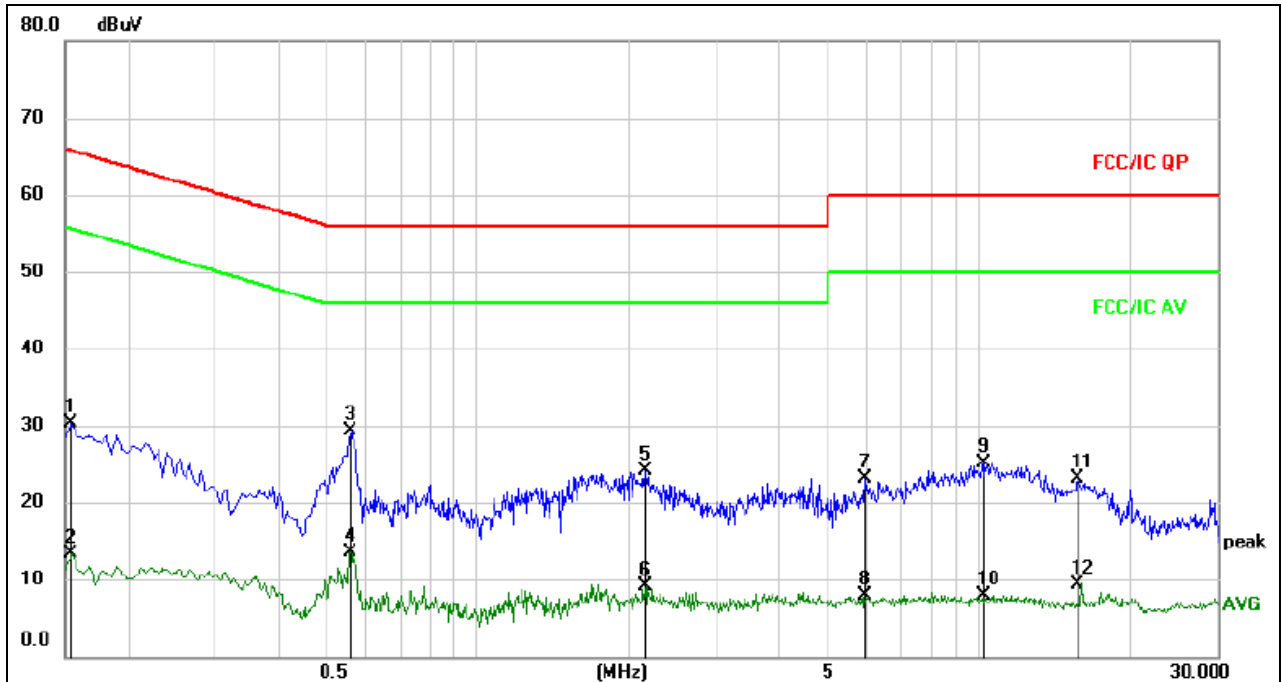

Remark:

1. All readings are Quasi-Peak and Average values.
2. Factor = Insertion Loss + Cable Loss.

No.	Mk.	Freq.	Reading Level	Correct Factor	Measurement	Limit	Over	Detector	Comment
		MHz	dBuV	dB	dBuV	dBuV	dB		
1		0.1545	20.57	9.77	30.34	65.75	-35.41	QP	
2		0.1545	3.62	9.77	13.39	55.75	-42.36	AVG	
3	*	0.5550	19.30	10.02	29.32	56.00	-26.68	QP	
4		0.5550	3.58	10.02	13.60	46.00	-32.40	AVG	
5		2.1570	14.25	9.80	24.05	56.00	-31.95	QP	
6		2.1570	-0.74	9.80	9.06	46.00	-36.94	AVG	
7		5.9550	13.21	9.91	23.12	60.00	-36.88	QP	
8		5.9550	-1.96	9.91	7.95	50.00	-42.05	AVG	
9		10.1805	15.18	9.89	25.07	60.00	-34.93	QP	
10		10.1805	-1.97	9.89	7.92	50.00	-42.08	AVG	
11		15.7875	13.04	10.01	23.05	60.00	-36.95	QP	
12		15.7875	-0.61	10.01	9.40	50.00	-40.60	AVG	



Temperature :	26 °C	Relative Humidity :	55%
Pressure :	101kPa	Phase :	N
Test Voltage :	AC 120V/60Hz	Test Mode :	Mode 1

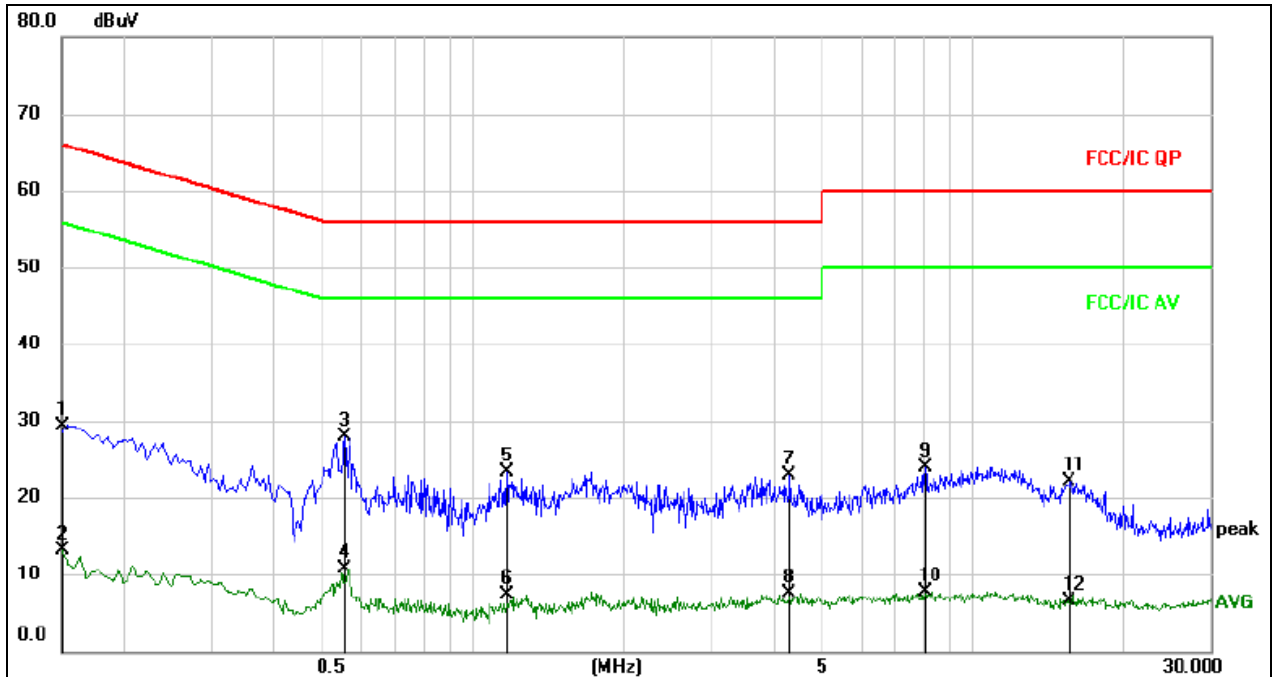

Remark:

1. All readings are Quasi-Peak and Average values.
2. Factor = Insertion Loss + Cable Loss.

No.	Mk.	Freq. MHz	Reading Level dBuV	Correct Factor dB	Measure- ment dBuV	Limit dBuV	Over dB	Detector	Comment
1		0.1500	19.62	9.77	29.39	66.00	-36.61	QP	
2		0.1500	3.37	9.77	13.14	56.00	-42.86	AVG	
3	*	0.5550	17.79	10.02	27.81	56.00	-28.19	QP	
4		0.5550	0.66	10.02	10.68	46.00	-35.32	AVG	
5		1.1670	13.56	9.77	23.33	56.00	-32.67	QP	
6		1.1670	-2.40	9.77	7.37	46.00	-38.63	AVG	
7		4.3080	13.04	9.87	22.91	56.00	-33.09	QP	
8		4.3080	-2.46	9.87	7.41	46.00	-38.59	AVG	
9		8.0520	14.02	9.91	23.93	60.00	-36.07	QP	
10		8.0520	-2.26	9.91	7.65	50.00	-42.35	AVG	
11		15.6750	12.10	10.01	22.11	60.00	-37.89	QP	
12		15.6750	-3.41	10.01	6.60	50.00	-43.40	AVG	



### 3.2 RADIATED EMISSION MEASUREMENT

#### 3.2.1 RADIATED EMISSION LIMITS (Frequency Range 9kHz-1000MHz)

20dBc in any 100 kHz bandwidth outside the operating frequency band. In case the emission fall within the restricted band specified on 15.205(a), then the 15.231(b) limit in the table below has to be followed.

Frequencies(MHz)	Field Strength(microrvolts/meter)	Measurement Distance(meters)
0.009~0.490	2400/F(KHz)	300
0.490~1.705	24000/F(KHz)	30
1.705~30.0	30	30
30~88	100	3
88~216	150	3
216~960	200	3
Above 960	500	3

#### LIMITS OF RADIATED EMISSION MEASUREMENT (Above 1000MHz)

FREQUENCY (MHz)	Limit (dBuV/m) (at 3M)	
	PEAK	AVERAGE
Above 1000	74	54

Notes:

- (1) The limit for radiated test was performed according to FCC PART 15C.
- (2) The tighter limit applies at the band edges.
- (3) Emission level (dBuV/m)=20log Emission level (uV/m).

#### FUNDAMENTAL AND HARMONICS EMISSION LIMITS

Fundamental Frequency (MHz)	Field Strength of Fundamental (microvolts/meter)	Field Strength of Spurious Emissions (microvolts/meter)
40.66 - 40.70	2,250	225
70 - 130	1,250	125
130 - 174	1,250 to 3,750 **	125 to 375 **
174 - 260	3,750	375
260 - 470	3,750 to 12,500 **	375 to 1,250 **
Above 470	12,500	1,250

\*\* linear interpolations

[Where F is the frequency in MHz, the formulas for calculating the maximum permitted fundamental field strengths are as follows: for the band 130-174 MHz,  $\mu\text{V/m}$  at 3 meters =  $56.81818(F) - 6136.3636$ ; for the band 260-470 MHz,  $\mu\text{V/m}$  at 3 meters =  $41.6667(F) - 7083.3333$ . The maximum permitted unwanted emission level is 20 dB below the maximum permitted fundamental level.]



**FREQUENCY RANGE OF RADIATED MEASUREMENT (For unintentional radiators)**

Highest frequency generated or Upper frequency of measurement used in the device or on which the device operates or tunes (MHz)	Range (MHz)
Below 1.705	30
1.705 – 108	1000
108 – 500	2000
500 – 1000	5000
Above 1000	5 <sup>th</sup> harmonic of the highest frequency or 40 GHz, whichever is lower

Spectrum Parameter	Setting
Attenuation	Auto
Start Frequency	1000 MHz
Stop Frequency	10th carrier harmonic
RBW / VBW setting	1 MHz / 1 MHz for Peak, 1 MHz / 10Hz for Average

Receiver Parameter	Setting
Attenuation	Auto
Start ~ Stop Frequency	9kHz~150kHz / RB 200Hz for QP
Start ~ Stop Frequency	150kHz~30MHz / RB 9kHz for QP
Start ~ Stop Frequency	30MHz~1000MHz / RB 120kHz for QP

**3.2.2 TEST PROCEDURE**

- a. The measuring distance of at 3 m shall be used for measurements at frequency up to 1GHz. For frequencies above 1GHz, any suitable measuring distance may be used.
- b. The EUT was placed on the top of a rotating table 0.8 meters above the ground at a 3 meter open area test site. The table was rotated 360 degrees to determine the position of the highest radiation.
- c. The height of the equipment or of the substitution antenna shall be 0.8 m; above 1GHz, the height was 1.5m, the height of the test antenna shall vary between 1 m to 4 m. Both horizontal and vertical polarizations of the antenna are set to make the measurement.
- d. The initial step in collecting conducted emission data is a spectrum analyzer peak detector mode pre-scanning the measurement frequency range. Significant peaks are then marked and then Quasi Peak detector mode re-measured.
- e. If the Peak Mode measured value compliance with and lower than Quasi Peak Mode Limit, the EUT shall be deemed to meet QP Limits and then no additional QP Mode measurement performed.
- f. For the actual test configuration, please refer to the related Item –EUT Test Photos.

Note:

Both horizontal and vertical antenna polarities were tested and performed pretest to three orthogonal axis. The worst case was X axis and the emissions were reported

### 3.2.3 TEST SETUP

(A) Radiated Emission Test-Up Frequency Below 30MHz

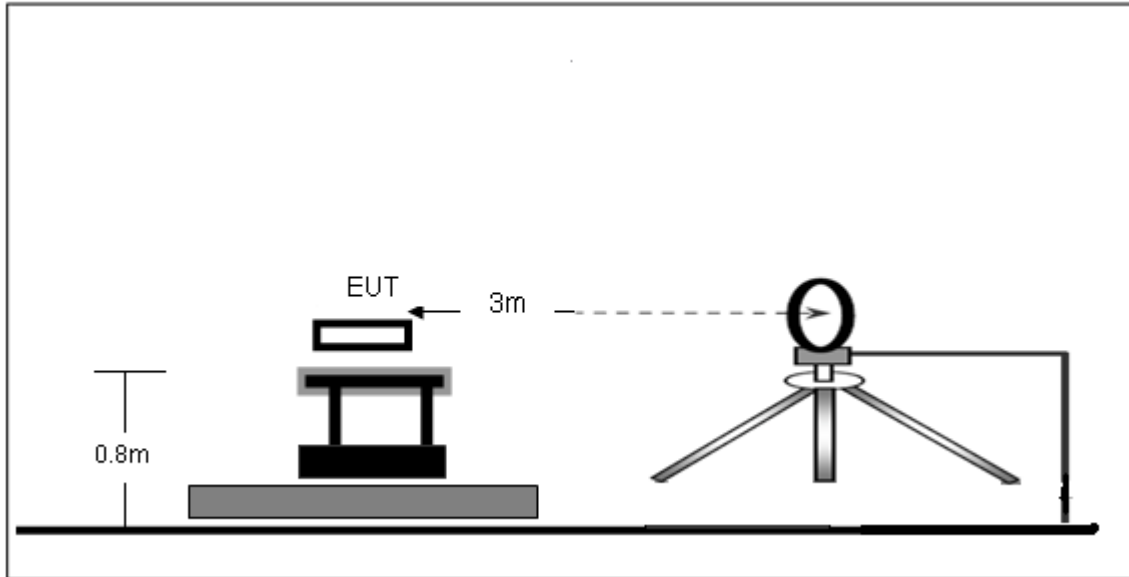

(B) Radiated Emission Test-Up Frequency 30MHz~1GHz

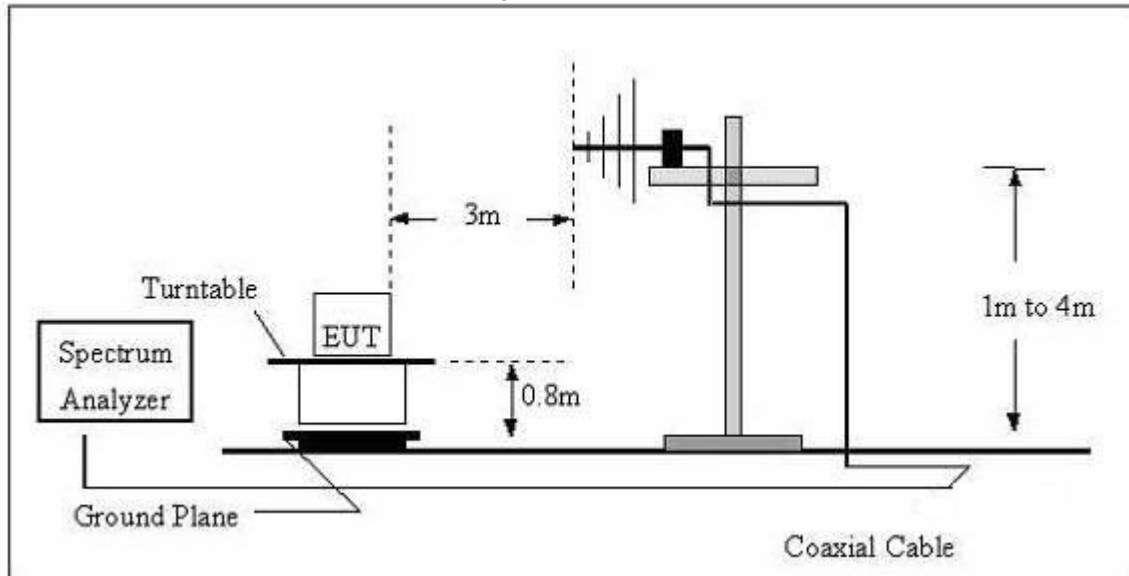



(C) Radiated Emission Test-Up Frequency Above 1GHz

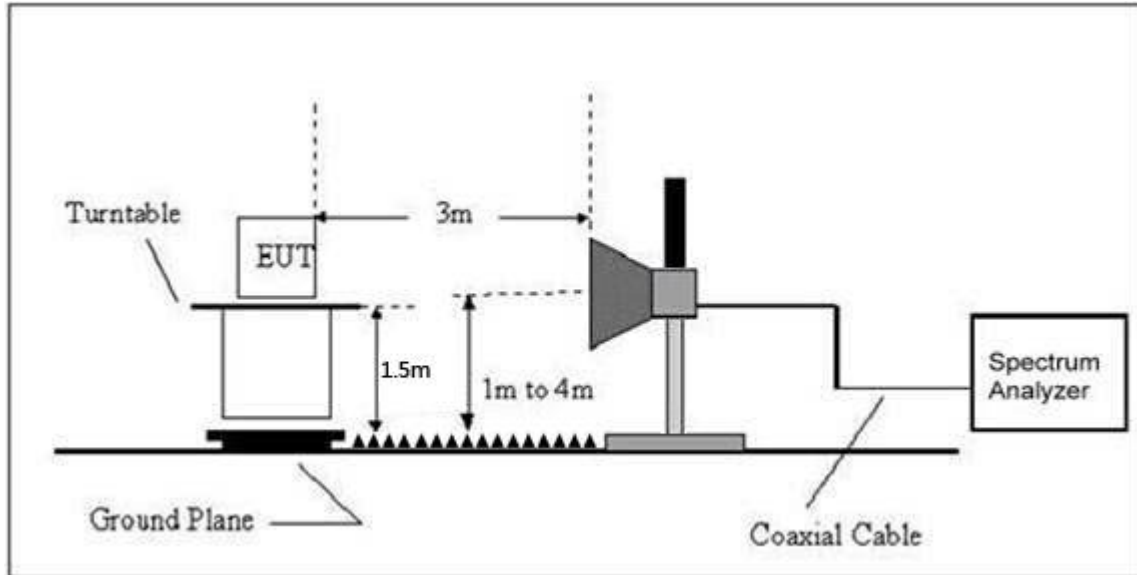

### 3.2.4 EUT OPERATING CONDITIONS

The EUT tested system was configured as the statements of 2.4 Unless otherwise a special operating condition is specified in the follows during the testing.

**3.2.5 TEST RESULTS (BETWEEN 9KHZ – 30 MHZ)**

Temperature :	26 °C	Relative Humidity :	54%
Pressure :	101 kPa	Polarization :	---
Test Voltage :	DC 3.7V		
Test Mode :	TX Mode		

Frequency (kHz)	Meter Reading (dBμV)	Factor (dB)	Emission Level (dBμV/m)	Limits (dBμV/m)	Margin (dB)	Detector Type
190.2400	32.56	20.65	53.21	82.02	-28.81	QP
450.3300	37.78	20.66	58.44	74.53	-16.09	QP
670.5800	30.44	20.75	51.19	71.08	-19.89	QP
760.3300	38.02	20.95	58.97	69.98	-11.01	QP
925.6500	35.01	21.43	56.44	68.28	-11.84	QP
1230.0000	22.15	22.86	45.01	65.81	-20.80	QP

**Note:**

Pre-scan in the all of mode, the worst case in of was recorded.

Factor = antenna factor + cable loss – pre-amplifier.

Margin = Emission Level- Limit.



Radiated Spurious Emission (Between 30MHz – 1GHz)

Temperature :	26 °C	Relative Humidity :	54%
Pressure :	101 kPa	Polarization :	Horizontal
Test Voltage :	DC 3.7V		
Test Mode :	TX Mode		

Frequency (MHz)	Meter Reading (dBμV)	Factor (dB)	Emission Level (dBμV/m)	Limits (dBμV/m)	Margin (dB)	Detector Type
38.8878	31.27	-15.11	16.16	40.00	-23.84	QP
53.6932	29.44	-14.56	14.88	40.00	-25.12	QP
106.3850	28.75	-15.68	13.07	43.50	-30.43	QP
169.5990	40.07	-18.60	21.47	43.50	-22.03	QP
360.4476	35.92	-12.18	23.74	46.00	-22.26	QP
433.9200	97.85	-10.82	87.03	100.80	-13.77	peak
504.7062	39.54	-9.23	30.31	46.00	-15.69	QP
867.8400	63.59	-3.40	60.19	80.80	-20.61	peak

Remark:

Factor = Antenna Factor + Correct Factor.  
 Correct Factor= Cable Loss – Pre-amplifier

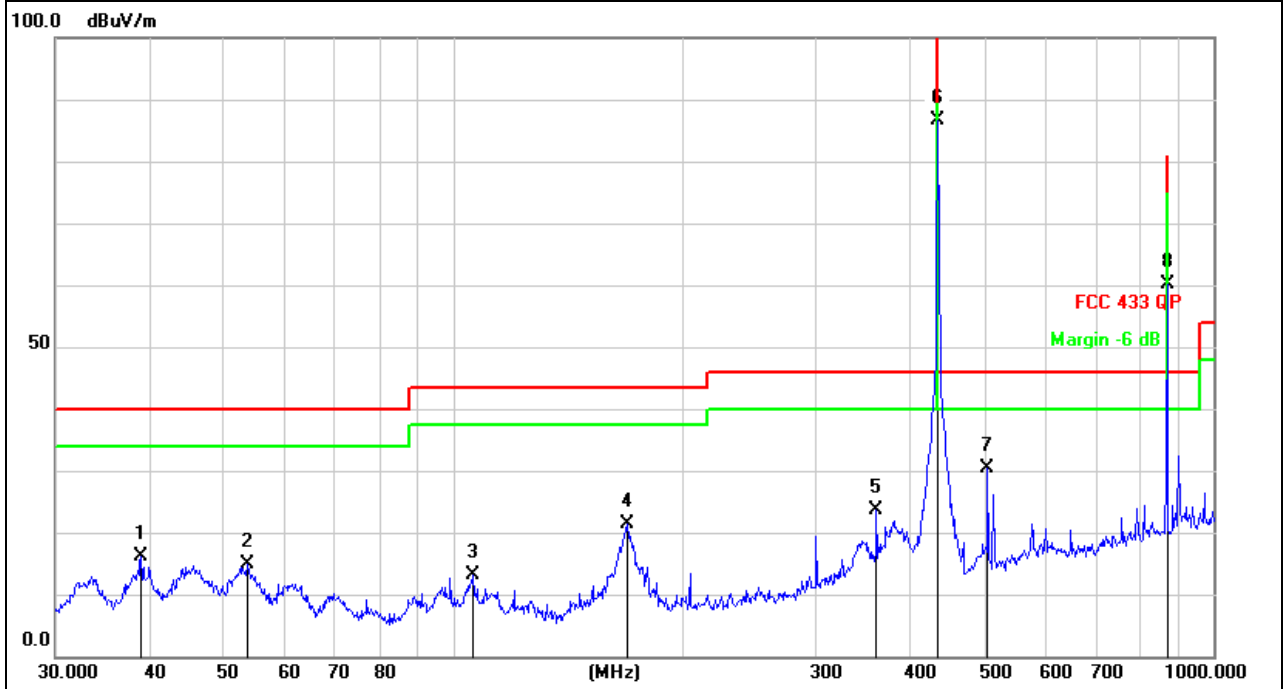



Temperature :	26 °C	Relative Humidity :	54%
Pressure :	101 kPa	Polarization :	Vertical
Test Voltage :	DC 3.7V		
Test Mode :	TX Mode		

Frequency (MHz)	Meter Reading (dBμV)	Factor (dB)	Emission Level (dBμV/m)	Limits (dBμV/m)	Margin (dB)	Detector Type
45.6948	28.08	-14.03	14.05	40.00	-25.95	QP
68.3907	30.23	-17.27	12.96	40.00	-27.04	QP
106.0126	27.48	-15.67	11.81	43.50	-31.69	QP
169.5989	37.66	-18.60	19.06	43.50	-24.44	QP
300.3672	28.34	-13.45	14.89	46.00	-31.11	QP
433.9200	95.36	-10.82	84.54	100.80	-16.26	peak
504.7062	41.95	-9.23	32.72	46.00	-13.28	QP
867.8400	50.11	-3.40	46.71	80.80	-34.09	peak

Remark:

Factor = Antenna Factor + Correct Factor.  
 Correct Factor= Cable Loss – Pre-amplifier

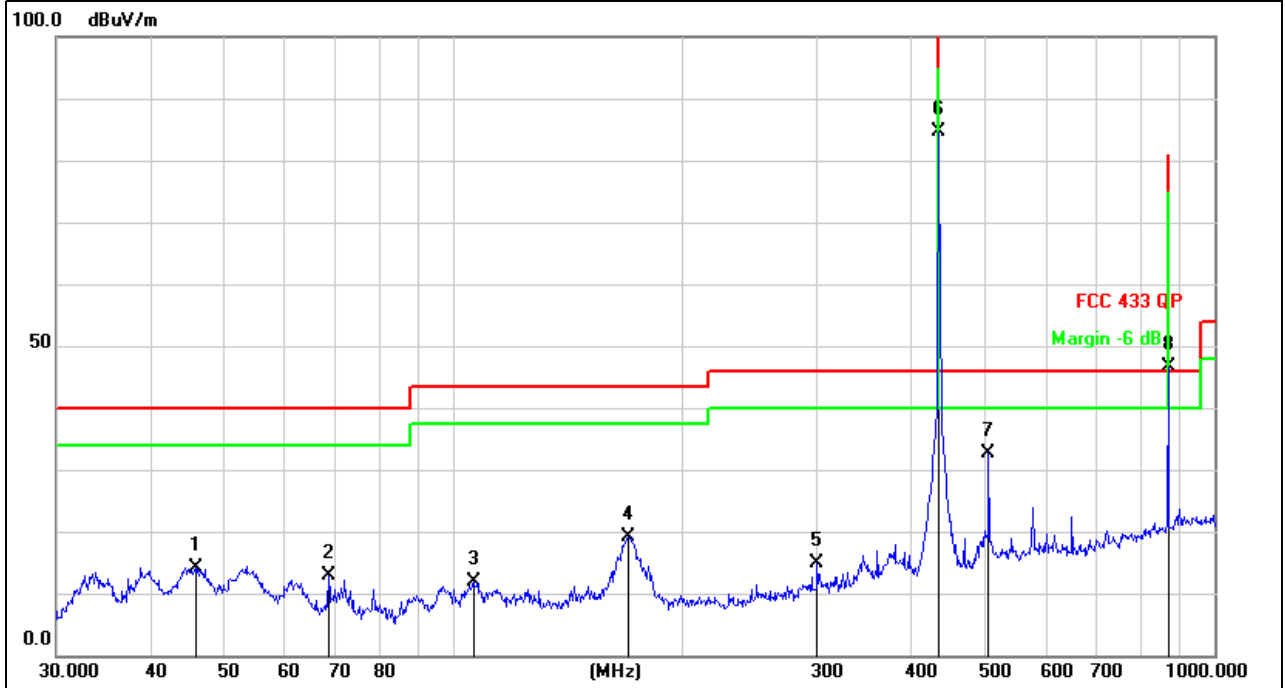



For average Emission

Frequency MHz	Peak Level dBuV/m	Duty cycle factor	AverageLevel dBuV/m	Limit AV	Margin	Polarization
433.92	87.03	-7.51	79.52	80.8	-1.28	Horizontal
867.84	60.19	-7.51	52.68	60.8	-8.12	Horizontal

Notes: 1. Average emission Level = Peak Level + Duty cycle factor  
2. Duty cycle level please see clause 5.

Frequency MHz	Peak Level dBuV/m	Duty cycle factor	AverageLevel dBuV/m	Limit AV	Margin	Polarization
433.92	84.54	-7.51	77.03	80.8	-3.77	Vertical
867.84	46.71	-7.51	39.2	60.8	-21.6	Vertical

Notes: 1. Average emission Level = Peak Level + Duty cycle factor  
2. Duty cycle level please see clause 5.



Radiated Spurious Emission ( 1GHz to 10<sup>th</sup> harmonics)

Frequency MHz	Peak Level dBuV/m	Duty cycle factor	Average Level dBuV/m	Limit		Margin dB		Polarization
				PK	AV	PK	AV	
1301.76	51.47	-7.51	43.96	80.8	60.8	-29.33	-16.84	Vertical
1735.68	52.21	-7.51	44.7	80.8	60.8	-28.59	-16.1	Vertical
2603.52	50.38	-7.51	42.87	80.8	60.8	-30.42	-17.93	Vertical
3037.44	50.53	-7.51	43.02	80.8	60.8	-30.27	-17.78	Vertical
3471.36	50.81	-7.51	43.3	80.8	60.8	-29.99	-17.5	Vertical
3905.28	47.95	-7.51	40.44	80.8	60.8	-32.85	-20.36	Vertical
1301.76	47.61	-7.51	40.1	80.8	60.8	-33.19	-20.7	Horizontal
1735.68	47.14	-7.51	39.63	80.8	60.8	-33.66	-21.17	Horizontal
2603.52	49.20	-7.51	41.69	80.8	60.8	-31.6	-19.11	Horizontal
3037.44	49.02	-7.51	41.51	80.8	60.8	-31.78	-19.29	Horizontal
3471.36	47.27	-7.51	39.76	80.8	60.8	-33.53	-21.04	Horizontal
3905.28	48.32	-7.51	40.81	80.8	60.8	-32.48	-19.99	Horizontal

Notes: 1.Average emission Level = Peak Level + Duty cycle factor

2.Duty cycle level please see clause 5.

3. Pulse Desensitization Correction Factor

Pulse Width (PW) = 54.75ms

$2/PW = 2/54.75ms = 0.037kHz$

RBW (100 kHz) > 2/PW (0.037kHz)

Therefore PDCF is not needed

4.Other harmonics emissions are lower than 20dB below the allowable limit.



CONDUCTED EMISSION MEASUREMENT

433.92MHz

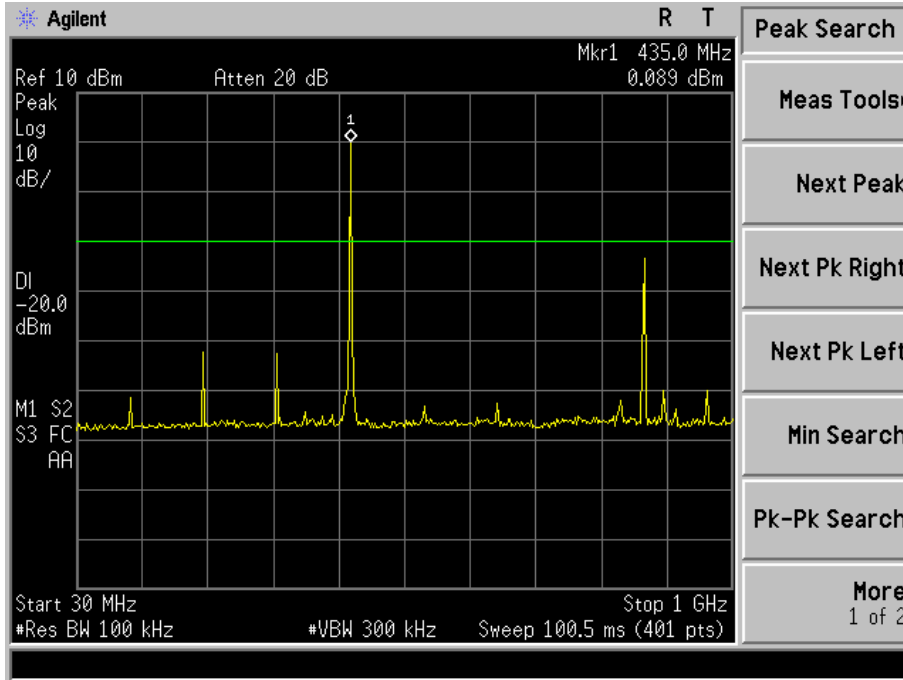

433.92MHz

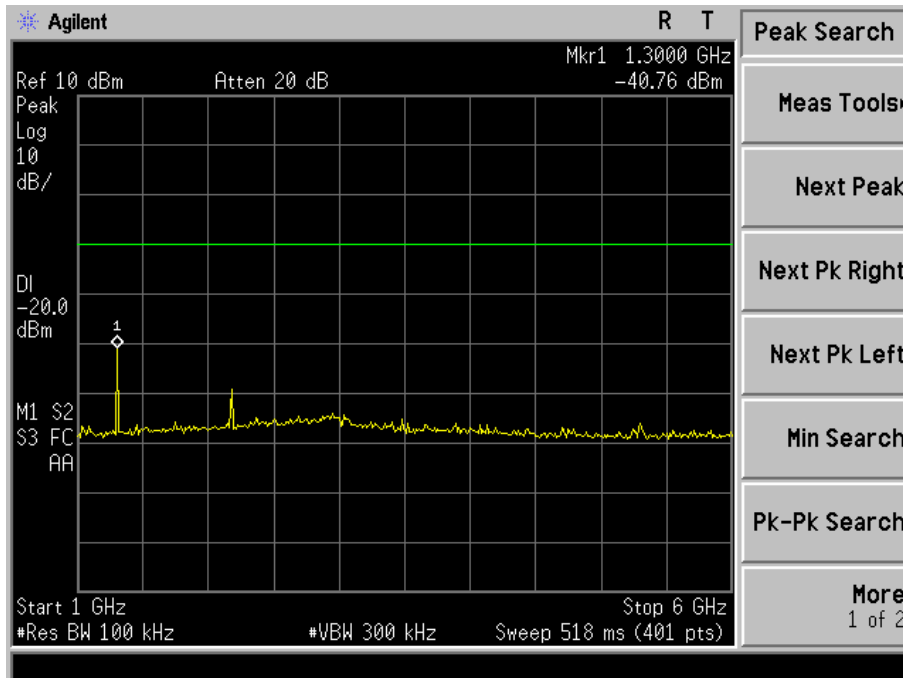



## 4. BANDWIDTH TEST

### 4.1 APPLIED PROCEDURES / LIMIT

According to FCC 15.231(c) requirement:

The bandwidth of the emission shall be no wider than 0.25% of the center frequency for devices operating between 70 MHz to 900 MHz. Those devices operating above 900 MHz, the emission spurious shall be no wider than 0.5% of the center frequency. Bandwidth is determined at the points 20 dB down from the modulated carrier.

B.W (20dBc) Limit =  $0.25\% * f(\text{MHz}) = 0.25\% * 433.92\text{MHz} = 1.0848\text{MHz}$

Spectrum Parameter	Setting
Attenuation	Auto
Span Frequency	> Measurement Bandwidth or Channel Separation
RB	30kHz
VB	$\geq$ RBW
Detector	Peak
Trace	Max Hold
Sweep Time	Auto

#### 4.1.1 TEST PROCEDURE

- The EUT was directly connected to the spectrum analyzer and antenna output port as show in the block diagram below,
- Spectrum Setting : RBW= 30kHz, VBW $\geq$  RBW, Sweep time = Auto.

#### 4.1.2 DEVIATION FROM STANDARD

No deviation.

#### 4.1.3 TEST SETUP



#### 4.1.4 EUT OPERATION CONDITIONS

The EUT tested system was configured as the statements of 2.4 Unless otherwise a special operating condition is specified in the follows during the testing.





**4.1.5 TEST RESULTS**

Temperature :	26 °C	Relative Humidity :	54%
Pressure :	101kPa	Test Voltage :	DC 3.7V
Test Mode :	TX Mode		

Frequency	20dB Bandwidth (kHz)	Limit (MHz)	Result
433.92MHz	137.693	1.0848	PASS

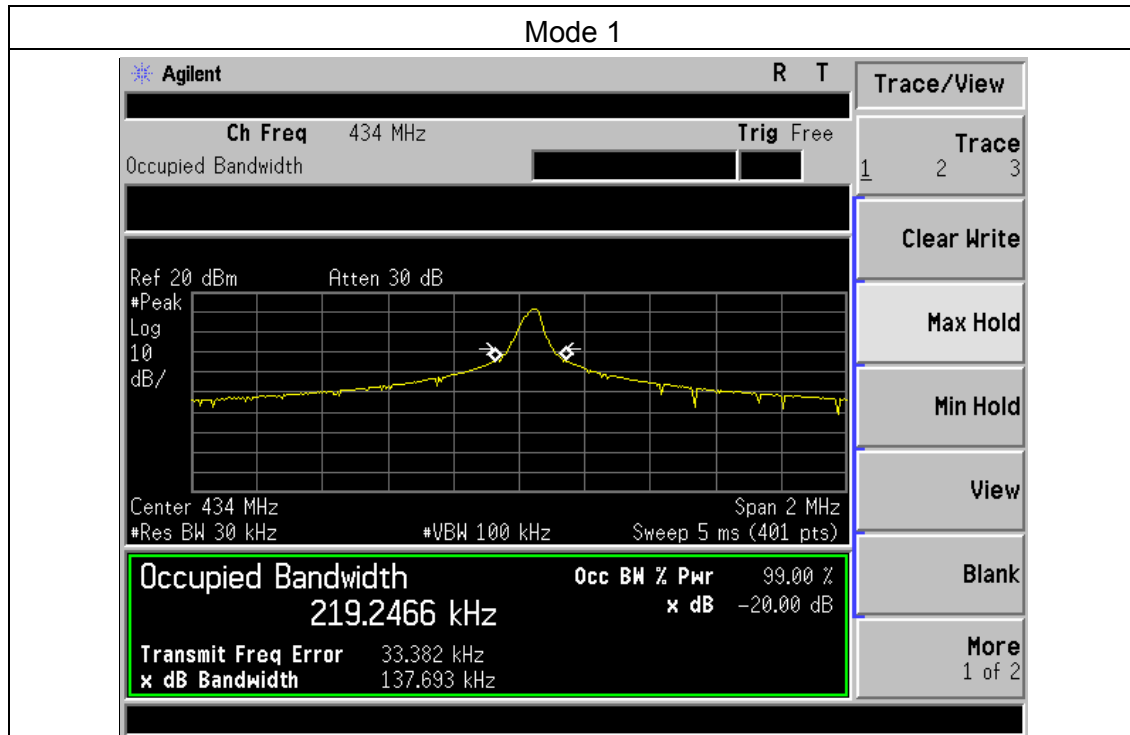



### 5. CALCULATION OF AVERAGE FACTOR

The output field strengths of specification in accordance with the FCC rules specify measurements with an average detector. During the test, a spectrum analyzer incorporating a peak detector was used. Therefore, a reduction factor can be applied to the resultant peak signal level and compared to the limit for measurement instrumentation incorporating an average detector.

The duty cycle is measured in 100 ms or the repetition cycle period, whichever is a shorter time frame. The duty cycle is measured by placing the spectrum analyzer to set zero span at 100kHz resolution bandwidth.

Averaging factor in dB = 20log (duty cycle)

The duration of one cycle = 54.75ms

The duty cycle is simply the on-time divided the duration of one cycle

$$\text{Duty Cycle} = (1.37\text{ms} \times 12 + 0.51\text{ms} \times 13) / 54.75$$

$$= 23.07\text{ms} / 54.75\text{ms}$$

$$= 0.421$$

Therefore, the averaging factor is found by  $20\log 0.421 = -7.51\text{dB}$

Test plot as follows:

Note: During the 100ms, the amount of pulse and on-time of pulse are the same for every pulse train.

Cycle

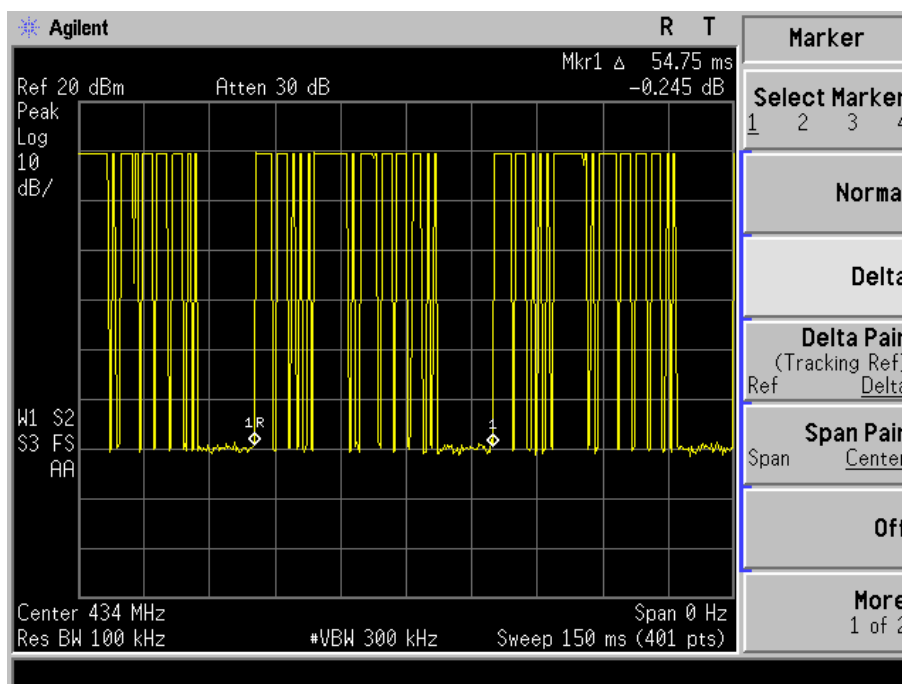



### Pulse

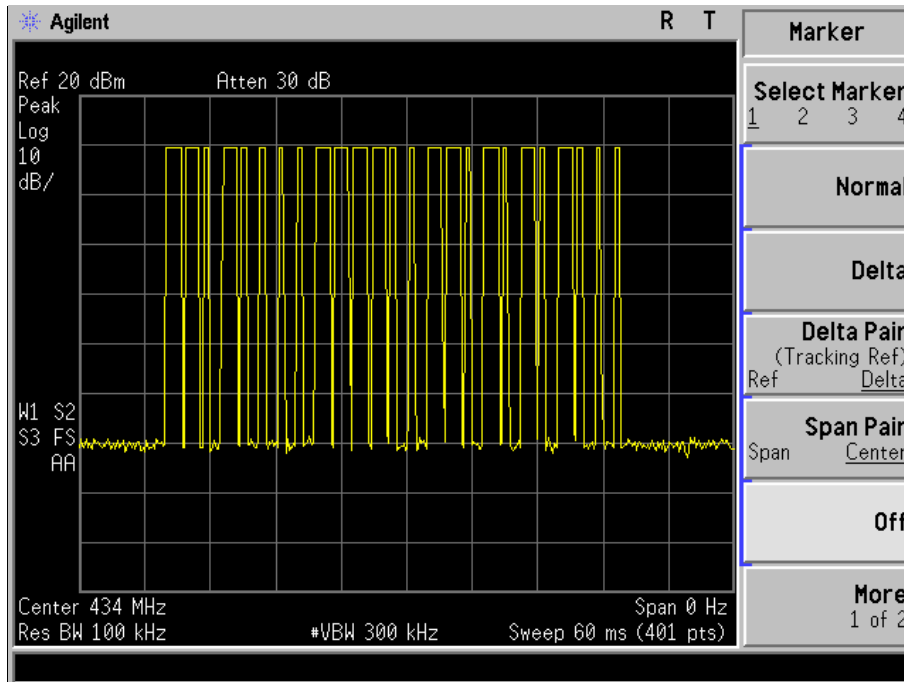

### On-time

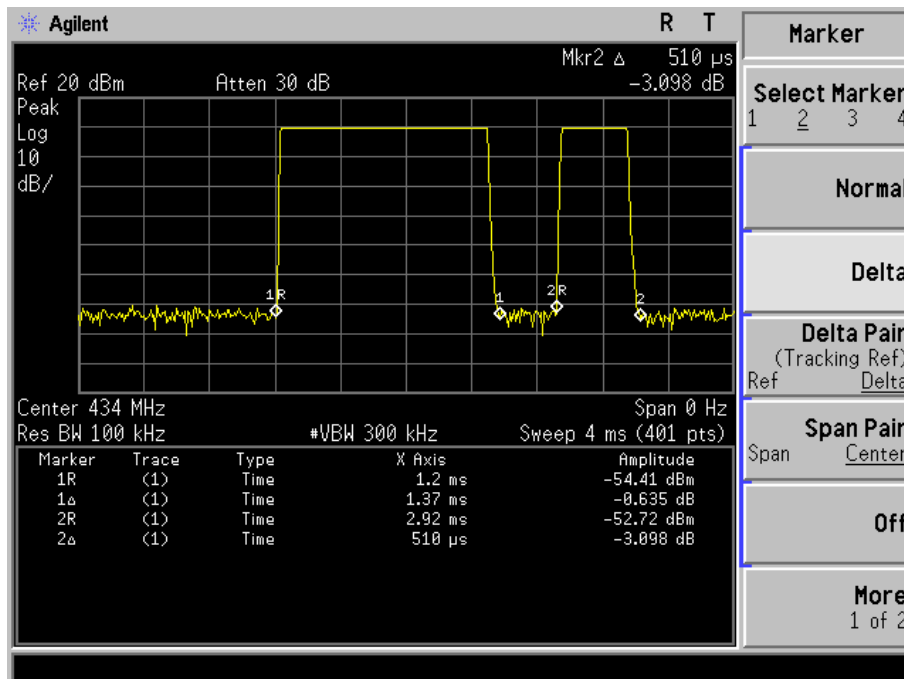

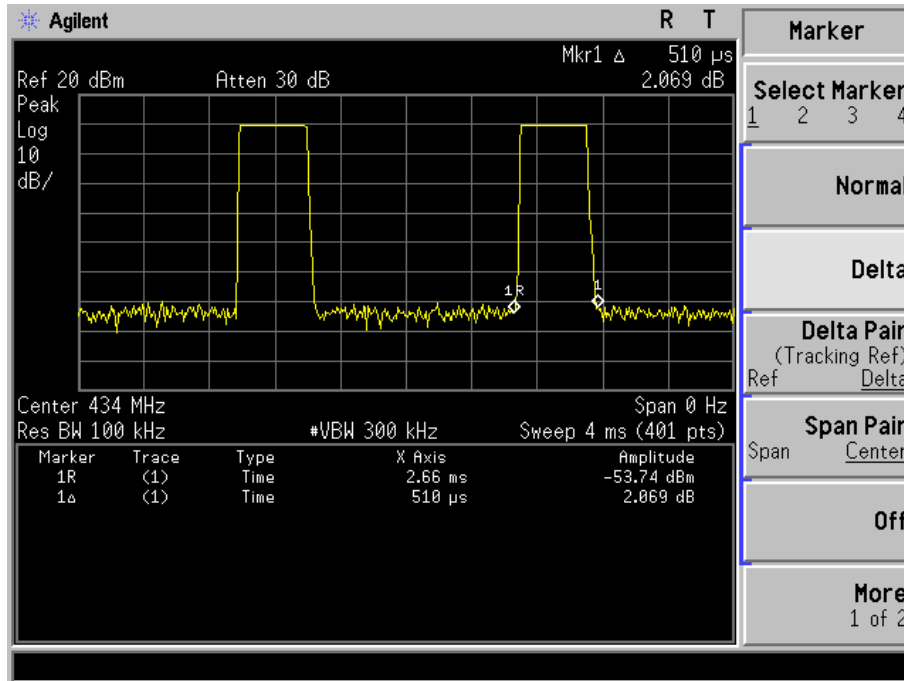



## 6. DWELL TIME

### APPLICABLE STANDARD

According to FCC 15.231(a) requirement:

A manually operated transmitter shall employ a switch that will automatically deactivate the transmitter within not more than 5 seconds of being released.

### TEST PROCEDURE

- a) Check the calibration of the measuring instrument using either an internal calibrator or a known signal from an external generator.
- b) Position the EUT without connection to measurement instrument. Turn on the EUT and connect its antenna terminal to measurement instrument via a low loss cable. Then set it to any one measured frequency within its operating range, and make sure the instrument is operated in its linear range.
- c) Set RBW to 100 kHz and VBW of spectrum analyzer to 300 kHz with a convenient frequency span including 100 kHz bandwidth from band edge.
- d) Measure the highest amplitude appearing on spectral display and set it as a reference level. Plot the graph with marking the highest point and edge frequency.
- e) Repeat above procedures until all measured frequencies were complete.

### 6.1 DEVIATION FROM STANDARD

No deviation.

### 6.2 TEST SETUP

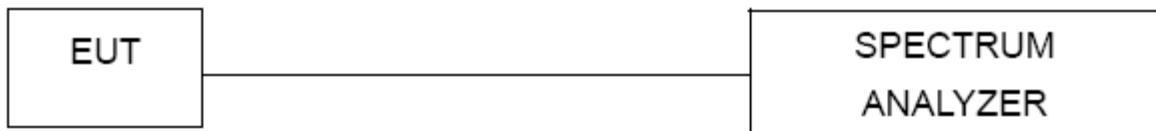

### 6.3 EUT OPERATION CONDITIONS

The EUT tested system was configured as the statements of 2.4 Unless otherwise a special operating condition is specified in the follows during the testing.



### 6.4 TEST RESULTS

Dwell time (second)	Limit (second)	Result
206.5ms	<5s	Pass

Test plot as follows:

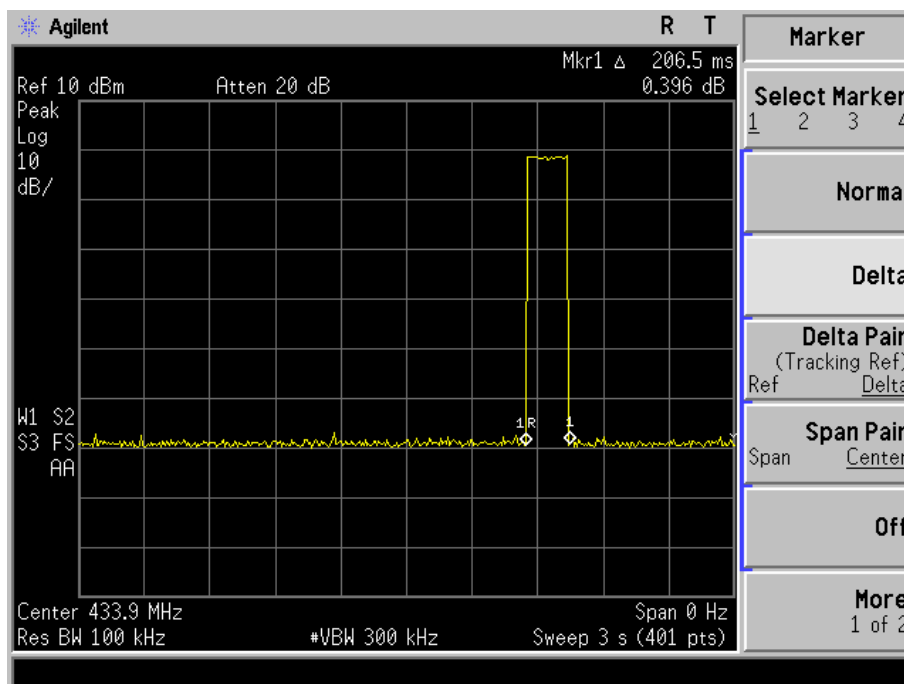



## **7. ANTENNA REQUIREMENT**

### **7.1 STANDARD REQUIREMENT**

15.203 requirement: For intentional device, according to 15.203: an intentional radiator shall be designed to ensure that no antenna other than that furnished by the responsible party shall be used with the device.

### **7.2 EUT ANTENNA**

The EUT antenna is the Spring antenna. It comply with the standard requirement.

## 8. EUT TEST PHOTO

### Conducted Measurement Photos



### Radiated Measurement Photos

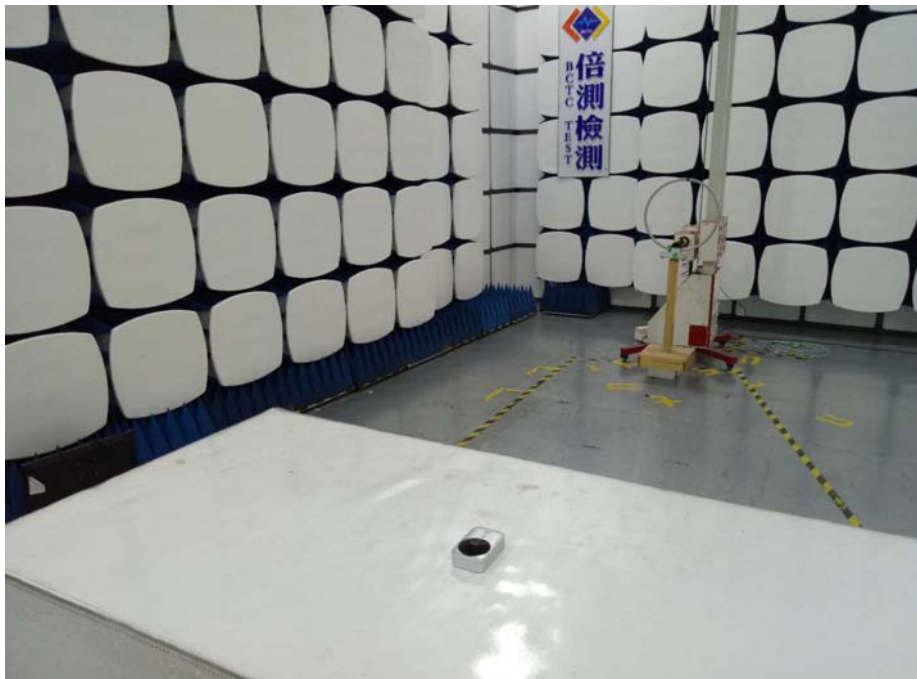



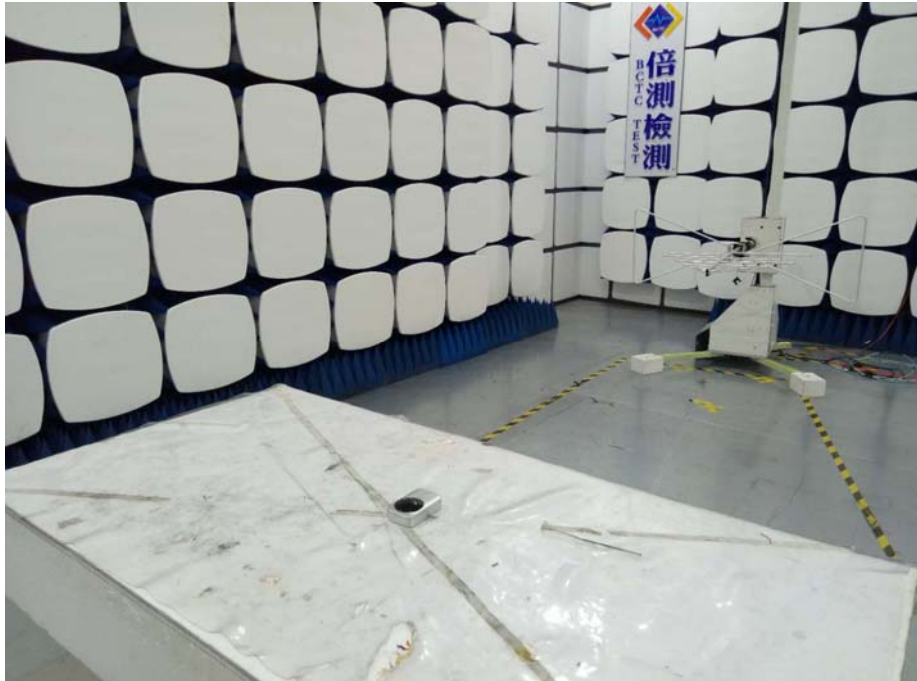

## 9. EUT PHOTO

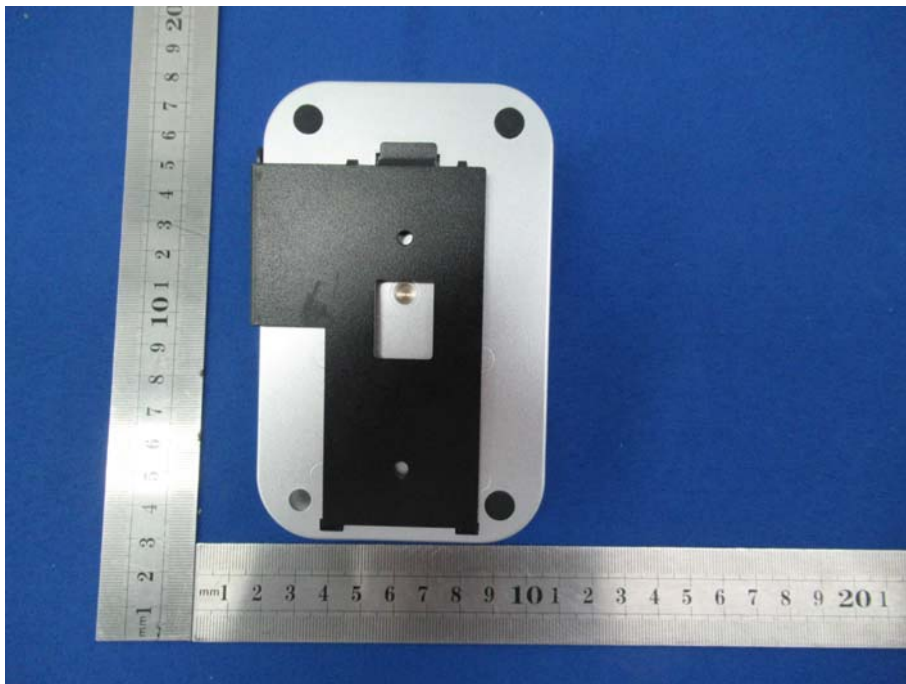

\*\*\*\*\* END OF REPORT \*\*\*\*\*