

PSREF

Product Specifications Reference

ThinkCentre

The ThinkCentre logo is positioned in the upper right area of the cover. It features the word "ThinkCentre" in a white, sans-serif font, with a small red dot above the letter "i". The background of the entire cover is a low-angle, upward-looking photograph of a modern building's glass facade, showing a grid of windows reflecting a cloudy sky.

Version 583
September 22, 2021

The Lenovo logo is located in the bottom right corner. It consists of the word "Lenovo" in a white, sans-serif font, oriented vertically within a blue rectangular background.

Contents

Cover	1
Contents	2
Summary Of Change	4
All-In-One	5
ThinkCentre M70a	5
ThinkCentre M70a Gen 2	14
ThinkCentre M90a	22
ThinkCentre M90a Gen 2	31
Nano Desktops	40
ThinkCentre M75n	40
ThinkCentre M75n IoT	47
ThinkCentre M75n Thin Client	54
ThinkCentre M90n-1 Nano	61
ThinkCentre M90n-1 Nano IoT	68
SFF Desktops	76
ThinkCentre M70c	76
ThinkCentre M70s	84
ThinkCentre M720 SFF	92
ThinkCentre M75s Gen 2	100
ThinkCentre M80s	109
ThinkCentre M90s	117
ThinkCentre M920 SFF	125
Tiny Desktops	134
ThinkCentre M60e	134
ThinkCentre M625 Tiny Thin Client	141
ThinkCentre M630e Tiny	148
ThinkCentre M70q	155
ThinkCentre M70q Gen 2	163
ThinkCentre M720 Tiny	171
ThinkCentre M75q Gen 2	180
ThinkCentre M75q Tiny	188
ThinkCentre M80q	196
ThinkCentre M90q	204
ThinkCentre M90q Gen 2	213
ThinkCentre M920 Tiny	221
ThinkSmart Edition Tiny M80q	230
ThinkSmart Edition Tiny M920q for Logitech	237
ThinkSmart Edition Tiny M920q for Poly	244
ThinkSmart Edition Tiny M920q for Zoom Rooms	251
Tiny-In-One	258
ThinkCentre Tiny-In-One 22 Gen 3	258
ThinkCentre Tiny-In-One 22 Gen 4	262
ThinkCentre Tiny-In-One 24 Gen 3	266
ThinkCentre Tiny-In-One 24 Gen 4	270
ThinkCentre Tiny-In-One 27	274
Tower Desktops	278
ThinkCentre M70t	278
ThinkCentre M720 Tower	286
ThinkCentre M75t Gen 2	295
ThinkCentre M80t	304
ThinkCentre M90t	312

Contents

ThinkCentre M920 Tower
Legal Information

320
329

Summary of Changes

This section describes the technical changes made in this edition.

This edition might also include minor corrections and editorial changes which are not identified.

September 2021 - Version 583

Additions in this update

▶ **New product(s)**

ThinkCentre M70a Gen 2

ThinkCentre M90a Gen 2

▶ **New model(s)**

None

▶ **Others**

None

Withdrawals in this update

▶ **Withdrawn product(s)**

None

▶ **Withdrawn model(s)**

None

OVERVIEW

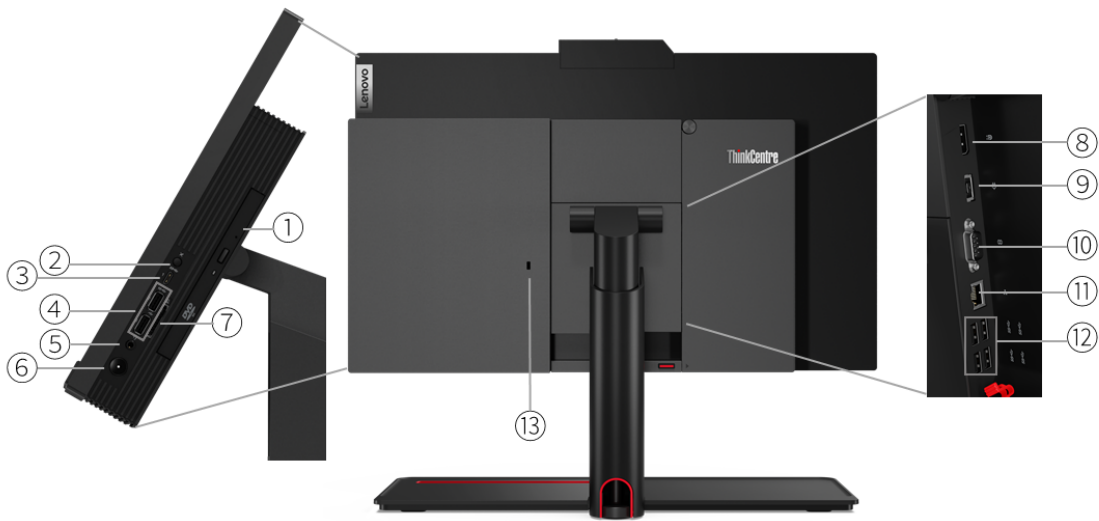

1. Optical drive *	8. DisplayPort
2. Microphone mute button	9. Power connector
3. USB-C 3.2 Gen 1	10. Serial *
4. 1x USB 3.2 Gen 2 + 1x USB 3.2 Gen 1	11. Ethernet (RJ-45)
5. Headphone / microphone combo jack (3.5mm)	12. 4x USB 3.2 Gen 1
6. Power button	13. Kensington Security Slot
7. Card reader *	

Notes:

- Ports with * are only available on selected models

PERFORMANCE

Processor

Processor Family

Intel® Celeron®, Intel Pentium®, or 10th Generation Intel Core™ i3 / i5 / i7 / i9 Processor

Processor**

Processor Name	Cores	Threads	Base Frequency	Max Frequency	Cache	Memory Support	Processor Graphics
Celeron G5900	2	2	3.4GHz	-	2MB	DDR4-2666	Intel UHD Graphics 610
Celeron G5905	2	2	3.5GHz	-	4MB	DDR4-2666	Intel UHD Graphics 610
Celeron G5920	2	2	3.5GHz	-	2MB	DDR4-2666	Intel UHD Graphics 610
Celeron G5925	2	2	3.6GHz	-	4MB	DDR4-2666	Intel UHD Graphics 610
Pentium Gold G6400	2	4	4.0GHz	-	4MB	DDR4-2666	Intel UHD Graphics 610
Pentium Gold G6500	2	4	4.1GHz	-	4MB	DDR4-2666	Intel UHD Graphics 630
Pentium Gold G6600	2	4	4.2GHz	-	4MB	DDR4-2666	Intel UHD Graphics 630
Core i3-10100	4	8	3.6GHz	4.3GHz	6MB	DDR4-2666	Intel UHD Graphics 630
Core i3-10300	4	8	3.7GHz	4.4GHz	8MB	DDR4-2666	Intel UHD Graphics 630
Core i3-10320	4	8	3.8GHz	4.6GHz	8MB	DDR4-2666	Intel UHD Graphics 630
Core i5-10400	6	12	2.9GHz	4.3GHz	12MB	DDR4-2666	Intel UHD Graphics 630
Core i5-10500	6	12	3.1GHz	4.5GHz	12MB	DDR4-2666	Intel UHD Graphics 630
Core i5-10600	6	12	3.3GHz	4.8GHz	12MB	DDR4-2666	Intel UHD Graphics 630
Core i7-10700	8	16	2.9GHz	4.8GHz	16MB	DDR4-2933	Intel UHD Graphics 630
Core i9-10900	10	20	2.8GHz	5.2GHz	20MB	DDR4-2933	Intel UHD Graphics 630

Operating System

Operating System**

- Windows® 10 Pro 64
- Windows 10 Home 64
- Windows 10 IoT Enterprise
- Ubuntu Linux
- No operating system

Graphics

Graphics**[1]

Graphics	Type	Memory	Connector	Max Resolution	Key Features
Intel UHD graphics 630	Integrated	Shared	1x DP 1.2	4096x2304@60Hz(DP)	DirectX® 12
Intel UHD graphics 610	Integrated	Shared	1x DP 1.2	4096x2304@60Hz(DP)	DirectX 12

Notes:

1. The information of integrated graphics are not applicable for the models without integrated graphics (for the details, please refer to processor section)

Monitor Support

Monitor Support

Supports up to 2 independent displays via native display and 1 external monitor; supports external monitor via DisplayPort™

Chipset

Chipset

Intel H470 chipset

Memory

Max Memory^[1]

Up to 64GB DDR4-2933

Memory Slots

Two DDR4 SO-DIMM slots, dual-channel capable

Memory Type^{}**

- DDR4-2666
- DDR4-2933

Notes:

1. The max memory is based on the test results with current Lenovo® memory offerings. The system may support more memory as the technology develops.

Storage**Storage Support**

Up to two drives, 1x 2.5" HDD + 1x M.2 SSD

- 2.5" HDD up to 2TB
- M.2 SSD up to 1TB
- Optional Intel Optane™ Memory, M.2

Storage Type^{*}**

Disk Type	Interface	RPM	Security
2.5" SATA HDD	SATA 6Gb/s	5.4K	-
2.5" SATA HDD	SATA 6Gb/s	7.2K	-
M.2 2242 SSD	PCIe NVMe, PCIe 3.0 x2	-	-
M.2 2242 SSD	PCIe NVMe, PCIe 3.0 x4	-	-
M.2 2280 SSD	PCIe NVMe, PCIe 3.0 x4	-	Opal
M.2 2280 SSD	PCIe NVMe, PCIe 3.0 x4	-	-
Intel Optane Memory M10	PCIe NVMe, PCIe 3.0 x2	-	-

RAID

No support

Removable Storage**Optical^{**}**

- DVD-ROM, SATA 1.5Gb/s, slim (9.0mm)
- DVD burner (DVD±RW), SATA 1.5Gb/s, slim (9.0mm)
- None

Card Reader

- 3-in-1 card reader
- No card reader

Multi-Media**Audio Chip**

High Definition (HD) Audio, Realtek® ALC233 codec

Speakers

Stereo speakers, 2W x2

Microphone

Dual array microphone

Camera^{}**

- 1080p, with ThinkShutter (physical switch on/off)
- IR & 1080p, with ThinkShutter (physical switch on/off), Windows Hello support
- No camera

Power Supply

Power Supply**

Power	Type	Efficiency	Key Features
135W	Adapter	89%	Autosensing
170W	Adapter	89%	Autosensing

DESIGN**Display****Display**[2]**

Size	Resolution	Touch	Type	Brightness	Surface	Aspect Ratio	Contrast Ratio	Color Gamut	Viewing Angle	Key Features
21.5"	FHD (1920x1080)	None	IPS	250 nits	Anti-glare	16:9	1000:1	-	horizontal: +/- 89°, vertical: +/- 89°	Borderless design (88% screen to body ratio)
21.5"	FHD (1920x1080)	Multi-touch	IPS	250 nits	Anti-glare	16:9	1000:1	-	horizontal: +/- 89°, vertical: +/- 89°	Borderless design (88% screen to body ratio)

Touchscreen

- Advanced In-cell Touch (AIT), supports 10-point touch
- Non-touch

Notes:

- California Electronic Waste Recycling Fee
In California, per state law, Lenovo charges an electronic waste recycling fee on this covered device at the time of sale of the product. For more information, go to <https://www.calrecycle.ca.gov/Electronics/Consumer>
- IPS (in-plane switching) technology may refer to IPS, PLS, ADS, AHVA, AAS

Input Device**Keyboard****

- Lenovo Calliope Keyboard (USB connector), black
- Lenovo Calliope Wireless Keyboard (2.4GHz via USB receiver), black
- Lenovo Traditional Keyboard (USB connector), black
- No keyboard

Mouse**

- Lenovo Calliope Mouse (USB connector), black
- Lenovo Calliope Wireless Mouse (2.4GHz via USB receiver), black
- Lenovo Fingerprint Mouse (USB connector), Windows Hello support, black
- No mouse

Mechanical**Buttons**

- Power button
- Microphone mute button

Form Factor

AIO (21.5 inches)

Dimensions (WxDxH)

Models	Dimensions
Models (with full function monitor stand, with camera)	490.14 x 199.82 x 386.05-466.04 mm (19.3 x 7.9 x 15.2-18.3 inches)
Models (with UltraFlex IV stand, with camera)	Lowest in flat mode: 490.17 x 288.17 x 197.04 mm (19.3 x 11.3 x 7.8 inches) Highest in vertical mode: 490.17 x 232.75 x 439.28 mm (19.3 x 9.2 x 17.3 inches)

Models (without stand, with ODD, with Camera)	490.14 x 57.8 x 297.75 mm (19.3 x 2.3 x 11.7 inches)
Models (without stand, without ODD, with camera)	490.14 x 46 x 297.75 mm (19.3 x 1.8 x 11.7 inches)

Weight

Models	Weight
Models (with full function monitor stand, with ODD)	Non-touch: 7.33 kg (16.2 lbs) Touch: 7.09 kg (15.6 lbs)
Models (with full function monitor stand, without ODD)	Non-touch: 7.07 kg (15.6 lbs) Touch: 6.83 kg (15.1 lbs)
Models (with UltraFlex IV stand, with ODD)	Non-touch: 7.88 kg (17.4 lbs) Touch: 7.65 kg (16.9 lbs)
Models (with UltraFlex IV stand, without ODD)	Non-touch: 7.62 kg (16.8 lbs) Touch: 7.38 kg (16.3 lbs)
Models (without stand, with ODD)	Non-touch: 5.12 kg (11.3 lbs) Touch: 4.88 kg (10.8 lbs)
Models (without stand, without ODD)	Non-touch: 4.86 kg (10.7 lbs) Touch: 4.62 kg (10.2 lbs)

Case Color

Black

Bays

- 1x 2.5" disk bay
- 1x slim ODD bay

Expansion Slots

Two M.2 slots (one for WLAN, one for SSD)

EOU

Toolless cover and stand assembly / removal

Stand**

- Full function monitor stand, supports -5° to +30° tilt, up to 80mm lift
- UltraFlex IV stand, supports -5° to +70° tilt, up to 164mm lift (flat mode) / up to 115mm lift (vertical mode)
- No stand

Mounting

Supports VESA mount 100mm

CONNECTIVITY**Network****Onboard Ethernet**

One gigabit Ethernet, Realtek RTL8111K, 1x RJ-45, supports Wake-on-LAN

Optional Ethernet

No optional Ethernet

WLAN + Bluetooth®**

- Realtek RTL8822CE, 802.11ac Dual Band 2x2 Wi-Fi® + Bluetooth 5.0, M.2 card
- Realtek RTL8822BE, 802.11ac Dual Band 1x1 Wi-Fi + Bluetooth 5.0, M.2 card
- Intel Wireless-AC 9462, 802.11ac Dual Band 1x1 Wi-Fi + Bluetooth 5.0, M.2 card
- Intel Wireless-AC 9560, 802.11ac Dual Band 2x2 Wi-Fi + Bluetooth 5.0, M.2 card
- Intel Wi-Fi 6 AX201, 802.11ax 2x2 Wi-Fi + Bluetooth 5.1, M.2 Card
- No WLAN and Bluetooth

Ports^[1]**Rear Ports^[2]**

- 4x USB 3.2 Gen 1 (one supports Smart Power On)
- 1x DisplayPort

- 1x Ethernet (RJ-45)

Optional Rear Ports

1x serial

Right Ports

- 1x USB 3.2 Gen 1
- 1x USB 3.2 Gen 2
- 1x USB-C 3.2 Gen 1 (5V/3A charging)
- 1x headphone / microphone combo jack (3.5mm)

Optional Right Ports

1x card reader

Notes:

1. The transfer speed of following ports will vary and, depending on many factors, such as the processing speed of the host device, file attributes and other factors related to system configuration and your operating environment, will be slower than theoretical speed.
USB 2.0: 480 Mbit/s;
USB 3.2 Gen 1 (SuperSpeed USB 5Gbps, formerly USB 3.0 / USB 3.1 Gen 1): 5 Gbit/s;
USB 3.2 Gen 2 (SuperSpeed USB 10Gbps, formerly USB 3.1 Gen 2): 10 Gbit/s;
USB 3.2 Gen 2x2 (SuperSpeed USB 20Gbps): 20 Gbit/s;
Thunderbolt™ 3: 40 Gbit/s;
FireWire 400: 400 Mbit/s;
FireWire 800: 800 Mbit/s
2. For video ports on discrete graphics, please see graphics section

Monitor Cable**Monitor Cable*****

- DP to dual DP dongle
- DP to DVI-D dongle
- DP to HDMI® 1.4 dongle
- DP to VGA dongle
- No monitor cable

SECURITY & PRIVACY**Security****Security Chip**

Discrete TPM 2.0, TCG certified

Physical Locks

Kensington® Security Slot

Chassis Intrusion Switch

- Chassis intrusion switch
- No chassis intrusion switch

Fingerprint Reader

- Touch style fingerprint reader on mouse
- No fingerprint reader

Other Security

(Optional) ThinkShutter camera cover

BIOS Security

- Administrator password
- Power-on password
- Hard disk password
- Boot sequence control
- Boot without keyboard and mouse
- Self-healing BIOS
- Smart USB protection (allows keyboard / mouse only, blocks all storage devices)
- Individual USB port disablement

MANAGEABILITY

System Management

System Management

None

SERVICE

Warranty

Base Warranty**

- 1-year depot service
- 1-year limited onsite service
- 3-year limited onsite service
- No base warranty

ENVIRONMENTAL

Operating Environment

Temperature

- Operating: 5°C (41°F) to 35°C (95°F)
- Storage: -20°C (-4°F) to 60°C (140°F)

Humidity

Operating: 20% to 80%

Altitude

- Operating: -15.2 m (-50 ft) to 3048 m (10,000 ft)
- Storage: -15.2 m (-50 ft) to 12192 m (40,000 ft)

CERTIFICATIONS

Green Certifications

Green Certifications

- EPEAT™ Silver
- ENERGY STAR® 8.0
- ErP Lot 3
- TCO Certified 8.0
- TCO edge
- RoHS compliant

Other Certifications

Other Certifications

- (Optional) TÜV Rheinland® Low Noise
- (Optional) TÜV Rheinland Ultra Low Noise

Mil-Spec Test

MIL-STD-810H military test passed (Low Pressure [Altitude], High Temperature, Low Temperature, Temperature Shock, Humidity, Sand and Dust, Vibration, Shock, Fungus, Solar Radiation)

- Feature with ** means that only one offering listed under the feature is configured on selected models.
- Feature with *** means that one or more offerings listed under the feature could be configured on selected models.
- Lenovo reserves the right to change specifications or other product information without notice. Lenovo is not responsible for photographic or typographical errors. LENOVO PROVIDES THIS PUBLICATION "AS IS,"

WITHOUT WARRANTY OF ANY KIND, EITHER EXPRESS OR IMPLIED, INCLUDING THE IMPLIED WARRANTIES OF MERCHANTABILITY OR FITNESS FOR A PARTICULAR PURPOSE. Some jurisdictions do not allow disclaimer of express or implied warranties in certain transactions, therefore this disclaimer may not apply to you.

- The specifications on this page may not be available in all regions, and may be changed or updated without notice.



OVERVIEW

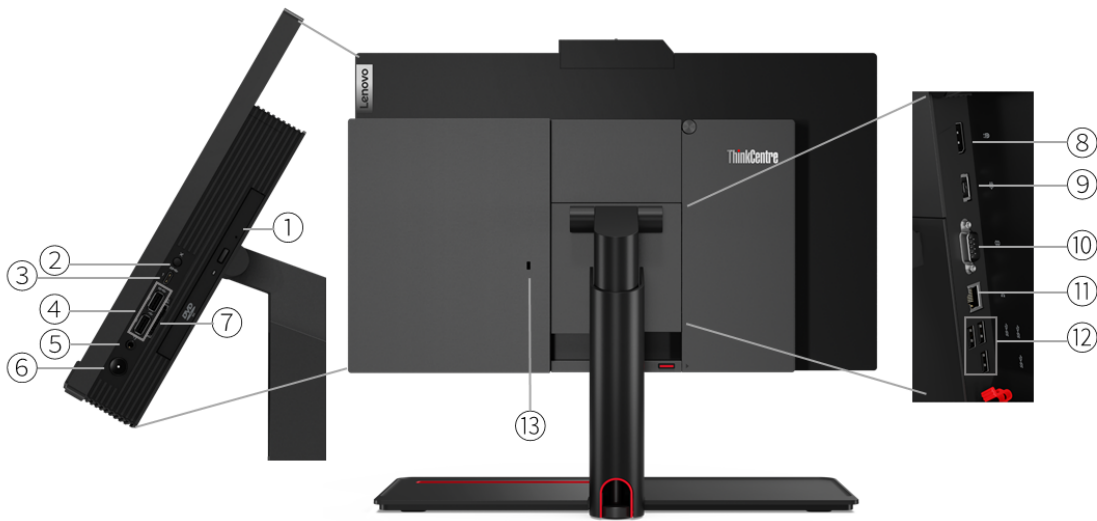

1. Optical drive *	8. DisplayPort
2. Microphone mute button	9. Power connector
3. USB-C 3.2 Gen 2	10. Serial or HDMI *
4. 1x USB 3.2 Gen 2 + 1x USB 3.2 Gen 1	11. Ethernet (RJ-45)
5. Headphone / microphone combo jack (3.5mm)	12. 3x USB 3.2 Gen 1
6. Power button	13. Kensington Security Slot
7. Card reader *	

Notes:

- Ports with * are only available on selected models

PERFORMANCE

Processor

Processor Family

Intel® Celeron®, Intel Pentium®, 10th Generation Intel Core™ i3, or 11th Generation Intel Core i5 / i7 / i9 Processor

Processor**

Processor Name	Cores	Threads	Base Frequency	Max Frequency	Cache	Memory Support	Processor Graphics
Celeron G5905	2	2	3.5GHz	-	4MB	DDR4-2666	Intel UHD Graphics 610
Celeron G5925	2	2	3.6GHz	-	4MB	DDR4-2666	Intel UHD Graphics 610
Pentium Gold G6405	2	4	4.1GHz	-	4MB	DDR4-2666	Intel UHD Graphics 610
Pentium Gold G6505	2	4	4.2GHz	-	4MB	DDR4-2666	Intel UHD Graphics 630
Pentium Gold G6605	2	4	4.3GHz	-	4MB	DDR4-2666	Intel UHD Graphics 630
Core i3-10105	4	8	3.7GHz	4.4GHz	6MB	DDR4-2666	Intel UHD Graphics 630
Core i3-10305	4	8	3.8GHz	4.5GHz	8MB	DDR4-2666	Intel UHD Graphics 630
Core i3-10325	4	8	3.9GHz	4.7GHz	8MB	DDR4-2666	Intel UHD Graphics 630
Core i5-11400	6	12	2.6GHz	4.4GHz	12MB	DDR4-3200	Intel UHD Graphics 730
Core i5-11500	6	12	2.7GHz	4.6GHz	12MB	DDR4-3200	Intel UHD Graphics 750
Core i5-11600	6	12	2.8GHz	4.8GHz	12MB	DDR4-3200	Intel UHD Graphics 750
Core i7-11700	8	16	2.5GHz	4.9GHz	16MB	DDR4-3200	Intel UHD Graphics 750
Core i9-11900	8	16	2.5GHz	5.2GHz	16MB	DDR4-3200	Intel UHD Graphics 750

Operating System

Operating System**

- Windows® 10 Pro 64
- Windows 10 Home 64
- Windows 10 IoT Enterprise
- Ubuntu Linux
- No operating system

Graphics

Graphics**[1]

Graphics	Type	Memory	Connector	Max Resolution	Key Features
Intel UHD graphics 730	Integrated	Shared	1x DP 1.4b, 1x optional HDMI® 2.1	4096x2304@60Hz(DP), 4096x2160@60Hz(HDMI)	DirectX® 12
Intel UHD graphics 750	Integrated	Shared	1x DP 1.4b, 1x optional HDMI 2.1	4096x2304@60Hz(DP), 4096x2160@60Hz(HDMI)	DirectX 12
Intel UHD graphics 630	Integrated	Shared	1x DP 1.4b, 1x optional HDMI 2.1	4096x2304@60Hz(DP), 4096x2160@60Hz(HDMI)	DirectX 12
Intel UHD graphics 610	Integrated	Shared	1x DP 1.4b, 1x optional HDMI 2.1	4096x2304@60Hz(DP), 4096x2160@60Hz(HDMI)	DirectX 12

Notes:

1. The information of integrated graphics are not applicable for the models without integrated graphics (for the details, please refer to processor section)

Monitor Support

Monitor Support

Supports up to 3 independent displays via native display and 2 external monitor; supports external monitors via DisplayPort™ and optional HDMI

Chipset

Chipset

Intel B560 chipset

Memory

Max Memory^[1]

Up to 64GB DDR4-3200

Memory Slots

Two DDR4 SO-DIMM slots, dual-channel capable

Memory Type^{**[2]}

- DDR4-2666
- DDR4-3200

Notes:

1. The max memory is based on the test results with current Lenovo® memory offerings. The system may support more memory as the technology develops.
2. Installed memory is actually 3200MHz, but may run at 2666MHz, 2933 MHz or 3200MHz depending on the memory support capability of processor

Storage

Storage Support

Up to two drives, 1x 2.5" HDD + 1x M.2 SSD

- 2.5" HDD up to 2TB
- M.2 SSD up to 1TB

Storage Type^{***}

Disk Type	Interface	RPM	Security
2.5" SATA HDD	SATA 6Gb/s	5.4K	-
2.5" SATA HDD	SATA 6Gb/s	7.2K	-
M.2 2242 SSD	PCIe NVMe, PCIe 3.0 x4	-	-
M.2 2280 SSD	PCIe NVMe, PCIe 3.0 x4	-	Opal

RAID

No support

Removable Storage

Optical^{**}

- DVD-ROM, SATA 1.5Gb/s, slim (9.0mm)
- DVD burner (DVD±RW), SATA 1.5Gb/s, slim (9.0mm)
- None

Card Reader

- 3-in-1 card reader
- No card reader

Multi-Media

Audio Chip

High Definition (HD) Audio, Realtek® ALC233 codec

Speakers

Stereo speakers, 2W x2, Dolby® Atmos®

Microphone

- Dual array microphone
- No microphone

Camera^{**}

- 1080p, with ThinkShutter (physical switch on/off)
- IR & 1080p, with ThinkShutter (physical switch on/off), Windows Hello support

ThinkCentre M70a Gen 2

- No camera

Power Supply

Power Supply**

Power	Type	Efficiency	Key Features
135W	Adapter	89%	Autosensing
170W	Adapter	89%	Autosensing

DESIGN

Display

Display**[2]

Size	Resolution	Touch	Type	Brightness	Surface	Aspect Ratio	Contrast Ratio	Color Gamut	Viewing Angle	Key Features
21.5"	FHD (1920x1080)	None	IPS	250 nits	Anti-glare	16:9	1000:1	72% NTSC	horizontal: +/- 89°, vertical: +/- 89°	Borderless design (88% screen to body ratio), support low blue light mode
21.5"	FHD (1920x1080)	Multi-touch	IPS	250 nits	Anti-glare	16:9	1000:1	72% NTSC	horizontal: +/- 89°, vertical: +/- 89°	Borderless design (88% screen to body ratio), support low blue light mode

Touchscreen

- Advanced In-cell Touch (AIT), supports 10-point touch
- Non-touch

Notes:

- California Electronic Waste Recycling Fee
In California, per state law, Lenovo charges an electronic waste recycling fee on this covered device at the time of sale of the product. For more information, go to <https://www.calrecycle.ca.gov/Electronics/Consumer>
- IPS (in-plane switching) technology may refer to IPS, PLS, ADS, AHVA, AAS

Input Device

Keyboard**

- Lenovo Calliope Keyboard (USB connector), black
- Lenovo Calliope Wireless Keyboard (2.4GHz via USB receiver), black
- Lenovo Traditional Keyboard (USB connector), black
- No keyboard

Mouse**

- Lenovo Calliope Mouse (USB connector), black
- Lenovo Calliope Wireless Mouse (2.4GHz via USB receiver), black
- Lenovo Fingerprint Mouse (USB connector), Windows Hello support, black
- No mouse

Mechanical

Buttons

- Power button
- Microphone mute button

Form Factor

AIO (21.5 inches)

Dimensions (WxDxH)

Models	Dimensions
All models	490.1 x 55.6 x 312.3 mm (19.3 x 2.2 x 12.3 inches), no stand, with ODD, with camera

Weight

ThinkCentre M70a Gen 2

Models	Weight
All models	8.1 kg (17.9 lbs) at maximum configuration

Case Color

Black

Bays

- 1x 2.5" disk bay
- 1x slim ODD bay

Expansion Slots

Two M.2 slots (one for WLAN, one for SSD)

EOU

Toolless cover and stand assembly / removal

Stand**

- Full function monitor stand, supports -5° to +30° tilt, up to 80mm lift
- UltraFlex IV stand, supports -5° to +70° tilt, up to 164mm lift (flat mode) / up to 115mm lift (vertical mode)
- No stand

Mounting

Supports VESA mount 100mm

Others

Supports Smart Power On

CONNECTIVITY

Network

Onboard Ethernet

One gigabit Ethernet, Realtek RTL8111K, 1x RJ-45, supports Wake-on-LAN

Optional Ethernet

No optional Ethernet

WLAN + Bluetooth**

- Realtek RTL8822CE, 802.11ac Dual Band 2x2 Wi-Fi® + Bluetooth 5.0, M.2 card
- Intel Wireless-AC 9560, 802.11ac Dual Band 2x2 Wi-Fi + Bluetooth 5.1, M.2 card
- Intel Wi-Fi 6 AX201, 802.11ax 2x2 Wi-Fi + Bluetooth 5.2, M.2 Card
- No WLAN and Bluetooth

Ports^[1]

Rear Ports^[2]

- 3x USB 3.2 Gen 1
- 1x DisplayPort
- 1x Ethernet (RJ-45)

Optional Rear Ports**

- 1x HDMI
- 1x serial

Right Ports

- 1x USB 3.2 Gen 1
- 1x USB 3.2 Gen 2
- 1x USB-C 3.2 Gen 2 (support data transfer and 5V@3A charging)
- 1x headphone / microphone combo jack (3.5mm)

Optional Right Ports

1x card reader

Notes:

1. The transfer speed of following ports will vary and, depending on many factors, such as the processing speed of the host device, file attributes and other factors related to system configuration and your operating environment, will be slower than theoretical speed.
USB 2.0: 480 Mbit/s;
USB 3.2 Gen 1 (SuperSpeed USB 5Gbps, formerly USB 3.0 / USB 3.1 Gen 1): 5 Gbit/s;

USB 3.2 Gen 2 (SuperSpeed USB 10Gbps, formerly USB 3.1 Gen 2): 10 Gbit/s;
USB 3.2 Gen 2x2 (SuperSpeed USB 20Gbps): 20 Gbit/s;
Thunderbolt™ 3: 40 Gbit/s;
FireWire 400: 400 Mbit/s;
FireWire 800: 800 Mbit/s

2. For video ports on discrete graphics, please see graphics section

Monitor Cable

Monitor Cable***

- DP to dual DP dongle
- DP to DVI-D dongle
- DP to HDMI 1.4 dongle
- DP to VGA dongle
- No monitor cable

SECURITY & PRIVACY

Security

Security Chip

Discrete TPM 2.0, TCG certified

Physical Locks

Kensington® Security Slot

Chassis Intrusion Switch

- Chassis intrusion switch
- No chassis intrusion switch

Fingerprint Reader

No fingerprint reader

Other Security

(Optional) ThinkShutter camera cover

BIOS Security

- Administrator password
- Power-on password
- Hard disk password
- Boot sequence control
- Boot without keyboard and mouse
- Self-healing BIOS
- Smart USB protection (allows keyboard / mouse only, blocks all storage devices)
- Individual USB port disablement

MANAGEABILITY

System Management

System Management

None

SERVICE

Warranty

Base Warranty**

- 1-year depot service
- 1-year limited onsite service
- 3-year limited onsite service
- No base warranty

ENVIRONMENTAL

Operating Environment

Temperature

- Operating: 5°C (41°F) to 35°C (95°F)
- Storage: -20°C (-4°F) to 60°C (140°F)

Humidity

Operating: 20% to 80%

Altitude

- Operating: -15.2 m (-50 ft) to 3048 m (10,000 ft)
- Storage: -15.2 m (-50 ft) to 12192 m (40,000 ft)

CERTIFICATIONS

Green Certifications

Green Certifications

- EPEAT™ Silver
- ENERGY STAR® 8.0
- ErP Lot 3
- TCO Certified 8.0
- TCO edge
- RoHS compliant

Other Certifications

Other Certifications

- TÜV Rheinland® Eye Comfort Certification
- TÜV Rheinland Low Blue Light
- (Optional) TÜV Rheinland Ultra Low Noise

Mil-Spec Test

MIL-STD-810H military test passed (Low Pressure [Altitude], High Temperature, Low Temperature, Temperature Shock, Humidity, Sand and Dust, Vibration, Shock, Fungus, Solar Radiation)

- Feature with ** means that only one offering listed under the feature is configured on selected models.
- Feature with *** means that one or more offerings listed under the feature could be configured on selected models.
- Lenovo reserves the right to change specifications or other product information without notice. Lenovo is not responsible for photographic or typographical errors. LENOVO PROVIDES THIS PUBLICATION "AS IS," WITHOUT WARRANTY OF ANY KIND, EITHER EXPRESS OR IMPLIED, INCLUDING THE IMPLIED WARRANTIES OF MERCHANTABILITY OR FITNESS FOR A PARTICULAR PURPOSE. Some jurisdictions do not allow disclaimer of express or implied warranties in certain transactions, therefore this disclaimer may not apply to you.
- The specifications on this page may not be available in all regions, and may be changed or updated without notice.



OVERVIEW

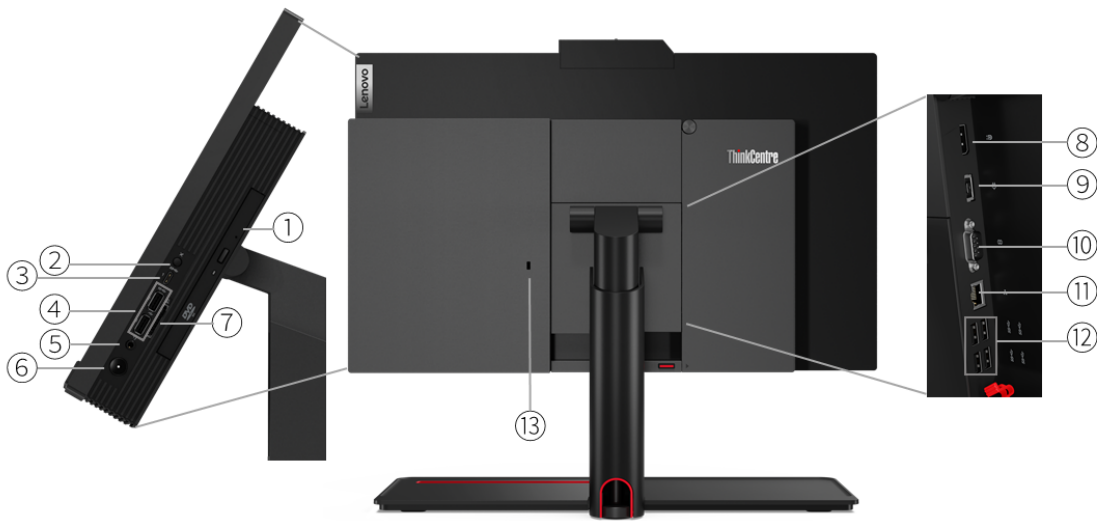

1. Optical drive *	8. DisplayPort
2. Microphone mute button	9. Power connector
3. USB-C 3.2 Gen 1	10. Serial *
4. 2x USB 3.2 Gen 2	11. Ethernet (RJ-45)
5. Headphone / microphone combo jack (3.5mm)	12. 4x USB 3.2 Gen 1
6. Power button	13. Kensington Security Slot
7. Card reader *	

Notes:

- Ports with * are only available on selected models

PERFORMANCE

Processor

Processor Family

Intel® Celeron®, Intel Pentium®, or 10th Generation Intel Core™ i3 / i5 / i7 / i9 Processor

Processor**

Processor Name	Cores	Threads	Base Frequency	Max Frequency	Cache	Memory Support	Processor Graphics
Celeron G5900	2	2	3.4GHz	-	2MB	DDR4-2666	Intel UHD Graphics 610
Celeron G5905	2	2	3.5GHz	-	4MB	DDR4-2666	Intel UHD Graphics 610
Celeron G5920	2	2	3.5GHz	-	2MB	DDR4-2666	Intel UHD Graphics 610
Celeron G5925	2	2	3.6GHz	-	4MB	DDR4-2666	Intel UHD Graphics 610
Pentium Gold G6400	2	4	4.0GHz	-	4MB	DDR4-2666	Intel UHD Graphics 610
Pentium Gold G6500	2	4	4.1GHz	-	4MB	DDR4-2666	Intel UHD Graphics 630
Pentium Gold G6600	2	4	4.2GHz	-	4MB	DDR4-2666	Intel UHD Graphics 630
Core i3-10100	4	8	3.6GHz	4.3GHz	6MB	DDR4-2666	Intel UHD Graphics 630
Core i3-10300	4	8	3.7GHz	4.4GHz	8MB	DDR4-2666	Intel UHD Graphics 630
Core i3-10320	4	8	3.8GHz	4.6GHz	8MB	DDR4-2666	Intel UHD Graphics 630
Core i5-10400	6	12	2.9GHz	4.3GHz	12MB	DDR4-2666	Intel UHD Graphics 630
Core i5-10500	6	12	3.1GHz	4.5GHz	12MB	DDR4-2666	Intel UHD Graphics 630
Core i5-10600	6	12	3.3GHz	4.8GHz	12MB	DDR4-2666	Intel UHD Graphics 630
Core i7-10700	8	16	2.9GHz	4.8GHz	16MB	DDR4-2933	Intel UHD Graphics 630
Core i9-10900	10	20	2.8GHz	5.2GHz	20MB	DDR4-2933	Intel UHD Graphics 630

Operating System

Operating System**

- Windows® 10 Pro 64
- Windows 10 Home 64
- Windows 10 IoT Enterprise
- Ubuntu Linux
- No operating system

Graphics

Graphics**[1]

Graphics	Type	Memory	Connector	Max Resolution	Key Features
Intel UHD graphics 630	Integrated	Shared	1x DP 1.2	4096x2304@60Hz(DP)	DirectX® 12
Intel UHD graphics 610	Integrated	Shared	1x DP 1.2	4096x2304@60Hz(DP)	DirectX 12
AMD Radeon™ 625	Discrete	2GB GDDR5	1x DP 1.2	4096x2304@60Hz(DP)	DirectX 12

Notes:

1. The information of integrated graphics are not applicable for the models without integrated graphics (for the details, please refer to processor section)

Monitor Support

Monitor Support

Supports up to 2 independent displays via native display and 1 external monitor; supports external monitor via DisplayPort™

Chipset

Chipset

Intel Q470 chipset

Memory

Max Memory^[1]

Up to 64GB DDR4-2933

Memory Slots

Two DDR4 DIMM slots, dual-channel capable

Memory Type^{**}

- DDR4-2666
- DDR4-2933

Notes:

1. The max memory is based on the test results with current Lenovo® memory offerings. The system may support more memory as the technology develops.

Storage

Storage Support

Up to three drives, 2x 2.5" HDD + 1x M.2 SSD

- 2.5" HDD up to 2TB each
- M.2 SSD up to 1TB
- Optional Intel Optane™ Memory, M.2

Storage Type^{***}

Disk Type	Interface	RPM	Security
2.5" SATA HDD	SATA 6Gb/s	5.4K	-
2.5" SATA HDD	SATA 6Gb/s	7.2K	-
M.2 2242 SSD	PCIe NVMe, PCIe 3.0 x2	-	-
M.2 2280 SSD	PCIe NVMe, PCIe 3.0 x4	-	Opal
M.2 2280 SSD	PCIe NVMe, PCIe 3.0 x4	-	-
Intel Optane Memory M10	PCIe NVMe, PCIe 3.0 x2	-	-

RAID^[1]

RAID 0/1 support for HDDs

Notes:

1. RAID is not preset by default, user can config RAID 0/1 according to the demand

Removable Storage

Optical^{**}

- DVD-ROM, SATA 1.5Gb/s, slim (9.0mm)
- DVD burner (DVD±RW), SATA 1.5Gb/s, slim (9.0mm)
- None

Card Reader

- 3-in-1 card reader
- No card reader

Multi-Media

Audio Chip

High Definition (HD) Audio, Realtek® ALC233 codec

Speakers

Stereo speakers, 3W x2

Microphone

Dual array microphone

Camera^{**}

- 1080p, with ThinkShutter (physical switch on/off)
- IR & 1080p, with ThinkShutter (physical switch on/off), Windows Hello support

- No camera

Power Supply

Power Supply**

Power	Type	Efficiency	Key Features
150W	Adapter	89%	Autosensing
170W	Adapter	89%	Autosensing

DESIGN

Display

Display**[2]

Size	Resolution	Touch	Type	Brightness	Surface	Aspect Ratio	Contrast Ratio	Color Gamut	Viewing Angle	Key Features
23.8"	FHD (1920x1080)	None	IPS	250 nits	Anti-glare	16:9	1000:1	-	horizontal: +/- 89°, vertical: +/- 89°	Borderless design, support low blue light mode
23.8"	FHD (1920x1080)	None	IPS	350 nits	Anti-glare	16:9	1000:1	-	horizontal: +/- 89°, vertical: +/- 89°	Borderless design, support low blue light mode, PrivacyGuard
23.8"	FHD (1920x1080)	Multi-touch	IPS	250 nits	Anti-glare	16:9	1000:1	-	horizontal: +/- 89°, vertical: +/- 89°	Borderless design, support low blue light mode

Touchscreen

- Advanced In-cell Touch (AIT), supports 10-point touch
- Non-touch

Notes:

1. California Electronic Waste Recycling Fee
In California, per state law, Lenovo charges an electronic waste recycling fee on this covered device at the time of sale of the product. For more information, go to <https://www.calrecycle.ca.gov/Electronics/Consumer>
2. PrivacyGuard is only available for MT 11JX

Input Device

Keyboard**

- Lenovo Calliope Keyboard (USB connector), black
- Lenovo Calliope Wireless Keyboard (2.4GHz via USB receiver), black
- Lenovo Traditional Keyboard (USB connector), black
- No keyboard

Mouse**

- Lenovo Calliope Mouse (USB connector), black
- Lenovo Calliope Wireless Mouse (2.4GHz via USB receiver), black
- Lenovo Fingerprint Mouse (USB connector), Windows Hello support, black
- No mouse

Mechanical

Buttons

- Power button
- PrivacyGuard on/off button (PrivacyGuard model only)
- Microphone mute button

Form Factor

AIO (23.8 inches)

Dimensions (WxDxH)

Models	Dimensions
Models (with full function monitor stand, with ODD, with PrivacyGuard, with camera)	541 x 200 x 414.2-494.2 mm (21.3 x 7.9 x 16.3-19.5 inches)
Models (with full function monitor stand, with ODD, without PrivacyGuard, with camera)	541 x 200 x 414.2-494.2 mm (21.3 x 7.9 x 16.3-19.5 inches)
Models (with full function monitor stand, without ODD, with PrivacyGuard, with camera)	541 x 200 x 414.2-494.2 mm (21.3 x 7.9 x 16.3-19.5 inches)
Models (with full function monitor stand, without ODD, without PrivacyGuard, with camera)	541 x 200 x 414.2-494.2 mm (21.3 x 7.9 x 16.3-19.5 inches)
Models (with UltraFlex IV stand, with ODD, without PrivacyGuard, with camera)	Lowest in flat mode: 541 x 312.8 x 227.4 mm (21.3 x 12.3 x 9.0 inches) Highest in vertical mode: 541 x 232.7 x 467.7 mm (21.3 x 9.2 x 18.4 inches)
Models (with UltraFlex IV stand, without ODD, without PrivacyGuard, with camera)	Lowest in flat mode: 541 x 312.8 x 227.4 mm (21.3 x 12.3 x 9.0 inches) Highest in vertical mode: 541 x 232.7 x 467.7 mm (21.3 x 9.2 x 18.4 inches)
Models (without stand, with ODD, with PrivacyGuard, with camera)	541 x 61.3 x 340.5 mm (21.3 x 2.4 x 13.4 inches)
Models (without stand, with ODD, without PrivacyGuard, with camera)	541 x 57.8 x 340.5 mm (21.3 x 2.3 x 13.4 inches)
Models (without stand, without ODD, with PrivacyGuard, with camera)	541 x 49.5 x 340.5 mm (21.3 x 1.9 x 13.4 inches)
Models (without stand, without ODD, without PrivacyGuard, with camera)	541 x 46 x 340.5 mm (21.3 x 1.8 x 13.4 inches)

Weight

Models	Weight
Models (with full function monitor stand, with ODD, with PrivacyGuard, with camera)	8.71 kg (19.2 lbs)
Models (with full function monitor stand, with ODD, without PrivacyGuard, with camera)	7.84 kg (17.3 lbs)
Models (with full function monitor stand, without ODD, with PrivacyGuard, with camera)	8.39 kg (18.5 lbs)
Models (with full function monitor stand, without ODD, without PrivacyGuard, with camera)	7.51 kg (16.6 lbs)
Models (with UltraFlex IV stand, with ODD, without PrivacyGuard, with camera)	8.58 kg (18.9 lbs)
Models (with UltraFlex IV stand, without ODD, without PrivacyGuard, with camera)	8.26 kg (18.2 lbs)
Models (without stand, with ODD, with PrivacyGuard, with camera)	6.45 kg (14.2 lbs)
Models (without stand, with ODD, without PrivacyGuard, with camera)	5.57 kg (12.3 lbs)
Models (without stand, without ODD, with PrivacyGuard, with camera)	6.13 kg (13.5 lbs)
Models (without stand, without ODD, without PrivacyGuard, with camera)	5.25 kg (11.6 lbs)

Case Color

Black

Bays

- 2x 2.5" disk bay (2nd 2.5" HDD occupies ODD bay)
- 1x slim ODD bay

Expansion Slots

Two M.2 slots (one for WLAN, one for SSD)

EOU

Toolless cover and stand assembly / removal

Stand**

- Full function monitor stand, supports -5° to +30° tilt, up to 80mm lift
- UltraFlex IV stand, supports -5° to +70° tilt, up to 164mm lift (flat mode) / up to 115mm lift (vertical mode)
- No stand

Mounting

Supports VESA mount 100mm

CONNECTIVITY

Network^[1]

Onboard Ethernet

Gigabit Ethernet, Intel Ethernet Connection I219-LM, 1x RJ45, supports Wake-on-LAN

Optional Ethernet

No optional Ethernet

WLAN + Bluetooth^{**}

- Realtek RTL8822CE, 802.11ac Dual Band 2x2 Wi-Fi® + Bluetooth 5.0, M.2 card
- Intel Wireless-AC 9560, 802.11ac Dual Band 2x2 Wi-Fi + Bluetooth 5.0, M.2 card
- Intel Wi-Fi 6 AX201, 802.11ax 2x2 Wi-Fi + Bluetooth 5.1, Intel vPro technology support, M.2 Card
- No WLAN and Bluetooth

Notes:

1. This system does not support Power Over Ethernet (PoE). If the system is used in a PoE environment, then a Network Isolator is required to prevent possible damage to the system, PoE equipment, or both.

Ports^[1]

Rear Ports^[2]

- 4x USB 3.2 Gen 1 (one supports Smart Power On)
- 1x DisplayPort
- 1x Ethernet (RJ-45)

Optional Rear Ports

1x serial

Right Ports

- 2x USB 3.2 Gen 2
- 1x USB-C 3.2 Gen 1 (5V/3A charging)
- 1x headphone / microphone combo jack (3.5mm)

Optional Right Ports

1x card reader

Notes:

1. The transfer speed of following ports will vary and, depending on many factors, such as the processing speed of the host device, file attributes and other factors related to system configuration and your operating environment, will be slower than theoretical speed.
USB 2.0: 480 Mbit/s;
USB 3.2 Gen 1 (SuperSpeed USB 5Gbps, formerly USB 3.0 / USB 3.1 Gen 1): 5 Gbit/s;
USB 3.2 Gen 2 (SuperSpeed USB 10Gbps, formerly USB 3.1 Gen 2): 10 Gbit/s;
USB 3.2 Gen 2x2 (SuperSpeed USB 20Gbps): 20 Gbit/s;
Thunderbolt™ 3: 40 Gbit/s;
FireWire 400: 400 Mbit/s;
FireWire 800: 800 Mbit/s
2. For video ports on discrete graphics, please see graphics section

Monitor Cable

Monitor Cable^{***}

- DP to dual DP dongle
- DP to DVI-D dongle
- DP to HDMI® 1.4 dongle
- DP to VGA dongle
- No monitor cable

SECURITY & PRIVACY

Security

Security Chip

Discrete TPM 2.0, TCG certified

Physical Locks

Kensington® Security Slot

Chassis Intrusion Switch

- Chassis intrusion switch
- No chassis intrusion switch

Fingerprint Reader

- Touch style fingerprint reader on mouse
- No fingerprint reader

Other Security

(Optional) ThinkShutter camera cover

BIOS Security

- Administrator password
- Power-on password
- Hard disk password
- Boot sequence control
- Boot without keyboard and mouse
- Self-healing BIOS
- Smart USB protection (allows keyboard / mouse only, blocks all storage devices)
- Individual USB port disablement

MANAGEABILITY

System Management

System Management¹

- Intel vPro with Intel AMT 14.0
- None

Notes:

1. Require choosing a vPro-support Wi-Fi adapter to enable vPro function through wireless connection

SERVICE

Warranty

Base Warranty**

- 1-year depot service
- 1-year limited onsite service
- 3-year limited onsite service
- No base warranty

ENVIRONMENTAL

Operating Environment

Temperature

- Operating: 5°C (41°F) to 35°C (95°F)
- Storage: -20°C (-4°F) to 60°C (140°F)

Humidity

Operating: 20% to 80%

Altitude

- Operating: -15.2 m (-50 ft) to 3048 m (10,000 ft)
- Storage: -15.2 m (-50 ft) to 12192 m (40,000 ft)

CERTIFICATIONS

Green Certifications

Green Certifications^[1]

- EPEAT™ Silver
- ENERGY STAR® 8.0
- ErP Lot 3
- TCO Certified 8.0
- TCO edge
- RoHS compliant

Notes:

1. Energy Star 8.0 and EPEAT are only available for MT 11CD/11CE, TCO 8.0 and TCO Edge are not for the models with PrivacyGaurd.

Other Certifications

Other Certifications

- TÜV Rheinland® Eye Comfort Certification
- TÜV Rheinland Low Blue Light
- (Optional) TÜV Rheinland Ultra Low Noise

Mil-Spec Test

MIL-STD-810H military test passed (Low Pressure [Altitude], High Temperature, Low Temperature, Temperature Shock, Humidity, Sand and Dust, Vibration, Shock, Fungus, Solar Radiation)

- Feature with ** means that only one offering listed under the feature is configured on selected models.
- Feature with *** means that one or more offerings listed under the feature could be configured on selected models.
- Lenovo reserves the right to change specifications or other product information without notice. Lenovo is not responsible for photographic or typographical errors. LENOVO PROVIDES THIS PUBLICATION “AS IS,” WITHOUT WARRANTY OF ANY KIND, EITHER EXPRESS OR IMPLIED, INCLUDING THE IMPLIED WARRANTIES OF MERCHANTABILITY OR FITNESS FOR A PARTICULAR PURPOSE. Some jurisdictions do not allow disclaimer of express or implied warranties in certain transactions, therefore this disclaimer may not apply to you.
- The specifications on this page may not be available in all regions, and may be changed or updated without notice.



OVERVIEW

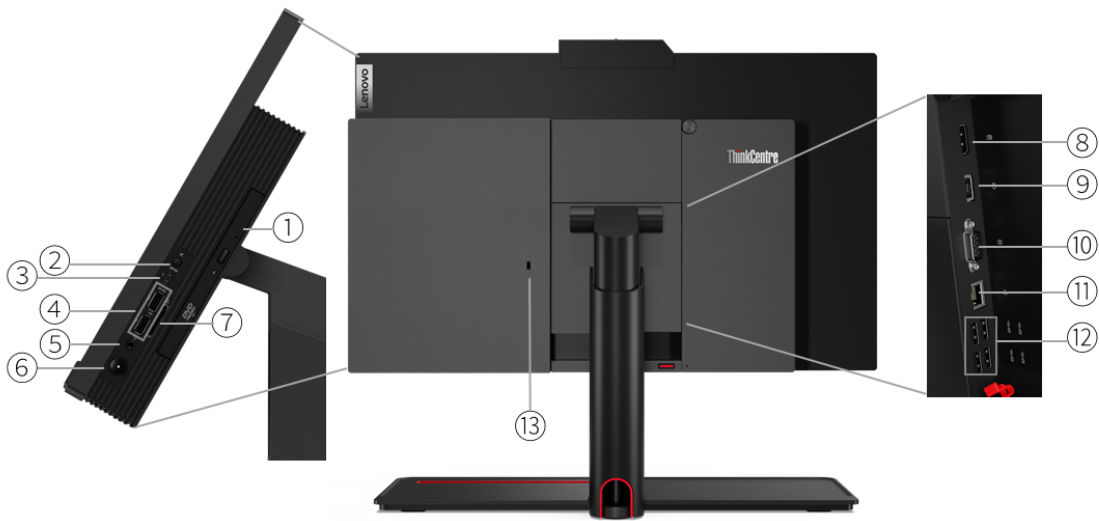

1. Optical drive *	8. DisplayPort (DP in/out combo port)
2. Microphone mute button	9. Power connector
3. USB-C 3.2 Gen 2	10. Serial or HDMI *
4. 2x USB 3.2 Gen 2	11. Ethernet (RJ-45)
5. Headphone / microphone combo jack (3.5mm)	12. 4x USB 3.2 Gen 1
6. Power button	13. Kensington Security Slot
7. Card reader *	

Notes:

- Ports with * are only available on selected models

PERFORMANCE

Processor

Processor Family

Intel® Celeron®, Intel Pentium®, 10th Generation Intel Core™ i3, or 11th Generation Intel Core i5 / i7 / i9 Processor

Processor**

Processor Name	Cores	Threads	Base Frequency	Max Frequency	Cache	Memory Support	Processor Graphics
Celeron G5905	2	2	3.5GHz	-	4MB	DDR4-2666	Intel UHD Graphics 610
Celeron G5925	2	2	3.6GHz	-	4MB	DDR4-2666	Intel UHD Graphics 610
Pentium Gold G6405	2	4	4.1GHz	-	4MB	DDR4-2666	Intel UHD Graphics 610
Pentium Gold G6505	2	4	4.2GHz	-	4MB	DDR4-2666	Intel UHD Graphics 630
Pentium Gold G6605	2	4	4.3GHz	-	4MB	DDR4-2666	Intel UHD Graphics 630
Core i3-10105	4	8	3.7GHz	4.4GHz	6MB	DDR4-2666	Intel UHD Graphics 630
Core i3-10305	4	8	3.8GHz	4.5GHz	8MB	DDR4-2666	Intel UHD Graphics 630
Core i3-10325	4	8	3.9GHz	4.7GHz	8MB	DDR4-2666	Intel UHD Graphics 630
Core i5-11400	6	12	2.6GHz	4.4GHz	12MB	DDR4-3200	Intel UHD Graphics 730
Core i5-11500	6	12	2.7GHz	4.6GHz	12MB	DDR4-3200	Intel UHD Graphics 750
Core i5-11600	6	12	2.8GHz	4.8GHz	12MB	DDR4-3200	Intel UHD Graphics 750
Core i7-11700	8	16	2.5GHz	4.9GHz	16MB	DDR4-3200	Intel UHD Graphics 750
Core i9-11900	8	16	2.5GHz	5.2GHz	16MB	DDR4-3200	Intel UHD Graphics 750

Operating System

Operating System**

- Windows® 10 Pro 64
- Windows 10 Home 64
- Windows 10 IoT Enterprise
- Ubuntu Linux
- No operating system

Graphics

Graphics**[1]

Graphics	Type	Memory	Connector	Max Resolution	Key Features	Remark
Intel UHD graphics 730	Integrated	Shared	1x DP 1.4b, 1x optional HDMI® 2.1	4096x2304@60Hz(DP), 4096x2160@60Hz(HDMI)	DirectX® 12	-
Intel UHD graphics 750	Integrated	Shared	1x DP 1.4b, 1x optional HDMI 2.1	4096x2304@60Hz(DP), 4096x2160@60Hz(HDMI)	DirectX 12	-
Intel UHD graphics 630	Integrated	Shared	1x DP 1.4b, 1x optional HDMI 2.1	4096x2304@60Hz(DP), 4096x2160@60Hz(HDMI)	DirectX 12	-
Intel UHD graphics 610	Integrated	Shared	1x DP 1.4b, 1x optional HDMI 2.1	4096x2304@60Hz(DP), 4096x2160@60Hz(HDMI)	DirectX 12	-
AMD Radeon™ 630	Discrete	2GB GDDR5	1x DP 1.4b, 1x optional HDMI 2.1	4096x2304@60Hz(DP), 4096x2160@60Hz(HDMI)	DirectX 12	-

Notes:

1. The information of integrated graphics are not applicable for the models without integrated graphics (for the details, please refer to processor section)

Monitor Support

Monitor Support

Supports up to 3 independent displays via native display and 2 external monitor; supports external monitors via

DisplayPort™ and optional HDMI; work as standalone monitor via DisplayPort (DP in / out combo)

Chipset

Chipset

Intel Q570 Chipset

Memory

Max Memory^[1]

Up to 64GB DDR4-3200

Memory Slots

Two DDR4 SO-DIMM slots, dual-channel capable

Memory Type^{**[2]}

- DDR4-2666
- DDR4-3200

Notes:

1. The max memory is based on the test results with current Lenovo® memory offerings. The system may support more memory as the technology develops.
2. Installed memory is actually 3200MHz, but may run at 2666MHz or 3200MHz depending on the memory support capability of processor

Storage

Storage Support^[1]

Up to three drives, 2x 2.5" HDD + 1x M.2 SSD

- 2.5" HDD up to 2TB each
- M.2 SSD up to 1TB

Storage Type^{***}

Disk Type	Interface	RPM	Offering	Security
2.5" SATA HDD	SATA 6Gb/s	5.4K	-	-
2.5" SATA HDD	SATA 6Gb/s	7.2K	-	-
M.2 2242 SSD	PCIe NVMe, PCIe 3.0 x2	-	-	-
M.2 2242 SSD	PCIe NVMe, PCIe 3.0 x4	-	-	-
M.2 2280 SSD	PCIe NVMe, PCIe 4.0 x4	-	-	Opal
M.2 2280 SSD	PCIe NVMe, PCIe 3.0 x4	-	-	Opal

RAID^[2]

RAID 0/1 support for HDDs

Notes:

1. 2nd 2.5" HDD occupies ODD bay
2. RAID is not preset by default, user can config RAID 0/1 according to the demand

Removable Storage

Optical^{**}

- DVD-ROM, SATA 1.5Gb/s, slim (9.0mm)
- DVD burner (DVD±RW), SATA 1.5Gb/s, slim (9.0mm)
- None

Card Reader

- 3-in-1 card reader
- No card reader

Multi-Media

Audio Chip

High Definition (HD) Audio, Realtek® ALC233 codec

Speakers

ThinkCentre M90a Gen 2

Stereo speakers, 3W x2, Dolby® Atmos®

Microphone

- Dual array microphone
- No microphone

Camera**

- 5.0-megapixel, with ThinkShutter (physical switch on/off), Windows Hello support
- 5.0-megapixel, IR & RGB hybrid, with ThinkShutter (physical switch on/off), Windows Hello support
- No camera

Power Supply

Power Supply**

Power	Type	Efficiency	Key Features
150W	Adapter	89%	Autosensing
170W	Adapter	89%	Autosensing

DESIGN

Display

Display**[1]

Size	Resolution	Touch	Type	Brightness	Surface	Aspect Ratio	Contrast Ratio	Color Gamut	Viewing Angle	Key Features
23.8"	FHD (1920x1080)	None	IPS	250 nits	Anti-glare	16:9	1000:1	72% NTSC	horizontal: +/- 89°, vertical: +/- 89°	Borderless design, low blue light
23.8"	FHD (1920x1080)	None	IPS	350 nits	Anti-glare	16:9	1000:1	72% NTSC	horizontal: +/- 89°, vertical: +/- 89°	Borderless design, low blue light, PrivacyGuard
23.8"	FHD (1920x1080)	Multi-touch	IPS	250 nits	Anti-glare	16:9	1000:1	72% NTSC	horizontal: +/- 89°, vertical: +/- 89°	Borderless design, low blue light

Touchscreen

- Advanced In-cell Touch (AIT), supports 10-point touch
- Non-touch

Notes:

- California Electronic Waste Recycling Fee
In California, per state law, Lenovo charges an electronic waste recycling fee on this covered device at the time of sale of the product. For more information, go to <https://www.calrecycle.ca.gov/Electronics/Consumer>

Input Device

Keyboard**

- Lenovo Calliope Keyboard (USB connector), black
- Lenovo Calliope Wireless Keyboard (2.4GHz via USB receiver), black
- Lenovo Traditional Keyboard (USB connector), black
- No keyboard

Mouse**

- Lenovo Calliope Mouse (USB connector), black
- Lenovo Calliope Wireless Mouse (2.4GHz via USB receiver), black
- No mouse

Mechanical

Buttons

- Power button
- PrivacyGuard on/off button (PrivacyGuard model only)
- Microphone mute button

Form Factor

AIO (23.8 inches)

Dimensions (WxDxH)

Models	Dimensions
Models (with full function monitor stand, with ODD, with PrivacyGuard, with camera)	541 x 200 x 414.2-494.2 mm (21.3 x 7.9 x 16.3-19.5 inches)
Models (with full function monitor stand, with ODD, without PrivacyGuard, with camera)	541 x 200 x 414.2-494.2 mm (21.3 x 7.9 x 16.3-19.5 inches)
Models (with full function monitor stand, without ODD, with PrivacyGuard, with camera)	541 x 200 x 414.2-494.2 mm (21.3 x 7.9 x 16.3-19.5 inches)
Models (with full function monitor stand, without ODD, without PrivacyGuard, with camera)	541 x 200 x 414.2-494.2 mm (21.3 x 7.9 x 16.3-19.5 inches)
Models (with UltraFlex IV stand, with ODD, without PrivacyGuard, with camera)	Lowest in flat mode: 541 x 312.8 x 227.4 mm (21.3 x 12.3 x 9.0 inches) Highest in vertical mode: 541 x 232.7 x 467.7 mm (21.3 x 9.2 x 18.4 inches)
Models (with UltraFlex IV stand, without ODD, without PrivacyGuard, with camera)	Lowest in flat mode: 541 x 312.8 x 227.4 mm (21.3 x 12.3 x 9.0 inches) Highest in vertical mode: 541 x 232.7 x 467.7 mm (21.3 x 9.2 x 18.4 inches)
Models (without stand, with ODD, with PrivacyGuard, with camera)	541 x 61.3 x 340.5 mm (21.3 x 2.4 x 13.4 inches)
Models (without stand, with ODD, without PrivacyGuard, with camera)	541 x 57.8 x 340.5 mm (21.3 x 2.3 x 13.4 inches)
Models (without stand, without ODD, with PrivacyGuard, with camera)	541 x 49.5 x 340.5 mm (21.3 x 1.9 x 13.4 inches)
Models (without stand, without ODD, without PrivacyGuard, with camera)	541 x 46 x 340.5 mm (21.3 x 1.8 x 13.4 inches)

Weight

Models	Weight
Models (with full function monitor stand, with ODD, with PrivacyGuard, with camera)	8.71 kg (19.2 lbs)
Models (with full function monitor stand, with ODD, without PrivacyGuard, with camera)	7.84 kg (17.3 lbs)
Models (with full function monitor stand, without ODD, with PrivacyGuard, with camera)	8.39 kg (18.5 lbs)
Models (with full function monitor stand, without ODD, without PrivacyGuard, with camera)	7.51 kg (16.6 lbs)
Models (with UltraFlex IV stand, with ODD, without PrivacyGuard, with camera)	8.58 kg (18.9 lbs)
Models (with UltraFlex IV stand, without ODD, without PrivacyGuard, with camera)	8.26 kg (18.2 lbs)
Models (without stand, with ODD, with PrivacyGuard, with camera)	6.45 kg (14.2 lbs)
Models (without stand, with ODD, without PrivacyGuard, with camera)	5.57 kg (12.3 lbs)
Models (without stand, without ODD, with PrivacyGuard, with camera)	6.13 kg (13.5 lbs)
Models (without stand, without ODD, without PrivacyGuard, with camera)	5.25 kg (11.6 lbs)

Case Color

Black

Bays

- 2x 2.5" disk bay (2nd 2.5" HDD occupies ODD bay)
- 1x slim ODD bay

Expansion Slots

Two M.2 slots (one for WLAN, one for SSD)

EOU

Toolless cover and stand assembly / removal

Stand**

- Full function monitor stand, supports -5° to +30° tilt, up to 80mm lift
- UltraFlex IV stand, supports -5° to +70° tilt, up to 164mm lift (flat mode) / up to 115mm lift (vertical mode)
- No stand

Mounting

Supports VESA mount 100mm

Others

Supports Smart Power On

CONNECTIVITY

Network^[1]

Onboard Ethernet

Gigabit Ethernet, Intel Ethernet Connection I219-LM, 1x RJ45, supports Wake-on-LAN

Optional Ethernet

No optional Ethernet

WLAN + Bluetooth^{®*}

- Realtek RTL8822CE, 802.11ac Dual Band 2x2 Wi-Fi[®] + Bluetooth 5.0, M.2 card
- Intel Wireless-AC 9560, 802.11ac Dual Band 2x2 Wi-Fi + Bluetooth 5.1, Intel vPro technology support, M.2 card
- Intel Wireless-AC 9560, 802.11ac Dual Band 2x2 Wi-Fi + Bluetooth 5.1, M.2 card
- Intel Wi-Fi 6 AX201, 802.11ax 2x2 Wi-Fi + Bluetooth 5.2, Intel vPro technology support, M.2 Card
- Intel Wi-Fi 6 AX201, 802.11ax 2x2 Wi-Fi + Bluetooth 5.2, M.2 Card
- No WLAN and Bluetooth

Notes:

1. This system does not support Power Over Ethernet (PoE). If the system is used in a PoE environment, then a Network Isolator is required to prevent possible damage to the system, PoE equipment, or both.

Ports^[1]

Rear Ports^[2]

- 4x USB 3.2 Gen 1
- 1x DisplayPort
- 1x Ethernet (RJ-45)

Optional Rear Ports^{}**

- 1x HDMI
- 1x serial

Right Ports

- 2x USB 3.2 Gen 2
- 1x USB-C 3.2 Gen 2 (support data transfer and 5V@3A charging)
- 1x headphone / microphone combo jack (3.5mm)

Optional Right Ports

1x card reader

Notes:

1. The transfer speed of following ports will vary and, depending on many factors, such as the processing speed of the host device, file attributes and other factors related to system configuration and your operating environment, will be slower than theoretical speed.
USB 2.0: 480 Mbit/s;
USB 3.2 Gen 1 (SuperSpeed USB 5Gbps, formerly USB 3.0 / USB 3.1 Gen 1): 5 Gbit/s;
USB 3.2 Gen 2 (SuperSpeed USB 10Gbps, formerly USB 3.1 Gen 2): 10 Gbit/s;
USB 3.2 Gen 2x2 (SuperSpeed USB 20Gbps): 20 Gbit/s;
Thunderbolt™ 3: 40 Gbit/s;
FireWire 400: 400 Mbit/s;
FireWire 800: 800 Mbit/s
2. For video ports on discrete graphics, please see graphics section

Monitor Cable

Monitor Cable^{*}**

- DP to dual DP dongle
- DP to DVI-D dongle

- DP to HDMI 1.4 dongle
- DP to VGA dongle
- No monitor cable

SECURITY & PRIVACY

Security

Security Chip

Discrete TPM 2.0, TCG certified

Physical Locks

Kensington® Security Slot

Chassis Intrusion Switch

- Chassis intrusion switch
- No chassis intrusion switch

Fingerprint Reader

- Touch style fingerprint reader on mouse
- No fingerprint reader

Other Security

(Optional) ThinkShutter camera cover

BIOS Security

- Administrator password
- Power-on password
- Hard disk password
- Boot sequence control
- Boot without keyboard and mouse
- Self-healing BIOS
- Smart USB protection (allows keyboard / mouse only, blocks all storage devices)
- Individual USB port disablement

MANAGEABILITY

System Management

System Management

- Intel vPro Technology, DASH
- None

SERVICE

Warranty

Base Warranty**

- 1-year limited onsite service
- 3-year limited onsite service
- No base warranty

ENVIRONMENTAL

Operating Environment

Temperature

- Operating: 5°C (41°F) to 35°C (95°F)
- Storage: -20°C (-4°F) to 60°C (140°F)

Humidity

Operating: 20% to 80%

Altitude

- Operating: -15.2 m (-50 ft) to 3048 m (10,000 ft)

- Storage: -15.2 m (-50 ft) to 12192 m (40,000 ft)

CERTIFICATIONS

Green Certifications

Green Certifications

- EPEAT™ Silver
- ENERGY STAR® 8.0
- ErP Lot 3
- TCO Certified 8.0
- TCO edge
- RoHS compliant

Other Certifications

Other Certifications

- (Optional) TÜV Rheinland® Eye Comfort Certification
- TÜV Rheinland Low Blue Light
- (Optional) TÜV Rheinland Ultra Low Noise

Mil-Spec Test

MIL-STD-810H military test passed (Low Pressure [Altitude], High Temperature, Low Temperature, Temperature Shock, Humidity, Sand and Dust, Vibration, Shock, Fungus, Solar Radiation)

- Feature with ** means that only one offering listed under the feature is configured on selected models.
- Feature with *** means that one or more offerings listed under the feature could be configured on selected models.
- Lenovo reserves the right to change specifications or other product information without notice. Lenovo is not responsible for photographic or typographical errors. LENOVO PROVIDES THIS PUBLICATION “AS IS,” WITHOUT WARRANTY OF ANY KIND, EITHER EXPRESS OR IMPLIED, INCLUDING THE IMPLIED WARRANTIES OF MERCHANTABILITY OR FITNESS FOR A PARTICULAR PURPOSE. Some jurisdictions do not allow disclaimer of express or implied warranties in certain transactions, therefore this disclaimer may not apply to you.
- The specifications on this page may not be available in all regions, and may be changed or updated without notice.



intel



intel



intel

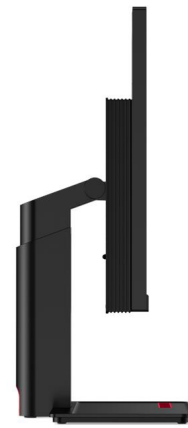

intel



intel



OVERVIEW

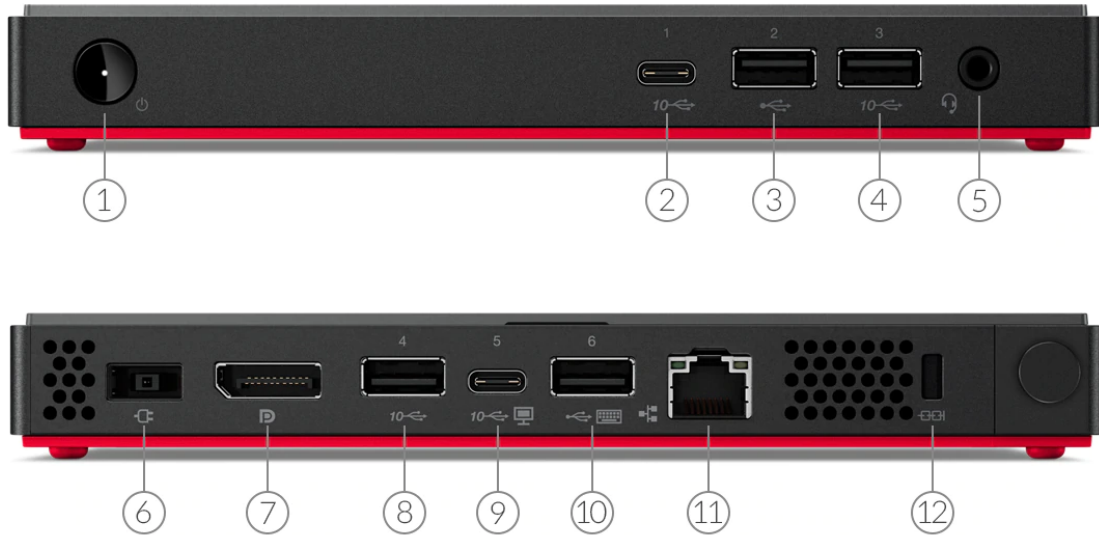

1. Power button	7. DisplayPort
2. USB-C 3.2 Gen 2	8. USB 3.2 Gen 2
3. USB 2.0	9. USB-C 3.2 Gen 2 (display and power-in)
4. USB 3.2 Gen 2	10. USB 2.0
5. Headphone / microphone combo jack (3.5mm)	11. Ethernet (RJ-45)
6. Power connector	

PERFORMANCE

Processor

Processor Family

AMD Ryzen™ 3 / 5 Processor

Processor**

Processor Name	Cores	Threads	Base Frequency	Max Frequency	Cache	Memory Support	Processor Graphics
AMD Ryzen 3 PRO 3300U	4	4	2.1GHz	3.5GHz	2MB L2 / 4MB L3	DDR4-2400	AMD Radeon™ Vega 6 Graphics
AMD Ryzen 5 PRO 3500U	4	8	2.1GHz	3.7GHz	2MB L2 / 4MB L3	DDR4-2400	AMD Radeon Vega 8 Graphics

Operating System

Operating System**

- Windows® 10 Pro 64
- Windows 10 Home 64
- Windows 10 IoT Enterprise
- Ubuntu Linux
- No operating system

Graphics

Graphics**[1]

Graphics	Type	Memory	Connector	Max Resolution	Key Features
AMD Radeon Vega 6 Graphics	Integrated	Shared	1x DisplayPort™, 1x USB-C	3840x2160@60Hz(DP), 3840x2160@60Hz(USB-C)	DirectX® 12
AMD Radeon Vega 8 Graphics	Integrated	Shared	1x DisplayPort, 1x USB-C	3840x2160@60Hz(DP), 3840x2160@60Hz(USB-C)	DirectX 12

Notes:

1. The information of integrated graphics are not applicable for the models without integrated graphics (for the details, please refer to processor section)

Monitor Support

Monitor Support

Supports up to 2 independent displays via onboard ports (DisplayPort and USB-C)

Chipset

Chipset

AMD SoC (System on Chip) platform

Memory

Max Memory^[1]

8GB soldered memory, not upgradable

Memory Slots

Memory soldered to systemboard, no slots, dual-channel

Memory Type

DDR4-2400

Notes:

1. The max memory is based on the test results with current Lenovo® memory offerings. The system may support more memory as the technology develops.

Storage

Storage Support

Up to two drives, 2x M.2 SSD

- M.2 SSD up to 1TB each

Storage Type**

Disk Type	Interface	RPM	Security
M.2 2242 SSD	PCIe NVMe, PCIe 3.0 x2	-	-
M.2 2242 SSD	PCIe NVMe, PCIe 3.0 x4	-	-
M.2 2280 SSD	PCIe NVMe, PCIe 3.0 x4	-	Opal

RAID

No support

Removable Storage

Optical

None

Card Reader

No card reader

Multi-Media

Audio Chip

High Definition (HD) Audio, Realtek® ALC233 codec

Speakers

Single speaker, 1W x1

Power Supply

Power Supply

Power	Type	Efficiency	Key Features
65W	Adapter	89%	Autosensing
No power supply	-	-	-

DESIGN

Input Device

Keyboard**

- Lenovo Calliope Keyboard (USB connector), black
- Lenovo Calliope Wireless Keyboard (2.4GHz via USB receiver), black
- Lenovo Traditional Keyboard (USB connector), black
- No keyboard

Mouse**

- Lenovo Calliope Mouse (USB connector), black
- Lenovo Calliope Wireless Mouse (2.4GHz via USB receiver), black
- Lenovo Fingerprint Mouse (USB connector), Windows Hello support, black
- No mouse

Mechanical

Form Factor

Nano (0.35L)

Dimensions (WxDxH)

Models	Dimensions
All models	179 x 88 x 22 mm (7.05 x 3.46 x 0.87 inches)

Weight

Models	Weight
--------	--------

All models	0.505 kg (1.11 lbs)
------------	---------------------

Case Color

Iron grey (top cover), black (mid bezel), red (bottom cover)

Bays

No bays

Expansion Slots

- One M.2 slot (for WLAN)
- Two M.2 slots (for SSD, one supports up to PCIe 3.0 x4, one supports up to PCIe 3.0 x2)

Stand

No stand

IO Box

No IO box

Mounting**

- VESA mount bracket kit with adapter holder, supports VESA mount 75mm and 100mm
- VESA mount bracket kit, supports VESA mount 75mm and 100mm
- DIN rail mount bracket kit
- None

CONNECTIVITY

Network

Onboard Ethernet

Gigabit Ethernet, Realtek RTL8111FP-CG, 1x RJ45, supports Wake-on-LAN

Optional Ethernet

No optional Ethernet

WLAN + Bluetooth**

- Realtek RTL8852AE, Wi-Fi® 6, 802.11ax Dual Band 2x2 Wi-Fi + Bluetooth 5.2, M.2 card
- Realtek RTL8822CE, 802.11ac Dual Band 2x2 Wi-Fi + Bluetooth 5.0, M.2 card
- Qualcomm® QCA6174A, 802.11ac Dual Band 2x2 Wi-Fi + Bluetooth 4.2, M.2 card
- Intel® Wireless-AC 9260, 802.11ac Dual Band 2x2 Wi-Fi + Bluetooth 5.0, M.2 card
- No WLAN and Bluetooth

Ports^[1]

Front Ports

- 1x USB 2.0
- 1x USB 3.2 Gen 2
- 1x USB-C 3.2 Gen 2
- 1x headphone / microphone combo jack (3.5mm)

Rear Ports^[2]

- 1x USB 2.0
- 1x USB 3.2 Gen 2
- 1x USB-C 3.2 Gen 2 (support display function and power-in [20V and >45W])
- 1x DisplayPort
- 1x Ethernet (RJ-45)

Notes:

1. The transfer speed of following ports will vary and, depending on many factors, such as the processing speed of the host device, file attributes and other factors related to system configuration and your operating environment, will be slower than theoretical speed.
USB 2.0: 480 Mbit/s;
USB 3.2 Gen 1 (SuperSpeed USB 5Gbps, formerly USB 3.0 / USB 3.1 Gen 1): 5 Gbit/s;
USB 3.2 Gen 2 (SuperSpeed USB 10Gbps, formerly USB 3.1 Gen 2): 10 Gbit/s;
USB 3.2 Gen 2x2 (SuperSpeed USB 20Gbps): 20 Gbit/s;
Thunderbolt™ 3: 40 Gbit/s;
FireWire 400: 400 Mbit/s;
FireWire 800: 800 Mbit/s
2. For video ports on discrete graphics, please see graphics section

Monitor Cable

Monitor Cable***

- USB-C to DP dongle
- USB-C to HDMI® dongle
- USB-C to VGA dongle
- DP to HDMI 1.4 dongle
- DP to VGA dongle
- No monitor cable

SECURITY & PRIVACY

Security

Security Chip

Discrete TPM 2.0, TCG certified

Physical Locks

Kensington® Security Slot

Chassis Intrusion Switch

Chassis intrusion switch

Fingerprint Reader

- Touch style fingerprint reader on mouse
- No fingerprint reader

BIOS Security

- Administrator password
- Power-on password
- Hard disk password
- Boot sequence control
- Boot without keyboard and mouse
- Smart USB protection (allows keyboard / mouse only, blocks all storage devices)
- Individual USB port disablement

MANAGEABILITY

System Management

System Management

DASH 1.1 / 1.2

SERVICE

Warranty

Base Warranty**

- 1-year depot service
- 1-year limited onsite service
- 3-year limited onsite service
- No base warranty

ENVIRONMENTAL

Operating Environment

Temperature

- Operating: 5°C (41°F) to 35°C (95°F)
- Storage: -40°C (-40°F) to 60°C (140°F)

Humidity

- Operating: 20% to 80%

- Storage: 10% to 90%

Altitude

- Operating: -15.2 m (-50 ft) to 3048 m (10,000 ft)
- Storage: -15.2 m (-50 ft) to 12192 m (40,000 ft)

CERTIFICATIONS

Green Certifications

Green Certifications

- EPEAT™ Silver
- ENERGY STAR® 8.0
- ErP Lot 3
- TCO Certified 8.0
- RoHS compliant
- REACH
- WEEE

Other Certifications

Other Certifications

TÜV Rheinland® Ultra Low Noise

Mil-Spec Test

MIL-STD-810H military test passed (Low Pressure [Altitude], High Temperature, Low Temperature, Temperature Shock, Humidity, Sand and Dust, Vibration, Shock, Fungus, Solar Radiation)

- Feature with ** means that only one offering listed under the feature is configured on selected models.
- Feature with *** means that one or more offerings listed under the feature could be configured on selected models.
- Lenovo reserves the right to change specifications or other product information without notice. Lenovo is not responsible for photographic or typographical errors. LENOVO PROVIDES THIS PUBLICATION “AS IS,” WITHOUT WARRANTY OF ANY KIND, EITHER EXPRESS OR IMPLIED, INCLUDING THE IMPLIED WARRANTIES OF MERCHANTABILITY OR FITNESS FOR A PARTICULAR PURPOSE. Some jurisdictions do not allow disclaimer of express or implied warranties in certain transactions, therefore this disclaimer may not apply to you.
- The specifications on this page may not be available in all regions, and may be changed or updated without notice.



AMD



AMD



AMD



AMD



AMD



AMD

OVERVIEW

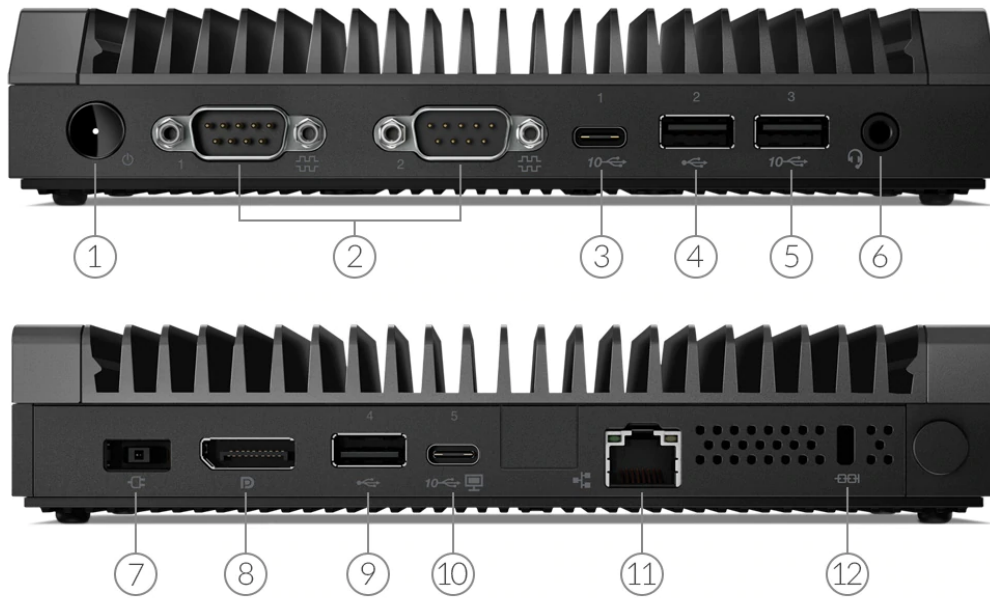

1. Power button	7. Power connector
2. 2x Serial (RS232)	8. DisplayPort
3. USB-C 3.2 Gen 2	9. USB 3.2 Gen 2
4. USB 2.0	10. USB-C 3.2 Gen 2 (display and power-in)
5. USB 3.2 Gen 2	11. Ethernet (RJ-45)
6. Headphone / microphone combo jack (3.5mm)	12. Kensington Security Slot

PERFORMANCE

Processor

Processor Family

AMD Athlon™ Processor

Processor

Processor Name	Cores	Threads	Base Frequency	Max Frequency	Cache	Memory Support	Processor Graphics
AMD Athlon Silver 3050e	2	4	1.4GHz	2.8GHz	1MB L2 / 4MB L3	DDR4-2400	AMD Radeon™ Graphics

Operating System

Operating System**

- Windows® 10 Pro 64
- Windows 10 Home 64
- Windows 10 IoT Enterprise
- LeTOS V2 (Lenovo® Terminal Operating System, Linux-based)
- Ubuntu Linux
- No operating system

Graphics

Graphics^[1]

Graphics	Type	Memory	Connector	Max Resolution	Key Features
AMD Radeon Graphics	Integrated	Shared	1x DisplayPort™, 1x USB-C	3840x2160@60Hz(DP), 3840x2160@60Hz(USB-C)	DirectX® 12

Notes:

1. The information of integrated graphics are not applicable for the models without integrated graphics (for the details, please refer to processor section)

Monitor Support

Monitor Support

Supports up to 2 independent displays via onboard ports (DisplayPort and USB-C)

Chipset

Chipset

AMD SoC (System on Chip) platform

Memory

Max Memory^[1]

4GB soldered memory, not upgradable

Memory Slots

Memory soldered to systemboard, no slots

Memory Type

DDR4-2400

Notes:

1. The max memory is based on the test results with current Lenovo memory offerings. The system may support more memory as the technology develops.

Storage

Storage Support

One drive, up to 1TB M.2 2280 SSD

Storage Type***

ThinkCentre M75n IoT

Disk Type	Interface	RPM	Security
M.2 2242 SSD	PCIe NVMe, PCIe 3.0 x2	-	-
M.2 2242 SSD	PCIe NVMe, PCIe 3.0 x4	-	-
M.2 2280 SSD	PCIe NVMe, PCIe 3.0 x4	-	Opal
M.2 2280 SSD	SATA 6Gb/s	-	Opal

RAID

No support

Removable Storage

Optical

None

Card Reader

No card reader

Multi-Media

Audio Chip

High Definition (HD) Audio, Realtek® ALC233 codec

Speakers

Single speaker, 1W x1

Power Supply

Power Supply**

Power	Type	Efficiency	Key Features
65W	Adapter	88%	Autosensing, wide temperature
65W	Adapter	89%	Autosensing
No power supply	-	-	-

DESIGN

Input Device

Keyboard**

- Lenovo Calliope Keyboard (USB connector), black
- Lenovo Calliope Wireless Keyboard (2.4GHz via USB receiver), black
- Lenovo Traditional Keyboard (USB connector), black
- No keyboard

Mouse**

- Lenovo Calliope Mouse (USB connector), black
- Lenovo Calliope Wireless Mouse (2.4GHz via USB receiver), black
- Lenovo Fingerprint Mouse (USB connector), Windows Hello support, black
- No mouse

Mechanical

Form Factor

Nano (0.55L)

Dimensions (WxDxH)

Models	Dimensions
Nano only	179 x 88 x 34.5 mm (7.05 x 3.46 x 1.36 inches)
Nano with IO box	179 x 88 x 61.3 mm (7.05 x 3.46 x 2.41 inches)

Weight

Models	Weight
--------	--------

ThinkCentre M75n IoT

Nano only	0.72 kg (1.58 lbs)
Nano with IO box	1.2 kg (2.65 lbs)

Case Color

Iron grey (top cover), black (mid bezel), black (bottom cover)

Bays

No bays

Expansion Slots

Two M.2 slots (one for WLAN, one for SSD)

Stand

No stand

IO Box

- IO box: 2x serial (RS232 / RS422 / RS485, SDK selectable) and 2x Ethernet (RJ-45, Realtek RTL8153B, gigabit Ethernet) on front, 1x DIO (4DI / 4DO), 1x USB-C (connect to Nano) and 1x DC-in connector (9V - 36V) on rear
- No IO box

Mounting**

- VESA mount bracket kit with adapter holder, supports VESA mount 75mm and 100mm
- VESA mount bracket kit, supports VESA mount 75mm and 100mm
- DIN rail mount bracket kit
- None

CONNECTIVITY

Network

Onboard Ethernet

Gigabit Ethernet, Realtek RTL8111FP-CG, 1x RJ45, supports Wake-on-LAN

Optional Ethernet

No optional Ethernet

WLAN + Bluetooth**

- Realtek RTL8852AE, Wi-Fi® 6, 802.11ax Dual Band 2x2 Wi-Fi + Bluetooth 5.2, M.2 card
- Realtek RTL8822CE, 802.11ac Dual Band 2x2 Wi-Fi + Bluetooth 5.0, M.2 card
- Qualcomm® QCA6174A, 802.11ac Dual Band 2x2 Wi-Fi + Bluetooth 4.2, M.2 card
- Intel® Wireless-AC 9260, 802.11ac Dual Band 2x2 Wi-Fi + Bluetooth 5.0, M.2 card
- No WLAN and Bluetooth

Ports^[1]

Front Ports

- 1x USB 2.0
- 1x USB 3.2 Gen 2
- 1x USB-C 3.2 Gen 2
- 1x headphone / microphone combo jack (3.5mm)
- 2x serial (RS-232)

Optional Front Ports

- 2x gigabit Ethernet (RJ-45) on SE30 IO box
- 2x serial (RS232 / RS422 / RS485, SDK selectable) on SE30 IO box

Rear Ports^[2]

- 1x USB 3.2 Gen 2
- 1x USB-C 3.2 Gen 2 (support display function and power-in [20V and >45W])
- 1x DisplayPort
- 1x Ethernet (RJ-45)

Optional Rear Ports

- 1x DC-in 3pin Phoenix connector on SE30 IO box
- 1x DIO (4DI / 4DO) on SE30 IO box

Notes:

ThinkCentre M75n IoT

1. The transfer speed of following ports will vary and, depending on many factors, such as the processing speed of the host device, file attributes and other factors related to system configuration and your operating environment, will be slower than theoretical speed.
USB 2.0: 480 Mbit/s;
USB 3.2 Gen 1 (SuperSpeed USB 5Gbps, formerly USB 3.0 / USB 3.1 Gen 1): 5 Gbit/s;
USB 3.2 Gen 2 (SuperSpeed USB 10Gbps, formerly USB 3.1 Gen 2): 10 Gbit/s;
USB 3.2 Gen 2x2 (SuperSpeed USB 20Gbps): 20 Gbit/s;
Thunderbolt™ 3: 40 Gbit/s;
FireWire 400: 400 Mbit/s;
FireWire 800: 800 Mbit/s
2. For video ports on discrete graphics, please see graphics section

Monitor Cable

Monitor Cable***

- USB-C to DP dongle
- USB-C to HDMI® dongle
- USB-C to VGA dongle
- DP to HDMI 1.4 dongle
- DP to VGA dongle
- No monitor cable

SECURITY & PRIVACY

Security

Security Chip

Discrete TPM 2.0, TCG certified

Physical Locks

Kensington® Security Slot

Chassis Intrusion Switch

Chassis intrusion switch

Fingerprint Reader

- Touch style fingerprint reader on mouse
- No fingerprint reader

BIOS Security

- Administrator password
- Power-on password
- Hard disk password
- Boot sequence control
- Boot without keyboard and mouse
- Smart USB protection (allows keyboard / mouse only, blocks all storage devices)
- Individual USB port disablement

MANAGEABILITY

System Management

System Management

DASH 1.1 / 1.2

SERVICE

Warranty

Base Warranty**

- 1-year depot service
- 1-year limited onsite service
- 3-year limited onsite service
- No base warranty

ENVIRONMENTAL

Operating Environment

Temperature

- Storage: -40°C (-40°F) to 60°C (140°F)
- Operating:
 - From 10°C (50°F) to 50°C (122°F): for the machine types of 11GW and 11GX
 - From 10°C (50°F) to 35°C (95°F): for the machine types of 11BW and 11BX

Humidity

- Operating: 20% to 80%
- Storage: 10% to 90%

Altitude

- Operating: -15.2 m (-50 ft) to 3048 m (10,000 ft)
- Storage: -15.2 m (-50 ft) to 12192 m (40,000 ft)

CERTIFICATIONS

Green Certifications

Green Certifications^[1]

- EPEAT™ Silver
- ENERGY STAR® 8.0
- ErP Lot 3
- TCO Certified 8.0
- RoHS compliant
- REACH
- WEEE

Notes:

1. ENERGY STAR 8.0 and EPEAT are not available for the models with I/O box

Other Certifications

Other Certifications

TÜV Rheinland® Ultra Low Noise

Mil-Spec Test

- MIL-STD-810H military test passed (Low Pressure [Altitude], High Temperature, Low Temperature, Temperature Shock, Humidity, Sand and Dust, Vibration, Shock, Fungus, Solar Radiation)
- None

- Feature with ** means that only one offering listed under the feature is configured on selected models.
- Feature with *** means that one or more offerings listed under the feature could be configured on selected models.
- Lenovo reserves the right to change specifications or other product information without notice. Lenovo is not responsible for photographic or typographical errors. LENOVO PROVIDES THIS PUBLICATION “AS IS,” WITHOUT WARRANTY OF ANY KIND, EITHER EXPRESS OR IMPLIED, INCLUDING THE IMPLIED WARRANTIES OF MERCHANTABILITY OR FITNESS FOR A PARTICULAR PURPOSE. Some jurisdictions do not allow disclaimer of express or implied warranties in certain transactions, therefore this disclaimer may not apply to you.
- The specifications on this page may not be available in all regions, and may be changed or updated without notice.



AMD



AMD



AMD



AMD



AMD



AMD

OVERVIEW

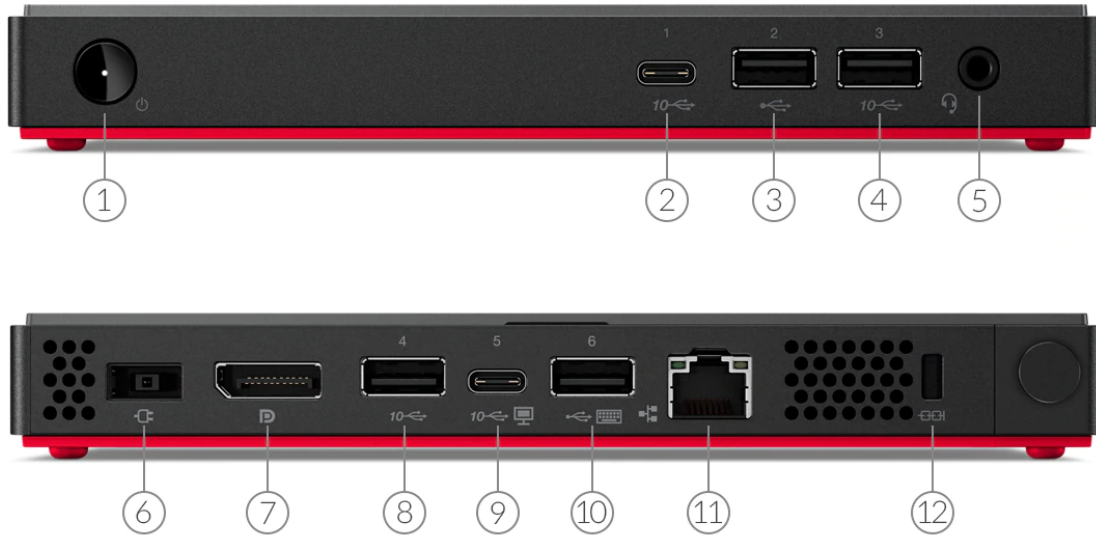

1. Power button	7. DisplayPort
2. USB-C 3.2 Gen 2	8. USB 3.2 Gen 2
3. USB 2.0	9. USB-C 3.2 Gen 2 (display and power-in)
4. USB 3.2 Gen 2	10. USB 2.0
5. Headphone / microphone combo jack (3.5mm)	11. Ethernet (RJ-45)
6. Power connector	

PERFORMANCE

Processor

Processor Family

AMD Ryzen™ 3 Processor

Processor

Processor Name	Cores	Threads	Base Frequency	Max Frequency	Cache	Memory Support	Processor Graphics
AMD Ryzen 3 PRO 3300U	4	4	2.1GHz	3.5GHz	2MB L2 / 4MB L3	DDR4-2400	AMD Radeon™ Vega 6 Graphics

Operating System

Operating System**

- Windows® 10 IoT Enterprise
- Windows Embedded Standard 7 V2 (WES 7 V2)
- Ubuntu Linux
- No operating system

Graphics

Graphics^[1]

Graphics	Type	Memory	Connector	Max Resolution	Key Features
AMD Radeon Vega 6 Graphics	Integrated	Shared	1x DisplayPort™, 1x USB-C	3840x2160@60Hz(DP), 3840x2160@60Hz(USB-C)	DirectX® 12

Notes:

1. The information of integrated graphics are not applicable for the models without integrated graphics (for the details, please refer to processor section)

Monitor Support

Monitor Support

Supports up to 2 independent displays via onboard ports (DisplayPort and USB-C)

Chipset

Chipset

AMD SoC (System on Chip) platform

Memory

Max Memory^[1]

8GB soldered memory, not upgradable

Memory Slots

Memory soldered to systemboard, no slots, dual-channel

Memory Type

DDR4-2400

Notes:

1. The max memory is based on the test results with current Lenovo® memory offerings. The system may support more memory as the technology develops.

Storage

Storage Support

Up to two drives, 2x M.2 SSD

- M.2 SSD up to 256GB each

Storage Type***

Disk Type	Interface	RPM	Security

ThinkCentre M75n Thin Client

M.2 2242 SSD	PCIe NVMe, PCIe 3.0 x2	-	-
M.2 2242 SSD	PCIe NVMe, PCIe 3.0 x4	-	-
M.2 2280 SSD	PCIe NVMe, PCIe 3.0 x4	-	Opal
M.2 2280 SSD	SATA 6Gb/s	-	Opal

RAID

No support

Removable Storage

Optical

None

Card Reader

No card reader

Multi-Media

Audio Chip

High Definition (HD) Audio, Realtek® ALC233 codec

Speakers

Single speaker, 1W x1

Power Supply

Power Supply

Power	Type	Efficiency	Key Features
65W	Adapter	89%	Autosensing
No power supply	-	-	-

DESIGN

Input Device

Keyboard**

- Lenovo Calliope Keyboard (USB connector), black
- Lenovo Calliope Wireless Keyboard (2.4GHz via USB receiver), black
- Lenovo Traditional Keyboard (USB connector), black
- No keyboard

Mouse**

- Lenovo Calliope Mouse (USB connector), black
- Lenovo Calliope Wireless Mouse (2.4GHz via USB receiver), black
- No mouse

Mechanical

Form Factor

Nano (0.35L)

Dimensions (WxDxH)

Models	Dimensions
All models	179 x 88 x 22 mm (7.05 x 3.46 x 0.87 inches)

Weight

Models	Weight
All models	0.505 kg (1.11 lbs)

Case Color

Iron grey (top cover), black (mid bezel), red (bottom cover)

Bays

ThinkCentre M75n Thin Client

No bays

Expansion Slots

- One M.2 slot (for WLAN)
- Two M.2 slots (for SSD, one supports up to PCIe 3.0 x4, one supports up to PCIe 3.0 x2 or SATA interface)

Stand

No stand

IO Box

No IO box

Mounting**

- VESA mount bracket kit with adapter holder, supports VESA mount 75mm and 100mm
- VESA mount bracket kit, supports VESA mount 75mm and 100mm
- DIN rail mount bracket kit
- None

CONNECTIVITY

Network

Onboard Ethernet

Gigabit Ethernet, Realtek RTL8111FP-CG, 1x RJ45, supports Wake-on-LAN

Optional Ethernet

No optional Ethernet

WLAN + Bluetooth®**

- Realtek RTL8852AE, Wi-Fi® 6, 802.11ax Dual Band 2x2 Wi-Fi + Bluetooth 5.2, M.2 card
- Realtek RTL8822CE, 802.11ac Dual Band 2x2 Wi-Fi + Bluetooth 5.0, M.2 card
- Intel® Wireless-AC 9260, 802.11ac Dual Band 2x2 Wi-Fi + Bluetooth 5.0, M.2 card
- No WLAN and Bluetooth

Ports^[1]

Front Ports

- 1x USB 2.0
- 1x USB 3.2 Gen 2
- 1x USB-C 3.2 Gen 2
- 1x headphone / microphone combo jack (3.5mm)

Rear Ports^[2]

- 1x USB 2.0
- 1x USB 3.2 Gen 2
- 1x USB-C 3.2 Gen 2 (support display function and power-in [20V and >45W])
- 1x DisplayPort
- 1x Ethernet (RJ-45)

Notes:

1. The transfer speed of following ports will vary and, depending on many factors, such as the processing speed of the host device, file attributes and other factors related to system configuration and your operating environment, will be slower than theoretical speed.
USB 2.0: 480 Mbit/s;
USB 3.2 Gen 1 (SuperSpeed USB 5Gbps, formerly USB 3.0 / USB 3.1 Gen 1): 5 Gbit/s;
USB 3.2 Gen 2 (SuperSpeed USB 10Gbps, formerly USB 3.1 Gen 2): 10 Gbit/s;
USB 3.2 Gen 2x2 (SuperSpeed USB 20Gbps): 20 Gbit/s;
Thunderbolt™ 3: 40 Gbit/s;
FireWire 400: 400 Mbit/s;
FireWire 800: 800 Mbit/s
2. For video ports on discrete graphics, please see graphics section

Monitor Cable

Monitor Cable***

- USB-C to DP dongle
- USB-C to HDMI® dongle
- USB-C to VGA dongle
- DP to HDMI 1.4 dongle

- DP to VGA dongle
- No monitor cable

SECURITY & PRIVACY

Security

Security Chip

Discrete TPM 2.0, TCG certified

Physical Locks

Kensington® Security Slot

Chassis Intrusion Switch

Chassis intrusion switch

BIOS Security

- Administrator password
- Power-on password
- Hard disk password
- Boot sequence control
- Boot without keyboard and mouse
- Smart USB protection (allows keyboard / mouse only, blocks all storage devices)
- Individual USB port disablement

MANAGEABILITY

System Management

System Management

DASH 1.1 / 1.2

SERVICE

Warranty

Base Warranty**

- 1-year depot service
- 1-year limited onsite service
- 3-year limited onsite service
- No base warranty

ENVIRONMENTAL

Operating Environment

Temperature

- Operating: 5°C (41°F) to 35°C (95°F)
- Storage: -40°C (-40°F) to 60°C (140°F)

Humidity

- Operating: 20% to 80%
- Storage: 10% to 90%

Altitude

- Operating: -15.2 m (-50 ft) to 3048 m (10,000 ft)
- Storage: -15.2 m (-50 ft) to 12192 m (40,000 ft)

CERTIFICATIONS

Green Certifications

Green Certifications

- EPEAT™ Silver
- ENERGY STAR® 8.0
- ErP Lot 3
- TCO Certified 8.0
- RoHS compliant
- REACH
- WEEE

Other Certifications

Other Certifications

TÜV Rheinland® Ultra Low Noise

Mil-Spec Test

MIL-STD-810H military test passed (Low Pressure [Altitude], High Temperature, Low Temperature, Temperature Shock, Humidity, Sand and Dust, Vibration, Shock, Fungus, Solar Radiation)

- Feature with ** means that only one offering listed under the feature is configured on selected models.
- Feature with *** means that one or more offerings listed under the feature could be configured on selected models.
- Lenovo reserves the right to change specifications or other product information without notice. Lenovo is not responsible for photographic or typographical errors. LENOVO PROVIDES THIS PUBLICATION “AS IS,” WITHOUT WARRANTY OF ANY KIND, EITHER EXPRESS OR IMPLIED, INCLUDING THE IMPLIED WARRANTIES OF MERCHANTABILITY OR FITNESS FOR A PARTICULAR PURPOSE. Some jurisdictions do not allow disclaimer of express or implied warranties in certain transactions, therefore this disclaimer may not apply to you.
- The specifications on this page may not be available in all regions, and may be changed or updated without notice.



AMD



AMD



AMD



AMD



AMD



AMD

OVERVIEW

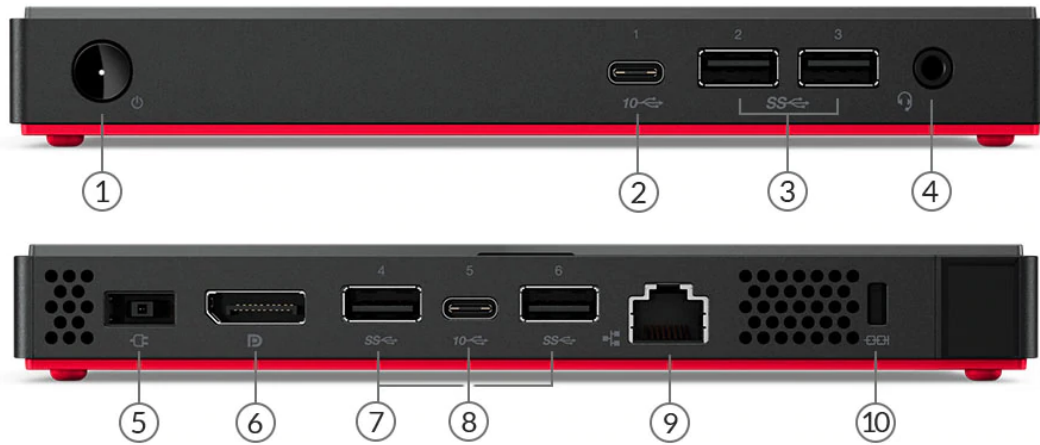

1. Power button	6. DisplayPort
2. USB-C 3.2 Gen 2	7. 2x USB 3.2 Gen 2
3. 2x USB 3.2 Gen 2	8. USB-C 3.2 Gen 2 (display and power-in)
4. Headphone / microphone combo jack (3.5mm)	9. Ethernet (RJ-45)
5. Power connector	10. Kensington Security Slot

PERFORMANCE

Processor

Processor Family

8th Generation Intel® Core™ i3 / i5 / i7 Processor

Processor**

Processor Name	Cores	Threads	Base Frequency	Max Frequency	Cache	Memory Support	Processor Graphics
Core i3-8145U	2	4	2.1GHz	3.9GHz	4MB	DDR4-2400	Intel UHD Graphics
Core i5-8265U	4	8	1.6GHz	3.9GHz	6MB	DDR4-2400	Intel UHD Graphics
Core i5-8365U	4	8	1.6GHz	4.1GHz	6MB	DDR4-2400	Intel UHD Graphics
Core i7-8665U	4	8	1.9GHz	4.8GHz	8MB	DDR4-2400	Intel UHD Graphics

Operating System

Operating System**

- Windows® 10 Pro 64
- Windows 10 Home 64
- Windows 10 IoT Enterprise
- Ubuntu Linux
- No operating system

Graphics

Graphics^[1]

Graphics	Type	Memory	Connector	Max Resolution	Key Features
Intel UHD Graphics 620	Integrated	Shared	1x DP, 1 USB-C	4096x2304@60Hz(DP); 4096x2304@60Hz(USB-C)	DirectX® 12

Notes:

1. The information of integrated graphics are not applicable for the models without integrated graphics (for the details, please refer to processor section)

Monitor Support

Monitor Support

Supports up to 2 independent displays via onboard ports (DisplayPort™ and USB-C)

Chipset

Chipset

Intel SoC (System on Chip) platform

Memory

Max Memory^[1]

- 4GB soldered memory, not upgradable
- 8GB soldered memory, not upgradable
- 16GB soldered memory, not upgradable

Memory Slots

Memory soldered to systemboard, no slots

Memory Type^[2]

DDR4-2666

Notes:

1. The max memory is based on the test results with current Lenovo® memory offerings. The system may support more memory as the technology develops.
2. Installed memory is actually 2666MHz, but runs at 2400MHz due to the memory support capability of processor

Storage

Storage Support

Up to two drives, 2x M.2 SSD

- M.2 SSD up to 1TB each
- Optional Intel Optane™ Memory Integrated with SSD, M.2

Storage Type***

Disk Type	Interface	RPM	Security
M.2 2242 SSD	PCIe NVMe, PCIe 3.0 x2	-	-
M.2 2280 SSD	PCIe NVMe, PCIe 3.0 x4	-	Opal
Intel Optane Memory with Solid State Storage, M.2 2280	PCIe NVMe, PCIe 3.0 x4	-	-

RAID

RAID 0/1 support for M.2 SSDs (RAID preset only available via special bid model)

Removable Storage

Optical

None

Card Reader

No card reader

Multi-Media

Audio Chip

High Definition (HD) Audio, Realtek® ALC233VB codec

Speakers

Single speaker, 1W x1

Power Supply

Power Supply

Power	Type	Efficiency	Key Features
65W	Adapter	88%	-
No power supply	-	-	-

DESIGN

Input Device

Keyboard**

- Lenovo Calliope Keyboard (USB connector), black
- Lenovo Calliope Wireless Keyboard (2.4GHz via USB receiver), black
- Lenovo Traditional Keyboard (USB connector), black
- No keyboard

Mouse**

- Lenovo Calliope Mouse (USB connector), black
- Lenovo Calliope Wireless Mouse (2.4GHz via USB receiver), black
- Lenovo Fingerprint Mouse (USB connector), Windows Hello support, black
- No mouse

Mechanical

Form Factor

Nano (0.35L)

Dimensions (WxDxH)

Models	Dimensions
All models	179 x 88 x 22 mm (7.05 x 3.46 x 0.87 inches)

Weight

Models	Weight
All models	0.505 kg (1.11 lbs)

Case Color

Iron grey (top cover), black (mid bezel), red (bottom cover)

Bays

No bays

Expansion Slots

Three M.2 slots (one for WLAN, two for SSD)

Stand

No stand

IO Box

No IO box

Mounting**

- VESA mount bracket kit with adapter holder, supports VESA mount 75mm and 100mm
- VESA mount bracket kit, supports VESA mount 75mm and 100mm
- DIN rail mount bracket kit
- None

CONNECTIVITY**Network****Onboard Ethernet****

- Gigabit Ethernet, Intel Ethernet Connection I219-V, 1x RJ45, supports Wake-on-LAN
- Gigabit Ethernet, Intel Ethernet Connection I219-LM, 1x RJ45, supports Wake-on-LAN

Optional Ethernet

No optional Ethernet

WLAN + Bluetooth**

- 802.11ac 1x1 Wi-Fi® + Bluetooth 5.0, M.2 card
- Realtek RTL8822CE, 802.11ac Dual Band 2x2 Wi-Fi + Bluetooth 5.0, M.2 card
- Intel Wireless-AC 9462, 802.11ac Dual Band 1x1 Wi-Fi + Bluetooth 5.0, M.2 card
- Intel Wireless-AC 9560, 802.11ac Dual Band 2x2 Wi-Fi + Bluetooth 5.0, Intel vPro technology support, M.2 card
- Intel Wireless-AC 9560, 802.11ac Dual Band 2x2 Wi-Fi + Bluetooth 5.0, M.2 card
- No WLAN and Bluetooth

Ports^[1]**Front Ports**

- 2x USB 3.2 Gen 2
- 1x USB-C 3.2 Gen 2
- 1x headphone / microphone combo jack (3.5mm)

Rear Ports^[2]

- 2x USB 3.2 Gen 2
- 1x USB-C 3.2 Gen 2 (support display function and power-in [20V and >45W])
- 1x DisplayPort
- 1x Ethernet (RJ-45)

Notes:

1. The transfer speed of following ports will vary and, depending on many factors, such as the processing speed of the host device, file attributes and other factors related to system configuration and your operating environment, will be slower than theoretical speed.
USB 2.0: 480 Mbit/s;
USB 3.2 Gen 1 (SuperSpeed USB 5Gbps, formerly USB 3.0 / USB 3.1 Gen 1): 5 Gbit/s;
USB 3.2 Gen 2 (SuperSpeed USB 10Gbps, formerly USB 3.1 Gen 2): 10 Gbit/s;
USB 3.2 Gen 2x2 (SuperSpeed USB 20Gbps): 20 Gbit/s;
Thunderbolt™ 3: 40 Gbit/s;
FireWire 400: 400 Mbit/s;
FireWire 800: 800 Mbit/s
2. For video ports on discrete graphics, please see graphics section

Monitor Cable

Monitor Cable***

- USB-C to DP dongle
- USB-C to HDMI® dongle
- USB-C to VGA dongle
- DP to HDMI 1.4 dongle
- DP to VGA dongle
- No monitor cable

SECURITY & PRIVACY

Security

Security Chip

Discrete TPM 2.0, TCG certified

Physical Locks

Kensington® Security Slot

Chassis Intrusion Switch

Chassis intrusion switch

Fingerprint Reader

- Touch style fingerprint reader on mouse
- No fingerprint reader

BIOS Security

- Administrator password
- Power-on password
- Hard disk password
- Boot sequence control
- Boot without keyboard and mouse
- Smart USB protection (allows keyboard / mouse only, blocks all storage devices)
- Individual USB port disablement

MANAGEABILITY

System Management

System Management

- Intel vPro Technology, DASH
- None

SERVICE

Warranty

Base Warranty**

- 1-year limited onsite service
- 3-year limited onsite service
- No base warranty

ENVIRONMENTAL

Operating Environment

Temperature

- Operating: 5°C (41°F) to 35°C (95°F)
- Storage: -40°C (-40°F) to 60°C (140°F)

Humidity

- Operating: 20% to 80%

- Storage: 10% to 90%

Altitude

- Operating: -15.2 m (-50 ft) to 3048 m (10,000 ft)
- Storage: -15.2 m (-50 ft) to 12192 m (40,000 ft)

CERTIFICATIONS

Green Certifications

Green Certifications

- EPEAT™ Silver
- ENERGY STAR® 8.0
- ErP Lot 3
- TCO Certified 8.0
- RoHS compliant
- REACH
- WEEE

Other Certifications

Other Certifications

(Optional) TÜV Rheinland® Ultra Low Noise

Mil-Spec Test

MIL-STD-810H military test passed (Low Pressure [Altitude], High Temperature, Low Temperature, Temperature Shock, Humidity, Sand and Dust, Vibration, Shock, Fungus, Solar Radiation)

- Feature with ** means that only one offering listed under the feature is configured on selected models.
- Feature with *** means that one or more offerings listed under the feature could be configured on selected models.
- Lenovo reserves the right to change specifications or other product information without notice. Lenovo is not responsible for photographic or typographical errors. LENOVO PROVIDES THIS PUBLICATION “AS IS,” WITHOUT WARRANTY OF ANY KIND, EITHER EXPRESS OR IMPLIED, INCLUDING THE IMPLIED WARRANTIES OF MERCHANTABILITY OR FITNESS FOR A PARTICULAR PURPOSE. Some jurisdictions do not allow disclaimer of express or implied warranties in certain transactions, therefore this disclaimer may not apply to you.
- The specifications on this page may not be available in all regions, and may be changed or updated without notice.

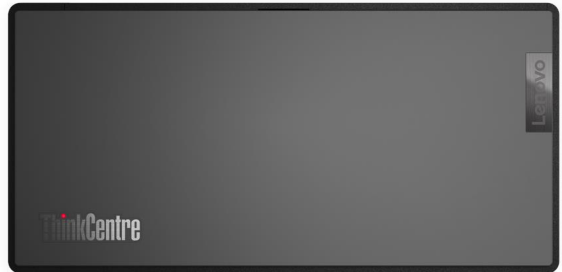

OVERVIEW

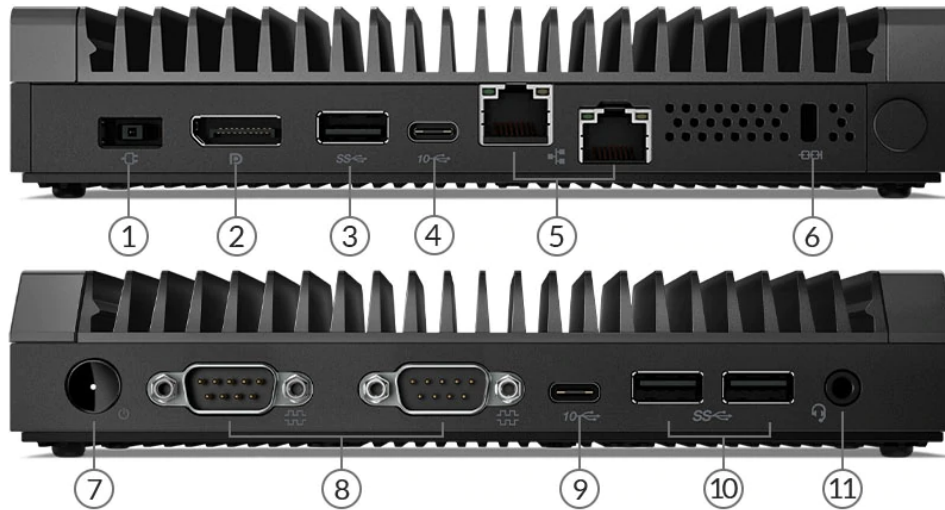

1. Power connector	7. Power button
2. HDMI (for 8145UE models) / DP (for others)	8. 2x Serial (RS232)
3. USB 3.2 Gen 2 (USB 2.0 for Celeron models)	9. USB-C 3.2 Gen 2
4. USB-C 3.2 Gen 2 (display and power-in)	10. 2x USB 3.2 Gen 2
5. 2x Ethernet (1x Ethernet for Celeron)	11. Headphone / microphone combo jack (3.5mm)
6. Kensington Security Slot	

PERFORMANCE

Processor

Processor Family

Intel® Celeron® or 8th Generation Intel Core™ i3 / i5 Processor

Processor**

Processor Name	Cores	Threads	Base Frequency	Max Frequency	Cache	Memory Support	Processor Graphics
Celeron 4205U	2	2	1.8GHz	-	2MB	DDR4-2133	Intel UHD Graphics
Celeron 4305UE	2	2	2.0GHz	-	2MB	DDR4-2133	Intel UHD Graphics 610
Core i3-8145U	2	4	2.1GHz	3.9GHz	4MB	DDR4-2400	Intel UHD Graphics
Core i3-8145UE	2	4	2.2GHz	3.9GHz	4MB	DDR4-2400	Intel UHD Graphics 620
Core i5-8365U	4	8	1.6GHz	4.1GHz	6MB	DDR4-2400	Intel UHD Graphics

Operating System

Operating System**

- Windows® 10 Pro 64
- Windows 10 Home 64
- Windows 10 IoT Enterprise
- FreeDOS
- Ubuntu Linux
- No operating system

Graphics

Graphics**^[1]

Graphics	Type	Memory	Connector	Max Resolution	Key Features
Intel UHD Graphics 610	Integrated	Shared	1x DP, 1 USB-C	4096x2304@60Hz(DP); 4096x2304@60Hz(USB-C)	DirectX® 12
Intel UHD Graphics 620	Integrated	Shared	1x HDMI®, 1 USB-C	4096x2304@60Hz(USB-C)	DirectX 12
Intel UHD graphics	Integrated	Shared	1x DP, 1x USB-C	4096x2304@60Hz(DP), 4096x2304@60Hz(USB-C)	DirectX 12

Notes:

1. The information of integrated graphics are not applicable for the models without integrated graphics (for the details, please refer to processor section)

Monitor Support

Monitor Support

Supports up to 2 independent displays via onboard ports (DisplayPort™ and USB-C, 8145UE models support HDMI and USB-C)

Chipset

Chipset

Intel SoC (System on Chip) platform

Memory

Max Memory^[1]

- 4GB soldered memory, not upgradable
- 8GB soldered memory, not upgradable

Memory Slots

Memory soldered to systemboard, no slots

Memory Type^[2]

ThinkCentre M90n-1 Nano IoT

DDR4-2666

Notes:

1. The max memory is based on the test results with current Lenovo® memory offerings. The system may support more memory as the technology develops.
2. Installed memory is actually 2666MHz, but runs at 2133MHz or 2400MHz depending on the memory support capability of processor.

Storage

Storage Support

Up to two drives, 2x M.2 SSD

- M.2 SSD up to 1TB each
- Optional Intel Optane™ Memory Integrated with SSD, M.2

Storage Type***

Disk Type	Interface	RPM	Security
M.2 2242 SSD	PCIe NVMe, PCIe 3.0 x2	-	-
M.2 2280 SSD	PCIe NVMe, PCIe 3.0 x4	-	Opal
Intel Optane Memory with Solid State Storage, M.2 2280	PCIe NVMe, PCIe 3.0 x4	-	-

RAID

RAID 0/1 support for M.2 SSDs (RAID preset only available via special bid model)

Removable Storage

Optical

None

Card Reader

No card reader

Multi-Media

Audio Chip

High Definition (HD) Audio, Realtek® ALC233VB codec

Speakers

Single speaker, 1W x1

Power Supply

Power Supply**

Power	Type	Efficiency	Key Features
65W	Adapter	88%	Autosensing, wide temperature
65W	Adapter	88%	-
No power supply	-	-	-

DESIGN

Input Device

Keyboard**

- Lenovo Calliope Keyboard (USB connector), black
- Lenovo Calliope Wireless Keyboard (2.4GHz via USB receiver), black
- Lenovo Traditional Keyboard (USB connector), black
- No keyboard

Mouse**

- Lenovo Calliope Mouse (USB connector), black
- Lenovo Calliope Wireless Mouse (2.4GHz via USB receiver), black
- Lenovo Fingerprint Mouse (USB connector), Windows Hello support, black
- No mouse

Mechanical

Form Factor

Nano (0.55L)

Dimensions (WxDxH)

Models	Dimensions
Nano only	179 x 88 x 34.5 mm (7.05 x 3.46 x 1.36 inches)
Nano with IO box	179 x 88 x 61.3 mm (7.05 x 3.46 x 2.41 inches)

Weight

Models	Weight
Nano only	0.72 kg (1.58 lbs)
Nano with IO box	1.2 kg (2.65 lbs)

Case Color

Iron grey (top cover), black (mid bezel), black (bottom cover)

Bays

No bays

Expansion Slots

Three M.2 slots (one for WLAN, two for SSD)

Stand

No stand

IO Box

- IO box: 2x serial (RS232 / RS422 / RS485, SDK selectable) and 2x Ethernet (RJ-45, Realtek RTL8153B, gigabit Ethernet) on front, 1x DIO (4DI / 4DO), 1x USB-C (connect to Nano) and 1x DC-in connector (9V - 36V) on rear
- No IO box

Mounting**

- VESA mount bracket kit with adapter holder, supports VESA mount 75mm and 100mm
- VESA mount bracket kit, supports VESA mount 75mm and 100mm
- DIN rail mount bracket kit
- None

CONNECTIVITY

Network

Onboard Ethernet***

- Two gigabit Ethernet, Intel Ethernet Connection I219-LM and Realtek RTL8111H, 2x RJ45, supports Wake-on-LAN
- One gigabit Ethernet, Realtek RTL8111K, 1x RJ-45, supports Wake-on-LAN
- Two gigabit Ethernet, Realtek RTL8111K and RTL8111H, 2x RJ-45, supports Wake-on-LAN

Optional Ethernet

No optional Ethernet

WLAN + Bluetooth®**

- 802.11ac 1x1 Wi-Fi® + Bluetooth 5.0, M.2 card
- Realtek RTL8822CE, 802.11ac Dual Band 2x2 Wi-Fi + Bluetooth 5.0, M.2 card
- Intel Wireless-AC 9462, 802.11ac Dual Band 1x1 Wi-Fi + Bluetooth 5.0, M.2 card
- Intel Wireless-AC 9560, 802.11ac Dual Band 2x2 Wi-Fi + Bluetooth 5.0, Intel vPro technology support, M.2 card
- Intel Wireless-AC 9560, 802.11ac Dual Band 2x2 Wi-Fi + Bluetooth 5.0, M.2 card
- No WLAN and Bluetooth

WWAN

- Intel XMM 7360 4G, CAT9, M.2 Card
- No support

Ports^[1]

Front Ports

ThinkCentre M90n-1 Nano IoT

- 2x USB 3.2 Gen 2
- 1x USB-C 3.2 Gen 2
- 1x headphone / microphone combo jack (3.5mm)
- 2x serial (RS-232)

Optional Front Ports

- 2x gigabit Ethernet (RJ-45) on SE30 IO box
- 2x serial (RS232 / RS422 / RS485, SDK selectable) on SE30 IO box

Rear Ports^[2]

- 1x USB 2.0 (for Celeron models)
- 1x USB 3.2 Gen 2 (for i3 / i5 models only)
- 1x USB-C 3.2 Gen 2 (support display function and power-in [20V and >45W])
- 1x HDMI (for 8145UE models)
- 1x DisplayPort (for 4205U / 4305UE / 8145U / 8365U models)
- 1x Ethernet (RJ-45, for Celeron models)
- 2x Ethernet (RJ-45, for i3 / i5 models)

Optional Rear Ports

- 1x DC-in 3pin Phoenix connector on SE30 IO box
- 1x DIO (4DI / 4DO) on SE30 IO box

Notes:

1. The transfer speed of following ports will vary and, depending on many factors, such as the processing speed of the host device, file attributes and other factors related to system configuration and your operating environment, will be slower than theoretical speed.
USB 2.0: 480 Mbit/s;
USB 3.2 Gen 1 (SuperSpeed USB 5Gbps, formerly USB 3.0 / USB 3.1 Gen 1): 5 Gbit/s;
USB 3.2 Gen 2 (SuperSpeed USB 10Gbps, formerly USB 3.1 Gen 2): 10 Gbit/s;
USB 3.2 Gen 2x2 (SuperSpeed USB 20Gbps): 20 Gbit/s;
Thunderbolt™ 3: 40 Gbit/s;
FireWire 400: 400 Mbit/s;
FireWire 800: 800 Mbit/s
2. For video ports on discrete graphics, please see graphics section

Monitor Cable

Monitor Cable***

- USB-C to DP dongle
- USB-C to HDMI dongle
- USB-C to VGA dongle
- DP to HDMI 1.4 dongle
- DP to VGA dongle
- No monitor cable

SECURITY & PRIVACY

Security

Security Chip

Discrete TPM 2.0, TCG certified

Physical Locks

Kensington® Security Slot

Chassis Intrusion Switch

Chassis intrusion switch

Fingerprint Reader

- Touch style fingerprint reader on mouse
- No fingerprint reader

BIOS Security

- Administrator password
- Power-on password
- Hard disk password
- Boot sequence control
- Boot without keyboard and mouse
- Individual USB port disablement

MANAGEABILITY

System Management

System Management

- Intel vPro Technology, DASH
- None

SERVICE

Warranty

Base Warranty**

- 1-year limited onsite service
- 3-year limited onsite service
- No base warranty

ENVIRONMENTAL

Operating Environment

Temperature

- Storage: -40°C (-40°F) to 60°C (140°F)
- Operating:
 - From 0°C (32°F) to 50°C (122°F): for the machine types of 11AK, 11AL, 11AM, 11AS, 11J3, 11J4, 11J7, and 11J8
 - From 0°C (32°F) to 35°C (95°F): for the machine types of 11AH and 11AJ

Humidity

- Operating: 20% to 80%
- Storage: 10% to 90%

Altitude

- Operating: -15.2 m (-50 ft) to 3048 m (10,000 ft)
- Storage: -15.2 m (-50 ft) to 12192 m (40,000 ft)

CERTIFICATIONS

Green Certifications

Green Certifications^[1]

- EPEAT™ Silver
- ENERGY STAR® 8.0
- ErP Lot 3
- TCO Certified 8.0
- RoHS compliant
- REACH
- WEEE

Notes:

1. Energy Star 8.0 and EPEAT not for the models with I/O box

Other Certifications

Other Certifications

(Optional) TÜV Rheinland® Ultra Low Noise

Mil-Spec Test^[1]

- MIL-STD-810H military test passed (Low Pressure [Altitude], High Temperature, Low Temperature, Temperature Shock, Humidity, Sand and Dust, Vibration, Shock, Fungus, Solar Radiation)
- None

Notes:

1. Not for the models with I/O box

- Feature with ** means that only one offering listed under the feature is configured on selected models.
- Feature with *** means that one or more offerings listed under the feature could be configured on selected models.
- Lenovo reserves the right to change specifications or other product information without notice. Lenovo is not responsible for photographic or typographical errors. LENOVO PROVIDES THIS PUBLICATION “AS IS,” WITHOUT WARRANTY OF ANY KIND, EITHER EXPRESS OR IMPLIED, INCLUDING THE IMPLIED WARRANTIES OF MERCHANTABILITY OR FITNESS FOR A PARTICULAR PURPOSE. Some jurisdictions do not allow disclaimer of express or implied warranties in certain transactions, therefore this disclaimer may not apply to you.
- The specifications on this page may not be available in all regions, and may be changed or updated without notice.



OVERVIEW

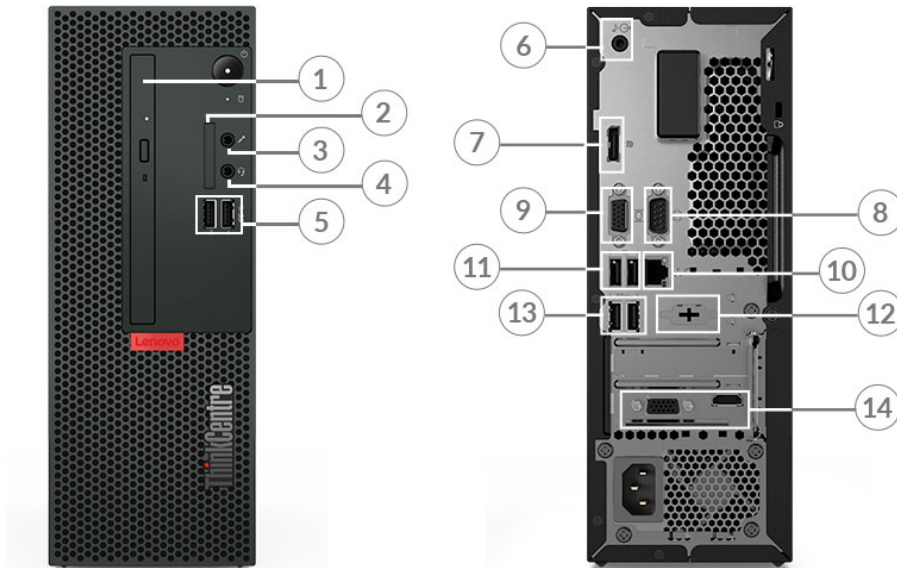

1. Optical drive *	8. Serial
2. Card reader *	9. VGA
3. Microphone (3.5mm)	10. Ethernet (RJ-45)
4. Headphone / microphone combo jack (3.5mm)	11. 2x USB 2.0
5. 2x USB 3.2 Gen 1	12. Serial *
6. Line-out (3.5mm)	13. 2x USB 3.2 Gen 1
7. DisplayPort	14. Optional ports on expansion cards

Notes:

- Ports with * are only available on selected models

PERFORMANCE

Processor

Processor Family

Intel® Celeron®, Intel Pentium®, or 10th Generation Intel Core™ i3 / i5 / i7 / i9 Processor

Processor**

Processor Name	Cores	Threads	Base Frequency	Max Frequency	Cache	Memory Support	Processor Graphics
Celeron G5900	2	2	3.4GHz	-	2MB	DDR4-2666	Intel UHD Graphics 610
Celeron G5905	2	2	3.5GHz	-	4MB	DDR4-2666	Intel UHD Graphics 610
Celeron G5920	2	2	3.5GHz	-	2MB	DDR4-2666	Intel UHD Graphics 610
Celeron G5925	2	2	3.6GHz	-	4MB	DDR4-2666	Intel UHD Graphics 610
Pentium Gold G6400	2	4	4.0GHz	-	4MB	DDR4-2666	Intel UHD Graphics 610
Pentium Gold G6405	2	4	4.1GHz	-	4MB	DDR4-2666	Intel UHD Graphics 610
Pentium Gold G6500	2	4	4.1GHz	-	4MB	DDR4-2666	Intel UHD Graphics 630
Pentium Gold G6600	2	4	4.2GHz	-	4MB	DDR4-2666	Intel UHD Graphics 630
Core i3-10100	4	8	3.6GHz	4.3GHz	6MB	DDR4-2666	Intel UHD Graphics 630
Core i3-10105	4	8	3.7GHz	4.4GHz	6MB	DDR4-2666	Intel UHD Graphics 630
Core i3-10300	4	8	3.7GHz	4.4GHz	8MB	DDR4-2666	Intel UHD Graphics 630
Core i3-10305	4	8	3.8GHz	4.5GHz	8MB	DDR4-2666	Intel UHD Graphics 630
Core i3-10320	4	8	3.8GHz	4.6GHz	8MB	DDR4-2666	Intel UHD Graphics 630
Core i5-10400	6	12	2.9GHz	4.3GHz	12MB	DDR4-2666	Intel UHD Graphics 630
Core i5-10500	6	12	3.1GHz	4.5GHz	12MB	DDR4-2666	Intel UHD Graphics 630
Core i5-10600	6	12	3.3GHz	4.8GHz	12MB	DDR4-2666	Intel UHD Graphics 630
Core i7-10700	8	16	2.9GHz	4.8GHz	16MB	DDR4-2933	Intel UHD Graphics 630
Core i7-10700F	8	16	2.9GHz	4.8GHz	16MB	DDR4-2933	-
Core i9-10900	10	20	2.8GHz	5.2GHz	20MB	DDR4-2933	Intel UHD Graphics 630
Core i9-10900F	10	20	2.8GHz	5.2GHz	20MB	DDR4-2933	-

Operating System

Operating System**

- Windows® 10 Pro 64
- Windows 10 Home 64
- Windows 10 IoT Enterprise
- Ubuntu Linux

Graphics

Graphics**[1]

Graphics	Type	Memory	Connector	Max Resolution	Key Features
Intel UHD graphics 610	Integrated	Shared	1x VGA, 1x DP	2048x1536@50Hz(VGA), 4096x2304@60Hz(DP)	DirectX® 12
Intel UHD graphics 630	Integrated	Shared	1x VGA, 1x DP	2048x1536@50Hz(VGA), 4096x2304@60Hz(DP)	DirectX 12
AMD Radeon™ 520	Discrete	2GB GDDR5	1x HDMI® 1.4, 1x VGA	3840x2160@30Hz(HDMI), 2048x1536@85Hz(VGA)	DirectX 12

Notes:

1. The information of integrated graphics are not applicable for the models without integrated graphics (for the details, please refer to processor section)

Monitor Support

Monitor Support

Supports up to 2 independent displays via onboard ports (VGA and DisplayPort™), more displays support via discrete graphics

Chipset

Chipset

Intel B460 chipset

Memory

Max Memory^[1]

Up to 32GB DDR4-2933

Memory Slots

Two DDR4 DIMM slots, dual-channel capable

Memory Type**

- DDR4-2666
- DDR4-2933

Notes:

1. The max memory is based on the test results with current Lenovo® memory offerings. The system may support more memory as the technology develops.

Storage

Storage Support

Up to two drives, 1x 2.5"/3.5" HDD + 1x M.2 SSD

- 2.5" HDD up to 1TB
- 3.5" HDD up to 1TB
- M.2 SSD up to 512GB
- Optional Intel Optane™ Memory, M.2

Storage Type***

Disk Type	Interface	RPM	Security
2.5" SATA HDD	SATA 6Gb/s	5.4K	-
2.5" SATA HDD	SATA 6Gb/s	7.2K	-
3.5" SATA HDD	SATA 6Gb/s	7.2K	-
M.2 2242 SSD	PCIe NVMe, PCIe 3.0 x2	-	-
M.2 2242 SSD	PCIe NVMe, PCIe 3.0 x4	-	-
M.2 2280 SSD	PCIe NVMe, PCIe 3.0 x4	-	Opal
Intel Optane Memory M10	PCIe NVMe, PCIe 3.0 x2	-	-

RAID

No support

Removable Storage

Optical**

- DVD-ROM, SATA 1.5Gb/s, slim (9.0mm)
- DVD burner (DVD±RW), SATA 1.5Gb/s, slim (9.0mm)
- None

Card Reader

- 7-in-1 card reader
- No card reader

Multi-Media

Audio Chip

High Definition (HD) Audio, Realtek® ALC623-CG codec or ALC897Q codec

Speakers

Single speaker, 1W x1

Power Supply**Power Supply****

Power	Type	Efficiency	Key Features
180W	Fixed	85%	-
260W	Fixed	85%	-

DESIGN**Input Device****Keyboard****

- Lenovo Calliope Keyboard (USB connector), black
- Lenovo Traditional Keyboard (USB connector), black
- No keyboard

Mouse

- Lenovo Calliope Mouse (USB connector), black
- No mouse

Mechanical**Form Factor**

SFF (7.4L)

Dimensions (WxDxH)⁽¹⁾

Models	Dimensions
All models	100 x 303.5 x 274.8 mm (3.9 x 11.9 x 10.8 inches)

Weight

Models	Weight
All models	4.5 kg (9.92 lbs)

Case Color

Black

Bays

- 1x 3.5" disk bay
- 1x slim ODD bay

Expansion Slots

- One PCIe 3.0 x1, low-profile (length < 152mm, height < 64mm)
- One PCIe 3.0 x16, low-profile (length < 152mm, height < 64mm)
- Two M.2 slots (one for WLAN, one for SSD)

Stand

- Vertical stand
- No stand

Notes:

1. Dimensions with bezel & PCI holder & rubber foot

CONNECTIVITY**Network****Onboard Ethernet**

Gigabit Ethernet, Realtek RTL8111HN, 1x RJ45, supports Wake-on-LAN

Optional Ethernet

- Gigabit Ethernet, Bitland BN8E88, 1x RJ-45, PCIe x1
- No optional Ethernet

WLAN + Bluetooth[®]*

- Realtek RTL8822CE, 802.11ac Dual Band 2x2 Wi-Fi[®] + Bluetooth 5.0, M.2 card
- Intel Wireless-AC 9260, 802.11ac Dual Band 2x2 Wi-Fi + Bluetooth 5.0, M.2 card
- No WLAN and Bluetooth

Ports^[1]**Front Ports**

- 2x USB 3.2 Gen 1
- 1x headphone / microphone combo jack (3.5mm)
- 1x microphone (3.5mm)

Optional Front Ports

- 1x card reader
- None

Rear Ports^[2]

- 2x USB 2.0
- 2x USB 3.2 Gen 1
- 1x VGA
- 1x DisplayPort
- 1x serial (9-pin)
- 1x Ethernet (RJ-45)
- 1x line-out (3.5mm)

Optional Rear Ports^{*}**

- 2x USB 2.0 (via 2-port adapter)
- 1x serial
- 1x parallel
- 2x PS/2

Notes:

1. The transfer speed of following ports will vary and, depending on many factors, such as the processing speed of the host device, file attributes and other factors related to system configuration and your operating environment, will be slower than theoretical speed.
USB 2.0: 480 Mbit/s;
USB 3.2 Gen 1 (SuperSpeed USB 5Gbps, formerly USB 3.0 / USB 3.1 Gen 1): 5 Gbit/s;
USB 3.2 Gen 2 (SuperSpeed USB 10Gbps, formerly USB 3.1 Gen 2): 10 Gbit/s;
USB 3.2 Gen 2x2 (SuperSpeed USB 20Gbps): 20 Gbit/s;
Thunderbolt™ 3: 40 Gbit/s;
FireWire 400: 400 Mbit/s;
FireWire 800: 800 Mbit/s
2. For video ports on discrete graphics, please see graphics section

Monitor Cable**Monitor Cable^{***}**

- DP to dual DP dongle
- DP to DVI-D dongle
- DP to HDMI 1.4 dongle
- DP to VGA dongle
- No monitor cable

SECURITY & PRIVACY**Security****Security Chip**

Discrete TPM 2.0, TCG certified

Physical Locks

- (Optional) Smart Cable Clip
- Kensington® Security Slot
- Padlock Loop

Chassis Intrusion Switch

- Chassis intrusion switch
- No chassis intrusion switch

Fingerprint Reader

- Touch style fingerprint reader on mouse
- No fingerprint reader

BIOS Security

- Administrator password
- Power-on password
- Hard disk password
- Boot sequence control
- Boot without keyboard and mouse
- Smart USB protection (allows keyboard / mouse only, blocks all storage devices)
- Individual USB port disablement

MANAGEABILITY

System Management

System Management

None

SERVICE

Warranty

Base Warranty**

- 1-year depot service
- 1-year limited onsite service
- 3-year limited onsite service
- No base warranty

ENVIRONMENTAL

Operating Environment

Temperature

- Operating: 5°C (41°F) to 35°C (95°F)
- Storage: -40°C (-40°F) to 60°C (140°F)

Humidity

- Operating: 20% to 80%
- Storage: 10% to 90%

Altitude

- Operating: -15.2 m (-50 ft) to 3048 m (10,000 ft)
- Storage: -15.2 m (-50 ft) to 12192 m (40,000 ft)

CERTIFICATIONS

Green Certifications

Green Certifications^[1]

- (Optional) EPEAT™ Silver
- (Optional) ENERGY STAR® 8.0
- ErP Lot 3
- RoHS compliant

Notes:

1. ENERGY STAR 8.0 and EPEAT are only available for MT 11GK/11GJ

Other Certifications

Other Certifications

- (Optional) TÜV Rheinland® Low Noise
- (Optional) TÜV Rheinland Ultra Low Noise

- Feature with ** means that only one offering listed under the feature is configured on selected models.
- Feature with *** means that one or more offerings listed under the feature could be configured on selected models.
- Lenovo reserves the right to change specifications or other product information without notice. Lenovo is not responsible for photographic or typographical errors. LENOVO PROVIDES THIS PUBLICATION “AS IS,” WITHOUT WARRANTY OF ANY KIND, EITHER EXPRESS OR IMPLIED, INCLUDING THE IMPLIED WARRANTIES OF MERCHANTABILITY OR FITNESS FOR A PARTICULAR PURPOSE. Some jurisdictions do not allow disclaimer of express or implied warranties in certain transactions, therefore this disclaimer may not apply to you.
- The specifications on this page may not be available in all regions, and may be changed or updated without notice.

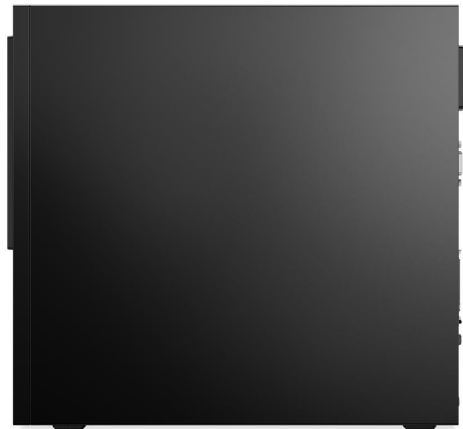

OVERVIEW

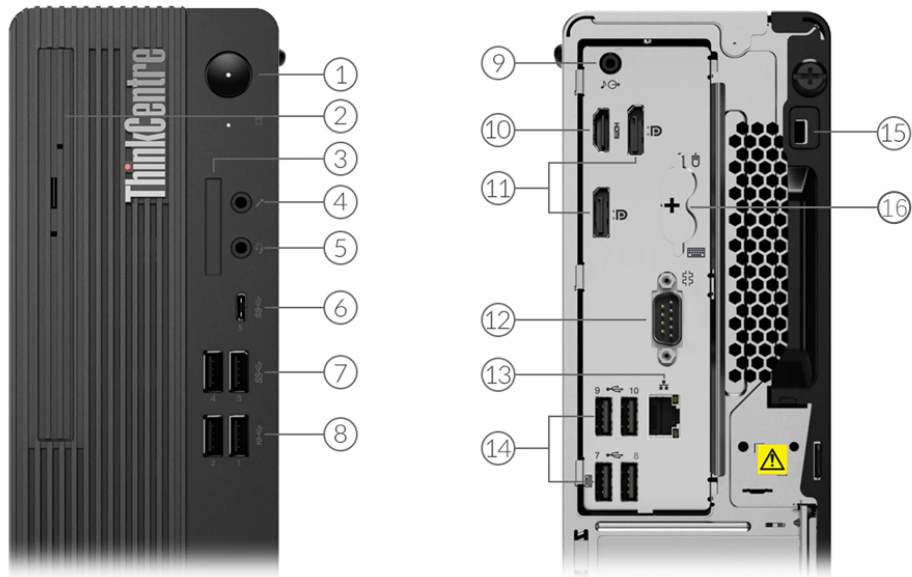

1. Power button	9. Line-out (3.5mm)
2. Optical drive *	10. HDMI
3. Card reader *	11. 2x DisplayPort
4. Microphone (3.5mm)	12. Serial
5. Headphone / microphone combo jack (3.5mm)	13. Ethernet (RJ-45)
6. USB-C 3.2 Gen 1	14. 4x USB 2.0
7. 2x USB 3.2 Gen 1	15. Kensington Security Slot
8. 2x USB 3.2 Gen 2	16. 2x PS/2 ports (keyboard / mouse) *

Notes:

- Ports with * are only available on selected models
- More ports are available through the optional expansion cards (not shown on the sample product above)

PERFORMANCE

Processor

Processor Family

Intel® Celeron®, Intel Pentium®, or 10th Generation Intel Core™ i3 / i5 / i7 / i9 Processor

Processor**

Processor Name	Cores	Threads	Base Frequency	Max Frequency	Cache	Memory Support	Processor Graphics
Celeron G5900	2	2	3.4GHz	-	2MB	DDR4-2666	Intel UHD Graphics 610
Celeron G5905	2	2	3.5GHz	-	4MB	DDR4-2666	Intel UHD Graphics 610
Celeron G5920	2	2	3.5GHz	-	2MB	DDR4-2666	Intel UHD Graphics 610
Celeron G5925	2	2	3.6GHz	-	4MB	DDR4-2666	Intel UHD Graphics 610
Pentium Gold G6400	2	4	4.0GHz	-	4MB	DDR4-2666	Intel UHD Graphics 610
Pentium Gold G6500	2	4	4.1GHz	-	4MB	DDR4-2666	Intel UHD Graphics 630
Pentium Gold G6600	2	4	4.2GHz	-	4MB	DDR4-2666	Intel UHD Graphics 630
Core i3-10100	4	8	3.6GHz	4.3GHz	6MB	DDR4-2666	Intel UHD Graphics 630
Core i3-10300	4	8	3.7GHz	4.4GHz	8MB	DDR4-2666	Intel UHD Graphics 630
Core i3-10320	4	8	3.8GHz	4.6GHz	8MB	DDR4-2666	Intel UHD Graphics 630
Core i5-10400	6	12	2.9GHz	4.3GHz	12MB	DDR4-2666	Intel UHD Graphics 630
Core i5-10400F	6	12	2.9GHz	4.3GHz	12MB	DDR4-2666	-
Core i5-10500	6	12	3.1GHz	4.5GHz	12MB	DDR4-2666	Intel UHD Graphics 630
Core i5-10600	6	12	3.3GHz	4.8GHz	12MB	DDR4-2666	Intel UHD Graphics 630
Core i7-10700	8	16	2.9GHz	4.8GHz	16MB	DDR4-2933	Intel UHD Graphics 630
Core i7-10700F	8	16	2.9GHz	4.8GHz	16MB	DDR4-2933	-
Core i9-10900	10	20	2.8GHz	5.2GHz	20MB	DDR4-2933	Intel UHD Graphics 630
Core i9-10900F	10	20	2.8GHz	5.2GHz	20MB	DDR4-2933	-

Operating System

Operating System**

- Windows® 10 Pro 64
- Windows 10 Home 64
- Windows 10 IoT Enterprise
- Ubuntu Linux
- No operating system

Graphics

Graphics**[1]

Graphics	Type	Memory	Connector	Max Resolution	Key Features
Intel UHD graphics 610	Integrated	Shared	1x HDMI®, 2x DP	1920x1080@60Hz(HDMI), 4096x2304@60Hz(DP)	DirectX® 12
Intel UHD graphics 630	Integrated	Shared	1x HDMI, 2x DP	1920x1080@60Hz(HDMI), 4096x2304@60Hz(DP)	DirectX 12
AMD Radeon™ 520	Discrete	2GB GDDR5	2x DP 1.2	4096x2160@60Hz(DP)	DirectX 12
AMD Radeon RX 550X	Discrete	4GB GDDR5	1x HDMI 2.0, 1x DP 1.4	4096x2160@60Hz(HDMI), 3840x2160@60Hz(DP)	DirectX 12
NVIDIA® GeForce® GT 730	Discrete	2GB GDDR5	1x VGA, 1x HDMI 1.4	2048x1536@75Hz(VGA), 3840x2160@30Hz(HDMI)	DirectX 12

Notes:

- The information of integrated graphics are not applicable for the models without integrated graphics (for the details, please refer to processor section)

Monitor Support

Monitor Support^[1]

Supports up to 3 independent displays via onboard ports (HDMI and 2x DisplayPort™), more displays support via discrete graphics

Notes:

- Onboard video ports are only available for the models with integrated graphics

Chipset

Chipset

Intel H470 chipset

Memory

Max Memory^[1]

Up to 128GB DDR4-2933

Memory Slots

Four DDR4 DIMM slots, dual-channel capable

Memory Type^{**}

- DDR4-2666
- DDR4-2933

Notes:

- The max memory is based on the test results with current Lenovo® memory offerings. The system may support more memory as the technology develops.

Storage

Storage Support

Up to three drives, 1x 2.5"/3.5" HDD + 1x 2.5" HDD + 1x M.2 SSD

- 2.5" HDD up to 1TB each
- 3.5" HDD up to 2TB
- M.2 SSD up to 2TB
- Optional Intel Optane™ Memory, M.2

Storage Type^{***}

Disk Type	Interface	RPM	Security
2.5" SATA HDD	SATA 6Gb/s	7.2K	-
3.5" SATA HDD	SATA 6Gb/s	7.2K	-
M.2 2242 SSD	PCIe NVMe, PCIe 3.0 x2	-	-
M.2 2280 SSD	PCIe NVMe, PCIe 3.0 x4	-	Opal
M.2 2280 SSD	PCIe NVMe, PCIe 3.0 x4	-	-
Intel Optane Memory M10	PCIe NVMe, PCIe 3.0 x2	-	-

RAID

No support

Removable Storage

Optical^{**}

- DVD-ROM, SATA 1.5Gb/s, slim (9.0mm)
- DVD burner (DVD±RW), SATA 1.5Gb/s, slim (9.0mm)
- None

Card Reader

- 3-in-1 card reader (SD, SDHC, SDXC)

ThinkCentre M70s

- No card reader

Multi-Media

Audio Chip

High Definition (HD) Audio, Realtek® ALC623-CG codec

Speakers

Single speaker, 1W x1

Power Supply

Power Supply**

Power	Type	Efficiency	Key Features
180W	Fixed	85%	-
260W	Fixed	85%	-
310W	Fixed	92%	-
380W	Fixed	92%	-

DESIGN

Input Device

Keyboard**

- Lenovo Calliope Keyboard (USB connector), black
- Lenovo Calliope Wireless Keyboard (2.4GHz via USB receiver), black
- Lenovo Traditional Keyboard (USB connector), black
- No keyboard

Mouse**

- Lenovo Calliope Mouse (USB connector), black
- Lenovo Calliope Wireless Mouse (2.4GHz via USB receiver), black
- Lenovo Fingerprint Mouse (USB connector), Windows Hello support, black
- No mouse

Mechanical

Form Factor

SFF (8.2L)

Dimensions (WxDxH)

Models	Dimensions
All models	93 x 298 x 340 mm (3.6 x 11.7 x 13.4 inches)

Weight

Models	Weight
All models	5.3 kg (11.7 lbs)

Case Color

Black

Bays

- 1x 2.5" disk bay (optional, or bay comes with disk)
- 1x 3.5" disk bay
- 1x slim ODD bay

Expansion Slots

- One PCIe 3.0 x1, low-profile (length < 155mm, height < 68mm)
- One PCIe 3.0 x16, low-profile (length < 155mm, height < 68mm)
- Two dummy slots, only brackets for optional port extension
- Two M.2 slots (one for WLAN, one for SSD)

Stand

ThinkCentre M70s

- Vertical stand
- No stand

Others

- (Optional) Dust filter
- Supports Smart Power On

CONNECTIVITY

Network

Onboard Ethernet

Gigabit Ethernet, Intel Ethernet Connection I219-V, 1x RJ45, supports Wake-on-LAN

Optional Ethernet**

- Gigabit Ethernet, Bitland BN8E88, 1x RJ-45, PCIe x1
- Gigabit Ethernet, Intel Ethernet Server Adapter I350-T4, 4x RJ-45, PCIe x4
- No optional Ethernet

WLAN + Bluetooth®**

- Realtek RTL8822CE, 802.11ac Dual Band 2x2 Wi-Fi® + Bluetooth 5.0, M.2 card
- Intel Wireless-AC 9462, 802.11ac Dual Band 1x1 Wi-Fi + Bluetooth 5.0, M.2 card
- Intel Wireless-AC 9560, 802.11ac Dual Band 2x2 Wi-Fi + Bluetooth 5.0, M.2 card
- Intel Wi-Fi 6 AX201, 802.11ax 2x2 Wi-Fi + Bluetooth 5.1, M.2 Card
- No WLAN and Bluetooth

Ports^[1]

Front Ports

- 2x USB 3.2 Gen 1
- 2x USB 3.2 Gen 2
- 1x USB-C 3.2 Gen 1
- 1x headphone / microphone combo jack (3.5mm)
- 1x microphone (3.5mm)

Optional Front Ports

- 1x card reader
- None

Rear Ports^[2]

- 4x USB 2.0
- 1x HDMI
- 2x DisplayPort
- 1x serial (9-pin)
- 1x Ethernet (RJ-45)
- 1x line-out (3.5mm)

Optional Rear Ports***

- 2x USB 3.2 Gen 1 (via 2-port USB expansion card, PCIe x1)
- 2x USB-C 3.2 Gen 2 (via 2-port USB-C expansion card, PCIe x4)
- 1x serial
- 4x serial (via 4-port serial expansion card, PCIe x1)
- 1x parallel
- 2x PS/2

Notes:

1. The transfer speed of following ports will vary and, depending on many factors, such as the processing speed of the host device, file attributes and other factors related to system configuration and your operating environment, will be slower than theoretical speed.
USB 2.0: 480 Mbit/s;
USB 3.2 Gen 1 (SuperSpeed USB 5Gbps, formerly USB 3.0 / USB 3.1 Gen 1): 5 Gbit/s;
USB 3.2 Gen 2 (SuperSpeed USB 10Gbps, formerly USB 3.1 Gen 2): 10 Gbit/s;
USB 3.2 Gen 2x2 (SuperSpeed USB 20Gbps): 20 Gbit/s;
Thunderbolt™ 3: 40 Gbit/s;
FireWire 400: 400 Mbit/s;
FireWire 800: 800 Mbit/s
2. For video ports on discrete graphics, please see graphics section

Monitor Cable

Monitor Cable***

- DP to dual DP dongle
- DP to DVI-D dongle
- DP to HDMI 1.4 dongle
- DP to VGA cable (1.5M)
- DP to VGA dongle
- HDMI to HDMI cable
- HDMI to VGA dongle
- No monitor cable

SECURITY & PRIVACY

Security

Security Chip

Discrete TPM 2.0, TCG certified

Physical Locks

- (Optional) E-lock
- (Optional) Smart Cable Clip
- Kensington® Security Slot
- Padlock Loop

Chassis Intrusion Switch

- Chassis intrusion switch
- No chassis intrusion switch

Fingerprint Reader

- Touch style fingerprint reader on mouse
- No fingerprint reader

BIOS Security

- Administrator password
- Power-on password
- Hard disk password
- Boot sequence control
- Boot without keyboard and mouse
- Smart USB protection (allows keyboard / mouse only, blocks all storage devices)
- Individual USB port disablement

MANAGEABILITY

System Management

System Management

None

SERVICE

Warranty

Base Warranty**

- 1-year depot service
- 1-year limited onsite service
- 3-year limited onsite service
- No base warranty

ENVIRONMENTAL

Operating Environment

Temperature

- Operating: 5°C (41°F) to 35°C (95°F)
- Storage: -40°C (-40°F) to 60°C (140°F)

Humidity

- Operating: 20% to 80%
- Storage: 10% to 90%

Altitude

- Operating: -15.2 m (-50 ft) to 3048 m (10,000 ft)
- Storage: -15.2 m (-50 ft) to 12192 m (40,000 ft)

CERTIFICATIONS

Green Certifications

Green Certifications[□]

- (Optional) EPEAT™ Gold
- (Optional) EPEAT Silver
- (Optional) ENERGY STAR® 8.0
- ErP Lot 3
- TCO Certified 8.0
- RoHS compliant

Notes:

1. ENERGY STAR 8.0 and EPEAT are only available for MT 11DB/11DC

Other Certifications

Other Certifications

- (Optional) TÜV Rheinland® Low Noise
- (Optional) TÜV Rheinland Ultra Low Noise

Mil-Spec Test

MIL-STD-810H military test passed (Low Pressure [Altitude], High Temperature, Low Temperature, Temperature Shock, Humidity, Sand and Dust, Vibration, Shock, Fungus, Solar Radiation)

- Feature with ** means that only one offering listed under the feature is configured on selected models.
- Feature with *** means that one or more offerings listed under the feature could be configured on selected models.
- Lenovo reserves the right to change specifications or other product information without notice. Lenovo is not responsible for photographic or typographical errors. LENOVO PROVIDES THIS PUBLICATION "AS IS," WITHOUT WARRANTY OF ANY KIND, EITHER EXPRESS OR IMPLIED, INCLUDING THE IMPLIED WARRANTIES OF MERCHANTABILITY OR FITNESS FOR A PARTICULAR PURPOSE. Some jurisdictions do not allow disclaimer of express or implied warranties in certain transactions, therefore this disclaimer may not apply to you.
- The specifications on this page may not be available in all regions, and may be changed or updated without notice.

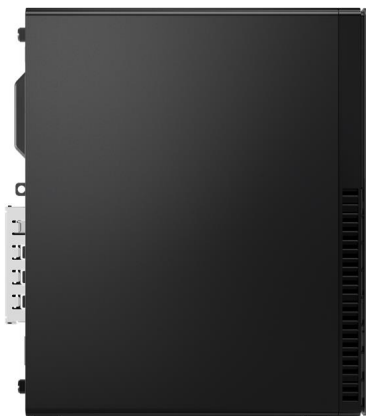

OVERVIEW

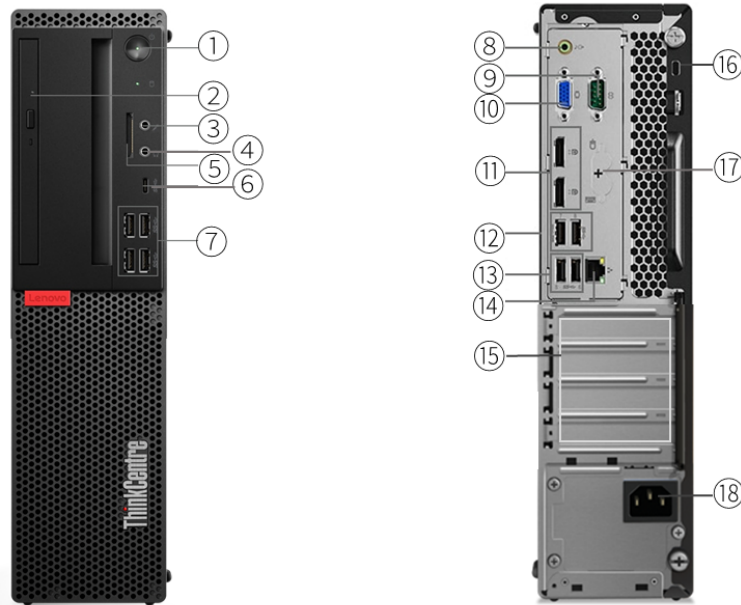

1. Optical drive *	10. VGA
2. Power button	11. 2x DisplayPort
3. Microphone (3.5mm)	12. 2x USB 2.0
4. Headphone / microphone combo jack (3.5mm)	13. 2x USB 2.0
5. Card reader *	14. Ethernet (RJ-45)
6. USB-C 3.1 Gen 1	15. Optional ports on expansion cards *
7. 2x USB 3.1 Gen 1 + 2x USB 3.1 Gen 2	16. Kensington Security Slot
8. Audio line-out (3.5mm)	17. 2x PS/2 ports (keyboard / mouse) *
9. Serial	18. Power connector

Notes:

- Ports with * are only available on selected models

PERFORMANCE

Processor

Processor Family

Intel® Celeron®, Intel Pentium®, 8th Generation Intel Core™ i3 / i5 / i7, or 9th Generation Intel Core i3 / i5 / i7 / i9 Processor

Processor**

Processor Name	Cores	Threads	Base Frequency	Max Frequency	Cache	Memory Support	Processor Graphics
Celeron G4900	2	2	3.1GHz	-	2MB	DDR4-2400	Intel UHD Graphics 610
Celeron G4920	2	2	3.2GHz	-	2MB	DDR4-2400	Intel UHD Graphics 610
Celeron G4930	2	2	3.2GHz	-	2MB	DDR4-2400	Intel UHD Graphics 610
Celeron G4950	2	2	3.3GHz	-	2MB	DDR4-2400	Intel UHD Graphics 610
Pentium Gold G5400	2	4	3.7GHz	-	4MB	DDR4-2400	Intel UHD Graphics 610
Pentium Gold G5420	2	4	3.8GHz	-	4MB	DDR4-2400	Intel UHD Graphics 610
Pentium Gold G5500	2	4	3.8GHz	-	4MB	DDR4-2400	Intel UHD Graphics 630
Pentium Gold G5600	2	4	3.9GHz	-	4MB	DDR4-2400	Intel UHD Graphics 630
Pentium Gold G5620	2	4	4.0GHz	-	4MB	DDR4-2400	Intel UHD Graphics 630
Core i3-8100	4	4	3.6GHz	-	6MB	DDR4-2400	Intel UHD Graphics 630
Core i3-8300	4	4	3.7GHz	-	8MB	DDR4-2400	Intel UHD Graphics 630
Core i3-9100	4	4	3.6GHz	4.2GHz	6MB	DDR4-2400	Intel UHD Graphics 630
Core i3-9300	4	4	3.7GHz	4.3GHz	8MB	DDR4-2400	Intel UHD Graphics 630
Core i3-9320	4	4	3.7GHz	4.4GHz	8MB	DDR4-2400	Intel UHD Graphics 630
Core i5-8400	6	6	2.8GHz	4.0GHz	9MB	DDR4-2666	Intel UHD Graphics 630
Core i5-8500	6	6	3.0GHz	4.1GHz	9MB	DDR4-2666	Intel UHD Graphics 630
Core i5-8600	6	6	3.1GHz	4.3GHz	9MB	DDR4-2666	Intel UHD Graphics 630
Core i5-9400	6	6	2.9GHz	4.1GHz	9MB	DDR4-2666	Intel UHD Graphics 630
Core i5-9400F	6	6	2.9GHz	4.1GHz	9MB	DDR4-2666	-
Core i5-9500	6	6	3.0GHz	4.4GHz	9MB	DDR4-2666	Intel UHD Graphics 630
Core i5-9500F	6	6	3.0GHz	4.4GHz	9MB	DDR4-2666	-
Core i5-9600	6	6	3.1GHz	4.6GHz	9MB	DDR4-2666	Intel UHD Graphics 630
Core i7-8700	6	12	3.2GHz	4.6GHz	12MB	DDR4-2666	Intel UHD Graphics 630
Core i7-9700	8	8	3.0GHz	4.7GHz	12MB	DDR4-2666	Intel UHD Graphics 630
Core i9-9900	8	16	3.1GHz	5.0GHz	16MB	DDR4-2666	Intel UHD Graphics 630

Operating System

Operating System**

- Windows® 10 Pro 64
- Windows 10 Home 64
- Ubuntu Linux
- No operating system

Graphics

Graphics**[1]

Graphics	Type	Memory	Connector	Max Resolution	Key Features
Intel UHD graphics 610	Integrated	Shared	1x VGA, 2x DP	2048x1536@50Hz(VGA), 4096x2304@60Hz(DP)	DirectX® 12
Intel UHD graphics 630	Integrated	Shared	1x VGA, 2x DP	2048x1536@50Hz(VGA), 4096x2304@60Hz(DP)	DirectX 12

ThinkCentre M720 SFF

AMD Radeon™ 520	Discrete	2GB GDDR5	2x DP 1.2	4096x2160@60Hz(DP)	DirectX 12
NVIDIA® GeForce® GT 730	Discrete	2GB GDDR5	2x DP	3840x2160@60Hz(DP)	DirectX 12, PCIe 2.0 x16, 35 watts

Notes:

- The information of integrated graphics are not applicable for the models without integrated graphics (for the details, please refer to processor section)

Monitor Support

Monitor Support

Supports up to 3 independent displays via onboard ports (VGA and 2x DisplayPort™), more displays support via discrete graphics

Chipset

Chipset

Intel B360 chipset

Memory

Max Memory^[1]

Up to 64GB DDR4-2666

Memory Slots

Four DDR4 DIMM slots, dual-channel capable

Memory Type

DDR4-2666

Notes:

- The max memory is based on the test results with current Lenovo® memory offerings. The system may support more memory as the technology develops.

Storage

Storage Support

Up to three drives, 1x 2.5"/3.5" HDD/SSD + 1x 2.5" HDD/SSD + 1x M.2 SSD

- 2.5" HDD up to 1TB each
- 3.5" HDD up to 2TB
- 2.5" SSD up to 256GB each
- M.2 SSD up to 1TB
- Optional Intel Optane™ Memory, M.2

Storage Type^{***}

Disk Type	Interface	RPM	Security
2.5" SATA HDD	SATA 6Gb/s	7.2K	-
2.5" SATA SSD	SATA 6Gb/s	-	Opal
2.5" SATA SSD	SATA 6Gb/s	-	-
3.5" SATA HDD	SATA 6Gb/s	7.2K	-
M.2 2242 SSD	PCIe NVMe, PCIe 3.0 x2	-	-
M.2 2280 SSD	PCIe NVMe, PCIe 3.0 x4	-	Opal
M.2 2280 SSD	PCIe NVMe, PCIe 3.0 x4	-	-
Intel Optane Memory M10	PCIe NVMe, PCIe 3.0 x2	-	-

RAID

No support

Removable Storage

Optical^{**}

ThinkCentre M720 SFF

- DVD-ROM, SATA 1.5Gb/s, slim (9.0mm)
- DVD burner (DVD±RW), SATA 1.5Gb/s, slim (9.0mm)
- None

Card Reader

- 7-in-1 card reader
- No card reader

Multi-Media

Audio Chip

High Definition (HD) Audio, Realtek® ALC233VB2 codec

Speakers

Single speaker, 1W x1

Power Supply

Power Supply**

Power	Type	Efficiency	Key Features
180W	Fixed	85%	-
210W	Fixed	85%	-
260W	Fixed	92%	-

DESIGN

Input Device

Keyboard**

- Lenovo Calliope Wireless Keyboard (2.4GHz via USB receiver), black
- Lenovo Keyboard (PS/2 connector), black
- Lenovo Traditional Keyboard (USB connector), black
- No keyboard

Mouse**

- Lenovo Calliope Mouse (USB connector), black
- Lenovo Calliope Wireless Mouse (2.4GHz via USB receiver), black
- Lenovo Mouse (PS/2 connector), black (only available via special bid)
- Lenovo Fingerprint Mouse (USB connector), Windows Hello support, black
- No mouse

Mechanical

Form Factor

SFF (8.4L)

Dimensions (WxDxH)

Models	Dimensions
All models	92.5 x 290.5 x 343.5 mm (3.6 x 11.4 x 13.5 inches)

Weight

Models	Weight
All models	6.0 kg (13.2 lbs)

Case Color

Black

Bays

- 1x 2.5" disk bay (optional, or bay comes with disk)
- 1x 3.5" disk bay
- 1x slim ODD bay

Expansion Slots

- Two PCIe 3.0 x1, low-profile (length < 147mm, height < 68.9mm)

ThinkCentre M720 SFF

- One PCIe 3.0 x16, low-profile (length < 147mm, height < 68.9mm)
- One dummy slot, only bracket for optional port extension
- Two M.2 slots (one for WLAN, one for SSD)

EOU

Toolless cover, disk, optical, extension card assembly / removal

Stand

- Vertical stand
- No stand

Others

(Optional) Dust filter

CONNECTIVITY

Network

Onboard Ethernet

Gigabit Ethernet, Intel Ethernet Connection I219-V, 1x RJ45, supports Wake-on-LAN

Optional Ethernet**

- Gigabit Ethernet, Bitland BN8E88, 1x RJ-45, PCIe x1
- Gigabit Ethernet, Intel Ethernet Server Adapter I350-T4, 4x RJ-45, PCIe x4
- No optional Ethernet

WLAN + Bluetooth**

- Realtek RTL8821CE, 802.11ac Dual Band 1x1 Wi-Fi® + Bluetooth 4.2, M.2 card
- Realtek RTL8822BE, 802.11ac Dual Band 2x2 Wi-Fi + Bluetooth 4.2, M.2 card
- Intel Dual Band Wireless-AC 3165, 802.11ac Dual Band 1x1 Wi-Fi + Bluetooth 4.2, M.2 Card
- Intel Dual Band Wireless-AC 8265, 802.11ac Dual Band 2x2 Wi-Fi + Bluetooth 4.2, M.2 Card
- No WLAN and Bluetooth

Ports^[1]

Front Ports

- 2x USB 3.1 Gen 1
- 2x USB 3.1 Gen 2
- 1x USB-C 3.1 Gen 1
- 1x headphone / microphone combo jack (3.5mm)
- 1x microphone (3.5mm)

Optional Front Ports

- 1x card reader
- None

Rear Ports^[2]

- 4x USB 2.0
- 1x VGA
- 2x DisplayPort
- 1x serial (9-pin)
- 1x Ethernet (RJ-45)
- 1x line-out (3.5mm)

Optional Rear Ports***

- 1x USB 2.0 (via 1-port adapter)
- 2x USB 3.2 Gen 1 (via 2-port USB expansion card, PCIe x1)
- 2x USB-C 3.2 Gen 2 (via 2-port USB-C expansion card, PCIe x4)
- 1x serial
- 4x serial (via 4-port serial expansion card, PCIe x1)
- 1x parallel
- 2x PS/2

Notes:

1. The transfer speed of following ports will vary and, depending on many factors, such as the processing speed of the host device, file attributes and other factors related to system configuration and your operating environment, will be slower than theoretical speed.
USB 2.0: 480 Mbit/s;

ThinkCentre M720 SFF

USB 3.2 Gen 1 (SuperSpeed USB 5Gbps, formerly USB 3.0 / USB 3.1 Gen 1): 5 Gbit/s;
USB 3.2 Gen 2 (SuperSpeed USB 10Gbps, formerly USB 3.1 Gen 2): 10 Gbit/s;
USB 3.2 Gen 2x2 (SuperSpeed USB 20Gbps): 20 Gbit/s;
Thunderbolt™ 3: 40 Gbit/s;
FireWire 400: 400 Mbit/s;
FireWire 800: 800 Mbit/s

2. For video ports on discrete graphics, please see graphics section

Monitor Cable

Monitor Cable***

- DP to dual DP dongle
- DP to DVI-D dongle
- DP to HDMI® 1.4 dongle
- DP to VGA cable (1.5M)
- DP to VGA dongle
- No monitor cable

SECURITY & PRIVACY

Security

Security Chip

Discrete TPM 2.0, TCG certified

Physical Locks

- (Optional) E-lock
- (Optional) Smart Cable Clip
- Kensington® Security Slot
- Padlock Loop

Chassis Intrusion Switch

- Chassis intrusion switch
- No chassis intrusion switch

Fingerprint Reader

- Touch style fingerprint reader on mouse
- No fingerprint reader

BIOS Security

- Administrator password
- Power-on password
- Hard disk password
- Boot sequence control
- Boot without keyboard and mouse
- Smart USB protection (allows keyboard / mouse only, blocks all storage devices)
- Individual USB port disablement

MANAGEABILITY

System Management

System Management

None

SERVICE

Warranty

Base Warranty**

- 1-year depot service
- 1-year limited onsite service
- 3-year depot service
- 3-year limited onsite service
- 3-year split limited onsite service

- No base warranty

ENVIRONMENTAL

Operating Environment

Temperature

- Operating: 5°C (41°F) to 35°C (95°F)
- Storage: -40°C (-40°F) to 60°C (140°F)

Humidity

- Operating: 20% to 80%
- Storage: 10% to 90%

Altitude

- Operating: -15.2 m (-50 ft) to 3048 m (10,000 ft)
- Storage: -15.2 m (-50 ft) to 12192 m (40,000 ft)

CERTIFICATIONS

Green Certifications

Green Certifications

- EPEAT™ Silver
- ENERGY STAR® 8.0
- ErP Lot 3
- TCO
- RoHS compliant

Other Certifications

Other Certifications

(Optional) TÜV Rheinland® Low Noise

- Feature with ** means that only one offering listed under the feature is configured on selected models.
- Feature with *** means that one or more offerings listed under the feature could be configured on selected models.
- Lenovo reserves the right to change specifications or other product information without notice. Lenovo is not responsible for photographic or typographical errors. LENOVO PROVIDES THIS PUBLICATION “AS IS,” WITHOUT WARRANTY OF ANY KIND, EITHER EXPRESS OR IMPLIED, INCLUDING THE IMPLIED WARRANTIES OF MERCHANTABILITY OR FITNESS FOR A PARTICULAR PURPOSE. Some jurisdictions do not allow disclaimer of express or implied warranties in certain transactions, therefore this disclaimer may not apply to you.
- The specifications on this page may not be available in all regions, and may be changed or updated without notice.



OVERVIEW

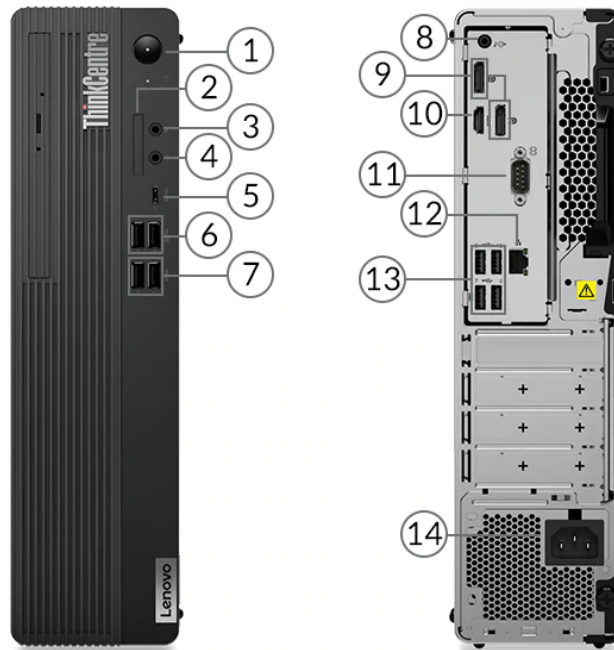

1. Power button	8. Line-out (3.5mm)
2. Card reader	9. 2x DisplayPort
3. Microphone (3.5mm)	10. HDMI
4. Headphone / microphone combo jack (3.5mm)	11. Serial
5. USB-C 3.2 Gen 1	12. Ethernet (RJ-45)
6. 2x USB 3.2 Gen 1	13. 4x USB 2.0
7. 2x USB 3.2 Gen 2	14. Power connector

Notes:

- More ports are available through the optional expansion cards (not shown on the sample product above)

PERFORMANCE

Processor

Processor Family

AMD Athlon™ or AMD Ryzen™ 3 / 5 / 7 / 9 Processor

Processor**

Processor Name	Cores	Threads	Base Frequency	Max Frequency	Cache	Memory Support	Processor Graphics
AMD Athlon Silver 3050GE	2	4	3.4GHz	3.4GHz	1MB L2 / 4MB L3	DDR4-2666	AMD Radeon™ Graphics
AMD Athlon Gold PRO 3150G	4	4	3.5GHz	3.9GHz	2MB L2 / 4MB L3	DDR4-2933	AMD Radeon Graphics
AMD Ryzen 3 3200G	4	4	3.6GHz	4.0GHz	2MB L2 / 4MB L3	DDR4-2933	AMD Radeon Vega 8 Graphics
AMD Ryzen 3 4300G	4	8	3.8GHz	4.0GHz	2MB L2 / 4MB L3	DDR4-3200	AMD Radeon Graphics
AMD Ryzen 3 5300G	4	8	4.0GHz	4.2GHz	2MB L2 / 8MB L3	DDR4-3200	AMD Radeon Graphics
AMD Ryzen 3 PRO 4350G	4	8	3.8GHz	4.0GHz	2MB L2 / 4MB L3	DDR4-3200	AMD Radeon Graphics
AMD Ryzen 3 PRO 5350G	4	8	4.0GHz	4.2GHz	2MB L2 / 8MB L3	DDR4-3200	AMD Radeon Graphics
AMD Ryzen 5 4600G	6	12	3.7GHz	4.2GHz	3MB L2 / 8MB L3	DDR4-3200	AMD Radeon Graphics
AMD Ryzen 5 5600G	6	12	3.9GHz	4.4GHz	3MB L2 / 16MB L3	DDR4-3200	AMD Radeon Graphics
AMD Ryzen 5 PRO 3350G	4	8	3.6GHz	4.0GHz	2MB L2 / 4MB L3	DDR4-2933	AMD Radeon Vega 11 Graphics
AMD Ryzen 5 PRO 3400G	4	8	3.7GHz	4.2GHz	2MB L2 / 4MB L3	DDR4-2933	AMD Radeon Vega 11 Graphics
AMD Ryzen 5 PRO 3600	6	12	3.6GHz	4.2GHz	3MB L2 / 32MB L3	DDR4-3200	-
AMD Ryzen 5 PRO 4650G	6	12	3.7GHz	4.2GHz	3MB L2 / 8MB L3	DDR4-3200	AMD Radeon Graphics
AMD Ryzen 5 PRO 5650G	6	12	3.9GHz	4.4GHz	3MB L2 / 16MB L3	DDR4-3200	AMD Radeon Graphics
AMD Ryzen 7 4700G	8	16	3.6GHz	4.4GHz	4MB L2 / 8MB L3	DDR4-3200	AMD Radeon Graphics
AMD Ryzen 7 5700G	8	16	3.8GHz	4.6GHz	4MB L2 / 16MB L3	DDR4-3200	AMD Radeon Graphics
AMD Ryzen 7 PRO 3700	8	16	3.6GHz	4.4GHz	4MB L2 / 32MB L3	DDR4-3200	-
AMD Ryzen 7 PRO 4750G	8	16	3.6GHz	4.4GHz	4MB L2 / 8MB L3	DDR4-3200	AMD Radeon Graphics
AMD Ryzen 7 PRO 5750G	8	16	3.8GHz	4.6GHz	4MB L2 / 16MB L3	DDR4 3200	AMD Radeon Graphics
AMD Ryzen 9 PRO 3900	12	24	3.1GHz	4.3GHz	6MB L2 / 64MB L3	DDR4-3200	-

Operating System

Operating System**

- Windows® 10 Pro 64

ThinkCentre M75s Gen 2

- Windows 10 Home 64
- Windows 10 IoT Enterprise
- Ubuntu Linux
- No operating system

Graphics

Graphics**^[1]

Graphics	Type	Memory	Connector	Max Resolution	Key Features
AMD Radeon Graphics	Integrated	Shared	2x DisplayPort™ 1.4, 1x HDMI® 1.4	4096x2160@60Hz(DP), 4096x2160@24Hz(HDMI)	DirectX® 12
AMD Radeon Vega 8 Graphics	Integrated	Shared	2x DisplayPort 1.4, 1x HDMI 1.4	4096x2160@60Hz(DP), 4096x2160@24Hz(HDMI)	DirectX 12
AMD Radeon Vega 11 Graphics	Integrated	Shared	2x DisplayPort 1.4, 1x HDMI 1.4	4096x2160@60Hz(DP), 4096x2160@24Hz(HDMI)	DirectX 12
AMD Radeon 520	Discrete	2GB GDDR5	2x DP 1.2	4096x2160@60Hz(DP)	DirectX 12
AMD Radeon RX 550X	Discrete	4GB GDDR5	1x HDMI 2.0, 1x DP 1.4	4096x2160@60Hz(HDMI), 3840x2160@60Hz(DP)	DirectX 12

Notes:

1. The information of integrated graphics are not applicable for the models without integrated graphics (for the details, please refer to processor section)

Monitor Support

Monitor Support

Supports up to 3 independent displays via onboard ports (HDMI and 2x DisplayPort), more displays support via discrete graphics

Chipset

Chipset

AMD PRO 565 chipset

Memory^[1]

Max Memory^[2]

Up to 128GB DDR4-3200

Memory Slots

Four DDR4 DIMM slots, dual-channel capable

Memory Type**^[3]

- DDR4-1866
- DDR4-2133
- DDR4-2400
- DDR4-2666
- DDR4-3200

Notes:

1. Recommend to choose the models with more than 4GB for better performance and experience
2. The max memory is based on the test results with current Lenovo® memory offerings. The system may support more memory as the technology develops.
3. Installed memory is actually 3200MHz, but may run at 1866MHz, 2133MHz, 2400MHz or 2666MHz depending on the memory support capability of processor

Storage

Storage Support

Up to three drives, 1x 2.5"/3.5" HDD + 1x 2.5" HDD + 1x M.2 SSD

- 2.5" HDD up to 1TB each
- 3.5" HDD up to 2TB

ThinkCentre M75s Gen 2

- M.2 SSD up to 2TB

Storage Type***

Disk Type	Interface	RPM	Security
2.5" SATA HDD	SATA 6Gb/s	7.2K	-
3.5" SATA HDD	SATA 6Gb/s	7.2K	-
M.2 2242 SSD	PCIe NVMe, PCIe 3.0 x2	-	-
M.2 2242 SSD	PCIe NVMe, PCIe 3.0 x4	-	-
M.2 2280 SSD	PCIe NVMe, PCIe 3.0 x4	-	Opal

RAID

RAID 0/1 support for HDDs (RAID preset only available via special bid model)

Removable Storage

Optical**

- DVD-ROM, SATA 1.5Gb/s, slim (9.0mm)
- DVD burner (DVD±RW), SATA 1.5Gb/s, slim (9.0mm)
- None

Card Reader

- 3-in-1 card reader (SD, SDHC, SDXC)
- No card reader

Multi-Media

Audio Chip

High Definition (HD) Audio, Realtek® ALC623-CG codec

Speakers

- Single speaker, 1W x1
- No speakers

Power Supply

Power Supply**

Power	Type	Efficiency	Key Features
180W	Fixed	85%	-
260W	Fixed	85%	-
310W	Fixed	92%	-

DESIGN

Input Device

Keyboard**

- Lenovo Calliope Keyboard (USB connector), black
- Lenovo Calliope Wireless Keyboard (2.4GHz via USB receiver), black
- Lenovo Traditional Keyboard (USB connector), black
- No keyboard

Mouse**

- Lenovo Calliope Mouse (USB connector), black
- Lenovo Calliope Wireless Mouse (2.4GHz via USB receiver), black
- Lenovo Fingerprint Mouse (USB connector), Windows Hello support, black
- No mouse

Mechanical

Form Factor

SFF (8.2L)

Dimensions (WxDxH)

ThinkCentre M75s Gen 2

Models	Dimensions
All models	93 x 298 x 340 mm (3.6 x 11.7 x 13.4 inches)

Weight

Models	Weight
All models	5.3 kg (11.7 lbs)

Case Color

Black

Bays

- 1x 2.5" disk bay (bay comes with disk)
- 1x 3.5" disk bay
- 1x slim ODD bay

Expansion Slots

- One PCIe 3.0 x1, low-profile (length < 155mm, height < 68mm)
- One PCIe 3.0 x16, low-profile (length < 155mm, height < 68mm)
- Two dummy slots, only brackets for optional port extension
- Two M.2 slots (one for WLAN, one for SSD)

Stand

- Vertical stand
- No stand

Others

(Optional) Dust filter

CONNECTIVITY

Network^[1]

Onboard Ethernet^{**}

- Gigabit Ethernet, Realtek RTL8111HN, 1x RJ45, supports Wake-on-LAN
- Gigabit Ethernet, Realtek RTL8111EPV, 1x RJ45, supports Wake-on-LAN

Optional Ethernet^{**[2]}

- Gigabit Ethernet, Bitland BN8E88, 1x RJ-45, PCIe x1
- Gigabit Ethernet, Bitland RTL8111FP, 1x RJ-45, PCIe x1
- No optional Ethernet

WLAN + Bluetooth^{**}

- Realtek RTL8852AE, Wi-Fi[®] 6, 802.11ax Dual Band 2x2 Wi-Fi + Bluetooth 5.2, M.2 card
- Realtek RTL8822CE, 802.11ac Dual Band 2x2 Wi-Fi + Bluetooth 5.0, M.2 card
- Intel[®] Wireless-AC 9260, 802.11ac Dual Band 2x2 Wi-Fi + Bluetooth 5.0, M.2 card
- No WLAN and Bluetooth

Notes:

1. This system does not support Power Over Ethernet (PoE). If the system is used in a PoE environment, then a Network Isolator is required to prevent possible damage to the system, PoE equipment, or both.
2. RTL8111FP is not available for AP countries

Ports^[1]

Front Ports

- 2x USB 3.2 Gen 1
- 2x USB 3.2 Gen 2
- 1x USB-C 3.2 Gen 1
- 1x headphone / microphone combo jack (3.5mm)
- 1x microphone (3.5mm)

Optional Front Ports

- 1x card reader
- None

Rear Ports^[2]

ThinkCentre M75s Gen 2

- 4x USB 2.0
- 1x HDMI
- 2x DisplayPort
- 1x serial (9-pin)
- 1x Ethernet (RJ-45)
- 1x line-out (3.5mm)

Optional Rear Ports***

- 2x USB 3.2 Gen 1 (via 2-port USB expansion card, PCIe x1)
- 2x USB-C 3.2 Gen 2 (via 2-port USB-C expansion card, PCIe x4)
- 1x serial
- 1x parallel
- None

Notes:

1. The transfer speed of following ports will vary and, depending on many factors, such as the processing speed of the host device, file attributes and other factors related to system configuration and your operating environment, will be slower than theoretical speed.
USB 2.0: 480 Mbit/s;
USB 3.2 Gen 1 (SuperSpeed USB 5Gbps, formerly USB 3.0 / USB 3.1 Gen 1): 5 Gbit/s;
USB 3.2 Gen 2 (SuperSpeed USB 10Gbps, formerly USB 3.1 Gen 2): 10 Gbit/s;
USB 3.2 Gen 2x2 (SuperSpeed USB 20Gbps): 20 Gbit/s;
Thunderbolt™ 3: 40 Gbit/s;
FireWire 400: 400 Mbit/s;
FireWire 800: 800 Mbit/s
2. For video ports on discrete graphics, please see graphics section

Monitor Cable

Monitor Cable***

- DP to dual DP dongle
- DP to DVI-D dongle
- DP to HDMI 1.4 dongle
- DP to VGA cable (1.5M)
- DP to VGA dongle
- HDMI to HDMI cable (1.5m)
- HDMI to VGA dongle
- No monitor cable

SECURITY & PRIVACY

Security

Security Chip

Discrete TPM 2.0, TCG certified

Physical Locks

- (Optional) E-lock
- (Optional) Smart Cable Clip
- Kensington® Security Slot

Chassis Intrusion Switch

- Chassis intrusion switch
- No chassis intrusion switch

Fingerprint Reader

- Touch style fingerprint reader on mouse
- No fingerprint reader

BIOS Security

- Administrator password
- Power-on password
- Hard disk password
- Boot sequence control
- Boot without keyboard and mouse
- Smart USB protection (allows keyboard / mouse only, blocks all storage devices)
- Individual USB port disablement

MANAGEABILITY

System Management

System Management^[1]

- DASH 1.1
- No DASH

Notes:

1. DASH 1.1 is an optional feature for the selected MTs

SERVICE

Warranty

Base Warranty**

- 1-year depot service
- 1-year limited onsite service
- 3-year limited onsite service
- No base warranty

ENVIRONMENTAL

Operating Environment

Temperature

- Operating: 5°C (41°F) to 35°C (95°F)
- Storage: -40°C (-40°F) to 60°C (140°F)

Humidity

- Operating: 20% to 80%
- Storage: 10% to 90%

Altitude

- Operating: -15.2 m (-50 ft) to 3048 m (10,000 ft)
- Storage: -15.2 m (-50 ft) to 12192 m (40,000 ft)

CERTIFICATIONS

Green Certifications

Green Certifications^[1]

- (Optional) EPEAT™ Gold
- (Optional) EPEAT Silver
- (Optional) ENERGY STAR® 8.0
- ErP Lot 3
- TCO Certified 8.0
- RoHS compliant

Notes:

1. ENERGY STAR 8.0 and EPEAT are only available for MT 11JA/11JB

Other Certifications

Other Certifications

- (Optional) TÜV Rheinland® Low Noise
- (Optional) TÜV Rheinland Ultra Low Noise

Mil-Spec Test

MIL-STD-810H military test passed (Low Pressure [Altitude], High Temperature, Low Temperature, Temperature Shock, Humidity, Sand and Dust, Vibration, Shock, Fungus, Solar Radiation)

- Feature with ** means that only one offering listed under the feature is configured on selected models.
- Feature with *** means that one or more offerings listed under the feature could be configured on selected models.
- Lenovo reserves the right to change specifications or other product information without notice. Lenovo is not responsible for photographic or typographical errors. LENOVO PROVIDES THIS PUBLICATION "AS IS," WITHOUT WARRANTY OF ANY KIND, EITHER EXPRESS OR IMPLIED, INCLUDING THE IMPLIED WARRANTIES OF MERCHANTABILITY OR FITNESS FOR A PARTICULAR PURPOSE. Some jurisdictions do not allow disclaimer of express or implied warranties in certain transactions, therefore this disclaimer may not apply to you.
- The specifications on this page may not be available in all regions, and may be changed or updated without notice.



AMD



AMD



AMD



AMD



AMD



AMD

OVERVIEW

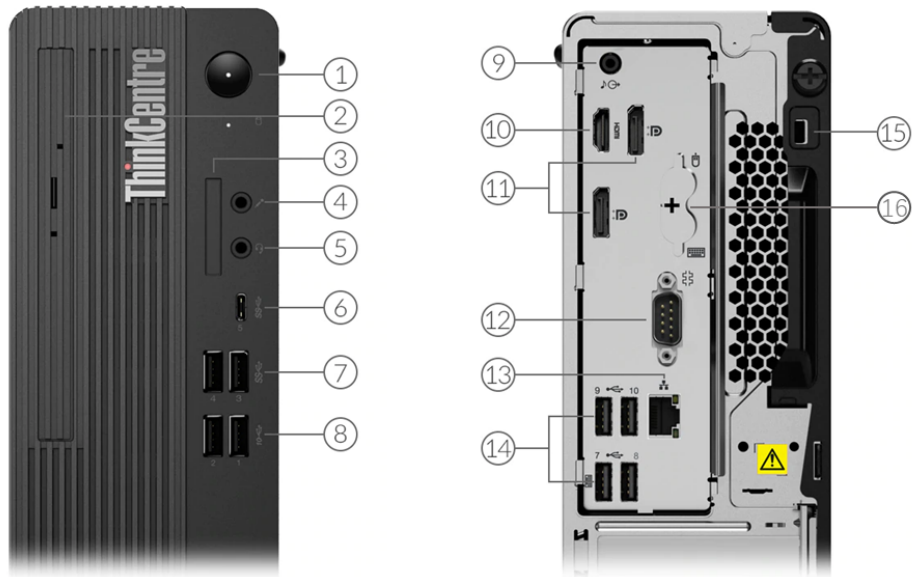

1. Power button	9. Line-out (3.5mm)
2. Optical drive *	10. HDMI
3. Card reader *	11. 2x DisplayPort
4. Microphone (3.5mm)	12. Serial
5. Headphone / microphone combo jack (3.5mm)	13. Ethernet (RJ-45)
6. USB-C 3.2 Gen 1	14. 4x USB 3.2 Gen 1
7. 2x USB 3.2 Gen 1	15. Kensington Security Slot
8. 2x USB 3.2 Gen 2	16. 2x PS/2 ports (keyboard / mouse) *

Notes:

- Ports with * are only available on selected models

PERFORMANCE

Processor

Processor Family

Intel® Celeron®, Intel Pentium®, or 10th Generation Intel Core™ i3 / i5 / i7 / i9 Processor

Processor**

Processor Name	Cores	Threads	Base Frequency	Max Frequency	Cache	Memory Support	Processor Graphics
Celeron G5900	2	2	3.4GHz	-	2MB	DDR4-2666	Intel UHD Graphics 610
Celeron G5905	2	2	3.5GHz	-	4MB	DDR4-2666	Intel UHD Graphics 610
Celeron G5920	2	2	3.5GHz	-	2MB	DDR4-2666	Intel UHD Graphics 610
Celeron G5925	2	2	3.6GHz	-	4MB	DDR4-2666	Intel UHD Graphics 610
Pentium Gold G6400	2	4	4.0GHz	-	4MB	DDR4-2666	Intel UHD Graphics 610
Pentium Gold G6500	2	4	4.1GHz	-	4MB	DDR4-2666	Intel UHD Graphics 630
Pentium Gold G6600	2	4	4.2GHz	-	4MB	DDR4-2666	Intel UHD Graphics 630
Core i3-10100	4	8	3.6GHz	4.3GHz	6MB	DDR4-2666	Intel UHD Graphics 630
Core i3-10300	4	8	3.7GHz	4.4GHz	8MB	DDR4-2666	Intel UHD Graphics 630
Core i3-10320	4	8	3.8GHz	4.6GHz	8MB	DDR4-2666	Intel UHD Graphics 630
Core i5-10400	6	12	2.9GHz	4.3GHz	12MB	DDR4-2666	Intel UHD Graphics 630
Core i5-10400F	6	12	2.9GHz	4.3GHz	12MB	DDR4-2666	-
Core i5-10500	6	12	3.1GHz	4.5GHz	12MB	DDR4-2666	Intel UHD Graphics 630
Core i5-10600	6	12	3.3GHz	4.8GHz	12MB	DDR4-2666	Intel UHD Graphics 630
Core i7-10700	8	16	2.9GHz	4.8GHz	16MB	DDR4-2933	Intel UHD Graphics 630
Core i7-10700F	8	16	2.9GHz	4.8GHz	16MB	DDR4-2933	-
Core i9-10900	10	20	2.8GHz	5.2GHz	20MB	DDR4-2933	Intel UHD Graphics 630
Core i9-10900F	10	20	2.8GHz	5.2GHz	20MB	DDR4-2933	-

Operating System

Operating System**

- Windows® 10 Pro 64
- Windows 10 Home 64
- Windows 10 IoT Enterprise
- Ubuntu Linux
- No operating system

Graphics

Graphics**[1]

Graphics	Type	Memory	Connector	Max Resolution	Key Features
Intel UHD graphics 610	Integrated	Shared	1x HDMI®, 2x DP	1920x1080@60Hz(HDMI), 4096x2304@60Hz(DP)	DirectX® 12
Intel UHD graphics 630	Integrated	Shared	1x HDMI, 2x DP	1920x1080@60Hz(HDMI), 4096x2304@60Hz(DP)	DirectX 12
AMD Radeon™ 520	Discrete	2GB GDDR5	2x DP 1.2	4096x2160@60Hz(DP)	DirectX 12
AMD Radeon RX 550X	Discrete	4GB GDDR5	1x HDMI 2.0, 1x DP 1.4	4096x2160@60Hz(HDMI), 3840x2160@60Hz(DP)	DirectX 12
NVIDIA® GeForce® GT 730	Discrete	2GB GDDR5	1x VGA, 1x HDMI 1.4	2048x1536@75Hz(VGA), 3840x2160@30Hz(HDMI)	DirectX 12

Notes:

- The information of integrated graphics are not applicable for the models without integrated graphics (for the details, please refer to processor section)

Monitor Support

Monitor Support

Supports up to 3 independent displays via onboard ports (HDMI and 2x DisplayPort™), more displays support via discrete graphics

Chipset

Chipset

Intel Q470 chipset

Memory

Max Memory^[1]

Up to 128GB DDR4-2933

Memory Slots

Four DDR4 DIMM slots, dual-channel capable

Memory Type**

- DDR4-2666
- DDR4-2933

Notes:

- The max memory is based on the test results with current Lenovo® memory offerings. The system may support more memory as the technology develops.

Storage

Storage Support

Up to three drives, 1x 2.5"/3.5" HDD + 1x 2.5" HDD + 1x M.2 SSD

- 2.5" HDD up to 1TB each
- 3.5" HDD up to 2TB
- M.2 SSD up to 2TB
- Optional Intel Optane™ Memory, M.2

Storage Type***

Disk Type	Interface	RPM	Security
2.5" SATA HDD	SATA 6Gb/s	7.2K	-
3.5" SATA HDD	SATA 6Gb/s	7.2K	-
M.2 2242 SSD	PCIe NVMe, PCIe 3.0 x2	-	-
M.2 2280 SSD	PCIe NVMe, PCIe 3.0 x4	-	Opal
M.2 2280 SSD	PCIe NVMe, PCIe 3.0 x4	-	-
Intel Optane Memory M10	PCIe NVMe, PCIe 3.0 x2	-	-

RAID

RAID 0/1 support for HDDs (RAID preset only available via special bid model)

Removable Storage

Optical**

- DVD-ROM, SATA 1.5Gb/s, slim (9.0mm)
- DVD burner (DVD±RW), SATA 1.5Gb/s, slim (9.0mm)
- None

Card Reader

- 3-in-1 card reader (SD, SDHC, SDXC)
- No card reader

Multi-Media

Audio Chip

High Definition (HD) Audio, Realtek® ALC623-CG codec

Speakers

Single speaker, 1W x1

Power Supply**Power Supply****

Power	Type	Efficiency	Key Features
180W	Fixed	85%	-
260W	Fixed	85%	-
310W	Fixed	92%	-
380W	Fixed	92%	-

DESIGN**Input Device****Keyboard****

- Lenovo Calliope Keyboard (USB connector), black
- Lenovo Calliope Wireless Keyboard (2.4GHz via USB receiver), black
- Lenovo Traditional Keyboard (USB connector), black
- No keyboard

Mouse**

- Lenovo Calliope Mouse (USB connector), black
- Lenovo Calliope Wireless Mouse (2.4GHz via USB receiver), black
- Lenovo Fingerprint Mouse (USB connector), Windows Hello support, black
- No mouse

Mechanical**Form Factor**

SFF (8.2L)

Dimensions (WxDxH)

Models	Dimensions
All models	93 x 298 x 340 mm (3.6 x 11.7 x 13.4 inches)

Weight

Models	Weight
All models	5.3 kg (11.7 lbs)

Case Color

Black

Bays

- 1x 2.5" disk bay (optional, or bay comes with disk)
- 1x 3.5" disk bay
- 1x slim ODD bay

Expansion Slots

- One PCIe 3.0 x1, low-profile (length < 155mm, height < 68mm)
- One PCIe 3.0 x16, low-profile (length < 155mm, height < 68mm)
- Two dummy slots, only brackets for optional port extension
- Two M.2 slots (one for WLAN, one for SSD)

Stand

- Vertical stand
- No stand

Others

- (Optional) Dust filter
- Supports Smart Power On

CONNECTIVITY

Network

Onboard Ethernet

Gigabit Ethernet, Intel Ethernet Connection I219-LM, 1x RJ45, supports Wake-on-LAN

Optional Ethernet**

- Gigabit Ethernet, Bitland BN8E88, 1x RJ-45, PCIe x1
- Gigabit Ethernet, Intel Ethernet Server Adapter I350-T4, 4x RJ-45, PCIe x4
- No optional Ethernet

WLAN + Bluetooth®**

- Realtek RTL8822CE, 802.11ac Dual Band 2x2 Wi-Fi® + Bluetooth 5.0, M.2 card
- Intel Wireless-AC 9560, 802.11ac Dual Band 2x2 Wi-Fi + Bluetooth 5.0, M.2 card
- Intel Wi-Fi 6 AX201, 802.11ax 2x2 Wi-Fi + Bluetooth 5.1, Intel vPro technology support, M.2 Card
- No WLAN and Bluetooth

Ports^[1]

Front Ports

- 2x USB 3.2 Gen 1
- 2x USB 3.2 Gen 2
- 1x USB-C 3.2 Gen 1
- 1x headphone / microphone combo jack (3.5mm)
- 1x microphone (3.5mm)

Optional Front Ports

- 1x card reader
- None

Rear Ports^[2]

- 4x USB 3.2 Gen 1
- 1x HDMI
- 2x DisplayPort
- 1x serial (9-pin)
- 1x Ethernet (RJ-45)
- 1x line-out (3.5mm)

Optional Rear Ports***

- 2x USB 2.0 (via 2-port adapter)
- 2x USB 3.2 Gen 1 (via 2-port USB expansion card, PCIe x1)
- 2x USB-C 3.2 Gen 2 (via 2-port USB-C expansion card, PCIe x4)
- 1x serial
- 4x serial (via 4-port serial expansion card, PCIe x1)
- 1x parallel
- 2x PS/2

Notes:

1. The transfer speed of following ports will vary and, depending on many factors, such as the processing speed of the host device, file attributes and other factors related to system configuration and your operating environment, will be slower than theoretical speed.
USB 2.0: 480 Mbit/s;
USB 3.2 Gen 1 (SuperSpeed USB 5Gbps, formerly USB 3.0 / USB 3.1 Gen 1): 5 Gbit/s;
USB 3.2 Gen 2 (SuperSpeed USB 10Gbps, formerly USB 3.1 Gen 2): 10 Gbit/s;
USB 3.2 Gen 2x2 (SuperSpeed USB 20Gbps): 20 Gbit/s;
Thunderbolt™ 3: 40 Gbit/s;
FireWire 400: 400 Mbit/s;
FireWire 800: 800 Mbit/s
2. For video ports on discrete graphics, please see graphics section

Monitor Cable

Monitor Cable***

- DP to dual DP dongle

- DP to DVI-D dongle
- DP to HDMI 1.4 dongle
- DP to VGA cable (1.5M)
- DP to VGA dongle
- HDMI to HDMI cable (1.5m)
- HDMI to VGA dongle
- No monitor cable

SECURITY & PRIVACY

Security

Security Chip

Discrete TPM 2.0, TCG certified

Physical Locks

- (Optional) E-lock
- (Optional) Smart Cable Clip
- Kensington® Security Slot
- Padlock Loop

Chassis Intrusion Switch

- Chassis intrusion switch
- No chassis intrusion switch

Fingerprint Reader

- Touch style fingerprint reader on mouse
- No fingerprint reader

BIOS Security

- Administrator password
- Power-on password
- Hard disk password
- Boot sequence control
- Boot without keyboard and mouse
- Smart USB protection (allows keyboard / mouse only, blocks all storage devices)
- Individual USB port disablement

MANAGEABILITY

System Management

System Management^[1]

- Intel vPro with Intel AMT 14.0
- None

Notes:

1. Require choosing a vPro-support Wi-Fi adapter to enable vPro function through wireless connection

SERVICE

Warranty

Base Warranty**

- 1-year depot service
- 1-year limited onsite service
- 3-year limited onsite service
- No base warranty

ENVIRONMENTAL

Operating Environment

Temperature

- Operating: 5°C (41°F) to 35°C (95°F)
- Storage: -40°C (-40°F) to 60°C (140°F)

Humidity

- Operating: 20% to 80%
- Storage: 10% to 90%

Altitude

- Operating: -15.2 m (-50 ft) to 3048 m (10,000 ft)
- Storage: -15.2 m (-50 ft) to 12192 m (40,000 ft)

CERTIFICATIONS

Green Certifications

Green Certifications

- (Optional) EPEAT™ Gold
- (Optional) EPEAT Silver
- (Optional) ENERGY STAR® 8.0
- ErP Lot 3
- TCO Certified 8.0
- RoHS compliant

Other Certifications

Other Certifications

- (Optional) TÜV Rheinland® Low Noise
- (Optional) TÜV Rheinland Ultra Low Noise

Mil-Spec Test

MIL-STD-810H military test passed (Low Pressure [Altitude], High Temperature, Low Temperature, Temperature Shock, Humidity, Sand and Dust, Vibration, Shock, Fungus, Solar Radiation)

- Feature with ** means that only one offering listed under the feature is configured on selected models.
- Feature with *** means that one or more offerings listed under the feature could be configured on selected models.
- Lenovo reserves the right to change specifications or other product information without notice. Lenovo is not responsible for photographic or typographical errors. LENOVO PROVIDES THIS PUBLICATION "AS IS," WITHOUT WARRANTY OF ANY KIND, EITHER EXPRESS OR IMPLIED, INCLUDING THE IMPLIED WARRANTIES OF MERCHANTABILITY OR FITNESS FOR A PARTICULAR PURPOSE. Some jurisdictions do not allow disclaimer of express or implied warranties in certain transactions, therefore this disclaimer may not apply to you.
- The specifications on this page may not be available in all regions, and may be changed or updated without notice.



OVERVIEW

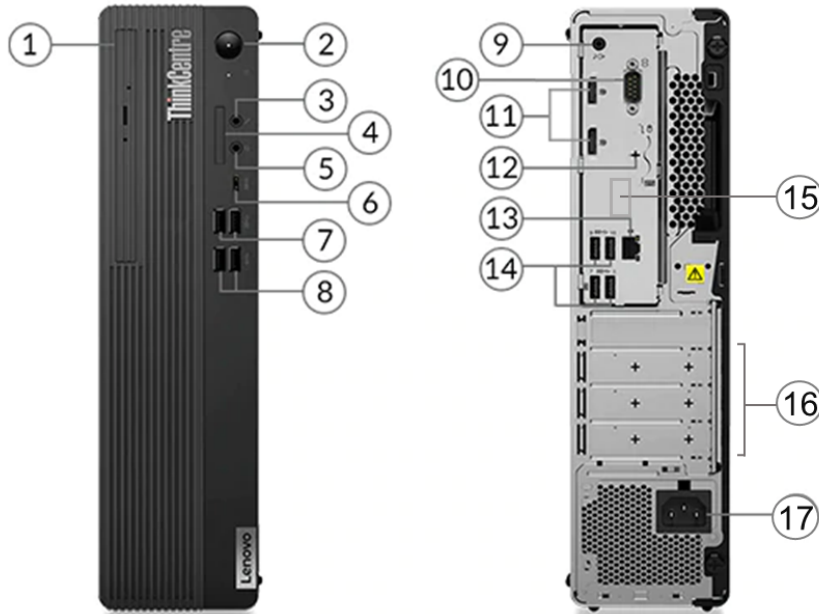

1. Optical drive *	10. Serial
2. Power button	11. 2x DisplayPort
3. Microphone (3.5mm)	12. 2x PS/2 ports (keyboard / mouse) *
4. Card reader *	13. Ethernet (RJ-45)
5. Headphone / microphone combo jack (3.5mm)	14. 4x USB 3.2 Gen 1
6. USB-C 3.2 Gen 1	15. Optional Video Port (HDMI / DP / USB-C) *
7. 2x USB 3.2 Gen 1	16. Optional ports on expansion cards *
8. 2x USB 3.2 Gen 2	17. Power connector
9. Line-out (3.5mm)	

Notes:

- Ports with * are only available on selected models

PERFORMANCE

Processor

Processor Family

Intel® Celeron®, Intel Pentium®, or 10th Generation Intel Core™ i3 / i5 / i7 / i9 Processor

Processor**

Processor Name	Cores	Threads	Base Frequency	Max Frequency	Cache	Memory Support	Processor Graphics
Celeron G5900	2	2	3.4GHz	-	2MB	DDR4-2666	Intel UHD Graphics 610
Celeron G5905	2	2	3.5GHz	-	4MB	DDR4-2666	Intel UHD Graphics 610
Celeron G5920	2	2	3.5GHz	-	2MB	DDR4-2666	Intel UHD Graphics 610
Celeron G5925	2	2	3.6GHz	-	4MB	DDR4-2666	Intel UHD Graphics 610
Pentium Gold G6400	2	4	4.0GHz	-	4MB	DDR4-2666	Intel UHD Graphics 610
Pentium Gold G6500	2	4	4.1GHz	-	4MB	DDR4-2666	Intel UHD Graphics 630
Pentium Gold G6600	2	4	4.2GHz	-	4MB	DDR4-2666	Intel UHD Graphics 630
Core i3-10100	4	8	3.6GHz	4.3GHz	6MB	DDR4-2666	Intel UHD Graphics 630
Core i3-10300	4	8	3.7GHz	4.4GHz	8MB	DDR4-2666	Intel UHD Graphics 630
Core i3-10320	4	8	3.8GHz	4.6GHz	8MB	DDR4-2666	Intel UHD Graphics 630
Core i5-10400	6	12	2.9GHz	4.3GHz	12MB	DDR4-2666	Intel UHD Graphics 630
Core i5-10400F	6	12	2.9GHz	4.3GHz	12MB	DDR4-2666	-
Core i5-10500	6	12	3.1GHz	4.5GHz	12MB	DDR4-2666	Intel UHD Graphics 630
Core i5-10600	6	12	3.3GHz	4.8GHz	12MB	DDR4-2666	Intel UHD Graphics 630
Core i7-10700	8	16	2.9GHz	4.8GHz	16MB	DDR4-2933	Intel UHD Graphics 630
Core i7-10700F	8	16	2.9GHz	4.8GHz	16MB	DDR4-2933	-
Core i9-10900	10	20	2.8GHz	5.2GHz	20MB	DDR4-2933	Intel UHD Graphics 630
Core i9-10900F	10	20	2.8GHz	5.2GHz	20MB	DDR4-2933	-

Operating System

Operating System**

- Windows® 10 Pro 64
- Windows 10 Home 64
- Windows 10 IoT Enterprise
- Ubuntu Linux
- No operating system

Graphics

Graphics**[1]

Graphics	Type	Memory	Connector	Max Resolution	Key Features
Intel UHD graphics 610	Integrated	Shared	2x DP, 1x optional video port (HDMI® / 3rd DP / USB-C)	4096x2160@24Hz(onboard HDMI), 4096x2304@60Hz(DP), 4096x2304@60Hz(USB-C)	DirectX® 12
Intel UHD graphics 630	Integrated	Shared	2x DP, 1x optional video port (HDMI / 3rd DP / USB-C)	4096x2160@24Hz(onboard HDMI), 4096x2304@60Hz(DP), 4096x2304@60Hz(USB-C)	DirectX 12
AMD Radeon™ 520	Discrete	2GB GDDR5	2x DP 1.2	4096x2160@60Hz(DP)	DirectX 12
AMD Radeon RX 550X	Discrete	4GB GDDR5	1x HDMI 2.0, 1x DP 1.4	4096x2160@60Hz(HDMI), 3840x2160@60Hz(DP)	DirectX 12
NVIDIA®	Discrete	2GB	1x VGA, 1x HDMI 1.4	2048x1536@75Hz(VGA),	DirectX 12

GeForce® GT 730		GDDR5		3840x2160@30Hz(HDMI)	
-----------------	--	-------	--	----------------------	--

Notes:

- The information of integrated graphics are not applicable for the models without integrated graphics (for the details, please refer to processor section)

Monitor Support

Monitor Support

Supports up to 3 independent displays via onboard ports (2x DisplayPort™ and 1x optional port [HDMI / 3rd DP / USB-C]), more displays support via discrete graphics

Chipset

Chipset

Intel Q470 chipset

Memory

Max Memory^[1]

Up to 128GB DDR4-2933

Memory Slots

Four DDR4 DIMM slots, dual-channel capable

Memory Type^{}**

- DDR4-2666
- DDR4-2933

Notes:

- The max memory is based on the test results with current Lenovo® memory offerings. The system may support more memory as the technology develops.

Storage

Storage Support

Up to four drives, 1x 2.5"/3.5" HDD + 1x 2.5" HDD + 2x M.2 SSD

- 2.5" HDD up to 1TB each
- 3.5" HDD up to 2TB each
- M.2 SSD up to 2TB each
- Optional Intel Optane™ Memory, M.2

Storage Type^{*}**

Disk Type	Interface	RPM	Security
2.5" SATA HDD	SATA 6Gb/s	7.2K	-
3.5" SATA HDD	SATA 6Gb/s	7.2K	-
M.2 2242 SSD	PCIe NVMe, PCIe 3.0 x2	-	-
M.2 2280 SSD	PCIe NVMe, PCIe 3.0 x4	-	Opal
M.2 2280 SSD	PCIe NVMe, PCIe 3.0 x4	-	-
Intel Optane Memory M10	PCIe NVMe, PCIe 3.0 x2	-	-

RAID

RAID 0/1 support (RAID preset only available via special bid model)

Removable Storage

Optical^{}**

- DVD-ROM, SATA 1.5Gb/s, slim (9.0mm)
- DVD burner (DVD±RW), SATA 1.5Gb/s, slim (9.0mm)
- None

Card Reader

- 3-in-1 card reader (SD, SDHC, SDXC)

ThinkCentre M90s

- No card reader

Multi-Media

Audio Chip

High Definition (HD) Audio, Realtek® ALC623-CG codec

Speakers

Single speaker, 1W x1

Power Supply

Power Supply**

Power	Type	Efficiency	Key Features
180W	Fixed	85%	-
260W	Fixed	85%	-
310W	Fixed	92%	-
380W	Fixed	92%	-

DESIGN

Input Device

Keyboard**

- Lenovo Calliope Keyboard (USB connector), black
- Lenovo Calliope Wireless Keyboard (2.4GHz via USB receiver), black
- Lenovo Traditional Keyboard (USB connector), black
- No keyboard

Mouse**

- Lenovo Calliope Mouse (USB connector), black
- Lenovo Calliope Wireless Mouse (2.4GHz via USB receiver), black
- Lenovo Fingerprint Mouse (USB connector), Windows Hello support, black
- No mouse

Mechanical

Form Factor

SFF (8.2L)

Dimensions (WxDxH)

Models	Dimensions
All models	93 x 298 x 340 mm (3.6 x 11.7 x 13.4 inches)

Weight

Models	Weight
All models	5.3 kg (11.7 lbs)

Case Color

Black

Bays

- 1x 2.5" disk bay (optional, or bay comes with disk)
- 1x 3.5" disk bay
- 1x slim ODD bay

Expansion Slots

- One PCIe 3.0 x1, low-profile (length < 155mm, height < 68mm)
- One PCIe 3.0 x4, low-profile (length < 155mm, height < 68mm)
- One PCIe 3.0 x16, low-profile (length < 155mm, height < 68mm)
- One dummy slot, only bracket for optional port extension
- Three M.2 slots (one for WLAN, two for SSD)

Stand

- Vertical stand
- No stand

Others

- (Optional) Dust filter
- Supports Smart Power On

CONNECTIVITY**Network****Onboard Ethernet**

Gigabit Ethernet, Intel Ethernet Connection I219-LM, 1x RJ45, supports Wake-on-LAN

Optional Ethernet**

- Gigabit Ethernet, Bitland BN8E88, 1x RJ-45, PCIe x1
- Gigabit Ethernet, Intel Ethernet Server Adapter I350-T4, 4x RJ-45, PCIe x4
- 2.5 Gigabit Ethernet, Realtek RTL8125BS, 1x RJ-45, PCIe x1
- No optional Ethernet

WLAN + Bluetooth®**

- Realtek RTL8822CE, 802.11ac Dual Band 2x2 Wi-Fi® + Bluetooth 5.0, M.2 card
- Intel Wireless-AC 9560, 802.11ac Dual Band 2x2 Wi-Fi + Bluetooth 5.0, M.2 card
- Intel Wi-Fi 6 AX201, 802.11ax 2x2 Wi-Fi + Bluetooth 5.1, Intel vPro technology support, M.2 Card
- No WLAN and Bluetooth

Ports^[1]**Front Ports**

- 2x USB 3.2 Gen 1
- 2x USB 3.2 Gen 2
- 1x USB-C 3.2 Gen 1
- 1x headphone / microphone combo jack (3.5mm)
- 1x microphone (3.5mm)

Optional Front Ports

- 1x card reader
- None

Rear Ports^[2]

- 4x USB 3.2 Gen 1
- 2x DisplayPort
- 1x serial (9-pin)
- 1x Ethernet (RJ-45)
- 1x line-out (3.5mm)

Optional Rear Ports***

- 2x USB 2.0 (via 2-port adapter)
- 2x USB 3.2 Gen 1 (via 2-port USB expansion card, PCIe x1)
- 2x USB-C 3.2 Gen 2 (via 2-port USB-C expansion card, PCIe x4)
- Optional video port (one of HDMI / DisplayPort / USB-C 3.2 Gen 1 with DisplayPort function)
- 1x serial
- 4x serial (via 4-port serial expansion card, PCIe x1)
- 1x parallel
- 2x PS/2

Notes:

1. The transfer speed of following ports will vary and, depending on many factors, such as the processing speed of the host device, file attributes and other factors related to system configuration and your operating environment, will be slower than theoretical speed.
USB 2.0: 480 Mbit/s;
USB 3.2 Gen 1 (SuperSpeed USB 5Gbps, formerly USB 3.0 / USB 3.1 Gen 1): 5 Gbit/s;
USB 3.2 Gen 2 (SuperSpeed USB 10Gbps, formerly USB 3.1 Gen 2): 10 Gbit/s;
USB 3.2 Gen 2x2 (SuperSpeed USB 20Gbps): 20 Gbit/s;
Thunderbolt™ 3: 40 Gbit/s;
FireWire 400: 400 Mbit/s;
FireWire 800: 800 Mbit/s
2. For video ports on discrete graphics, please see graphics section

Monitor Cable

Monitor Cable***

- DP to dual DP dongle
- DP to DVI-D dongle
- DP to HDMI 1.4 dongle
- DP to VGA cable (1.5M)
- DP to VGA dongle
- No monitor cable

SECURITY & PRIVACY

Security

Security Chip

Discrete TPM 2.0, TCG certified

Physical Locks

- (Optional) E-lock
- (Optional) Smart Cable Clip
- Kensington® Security Slot
- Padlock Loop

Chassis Intrusion Switch

- Chassis intrusion switch
- No chassis intrusion switch

Fingerprint Reader

- Touch style fingerprint reader on mouse
- No fingerprint reader

BIOS Security

- Administrator password
- Power-on password
- Hard disk password
- Boot sequence control
- Boot without keyboard and mouse
- Self-healing BIOS
- Smart USB protection (allows keyboard / mouse only, blocks all storage devices)
- Individual USB port disablement

MANAGEABILITY

System Management

System Management¹

- Intel vPro with Intel AMT 14.0
- None

Notes:

1. Require choosing a vPro-support Wi-Fi adapter to enable vPro function through wireless connection

SERVICE

Warranty

Base Warranty**

- 1-year limited onsite service
- 3-year limited onsite service
- No base warranty

ENVIRONMENTAL

Operating Environment

Temperature

- Operating: 5°C (41°F) to 35°C (95°F)
- Storage: -40°C (-40°F) to 60°C (140°F)

Humidity

- Operating: 20% to 80%
- Storage: 10% to 90%

Altitude

- Operating: -15.2 m (-50 ft) to 3048 m (10,000 ft)
- Storage: -15.2 m (-50 ft) to 12192 m (40,000 ft)

CERTIFICATIONS

Green Certifications

Green Certifications^[1]

- (Optional) EPEAT™ Gold
- (Optional) EPEAT Silver
- (Optional) ENERGY STAR® 8.0
- ErP Lot 3
- TCO Certified 8.0
- RoHS compliant

Notes:

1. ENERGY STAR 8.0 and EPEAT are only available for MT 11D1/11D2

Other Certifications

Other Certifications

- (Optional) TÜV Rheinland® Low Noise
- (Optional) TÜV Rheinland Ultra Low Noise

Mil-Spec Test

MIL-STD-810H military test passed (Low Pressure [Altitude], High Temperature, Low Temperature, Temperature Shock, Humidity, Sand and Dust, Vibration, Shock, Fungus, Solar Radiation)

- Feature with ** means that only one offering listed under the feature is configured on selected models.
- Feature with *** means that one or more offerings listed under the feature could be configured on selected models.
- Lenovo reserves the right to change specifications or other product information without notice. Lenovo is not responsible for photographic or typographical errors. LENOVO PROVIDES THIS PUBLICATION "AS IS," WITHOUT WARRANTY OF ANY KIND, EITHER EXPRESS OR IMPLIED, INCLUDING THE IMPLIED WARRANTIES OF MERCHANTABILITY OR FITNESS FOR A PARTICULAR PURPOSE. Some jurisdictions do not allow disclaimer of express or implied warranties in certain transactions, therefore this disclaimer may not apply to you.
- The specifications on this page may not be available in all regions, and may be changed or updated without notice.



OVERVIEW

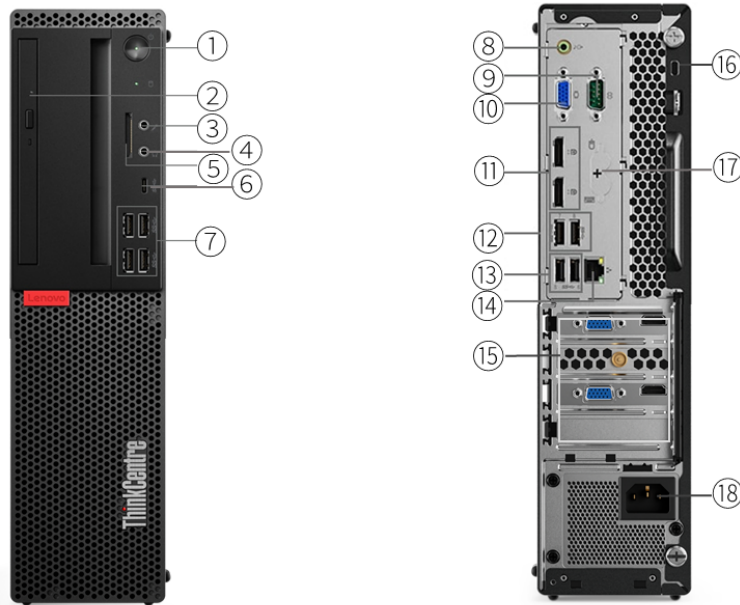

1. Optical drive *	10. VGA
2. Power button	11. 2x DisplayPort
3. Microphone (3.5mm)	12. 2x USB 3.2 Gen 1
4. Headphone / microphone combo jack (3.5mm)	13. 2x USB 3.2 Gen 1
5. Card reader *	14. Ethernet (RJ-45)
6. USB-C 3.1 Gen 1	15. Optional ports on expansion cards *
7. 2x USB 3.1 Gen 1 + 2x USB 3.1 Gen 2	16. Kensington Security Slot
8. Audio line-out (3.5mm)	17. 2x PS/2 ports (keyboard / mouse) *
9. Serial	18. Power connector

Notes:

- Ports with * are only available on selected models

PERFORMANCE

Processor

Processor Family

Intel® Celeron®, Intel Pentium®, 8th Generation Intel Core™ i3 / i5 / i7, or 9th Generation Intel Core i3 / i5 / i7 / i9 Processor

Processor**

Processor Name	Cores	Threads	Base Frequency	Max Frequency	Cache	Memory Support	Processor Graphics
Celeron G4900	2	2	3.1GHz	-	2MB	DDR4-2400	Intel UHD Graphics 610
Celeron G4920	2	2	3.2GHz	-	2MB	DDR4-2400	Intel UHD Graphics 610
Celeron G4930	2	2	3.2GHz	-	2MB	DDR4-2400	Intel UHD Graphics 610
Celeron G4950	2	2	3.3GHz	-	2MB	DDR4-2400	Intel UHD Graphics 610
Pentium Gold G5400	2	4	3.7GHz	-	4MB	DDR4-2400	Intel UHD Graphics 610
Pentium Gold G5420	2	4	3.8GHz	-	4MB	DDR4-2400	Intel UHD Graphics 610
Pentium Gold G5500	2	4	3.8GHz	-	4MB	DDR4-2400	Intel UHD Graphics 630
Pentium Gold G5600	2	4	3.9GHz	-	4MB	DDR4-2400	Intel UHD Graphics 630
Pentium Gold G5620	2	4	4.0GHz	-	4MB	DDR4-2400	Intel UHD Graphics 630
Core i3-8100	4	4	3.6GHz	-	6MB	DDR4-2400	Intel UHD Graphics 630
Core i3-8300	4	4	3.7GHz	-	8MB	DDR4-2400	Intel UHD Graphics 630
Core i3-9100	4	4	3.6GHz	4.2GHz	6MB	DDR4-2400	Intel UHD Graphics 630
Core i3-9300	4	4	3.7GHz	4.3GHz	8MB	DDR4-2400	Intel UHD Graphics 630
Core i3-9320	4	4	3.7GHz	4.4GHz	8MB	DDR4-2400	Intel UHD Graphics 630
Core i5-8400	6	6	2.8GHz	4.0GHz	9MB	DDR4-2666	Intel UHD Graphics 630
Core i5-8500	6	6	3.0GHz	4.1GHz	9MB	DDR4-2666	Intel UHD Graphics 630
Core i5-8600	6	6	3.1GHz	4.3GHz	9MB	DDR4-2666	Intel UHD Graphics 630
Core i5-9400	6	6	2.9GHz	4.1GHz	9MB	DDR4-2666	Intel UHD Graphics 630
Core i5-9400F	6	6	2.9GHz	4.1GHz	9MB	DDR4-2666	-
Core i5-9500	6	6	3.0GHz	4.4GHz	9MB	DDR4-2666	Intel UHD Graphics 630
Core i5-9500F	6	6	3.0GHz	4.4GHz	9MB	DDR4-2666	-
Core i5-9600	6	6	3.1GHz	4.6GHz	9MB	DDR4-2666	Intel UHD Graphics 630
Core i7-8700	6	12	3.2GHz	4.6GHz	12MB	DDR4-2666	Intel UHD Graphics 630
Core i7-9700	8	8	3.0GHz	4.7GHz	12MB	DDR4-2666	Intel UHD Graphics 630
Core i9-9900	8	16	3.1GHz	5.0GHz	16MB	DDR4-2666	Intel UHD Graphics 630

Operating System

Operating System**

- Windows® 10 Pro 64
- Windows 10 Home 64
- Ubuntu Linux
- No operating system

Graphics

Graphics***[]

Graphics	Type	Memory	Connector	Max Resolution	Key Features
Intel UHD graphics 610	Integrated	Shared	1x VGA, 2x DP	2048x1536@50Hz(VGA), 4096x2304@60Hz(DP)	DirectX® 12
Intel UHD graphics 630	Integrated	Shared	1x VGA, 2x DP	2048x1536@50Hz(VGA), 4096x2304@60Hz(DP)	DirectX 12

AMD Radeon™ 520	Discrete	2GB GDDR5	2x DP 1.2	4096x2160@60Hz(DP)	DirectX 12
NVIDIA® GeForce® GT 730	Discrete	2GB GDDR5	2x DP	3840x2160@60Hz(DP)	DirectX 12, PCIe 2.0 x16, 35 watts

Notes:

- The information of integrated graphics are not applicable for the models without integrated graphics (for the details, please refer to processor section)

Monitor Support**Monitor Support**

Supports up to 3 independent displays via onboard ports (VGA and 2x DisplayPort™), more displays support via discrete graphics

Chipset**Chipset**

Intel Q370 chipset

Memory**Max Memory^[1]**

Up to 64GB DDR4-2666

Memory Slots

Four DDR4 DIMM slots, dual-channel capable

Memory Type

DDR4-2666

Notes:

- The max memory is based on the test results with current Lenovo® memory offerings. The system may support more memory as the technology develops.

Storage**Storage Support**

Up to three drives, 1x 2.5"/3.5" HDD/SSD + 1x 2.5" HDD/SSD + 1x M.2 SSD

- 2.5" HDD up to 1TB each
- 3.5" HDD up to 2TB
- 2.5" SSD up to 256GB each
- M.2 SSD up to 1TB
- Optional Intel Optane™ Memory, M.2

Storage Type^{*}**

Disk Type	Interface	RPM	Security
2.5" SATA HDD	SATA 6Gb/s	7.2K	-
2.5" SATA SSD	SATA 6Gb/s	-	Opal
2.5" SATA SSD	SATA 6Gb/s	-	-
3.5" SATA HDD	SATA 6Gb/s	7.2K	-
M.2 2242 SSD	PCIe NVMe, PCIe 3.0 x2	-	-
M.2 2280 SSD	PCIe NVMe, PCIe 3.0 x4	-	Opal
M.2 2280 SSD	PCIe NVMe, PCIe 3.0 x4	-	-
Intel Optane Memory M10	PCIe NVMe, PCIe 3.0 x2	-	-

RAID

RAID 0/1 support for HDDs (RAID preset only available via special bid model)

Removable Storage**Optical^{**}**

ThinkCentre M920 SFF

- DVD-ROM, SATA 1.5Gb/s, slim (9.0mm)
- DVD burner (DVD±RW), SATA 1.5Gb/s, slim (9.0mm)
- None

Card Reader

- 7-in-1 card reader
- No card reader

Multi-Media

Audio Chip

High Definition (HD) Audio, Realtek® ALC233VB2 codec

Speakers

Single speaker, 1W x1

Power Supply

Power Supply**

Power	Type	Efficiency	Key Features
180W	Fixed	85%	-
210W	Fixed	85%	-
260W	Fixed	92%	-

DESIGN

Input Device

Keyboard**

- Lenovo Calliope Wireless Keyboard (2.4GHz via USB receiver), black
- Lenovo Keyboard (PS/2 connector), black
- Lenovo Traditional Keyboard (USB connector), black
- No keyboard

Mouse**

- Lenovo Calliope Mouse (USB connector), black
- Lenovo Calliope Wireless Mouse (2.4GHz via USB receiver), black
- Lenovo Mouse (PS/2 connector), black (only available via special bid)
- Lenovo Fingerprint Mouse (USB connector), Windows Hello support, black
- No mouse

Mechanical

Form Factor

SFF (8.4L)

Dimensions (WxDxH)

Models	Dimensions
All models	92.5 x 290.5 x 343.5 mm (3.6 x 11.4 x 13.5 inches)

Weight

Models	Weight
All models	6.0 kg (13.2 lbs)

Case Color

Black

Bays

- 1x 2.5" disk bay (optional, or bay comes with disk)
- 1x 3.5" disk bay
- 1x slim ODD bay

Expansion Slots

- One PCIe 3.0 x1, low-profile (length < 150mm, height < 68mm)

ThinkCentre M920 SFF

- One PCIe 3.0 x16 (x4 signal), low-profile (length < 150mm, height < 68mm)
- One PCIe 3.0 x16, low-profile (length < 150mm, height < 68mm)
- One dummy slot, only bracket for optional port extension
- Two M.2 slots (one for WLAN, one for SSD)

EOU

Toolless cover, disk, optical, extension card assembly / removal

Stand

- Vertical stand
- No stand

Others

(Optional) Dust filter

CONNECTIVITY

Network

Onboard Ethernet

Gigabit Ethernet, Intel Ethernet Connection I219-LM, 1x RJ45, supports Wake-on-LAN

Optional Ethernet**

- Gigabit Ethernet, Bitland BN8E88, 1x RJ-45, PCIe x1
- Gigabit Ethernet, Intel Ethernet Server Adapter I350-T4, 4x RJ-45, PCIe x4
- No optional Ethernet

WLAN + Bluetooth®**

- Realtek RTL8821CE, 802.11ac Dual Band 1x1 Wi-Fi® + Bluetooth 4.2, M.2 card
- Realtek RTL8822BE, 802.11ac Dual Band 2x2 Wi-Fi + Bluetooth 4.2, M.2 card
- Intel Dual Band Wireless-AC 3165, 802.11ac Dual Band 1x1 Wi-Fi + Bluetooth 4.2, M.2 Card
- Intel Dual Band Wireless-AC 8265, 802.11ac Dual Band 2x2 Wi-Fi + Bluetooth 4.2, M.2 Card
- Intel Wireless-AC 9560, 802.11ac Dual Band 2x2 Wi-Fi + Bluetooth 5.0, Intel vPro technology support, M.2 card
- No WLAN and Bluetooth

Ports^[1]

Front Ports

- 2x USB 3.1 Gen 1
- 2x USB 3.1 Gen 2
- 1x USB-C 3.1 Gen 1
- 1x headphone / microphone combo jack (3.5mm)
- 1x microphone (3.5mm)

Optional Front Ports

- 1x card reader
- None

Rear Ports^[2]

- 4x USB 3.1 Gen 1
- 1x VGA
- 2x DisplayPort
- 1x serial (9-pin)
- 1x Ethernet (RJ-45)
- 1x line-out (3.5mm)

Optional Rear Ports***

- 2x USB 2.0 (via 2-port adapter)
- 2x USB 3.2 Gen 1 (via 2-port USB expansion card, PCIe x1)
- 2x USB-C 3.2 Gen 2 (via 2-port USB-C expansion card, PCIe x4)
- 1x Thunderbolt™ 3 (combo USB-C 3.1 Gen 2 / DisplayPort, via Thunderbolt expansion card, PCIe x4)
- 1x serial
- 4x serial (via 4-port serial expansion card, PCIe x1)
- 1x parallel
- 2x PS/2

Notes:

1. The transfer speed of following ports will vary and, depending on many factors, such as the processing speed of the host device, file attributes and other factors related to system configuration and your operating environment, will be slower than theoretical speed.
USB 2.0: 480 Mbit/s;
USB 3.2 Gen 1 (SuperSpeed USB 5Gbps, formerly USB 3.0 / USB 3.1 Gen 1): 5 Gbit/s;
USB 3.2 Gen 2 (SuperSpeed USB 10Gbps, formerly USB 3.1 Gen 2): 10 Gbit/s;
USB 3.2 Gen 2x2 (SuperSpeed USB 20Gbps): 20 Gbit/s;
Thunderbolt 3: 40 Gbit/s;
FireWire 400: 400 Mbit/s;
FireWire 800: 800 Mbit/s
2. For video ports on discrete graphics, please see graphics section

Monitor Cable

Monitor Cable***

- DP to dual DP dongle
- DP to DVI-D dongle
- DP to HDMI® 1.4 dongle
- DP to VGA cable (1.5M)
- DP to VGA dongle
- No monitor cable

SECURITY & PRIVACY

Security

Security Chip

Discrete TPM 2.0, TCG certified

Physical Locks

- (Optional) E-lock
- (Optional) Smart Cable Clip
- Kensington® Security Slot
- Padlock Loop

Chassis Intrusion Switch

- Chassis intrusion switch
- No chassis intrusion switch

Fingerprint Reader

- Touch style fingerprint reader on mouse
- No fingerprint reader

BIOS Security

- Administrator password
- Power-on password
- Hard disk password
- Boot sequence control
- Boot without keyboard and mouse
- Smart USB protection (allows keyboard / mouse only, blocks all storage devices)
- Individual USB port disablement

MANAGEABILITY

System Management

System Management^[1]

- Intel vPro with Intel AMT 12.0
- None

Notes:

1. Require choosing a vPro-support Wi-Fi adapter to enable vPro function through wireless connection

SERVICE

Warranty

Base Warranty**

- 1-year depot service
- 1-year limited onsite service
- 3-year depot service
- 3-year limited onsite service
- 3-year split limited onsite service
- No base warranty

ENVIRONMENTAL**Operating Environment****Temperature**

- Operating: 5°C (41°F) to 35°C (95°F)
- Storage: -40°C (-40°F) to 60°C (140°F)

Humidity

- Operating: 20% to 80%
- Storage: 10% to 90%

Altitude

- Operating: -15.2 m (-50 ft) to 3048 m (10,000 ft)
- Storage: -15.2 m (-50 ft) to 12192 m (40,000 ft)

CERTIFICATIONS**Green Certifications****Green Certifications^[1]**

- (Optional) EPEAT™ Silver
- (Optional) ENERGY STAR® 8.0
- ErP Lot 3
- TCO
- RoHS compliant

Notes:

1. ENERGY STAR 8.0 and EPEAT are only available for MT 10U2/10U3 with i3/i5/i7/i9 processor

Other Certifications**Other Certifications**

(Optional) TÜV Rheinland® Low Noise

- Feature with ** means that only one offering listed under the feature is configured on selected models.
- Feature with *** means that one or more offerings listed under the feature could be configured on selected models.
- Lenovo reserves the right to change specifications or other product information without notice. Lenovo is not responsible for photographic or typographical errors. LENOVO PROVIDES THIS PUBLICATION "AS IS," WITHOUT WARRANTY OF ANY KIND, EITHER EXPRESS OR IMPLIED, INCLUDING THE IMPLIED WARRANTIES OF MERCHANTABILITY OR FITNESS FOR A PARTICULAR PURPOSE. Some jurisdictions do not allow disclaimer of express or implied warranties in certain transactions, therefore this disclaimer may not apply to you.
- The specifications on this page may not be available in all regions, and may be changed or updated without notice.





OVERVIEW

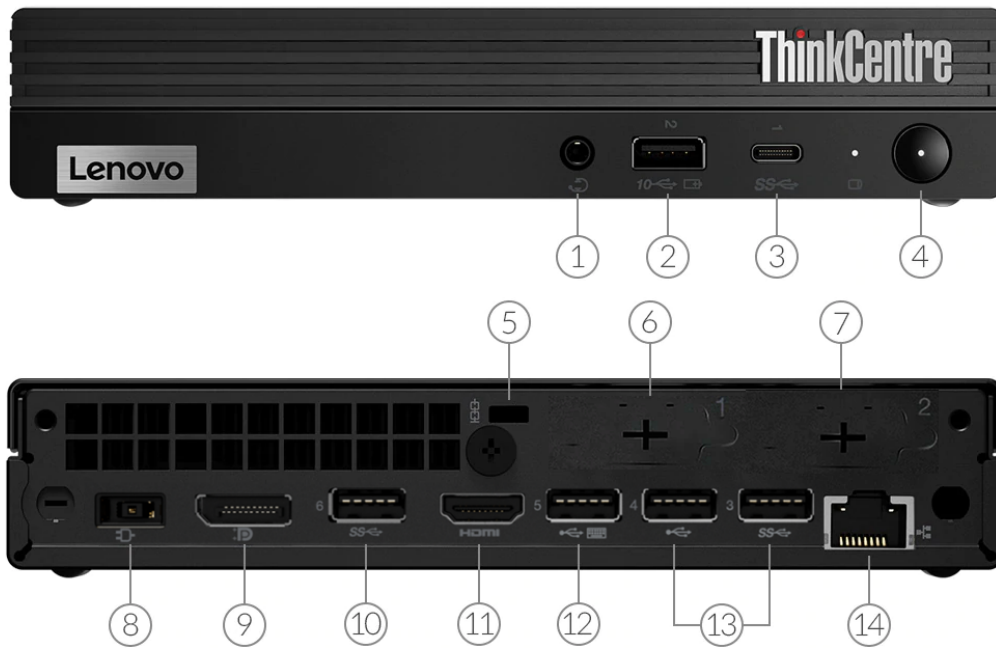

1. Headphone / microphone combo jack (3.5mm)	8. Power connector
2. USB 3.2 Gen 2	9. DisplayPort
3. USB-C 3.2 Gen 1	10. USB 3.2 Gen 1
4. Power button	11. HDMI
5. Kensington Security Slot	12. USB 2.0
6. Dummy port (no function) *	13. 1x USB 2.0 + 1x USB 3.2 Gen 1
7. Dummy port (no function) *	14. Ethernet (RJ-45)

Notes:

- Ports with * are only available on selected models

PERFORMANCE

Processor

Processor Family

10th Generation Intel® Core™ i3 / i5 Processor

Processor**

Processor Name	Cores	Threads	Base Frequency	Max Frequency	Cache	Memory Support	Processor Graphics
Core i3-1005G1	2	4	1.2GHz	3.4GHz	4MB	DDR4-3200	Intel UHD Graphics
Core i5-1035G1	4	8	1.0GHz	3.6GHz	6MB	DDR4-3200	Intel UHD Graphics

Operating System

Operating System**

- Windows® 10 Pro 64
- Windows 10 Home 64
- Windows 11 Pro 64
- Windows 11 Home 64
- Windows 11 DG Windows 10 Pro 64
- Ubuntu Linux

Graphics

Graphics^[1]

Graphics	Type	Memory	Connector	Max Resolution	Key Features
Intel UHD graphics	Integrated	Shared	1x HDMI®, 1x DP	4096x2304@24Hz(HDMI), 4096x2304@60Hz(DP)	DirectX® 12

Notes:

1. The information of integrated graphics are not applicable for the models without integrated graphics (for the details, please refer to processor section)

Monitor Support

Monitor Support

Supports up to 2 independent displays via onboard ports (DisplayPort™ and HDMI)

Chipset

Chipset

Intel SoC (System on Chip) platform

Memory

Max Memory^[1]

Up to 32GB DDR4-2666

Memory Slots

Two DDR4 SO-DIMM slots, dual-channel capable

Memory Type

DDR4-2666

Notes:

1. The max memory is based on the test results with current Lenovo® memory offerings. The system may support more memory as the technology develops.

Storage

Storage Support

Up to two drives, 1x 2.5" HDD + 1x M.2 SSD

- 2.5" HDD up to 2TB
- M.2 SSD up to 512GB

Storage Type***

Disk Type	Interface	RPM	Security
2.5" SATA HDD	SATA 6Gb/s	5.4K	-
M.2 2242 SSD	PCIe NVMe	-	-
M.2 2280 SSD	PCIe NVMe	-	Opal

Multi-Media**Audio Chip**

High Definition (HD) Audio

Speakers

- Single speaker
- No speakers

Power Supply**Power Supply**

Power	Type	Efficiency	Key Features
65W	Adapter	89%	Autosensing
No power supply	-	-	-

DESIGN**Input Device****Keyboard****

- Lenovo Calliope Keyboard (USB connector), black
- USB Traditional Keyboard, black
- No keyboard

Mouse

- USB Calliope Mouse, black
- No mouse

Mechanical**Form Factor**

Tiny (1L)

Dimensions (WxDxH)

Models	Dimensions
All models	179 x 182.9 x 36.5 mm (7.05 x 7.20 x 1.4 inches)

Weight

Models	Weight
All models	1.25 kg (2.76 lbs)

Case Color

Black

Expansion Slots

- One M.2 slot (for WLAN)
- One M.2 slot (for SSD)

EOU

- (Optional) toolless chassis open (toolless chassis screw required) and toolless M.2 SSD, HDD, memory assembly / removal
- No support

Stand

- Vertical stand

- No stand

Mounting

- VESA mount bracket kit, supports VESA mount 75mm and 100mm
- None

CONNECTIVITY

Network

Onboard Ethernet

Gigabit Ethernet, 1x RJ45

WLAN + Bluetooth^{®**}

- Realtek[®] RTL8822CE, 802.11ac Dual Band 2x2 Wi-Fi[®] + Bluetooth 5.0, M.2 card
- Intel Wireless-AC 9560, 802.11ac Dual Band 2x2 Wi-Fi + Bluetooth 5.1, M.2 card
- Intel Wi-Fi 6 AX200, 802.11ax 2x2 Wi-Fi + Bluetooth 5.1, M.2 card
- Intel Wi-Fi 6 AX201, 802.11ax 2x2 Wi-Fi + Bluetooth 5.2, M.2 Card
- No WLAN and Bluetooth

Ports^[1]

Front Ports

- 1x USB 3.2 Gen 2
- 1x USB-C 3.2 Gen 1
- 1x headphone / microphone combo jack (3.5mm)

Rear Ports^[2]

- 2x USB 2.0
- 2x USB 3.2 Gen 1
- 1x HDMI
- 1x DisplayPort
- 1x Ethernet (RJ-45)

Optional Rear Ports

1x parallel (external USB to parallel dongle)

Notes:

1. The transfer speed of following ports will vary and, depending on many factors, such as the processing speed of the host device, file attributes and other factors related to system configuration and your operating environment, will be slower than theoretical speed.
USB 2.0: 480 Mbit/s;
USB 3.2 Gen 1 (SuperSpeed USB 5Gbps, formerly USB 3.0 / USB 3.1 Gen 1): 5 Gbit/s;
USB 3.2 Gen 2 (SuperSpeed USB 10Gbps, formerly USB 3.1 Gen 2): 10 Gbit/s;
USB 3.2 Gen 2x2 (SuperSpeed USB 20Gbps): 20 Gbit/s;
Thunderbolt[™] 3: 40 Gbit/s;
FireWire 400: 400 Mbit/s;
FireWire 800: 800 Mbit/s
2. For video ports on discrete graphics, please see graphics section

SECURITY & PRIVACY

Security

Security Chip

Firmware TPM 2.0 integrated in chipset

Physical Locks

Kensington[®] Security Slot

Chassis Intrusion Switch

No chassis intrusion switch

BIOS Security

- Administrator password
- Power-on password
- Hard disk password
- Boot sequence control

- Boot without keyboard and mouse
- Individual USB port disablement

MANAGEABILITY

System Management

System Management

None

SERVICE

Warranty

Base Warranty**

- 1-year depot service
- 1-year limited onsite service

ENVIRONMENTAL

Operating Environment

Temperature

- Operating: 5°C (41°F) to 35°C (95°F)
- Storage: -40°C (-40°F) to 60°C (140°F)

Humidity

- Operating: 20% to 80%
- Storage: 10% to 90%

Altitude

- Operating: -15.2 m (-50 ft) to 3048 m (10,000 ft)
- Storage: -15.2 m (-50 ft) to 12192 m (40,000 ft)

CERTIFICATIONS

Green Certifications

Green Certifications

RoHS compliant

Other Certifications

Mil-Spec Test

MIL-STD-810G military test passed

- Feature with ** means that only one offering listed under the feature is configured on selected models.
- Feature with *** means that one or more offerings listed under the feature could be configured on selected models.
- Lenovo reserves the right to change specifications or other product information without notice. Lenovo is not responsible for photographic or typographical errors. LENOVO PROVIDES THIS PUBLICATION "AS IS," WITHOUT WARRANTY OF ANY KIND, EITHER EXPRESS OR IMPLIED, INCLUDING THE IMPLIED WARRANTIES OF MERCHANTABILITY OR FITNESS FOR A PARTICULAR PURPOSE. Some jurisdictions do not allow disclaimer of express or implied warranties in certain transactions, therefore this disclaimer may not apply to you.

- The specifications on this page may not be available in all regions, and may be changed or updated without notice.



intel



intel



intel



intel



intel



intel

OVERVIEW

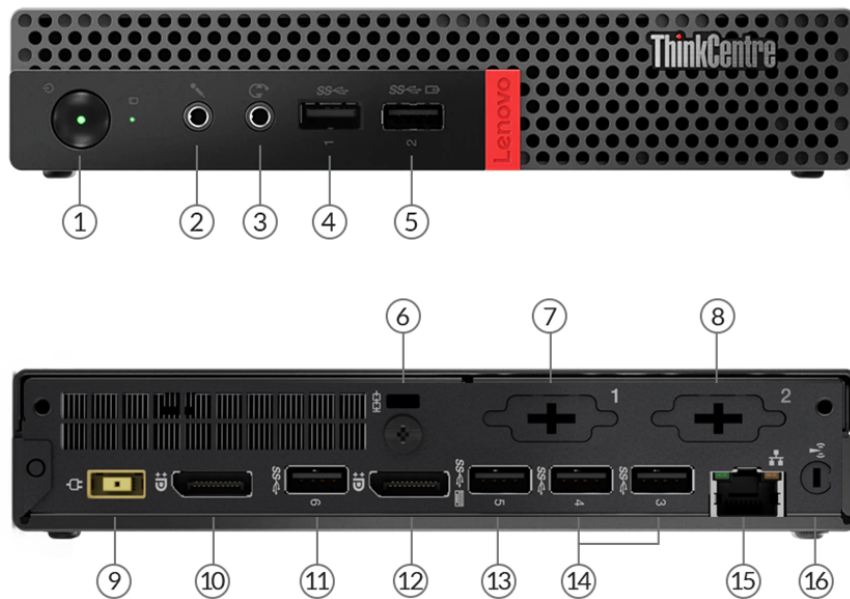

1. Power button	9. Power connector
2. Microphone (3.5mm)	10. DisplayPort
3. Headphone / microphone combo jack (3.5mm)	11. USB 3.1 Gen 1
4. USB 3.1 Gen 1	12. DisplayPort
5. USB 3.1 Gen 1	13. USB 2.0
6. Kensington Security Slot	14. 2x USB 2.0
7. Optional port 1 *	15. Ethernet (RJ-45)
8. Optional port 2 *	16. Wi-Fi antenna slot

Notes:

- Ports with * are only available on selected models

PERFORMANCE

Processor

Processor Family

AMD E2 / A4 Processor

Processor**

Processor Name	Cores	Threads	Base Frequency	Max Frequency	Cache	Memory Support	Processor Graphics
AMD E2-9000e	2	2	1.5GHz	2.0GHz	1MB L2	DDR4-1866	AMD Radeon™ R2 Graphics
AMD A4-9120e	2	2	1.5GHz	2.2GHz	1MB L2	DDR4-1866	AMD Radeon R3 Graphics
AMD A4-9120C	2	2	1.6GHz	2.4GHz	1MB L2	DDR4-1866	AMD Radeon R4 Graphics

Operating System

Operating System**

- Windows® 10 IoT Enterprise
- Windows Embedded Standard 7 V2 (WES 7 V2)
- LeTOS V2 (Lenovo® Terminal Operating System, Linux-based)

Graphics

Graphics**^[1]

Graphics	Type	Memory	Connector	Max Resolution	Key Features
AMD Radeon R2 Graphics	Integrated	Shared	2x DisplayPort™, 1x optional port (VGA / USB-C)	3840x2160@60Hz(DP), 2048x1280@60Hz(VGA), 3840x2160@60Hz(USB-C)	DirectX® 12
AMD Radeon R3 Graphics	Integrated	Shared	2x DisplayPort, 1x optional port (VGA / USB-C)	3840x2160@60Hz(DP), 2048x1280@60Hz(VGA), 3840x2160@60Hz(USB-C)	DirectX 12
AMD Radeon R4 Graphics	Integrated	Shared	2x DisplayPort, 1x optional port (VGA / USB-C)	3840x2160@60Hz(DP), 2048x1280@60Hz(VGA), 3840x2160@60Hz(USB-C)	DirectX 12

Notes:

1. The information of integrated graphics are not applicable for the models without integrated graphics (for the details, please refer to processor section)

Monitor Support

Monitor Support

Supports up to 3 independent displays via onboard ports (2x DisplayPort and 1x optional port [VGA / USB-C])

Chipset

Chipset

AMD SoC (System on Chip) platform

Memory

Max Memory^[1]

Up to 8GB DDR4-2666

Memory Slots

One DDR4 SO-DIMM slot

Memory Type^[2]

DDR4-2666

Notes:

1. The max memory is based on the test results with current Lenovo memory offerings. The system may support more memory as the technology develops.

ThinkCentre M625 Tiny Thin Client

2. Installed memory is actually 2666MHz, but run at 1866 due to the memory support capability of processor

Storage

Storage Support

One drive, up to 128GB M.2 2242 SSD

Storage Type**

Disk Type	Interface	RPM	Security
M.2 2242 SSD	SATA 6Gb/s	-	-
M.2 2242 SSD	PCIe NVMe, PCIe 3.0 x2	-	-

RAID

No support

Removable Storage

Optical

None

Card Reader

No card reader

Multi-Media

Audio Chip

High Definition (HD) Audio, Realtek® ALC233-VB2-CG codec

Speakers

Single speaker, 1.5W x1

Power Supply

Power Supply**

Power	Type	Efficiency	Key Features
65W	Adapter	88%	Autosensing
135W	Adapter	89%	Autosensing
No power supply	-	-	-

DESIGN

Input Device

Keyboard

- Lenovo Traditional Keyboard (USB connector), black
- No keyboard

Mouse

Lenovo Calliope Mouse (USB connector), black

Mechanical

Form Factor

Tiny (1L)

Dimensions (WxDxH)

Models	Dimensions
All models	179 x 182.9 x 34.5 mm (7.05 x 7.20 x 1.36 inches)

Weight^[1]

Models	Weight
All models	1.3 kg (2.9 lbs)

ThinkCentre M625 Tiny Thin Client

Case Color

Black

Bays

No bays

Expansion Slots

Two M.2 slots (one for WLAN, one for SSD)

EOU

(Optional) toolless chassis open (toolless chassis screw required) and toolless M.2 SSD, HDD, memory assembly / removal

Stand

- Vertical stand
- No stand

Mounting

- VESA mount bracket kit, supports VESA mount 75mm and 100mm
- None

Others

(Optional) Power adapter cage

Notes:

1. Weight may vary by configuration

CONNECTIVITY

Network

Onboard Ethernet

Gigabit Ethernet, Realtek RTL8111HN, 1x RJ45, supports Wake-on-LAN

Optional Ethernet

No optional Ethernet

WLAN + Bluetooth[®]*^[1]

- Realtek RTL8821CE, 802.11ac Dual Band 1x1 Wi-Fi[®] + Bluetooth 4.2, M.2 card
- Realtek RTL8822BE, 802.11ac Dual Band 2x2 Wi-Fi + Bluetooth 4.2, M.2 card
- Qualcomm[®] QCA6174A, 802.11ac Dual Band 2x2 Wi-Fi + Bluetooth 4.2, M.2 card
- Qualcomm QCA9377, 802.11ac Dual Band 1x1 Wi-Fi + Bluetooth 4.2, M.2 card
- Intel[®] Wireless-AC 9260, 802.11ac Dual Band 2x2 Wi-Fi + Bluetooth 5.0, M.2 card
- No WLAN and Bluetooth

Notes:

1. Win 10 RS3 and Win10 earlier version only support Bluetooth 4.1

Ports^[1]

Front Ports

- 2x USB 3.1 Gen 1 (one supports Always On and fast charge)
- 1x headphone / microphone combo jack (3.5mm)
- 1x microphone (3.5mm)

Optional Front Ports

None

Rear Ports^[2]

- 3x USB 2.0
- 1x USB 3.1 Gen 1
- 2x DisplayPort
- 1x Ethernet (RJ-45)

Optional Rear Ports^{***}

- Optional port 1 (one of VGA / serial / USB-C 2.0 with DisplayPort function)
- Optional port 2 (serial)

ThinkCentre M625 Tiny Thin Client

Notes:

- The transfer speed of following ports will vary and, depending on many factors, such as the processing speed of the host device, file attributes and other factors related to system configuration and your operating environment, will be slower than theoretical speed.
 USB 2.0: 480 Mbit/s;
 USB 3.2 Gen 1 (SuperSpeed USB 5Gbps, formerly USB 3.0 / USB 3.1 Gen 1): 5 Gbit/s;
 USB 3.2 Gen 2 (SuperSpeed USB 10Gbps, formerly USB 3.1 Gen 2): 10 Gbit/s;
 USB 3.2 Gen 2x2 (SuperSpeed USB 20Gbps): 20 Gbit/s;
 Thunderbolt™ 3: 40 Gbit/s;
 FireWire 400: 400 Mbit/s;
 FireWire 800: 800 Mbit/s
- For video ports on discrete graphics, please see graphics section

Monitor Cable

Monitor Cable***

- VGA Cable Tiny
- DP to DVI-D dongle
- DP to HDMI® 1.4 dongle
- DP to VGA cable (1.5M)
- DP to VGA dongle
- No monitor cable

SECURITY & PRIVACY

Security

Security Chip

Discrete TPM 2.0, TCG certified

Physical Locks

Kensington® Security Slot

Chassis Intrusion Switch

Chassis intrusion switch

Fingerprint Reader

No fingerprint reader

BIOS Security

- Administrator password
- Power-on password
- Hard disk password
- Boot sequence control
- Boot without keyboard and mouse
- Smart USB protection (allows keyboard / mouse only, blocks all storage devices)
- Individual USB port disablement

MANAGEABILITY

System Management

System Management

None

SERVICE

Warranty

Base Warranty**

- 1-year depot service
- 1-year limited onsite service
- 3-year limited onsite service

ENVIRONMENTAL

Operating Environment

Temperature

- Operating: 5°C (41°F) to 35°C (95°F)
- Storage: -40°C (-40°F) to 60°C (140°F)

Humidity

- Operating: 20% to 80%
- Storage: 10% to 90%

Altitude

- Operating: -15.2 m (-50 ft) to 3048 m (10,000 ft)
- Storage: -15.2 m (-50 ft) to 12192 m (40,000 ft)

CERTIFICATIONS

Green Certifications

Green Certifications^[1]

- (Optional) EPEAT™ Gold
- (Optional) EPEAT Silver
- ENERGY STAR® 8.0
- ErP Lot 3
- TCO
- RoHS compliant
- WEEE

Notes:

1. EnergyStar and EPEAT are not for non-OS models

Other Certifications

Mil-Spec Test

MIL-STD-810G military test passed (Low Pressure [Altitude], High Temperature, Low Temperature, Temperature Shock, Humidity, Sand and Dust, Vibration, Shock, Fungus, Solar Radiation)

- Feature with ** means that only one offering listed under the feature is configured on selected models.
- Feature with *** means that one or more offerings listed under the feature could be configured on selected models.
- Lenovo reserves the right to change specifications or other product information without notice. Lenovo is not responsible for photographic or typographical errors. **LENOVO PROVIDES THIS PUBLICATION "AS IS," WITHOUT WARRANTY OF ANY KIND, EITHER EXPRESS OR IMPLIED, INCLUDING THE IMPLIED WARRANTIES OF MERCHANTABILITY OR FITNESS FOR A PARTICULAR PURPOSE.** Some jurisdictions do not allow disclaimer of express or implied warranties in certain transactions, therefore this disclaimer may not apply to you.
- The specifications on this page may not be available in all regions, and may be changed or updated without notice.



OVERVIEW

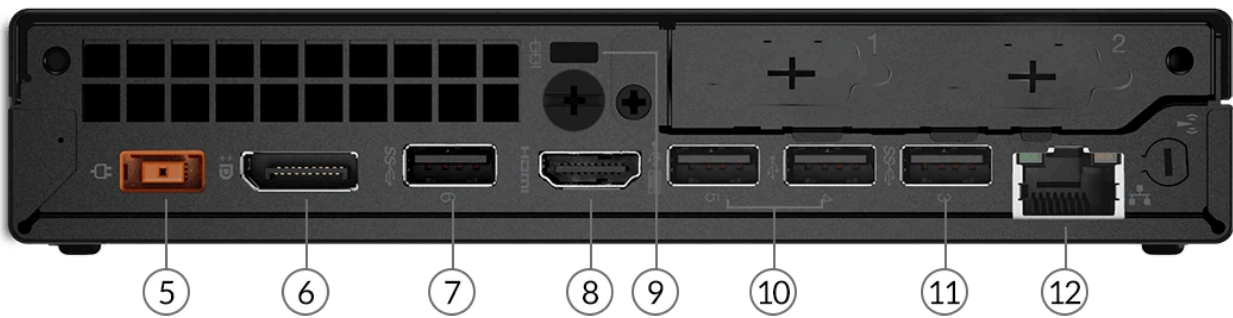
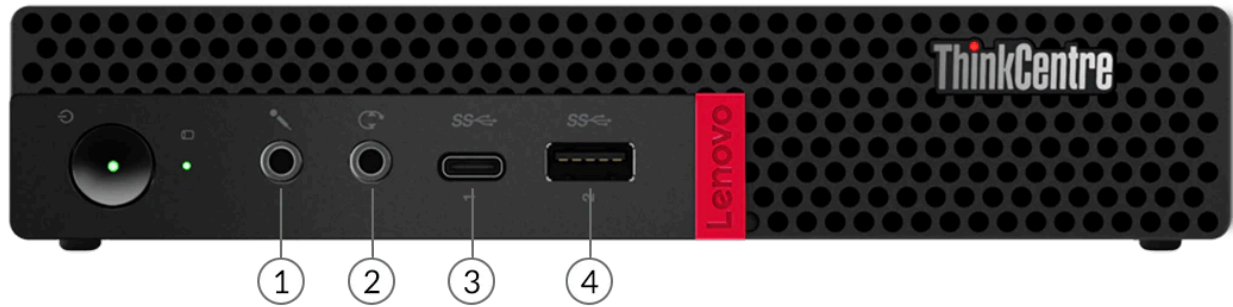

1. Microphone (3.5mm)	7. USB 3.1 Gen 1
2. Headphone / microphone combo jack (3.5mm)	8. HDMI
3. USB-C 3.1 Gen 1	9. Kensington Security Slot
4. USB 3.1 Gen 1	10. 2x USB 2.0
5. Power connector	11. USB 3.1 Gen 1
6. DisplayPort	12. Ethernet (RJ-45)

PERFORMANCE

Processor

Processor Family

Intel® Pentium® or 8th Generation Intel Core™ i3 / i5 Processor

Processor**

Processor Name	Cores	Threads	Base Frequency	Max Frequency	Cache	Memory Support	Processor Graphics
Pentium Gold 5405U	2	4	2.3GHz	-	2MB	DDR4-2133	Intel UHD Graphics
Core i3-8145U	2	4	2.1GHz	3.9GHz	4MB	DDR4-2400	Intel UHD Graphics
Core i5-8265U	4	8	1.6GHz	3.9GHz	6MB	DDR4-2400	Intel UHD Graphics

Operating System

Operating System**

- Windows® 10 Pro 64
- Windows 10 Home 64
- Ubuntu Linux
- No operating system

Graphics

Graphics^[1]

Graphics	Type	Memory	Connector	Max Resolution	Key Features
Intel UHD graphics	Integrated	Shared	1x HDMI®, 1x DP	4096x2304@24Hz(HDMI), 4096x2304@60Hz(DP)	DirectX® 12

Notes:

1. The information of integrated graphics are not applicable for the models without integrated graphics (for the details, please refer to processor section)

Monitor Support

Monitor Support

Supports up to 2 independent displays via onboard ports (DisplayPort™ and HDMI)

Chipset

Chipset

Intel SoC (System on Chip) platform

Memory

Max Memory^[1]

Up to 16GB DDR4-2666

Memory Slots

One DDR4 SO-DIMM slot

Memory Type^[2]

DDR4-2666

Notes:

1. The max memory is based on the test results with current Lenovo® memory offerings. The system may support more memory as the technology develops.
2. System automatically clocks down for the processors with lower memory controller

Storage

Storage Support

Up to two drives, 1x 2.5" HDD/SSD + 1x M.2 SSD

- 2.5" HDD up to 1TB
- M.2 SSD up to 512GB

ThinkCentre M630e Tiny

Storage Type***

Disk Type	Interface	RPM	Security
2.5" SATA HDD	SATA 6Gb/s	5.4K	-
2.5" SATA HDD	SATA 6Gb/s	7.2K	-
2.5" SATA SSD	SATA 6Gb/s	-	-
M.2 2242 SSD	PCIe NVMe, PCIe 3.0 x2	-	-
M.2 2280 SSD	PCIe NVMe, PCIe 3.0 x4	-	Opal

RAID

No support

Removable Storage

Optical

None

Card Reader

No card reader

Multi-Media

Audio Chip

High Definition (HD) Audio, Realtek® ALC233VB codec

Speakers

Single speaker, 1.5W x1

Power Supply

Power Supply

Power	Type	Efficiency	Key Features
65W	Adapter	88%	Autosensing
No power supply	-	-	-

DESIGN

Input Device

Keyboard**

- Lenovo Calliope Keyboard (USB connector), black
- Lenovo Traditional Keyboard (USB connector), black

Mouse

- Lenovo Calliope Mouse (USB connector), black
- No mouse

Mechanical

Form Factor

Tiny (1L)

Dimensions (WxDxH)

Models	Dimensions
All models	179 x 183 x 34.5 / 37 mm with rubber feet (7.05 x 7.2 x 1.36 / 1.5 inches with rubber feet)

Weight

Models	Weight
All models	1.32 kg (2.91 lbs)

Case Color

Black

Bays

1x 2.5" disk bay

Expansion Slots

Two M.2 slots (one for WLAN, one for SSD)

EOU

No support

Stand

- Vertical stand
- No stand

Mounting

- VESA mount bracket kit, supports VESA mount 75mm and 100mm
- None

Others

- (Optional) Dust filter
- (Optional) Power adapter cage

CONNECTIVITY

Network

Onboard Ethernet

Gigabit Ethernet, Realtek RTL8111HN-CG, 1x RJ45, supports Wake-on-LAN

Optional Ethernet

No optional Ethernet

WLAN + Bluetooth[®]**

- Realtek RTL8821CE, 802.11ac Dual Band 1x1 Wi-Fi[®] + Bluetooth 4.2, M.2 card
- Realtek RTL8822BE, 802.11ac Dual Band 2x2 Wi-Fi + Bluetooth 4.2, M.2 card
- Intel Dual Band Wireless-AC 3165, 802.11ac Dual Band 1x1 Wi-Fi + Bluetooth 4.2, M.2 Card
- Intel Dual Band Wireless-AC 8265, 802.11ac Dual Band 2x2 Wi-Fi + Bluetooth 4.2, M.2 Card
- No WLAN and Bluetooth

WWAN

No support

Ports^[1]

Front Ports

- 1x USB 3.1 Gen 1
- 1x USB-C 3.1 Gen 1
- 1x headphone / microphone combo jack (3.5mm)
- 1x microphone (3.5mm)

Optional Front Ports

None

Rear Ports^[2]

- 2x USB 2.0
- 2x USB 3.1 Gen 1
- 1x HDMI
- 1x DisplayPort
- 1x Ethernet (RJ-45)

Optional Rear Ports

1x parallel (external USB to parallel dongle)

Notes:

1. The transfer speed of following ports will vary and, depending on many factors, such as the processing speed of the host device, file attributes and other factors related to system configuration and your operating environment, will be slower than theoretical speed.
USB 2.0: 480 Mbit/s;
USB 3.2 Gen 1 (SuperSpeed USB 5Gbps, formerly USB 3.0 / USB 3.1 Gen 1): 5 Gbit/s;
USB 3.2 Gen 2 (SuperSpeed USB 10Gbps, formerly USB 3.1 Gen 2): 10 Gbit/s;

USB 3.2 Gen 2x2 (SuperSpeed USB 20Gbps): 20 Gbit/s;
Thunderbolt™ 3: 40 Gbit/s;
FireWire 400: 400 Mbit/s;
FireWire 800: 800 Mbit/s

2. For video ports on discrete graphics, please see graphics section

Monitor Cable

Monitor Cable**

- DP to HDMI 1.4 dongle
- DP to VGA cable (1.5M)
- DP to VGA dongle
- No monitor cable

SECURITY & PRIVACY

Security

Security Chip

Firmware TPM 2.0 integrated in chipset

Physical Locks

Kensington® Security Slot

Chassis Intrusion Switch

Chassis intrusion switch

BIOS Security

- Administrator password
- Power-on password
- Hard disk password
- Boot sequence control
- Boot without keyboard and mouse
- Smart USB protection (allows keyboard / mouse only, blocks all storage devices)
- Individual USB port disablement

MANAGEABILITY

System Management

System Management

None

SERVICE

Warranty

Base Warranty**

- 1-year depot service
- 1-year limited onsite service

ENVIRONMENTAL

Operating Environment

Temperature

- Operating: 5°C (41°F) to 35°C (95°F)
- Storage: -40°C (-40°F) to 60°C (140°F)

Humidity

- Operating: 20% to 80%
- Storage: 10% to 90%

Altitude

- Operating: -15.2 m (-50 ft) to 3048 m (10,000 ft)
- Storage: -15.2 m (-50 ft) to 12192 m (40,000 ft)

CERTIFICATIONS

Green Certifications

Green Certifications

- EPEAT™ Silver
- ENERGY STAR® 8.0
- ErP Lot 3
- TCO
- RoHS compliant
- REACH
- WEEE

Other Certifications

Mil-Spec Test

MIL-STD-810G military test passed (Low Pressure [Altitude], High Temperature, Low Temperature, Temperature Shock, Humidity, Sand and Dust, Vibration, Shock, Fungus, Solar Radiation)

- Feature with ** means that only one offering listed under the feature is configured on selected models.
- Feature with *** means that one or more offerings listed under the feature could be configured on selected models.
- Lenovo reserves the right to change specifications or other product information without notice. Lenovo is not responsible for photographic or typographical errors. LENOVO PROVIDES THIS PUBLICATION “AS IS,” WITHOUT WARRANTY OF ANY KIND, EITHER EXPRESS OR IMPLIED, INCLUDING THE IMPLIED WARRANTIES OF MERCHANTABILITY OR FITNESS FOR A PARTICULAR PURPOSE. Some jurisdictions do not allow disclaimer of express or implied warranties in certain transactions, therefore this disclaimer may not apply to you.
- The specifications on this page may not be available in all regions, and may be changed or updated without notice.



OVERVIEW

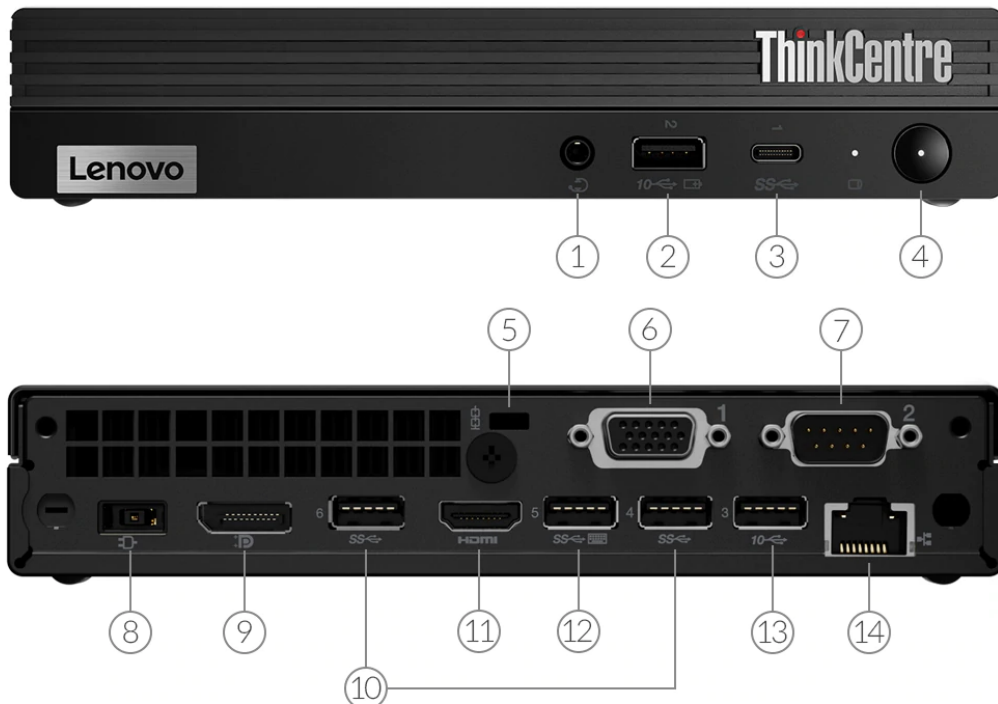

1. Headphone / microphone combo jack (3.5mm)	8. Power connector
2. USB 3.2 Gen 2	9. DisplayPort
3. USB-C 3.2 Gen 1	10. USB 3.2 Gen 1
4. Power button	11. HDMI
5. Kensington Security Slot	12. USB 3.2 Gen 1
6. Optional port 1 (VGA is shown)	13. USB 3.2 Gen 2
7. Optional port 2 (serial is shown)	14. Ethernet (RJ-45)

PERFORMANCE

Processor

Processor Family

Intel® Celeron®, Intel Pentium®, or 10th Generation Intel Core™ i3 / i5 / i7 / i9 Processor

Processor**

Processor Name	Cores	Threads	Base Frequency	Max Frequency	Cache	Memory Support	Processor Graphics
Celeron G5900T	2	2	3.2GHz	-	2MB	DDR4-2666	Intel UHD Graphics 610
Celeron G5905T	2	2	3.3GHz	-	4MB	DDR4-2666	Intel UHD Graphics 610
Pentium Gold G6400T	2	4	3.4GHz	-	4MB	DDR4-2666	Intel UHD Graphics 610
Pentium Gold G6500T	2	4	3.5GHz	-	4MB	DDR4-2666	Intel UHD Graphics 630
Core i3-10100T	4	8	3.0GHz	3.8GHz	6MB	DDR4-2666	Intel UHD Graphics 630
Core i3-10300T	4	8	3.0GHz	3.9GHz	8MB	DDR4-2666	Intel UHD Graphics 630
Core i5-10400T	6	12	2.0GHz	3.6GHz	12MB	DDR4-2666	Intel UHD Graphics 630
Core i5-10500T	6	12	2.3GHz	3.8GHz	12MB	DDR4-2666	Intel UHD Graphics 630
Core i5-10600T	6	12	2.4GHz	4.0GHz	12MB	DDR4-2666	Intel UHD Graphics 630
Core i7-10700T	8	16	2.0GHz	4.5GHz	16MB	DDR4-2933	Intel UHD Graphics 630
Core i9-10900T	10	20	1.9GHz	4.6GHz	20MB	DDR4-2933	Intel UHD Graphics 630

Operating System

Operating System**

- Windows® 10 Pro 64
- Windows 10 Home 64
- Windows 10 IoT Enterprise
- Ubuntu Linux
- No operating system

Graphics

Graphics**^[1]

Graphics	Type	Memory	Connector	Max Resolution	Key Features
Intel UHD graphics 610	Integrated	Shared	1x HDMI®, 1x DP, 1x optional video port (2nd HDMI / VGA / 2nd DP / USB-C / dual DP)	4096x2160@24Hz(onboard HDMI), 4096x2304@60Hz(DP), 3840x2160@60Hz(Dual DP, MST mode), 2048x1536@50Hz(VGA), 4096x2304@60Hz(USB-C)	DirectX® 12
Intel UHD graphics 630	Integrated	Shared	1x HDMI, 1x DP, 1x optional video port (2nd HDMI / VGA / 2nd DP / USB-C / dual DP)	4096x2160@24Hz(onboard HDMI), 4096x2304@60Hz(DP), 3840x2160@60Hz(Dual DP, MST mode), 2048x1536@50Hz(VGA), 4096x2304@60Hz(USB-C)	DirectX 12

Notes:

1. The information of integrated graphics are not applicable for the models without integrated graphics (for the details, please refer to processor section)

Monitor Support

Monitor Support

Supports up to 3 independent displays via (onboard DP, onboard HDMI, and one optional port [VGA / 2nd DP / 2nd HDMI / USB-C]) or (one onboard port [DP / HDMI] and optional dual DP [MST mode])

Chipset

Chipset

Intel H470 chipset

Memory

Max Memory^[1]

Up to 64GB DDR4-2933

Memory Slots

Two DDR4 SO-DIMM slots, dual-channel capable

Memory Type^{**[2]}

- DDR4-2666
- DDR4-2933

Notes:

1. The max memory is based on the test results with current Lenovo® memory offerings. The system may support more memory as the technology develops.
2. Installed memory is actually 3200MHz, but may run at 2666MHz or 2933MHz, depending on the memory support capability of processor

Storage

Storage Support

Up to two drives, 1x 2.5" HDD + 1x M.2 SSD

- 2.5" HDD up to 1TB
- M.2 SSD up to 2TB
- Optional Intel Optane™ Memory, M.2

Storage Type^{***}

Disk Type	Interface	RPM	Security
2.5" SATA HDD	SATA 6Gb/s	7.2K	-
M.2 2242 SSD	PCIe NVMe, PCIe 3.0 x2	-	-
M.2 2242 SSD	PCIe NVMe, PCIe 3.0 x4	-	-
M.2 2280 SSD	PCIe NVMe, PCIe 3.0 x4	-	Opal
M.2 2280 SSD	PCIe NVMe, PCIe 3.0 x4	-	-
Intel Optane Memory M10	PCIe NVMe, PCIe 3.0 x2	-	-

RAID

No support

Removable Storage

Optical^{**}

- DVD-ROM, slim (9.0mm), via USB external ODD box
- DVD burner (DVD±RW), slim (9.0mm), via USB external ODD box
- None

Card Reader

No card reader

Multi-Media

Audio Chip

High Definition (HD) Audio, Realtek® ALC233VB codec or ALC897Q codec

Speakers

Single speaker, 1.5W x1

Power Supply

Power Supply**

Power	Type	Efficiency	Key Features
65W	Adapter	89%	Autosensing
90W	Adapter	89%	Autosensing
135W	Adapter	89%	Autosensing
No power supply	-	-	-

DESIGN

Input Device

Keyboard**

- Lenovo Calliope Keyboard (USB connector), black
- Lenovo Calliope Wireless Keyboard (2.4GHz via USB receiver), black
- Lenovo Traditional Keyboard (USB connector), black
- No keyboard

Mouse**

- Lenovo Calliope Mouse (USB connector), black
- Lenovo Calliope Wireless Mouse (2.4GHz via USB receiver), black
- Lenovo Fingerprint Mouse (USB connector), Windows Hello support, black
- No mouse

Mechanical

Form Factor

Tiny (1L)

Dimensions (WxDxH)

Models	Dimensions
Tiny only	179 x 183 x 34.5 / 37 mm with rubber feet (7.05 x 7.2 x 1.36 / 1.5 inches with rubber feet)
With VESA mount & ODD box	187 x 183.8 x 66.5 mm (7.36 x 7.24 x 2.62 inches)

Weight

Models	Weight
Tiny only	1.25 kg (2.76 lbs)
With VESA mount & ODD box	1.74 kg (3.84 lbs)

Case Color

Black

Bays

1x 2.5" disk bay

Expansion Slots

Two M.2 slots (one for WLAN, one for SSD)

EOU

(Optional) toolless chassis open (toolless chassis screw required) and toolless M.2 SSD, HDD, memory assembly / removal

Stand

- Vertical stand
- No stand

Mounting

- VESA mount bracket kit, supports VESA mount 75mm and 100mm
- None

Others

- (Optional) Dust filter
- (Optional) Power adapter cage

CONNECTIVITY

Network

Onboard Ethernet

Gigabit Ethernet, Intel Ethernet Connection I219-V, 1x RJ45, supports Wake-on-LAN

Optional Ethernet

No optional Ethernet

WLAN + Bluetooth[®]**

- Realtek RTL8822CE, 802.11ac Dual Band 2x2 Wi-Fi[®] + Bluetooth 5.0, M.2 card
- Intel Wireless-AC 9462, 802.11ac Dual Band 1x1 Wi-Fi + Bluetooth 5.0, M.2 card
- Intel Wireless-AC 9560, 802.11ac Dual Band 2x2 Wi-Fi + Bluetooth 5.0, M.2 card
- Intel Wi-Fi 6 AX201, 802.11ax 2x2 Wi-Fi + Bluetooth 5.1, M.2 Card
- No WLAN and Bluetooth

Ports^[1]

Front Ports

- 1x USB 3.2 Gen 2 (Always On and fast charge)
- 1x USB-C 3.2 Gen 1
- 1x headphone / microphone combo jack (3.5mm)

Optional Front Ports

None

Rear Ports^[2]

- 3x USB 3.2 Gen 1
- 1x USB 3.2 Gen 2
- 1x HDMI
- 1x DisplayPort™
- 1x Ethernet (RJ-45)

Optional Rear Ports^{***}

- 2x USB 3.2 Gen 1 ports (share one USB 3.2 Gen 1 bandwidth, occupy optional port 1 and 2)
- 2x DisplayPort ports (occupy Optional port 1 and 2)
- Optional port 1 (one of VGA / 2nd DisplayPort / 2nd HDMI / serial / USB-C 3.2 Gen 1 with DisplayPort function)
- Optional port 2 (serial)

Notes:

1. The transfer speed of following ports will vary and, depending on many factors, such as the processing speed of the host device, file attributes and other factors related to system configuration and your operating environment, will be slower than theoretical speed.
USB 2.0: 480 Mbit/s;
USB 3.2 Gen 1 (SuperSpeed USB 5Gbps, formerly USB 3.0 / USB 3.1 Gen 1): 5 Gbit/s;
USB 3.2 Gen 2 (SuperSpeed USB 10Gbps, formerly USB 3.1 Gen 2): 10 Gbit/s;
USB 3.2 Gen 2x2 (SuperSpeed USB 20Gbps): 20 Gbit/s;
Thunderbolt™ 3: 40 Gbit/s;
FireWire 400: 400 Mbit/s;
FireWire 800: 800 Mbit/s
2. For video ports on discrete graphics, please see graphics section

Monitor Cable

Monitor Cable^{***}

- DP to dual DP dongle
- DP to DVI-D dongle
- DP to HDMI 1.4 dongle
- DP to VGA cable (1.5M)
- DP to VGA dongle
- HDMI to HDMI cable (1.5m)
- HDMI to VGA dongle
- No monitor cable

SECURITY & PRIVACY

Security

Security Chip

Discrete TPM 2.0, TCG certified

Physical Locks

Kensington® Security Slot

Chassis Intrusion Switch

Chassis intrusion switch

Fingerprint Reader

- Touch style fingerprint reader on mouse
- No fingerprint reader

BIOS Security

- Administrator password
- Power-on password
- Hard disk password
- Boot sequence control
- Boot without keyboard and mouse
- Smart USB protection (allows keyboard / mouse only, blocks all storage devices)
- Individual USB port disablement

MANAGEABILITY

System Management

System Management

None

SERVICE

Warranty

Base Warranty**

- 1-year depot service
- 1-year limited onsite service
- 3-year limited onsite service
- No base warranty

ENVIRONMENTAL

Operating Environment

Temperature

- Operating: 5°C (41°F) to 35°C (95°F)
- Storage: -40°C (-40°F) to 60°C (140°F)

Humidity

- Operating: 20% to 80%
- Storage: 10% to 90%

Altitude

- Operating: -15.2 m (-50 ft) to 3048 m (10,000 ft)
- Storage: -15.2 m (-50 ft) to 12192 m (40,000 ft)

CERTIFICATIONS

Green Certifications

Green Certifications

- (Optional) EPEAT™ Gold
- (Optional) EPEAT Silver

- ENERGY STAR® 8.0
- ErP Lot 3
- TCO Certified 8.0
- RoHS compliant

Other Certifications

Other Certifications

- (Optional) TÜV Rheinland® Low Noise
- (Optional) TÜV Rheinland Ultra Low Noise

Mil-Spec Test

MIL-STD-810H military test passed (Low Pressure [Altitude], High Temperature, Low Temperature, Temperature Shock, Humidity, Sand and Dust, Vibration, Shock, Fungus, Solar Radiation)

- Feature with ** means that only one offering listed under the feature is configured on selected models.
- Feature with *** means that one or more offerings listed under the feature could be configured on selected models.
- Lenovo reserves the right to change specifications or other product information without notice. Lenovo is not responsible for photographic or typographical errors. LENOVO PROVIDES THIS PUBLICATION “AS IS,” WITHOUT WARRANTY OF ANY KIND, EITHER EXPRESS OR IMPLIED, INCLUDING THE IMPLIED WARRANTIES OF MERCHANTABILITY OR FITNESS FOR A PARTICULAR PURPOSE. Some jurisdictions do not allow disclaimer of express or implied warranties in certain transactions, therefore this disclaimer may not apply to you.
- The specifications on this page may not be available in all regions, and may be changed or updated without notice.

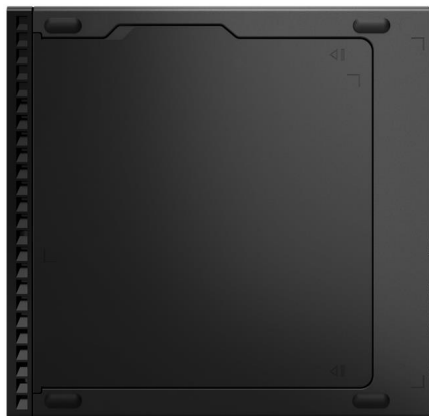

OVERVIEW

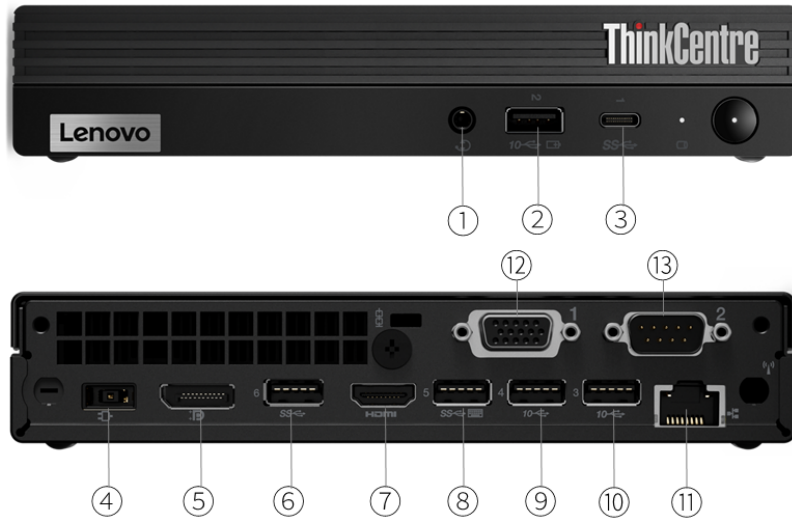

1. Headphone / microphone combo jack (3.5mm)	8. USB 3.2 Gen 1
2. USB 3.2 Gen 2	9. USB 3.2 Gen 2
3. USB-C 3.2 Gen 1	10. USB 3.2 Gen 2
4. Power connector	11. Ethernet (RJ-45)
5. DisplayPort	12. Optional port 1 (VGA is shown) *
6. USB 3.2 Gen 1	13. Optional port 2 (serial is shown) *
7. HDMI	

Notes:

- Ports with * are only available on selected models

PERFORMANCE

Processor

Processor Family

Intel® Celeron®, Intel Pentium®, 10th Generation Intel Core™ i3, or 11th Generation Intel Core i5 / i7 / i9 Processor

Processor**

Processor Name	Cores	Threads	Base Frequency	Max Frequency	Cache	Memory Support	Processor Graphics
Celeron G5905T	2	2	3.3GHz	-	4MB	DDR4-2666	Intel UHD Graphics 610
Pentium Gold G6405T	2	4	3.5GHz	-	4MB	DDR4-2666	Intel UHD Graphics 610
Pentium Gold G6505T	2	4	3.6GHz	-	4MB	DDR4-2666	Intel UHD Graphics 630
Core i3-10105T	4	8	3.0GHz	3.9GHz	6MB	DDR4-2666	Intel UHD Graphics 630
Core i3-10305T	4	8	3.0GHz	4.0GHz	8MB	DDR4-2666	Intel UHD Graphics 630
Core i5-11400T	6	12	1.3GHz	3.7GHz	12MB	DDR4-3200	Intel UHD Graphics 730
Core i5-11500T	6	12	1.5GHz	3.9GHz	12MB	DDR4-3200	Intel UHD Graphics 750
Core i5-11600T	6	12	1.7GHz	4.1GHz	12MB	DDR4-3200	Intel UHD Graphics 750
Core i7-11700T	8	16	1.4GHz	4.6GHz	16MB	DDR4-3200	Intel UHD Graphics 750
Core i9-11900T	8	16	1.5GHz	4.9GHz	16MB	DDR4-3200	Intel UHD Graphics 750

Operating System

Operating System**

- Windows® 10 Pro 64
- Windows 10 Home 64
- Windows 10 IoT Enterprise
- Windows 11 Pro 64
- Windows 11 Home 64
- Windows 11 DG Windows 10 Pro 64
- Ubuntu Linux
- No operating system

Graphics

Graphics**[1]

Graphics	Type	Memory	Connector	Max Resolution	Key Features
Intel UHD graphics 610	Integrated	Shared	1x HDMI®, 1x DP, 1x optional video port (2nd HDMI / VGA / 2nd DP / USB-C / dual DP)	4096x2160@24Hz(onboard HDMI), 4096x2304@60Hz(DP), 3840x2160@60Hz(Dual DP, MST mode), 2048x1536@50Hz(VGA), 4096x2304@60Hz(USB-C)	DirectX® 12
Intel UHD graphics 630	Integrated	Shared	1x HDMI, 1x DP, 1x optional video port (2nd HDMI / VGA / 2nd DP / USB-C / dual DP)	4096x2160@24Hz(onboard HDMI), 4096x2304@60Hz(DP), 3840x2160@60Hz(Dual DP, MST mode), 2048x1536@50Hz(VGA), 4096x2304@60Hz(USB-C)	DirectX 12
Intel UHD Graphics 730	Integrated	Shared	1x HDMI, 1x DP, 1x optional video port (2nd HDMI / VGA / 2nd DP /	4096x2160@24Hz(onboard HDMI), 4096x2304@60Hz(DP), 3840x2160@60Hz(Dual DP, MST mode), 2048x1536@50Hz(VGA),	DirectX 12

ThinkCentre M70q Gen 2

			USB-C / dual DP)	4096x2304@60Hz(USB-C)	
Intel UHD Graphics 750	Integrated	Shared	1x HDMI, 1x DP, 1x optional video port (2nd HDMI / VGA / 2nd DP / USB-C / dual DP)	4096x2160@24Hz(onboard HDMI), 4096x2304@60Hz(DP), 3840x2160@60Hz(Dual DP, MST mode), 2048x1536@50Hz(VGA), 4096x2304@60Hz(USB-C)	DirectX 12

Notes:

- The information of integrated graphics are not applicable for the models without integrated graphics (for the details, please refer to processor section)

Monitor Support

Monitor Support

Supports up to 3 independent displays via (onboard DP, onboard HDMI, and one optional port [VGA / 2nd DP / 2nd HDMI / USB-C]) or (one onboard port [DP / HDMI] and optional dual DP [MST mode])

Chipset

Chipset

Intel B560 chipset

Memory

Max Memory^[1]

Up to 64GB DDR4-2933

Memory Slots

Two DDR4 SO-DIMM slots, dual-channel capable

Memory Type**

- DDR4-2666
- DDR4-2933
- DDR4-3200

Notes:

- The max memory is based on the test results with current Lenovo® memory offerings. The system may support more memory as the technology develops.

Storage

Storage Support

Up to two drives, 1x 2.5" HDD + 1x M.2 SSD

- 2.5" HDD up to 1TB
- M.2 SSD up to 2TB

Storage Type***

Disk Type	Interface	RPM	Security
2.5" SATA HDD	SATA 6Gb/s	7.2K	-
M.2 2242 SSD	PCIe NVMe	-	-
M.2 2280 SSD	PCIe NVMe	-	Opal

RAID

No support

Removable Storage

Optical**

- DVD-ROM, slim (9.0mm), via USB external ODD box
- DVD burner (DVD±RW), slim (9.0mm), via USB external ODD box
- None

Card Reader

No card reader

Multi-Media

ThinkCentre M70q Gen 2

Audio Chip

High Definition (HD) Audio, Realtek® ALC233VB codec

Speakers

Single speaker, 1.5W x1

Power Supply

Power Supply**

Power	Type	Efficiency	Key Features
65W	Adapter	89%	Autosensing
135W	Adapter	89%	Autosensing
No power supply	-	-	-

DESIGN

Input Device

Keyboard**

- Lenovo Calliope Keyboard (USB connector), black
- Lenovo Calliope Wireless Keyboard, black
- Lenovo Traditional Keyboard (USB connector), black
- No keyboard

Mouse**

- Lenovo Calliope Mouse (USB connector), black
- Lenovo Calliope Wireless Mouse (2.4GHz via USB receiver), black
- Lenovo Fingerprint Mouse (USB connector), black
- No mouse

Mechanical

Form Factor

Tiny (1L)

Dimensions (WxDxH)

Models	Dimensions
Tiny only	179 x 182.9 x 36.5 mm with rubber feet (7.05 x 7.2 x 1.44 inches with rubber feet)

Weight

Models	Weight
Tiny only	1.25 kg (2.76 lbs)
With VESA mount & ODD box	1.74 kg (3.84 lbs)

Case Color

Black

Bays

1x 2.5" disk bay

Expansion Slots

Two M.2 slots (one for WLAN, one for SSD)

EOU

(Optional) toolless chassis open (toolless chassis screw required) and toolless M.2 SSD, HDD, memory assembly / removal

Stand

- Vertical stand
- No stand

IO Box

No IO box

Mounting

ThinkCentre M70q Gen 2

- VESA mount bracket kit, supports VESA mount 75mm and 100mm
- None

Others

- (Optional) Dust filter
- (Optional) Power adapter cage

CONNECTIVITY

Network

Onboard Ethernet

Gigabit Ethernet, Intel Ethernet Connection I219-V, 1x RJ45, supports Wake-on-LAN

Optional Ethernet

No optional Ethernet

WLAN + Bluetooth^{®**}

- Realtek RTL8822CE, 802.11ac Dual Band 2x2 Wi-Fi[®] + Bluetooth 5.0, M.2 card
- Intel Wireless-AC 9560, 802.11ac Dual Band 2x2 Wi-Fi + Bluetooth 5.0, M.2 card
- Intel Wireless-AC 9560, 802.11ac Dual Band 2x2 Wi-Fi + Bluetooth 5.1, M.2 card
- Intel Wi-Fi 6 AX201, 802.11ax 2x2 Wi-Fi + Bluetooth 5.2, M.2 Card
- No WLAN and Bluetooth

Ports^[1]

Front Ports

- 1x USB 3.2 Gen 2 (Always On and fast charge)
- 1x USB-C 3.2 Gen 1
- 1x headphone / microphone combo jack (3.5mm)

Optional Front Ports

None

Rear Ports^[2]

- 2x USB 3.2 Gen 1
- 2x USB 3.2 Gen 2
- 1x HDMI
- 1x DisplayPort[™]
- 1x Ethernet (RJ-45)

Optional Rear Ports^{***}

- 2x USB 3.2 Gen 1 ports (share one USB 3.2 Gen 1 bandwidth, occupy optional port 1 and 2)
- 2x DisplayPort ports (occupy Optional port 1 and 2)
- Optional port 1 (one of VGA / 2nd DisplayPort / 2nd HDMI / serial / USB-C 2.0 with DisplayPort function)
- Optional port 2 (serial)

Notes:

1. The transfer speed of following ports will vary and, depending on many factors, such as the processing speed of the host device, file attributes and other factors related to system configuration and your operating environment, will be slower than theoretical speed.
USB 2.0: 480 Mbit/s;
USB 3.2 Gen 1 (SuperSpeed USB 5Gbps, formerly USB 3.0 / USB 3.1 Gen 1): 5 Gbit/s;
USB 3.2 Gen 2 (SuperSpeed USB 10Gbps, formerly USB 3.1 Gen 2): 10 Gbit/s;
USB 3.2 Gen 2x2 (SuperSpeed USB 20Gbps): 20 Gbit/s;
Thunderbolt[™] 3: 40 Gbit/s;
FireWire 400: 400 Mbit/s;
FireWire 800: 800 Mbit/s
2. For video ports on discrete graphics, please see graphics section

Monitor Cable

Monitor Cable^{***}

- DP to dual DP dongle
- DP to DVI-D dongle
- DP to HDMI 1.4 dongle
- DP to VGA cable (1.5M)
- DP to VGA dongle
- HDMI to HDMI cable (1.5m)

- HDMI to VGA dongle
- No monitor cable

SECURITY & PRIVACY

Security

Security Chip

Discrete TPM 2.0, TCG certified

Physical Locks

Kensington® Security Slot

Chassis Intrusion Switch

Chassis intrusion switch

Fingerprint Reader

- Touch style fingerprint reader on mouse
- No fingerprint reader

BIOS Security

- Administrator password
- Power-on password
- Hard disk password
- Boot sequence control
- Boot without keyboard and mouse
- Smart USB protection (allows keyboard / mouse only, blocks all storage devices)
- Individual USB port disablement

MANAGEABILITY

System Management

System Management

None

SERVICE

Warranty

Base Warranty**

- 1-year depot service
- 1-year limited onsite service
- 3-year limited onsite service
- No base warranty

ENVIRONMENTAL

Operating Environment

Temperature

- Operating: 5°C (41°F) to 35°C (95°F)
- Storage: -40°C (-40°F) to 60°C (140°F)

Humidity

- Operating: 20% to 80%
- Storage: 10% to 90%

Altitude

- Operating: -15.2 m (-50 ft) to 3048 m (10,000 ft)
- Storage: -15.2 m (-50 ft) to 12192 m (40,000 ft)

CERTIFICATIONS

Green Certifications

Green Certifications

- EPEAT™ Gold
- ENERGY STAR® 8.0
- RoHS compliant

Other Certifications

Other Certifications

(Optional) TÜV Rheinland® Ultra Low Noise

Mil-Spec Test

MIL-STD-810H military test passed

- Feature with ** means that only one offering listed under the feature is configured on selected models.
- Feature with *** means that one or more offerings listed under the feature could be configured on selected models.
- Lenovo reserves the right to change specifications or other product information without notice. Lenovo is not responsible for photographic or typographical errors. LENOVO PROVIDES THIS PUBLICATION “AS IS,” WITHOUT WARRANTY OF ANY KIND, EITHER EXPRESS OR IMPLIED, INCLUDING THE IMPLIED WARRANTIES OF MERCHANTABILITY OR FITNESS FOR A PARTICULAR PURPOSE. Some jurisdictions do not allow disclaimer of express or implied warranties in certain transactions, therefore this disclaimer may not apply to you.
- The specifications on this page may not be available in all regions, and may be changed or updated without notice.



intel



intel



intel

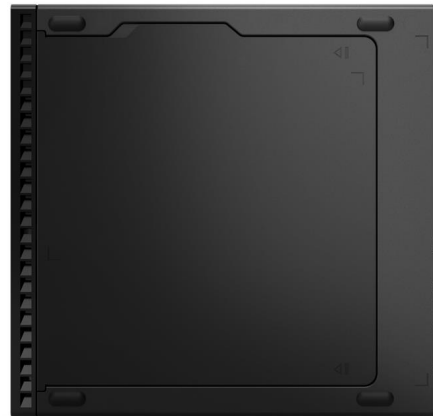

intel

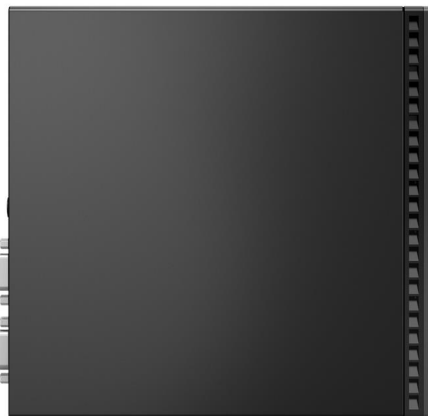

intel



intel

OVERVIEW

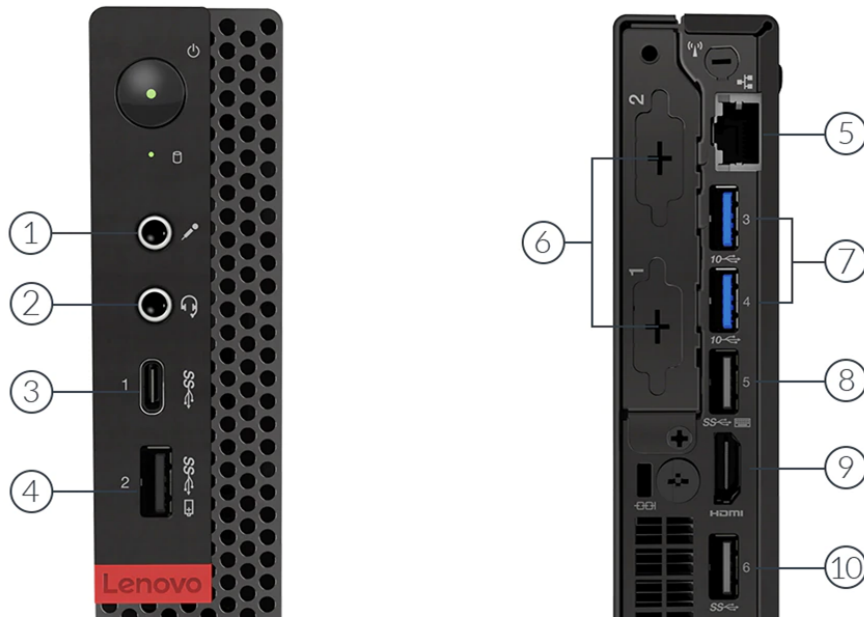

1. Microphone (3.5mm)	6. Optional port 1 and 2 *
2. Headphone / microphone combo jack (3.5mm)	7. 2x USB 3.1 Gen 2
3. USB-C 3.1 Gen 1	8. USB 3.1 Gen 1
4. USB 3.1 Gen 1	9. HDMI
5. Ethernet (RJ-45)	10. USB 3.1 Gen 1

Notes:

- Ports with * are only available on selected models

PERFORMANCE

Processor

Processor Family

Intel® Celeron®, Intel Pentium®, 8th Generation Intel Core™ i3 / i5 / i7, or 9th Generation Intel Core i3 / i5 / i7 / i9 Processor

Processor**

Processor Name	Cores	Threads	Base Frequency	Max Frequency	Cache	Memory Support	Processor Graphics
Celeron G4900T	2	2	2.9GHz	-	2MB	DDR4-2400	Intel UHD Graphics 610
Celeron G4930T	2	2	3.0GHz	-	2MB	DDR4-2400	Intel UHD Graphics 610
Pentium Gold G5400T	2	4	3.1GHz	-	4MB	DDR4-2400	Intel UHD Graphics 610
Pentium Gold G5420T	2	4	3.2GHz	-	4MB	DDR4-2400	Intel UHD Graphics 610
Pentium Gold G5500T	2	4	3.2GHz	-	4MB	DDR4-2400	Intel UHD Graphics 630
Pentium Gold G5600T	2	4	3.3GHz	-	4MB	DDR4-2400	Intel UHD Graphics 630
Core i3-8100T	4	4	3.1GHz	-	6MB	DDR4-2400	Intel UHD Graphics 630
Core i3-8300T	4	4	3.2GHz	-	8MB	DDR4-2400	Intel UHD Graphics 630
Core i3-9100T	4	4	3.1GHz	3.7GHz	6MB	DDR4-2400	Intel UHD Graphics 630
Core i3-9300T	4	4	3.2GHz	3.8GHz	8MB	DDR4-2400	Intel UHD Graphics 630
Core i5-8400T	6	6	1.7GHz	3.3GHz	9MB	DDR4-2666	Intel UHD Graphics 630
Core i5-8500T	6	6	2.1GHz	3.5GHz	9MB	DDR4-2666	Intel UHD Graphics 630
Core i5-8600T	6	6	2.3GHz	3.7GHz	9MB	DDR4-2666	Intel UHD Graphics 630
Core i5-9400T	6	6	1.8GHz	3.4GHz	9MB	DDR4-2666	Intel UHD Graphics 630
Core i5-9500T	6	6	2.2GHz	3.7GHz	9MB	DDR4-2666	Intel UHD Graphics 630
Core i5-9600T	6	6	2.3GHz	3.9GHz	9MB	DDR4-2666	Intel UHD Graphics 630
Core i7-8700T	6	12	2.4GHz	4.0GHz	12MB	DDR4-2666	Intel UHD Graphics 630
Core i7-9700T	8	8	2.0GHz	4.3GHz	12MB	DDR4-2666	Intel UHD Graphics 630
Core i9-9900T	8	16	2.1GHz	4.4GHz	16MB	DDR4-2666	Intel UHD Graphics 630

Operating System

Operating System**

- Windows® 10 Pro 64
- Windows 10 Home 64
- Windows 10 IoT Enterprise
- Ubuntu Linux
- No operating system

Graphics

Graphics[]**

Graphics	Type	Memory	Connector	Max Resolution	Key Features
Intel UHD graphics 610	Integrated	Shared	1x HDMI®, 1x DP, 1x optional video port (2nd HDMI / VGA / 2nd DP / USB-C)	4096x2160@24Hz(onboard HDMI), 4096x2304@60Hz(DP), 2048x1536@50Hz(VGA), 4096x2304@60Hz(USB-C)	DirectX® 12
Intel UHD graphics 630	Integrated	Shared	1x HDMI, 1x DP, 1x optional video port (2nd HDMI / VGA / 2nd DP / USB-C)	4096x2160@24Hz(onboard HDMI), 4096x2304@60Hz(DP), 2048x1536@50Hz(VGA), 4096x2304@60Hz(USB-C)	DirectX 12

Notes:

1. The information of integrated graphics are not applicable for the models without integrated graphics (for the details, please refer to processor section)

Monitor Support

Monitor Support

Supports up to 3 independent displays via onboard ports (DisplayPort™ + HDMI + 1x optional port [VGA / 2nd DP / 2nd HDMI / USB-C])

Chipset

Chipset

Intel B360 chipset

Memory

Max Memory[]

Up to 32GB DDR4-2666

Memory Slots

Two DDR4 SO-DIMM slots, dual-channel capable

Memory Type

DDR4-2666

Notes:

1. The max memory is based on the test results with current Lenovo® memory offerings. The system may support more memory as the technology develops.

Storage

Storage Support

Up to two drives, 1x 2.5" HDD/SSD + 1x M.2 SSD

- 2.5" HDD up to 1TB
- 2.5" SSD up to 256GB
- M.2 SSD up to 1TB
- Optional Intel Optane™ Memory, M.2

Storage Type***

Disk Type	Interface	RPM	Security
2.5" SATA HDD	SATA 6Gb/s	5.4K	-
2.5" SATA HDD	SATA 6Gb/s	7.2K	-
2.5" SATA SSD	SATA 6Gb/s	-	Opal
2.5" SATA SSD	SATA 6Gb/s	-	-
M.2 2242 SSD	PCIe NVMe, PCIe 3.0 x2	-	-
M.2 2280 SSD	PCIe NVMe, PCIe 3.0 x4	-	Opal
M.2 2280 SSD	PCIe NVMe, PCIe 3.0 x4	-	-

ThinkCentre M720 Tiny

Intel Optane Memory M10	PCIe NVMe, PCIe 3.0 x2	-	-
-------------------------	------------------------	---	---

RAID

No support

Removable Storage

Optical**

- DVD-ROM, slim (9.0mm), via USB external ODD box
- DVD burner (DVD±RW), slim (9.0mm), via USB external ODD box
- None

Card Reader

No card reader

Multi-Media

Audio Chip

High Definition (HD) Audio, Realtek® ALC233VB2 codec

Speakers**

- Single speaker, 1.5W x1
- Single speaker, 2W x1

Power Supply

Power Supply**

Power	Type	Efficiency	Key Features
65W	Adapter	88%	Autosensing
90W	Adapter	88%	Autosensing
135W	Adapter	88%	Autosensing
135W	Adapter	89%	Autosensing
No power supply	-	-	-

DESIGN

Input Device

Keyboard**

- Lenovo Calliope Keyboard (USB connector), black
- Lenovo Calliope Wireless Keyboard (2.4GHz via USB receiver), black
- Lenovo Traditional Keyboard (USB connector), black
- No keyboard

Mouse**

- Lenovo Calliope Mouse (USB connector), black
- Lenovo Calliope Wireless Mouse (2.4GHz via USB receiver), black
- Lenovo Fingerprint Mouse (USB connector), Windows Hello support, black
- No mouse

Mechanical

Form Factor

Tiny (1L)

Dimensions (WxDxH)

Models	Dimensions
Tiny only	179 x 183 x 34.5 / 37 mm with rubber feet (7.05 x 7.2 x 1.36 / 1.5 inches with rubber feet)
With VESA mount & ODD box	188.4 x 185.38 x 63 mm (7.42 x 7.30 x 2.48 inches)

Weight

Models	Weight
--------	--------

Tiny only	1.32 kg (2.91 lbs)
With VESA mount & ODD box	1.66 kg (3.66 lbs)

Case Color

Black

Bays

1x 2.5" disk bay

Expansion Slots^[1]

- One PCIe 3.0 x8, low-profile
- Two M.2 slots (one for WLAN, one for SSD)

EOU

(Optional) toolless chassis open (toolless chassis screw required) and toolless M.2 SSD, HDD, memory assembly / removal

Stand

- Vertical stand
- No stand

Mounting

- VESA mount bracket kit, supports VESA mount 75mm and 100mm
- None

Others

- (Optional) Dust filter
- (Optional) Power adapter cage

Notes:

1. 2.5" HDD/SSD and PCIe card are mutually exclusive

CONNECTIVITY**Network****Onboard Ethernet**

Gigabit Ethernet, Intel Ethernet Connection I219-V, 1x RJ45, supports Wake-on-LAN

Optional Ethernet

- Gigabit Ethernet, Intel Ethernet Server Adapter I350-T4, 4x RJ-45, PCIe x4
- No optional Ethernet

WLAN + Bluetooth^{®}**

- Realtek RTL8821CE, 802.11ac Dual Band 1x1 Wi-Fi[®] + Bluetooth 4.2, M.2 card
- Realtek RTL8822BE, 802.11ac Dual Band 2x2 Wi-Fi + Bluetooth 4.2, M.2 card
- Intel Dual Band Wireless-AC 3165, 802.11ac Dual Band 1x1 Wi-Fi + Bluetooth 4.2, M.2 Card
- Intel Dual Band Wireless-AC 8265, 802.11ac Dual Band 2x2 Wi-Fi + Bluetooth 4.2, M.2 Card
- No WLAN and Bluetooth

Ports^[1]**Front Ports**

- 1x USB 3.1 Gen 1 (Always On and fast charge)
- 1x USB-C 3.1 Gen 1
- 1x headphone / microphone combo jack (3.5mm)
- 1x microphone (3.5mm)

Optional Front Ports

None

Rear Ports^[2]

- 2x USB 3.1 Gen 1
- 2x USB 3.1 Gen 2
- 1x HDMI
- 1x DisplayPort
- 1x Ethernet (RJ-45)

Optional Rear Ports^{*}**

ThinkCentre M720 Tiny

- 2x USB 3.1 Gen 1 (via 2-port USB expansion card, PCIe x1)
- Optional port 1 (one of VGA / 2nd DisplayPort / 2nd HDMI / serial / USB-C 3.1 Gen 1 with DisplayPort function)
- Optional port 2 (serial)
- 4x serial (via 4-port serial expansion card, PCIe x1)
- 1x parallel
- 2x PS/2 (USB to 2x PS/2 dongle)

Notes:

1. The transfer speed of following ports will vary and, depending on many factors, such as the processing speed of the host device, file attributes and other factors related to system configuration and your operating environment, will be slower than theoretical speed.
USB 2.0: 480 Mbit/s;
USB 3.2 Gen 1 (SuperSpeed USB 5Gbps, formerly USB 3.0 / USB 3.1 Gen 1): 5 Gbit/s;
USB 3.2 Gen 2 (SuperSpeed USB 10Gbps, formerly USB 3.1 Gen 2): 10 Gbit/s;
USB 3.2 Gen 2x2 (SuperSpeed USB 20Gbps): 20 Gbit/s;
Thunderbolt™ 3: 40 Gbit/s;
FireWire 400: 400 Mbit/s;
FireWire 800: 800 Mbit/s
2. For video ports on discrete graphics, please see graphics section

Monitor Cable

Monitor Cable***

- VGA Cable Tiny
- DP to dual DP dongle
- DP to DVI-D dongle
- DP to HDMI 1.4 dongle
- DP to VGA cable (1.5M)
- DP to VGA dongle
- HDMI to VGA dongle
- No monitor cable

SECURITY & PRIVACY

Security

Security Chip

Discrete TPM 2.0, TCG certified

Physical Locks

Kensington® Security Slot

Chassis Intrusion Switch

- Chassis intrusion switch
- No chassis intrusion switch

Fingerprint Reader

- Touch style fingerprint reader on mouse
- No fingerprint reader

BIOS Security

- Administrator password
- Power-on password
- Hard disk password
- Boot sequence control
- Boot without keyboard and mouse
- Smart USB protection (allows keyboard / mouse only, blocks all storage devices)
- Individual USB port disablement

MANAGEABILITY

System Management

System Management

None

SERVICE

Warranty

Base Warranty**

- 1-year depot service
- 1-year limited onsite service
- 3-year depot service
- 3-year limited onsite service
- 3-year split limited onsite service
- No base warranty

ENVIRONMENTAL

Operating Environment

Temperature

- Operating: 5°C (41°F) to 35°C (95°F)
- Storage: -40°C (-40°F) to 60°C (140°F)

Humidity

- Operating: 20% to 80%
- Storage: 10% to 90%

Altitude

- Operating: -15.2 m (-50 ft) to 3048 m (10,000 ft)
- Storage: -15.2 m (-50 ft) to 12192 m (40,000 ft)

CERTIFICATIONS

Green Certifications

Green Certifications

- EPEAT™ Gold
- EPEAT Silver
- ENERGY STAR® 8.0
- ErP Lot 3
- TCO
- RoHS compliant

Other Certifications

Other Certifications

(Optional) TÜV Rheinland® Ultra Low Noise

Mil-Spec Test

MIL-STD-810G military test passed (Low Pressure [Altitude], High Temperature, Low Temperature, Temperature Shock, Humidity, Sand and Dust, Vibration, Shock, Fungus, Solar Radiation)

- Feature with ** means that only one offering listed under the feature is configured on selected models.
- Feature with *** means that one or more offerings listed under the feature could be configured on selected models.
- Lenovo reserves the right to change specifications or other product information without notice. Lenovo is not responsible for photographic or typographical errors. LENOVO PROVIDES THIS PUBLICATION "AS IS," WITHOUT WARRANTY OF ANY KIND, EITHER EXPRESS OR IMPLIED, INCLUDING THE IMPLIED WARRANTIES OF MERCHANTABILITY OR FITNESS FOR A PARTICULAR PURPOSE. Some jurisdictions do not allow disclaimer of express or implied warranties in certain transactions, therefore this disclaimer may not apply to you.

- The specifications on this page may not be available in all regions, and may be changed or updated without notice.



OVERVIEW

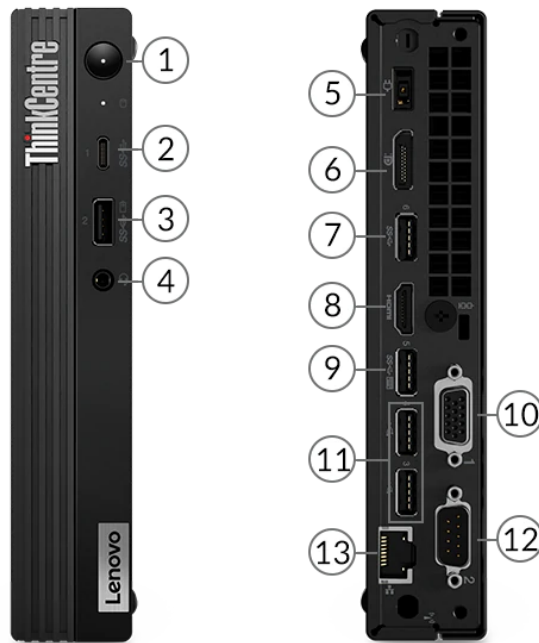

1. Power button	8. HDMI
2. USB-C 3.2 Gen 1	9. USB 3.2 Gen 1
3. USB 3.2 Gen 2	10. Optional port 1 (VGA is shown)
4. Headphone / microphone combo jack (3.5mm)	11. 2x USB 2.0
5. Power connector	12. Optional port 2 (serial is shown)
6. DisplayPort	13. Ethernet (RJ-45)
7. USB 3.2 Gen 1	

PERFORMANCE

Processor

Processor Family

AMD Athlon™ or AMD Ryzen™ 3 / 5 / 7 Processor

Processor**

Processor Name	Cores	Threads	Base Frequency	Max Frequency	Cache	Memory Support	Processor Graphics
AMD Athlon Silver 3050GE	2	4	3.4GHz	3.4GHz	1MB L2 / 4MB L3	DDR4-2666	AMD Radeon™ Graphics
AMD Athlon Silver PRO 3125GE	2	4	3.4GHz	3.4GHz	1MB L2 / 4MB L3	DDR4-2666	AMD Radeon Graphics
AMD Athlon Gold PRO 3150GE	4	4	3.3GHz	3.8GHz	2MB L2 / 4MB L3	DDR4-2933	AMD Radeon Graphics
AMD Ryzen 3 3200GE	4	4	3.3GHz	3.8GHz	2MB L2 / 4MB L3	DDR4-2933	AMD Radeon Vega 8 Graphics
AMD Ryzen 3 4300GE	4	8	3.5GHz	4.0GHz	2MB L2 / 4MB L3	DDR4-3200	AMD Radeon Graphics
AMD Ryzen 3 5300GE	4	8	3.6GHz	4.2GHz	2MB L2 / 8MB L3	DDR4-3200	AMD Radeon Graphics
AMD Ryzen 3 PRO 4350GE	4	8	3.5GHz	4.0GHz	2MB L2 / 4MB L3	DDR4-3200	AMD Radeon Graphics
AMD Ryzen 3 PRO 5350GE	4	8	3.6GHz	4.2GHz	2MB L2 / 8MB L3	DDR4-3200	AMD Radeon Graphics
AMD Ryzen 5 4600GE	6	12	3.3GHz	4.2GHz	3MB L2 / 8MB L3	DDR4-3200	AMD Radeon Graphics
AMD Ryzen 5 5600GE	6	12	3.4GHz	4.4GHz	3MB L2 / 16MB L3	DDR4-3200	AMD Radeon Graphics
AMD Ryzen 5 PRO 3350GE	4	8	3.3GHz	3.9GHz	2MB L2 / 4MB L3	DDR4-2933	AMD Radeon Vega 11 Graphics
AMD Ryzen 5 PRO 4650GE	6	12	3.3GHz	4.2GHz	3MB L2 / 8MB L3	DDR4-3200	AMD Radeon Graphics
AMD Ryzen 5 PRO 5650GE	6	12	3.4GHz	4.4GHz	3MB L2 / 16MB L3	DDR4-3200	AMD Radeon Graphics
AMD Ryzen 7 4700GE	8	16	3.1GHz	4.3GHz	4MB L2 / 8MB L3	DDR4-3200	AMD Radeon Graphics
AMD Ryzen 7 5700GE	8	16	3.2GHz	4.6GHz	4MB L2 / 16MB L3	DDR4-3200	AMD Radeon Graphics
AMD Ryzen 7 PRO 4750GE	8	16	3.1GHz	4.3GHz	4MB L2 / 8MB L3	DDR4-3200	AMD Radeon Graphics
AMD Ryzen 7 PRO 5750GE	8	16	3.2GHz	4.6GHz	4MB L2 / 16MB L3	DDR4-3200	AMD Radeon Graphics

Operating System

Operating System**

- Windows® 10 Pro 64
- Windows 10 Home 64
- Windows 10 IoT Enterprise
- Ubuntu Linux
- No operating system

Graphics

Graphics**[1]

Graphics	Type	Memory	Connector	Max Resolution	Key Features
AMD Radeon Vega 8 Graphics	Integrated	Shared	1x HDMI®, 1x DisplayPort™, 1x optional port (VGA / 2nd DP / USB-C / 2nd HDMI / dual DP)	3840x2160@30Hz or 2560x1440@60Hz(HDMI), 1920x1200@60Hz(VGA), 3840x2160(DP)@60Hz	DirectX® 12
AMD Radeon Vega 11 Graphics	Integrated	Shared	1x HDMI, 1x DisplayPort, 1x optional port (VGA / 2nd DP / USB-C / 2nd HDMI / dual DP)	3840x2160@30Hz or 2560x1440@60Hz(HDMI), 1920x1200@60Hz(VGA), 3840x2160(DP)@60Hz	DirectX 12
AMD Radeon Graphics	Integrated	Shared	1x HDMI, 1x DisplayPort, 1x optional port (VGA / 2nd DP / USB-C / 2nd HDMI / dual DP)	3840x2160@30Hz or 2560x1440@60Hz(HDMI), 1920x1200@60Hz(VGA), 3840x2160(DP)@60Hz	DirectX 12

Notes:

- The information of integrated graphics are not applicable for the models without integrated graphics (for the details, please refer to processor section)

Monitor Support

Monitor Support

Supports up to 3 independent displays via onboard ports (DisplayPort + HDMI) and optional ports (VGA / 2nd DP / 2nd HDMI / USB-C / 2x DP)

Chipset

Chipset

AMD PRO 500 chipset

Memory

Max Memory^[1]

Up to 64GB DDR4-3200

Memory Slots

Two DDR4 SO-DIMM slots, dual-channel capable

Memory Type^[2]

DDR4-3200

Notes:

- The max memory is based on the test results with current Lenovo® memory offerings. The system may support more memory as the technology develops.
- Installed memory is actually 3200MHz, but may run at 2666MHz, 2933MHz or 3200MHz depending on the memory support capability of processor

Storage

Storage Support

Up to two drives, 1x 2.5" HDD + 1x M.2 SSD

- 2.5" HDD up to 1TB
- M.2 SSD up to 1TB

Storage Type^{***}

Disk Type	Interface	RPM	Security
2.5" SATA HDD	SATA 6Gb/s	5.4K	-
2.5" SATA HDD	SATA 6Gb/s	7.2K	-
M.2 2242 SSD	PCIe NVMe, PCIe 3.0 x2	-	-
M.2 2280 SSD	PCIe NVMe, PCIe 3.0 x4	-	Opal

Removable Storage

Optical

**

- DVD-ROM, slim (9.0mm), via USB external ODD box
- DVD burner (DVD±RW), slim (9.0mm), via USB external ODD box
- None

Multi-Media

Audio Chip

High Definition (HD) Audio, Realtek® ALC222 codec

Speakers

Single speaker, 1.5W x1

Power Supply

Power Supply**

Power	Type	Efficiency	Key Features
65W	Adapter	89%	Autosensing
90W	Adapter	89%	Autosensing

DESIGN

Input Device

Keyboard**

- Lenovo Calliope Keyboard (USB connector), black
- Lenovo Calliope Wireless Keyboard, black
- Lenovo Traditional Keyboard (USB connector), black
- No keyboard

Mouse**

- Lenovo Calliope Mouse (USB connector), black
- Lenovo Calliope Wireless Mouse (2.4GHz via USB receiver), black
- Lenovo Fingerprint Mouse (USB connector), Windows Hello support, black
- No mouse

Mechanical

Form Factor

Tiny (1L)

Dimensions (WxDxH)

Models	Dimensions
Tiny only	179 x 183 x 34.5 / 37 mm with rubber feet (7.05 x 7.2 x 1.36 / 1.5 inches with rubber feet)

Weight

Models	Weight
Tiny only	1.25 kg (2.76 lbs)

Case Color

Black

Bays

1x 2.5" disk bay

Expansion Slots

- One M.2 slot (for WLAN)
- One M.2 slot (for SSD)

EOU

(Optional) toolless chassis open (toolless chassis screw required) and toolless M.2 SSD, HDD, memory assembly / removal

Stand

- Vertical stand

ThinkCentre M75q Gen 2

- No stand

Mounting

- VESA mount bracket kit, supports VESA mount 75mm and 100mm
- None

CONNECTIVITY

Network

Onboard Ethernet

- Gigabit Ethernet, Realtek RTL8111HN, 1x RJ45, supports Wake-on-LAN
- Gigabit Ethernet, Realtek RTL8111FP, 1x RJ45, supports DASH and Wake-on-LAN

WLAN + Bluetooth[®]**

- Realtek RTL8852AE, Wi-Fi[®] 6, 802.11ax Dual Band 2x2 Wi-Fi + Bluetooth 5.2, M.2 card
- Realtek RTL8822CE, 802.11ac Dual Band 2x2 Wi-Fi + Bluetooth 5.0, M.2 card
- Intel[®] Wireless-AC 9260, 802.11ac Dual Band 2x2 Wi-Fi + Bluetooth 5.1, M.2 card
- Intel Wi-Fi 6 AX200, 802.11ax 2x2 Wi-Fi + Bluetooth 5.2, M.2 card
- No WLAN and Bluetooth

Ports^[1]

Front Ports

- 1x USB 3.2 Gen 2 (Always On and fast charge)
- 1x USB-C 3.2 Gen 1
- 1x headphone / microphone combo jack (3.5mm)

Rear Ports^[2]

- 2x USB 2.0
- 2x USB 3.2 Gen 1
- 1x HDMI
- 1x DisplayPort
- 1x Ethernet (RJ-45)

Optional Rear Ports^{***}

- 2x USB 3.2 Gen 1 (occupies port 1 and 2)
- 4x USB 3.2 Gen 1 ports (share one USB 3.2 Gen 1 bandwidth, occupy optional port 1 and 2)
- 2x DisplayPort (occupies port 1 and 2)
- Optional port 1 (one of VGA / 2nd DisplayPort / 2nd HDMI / serial / USB-C 3.2 Gen 1 with DisplayPort function)
- Optional port 2 (serial)
- 1x parallel

Notes:

1. The transfer speed of following ports will vary and, depending on many factors, such as the processing speed of the host device, file attributes and other factors related to system configuration and your operating environment, will be slower than theoretical speed.
 USB 2.0: 480 Mbit/s;
 USB 3.2 Gen 1 (SuperSpeed USB 5Gbps, formerly USB 3.0 / USB 3.1 Gen 1): 5 Gbit/s;
 USB 3.2 Gen 2 (SuperSpeed USB 10Gbps, formerly USB 3.1 Gen 2): 10 Gbit/s;
 USB 3.2 Gen 2x2 (SuperSpeed USB 20Gbps): 20 Gbit/s;
 Thunderbolt™ 3: 40 Gbit/s;
 FireWire 400: 400 Mbit/s;
 FireWire 800: 800 Mbit/s
2. For video ports on discrete graphics, please see graphics section

Monitor Cable

Monitor Cable^{***}

- VGA Cable Tiny
- DP to dual DP dongle
- DP to DVI-D dongle
- DP to HDMI 1.4 dongle
- DP to VGA cable (1.5M)
- DP to VGA dongle
- HDMI to HDMI cable (1.5m)
- HDMI to VGA dongle
- No monitor cable

SECURITY & PRIVACY

Security

Security Chip

Discrete TPM 2.0, TCG certified

Physical Locks

Kensington® Security Slot

Chassis Intrusion Switch

Chassis intrusion switch

BIOS Security

- Administrator password
- Power-on password
- Hard disk password
- Boot sequence control
- Boot without keyboard and mouse
- Individual USB port disablement

MANAGEABILITY

System Management

System Management

- DASH 1.2
- No DASH

SERVICE

Warranty

Base Warranty**

- 1-year depot service
- 1-year limited onsite service
- 3-year limited onsite service
- No base warranty

ENVIRONMENTAL

Operating Environment

Temperature

- Operating: 5°C (41°F) to 35°C (95°F)
- Storage: -40°C (-40°F) to 60°C (140°F)

Humidity

- Operating: 20% to 80%
- Storage: 10% to 90%

Altitude

- Operating: -15.2 m (-50 ft) to 3048 m (10,000 ft)
- Storage: -15.2 m (-50 ft) to 12192 m (40,000 ft)

CERTIFICATIONS

Green Certifications

Green Certifications

- (Optional) EPEAT™ Gold
- ENERGY STAR® 8.0
- ErP Lot 3
- TCO

- RoHS compliant

Other Certifications

Mil-Spec Test

MIL-STD-810H military test passed

- Feature with ** means that only one offering listed under the feature is configured on selected models.
- Feature with *** means that one or more offerings listed under the feature could be configured on selected models.
- Lenovo reserves the right to change specifications or other product information without notice. Lenovo is not responsible for photographic or typographical errors. LENOVO PROVIDES THIS PUBLICATION “AS IS,” WITHOUT WARRANTY OF ANY KIND, EITHER EXPRESS OR IMPLIED, INCLUDING THE IMPLIED WARRANTIES OF MERCHANTABILITY OR FITNESS FOR A PARTICULAR PURPOSE. Some jurisdictions do not allow disclaimer of express or implied warranties in certain transactions, therefore this disclaimer may not apply to you.
- The specifications on this page may not be available in all regions, and may be changed or updated without notice.



AMD



AMD



AMD

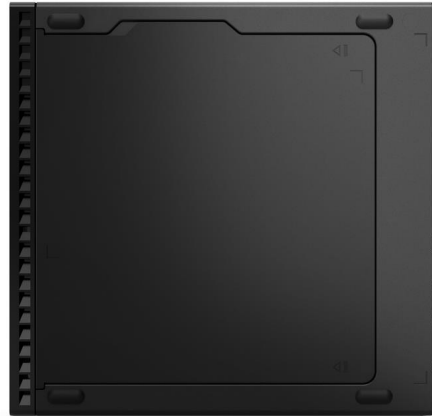

AMD



AMD



AMD

OVERVIEW

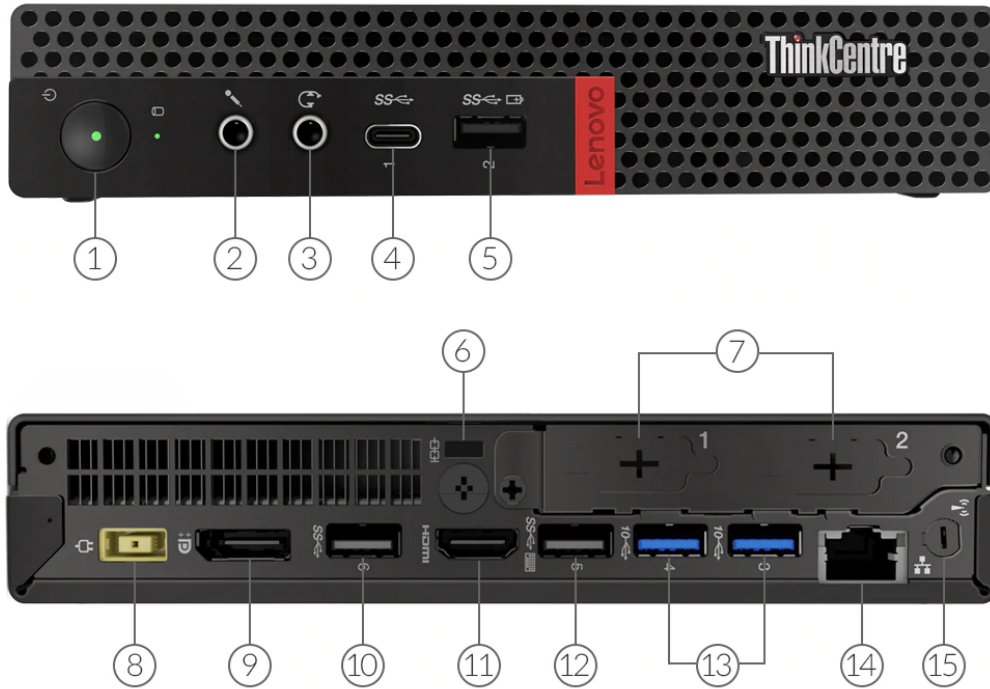

1. Power button	9. DisplayPort
2. Microphone (3.5mm)	10. USB 3.2 Gen 1
3. Headphone / microphone combo jack (3.5mm)	11. HDMI
4. USB-C 3.2 Gen 1	12. USB 2.0
5. USB 3.2 Gen 1	13. 2x USB 2.0
6. Kensington Security Slot	14. Ethernet (RJ-45)
7. Optional port 1 and 2 *	15. Wi-Fi antenna *
8. Power connector	

Notes:

- Ports with * are only available on selected models

PERFORMANCE

Processor

Processor Family

AMD Athlon™ or AMD Ryzen™ 3 / 5 Processor

Processor**

Processor Name	Cores	Threads	Base Frequency	Max Frequency	Cache	Memory Support	Processor Graphics
AMD Athlon 300GE	2	4	3.4GHz	-	1MB L2 / 4MB L3	DDR4-2666	AMD Radeon™ Vega 3 Graphics
AMD Athlon PRO 200GE	2	4	3.2GHz	-	1MB L2 / 4MB L3	DDR4-2666	AMD Radeon Vega 3 Graphics
AMD Athlon PRO 300GE	2	4	3.4GHz	-	1MB L2 / 4MB L3	DDR4-2666	AMD Radeon Vega 3 Graphics
AMD Ryzen 3 3200GE	4	4	3.3GHz	3.8GHz	2MB L2 / 4MB L3	DDR4-2933	AMD Radeon Vega 8 Graphics
AMD Ryzen 3 PRO 2200GE	4	4	3.2GHz	3.6GHz	2MB L2 / 4MB L3	DDR4-2933	AMD Radeon Vega 8 Graphics
AMD Ryzen 3 PRO 3200GE	4	4	3.3GHz	3.8GHz	2MB L2 / 4MB L3	DDR4-2933	AMD Radeon Vega 8 Graphics
AMD Ryzen 5 3350GE	4	8	3.3GHz	3.9GHz	2MB L2 / 4MB L3	DDR4-2933	AMD Radeon RX Vega 11 Graphics
AMD Ryzen 5 3400GE	4	8	3.3GHz	4.0GHz	2MB L2 / 4MB L3	DDR4-2933	AMD Radeon Vega 11 Graphics
AMD Ryzen 5 PRO 2400GE	4	8	3.2GHz	3.8GHz	2MB L2 / 4MB L3	DDR4-2933	AMD Radeon Vega 11 Graphics
AMD Ryzen 5 PRO 3350GE	4	8	3.3GHz	3.9GHz	2MB L2 / 4MB L3	DDR4-2933	AMD Radeon Vega 11 Graphics
AMD Ryzen 5 PRO 3400GE	4	8	3.3GHz	4.0GHz	2MB L2 / 4MB L3	DDR4-2933	AMD Radeon Vega 11 Graphics

Operating System

Operating System**

- Windows® 10 Pro 64
- Windows 10 Home 64
- Windows 10 IoT Enterprise
- Ubuntu Linux
- No operating system

Graphics

Graphics**[1]

Graphics	Type	Memory	Connector	Max Resolution	Key Features
AMD Radeon R5 Graphics	Integrated	Shared	1x HDMI®, 1x DisplayPort™, 1x optional port (VGA / 2nd DP / 2nd HDMI)	4096x2160@30Hz(HDMI), 1920x1200@60Hz(VGA), 4096x2160(DP)@60Hz	DirectX® 12
AMD Radeon R7 Graphics	Integrated	Shared	1x HDMI, 1x DisplayPort, 1x optional port (VGA / 2nd DP / 2nd HDMI)	4096x2160@30Hz(HDMI), 1920x1200@60Hz(VGA), 4096x2160(DP)@60Hz	DirectX 12
AMD Radeon Vega 3 Graphics	Integrated	Shared	1x HDMI, 1x DisplayPort, 1x optional port (VGA / 2nd DP / 2nd HDMI)	4096x2160@30Hz(HDMI), 1920x1200@60Hz(VGA), 4096x2160(DP)@60Hz	DirectX 12
AMD Radeon	Integrated	Shared	1x HDMI, 1x DisplayPort, 1x	4096x2160@30Hz(HDMI),	DirectX 12

Vega 8 Graphics			optional port (VGA / 2nd DP / 2nd HDMI)	1920x1200@60Hz(VGA), 4096x2160(DP)@60Hz	
AMD Radeon Vega 11 Graphics	Integrated	Shared	1x HDMI, 1x DisplayPort, 1x optional port (VGA / 2nd DP / 2nd HDMI)	4096x2160@30Hz(HDMI), 1920x1200@60Hz(VGA), 4096x2160(DP)@60Hz	DirectX 12
AMD Radeon RX Vega 11 Graphics	Integrated	Shared	1x HDMI, 1x DisplayPort, 1x optional port (VGA / 2nd DP / 2nd HDMI)	4096x2160@30Hz(HDMI), 1920x1200@60Hz(VGA), 4096x2160(DP)@60Hz	DirectX 12

Notes:

- The information of integrated graphics are not applicable for the models without integrated graphics (for the details, please refer to processor section)

Monitor Support

Monitor Support^[1]

Supports up to 3 independent displays via onboard ports (DisplayPort + HDMI + 1x optional port [VGA / 2nd DP / 2nd HDMI])

Notes:

- Supports maximum of 2 concurrent HDMI/DVI displays when using HDMI port or DP to DVI/HDMI dongles, and Athlon / Athlon PRO only support 2 display

Chipset

Chipset

AMD PRO 500 chipset

Memory

Max Memory^[1]

Up to 32GB DDR4-2666

Memory Slots

Two DDR4 SO-DIMM slots, dual-channel capable

Memory Type

DDR4-2666

Notes:

- The max memory is based on the test results with current Lenovo® memory offerings. The system may support more memory as the technology develops.

Storage

Storage Support

Up to two drives, 1x 2.5" HDD + 1x M.2 SSD

- 2.5" HDD up to 1TB
- M.2 SSD up to 1TB

Storage Type^{***}

Disk Type	Interface	RPM	Security
2.5" SATA HDD	SATA 6Gb/s	7.2K	-
M.2 2242 SSD	PCIe NVMe, PCIe 3.0 x2	-	-
M.2 2280 SSD	PCIe NVMe, PCIe 3.0 x4	-	Opal
M.2 2280 SSD	PCIe NVMe, PCIe 3.0 x4	-	-

RAID

No support

Removable Storage

Optical^{**}

- DVD-ROM, slim (9.0mm), via USB external ODD box

ThinkCentre M75q Tiny

- DVD burner (DVD±RW), slim (9.0mm), via USB external ODD box
- None

Card Reader

No card reader

Multi-Media

Audio Chip

High Definition (HD) Audio, Realtek® ALC222-CG codec

Speakers

Single speaker, 1.5W x1

Power Supply

Power Supply**

Power	Type	Efficiency	Key Features
65W	Adapter	88%	Autosensing
135W	Adapter	88%	Autosensing
135W	Adapter	89%	Autosensing
No power supply	-	-	-

DESIGN

Input Device

Keyboard**

- Lenovo Calliope Wireless Keyboard (2.4GHz via USB receiver), black
- Lenovo Traditional Keyboard (USB connector), black
- No keyboard

Mouse**

- Lenovo Calliope Mouse (USB connector), black
- Lenovo Calliope Wireless Mouse (2.4GHz via USB receiver), black
- Lenovo Fingerprint Mouse (USB connector), Windows Hello support, black
- No mouse

Mechanical

Form Factor

Tiny (1L)

Dimensions (WxDxH)

Models	Dimensions
Tiny only	179 x 183 x 34.5 / 37 mm with rubber feet (7.05 x 7.2 x 1.36 / 1.5 inches with rubber feet)
With VESA mount & ODD box	188.4 x 185.38 x 63 mm (7.42 x 7.30 x 2.48 inches)

Weight

Models	Weight
Tiny only	1.32 kg (2.91 lbs)
With VESA mount & ODD box	1.66 kg (3.66 lbs)

Case Color

Black

Bays

1x 2.5" disk bay

Expansion Slots

Two M.2 slots (one for WLAN, one for SSD)

EOU

(Optional) toolless chassis open (toolless chassis screw required) and toolless M.2 SSD, HDD, memory assembly / removal

Stand

- Vertical stand
- No stand

Mounting

- VESA mount bracket kit, supports VESA mount 75mm and 100mm
- None

Others

- (Optional) Dust filter
- (Optional) Power adapter cage

CONNECTIVITY

Network

Onboard Ethernet

Gigabit Ethernet, Realtek RTL8111EPV-CG, 1x RJ45, supports Wake-on-LAN

Optional Ethernet

No optional Ethernet

WLAN + Bluetooth^{}**

- Realtek RTL8822CE, 802.11ac Dual Band 2x2 Wi-Fi® + Bluetooth 5.0, M.2 card
- Qualcomm® QCA6174A, 802.11ac Dual Band 2x2 Wi-Fi + Bluetooth 4.2, M.2 card
- Intel® Wireless-AC 9260, 802.11ac Dual Band 2x2 Wi-Fi + Bluetooth 5.0, M.2 card
- No WLAN and Bluetooth

Ports^[1]

Front Ports

- 1x USB 3.2 Gen 1 (Always On and fast charge)
- 1x USB-C 3.2 Gen 1
- 1x headphone / microphone combo jack (3.5mm)
- 1x microphone (3.5mm)

Optional Front Ports

None

Rear Ports^[2]

- 3x USB 2.0
- 1x USB 3.2 Gen 1
- 1x HDMI
- 1x DisplayPort
- 1x Ethernet (RJ-45)

Optional Rear Ports^{*}**

- Optional port 1 (one of VGA / 2nd DisplayPort / 2nd HDMI / serial)
- Optional port 2 (serial)
- 1x parallel (external USB to parallel dongle)

Notes:

1. The transfer speed of following ports will vary and, depending on many factors, such as the processing speed of the host device, file attributes and other factors related to system configuration and your operating environment, will be slower than theoretical speed.
USB 2.0: 480 Mbit/s;
USB 3.2 Gen 1 (SuperSpeed USB 5Gbps, formerly USB 3.0 / USB 3.1 Gen 1): 5 Gbit/s;
USB 3.2 Gen 2 (SuperSpeed USB 10Gbps, formerly USB 3.1 Gen 2): 10 Gbit/s;
USB 3.2 Gen 2x2 (SuperSpeed USB 20Gbps): 20 Gbit/s;
Thunderbolt™ 3: 40 Gbit/s;
FireWire 400: 400 Mbit/s;
FireWire 800: 800 Mbit/s
2. For video ports on discrete graphics, please see graphics section

Monitor Cable

Monitor Cable^{*}**

- VGA Cable Tiny
- DP to dual DP dongle
- DP to DVI-D dongle
- DP to HDMI 1.4 dongle
- DP to VGA cable (1.5M)
- DP to VGA dongle
- HDMI to VGA dongle
- No monitor cable

SECURITY & PRIVACY

Security

Security Chip

Discrete TPM 2.0, TCG certified

Physical Locks

Kensington® Security Slot

Chassis Intrusion Switch

Chassis intrusion switch

Fingerprint Reader

- Touch style fingerprint reader on mouse
- No fingerprint reader

BIOS Security

- Administrator password
- Power-on password
- Hard disk password
- Boot sequence control
- Boot without keyboard and mouse
- Smart USB protection (allows keyboard / mouse only, blocks all storage devices)
- Individual USB port disablement

MANAGEABILITY

System Management

System Management

DASH 1.0 / 1.1

SERVICE

Warranty

Base Warranty**

- 1-year depot service
- 1-year limited onsite service
- 3-year limited onsite service
- No base warranty

ENVIRONMENTAL

Operating Environment

Temperature

- Operating: 5°C (41°F) to 35°C (95°F)
- Storage: -40°C (-40°F) to 60°C (140°F)

Humidity

- Operating: 20% to 80%
- Storage: 10% to 90%

Altitude

- Operating: -15.2 m (-50 ft) to 3048 m (10,000 ft)
- Storage: -15.2 m (-50 ft) to 12192 m (40,000 ft)

CERTIFICATIONS

Green Certifications

Green Certifications

- EPEAT™ Gold
- EPEAT Silver
- ENERGY STAR® 8.0
- ErP Lot 3
- RoHS compliant

Other Certifications

Other Certifications

(Optional) TÜV Rheinland® Low Noise

Mil-Spec Test

MIL-STD-810H military test passed (Low Pressure [Altitude], High Temperature, Low Temperature, Temperature Shock, Humidity, Sand and Dust, Vibration, Shock, Fungus, Solar Radiation)

- Feature with ** means that only one offering listed under the feature is configured on selected models.
- Feature with *** means that one or more offerings listed under the feature could be configured on selected models.
- Lenovo reserves the right to change specifications or other product information without notice. Lenovo is not responsible for photographic or typographical errors. LENOVO PROVIDES THIS PUBLICATION "AS IS," WITHOUT WARRANTY OF ANY KIND, EITHER EXPRESS OR IMPLIED, INCLUDING THE IMPLIED WARRANTIES OF MERCHANTABILITY OR FITNESS FOR A PARTICULAR PURPOSE. Some jurisdictions do not allow disclaimer of express or implied warranties in certain transactions, therefore this disclaimer may not apply to you.
- The specifications on this page may not be available in all regions, and may be changed or updated without notice.



OVERVIEW

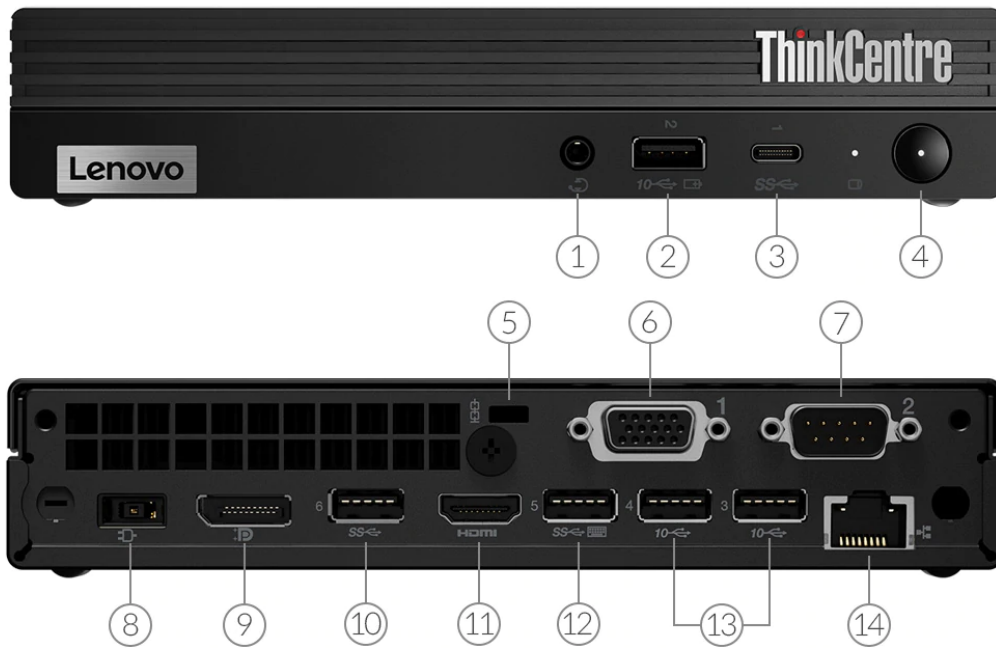

1. Headphone / microphone combo jack (3.5mm)	8. Power connector
2. USB 3.2 Gen 2	9. DisplayPort
3. USB-C 3.2 Gen 1	10. USB 3.2 Gen 2
4. Power button	11. HDMI
5. Kensington Security Slot	12. USB 3.2 Gen 2
6. Optional port 1 (VGA is shown) *	13. 2x USB 3.2 Gen 1
7. Optional port 2 (serial is shown) *	14. Ethernet (RJ-45)

Notes:

- Ports with * are only available on selected models

PERFORMANCE

Processor

Processor Family

Intel® Celeron®, Intel Pentium®, or 10th Generation Intel Core™ i3 / i5 / i7 / i9 Processor

Processor**

Processor Name	Cores	Threads	Base Frequency	Max Frequency	Cache	Memory Support	Processor Graphics
Celeron G5900T	2	2	3.2GHz	-	2MB	DDR4-2666	Intel UHD Graphics 610
Celeron G5905T	2	2	3.3GHz	-	4MB	DDR4-2666	Intel UHD Graphics 610
Pentium Gold G6400T	2	4	3.4GHz	-	4MB	DDR4-2666	Intel UHD Graphics 610
Pentium Gold G6500T	2	4	3.5GHz	-	4MB	DDR4-2666	Intel UHD Graphics 630
Core i3-10100T	4	8	3.0GHz	3.8GHz	6MB	DDR4-2666	Intel UHD Graphics 630
Core i3-10300T	4	8	3.0GHz	3.9GHz	8MB	DDR4-2666	Intel UHD Graphics 630
Core i5-10400T	6	12	2.0GHz	3.6GHz	12MB	DDR4-2666	Intel UHD Graphics 630
Core i5-10500T	6	12	2.3GHz	3.8GHz	12MB	DDR4-2666	Intel UHD Graphics 630
Core i5-10600T	6	12	2.4GHz	4.0GHz	12MB	DDR4-2666	Intel UHD Graphics 630
Core i7-10700T	8	16	2.0GHz	4.5GHz	16MB	DDR4-2933	Intel UHD Graphics 630
Core i9-10900T	10	20	1.9GHz	4.6GHz	20MB	DDR4-2933	Intel UHD Graphics 630

Operating System

Operating System**

- Windows® 10 Pro 64
- Windows 10 Home 64
- Windows 10 IoT Enterprise
- Ubuntu Linux
- No operating system

Graphics

Graphics**^[1]

Graphics	Type	Memory	Connector	Max Resolution	Key Features
Intel UHD graphics 610	Integrated	Shared	1x HDMI®, 1x DP, 1x optional video port (2nd HDMI / VGA / 2nd DP / USB-C / dual DP)	4096x2160@24Hz(onboard HDMI), 4096x2304@60Hz(DP), 3840x2160@60Hz(Dual DP, MST mode), 2048x1536@50Hz(VGA), 4096x2304@60Hz(USB-C)	DirectX® 12
Intel UHD graphics 630	Integrated	Shared	1x HDMI, 1x DP, 1x optional video port (2nd HDMI / VGA / 2nd DP / USB-C / dual DP)	4096x2160@24Hz(onboard HDMI), 4096x2304@60Hz(DP), 3840x2160@60Hz(Dual DP, MST mode), 2048x1536@50Hz(VGA), 4096x2304@60Hz(USB-C)	DirectX 12

Notes:

1. The information of integrated graphics are not applicable for the models without integrated graphics (for the details, please refer to processor section)

Monitor Support

Monitor Support

Supports up to 3 independent displays via (onboard DP, onboard HDMI, and one optional port [VGA / 2nd DP / 2nd HDMI / USB-C]) or (one onboard port [DP / HDMI] and optional dual DP [MST mode])

Chipset

Chipset

Intel Q470 chipset

Memory

Max Memory^[1]

Up to 64GB DDR4-2933

Memory Slots

Two DDR4 SO-DIMM slots, dual-channel capable

Memory Type^{**}

- DDR4-2666
- DDR4-2933

Notes:

1. The max memory is based on the test results with current Lenovo® memory offerings. The system may support more memory as the technology develops.

Storage

Storage Support

Up to two drives, 1x 2.5" HDD + 1x M.2 SSD

- 2.5" HDD up to 1TB
- M.2 SSD up to 2TB
- Optional Intel Optane™ Memory, M.2

Storage Type^{***}

Disk Type	Interface	RPM	Security
2.5" SATA HDD	SATA 6Gb/s	7.2K	-
M.2 2242 SSD	PCIe NVMe, PCIe 3.0 x2	-	-
M.2 2242 SSD	PCIe NVMe, PCIe 3.0 x4	-	-
M.2 2280 SSD	PCIe NVMe, PCIe 3.0 x4	-	Opal
M.2 2280 SSD	PCIe NVMe, PCIe 3.0 x4	-	-
Intel Optane Memory M10	PCIe NVMe, PCIe 3.0 x2	-	-

RAID

No support

Removable Storage

Optical^{**}

- DVD-ROM, slim (9.0mm), via USB external ODD box
- DVD burner (DVD±RW), slim (9.0mm), via USB external ODD box
- None

Card Reader

No card reader

Multi-Media

Audio Chip

High Definition (HD) Audio, Realtek® ALC233VB codec or ALC897Q codec

Speakers

Single speaker, 1.5W x1

Power Supply

Power Supply**

Power	Type	Efficiency	Key Features
65W	Adapter	89%	Autosensing
90W	Adapter	89%	Autosensing
135W	Adapter	89%	Autosensing
No power supply	-	-	-

DESIGN

Input Device

Keyboard**

- Lenovo Calliope Keyboard (USB connector), black
- Lenovo Calliope Wireless Keyboard (2.4GHz via USB receiver), black
- Lenovo Traditional Keyboard (USB connector), black
- No keyboard

Mouse**

- Lenovo Calliope Mouse (USB connector), black
- Lenovo Calliope Wireless Mouse (2.4GHz via USB receiver), black
- Lenovo Fingerprint Mouse (USB connector), Windows Hello support, black
- No mouse

Mechanical

Form Factor

Tiny (1L)

Dimensions (WxDxH)

Models	Dimensions
Tiny only	179 x 183 x 34.5 / 37 mm with rubber feet (7.05 x 7.2 x 1.36 / 1.5 inches with rubber feet)
With VESA mount & ODD box	187 x 183.8 x 66.5 mm (7.36 x 7.24 x 2.62 inches)

Weight

Models	Weight
Tiny only	1.25 kg (2.76 lbs)
With VESA mount & ODD box	1.74 kg (3.84 lbs)

Case Color

Black

Bays

1x 2.5" disk bay

Expansion Slots

Two M.2 slots (one for WLAN, one for SSD)

EOU

(Optional) toolless chassis open (toolless chassis screw required) and toolless M.2 SSD, HDD, memory assembly / removal

Stand

- Vertical stand
- No stand

Mounting

- VESA mount bracket kit, supports VESA mount 75mm and 100mm
- None

Others

- (Optional) Dust filter

- (Optional) Power adapter cage

CONNECTIVITY

Network

Onboard Ethernet

Gigabit Ethernet, Intel Ethernet Connection I219-LM, 1x RJ45, supports Wake-on-LAN

Optional Ethernet

No optional Ethernet

WLAN + Bluetooth^{**}

- Realtek RTL8822CE, 802.11ac Dual Band 2x2 Wi-Fi® + Bluetooth 5.0, M.2 card
- Intel Wireless-AC 9560, 802.11ac Dual Band 2x2 Wi-Fi + Bluetooth 5.0, M.2 card
- Intel Wi-Fi 6 AX201, 802.11ax 2x2 Wi-Fi + Bluetooth 5.1, Intel vPro technology support, M.2 Card
- No WLAN and Bluetooth

Ports^[1]

Front Ports

- 1x USB 3.2 Gen 2 (Always On and fast charge)
- 1x USB-C 3.2 Gen 1
- 1x headphone / microphone combo jack (3.5mm)

Optional Front Ports

None

Rear Ports^[2]

- 2x USB 3.2 Gen 1
- 2x USB 3.2 Gen 2
- 1x HDMI
- 1x DisplayPort™
- 1x Ethernet (RJ-45)

Optional Rear Ports^{***}

- 2x USB 3.2 Gen 1 ports (share one USB 3.2 Gen 1 bandwidth, occupy optional port 1 and 2)
- 2x DisplayPort ports (occupy Optional port 1 and 2)
- Optional port 1 (one of VGA / 2nd DisplayPort / 2nd HDMI / serial / USB-C 3.2 Gen 1 with DisplayPort function)
- Optional port 2 (serial)

Notes:

1. The transfer speed of following ports will vary and, depending on many factors, such as the processing speed of the host device, file attributes and other factors related to system configuration and your operating environment, will be slower than theoretical speed.
USB 2.0: 480 Mbit/s;
USB 3.2 Gen 1 (SuperSpeed USB 5Gbps, formerly USB 3.0 / USB 3.1 Gen 1): 5 Gbit/s;
USB 3.2 Gen 2 (SuperSpeed USB 10Gbps, formerly USB 3.1 Gen 2): 10 Gbit/s;
USB 3.2 Gen 2x2 (SuperSpeed USB 20Gbps): 20 Gbit/s;
Thunderbolt™ 3: 40 Gbit/s;
FireWire 400: 400 Mbit/s;
FireWire 800: 800 Mbit/s
2. For video ports on discrete graphics, please see graphics section

Monitor Cable

Monitor Cable^{***}

- DP to dual DP dongle
- DP to DVI-D dongle
- DP to HDMI 1.4 dongle
- DP to VGA cable (1.5M)
- DP to VGA dongle
- HDMI to HDMI cable (1.5m)
- HDMI to VGA dongle
- No monitor cable

SECURITY & PRIVACY

Security

Security Chip

Discrete TPM 2.0, TCG certified

Physical Locks

Kensington® Security Slot

Chassis Intrusion Switch

Chassis intrusion switch

Fingerprint Reader

- Touch style fingerprint reader on mouse
- No fingerprint reader

BIOS Security

- Administrator password
- Power-on password
- Hard disk password
- Boot sequence control
- Boot without keyboard and mouse
- Smart USB protection (allows keyboard / mouse only, blocks all storage devices)
- Individual USB port disablement

MANAGEABILITY

System Management

System Management^[1]

- Intel vPro with Intel AMT 14.0
- None

Notes:

1. Require choosing a vPro-support Wi-Fi adapter to enable vPro function through wireless connection

SERVICE

Warranty

Base Warranty**

- 1-year depot service
- 1-year limited onsite service
- 3-year limited onsite service
- No base warranty

ENVIRONMENTAL

Operating Environment

Temperature

- Operating: 5°C (41°F) to 35°C (95°F)
- Storage: -40°C (-40°F) to 60°C (140°F)

Humidity

- Operating: 20% to 80%
- Storage: 10% to 90%

Altitude

- Operating: -15.2 m (-50 ft) to 3048 m (10,000 ft)
- Storage: -15.2 m (-50 ft) to 12192 m (40,000 ft)

CERTIFICATIONS

Green Certifications

Green Certifications

- (Optional) EPEAT™ Gold
- (Optional) EPEAT Silver
- ENERGY STAR® 8.0
- ErP Lot 3
- TCO Certified 8.0
- RoHS compliant

Other Certifications

Other Certifications

- (Optional) TÜV Rheinland® Low Noise
- (Optional) TÜV Rheinland Ultra Low Noise

Mil-Spec Test

MIL-STD-810H military test passed (Low Pressure [Altitude], High Temperature, Low Temperature, Temperature Shock, Humidity, Sand and Dust, Vibration, Shock, Fungus, Solar Radiation)

- Feature with ** means that only one offering listed under the feature is configured on selected models.
- Feature with *** means that one or more offerings listed under the feature could be configured on selected models.
- Lenovo reserves the right to change specifications or other product information without notice. Lenovo is not responsible for photographic or typographical errors. LENOVO PROVIDES THIS PUBLICATION “AS IS,” WITHOUT WARRANTY OF ANY KIND, EITHER EXPRESS OR IMPLIED, INCLUDING THE IMPLIED WARRANTIES OF MERCHANTABILITY OR FITNESS FOR A PARTICULAR PURPOSE. Some jurisdictions do not allow disclaimer of express or implied warranties in certain transactions, therefore this disclaimer may not apply to you.
- The specifications on this page may not be available in all regions, and may be changed or updated without notice.

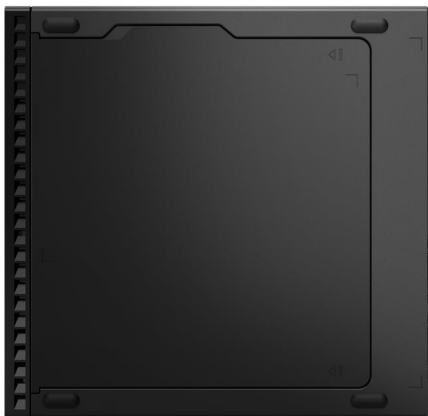

OVERVIEW

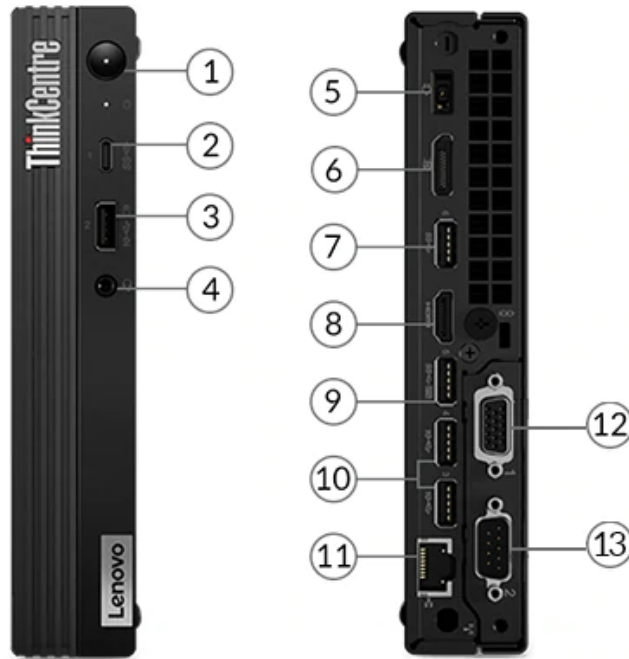

1. Power button	8. HDMI
2. USB-C 3.2 Gen 1	9. USB 3.2 Gen 1
3. USB 3.2 Gen 2	10. 2x USB 3.2 Gen 2
4. Headphone / microphone combo jack (3.5mm)	11. Ethernet (RJ-45)
5. Power connector	12. Optional port 1 (VGA is shown) *
6. DisplayPort	13. Optional port 2 (serial is shown) *
7. USB 3.2 Gen 1	

Notes:

- Ports with * are only available on selected models

PERFORMANCE

Processor

Processor Family

Intel® Celeron®, Intel Pentium®, or 10th Generation Intel Core™ i3 / i5 / i7 / i9 Processor

Processor**

Processor Name	Cores	Threads	Base Frequency	Max Frequency	Cache	Memory Support	Processor Graphics
Celeron G5900	2	2	3.4GHz	-	2MB	DDR4-2666	Intel UHD Graphics 610
Celeron G5900T	2	2	3.2GHz	-	2MB	DDR4-2666	Intel UHD Graphics 610
Celeron G5905	2	2	3.5GHz	-	4MB	DDR4-2666	Intel UHD Graphics 610
Celeron G5905T	2	2	3.3GHz	-	4MB	DDR4-2666	Intel UHD Graphics 610
Celeron G5920	2	2	3.5GHz	-	2MB	DDR4-2666	Intel UHD Graphics 610
Celeron G5925	2	2	3.6GHz	-	4MB	DDR4-2666	Intel UHD Graphics 610
Pentium Gold G6400	2	4	4.0GHz	-	4MB	DDR4-2666	Intel UHD Graphics 610
Pentium Gold G6500	2	4	4.1GHz	-	4MB	DDR4-2666	Intel UHD Graphics 630
Pentium Gold G6500T	2	4	3.5GHz	-	4MB	DDR4-2666	Intel UHD Graphics 630
Pentium Gold G6600	2	4	4.2GHz	-	4MB	DDR4-2666	Intel UHD Graphics 630
Core i3-10100	4	8	3.6GHz	4.3GHz	6MB	DDR4-2666	Intel UHD Graphics 630
Core i3-10100T	4	8	3.0GHz	3.8GHz	6MB	DDR4-2666	Intel UHD Graphics 630
Core i3-10300	4	8	3.7GHz	4.4GHz	8MB	DDR4-2666	Intel UHD Graphics 630
Core i3-10300T	4	8	3.0GHz	3.9GHz	8MB	DDR4-2666	Intel UHD Graphics 630
Core i3-10320	4	8	3.8GHz	4.6GHz	8MB	DDR4-2666	Intel UHD Graphics 630
Core i5-10400	6	12	2.9GHz	4.3GHz	12MB	DDR4-2666	Intel UHD Graphics 630
Core i5-10400T	6	12	2.0GHz	3.6GHz	12MB	DDR4-2666	Intel UHD Graphics 630
Core i5-10500	6	12	3.1GHz	4.5GHz	12MB	DDR4-2666	Intel UHD Graphics 630
Core i5-10500T	6	12	2.3GHz	3.8GHz	12MB	DDR4-2666	Intel UHD Graphics 630
Core i5-10600	6	12	3.3GHz	4.8GHz	12MB	DDR4-2666	Intel UHD Graphics 630
Core i5-10600T	6	12	2.4GHz	4.0GHz	12MB	DDR4-2666	Intel UHD Graphics 630
Core i7-10700	8	16	2.9GHz	4.8GHz	16MB	DDR4-2933	Intel UHD Graphics 630
Core i7-10700T	8	16	2.0GHz	4.5GHz	16MB	DDR4-2933	Intel UHD Graphics 630
Core i9-10900	10	20	2.8GHz	5.2GHz	20MB	DDR4-2933	Intel UHD Graphics 630
Core i9-10900T	10	20	1.9GHz	4.6GHz	20MB	DDR4-2933	Intel UHD Graphics

630

Operating System

Operating System**

- Windows® 10 Pro 64
- Windows 10 Home 64
- Windows 10 IoT Enterprise
- Ubuntu Linux
- No operating system

Graphics

Graphics**[1]

Graphics	Type	Memory	Connector	Max Resolution	Key Features
Intel UHD graphics 610	Integrated	Shared	1x HDMI®, 1x DP, 1x optional video port (2nd HDMI / VGA / 2nd DP / USB-C / dual DP)	4096x2160@24Hz(onboard HDMI), 4096x2304@60Hz(DP), 3840x2160@60Hz(Dual DP, MST mode), 2048x1536@50Hz(VGA), 4096x2304@60Hz(USB-C)	DirectX® 12
Intel UHD graphics 630	Integrated	Shared	1x HDMI, 1x DP, 1x optional video port (2nd HDMI / VGA / 2nd DP / USB-C / dual DP)	4096x2160@24Hz(onboard HDMI), 4096x2304@60Hz(DP), 3840x2160@60Hz(Dual DP, MST mode), 2048x1536@50Hz(VGA), 4096x2304@60Hz(USB-C)	DirectX 12

Notes:

1. The information of integrated graphics are not applicable for the models without integrated graphics (for the details, please refer to processor section)

Monitor Support

Monitor Support

Supports up to 3 independent displays via (onboard DP, onboard HDMI, and one optional port [VGA / 2nd DP / 2nd HDMI / USB-C]) or (one onboard port [DP / HDMI] and optional dual DP [MST mode])

Chipset

Chipset

Intel Q470 chipset

Memory

Max Memory^[1]

Up to 64GB DDR4-2933

Memory Slots

Two DDR4 SO-DIMM slots, dual-channel capable

Memory Type**[2]

- DDR4-2666
- DDR4-2933

Notes:

1. The max memory is based on the test results with current Lenovo® memory offerings. The system may support more memory as the technology develops.
2. Installed memory is actually 3200MHz, but may run at 2666MHz or 2933MHz, depending on the memory support capability of processor

Storage

Storage Support

Up to three drives, 1x 2.5" HDD + 2x M.2 SSD

- 2.5" HDD up to 1TB
- M.2 SSD up to 2TB each
- Optional Intel Optane™ Memory, M.2

Storage Type***

Disk Type	Interface	RPM	Security
2.5" SATA HDD	SATA 6Gb/s	7.2K	-
M.2 2242 SSD	PCIe NVMe, PCIe 3.0 x2	-	-
M.2 2242 SSD	PCIe NVMe, PCIe 3.0 x4	-	-
M.2 2280 SSD	PCIe NVMe, PCIe 3.0 x4	-	Opal
M.2 2280 SSD	PCIe NVMe, PCIe 3.0 x4	-	-
Intel Optane Memory M10	PCIe NVMe, PCIe 3.0 x2	-	-

RAID

RAID 0/1 support for M.2 SSDs (RAID preset only available via special bid model)

Removable Storage**Optical****

- DVD-ROM, slim (9.0mm), via USB external ODD box
- DVD burner (DVD±RW), slim (9.0mm), via USB external ODD box
- None

Card Reader

No card reader

Multi-Media**Audio Chip**

High Definition (HD) Audio, Realtek® ALC233VB codec

Speakers

Single speaker, 1.5W x1

Power Supply**Power Supply****

Power	Type	Efficiency	Key Features
65W	Adapter	89%	Autosensing
90W	Adapter	89%	Autosensing
135W	Adapter	89%	Autosensing
230W	Adapter	89%	Autosensing
No power supply	-	-	-

DESIGN**Input Device****Keyboard****

- Lenovo Calliope Keyboard (USB connector), black
- Lenovo Calliope Wireless Keyboard (2.4GHz via USB receiver), black
- Lenovo Traditional Keyboard (USB connector), black
- No keyboard

Mouse**

- Lenovo Calliope Mouse (USB connector), black
- Lenovo Calliope Wireless Mouse (2.4GHz via USB receiver), black
- Lenovo Fingerprint Mouse (USB connector), Windows Hello support, black
- No mouse

Mechanical**Form Factor**

Tiny (1L)

Dimensions (WxDxH)

Models	Dimensions
Tiny only	179 x 183 x 34.5 / 37 mm with rubber feet (7.05 x 7.2 x 1.36 / 1.5 inches with rubber feet)
With VESA mount & ODD box	187 x 183.8 x 66.5 mm (7.36 x 7.24 x 2.62 inches)

Weight

Models	Weight
Tiny only	1.25 kg (2.76 lbs)
With VESA mount & ODD box	1.74 kg (3.84 lbs)

Case Color

Black

Bays

1x 2.5" disk bay

Expansion Slots^[1]

- One PCIe 3.0 x8, low-profile
- Three M.2 slots (one for WLAN, two for SSD)

EOU

(Optional) toolless chassis open (toolless chassis screw required) and toolless M.2 SSD, HDD, memory assembly / removal

Stand

- Vertical stand
- No stand

Mounting

- VESA mount bracket kit, supports VESA mount 75mm and 100mm
- None

Others

- (Optional) Dust filter
- (Optional) Power adapter cage

Notes:

1. PCIe 3.0 x8 slot is for Lenovo qualified PCIe cards, Intel I350-T4 ethernet card and 4x serial port expansion card. The PCIe card occupies the space of 2.5" HDD/SSD and optional ports, they are mutually exclusive.

CONNECTIVITY

Network

Onboard Ethernet

Gigabit Ethernet, Intel Ethernet Connection I219-LM, 1x RJ45, supports Wake-on-LAN

Optional Ethernet^[1]

- Gigabit Ethernet, Intel Ethernet Server Adapter I350-T4, 4x RJ-45, PCIe x4
- No optional Ethernet

WLAN + Bluetooth[®]*

- Realtek RTL8822CE, 802.11ac Dual Band 2x2 Wi-Fi[®] + Bluetooth 5.0, M.2 card
- Intel Wireless-AC 9560, 802.11ac Dual Band 2x2 Wi-Fi + Bluetooth 5.0, M.2 card
- Intel Wi-Fi 6 AX201, 802.11ax 2x2 Wi-Fi + Bluetooth 5.1, Intel vPro technology support, M.2 Card
- No WLAN and Bluetooth

Notes:

1. Intel Ethernet Server Adapter I350-T4 is not available in EMEA

Ports^[1]

Front Ports

- 1x USB 3.2 Gen 2 (Always On and fast charge)

- 1x USB-C 3.2 Gen 1
- 1x headphone / microphone combo jack (3.5mm)

Optional Front Ports

None

Rear Ports^[2]

- 2x USB 3.2 Gen 1
- 2x USB 3.2 Gen 2
- 1x HDMI
- 1x DisplayPort™
- 1x Ethernet (RJ-45)

Optional Rear Ports^{*}**

- 2x USB 3.2 Gen 1 ports (share one USB 3.2 Gen 1 bandwidth, occupy optional port 1 and 2)
- 4x USB 3.2 Gen 1 ports (share one USB 3.2 Gen 1 bandwidth, occupy optional port 1 and 2)
- 2x DisplayPort ports (occupy Optional port 1 and 2)
- Optional port 1 (one of VGA / 2nd DisplayPort / 2nd HDMI / serial / USB-C 3.2 Gen 1 with DisplayPort function)
- Optional port 2 (serial)

Notes:

1. The transfer speed of following ports will vary and, depending on many factors, such as the processing speed of the host device, file attributes and other factors related to system configuration and your operating environment, will be slower than theoretical speed.
USB 2.0: 480 Mbit/s;
USB 3.2 Gen 1 (SuperSpeed USB 5Gbps, formerly USB 3.0 / USB 3.1 Gen 1): 5 Gbit/s;
USB 3.2 Gen 2 (SuperSpeed USB 10Gbps, formerly USB 3.1 Gen 2): 10 Gbit/s;
USB 3.2 Gen 2x2 (SuperSpeed USB 20Gbps): 20 Gbit/s;
Thunderbolt™ 3: 40 Gbit/s;
FireWire 400: 400 Mbit/s;
FireWire 800: 800 Mbit/s
2. For video ports on discrete graphics, please see graphics section

Monitor Cable**Monitor Cable^{***}**

- DP to dual DP dongle
- DP to DVI-D dongle
- DP to HDMI 1.4 dongle
- DP to VGA cable (1.5M)
- DP to VGA dongle
- HDMI to HDMI cable (1.5m)
- HDMI to VGA dongle
- No monitor cable

SECURITY & PRIVACY**Security****Security Chip**

Discrete TPM 2.0, TCG certified

Physical Locks

Kensington® Security Slot

Chassis Intrusion Switch

Chassis intrusion switch

Fingerprint Reader

- Touch style fingerprint reader on mouse
- No fingerprint reader

BIOS Security

- Administrator password
- Power-on password
- Hard disk password
- Boot sequence control
- Boot without keyboard and mouse
- Self-healing BIOS

- Smart USB protection (allows keyboard / mouse only, blocks all storage devices)
- Individual USB port disablement

MANAGEABILITY

System Management

System Management^[1]

- Intel vPro with Intel AMT 14.0
- None

Notes:

1. Require choosing a vPro-support Wi-Fi adapter to enable vPro function through wireless connection

SERVICE

Warranty

Base Warranty**

- 1-year limited onsite service
- 3-year limited onsite service
- No base warranty

ENVIRONMENTAL

Operating Environment

Temperature

- Operating: 5°C (41°F) to 35°C (95°F)
- Storage: -40°C (-40°F) to 60°C (140°F)

Humidity

- Operating: 20% to 80%
- Storage: 10% to 90%

Altitude

- Operating: -15.2 m (-50 ft) to 3048 m (10,000 ft)
- Storage: -15.2 m (-50 ft) to 12192 m (40,000 ft)

CERTIFICATIONS

Green Certifications

Green Certifications

- (Optional) EPEAT™ Gold
- (Optional) EPEAT Silver
- ENERGY STAR® 8.0
- ErP Lot 3
- TCO Certified 8.0
- RoHS compliant

Other Certifications

Other Certifications

- (Optional) TÜV Rheinland® Low Noise
- (Optional) TÜV Rheinland Ultra Low Noise

Mil-Spec Test

MIL-STD-810H military test passed (Low Pressure [Altitude], High Temperature, Low Temperature, Temperature Shock, Humidity, Sand and Dust, Vibration, Shock, Fungus, Solar Radiation)

- Feature with ** means that only one offering listed under the feature is configured on selected models.
- Feature with *** means that one or more offerings listed under the feature could be configured on selected models.
- Lenovo reserves the right to change specifications or other product information without notice. Lenovo is not responsible for photographic or typographical errors. LENOVO PROVIDES THIS PUBLICATION “AS IS,” WITHOUT WARRANTY OF ANY KIND, EITHER EXPRESS OR IMPLIED, INCLUDING THE IMPLIED WARRANTIES OF MERCHANTABILITY OR FITNESS FOR A PARTICULAR PURPOSE. Some jurisdictions do not allow disclaimer of express or implied warranties in certain transactions, therefore this disclaimer may not apply to you.
- The specifications on this page may not be available in all regions, and may be changed or updated without notice.

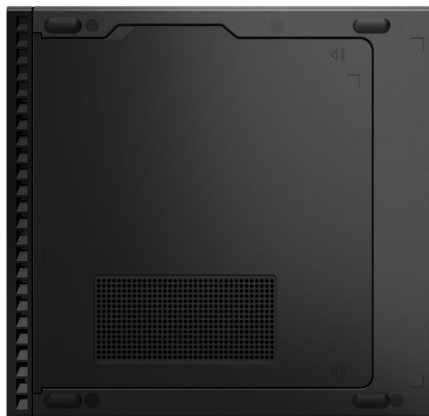

OVERVIEW

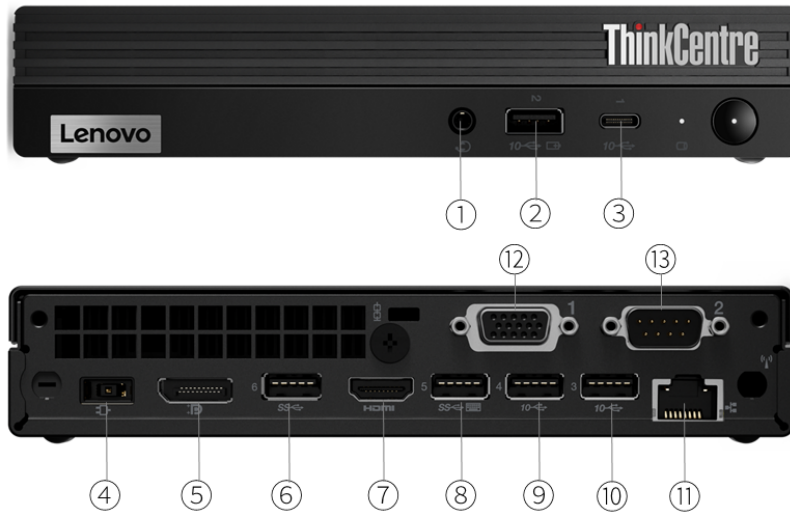

1. Headphone / microphone combo jack (3.5mm)	8. USB 3.2 Gen 1
2. USB 3.2 Gen 2	9. USB 3.2 Gen 2
3. USB-C 3.2 Gen 2	10. USB 3.2 Gen 2
4. Power connector	11. Ethernet (RJ-45)
5. DisplayPort	12. Optional port 1 (VGA is shown) *
6. USB 3.2 Gen 1	13. Optional port 2 (serial is shown) *
7. HDMI	

Notes:

- Ports with * are only available on selected models

PERFORMANCE

Processor

Processor Family

Intel® Celeron®, Intel Pentium®, 10th Generation Intel Core™ i3, or 11th Generation Intel Core i5 / i7 / i9 Processor

Processor**

Processor Name	Cores	Threads	Base Frequency	Max Frequency	Cache	Memory Support	Processor Graphics
Celeron G5905T	2	2	3.3GHz	-	4MB	DDR4-2666	Intel UHD Graphics 610
Celeron G5925	2	2	3.6GHz	-	4MB	DDR4-2666	Intel UHD Graphics 610
Pentium Gold G6505T	2	4	3.6GHz	-	4MB	DDR4-2666	Intel UHD Graphics 630
Pentium Gold G6605	2	4	4.3GHz	-	4MB	DDR4-2666	Intel UHD Graphics 630
Core i3-10105	4	8	3.7GHz	4.4GHz	6MB	DDR4-2666	Intel UHD Graphics 630
Core i3-10105T	4	8	3.0GHz	3.9GHz	6MB	DDR4-2666	Intel UHD Graphics 630
Core i3-10305	4	8	3.8GHz	4.5GHz	8MB	DDR4-2666	Intel UHD Graphics 630
Core i3-10305T	4	8	3.0GHz	4.0GHz	8MB	DDR4-2666	Intel UHD Graphics 630
Core i3-10325	4	8	3.9GHz	4.7GHz	8MB	DDR4-2666	Intel UHD Graphics 630
Core i5-11400	6	12	2.6GHz	4.4GHz	12MB	DDR4-3200	Intel UHD Graphics 730
Core i5-11400T	6	12	1.3GHz	3.7GHz	12MB	DDR4-3200	Intel UHD Graphics 730
Core i5-11500	6	12	2.7GHz	4.6GHz	12MB	DDR4-3200	Intel UHD Graphics 750
Core i5-11500T	6	12	1.5GHz	3.9GHz	12MB	DDR4-3200	Intel UHD Graphics 750
Core i5-11600	6	12	2.8GHz	4.8GHz	12MB	DDR4-3200	Intel UHD Graphics 750
Core i5-11600T	6	12	1.7GHz	4.1GHz	12MB	DDR4-3200	Intel UHD Graphics 750
Core i7-11700	8	16	2.5GHz	4.9GHz	16MB	DDR4-3200	Intel UHD Graphics 750
Core i7-11700T	8	16	1.4GHz	4.6GHz	16MB	DDR4-3200	Intel UHD Graphics 750
Core i9-11900	8	16	2.5GHz	5.2GHz	16MB	DDR4-3200	Intel UHD Graphics 750
Core i9-11900T	8	16	1.5GHz	4.9GHz	16MB	DDR4-3200	Intel UHD Graphics 750

Operating System

Operating System**

- Windows® 10 Pro 64
- Windows 10 Home 64
- Windows 10 IoT Enterprise
- No operating system

Graphics

Graphics**[1]

Graphics	Type	Memory	Connector	Max Resolution	Key Features	Remark
Intel UHD graphics 610	Integrated	Shared	1x HDMI®, 1x DP, 1x optional video port (2nd HDMI / VGA / 2nd DP / USB-C / dual DP)	4096x2160@24Hz(onboard HDMI), 4096x2304@60Hz(DP), 3840x2160@60Hz(Dual DP, MST mode), 2048x1536@50Hz(VGA), 4096x2304@60Hz(USB-C)	DirectX® 12	-

Intel UHD graphics 630	Integrated	Shared	1x HDMI, 1x DP, 1x optional video port (2nd HDMI / VGA / 2nd DP / USB-C / dual DP)	4096x2160@24Hz(onboard HDMI), 4096x2304@60Hz(DP), 3840x2160@60Hz(Dual DP, MST mode), 2048x1536@50Hz(VGA), 4096x2304@60Hz(USB-C)	DirectX 12	-
Intel UHD Graphics 730	Integrated	Shared	1x HDMI, 1x DP, 1x optional video port (2nd HDMI / VGA / 2nd DP / USB-C / dual DP)	4096x2160@24Hz(onboard HDMI), 4096x2304@60Hz(DP), 3840x2160@60Hz(Dual DP, MST mode), 2048x1536@50Hz(VGA), 4096x2304@60Hz(USB-C)	DirectX 12	-
Intel UHD Graphics 750	Integrated	Shared	1x HDMI, 1x DP, 1x optional video port (2nd HDMI / VGA / 2nd DP / USB-C / dual DP)	4096x2160@24Hz(onboard HDMI), 4096x2304@60Hz(DP), 3840x2160@60Hz(Dual DP, MST mode), 2048x1536@50Hz(VGA), 4096x2304@60Hz(USB-C)	DirectX 12	-

Notes:

- The information of integrated graphics are not applicable for the models without integrated graphics (for the details, please refer to processor section)

Monitor Support

Monitor Support

Supports up to 3 independent displays via (onboard DP, onboard HDMI, and one optional port [VGA / 2nd DP / 2nd HDMI / USB-C]) or (one onboard port [DP / HDMI] and optional dual DP [MST mode])

Chipset

Chipset

Intel Q570 Chipset

Memory

Max Memory^[1]

- Up to 64GB DDR4-2666
- Up to 64GB DDR4-2933
- Up to 64GB DDR4-3200

Memory Slots

Two DDR4 SO-DIMM slots, dual-channel capable

Memory Type^{**[2]}

- DDR4-2666
- DDR4-2933
- DDR4-3200

Notes:

- The max memory is based on the test results with current Lenovo® memory offerings. The system may support more memory as the technology develops.
- Installed memory is actually 3200MHz, but may run at 2666MHz, 2933 MHz or 3200MHz depending on the memory support capability of processor

Storage

Storage Support

Up to three drives, 1x 2.5" HDD + 2x M.2 SSD

- 2.5" HDD up to 1TB
- M.2 SSD up to 2TB each

Storage Type^{***}

Disk Type	Interface	RPM	Offering	Security
2.5" SATA HDD	SATA 6Gb/s	7.2K	-	-
M.2 2242 SSD	PCIe NVMe	-	-	-
M.2 2280 SSD	PCIe NVMe	-	-	Opal

RAID

RAID 0/1 support for M.2 SSDs

Removable Storage**Optical****

- DVD-ROM, slim (9.0mm), via USB external ODD box
- DVD burner (DVD±RW), slim (9.0mm), via USB external ODD box
- None

Card Reader

No card reader

Multi-Media**Audio Chip**

High Definition (HD) Audio, Realtek® ALC233VB codec

Speakers

Single speaker, 1.5W x1

Power Supply**Power Supply****

Power	Type	Efficiency	Key Features
65W	Adapter	89%	Autosensing
90W	Adapter	89%	Autosensing
135W	Adapter	89%	Autosensing
230W	Adapter	89%	Autosensing
No power supply	-	-	-

DESIGN**Input Device****Keyboard****

- Lenovo Calliope Keyboard (USB connector), black
- Lenovo Calliope Wireless Keyboard, black
- Lenovo Traditional Keyboard (USB connector), black
- No keyboard

Mouse**

- Lenovo Calliope Mouse (USB connector), black
- Lenovo Calliope Wireless Mouse (2.4GHz via USB receiver), black
- Lenovo Fingerprint Mouse (USB connector), black
- No mouse

Mechanical**Form Factor**

Tiny (1L)

Dimensions (WxDxH)

Models	Dimensions
Tiny only	179 x 182.9 x 36.5 mm with rubber feet (7.05 x 7.2 x 1.44 inches with rubber feet)

Weight

Models	Weight
Tiny only	1.25 kg (2.76 lbs)
With VESA mount & ODD box	1.74 kg (3.84 lbs)

Case Color

Black

Bays

1x 2.5" disk bay

Expansion Slots

Three M.2 slots (one for WLAN, two for SSD)

EOU

- (Optional) toolless chassis open (toolless chassis screw required) and toolless M.2 SSD, HDD, memory assembly / removal
- No support

Stand

- Vertical stand
- No stand

Mounting

- VESA mount bracket kit, supports VESA mount 75mm and 100mm
- None

Others

- (Optional) Dust filter
- (Optional) Power adapter cage

CONNECTIVITY

Network

Onboard Ethernet

Gigabit Ethernet, Intel Ethernet Connection I219-LM, 1x RJ45, supports Wake-on-LAN

Optional Ethernet^[1]

- Gigabit Ethernet, Intel Ethernet Server Adapter I350-T4, 4x RJ-45, PCIe x4
- No optional Ethernet

WLAN + Bluetooth^{**}

- Realtek RTL8822CE, 802.11ac Dual Band 2x2 Wi-Fi® + Bluetooth 5.0, M.2 card
- Intel Wireless-AC 9560, 802.11ac Dual Band 2x2 Wi-Fi + Bluetooth 5.1, M.2 card
- Intel Wi-Fi 6 AX201, 802.11ax 2x2 Wi-Fi + Bluetooth 5.2, M.2 Card
- No WLAN and Bluetooth

Notes:

1. Intel Ethernet Server Adapter I350-T4 is not available in EMEA

Ports^[1]

Front Ports

- 1x USB 3.2 Gen 2 (Always On and fast charge)
- 1x USB-C 3.2 Gen 2
- 1x headphone / microphone combo jack (3.5mm)

Optional Front Ports

None

Rear Ports^[2]

- 2x USB 3.2 Gen 1
- 2x USB 3.2 Gen 2
- 1x HDMI
- 1x DisplayPort™
- 1x Ethernet (RJ-45)

Optional Rear Ports^{***}

- 2x USB 3.2 Gen 1 ports (share one USB 3.2 Gen 1 bandwidth, occupy optional port 1 and 2)
- 4x USB 3.2 Gen 1 ports (share one USB 3.2 Gen 1 bandwidth, occupy optional port 1 and 2)
- 2x DisplayPort ports (occupy Optional port 1 and 2)
- Optional port 1 (one of VGA / 2nd DisplayPort / 2nd HDMI / serial / USB-C 3.2 Gen 1 with DisplayPort function)
- Optional port 2 (serial)

- I/O Box

Notes:

1. The transfer speed of following ports will vary and, depending on many factors, such as the processing speed of the host device, file attributes and other factors related to system configuration and your operating environment, will be slower than theoretical speed.
USB 2.0: 480 Mbit/s;
USB 3.2 Gen 1 (SuperSpeed USB 5Gbps, formerly USB 3.0 / USB 3.1 Gen 1): 5 Gbit/s;
USB 3.2 Gen 2 (SuperSpeed USB 10Gbps, formerly USB 3.1 Gen 2): 10 Gbit/s;
USB 3.2 Gen 2x2 (SuperSpeed USB 20Gbps): 20 Gbit/s;
Thunderbolt™ 3: 40 Gbit/s;
FireWire 400: 400 Mbit/s;
FireWire 800: 800 Mbit/s
2. For video ports on discrete graphics, please see graphics section

Monitor Cable

Monitor Cable***

- DP to DVI-D dongle
- DP to HDMI 1.4 dongle
- DP to VGA dongle
- HDMI to VGA dongle
- No monitor cable

SECURITY & PRIVACY

Security

Security Chip

Discrete TPM 2.0, TCG certified

Physical Locks

Kensington® Security Slot

Chassis Intrusion Switch

Chassis intrusion switch

Fingerprint Reader

- Touch style fingerprint reader on mouse
- No fingerprint reader

BIOS Security

- Administrator password
- Power-on password
- Hard disk password
- Boot sequence control
- Boot without keyboard and mouse
- Smart USB protection (allows keyboard / mouse only, blocks all storage devices)
- Individual USB port disablement

MANAGEABILITY

System Management

System Management

- No DASH
- Intel vPro Technology, DASH

SERVICE

Warranty

Base Warranty**

- 1-year limited onsite service
- 3-year limited onsite service
- No base warranty

ENVIRONMENTAL

Operating Environment

Temperature

- Operating: 5°C (41°F) to 35°C (95°F)
- Storage: -40°C (-40°F) to 60°C (140°F)

Humidity

- Operating: 20% to 80%
- Storage: 20% to 90%

Altitude

- Operating: -15.2 m (-50 ft) to 3048 m (10,000 ft)
- Storage: -15.2 m (-50 ft) to 10668 m (35,000 ft)

CERTIFICATIONS

Green Certifications

Green Certifications

- EPEAT™ Gold
- ENERGY STAR® 8.0
- RoHS compliant

Other Certifications

Other Certifications

- (Optional) TÜV Rheinland® Ultra Low Noise
- (Optional) Windows 10 Secured-core PCs

Mil-Spec Test

MIL-STD-810H military test passed

- Feature with ** means that only one offering listed under the feature is configured on selected models.
- Feature with *** means that one or more offerings listed under the feature could be configured on selected models.
- Lenovo reserves the right to change specifications or other product information without notice. Lenovo is not responsible for photographic or typographical errors. LENOVO PROVIDES THIS PUBLICATION “AS IS,” WITHOUT WARRANTY OF ANY KIND, EITHER EXPRESS OR IMPLIED, INCLUDING THE IMPLIED WARRANTIES OF MERCHANTABILITY OR FITNESS FOR A PARTICULAR PURPOSE. Some jurisdictions do not allow disclaimer of express or implied warranties in certain transactions, therefore this disclaimer may not apply to you.
- The specifications on this page may not be available in all regions, and may be changed or updated without notice.



intel



intel



intel

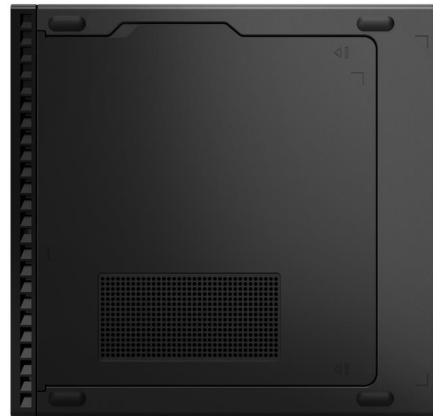

intel



intel



intel

OVERVIEW

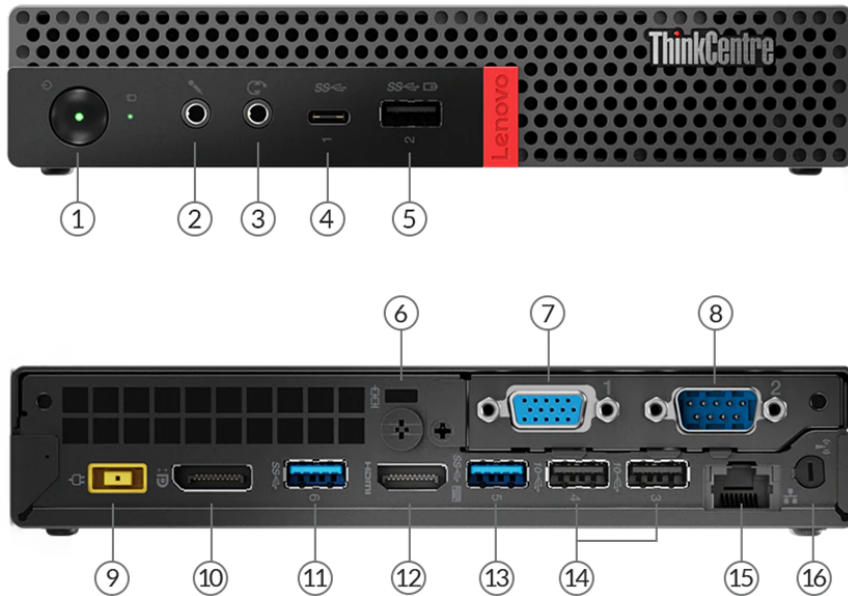

1. Power button	9. Power connector
2. Microphone (3.5mm)	10. DisplayPort
3. Headphone / microphone combo jack (3.5mm)	11. USB 3.1 Gen 1
4. USB-C 3.1 Gen 1	12. HDMI
5. USB 3.1 Gen 1	13. USB 3.1 Gen 1
6. Kensington Security Slot	14. 2x USB 3.1 Gen 2
7. Optional port 1 (VGA is shown) *	15. Ethernet (RJ-45)
8. Optional port 2 (serial is shown) *	16. Wi-Fi antenna *

Notes:

- Ports with * are only available on selected models

PERFORMANCE

Processor

Processor Family

Intel® Celeron®, Intel Pentium®, 8th Generation Intel Core™ i3 / i5 / i7, or 9th Generation Intel Core i3 / i5 / i7 / i9 Processor

Processor**

Processor Name	Cores	Threads	Base Frequency	Max Frequency	Cache	Memory Support	Processor Graphics
Celeron G4900T	2	2	2.9GHz	-	2MB	DDR4-2400	Intel UHD Graphics 610
Celeron G4930T	2	2	3.0GHz	-	2MB	DDR4-2400	Intel UHD Graphics 610
Pentium Gold G5400T	2	4	3.1GHz	-	4MB	DDR4-2400	Intel UHD Graphics 610
Pentium Gold G5420T	2	4	3.2GHz	-	4MB	DDR4-2400	Intel UHD Graphics 610
Pentium Gold G5500T	2	4	3.2GHz	-	4MB	DDR4-2400	Intel UHD Graphics 630
Pentium Gold G5600T	2	4	3.3GHz	-	4MB	DDR4-2400	Intel UHD Graphics 630
Core i3-8100T	4	4	3.1GHz	-	6MB	DDR4-2400	Intel UHD Graphics 630
Core i3-8300T	4	4	3.2GHz	-	8MB	DDR4-2400	Intel UHD Graphics 630
Core i3-9100T	4	4	3.1GHz	3.7GHz	6MB	DDR4-2400	Intel UHD Graphics 630
Core i3-9300T	4	4	3.2GHz	3.8GHz	8MB	DDR4-2400	Intel UHD Graphics 630
Core i5-8400T	6	6	1.7GHz	3.3GHz	9MB	DDR4-2666	Intel UHD Graphics 630
Core i5-8500T	6	6	2.1GHz	3.5GHz	9MB	DDR4-2666	Intel UHD Graphics 630
Core i5-8600T	6	6	2.3GHz	3.7GHz	9MB	DDR4-2666	Intel UHD Graphics 630
Core i5-9400T	6	6	1.8GHz	3.4GHz	9MB	DDR4-2666	Intel UHD Graphics 630
Core i5-9500T	6	6	2.2GHz	3.7GHz	9MB	DDR4-2666	Intel UHD Graphics 630
Core i5-9600T	6	6	2.3GHz	3.9GHz	9MB	DDR4-2666	Intel UHD Graphics 630
Core i7-8700T	6	12	2.4GHz	4.0GHz	12MB	DDR4-2666	Intel UHD Graphics 630
Core i7-9700T	8	8	2.0GHz	4.3GHz	12MB	DDR4-2666	Intel UHD Graphics 630
Core i9-9900T	8	16	2.1GHz	4.4GHz	16MB	DDR4-2666	Intel UHD Graphics 630

Operating System

Operating System**

- Windows® 10 Pro 64
- Windows 10 Home 64
- Windows 10 IoT Enterprise
- Ubuntu Linux
- No operating system

Graphics

Graphics^[1]**

Graphics	Type	Memory	Connector	Max Resolution	Key Features
Intel UHD graphics 610	Integrated	Shared	1x HDMI®, 1x DP, 1x optional video port (2nd HDMI / VGA / 2nd DP / USB-C)	4096x2160@24Hz(onboard HDMI), 4096x2304@60Hz(DP), 2048x1536@50Hz(VGA), 4096x2304@60Hz(USB-C)	DirectX® 12
Intel UHD graphics 630	Integrated	Shared	1x HDMI, 1x DP, 1x optional video port (2nd HDMI / VGA / 2nd DP / USB-C)	4096x2160@24Hz(onboard HDMI), 4096x2304@60Hz(DP), 2048x1536@50Hz(VGA), 4096x2304@60Hz(USB-C)	DirectX 12

Notes:

- The information of integrated graphics are not applicable for the models without integrated graphics (for the details, please refer to processor section)

Monitor Support

Monitor Support

Supports up to 3 independent displays via onboard ports (DisplayPort™ + HDMI + 1x optional port [VGA / 2nd DP / 2nd HDMI / USB-C])

Chipset

Chipset

Intel Q370 chipset

Memory

Max Memory^[1]

Up to 32GB DDR4-2666

Memory Slots

Two DDR4 SO-DIMM slots, dual-channel capable

Memory Type^[2]

DDR4-2666

Notes:

- The max memory is based on the test results with current Lenovo® memory offerings. The system may support more memory as the technology develops.
- System automatically clocks down for the processors with lower memory controller

Storage

Storage Support

Up to two drives, 1x 2.5" HDD/SSD + 1x M.2 SSD

- 2.5" HDD up to 1TB
- 2.5" SSD up to 256GB
- M.2 SSD up to 1TB
- Optional Intel Optane™ Memory, M.2

Storage Type***

Disk Type	Interface	RPM	Security
2.5" SATA HDD	SATA 6Gb/s	5.4K	-
2.5" SATA HDD	SATA 6Gb/s	7.2K	-
2.5" SATA SSD	SATA 6Gb/s	-	Opal
2.5" SATA SSD	SATA 6Gb/s	-	-
M.2 2242 SSD	PCIe NVMe, PCIe 3.0 x2	-	-
M.2 2280 SSD	PCIe NVMe, PCIe 3.0 x4	-	Opal
M.2 2280 SSD	PCIe NVMe, PCIe 3.0 x4	-	-

Intel Optane Memory M10	PCIe NVMe, PCIe 3.0 x2	-	-
-------------------------	------------------------	---	---

RAID

No support

Removable Storage**Optical****

- DVD-ROM, slim (9.0mm), via USB external ODD box
- DVD burner (DVD±RW), slim (9.0mm), via USB external ODD box
- None

Card Reader

No card reader

Multi-Media**Audio Chip**

High Definition (HD) Audio, Realtek® ALC233VB2 codec

Speakers**

- Single speaker, 1.5W x1
- Single speaker, 2W x1

Power Supply**Power Supply****

Power	Type	Efficiency	Key Features
65W	Adapter	88%	Autosensing
90W	Adapter	88%	Autosensing
135W	Adapter	88%	Autosensing
No power supply	-	-	-

DESIGN**Input Device****Keyboard****

- Lenovo Calliope Wireless Keyboard (2.4GHz via USB receiver), black
- Lenovo Traditional Keyboard (USB connector), black
- No keyboard

Mouse**

- Lenovo Calliope Mouse (USB connector), black
- Lenovo Calliope Wireless Mouse (2.4GHz via USB receiver), black
- Lenovo Fingerprint Mouse (USB connector), Windows Hello support, black
- No mouse

Mechanical**Form Factor**

Tiny (1L)

Dimensions (WxDxH)

Models	Dimensions
Tiny only	179 x 183 x 34.5 / 37 mm with rubber feet (7.05 x 7.2 x 1.36 / 1.5 inches with rubber feet)
With VESA mount & ODD box	188.4 x 185.38 x 63 mm (7.42 x 7.30 x 2.48 inches)

Weight

Models	Weight
Tiny only	1.32 kg (2.91 lbs)

ThinkCentre M920 Tiny

With VESA mount & ODD box	1.66 kg (3.66 lbs)
---------------------------	--------------------

Case Color

Black

Bays^[1]

1x 2.5" disk bay

Expansion Slots^[2]

- One PCIe 3.0 x8, low-profile
- Two M.2 slots (one for WLAN, one for SSD)

EOU

(Optional) toolless chassis open (toolless chassis screw required) and toolless M.2 SSD, HDD, memory assembly / removal

Stand

- Vertical stand
- No stand

Mounting

- VESA mount bracket kit, supports VESA mount 75mm and 100mm
- None

Others

- (Optional) Dust filter
- (Optional) Power adapter cage

Notes:

1. 2.5" HDD/SSD and PCIe card are mutually exclusive
2. 2.5" HDD/SSD and PCIe card are mutually exclusive

CONNECTIVITY

Network

Onboard Ethernet

Gigabit Ethernet, Intel Ethernet Connection I219-LM, 1x RJ45, supports Wake-on-LAN

Optional Ethernet

- Gigabit Ethernet, Intel Ethernet Server Adapter I350-T4, 4x RJ-45, PCIe x4
- No optional Ethernet

WLAN + Bluetooth^{®**}

- Realtek RTL8821CE, 802.11ac Dual Band 1x1 Wi-Fi[®] + Bluetooth 4.2, M.2 card
- Realtek RTL8822BE, 802.11ac Dual Band 2x2 Wi-Fi + Bluetooth 4.2, M.2 card
- Intel Dual Band Wireless-AC 3165, 802.11ac Dual Band 1x1 Wi-Fi + Bluetooth 4.2, M.2 Card
- Intel Dual Band Wireless-AC 8265, 802.11ac Dual Band 2x2 Wi-Fi + Bluetooth 4.2, M.2 Card
- Intel Wireless-AC 9560, 802.11ac Dual Band 2x2 Wi-Fi + Bluetooth 5.0, Intel vPro technology support, M.2 card
- No WLAN and Bluetooth

Ports^[1]

Front Ports

- 1x USB 3.1 Gen 1 (Always On and fast charge)
- 1x USB-C 3.1 Gen 1
- 1x headphone / microphone combo jack (3.5mm)
- 1x microphone (3.5mm)

Rear Ports^[2]

- 2x USB 3.1 Gen 1
- 2x USB 3.1 Gen 2
- 1x HDMI
- 1x DisplayPort
- 1x Ethernet (RJ-45)

Optional Rear Ports^{***}

- 2x USB 3.1 Gen 1 (via 2-port USB expansion card, PCIe x1)
- 1x Thunderbolt[™] 3 (combo USB-C 3.1 Gen 2 / DisplayPort, via Thunderbolt expansion card, PCIe x4)

ThinkCentre M920 Tiny

- Optional port 1 (one of VGA / 2nd DisplayPort / 2nd HDMI / serial / USB-C 3.1 Gen 1 with DisplayPort function)
- Optional port 2 (serial)
- 4x serial (via 4-port serial expansion card, PCIe x1)
- 1x parallel (external USB to parallel dongle)
- 2x PS/2 (USB to 2x PS/2 dongle)

Notes:

1. The transfer speed of following ports will vary and, depending on many factors, such as the processing speed of the host device, file attributes and other factors related to system configuration and your operating environment, will be slower than theoretical speed.
USB 2.0: 480 Mbit/s;
USB 3.2 Gen 1 (SuperSpeed USB 5Gbps, formerly USB 3.0 / USB 3.1 Gen 1): 5 Gbit/s;
USB 3.2 Gen 2 (SuperSpeed USB 10Gbps, formerly USB 3.1 Gen 2): 10 Gbit/s;
USB 3.2 Gen 2x2 (SuperSpeed USB 20Gbps): 20 Gbit/s;
Thunderbolt 3: 40 Gbit/s;
FireWire 400: 400 Mbit/s;
FireWire 800: 800 Mbit/s
2. For video ports on discrete graphics, please see graphics section

Monitor Cable

Monitor Cable***

- VGA Cable Tiny
- DP to dual DP dongle
- DP to DVI-D dongle
- DP to HDMI 1.4 dongle
- DP to VGA cable (1.5M)
- DP to VGA dongle
- HDMI to VGA dongle
- No monitor cable

SECURITY & PRIVACY

Security

Security Chip

Discrete TPM 2.0, TCG certified

Physical Locks

Kensington® Security Slot

Chassis Intrusion Switch

Chassis intrusion switch

Fingerprint Reader

- Touch style fingerprint reader on mouse
- No fingerprint reader

BIOS Security

- Administrator password
- Power-on password
- Hard disk password
- Boot sequence control
- Boot without keyboard and mouse
- Smart USB protection (allows keyboard / mouse only, blocks all storage devices)
- Individual USB port disablement

MANAGEABILITY

System Management

System Management^[1]

- Intel vPro with Intel AMT 12.0
- None

Notes:

1. Require choosing a vPro-support Wi-Fi adapter to enable vPro function through wireless connection

SERVICE

Warranty

Base Warranty**

- 1-year depot service
- 1-year limited onsite service
- 3-year depot service
- 3-year limited onsite service
- 3-year split limited onsite service
- No base warranty

ENVIRONMENTAL

Operating Environment

Temperature

- Operating: 5°C (41°F) to 35°C (95°F)
- Storage: -40°C (-40°F) to 60°C (140°F)

Humidity

- Operating: 20% to 80%
- Storage: 10% to 90%

Altitude

- Operating: -15.2 m (-50 ft) to 3048 m (10,000 ft)
- Storage: -15.2 m (-50 ft) to 12192 m (40,000 ft)

CERTIFICATIONS

Green Certifications

Green Certifications

- (Optional) EPEAT™ Gold
- (Optional) EPEAT Silver
- ENERGY STAR® 8.0
- ErP Lot 3
- TCO
- RoHS compliant

Other Certifications

Other Certifications

(Optional) TÜV Rheinland® Low Noise

Mil-Spec Test

MIL-STD-810G military test passed (Low Pressure [Altitude], High Temperature, Low Temperature, Temperature Shock, Humidity, Sand and Dust, Vibration, Shock, Fungus, Solar Radiation)

- Feature with ** means that only one offering listed under the feature is configured on selected models.
- Feature with *** means that one or more offerings listed under the feature could be configured on selected models.
- Lenovo reserves the right to change specifications or other product information without notice. Lenovo is not responsible for photographic or typographical errors. LENOVO PROVIDES THIS PUBLICATION "AS IS," WITHOUT WARRANTY OF ANY KIND, EITHER EXPRESS OR IMPLIED, INCLUDING THE IMPLIED WARRANTIES OF MERCHANTABILITY OR FITNESS FOR A PARTICULAR PURPOSE. Some jurisdictions do not allow disclaimer of express or implied warranties in certain transactions, therefore this disclaimer may not apply to

you.

- The specifications on this page may not be available in all regions, and may be changed or updated without notice.



OVERVIEW

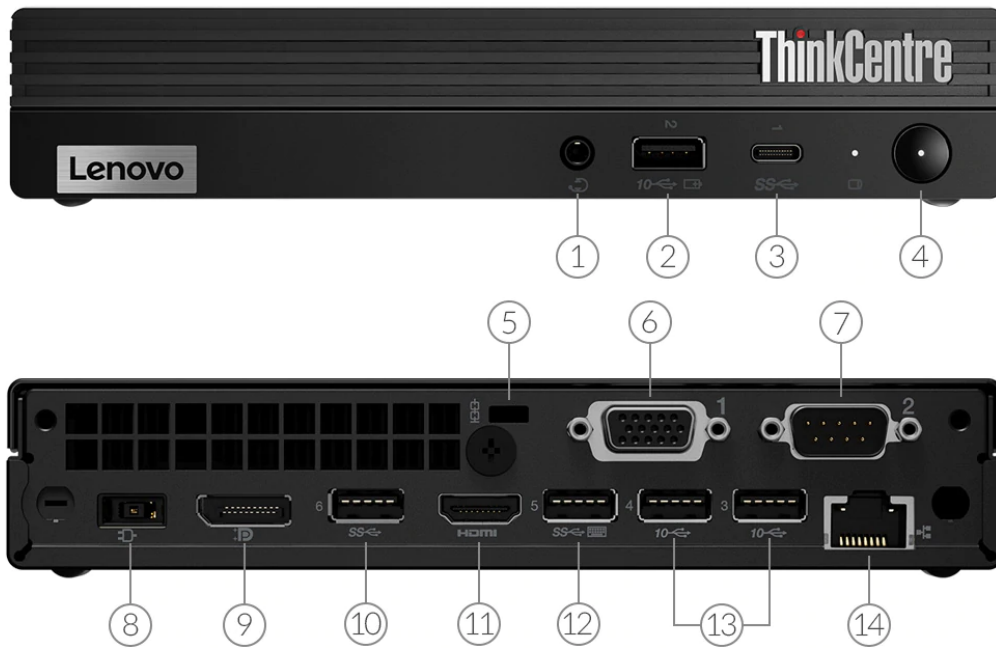

1. Headphone / microphone combo jack (3.5mm)	8. Power connector
2. USB 3.2 Gen 2	9. DisplayPort
3. USB-C 3.2 Gen 1	10. USB 3.2 Gen 2
4. Power button	11. HDMI
5. Kensington Security Slot	12. USB 3.2 Gen 2
6. Optional port 1 (VGA is shown)	13. 2x USB 3.2 Gen 1
7. Optional port 2 (serial is shown)	14. Ethernet (RJ-45)

ThinkSmart Edition Tiny M80q

PERFORMANCE

Processor

Processor Family

10th Generation Intel® Core™ i5 Processor

Processor

Processor Name	Cores	Threads	Base Frequency	Max Frequency	Cache	Memory Support	Processor Graphics
Core i5-10500T	6	12	2.3GHz	3.8GHz	12MB	DDR4-2666	Intel UHD Graphics 630

Operating System

Operating System

Windows® 10 IoT Enterprise SAC 64 with Intel Unite

Graphics

Graphics^[1]

Graphics	Type	Memory	Connector	Max Resolution	Key Features
Intel UHD graphics 630	Integrated	Shared	1x HDMI®, 1x DP	4096x2160@24Hz(onboard HDMI), 4096x2304@60Hz(DP)	DirectX® 12

Notes:

1. The information of integrated graphics are not applicable for the models without integrated graphics (for the details, please refer to processor section)

Monitor Support

Monitor Support

Supports up to 3 independent displays via (onboard DP, onboard HDMI, and one optional port [VGA / 2nd DP / 2nd HDMI / USB-C]) or (one onboard port [DP / HDMI] and optional dual DP [MST mode])

Chipset

Chipset

Intel Q470 chipset

Memory

Max Memory^[1]

Up to 16GB DDR4-2666

Memory Slots

Two DDR4 SO-DIMM slots, dual-channel capable

Memory Type

DDR4-2666

Notes:

1. The max memory is based on the test results with current Lenovo® memory offerings. The system may support more memory as the technology develops.

Storage

Storage Support

One drive, up to 256GB M.2 2280 SSD

Storage Type**

Disk Type	Interface	RPM	Security
M.2 2242 SSD	PCIe NVMe, PCIe 3.0 x2	-	-
M.2 2280 SSD	PCIe NVMe, PCIe 3.0 x4	-	Opal

RAID

No support

Removable Storage

Optical

None

Multi-Media

Audio Chip

High Definition (HD) Audio, Realtek® ALC233VB codec

Speakers

Single speaker, 1.5W x1

Power Supply

Power Supply

Power	Type	Efficiency	Key Features
135W	Adapter	89%	Autosensing

DESIGN

Input Device

Keyboard

- Lenovo Traditional Keyboard (USB connector), black
- No keyboard

Mouse

- USB Calliope Mouse, black
- No mouse

Mechanical

Form Factor

Tiny (1L)

Dimensions (WxDxH)

Models	Dimensions
Tiny only	179 x 183 x 34.5 / 37 mm with rubber feet (7.05 x 7.2 x 1.36 / 1.5 inches with rubber feet)

Weight

Models	Weight
Tiny only	1.25 kg (2.76 lbs)

Case Color

Black

Bays

No bays

Expansion Slots

Two M.2 slots (one for WLAN, one for SSD)

EOU

No support

Stand

- Vertical stand
- No stand

IO Box

No IO box

Mounting

- VESA mount bracket kit, supports VESA mount 75mm and 100mm

- None

CONNECTIVITY

Network

Onboard Ethernet

Gigabit Ethernet, Intel Ethernet Connection I219-LM, 1x RJ45, supports Wake-on-LAN

Optional Ethernet

No optional Ethernet

WLAN + Bluetooth®

- Intel Wi-Fi® 6 AX201, 802.11ax 2x2 Wi-Fi + Bluetooth 5.1, Intel vPro technology support, M.2 Card
- No WLAN and Bluetooth

Ports^[1]

Front Ports

- 1x USB 3.2 Gen 2 (Always On and fast charge)
- 1x USB-C 3.2 Gen 1
- 1x headphone / microphone combo jack (3.5mm)

Optional Front Ports

None

Rear Ports^[2]

- 2x USB 3.2 Gen 1
- 2x USB 3.2 Gen 2
- 1x HDMI
- 1x DisplayPort™
- 1x Ethernet (RJ-45)

Optional Rear Ports

1x USB-C 3.2 Gen 1

Notes:

1. The transfer speed of following ports will vary and, depending on many factors, such as the processing speed of the host device, file attributes and other factors related to system configuration and your operating environment, will be slower than theoretical speed.
USB 2.0: 480 Mbit/s;
USB 3.2 Gen 1 (SuperSpeed USB 5Gbps, formerly USB 3.0 / USB 3.1 Gen 1): 5 Gbit/s;
USB 3.2 Gen 2 (SuperSpeed USB 10Gbps, formerly USB 3.1 Gen 2): 10 Gbit/s;
USB 3.2 Gen 2x2 (SuperSpeed USB 20Gbps): 20 Gbit/s;
Thunderbolt™ 3: 40 Gbit/s;
FireWire 400: 400 Mbit/s;
FireWire 800: 800 Mbit/s
2. For video ports on discrete graphics, please see graphics section

Monitor Cable

Monitor Cable

No monitor cable

SECURITY & PRIVACY

Security

Security Chip

Discrete TPM 2.0, TCG certified

Physical Locks

Kensington® Security Slot

Chassis Intrusion Switch

Chassis intrusion switch

Fingerprint Reader

No fingerprint reader

BIOS Security

- Administrator password
- Power-on password
- Hard disk password
- Boot sequence control
- Boot without keyboard and mouse
- Smart USB protection (allows keyboard / mouse only, blocks all storage devices)
- Individual USB port disablement

MANAGEABILITY

System Management

System Management

Intel vPro with Intel AMT 14.0

SERVICE

Warranty

Base Warranty**

- 1-year depot service
- 1-year limited onsite service
- 3-year limited onsite service

ENVIRONMENTAL

Operating Environment

Temperature

- Operating: 5°C (41°F) to 35°C (95°F)
- Storage: -40°C (-40°F) to 60°C (140°F)

Humidity

- Operating: 20% to 80%
- Storage: 10% to 90%

Altitude

- Operating: -15.2 m (-50 ft) to 3048 m (10,000 ft)
- Storage: -15.2 m (-50 ft) to 12192 m (40,000 ft)

CERTIFICATIONS

Green Certifications

Green Certifications

- ENERGY STAR® 8.0
- ErP Lot 3
- TCO Certified 8.0
- RoHS compliant

Other Certifications

Mil-Spec Test

MIL-STD-810H military test passed (Low Pressure [Altitude], High Temperature, Low Temperature, Temperature Shock, Humidity, Sand and Dust, Vibration, Shock, Fungus, Solar Radiation)

- Feature with ** means that only one offering listed under the feature is configured on selected models.

- Lenovo reserves the right to change specifications or other product information without notice. Lenovo is not responsible for photographic or typographical errors. LENOVO PROVIDES THIS PUBLICATION “AS IS,” WITHOUT WARRANTY OF ANY KIND, EITHER EXPRESS OR IMPLIED, INCLUDING THE IMPLIED WARRANTIES OF MERCHANTABILITY OR FITNESS FOR A PARTICULAR PURPOSE. Some jurisdictions do not allow disclaimer of express or implied warranties in certain transactions, therefore this disclaimer may not apply to you.
- The specifications on this page may not be available in all regions, and may be changed or updated without notice.

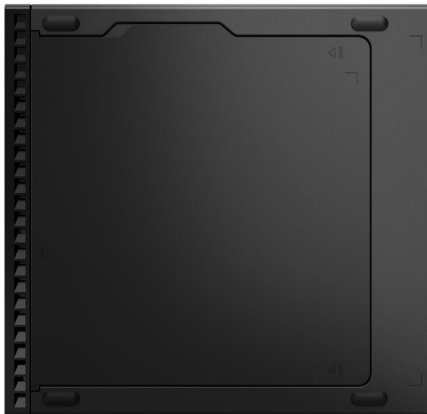
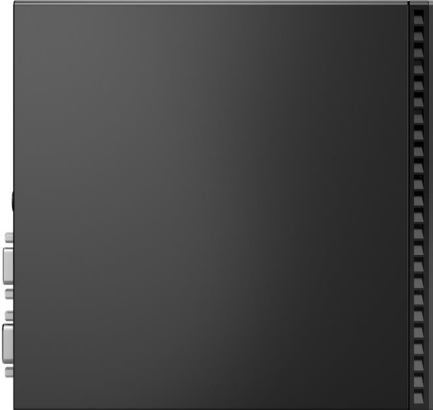

OVERVIEW

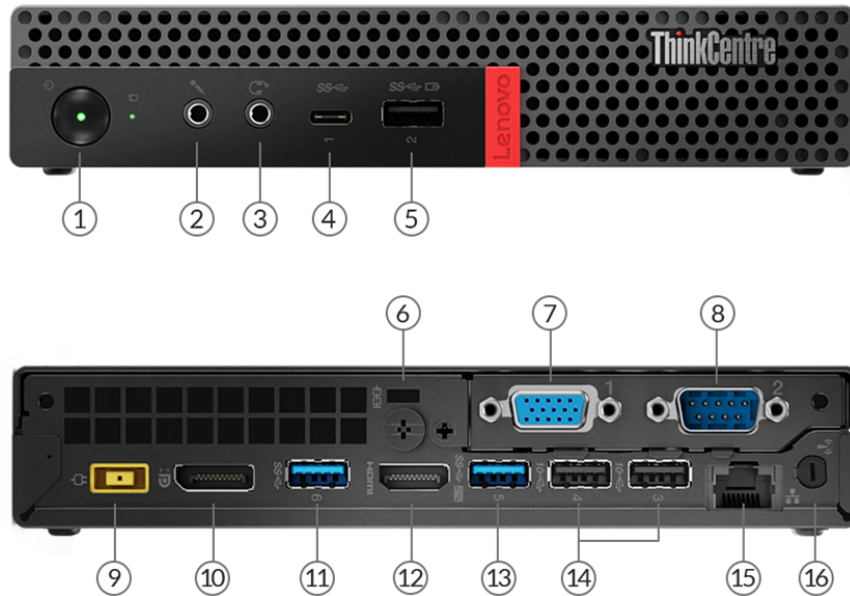

1. Power button	9. Power connector
2. Microphone (3.5mm)	10. DisplayPort
3. Headphone / microphone combo jack (3.5mm)	11. USB 3.1 Gen 1
4. USB-C 3.1 Gen 1	12. HDMI
5. USB 3.1 Gen 1	13. USB 3.1 Gen 1
6. Kensington Security Slot	14. 2x USB 3.1 Gen 2
7. Optional port 1 (VGA is shown) *	15. Ethernet (RJ-45)
8. Optional port 2 (serial is shown) *	16. Wi-Fi antenna *

Notes:

- Ports with * are only available on selected models

PERFORMANCE

Processor

Processor Family

9th Generation Intel® Core™ i5 Processor

Processor

Processor Name	Cores	Threads	Base Frequency	Max Frequency	Cache	Memory Support	Processor Graphics
Core i5-9600T	6	6	2.3GHz	3.9GHz	9MB	DDR4-2666	Intel UHD Graphics 630

Operating System

Operating System

Windows® 10 IoT Enterprise with Microsoft® Teams room for Logitech

Graphics

Graphics^[1]

Graphics	Type	Memory	Connector	Max Resolution	Key Features
Intel UHD graphics 630	Integrated	Shared	1x HDMI®, 1x 2nd HDMI (internal DP to HDMI dongle), 1x DP	4096x2160@24Hz(onboard HDMI), 4096x2304@60Hz(DP)	DirectX® 12

Notes:

- The information of integrated graphics are not applicable for the models without integrated graphics (for the details, please refer to processor section)

Monitor Support

Monitor Support

Supports up to 3 independent displays via (2x HDMI and DP)

Chipset

Chipset

Intel Q370 chipset

Memory

Max Memory^[1]

Up to 8GB DDR4-2666

Memory Slots

Two DDR4 SO-DIMM slots, dual-channel capable

Memory Type

DDR4-2666

Notes:

- The max memory is based on the test results with current Lenovo® memory offerings. The system may support more memory as the technology develops.

Storage

Storage Support

One drive, 128GB M.2 2242 SSD

Storage Type

Disk Type	Interface	RPM	Security
M.2 2242 SSD	PCIe NVMe, PCIe 3.0 x2	-	-

RAID

No support

Removable Storage

Optical

None

Card Reader

No card reader

Multi-Media

Audio Chip

High Definition (HD) Audio, Realtek® ALC233VB2 codec

Speakers

Single speaker, 1.5W x1

Power Supply

Power Supply

Power	Type	Efficiency	Key Features
135W	Adapter	88%	Autosensing

DESIGN

Input Device

Keyboard

No keyboard

Mouse

No mouse

Mechanical

Form Factor

Tiny (1L)

Dimensions (WxDxH)

Models	Dimensions
All models	179 x 183 x 34.5 / 37 mm with rubber feet (7.05 x 7.2 x 1.36 / 1.5 inches with rubber feet)

Weight

Models	Weight
All models	1.32 kg (2.91 lbs)

Case Color

Black

Bays

No bays

Expansion Slots

Two M.2 slots (one for WLAN, one for SSD)

EOU

No support

Stand

No stand

IO Box

No IO box

Mounting

VESA mount bracket kit, supports VESA mount 75mm and 100mm

Others

Power adapter cage

CONNECTIVITY

Network

Onboard Ethernet

Gigabit Ethernet, Intel Ethernet Connection I219-LM, 1x RJ45, supports Wake-on-LAN

WLAN + Bluetooth®

Intel Wireless-AC 9560, 802.11ac Dual Band 2x2 Wi-Fi® + Bluetooth 5.0, Intel vPro technology support, M.2 card

Ports^[1]

Front Ports

- 1x USB 3.1 Gen 1 (Always On and fast charge)
- 1x USB-C 3.1 Gen 1
- 1x headphone / microphone combo jack (3.5mm)
- 1x microphone (3.5mm)

Optional Front Ports

None

Rear Ports^[2]

- 2x USB 3.1 Gen 1
- 2x USB 3.1 Gen 2
- 2x HDMI
- 1x DisplayPort™
- 1x Ethernet (RJ-45)

Optional Rear Ports

None

Notes:

1. The transfer speed of following ports will vary and, depending on many factors, such as the processing speed of the host device, file attributes and other factors related to system configuration and your operating environment, will be slower than theoretical speed.
USB 2.0: 480 Mbit/s;
USB 3.2 Gen 1 (SuperSpeed USB 5Gbps, formerly USB 3.0 / USB 3.1 Gen 1): 5 Gbit/s;
USB 3.2 Gen 2 (SuperSpeed USB 10Gbps, formerly USB 3.1 Gen 2): 10 Gbit/s;
USB 3.2 Gen 2x2 (SuperSpeed USB 20Gbps): 20 Gbit/s;
Thunderbolt™ 3: 40 Gbit/s;
FireWire 400: 400 Mbit/s;
FireWire 800: 800 Mbit/s
2. For video ports on discrete graphics, please see graphics section

Monitor Cable

Monitor Cable

No monitor cable

SECURITY & PRIVACY

Security

Security Chip

Discrete TPM 2.0, TCG certified

Physical Locks

Kensington® Security Slot

Chassis Intrusion Switch

Chassis intrusion switch

Fingerprint Reader

No fingerprint reader

BIOS Security

- Administrator password

- Power-on password
- Hard disk password
- Boot sequence control
- Boot without keyboard and mouse
- Smart USB protection (allows keyboard / mouse only, blocks all storage devices)
- Individual USB port disablement

MANAGEABILITY

System Management

System Management

Intel vPro with Intel AMT 12.0

SERVICE

Warranty

Base Warranty

3-year premier support service

ENVIRONMENTAL

Operating Environment

Temperature

- Operating: 5°C (41°F) to 35°C (95°F)
- Storage: -40°C (-40°F) to 60°C (140°F)

Humidity

- Operating: 20% to 80%
- Storage: 10% to 90%

Altitude

- Operating: -15.2 m (-50 ft) to 3048 m (10,000 ft)
- Storage: -15.2 m (-50 ft) to 12192 m (40,000 ft)

CERTIFICATIONS

Green Certifications

Green Certifications

- EPEAT™ Gold
- ENERGY STAR® 8.0
- ErP Lot 3
- TCO
- RoHS compliant

Other Certifications

Mil-Spec Test

MIL-STD-810G military test passed (Low Pressure [Altitude], High Temperature, Low Temperature, Temperature Shock, Humidity, Sand and Dust, Vibration, Shock, Fungus, Solar Radiation)

- Lenovo reserves the right to change specifications or other product information without notice. Lenovo is not responsible for photographic or typographical errors. LENOVO PROVIDES THIS PUBLICATION “AS IS,” WITHOUT WARRANTY OF ANY KIND, EITHER EXPRESS OR IMPLIED, INCLUDING THE IMPLIED WARRANTIES OF MERCHANTABILITY OR FITNESS FOR A PARTICULAR PURPOSE. Some jurisdictions do not allow

disclaimer of express or implied warranties in certain transactions, therefore this disclaimer may not apply to you.

- The specifications on this page may not be available in all regions, and may be changed or updated without notice.

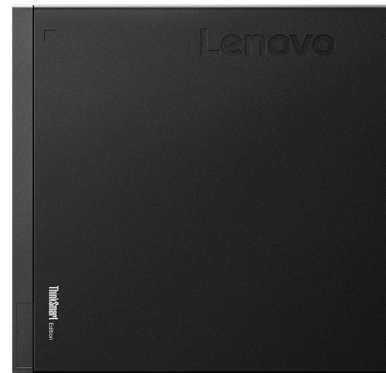

OVERVIEW

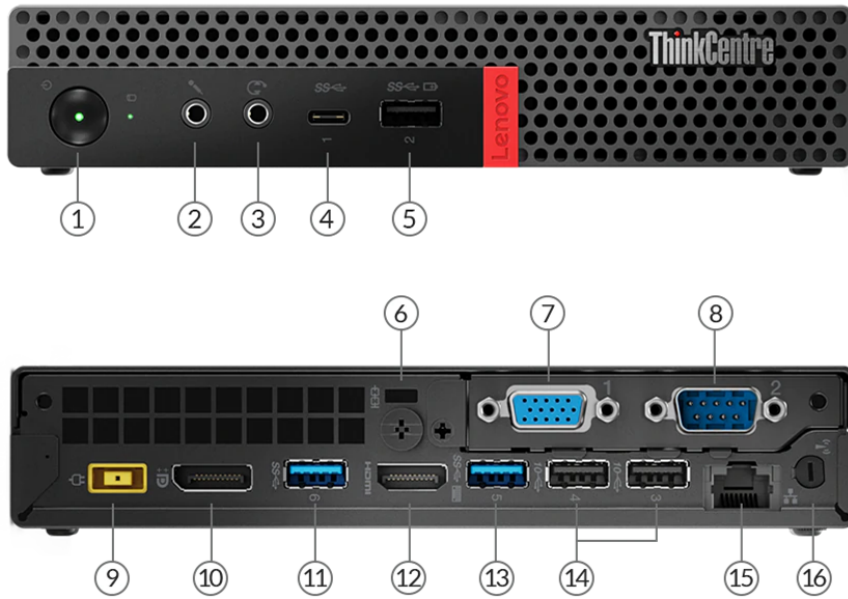

1. Power button	9. Power connector
2. Microphone (3.5mm)	10. DisplayPort
3. Headphone / microphone combo jack (3.5mm)	11. USB 3.1 Gen 1
4. USB-C 3.1 Gen 1	12. HDMI
5. USB 3.1 Gen 1	13. USB 3.1 Gen 1
6. Kensington Security Slot	14. 2x USB 3.1 Gen 2
7. Optional port 1 (VGA is shown) *	15. Ethernet (RJ-45)
8. Optional port 2 (serial is shown) *	16. Wi-Fi antenna *

Notes:

- Ports with * are only available on selected models

PERFORMANCE

Processor

Processor Family

9th Generation Intel® Core™ i5 Processor

Processor

Processor Name	Cores	Threads	Base Frequency	Max Frequency	Cache	Memory Support	Processor Graphics
Core i5-9600T	6	6	2.3GHz	3.9GHz	9MB	DDR4-2666	Intel UHD Graphics 630

Operating System

Operating System

Windows® 10 IoT Enterprise with Microsoft® Teams room for Poly

Graphics

Graphics^[1]

Graphics	Type	Memory	Connector	Max Resolution	Key Features
Intel UHD graphics 630	Integrated	Shared	1x HDMI®, 1x 2nd HDMI (internal DP to HDMI dongle), 1x DP	4096x2160@24Hz(onboard HDMI), 4096x2304@60Hz(DP)	DirectX® 12

Notes:

- The information of integrated graphics are not applicable for the models without integrated graphics (for the details, please refer to processor section)

Monitor Support

Monitor Support

Supports up to 3 independent displays via (2x HDMI and DP)

Chipset

Chipset

Intel Q370 chipset

Memory

Max Memory^[1]

Up to 8GB DDR4-2666

Memory Slots

Two DDR4 SO-DIMM slots, dual-channel capable

Memory Type

DDR4-2666

Notes:

- The max memory is based on the test results with current Lenovo® memory offerings. The system may support more memory as the technology develops.

Storage

Storage Support

One drive, 128GB M.2 2242 SSD

Storage Type

Disk Type	Interface	RPM	Security
M.2 2242 SSD	PCIe NVMe, PCIe 3.0 x2	-	-

RAID

No support

Removable Storage

Optical

None

Card Reader

No card reader

Multi-Media

Audio Chip

High Definition (HD) Audio, Realtek® ALC233VB2 codec

Speakers

Single speaker, 1.5W x1

Power Supply

Power Supply

Power	Type	Efficiency	Key Features
135W	Adapter	88%	Autosensing

DESIGN

Input Device

Keyboard

No keyboard

Mouse

No mouse

Mechanical

Form Factor

Tiny (1L)

Dimensions (WxDxH)

Models	Dimensions
All models	179 x 183 x 34.5 / 37 mm with rubber feet (7.05 x 7.2 x 1.36 / 1.5 inches with rubber feet)

Weight

Models	Weight
All models	1.32 kg (2.91 lbs)

Case Color

Black

Bays

No bays

Expansion Slots

Two M.2 slots (one for WLAN, one for SSD)

EOU

No support

Stand

No stand

IO Box

No IO box

Mounting

VESA mount bracket kit, supports VESA mount 75mm and 100mm

Others

Power adapter cage

CONNECTIVITY

Network

Onboard Ethernet

Gigabit Ethernet, Intel Ethernet Connection I219-LM, 1x RJ45, supports Wake-on-LAN

WLAN + Bluetooth®

Intel Wireless-AC 9560, 802.11ac Dual Band 2x2 Wi-Fi® + Bluetooth 5.0, Intel vPro technology support, M.2 card

Ports^[1]

Front Ports

- 1x USB 3.1 Gen 1 (Always On and fast charge)
- 1x USB-C 3.1 Gen 1
- 1x headphone / microphone combo jack (3.5mm)
- 1x microphone (3.5mm)

Optional Front Ports

None

Rear Ports^[2]

- 2x USB 3.1 Gen 1
- 2x USB 3.1 Gen 2
- 2x HDMI
- 1x DisplayPort™
- 1x Ethernet (RJ-45)

Optional Rear Ports

None

Notes:

1. The transfer speed of following ports will vary and, depending on many factors, such as the processing speed of the host device, file attributes and other factors related to system configuration and your operating environment, will be slower than theoretical speed.
USB 2.0: 480 Mbit/s;
USB 3.2 Gen 1 (SuperSpeed USB 5Gbps, formerly USB 3.0 / USB 3.1 Gen 1): 5 Gbit/s;
USB 3.2 Gen 2 (SuperSpeed USB 10Gbps, formerly USB 3.1 Gen 2): 10 Gbit/s;
USB 3.2 Gen 2x2 (SuperSpeed USB 20Gbps): 20 Gbit/s;
Thunderbolt™ 3: 40 Gbit/s;
FireWire 400: 400 Mbit/s;
FireWire 800: 800 Mbit/s
2. For video ports on discrete graphics, please see graphics section

Monitor Cable

Monitor Cable

No monitor cable

SECURITY & PRIVACY

Security

Security Chip

Discrete TPM 2.0, TCG certified

Physical Locks

Kensington® Security Slot

Chassis Intrusion Switch

Chassis intrusion switch

Fingerprint Reader

No fingerprint reader

BIOS Security

- Administrator password

- Power-on password
- Hard disk password
- Boot sequence control
- Boot without keyboard and mouse
- Smart USB protection (allows keyboard / mouse only, blocks all storage devices)
- Individual USB port disablement

MANAGEABILITY

System Management

System Management

Intel vPro with Intel AMT 12.0

SERVICE

Warranty

Base Warranty

Please consult with Poly

ENVIRONMENTAL

Operating Environment

Temperature

- Operating: 5°C (41°F) to 35°C (95°F)
- Storage: -40°C (-40°F) to 60°C (140°F)

Humidity

- Operating: 20% to 80%
- Storage: 10% to 90%

Altitude

- Operating: -15.2 m (-50 ft) to 3048 m (10,000 ft)
- Storage: -15.2 m (-50 ft) to 12192 m (40,000 ft)

CERTIFICATIONS

Green Certifications

Green Certifications

- EPEAT™ Gold
- ENERGY STAR® 8.0
- ErP Lot 3
- TCO
- RoHS compliant

Other Certifications

Mil-Spec Test

MIL-STD-810G military test passed (Low Pressure [Altitude], High Temperature, Low Temperature, Temperature Shock, Humidity, Sand and Dust, Vibration, Shock, Fungus, Solar Radiation)

- Lenovo reserves the right to change specifications or other product information without notice. Lenovo is not responsible for photographic or typographical errors. LENOVO PROVIDES THIS PUBLICATION “AS IS,” WITHOUT WARRANTY OF ANY KIND, EITHER EXPRESS OR IMPLIED, INCLUDING THE IMPLIED WARRANTIES OF MERCHANTABILITY OR FITNESS FOR A PARTICULAR PURPOSE. Some jurisdictions do not allow

disclaimer of express or implied warranties in certain transactions, therefore this disclaimer may not apply to you.

- The specifications on this page may not be available in all regions, and may be changed or updated without notice.

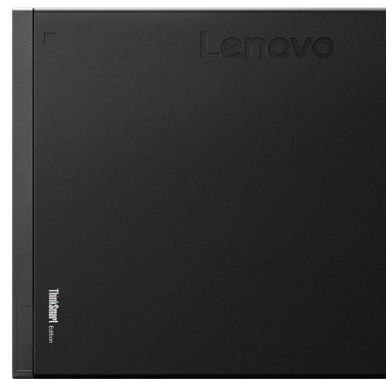

OVERVIEW

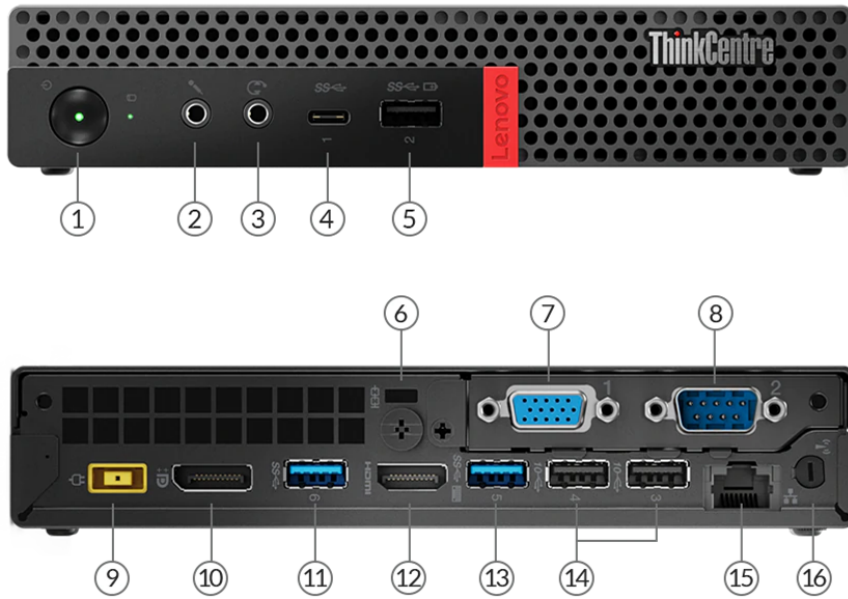

1. Power button	9. Power connector
2. Microphone (3.5mm)	10. DisplayPort
3. Headphone / microphone combo jack (3.5mm)	11. USB 3.1 Gen 1
4. USB-C 3.1 Gen 1	12. HDMI
5. USB 3.1 Gen 1	13. USB 3.1 Gen 1
6. Kensington Security Slot	14. 2x USB 3.1 Gen 2
7. Optional port 1 (VGA is shown) *	15. Ethernet (RJ-45)
8. Optional port 2 (serial is shown) *	16. Wi-Fi antenna *

Notes:

- Ports with * are only available on selected models

PERFORMANCE

Processor

Processor Family

9th Generation Intel® Core™ i7 Processor

Processor

Processor Name	Cores	Threads	Base Frequency	Max Frequency	Cache	Memory Support	Processor Graphics
Core i7-9700T	8	8	2.0GHz	4.3GHz	12MB	DDR4-2666	Intel UHD Graphics 630

Operating System

Operating System

Windows® 10 IoT Enterprise with Zoom Rooms preload

Graphics

Graphics^[1]

Graphics	Type	Memory	Connector	Max Resolution	Key Features
Intel UHD graphics 630	Integrated	Shared	2x HDMI® (one onboard HDMI, one HDMI via internal DP to HDMI dongle), 1x DP	4096x2160@24Hz(onboard HDMI), 4096x2304@60Hz(DP)	DirectX® 12

Notes:

1. The information of integrated graphics are not applicable for the models without integrated graphics (for the details, please refer to processor section)

Monitor Support

Monitor Support

Supports up to 3 independent displays via onboard ports (DisplayPort™ + 2x HDMI)

Chipset

Chipset

Intel Q370 chipset

Memory

Max Memory^[1]

Up to 16GB DDR4-2666

Memory Slots

Two DDR4 SO-DIMM slots, dual-channel capable

Memory Type

DDR4-2666

Notes:

1. The max memory is based on the test results with current Lenovo® memory offerings. The system may support more memory as the technology develops.

Storage

Storage Support

One drive, 128GB M.2 2242 SSD

Storage Type

Disk Type	Interface	RPM	Security
M.2 2242 SSD	PCIe NVMe, PCIe 3.0 x2	-	-

RAID

No support

Removable Storage

Optical**

- DVD-ROM, slim (9.0mm), via USB external ODD box
- DVD burner (DVD±RW), slim (9.0mm), via USB external ODD box
- None

Card Reader

No card reader

Multi-Media

Audio Chip

High Definition (HD) Audio, Realtek® ALC233VB2 codec

Speakers**

- Single speaker, 1.5W x1
- Single speaker, 2W x1

Power Supply

Power Supply**

Power	Type	Efficiency	Key Features
65W	Adapter	88%	Autosensing
90W	Adapter	88%	Autosensing
135W	Adapter	88%	Autosensing
No power supply	-	-	-

DESIGN

Input Device

Keyboard**

- Lenovo Calliope Wireless Keyboard (2.4GHz via USB receiver), black
- Lenovo Traditional Keyboard (USB connector), black
- No keyboard

Mouse**

- Lenovo Calliope Mouse (USB connector), black
- Lenovo Calliope Wireless Mouse (2.4GHz via USB receiver), black
- Lenovo Fingerprint Mouse (USB connector), Windows Hello support, black
- No mouse

Mechanical

Form Factor

Tiny (1L)

Dimensions (WxDxH)

Models	Dimensions
All models	179 x 183 x 34.5 / 37 mm with rubber feet (7.05 x 7.2 x 1.36 / 1.5 inches with rubber feet)

Weight

Models	Weight
All models	1.32 kg (2.91 lbs)

Case Color

Black

Bays

No bays

Expansion Slots

Two M.2 slots (one for WLAN, one for SSD)

EOU

No support

Stand

- Vertical stand
- No stand

Mounting

- VESA mount bracket kit, supports VESA mount 75mm and 100mm
- None

Others

- (Optional) Dust filter
- (Optional) Power adapter cage

CONNECTIVITY

Network

Onboard Ethernet

Gigabit Ethernet, Intel Ethernet Connection I219-LM, 1x RJ45, supports Wake-on-LAN

Optional Ethernet

No optional Ethernet

WLAN + Bluetooth®

Intel Wireless-AC 9560, 802.11ac Dual Band 2x2 Wi-Fi® + Bluetooth 5.0, Intel vPro technology support, M.2 card

Ports^[1]

Front Ports

- 1x USB 3.1 Gen 1 (Always On and fast charge)
- 1x USB-C 3.1 Gen 1
- 1x headphone / microphone combo jack (3.5mm)
- 1x microphone (3.5mm)

Optional Front Ports

None

Rear Ports^[2]

- 2x USB 3.1 Gen 1
- 2x USB 3.1 Gen 2
- 2x HDMI
- 1x DisplayPort
- 1x Ethernet (RJ-45)

Notes:

1. The transfer speed of following ports will vary and, depending on many factors, such as the processing speed of the host device, file attributes and other factors related to system configuration and your operating environment, will be slower than theoretical speed.
USB 2.0: 480 Mbit/s;
USB 3.2 Gen 1 (SuperSpeed USB 5Gbps, formerly USB 3.0 / USB 3.1 Gen 1): 5 Gbit/s;
USB 3.2 Gen 2 (SuperSpeed USB 10Gbps, formerly USB 3.1 Gen 2): 10 Gbit/s;
USB 3.2 Gen 2x2 (SuperSpeed USB 20Gbps): 20 Gbit/s;
Thunderbolt™ 3: 40 Gbit/s;
FireWire 400: 400 Mbit/s;
FireWire 800: 800 Mbit/s
2. For video ports on discrete graphics, please see graphics section

Monitor Cable

Monitor Cable

No monitor cable

SECURITY & PRIVACY

Security

Security Chip

Discrete TPM 2.0, TCG certified

Physical Locks

Kensington® Security Slot

Chassis Intrusion Switch

Chassis intrusion switch

Fingerprint Reader

No fingerprint reader

BIOS Security

- Administrator password
- Power-on password
- Hard disk password
- Boot sequence control
- Boot without keyboard and mouse
- Smart USB protection (allows keyboard / mouse only, blocks all storage devices)
- Individual USB port disablement

MANAGEABILITY

System Management

System Management^[1]

Intel vPro with Intel AMT 12.0

Notes:

1. Require choosing a vPro-support Wi-Fi adapter to enable vPro function through wireless connection

SERVICE

Warranty

Base Warranty

3-year limited onsite service

ENVIRONMENTAL

Operating Environment

Temperature

- Operating: 5°C (41°F) to 35°C (95°F)
- Storage: -40°C (-40°F) to 60°C (140°F)

Humidity

- Operating: 20% to 80%
- Storage: 10% to 90%

Altitude

- Operating: -15.2 m (-50 ft) to 3048 m (10,000 ft)
- Storage: -15.2 m (-50 ft) to 12192 m (40,000 ft)

CERTIFICATIONS

Green Certifications

Green Certifications

- EPEAT™ Silver
- ENERGY STAR® 8.0
- ErP Lot 3
- TCO

- RoHS compliant

Other Certifications

Mil-Spec Test

MIL-STD-810G military test passed (Low Pressure [Altitude], High Temperature, Low Temperature, Temperature Shock, Humidity, Sand and Dust, Vibration, Shock, Fungus, Solar Radiation)

- Feature with ** means that only one offering listed under the feature is configured on selected models.
- Lenovo reserves the right to change specifications or other product information without notice. Lenovo is not responsible for photographic or typographical errors. LENOVO PROVIDES THIS PUBLICATION “AS IS,” WITHOUT WARRANTY OF ANY KIND, EITHER EXPRESS OR IMPLIED, INCLUDING THE IMPLIED WARRANTIES OF MERCHANTABILITY OR FITNESS FOR A PARTICULAR PURPOSE. Some jurisdictions do not allow disclaimer of express or implied warranties in certain transactions, therefore this disclaimer may not apply to you.
- The specifications on this page may not be available in all regions, and may be changed or updated without notice.

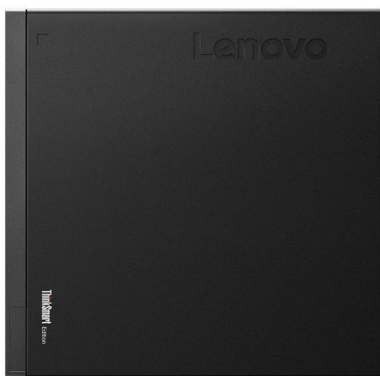

PERFORMANCE

Panel

Panel

In-Plane Switching (IPS)

Display Size

21.5 inches (546.1mm)

Max View Area

WxH: 476.1 x 267.8 mm (18.74 x 10.54 inches)

Native Resolution

1920x1080

Aspect Ratio

16:9

Pixel Pitch

0.24795 x 0.24795 mm

DPI

102.4 dpi

Brightness

250 nits

Contrast Ratio

1000:1

Pixel Response Time

4 ms (extreme mode) / 6 ms (typical mode) / 14 ms (off mode)

Color Gamut

72% NTSC

Viewing Angle

Horizontal: +/- 89°, vertical: +/- 89°

Anti-glare

Anti-glare

Multi-Media

Camera

720p, with dual microphone and LED indicator

Microphone

Dual array microphone

Speakers

Stereo speakers, 2W x2

Power Supply

Power Supply

Power	Type	Efficiency	Key Features
90W	Adapter	88%	-

Power Consumption

19 watts typical, 32 watts max

DESIGN

Menu

Presets and User Settings

- Presets: 25

ThinkCentre Tiny-In-One 22 Gen 3

- User settings: 25

On Screen Display

On screen display with digital user controls (8 languages)

Display

Touchscreen

(Optional)10-point multi-touch, supports Wake on Touch. ONLY for model 10R0PAT1 and 10R0PAR1.

Mechanical

Compatible Tiny

P330 / P320 / M920(x) / M720 / M910(x) / M710 / M900(x) / M700 / M630e / M625 / M600 / M75q / M715 / M93p / M83 / M73 / M53 / Chromebox Tiny

Bezel Width

- Top / side: 2mm
- Bottom: 22.1mm

Buttons

- Power button
- Exit button
- Menu button
- Mode-switching button
- Brightness button

Cables

Undetachable 3-in-1 cable (power connector, USB [supports USB 3.1 Gen 1 / USB 2.0], DisplayPort™)

Case Color

Black

Dimensions (WxDxH)

Models	Dimensions
Models without stand	489 x 72.5 x 339 mm (19.26 x 2.85 x 13.35 inches)
Models with full function monitor stand	489.3 x 273.3 x 370.7 mm (19.26 x 10.76 x 14.59 inches)

Weight

Models	Weight
Models without stand	3.19 kg (7.01 lbs)
Models with full function monitor stand	5.34 kg (11.77 lbs)

Mounting

Supports VESA mount 100mm

Stand

Full function monitor stand, supports -5° to +30° tilt, left & right 45° swivel, up to 150mm lift, -5° to +90° pivot

In the Box

- TIO (monitor)
- Detachable stand
- Driver CD
- Power adapter
- Power cord
- Quick start and safety poster
- User's guide

CONNECTIVITY

Ports

Rear Ports

- 1x USB upstream port
- 1x DisplayPort
- 1x power connector

Left Ports^[1]

- 1x USB 3.1 Gen 1 (on TIO)
- Side ports offered by installed Tiny (on Tiny)

Notes:

1. The availability and version depends on the Tiny installed or the PC connected via USB upstream port

SERVICE

Warranty

Base Warranty

3-year customer carry-in or mail-in via rapid replacement service

CERTIFICATIONS

Green Certifications

Green Certifications

- EPEAT™ Silver
- ENERGY STAR® 8.0
- TCO Certified 7.0
- TCO edge 2.0
- TUV
- ULE Gold
- RoHS compliant
- VOC
- WEEE

Other Certifications

Other Certifications

- FCC Class B
- ISO 9241-307
- TÜV Rheinland Eye Comfort Certification



PERFORMANCE

Panel

Panel

In-Plane Switching (IPS)

Display Size

21.5 inches (546.1mm)

Max View Area

WxH: 476.1 x 267.8 mm (18.74 x 10.54 inches)

Native Resolution

1920x1080

Aspect Ratio

16:9

Pixel Pitch

0.24795 x 0.24795 mm

DPI

102.4 dpi

Brightness

250 nits

Contrast Ratio

1000:1

Pixel Response Time

4 ms (extreme mode) / 6 ms (typical mode) / 14 ms (off mode)

Color Gamut

72% NTSC

Viewing Angle

Horizontal: +/- 89°, vertical: +/- 89°

Anti-glare

Anti-glare

Multi-Media

Camera

720p, with dual microphone and Think Shutter

Microphone

Dual array microphone

Speakers

Stereo speakers, 2W x2

Power Supply

Power Supply

Power	Type	Efficiency	Key Features
90W	Adapter	88%	-

Power Consumption

14 watts typical, 25 watts max

DESIGN

Menu

Presets and User Settings

- Presets: 25

ThinkCentre Tiny-In-One 22 Gen 4

- User settings: 25

On Screen Display

On screen display with digital user controls (8 languages)

Display

Touchscreen

(Optional)Advanced In-cell Touch (AIT), supports 10-point touch. ONLY for model 11GTPAT1 and 11GTPAR1.

Mechanical

Compatible Tiny

P340 / P330 / P320 / M90q / M80q / M70q / M75q / M920(x) / M720 / M910(x) / M710 / M715 / M900(x) / M700 / M630e / M625 / M600 Tiny / M90n / M75n Nano (with TIO kit)

Bezel Width

- Top / side: 2mm
- Bottom: 22.1mm

Buttons

- Power button
- Exit button
- Menu button
- Mode-switching button
- Brightness button

Cables

Undetachable 3-in-1 cable (power connector, USB [supports USB 3.1 Gen 1 / USB 2.0], DisplayPort™)

Case Color

Black

Dimensions (WxDxH)

Models	Dimensions
Models with full function monitor stand	489 x 220.4 x 568.2 mm (19.26 x 8.68 x 22.37 inches)
Models without stand	489 x 65.3 x 339 mm (19.26 x 2.57 x 13.35 inches)

Weight

Models	Weight
Models without stand	3.41 kg (7.52 lbs)
Models with full function monitor stand	6.58 kg (14.51 lbs)

Mounting

Supports VESA mount 100mm

Stand

Full function monitor stand, supports -5° to +30° tilt, left & right 45° swivel, up to 150mm lift, -5° to +90° pivot

In the Box

- TIO (monitor)
- Detachable stand
- Driver CD
- Information flyer
- Power adapter
- Power cord
- User's guide

CONNECTIVITY

Ports

Rear Ports

- 1x USB upstream port
- 1x DisplayPort
- 1x power connector

Left Ports^[1]

- 1x USB 3.1 Gen 1 (on TIO)
- Side ports offered by installed Tiny (on Tiny)

Notes:

1. The availability and version depends on the Tiny installed or the PC connected via USB upstream port

SERVICE

Warranty

Base Warranty

3-year customer carry-in or mail-in via rapid replacement service

CERTIFICATIONS

Green Certifications

Green Certifications

- EPEAT™ Silver
- ENERGY STAR® 8.0
- ErP Lot 5
- GREENGUARD®
- TCO Certified 8.0
- TCO edge 2.0
- RoHS compliant
- WEEE

Other Certifications

Other Certifications

TÜV Rheinland Eye Comfort Certification



PERFORMANCE

Panel

Panel

In-Plane Switching (IPS)

Display Size

23.8 inches (604.7mm)

Max View Area

WxH: 527 x 296.5 mm (20.75 x 11.67 inches)

Native Resolution

1920x1080

Aspect Ratio

16:9

Pixel Pitch

0.2745 x 0.2745 mm

DPI

92.6 dpi

Brightness

250 nits

Contrast Ratio

1000:1

Pixel Response Time

4 ms (extreme mode) / 6 ms (typical mode) / 14 ms (off mode)

Color Gamut

72% NTSC

Viewing Angle

Horizontal: +/- 89°, vertical: +/- 89°

Anti-glare

Anti-glare

Multi-Media

Camera

1080p, with dual microphone and LED indicator

Microphone

Dual array microphone

Speakers

Stereo speakers, 2W x2

Power Supply

Power Supply

Power	Type	Efficiency	Key Features
90W	Adapter	88%	-

Power Consumption

19 watts typical, 32 watts max

DESIGN

Menu

Presets and User Settings

- Presets: 25

ThinkCentre Tiny-In-One 24 Gen 3

- User settings: 25

On Screen Display

On screen display with digital user controls (8 languages)

Display

Touchscreen

(Optional)10-point multi-touch, supports Wake on Touch. ONLY for model 10QXPAT1 and 10QXPARI.

Mechanical

Compatible Tiny

P330 / P320 / M920(x) / M720 / M910(x) / M710 / M900(x) / M700 / M630e / M625 / M600 / M75q / M715 / M93p / M83 / M73 / M53 / Chromebox Tiny

Bezel Width

- Top / side: 2mm
- Bottom: 22.1mm

Buttons

- Volume button
- Power button
- Exit button
- Menu button
- Mode-switching button
- Brightness button

Cables

Undetachable 3-in-1 cable (power connector, USB [supports USB 3.1 Gen 1 / USB 2.0], DisplayPort™)

Case Color

Black

Dimensions (WxDxH)

Models	Dimensions
Models with full function monitor stand	539.8 x 282.3 x 509.4 mm (21.25 x 11.11 x 20.06 inches)
Models without stand	539.8 x 72.5 x 367.6 mm (21.25 x 2.85 x 14.47 inches)

Weight

Models	Weight
Models without stand	3.61 kg (7.96 lbs)
Models with full function monitor stand	5.86 kg (12.92 lbs)

Mounting

Supports VESA mount 100mm

Stand

Full function monitor stand, supports -5° to +30° tilt, left & right 45° swivel, up to 110mm lift, 0° to +90° pivot

In the Box

- TIO 24 (monitor)
- Detachable stand
- Driver CD
- Power adapter
- Power cord
- Quick start and safety poster
- User's guide

CONNECTIVITY

Ports

Rear Ports

- 1x USB upstream port
- 1x DisplayPort

- 1x power connector

Left Ports¹

- 1x USB 3.1 Gen 1 (on TIO)
- Side ports offered by installed Tiny (on Tiny)

Notes:

1. The availability and version depends on the Tiny installed or the PC connected via USB upstream port

SERVICE

Warranty

Base Warranty

3-year carry-in or courier service

CERTIFICATIONS

Green Certifications

Green Certifications

- EPEAT™ Silver
- ENERGY STAR® 8.0
- TCO Certified 7.0
- TCO edge 2.0
- TÜV
- ULE Gold
- RoHS compliant
- VOC
- WEEE

Other Certifications

Other Certifications

- FCC Class B
- ISO 9241-307
- TÜV Rheinland Eye Comfort Certification



PERFORMANCE

Panel

Panel

In-Plane Switching (IPS)

Display Size

23.8 inches (604.52mm)

Max View Area

WxH: 527 x 296.5 mm (20.75 x 11.67 inches)

Native Resolution

1920x1080

Aspect Ratio

16:9

Pixel Pitch

0.2745 x 0.2745 mm

DPI

92.6 dpi

Brightness

250 nits

Contrast Ratio

1000:1

Pixel Response Time

4 ms (extreme mode) / 6 ms (typical mode) / 14 ms (off mode)

Color Gamut

72% NTSC

Viewing Angle

Horizontal: +/- 89°, vertical: +/- 89°

Anti-glare

Anti-glare

Multi-Media

Camera

- 1080p, with dual microphone and Think Shutter
- IR & RGB camera, with dual microphone and ThinkShutter

Microphone

Dual array microphone

Speakers

Stereo speakers, 2W x2

Power Supply

Power Supply

Power	Type	Efficiency	Key Features
90W	Adapter	88%	-

Power Consumption

15 watts typical, 27 watts max

DESIGN

Menu

Presets and User Settings

ThinkCentre Tiny-In-One 24 Gen 4

- Presets: 25
- User settings: 25

On Screen Display

On screen display with digital user controls (8 languages)

Display

Touchscreen

(Optional) Advanced In-cell Touch (AIT), supports 10-point touch (for model 11GCPAT1 and 11GCPAR1 only)

Mechanical

Compatible Tiny

P340 / P330 / P320 / M90q / M80q / M70q / M75q / M920(x) / M720 / M910(x) / M710 / M715 / M900(x) / M700 / M630e / M625 / M600 Tiny / M90n / M75n Nano (with TIO kit)

Bezel Width

- Top / side: 2mm
- Bottom: 22.1mm

Buttons

- Volume button
- Power button
- Exit button
- Menu button
- Mode-switching button
- Brightness button

Cables

Undetachable 3-in-1 cable (power connector, USB [supports USB 3.1 Gen 1 / USB 2.0], DisplayPort™)

Case Color

Black

Dimensions (WxDxH)

Models	Dimensions
Models with full function monitor stand	539.8 x 230.4 x 596.9 mm (21.25 x 9.07 x 23.5 inches)
Models without stand	539.8 x 65.3 x 367.6 mm (21.25 x 2.57 x 14.47 inches)

Weight

Models	Weight
Models with full function monitor stand	6.66 kg (14.68 lbs)
Models without stand	3.61 kg (7.96 lbs)

Mounting

Supports VESA mount 100mm

Stand

Full function monitor stand, supports -5° to +30° tilt, left & right 45° swivel, up to 150mm lift, -5° to +90° pivot

In the Box

- TIO (monitor)
- Detachable stand
- Driver CD
- Information flyer
- Power adapter
- Power cord
- User's guide

CONNECTIVITY

Ports

Rear Ports

- 1x USB upstream port

- 1x DisplayPort
- 1x power connector

Left Ports^[1]

- 1x USB 3.1 Gen 1 (on TIO)
- Side ports offered by installed Tiny (on Tiny)

Notes:

1. The availability and version depends on the Tiny installed or the PC connected via USB upstream port

SERVICE

Warranty

Base Warranty

3-year carry-in or courier service

CERTIFICATIONS

Green Certifications

Green Certifications

- EPEAT™ Silver
- ENERGY STAR® 8.0
- ErP Lot 5
- GREENGUARD®
- TCO edge 2.0
- RoHS compliant
- WEEE

Other Certifications

Other Certifications

TÜV Rheinland Eye Comfort Certification



PERFORMANCE

Panel

Panel

In-Plane Switching (IPS)

Display Size

27 inches (685.8mm)

Max View Area

WxH: 596.7 x 335.7 mm (23.49 x 13.22 inches)

Native Resolution

2560x1440

Aspect Ratio

16:9

Pixel Pitch

0.2331 x 0.2331 mm

DPI

109 dpi

Brightness

350 nits

Contrast Ratio

1000:1

Pixel Response Time

4 ms (extreme mode) / 6 ms (typical mode) / 14 ms (off mode)

Color Gamut

99% sRGB

Viewing Angle

Horizontal: +/- 89°, vertical: +/- 89°

Anti-glare

Anti-glare

Multi-Media

Camera

RGBIR camera, with dual microphone , Think Shutter, LED indicator. Supports Window Hello and Facial Recognition

Microphone

Dual array microphone

Speakers

Stereo speakers, 2W x2

Power Supply

Power Supply

Power	Type	Efficiency	Key Features
170W	Adapter	88%	-

Power Consumption

37 watts typical, 57 watts max

DESIGN

Menu

Presets and User Settings

- Presets: 25

ThinkCentre Tiny-In-One 27

- User settings: 25

On Screen Display

On screen display with digital user controls (8 languages)

Display

Touchscreen

Non-touch

Mechanical

Compatible Tiny

ThinkCentre® Tiny, ThinkCentre Nano, and ThinkStaion Tiny

Bezel Width

- Top / side: 2mm
- Bottom: 23.3mm

Buttons

- Volume button
- Power button
- Exit button
- Menu button
- Mode-switching button
- Brightness button

Cables

Undetachable 3-in-1 cable (power connector, USB [supports USB 3.1 Gen 1 / USB 2.0], DisplayPort™)

Case Color

Black

Dimensions (WxDxH)

Models	Dimensions
Models with full function monitor stand	614 x 329 x 554.25 mm (24.17 x 12.95 x 21.82 inches)
Models without stand	614 x 73.89 x 413.1 mm (24.17 x 2.91 x 16.26 inches)

Weight

Models	Weight
Models without stand	4.90 kg (10.82 lbs)
Models with full function monitor stand	7.95 kg (17.53 lbs)

Mounting

Supports VESA mount 100mm

Stand

Full function monitor stand, supports -5° to +30° tilt, left & right 45° swivel, up to 110mm lift, -5° to +90° pivot

In the Box

- TIO 27 (monitor)
- Detachable stand
- Power adapter
- Power cord
- Reference and driver CD

CONNECTIVITY

Ports

Rear Ports

- 1x USB upstream port
- 1x HDMI®-in
- 1x DisplayPort
- 1x power connector

Left Ports^[1]

- 2x USB 3.1 Gen 1 (on TIO)
- Side ports offered by installed Tiny (on Tiny)
- 1x headphone / microphone combo jack (on TIO)

Notes:

1. The USB ports are enabled by installing a Tiny or connecting USB upstream port; the audio port is enabled by installing a Tiny or connecting USB upstream, DisplayPort(in), or HDMI(in) port

SERVICE

Warranty

Base Warranty

3-year product exchange service (US and EMEA) or customer carry-in service (EMEA)

CERTIFICATIONS

Green Certifications

Green Certifications

- EPEAT™ Silver
- ENERGY STAR® 8.0
- TCO edge 2.0
- TÜV
- ULE Gold
- RoHS compliant
- VOC
- WEEE

Other Certifications

Other Certifications

- ISO 9241-307
- TÜV Rheinland Eye Comfort Certification



OVERVIEW

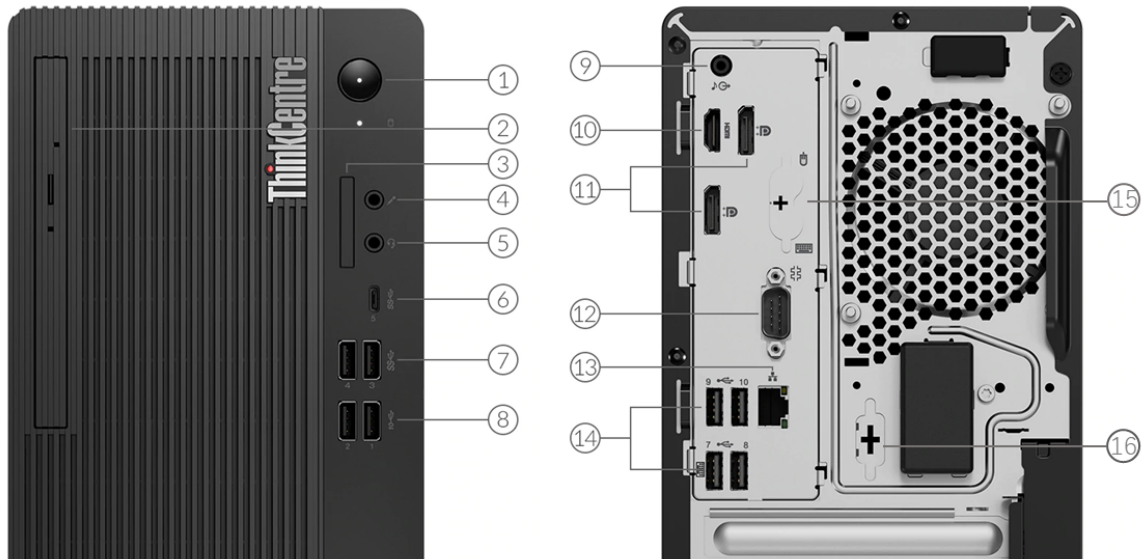

1. Power button	9. Line-out (3.5mm)
2. Optical drive *	10. HDMI
3. Card reader *	11. 2x DisplayPort
4. Microphone (3.5mm)	12. Serial
5. Headphone / microphone combo jack (3.5mm)	13. Ethernet (RJ-45)
6. USB-C 3.2 Gen 1	14. 4x USB 2.0
7. 2x USB 3.2 Gen 1	15. 2x PS/2 ports (keyboard / mouse) *
8. 2x USB 3.2 Gen 2	16. Serial *

Notes:

- Ports with * are only available on selected models
- More ports are available through the optional expansion cards (not shown on the sample product above)

PERFORMANCE

Processor

Processor Family

Intel® Celeron®, Intel Pentium®, or 10th Generation Intel Core™ i3 / i5 / i7 / i9 Processor

Processor**

Processor Name	Cores	Threads	Base Frequency	Max Frequency	Cache	Memory Support	Processor Graphics
Celeron G5900	2	2	3.4GHz	-	2MB	DDR4-2666	Intel UHD Graphics 610
Celeron G5905	2	2	3.5GHz	-	4MB	DDR4-2666	Intel UHD Graphics 610
Celeron G5920	2	2	3.5GHz	-	2MB	DDR4-2666	Intel UHD Graphics 610
Celeron G5925	2	2	3.6GHz	-	4MB	DDR4-2666	Intel UHD Graphics 610
Pentium Gold G6400	2	4	4.0GHz	-	4MB	DDR4-2666	Intel UHD Graphics 610
Pentium Gold G6500	2	4	4.1GHz	-	4MB	DDR4-2666	Intel UHD Graphics 630
Pentium Gold G6600	2	4	4.2GHz	-	4MB	DDR4-2666	Intel UHD Graphics 630
Core i3-10100	4	8	3.6GHz	4.3GHz	6MB	DDR4-2666	Intel UHD Graphics 630
Core i3-10300	4	8	3.7GHz	4.4GHz	8MB	DDR4-2666	Intel UHD Graphics 630
Core i3-10320	4	8	3.8GHz	4.6GHz	8MB	DDR4-2666	Intel UHD Graphics 630
Core i5-10400	6	12	2.9GHz	4.3GHz	12MB	DDR4-2666	Intel UHD Graphics 630
Core i5-10400F	6	12	2.9GHz	4.3GHz	12MB	DDR4-2666	-
Core i5-10500	6	12	3.1GHz	4.5GHz	12MB	DDR4-2666	Intel UHD Graphics 630
Core i5-10600	6	12	3.3GHz	4.8GHz	12MB	DDR4-2666	Intel UHD Graphics 630
Core i7-10700	8	16	2.9GHz	4.8GHz	16MB	DDR4-2933	Intel UHD Graphics 630
Core i7-10700F	8	16	2.9GHz	4.8GHz	16MB	DDR4-2933	-
Core i9-10900	10	20	2.8GHz	5.2GHz	20MB	DDR4-2933	Intel UHD Graphics 630
Core i9-10900F	10	20	2.8GHz	5.2GHz	20MB	DDR4-2933	-

Operating System

Operating System**

- Windows® 10 Pro 64
- Windows 10 Home 64
- Windows 10 IoT Enterprise
- Ubuntu Linux
- No operating system

Graphics

Graphics**[1]

Graphics	Type	Memory	Connector	Max Resolution	Key Features
Intel UHD graphics 610	Integrated	Shared	1x HDMI®, 2x DP	1920x1080@60Hz(HDMI), 4096x2304@60Hz(DP)	DirectX® 12
Intel UHD graphics 630	Integrated	Shared	1x HDMI, 2x DP	1920x1080@60Hz(HDMI), 4096x2304@60Hz(DP)	DirectX 12
AMD Radeon™ 520	Discrete	2GB GDDR5	2x DP 1.2	4096x2160@60Hz(DP)	DirectX 12
AMD Radeon RX 550X	Discrete	4GB GDDR5	1x HDMI 2.0, 1x VGA, 1x DP 1.4	4096x2160@60Hz(HDMI), 2048x1536@85Hz(VGA), 3840x2160@60Hz(DP)	DirectX 12
NVIDIA® GeForce® GT 730	Discrete	2GB GDDR5	1x VGA, 1x HDMI 1.4	2048x1536@75Hz(VGA), 3840x2160@30Hz(HDMI)	DirectX 12

Notes:

- The information of integrated graphics are not applicable for the models without integrated graphics (for the details, please refer to processor section)

Monitor Support

Monitor Support^[1]

Supports up to 3 independent displays via onboard ports (HDMI and 2x DisplayPort™), more displays support via discrete graphics

Notes:

- Onboard video ports are only available for the models with integrated graphics

Chipset

Chipset

Intel H470 chipset

Memory

Max Memory^[1]

Up to 128GB DDR4-2933

Memory Slots

Four DDR4 DIMM slots, dual-channel capable

Memory Type^{**}

- DDR4-2666
- DDR4-2933

Notes:

- The max memory is based on the test results with current Lenovo® memory offerings. The system may support more memory as the technology develops.

Storage

Storage Support

Up to three drives, 1x 2.5"/3.5" HDD + 1x 2.5" HDD + 1x M.2 SSD

- 2.5" HDD up to 1TB each
- 3.5" HDD up to 2TB
- M.2 SSD up to 2TB
- Optional Intel Optane™ Memory, M.2

Storage Type^{***}

Disk Type	Interface	RPM	Security
2.5" SATA HDD	SATA 6Gb/s	7.2K	-
3.5" SATA HDD	SATA 6Gb/s	7.2K	-
M.2 2242 SSD	PCIe NVMe, PCIe 3.0 x2	-	-
M.2 2280 SSD	PCIe NVMe, PCIe 3.0 x4	-	Opal
Intel Optane Memory M10	PCIe NVMe, PCIe 3.0 x2	-	-

RAID

No support

Removable Storage

Optical^{**}

- DVD-ROM, SATA 1.5Gb/s, slim (9.0mm)
- DVD burner (DVD±RW), SATA 1.5Gb/s, slim (9.0mm)
- None

Card Reader

- 3-in-1 card reader (SD, SDHC, SDXC)
- No card reader

Multi-Media

Audio Chip

High Definition (HD) Audio, Realtek® ALC623-CG codec

Speakers

Single speaker, 2W x1

Power Supply

Power Supply**

Power	Type	Efficiency	Key Features
180W	Fixed	85%	-
260W	Fixed	85%	-
310W	Fixed	92%	-
380W	Fixed	92%	-

DESIGN

Input Device

Keyboard**

- Lenovo Calliope Keyboard (USB connector), black
- Lenovo Calliope Wireless Keyboard (2.4GHz via USB receiver), black
- Lenovo Traditional Keyboard (USB connector), black
- No keyboard

Mouse**

- Lenovo Calliope Mouse (USB connector), black
- Lenovo Calliope Wireless Mouse (2.4GHz via USB receiver), black
- Lenovo Fingerprint Mouse (USB connector), Windows Hello support, black
- No mouse

Mechanical

Form Factor

Tower (13.6L)

Dimensions (WxDxH)

Models	Dimensions
All models	145 x 296 x 346 mm (5.7 x 11.7 x 13.6 inches)

Weight

Models	Weight
All models	4.8 kg (10.6 lbs)

Case Color

Black

Bays

- 1x 2.5" disk bay (optional, or bay comes with disk)
- 1x 3.5" disk bay
- 1x slim ODD bay

Expansion Slots

- One PCIe 3.0 x1, full-height (length < 215mm)
- One PCIe 3.0 x16, full-height (length < 215mm)
- Two M.2 slots (one for WLAN, one for SSD)

Others

- (Optional) Dust filter
- Supports Smart Power On

CONNECTIVITY

Network

Onboard Ethernet

Gigabit Ethernet, Intel Ethernet Connection I219-V, 1x RJ45, supports Wake-on-LAN

Optional Ethernet**

- Gigabit Ethernet, Bitland BN8E88, 1x RJ-45, PCIe x1
- Gigabit Ethernet, Intel Ethernet Server Adapter I350-T4, 4x RJ-45, PCIe x4
- No optional Ethernet

WLAN + Bluetooth***

- Realtek RTL8822CE, 802.11ac Dual Band 2x2 Wi-Fi® + Bluetooth 5.0, M.2 card
- Intel Wireless-AC 9462, 802.11ac Dual Band 1x1 Wi-Fi + Bluetooth 5.0, M.2 card
- Intel Wireless-AC 9560, 802.11ac Dual Band 2x2 Wi-Fi + Bluetooth 5.0, M.2 card
- Intel Wi-Fi 6 AX201, 802.11ax 2x2 Wi-Fi + Bluetooth 5.1, M.2 Card
- No WLAN and Bluetooth

Ports^[1]

Front Ports

- 2x USB 3.2 Gen 1
- 2x USB 3.2 Gen 2
- 1x USB-C 3.2 Gen 1
- 1x headphone / microphone combo jack (3.5mm)
- 1x microphone (3.5mm)

Optional Front Ports

- 1x card reader
- None

Rear Ports^[2]

- 4x USB 2.0
- 1x HDMI
- 2x DisplayPort
- 1x serial (9-pin)
- 1x Ethernet (RJ-45)
- 1x line-out (3.5mm)

Optional Rear Ports***

- 2x USB 3.2 Gen 1 (via 2-port USB expansion card, PCIe x1)
- 2x USB-C 3.2 Gen 2 (via 2-port USB-C expansion card, PCIe x4)
- 1x serial
- 4x serial (via 4-port serial expansion card, PCIe x1)
- 1x parallel
- 2x PS/2

Notes:

1. The transfer speed of following ports will vary and, depending on many factors, such as the processing speed of the host device, file attributes and other factors related to system configuration and your operating environment, will be slower than theoretical speed.
USB 2.0: 480 Mbit/s;
USB 3.2 Gen 1 (SuperSpeed USB 5Gbps, formerly USB 3.0 / USB 3.1 Gen 1): 5 Gbit/s;
USB 3.2 Gen 2 (SuperSpeed USB 10Gbps, formerly USB 3.1 Gen 2): 10 Gbit/s;
USB 3.2 Gen 2x2 (SuperSpeed USB 20Gbps): 20 Gbit/s;
Thunderbolt™ 3: 40 Gbit/s;
FireWire 400: 400 Mbit/s;
FireWire 800: 800 Mbit/s
2. For video ports on discrete graphics, please see graphics section

Monitor Cable

Monitor Cable***

- DP to dual DP dongle
- DP to DVI-D dongle
- DP to HDMI 1.4 dongle
- DP to VGA cable (1.5M)

- DP to VGA dongle
- HDMI to HDMI cable
- HDMI to VGA dongle
- No monitor cable

SECURITY & PRIVACY

Security

Security Chip

Discrete TPM 2.0, TCG certified

Physical Locks

- (Optional) E-lock
- (Optional) Smart Cable Clip
- Kensington® Security Slot
- Padlock Loop

Chassis Intrusion Switch

- Chassis intrusion switch
- No chassis intrusion switch

Fingerprint Reader

- Touch style fingerprint reader on mouse
- No fingerprint reader

BIOS Security

- Administrator password
- Power-on password
- Hard disk password
- Boot sequence control
- Boot without keyboard and mouse
- Smart USB protection (allows keyboard / mouse only, blocks all storage devices)
- Individual USB port disablement

MANAGEABILITY

System Management

System Management

None

SERVICE

Warranty

Base Warranty**

- 1-year depot service
- 1-year limited onsite service
- 3-year limited onsite service
- No base warranty

ENVIRONMENTAL

Operating Environment

Temperature

- Operating: 5°C (41°F) to 35°C (95°F)
- Storage: -40°C (-40°F) to 60°C (140°F)

Humidity

- Operating: 20% to 80%
- Storage: 10% to 90%

Altitude

- Operating: -15.2 m (-50 ft) to 3048 m (10,000 ft)
- Storage: -15.2 m (-50 ft) to 12192 m (40,000 ft)

CERTIFICATIONS

Green Certifications

Green Certifications

- EPEAT™ Gold
- EPEAT Silver
- ENERGY STAR® 8.0 (only available for MT 11D9/11DA)
- ErP Lot 3
- TCO Certified 8.0
- RoHS compliant

Other Certifications

Other Certifications

- (Optional) TÜV Rheinland® Low Noise
- (Optional) TÜV Rheinland Ultra Low Noise

- Feature with ** means that only one offering listed under the feature is configured on selected models.
- Feature with *** means that one or more offerings listed under the feature could be configured on selected models.
- Lenovo reserves the right to change specifications or other product information without notice. Lenovo is not responsible for photographic or typographical errors. LENOVO PROVIDES THIS PUBLICATION “AS IS,” WITHOUT WARRANTY OF ANY KIND, EITHER EXPRESS OR IMPLIED, INCLUDING THE IMPLIED WARRANTIES OF MERCHANTABILITY OR FITNESS FOR A PARTICULAR PURPOSE. Some jurisdictions do not allow disclaimer of express or implied warranties in certain transactions, therefore this disclaimer may not apply to you.
- The specifications on this page may not be available in all regions, and may be changed or updated without notice.

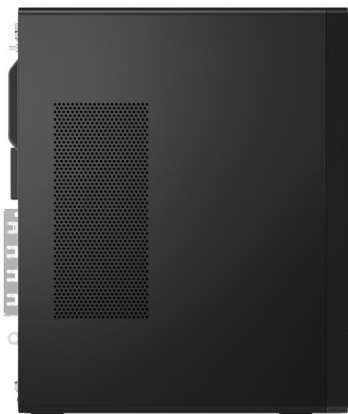
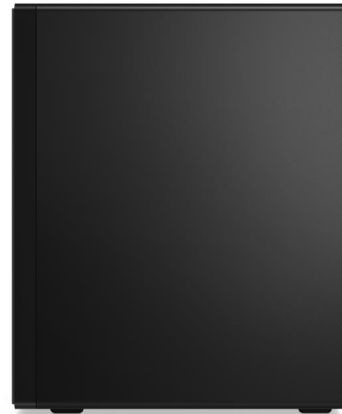

OVERVIEW

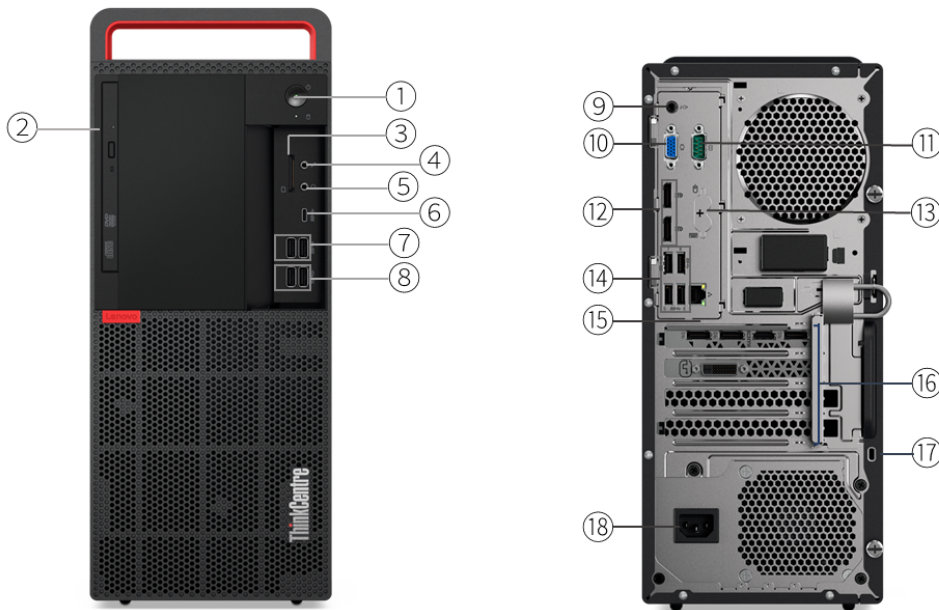

1. Power button	9. Serial
2. Optical drive *	10. VGA
3. Card reader *	11. 2x DisplayPort
4. Microphone (3.5mm)	12. 4x USB 3.1 Gen 1
5. Headphone / microphone combo jack (3.5mm)	13. Ethernet (RJ-45)
6. USB-C 3.1 Gen 1	14. 2x PS/2 ports (keyboard / mouse) *
7. 2x USB 3.1 Gen 1	15. 2x USB 3.1 Gen 2
8. Line-out (3.5mm)	

Notes:

- Ports with * are only available on selected models
- More ports are available through the optional expansion cards (not shown on the sample product above)

PERFORMANCE

Processor

Processor Family

Intel® Celeron®, Intel Pentium®, 8th Generation Intel Core™ i3 / i5 / i7, or 9th Generation Intel Core i3 / i5 / i7 / i9 Processor

Processor**

Processor Name	Cores	Threads	Base Frequency	Max Frequency	Cache	Memory Support	Processor Graphics
Celeron G4900	2	2	3.1GHz	-	2MB	DDR4-2400	Intel UHD Graphics 610
Celeron G4920	2	2	3.2GHz	-	2MB	DDR4-2400	Intel UHD Graphics 610
Celeron G4930	2	2	3.2GHz	-	2MB	DDR4-2400	Intel UHD Graphics 610
Celeron G4950	2	2	3.3GHz	-	2MB	DDR4-2400	Intel UHD Graphics 610
Pentium Gold G5400	2	4	3.7GHz	-	4MB	DDR4-2400	Intel UHD Graphics 610
Pentium Gold G5420	2	4	3.8GHz	-	4MB	DDR4-2400	Intel UHD Graphics 610
Pentium Gold G5500	2	4	3.8GHz	-	4MB	DDR4-2400	Intel UHD Graphics 630
Pentium Gold G5600	2	4	3.9GHz	-	4MB	DDR4-2400	Intel UHD Graphics 630
Pentium Gold G5620	2	4	4.0GHz	-	4MB	DDR4-2400	Intel UHD Graphics 630
Core i3-8100	4	4	3.6GHz	-	6MB	DDR4-2400	Intel UHD Graphics 630
Core i3-8300	4	4	3.7GHz	-	8MB	DDR4-2400	Intel UHD Graphics 630
Core i3-9100	4	4	3.6GHz	4.2GHz	6MB	DDR4-2400	Intel UHD Graphics 630
Core i3-9300	4	4	3.7GHz	4.3GHz	8MB	DDR4-2400	Intel UHD Graphics 630
Core i3-9320	4	4	3.7GHz	4.4GHz	8MB	DDR4-2400	Intel UHD Graphics 630
Core i5-8400	6	6	2.8GHz	4.0GHz	9MB	DDR4-2666	Intel UHD Graphics 630
Core i5-8500	6	6	3.0GHz	4.1GHz	9MB	DDR4-2666	Intel UHD Graphics 630
Core i5-8600	6	6	3.1GHz	4.3GHz	9MB	DDR4-2666	Intel UHD Graphics 630
Core i5-9400	6	6	2.9GHz	4.1GHz	9MB	DDR4-2666	Intel UHD Graphics 630
Core i5-9400F	6	6	2.9GHz	4.1GHz	9MB	DDR4-2666	-
Core i5-9500	6	6	3.0GHz	4.4GHz	9MB	DDR4-2666	Intel UHD Graphics 630
Core i5-9500F	6	6	3.0GHz	4.4GHz	9MB	DDR4-2666	-
Core i5-9600	6	6	3.1GHz	4.6GHz	9MB	DDR4-2666	Intel UHD Graphics 630
Core i7-8700	6	12	3.2GHz	4.6GHz	12MB	DDR4-2666	Intel UHD Graphics 630
Core i7-9700	8	8	3.0GHz	4.7GHz	12MB	DDR4-2666	Intel UHD Graphics 630
Core i9-9900	8	16	3.1GHz	5.0GHz	16MB	DDR4-2666	Intel UHD Graphics 630

Operating System

Operating System**

- Windows® 10 Pro 64
- Windows 10 Home 64
- Windows 10 IoT Enterprise
- Ubuntu Linux
- No operating system

Graphics

Graphics**[1]

Graphics	Type	Memory	Connector	Max Resolution	Key Features
Intel UHD graphics 610	Integrated	Shared	1x VGA, 2x DP	2048x1536@50Hz(VGA), 4096x2304@60Hz(DP)	DirectX® 12
Intel UHD	Integrated	Shared	1x VGA, 2x DP	2048x1536@50Hz(VGA),	DirectX 12

graphics 630				4096x2304@60Hz(DP)	
AMD Radeon™ 520	Discrete	2GB GDDR5	2x DP 1.2	4096x2160@60Hz(DP)	DirectX 12
AMD Radeon RX 550X	Discrete	4GB GDDR5	1x HDMI® 2.0, 1x VGA, 1x DP 1.4	4096x2160@60Hz(HDMI), 2048x1536@85Hz(VGA), 3840x2160@60Hz(DP)	DirectX 12
NVIDIA® GeForce® GT 730	Discrete	2GB GDDR5	2x DP	3840x2160@60Hz(DP)	DirectX 12, PCIe 2.0 x16, 35 watts

Notes:

- The information of integrated graphics are not applicable for the models without integrated graphics (for the details, please refer to processor section)

Monitor Support

Monitor Support^[1]

Supports up to 3 independent displays via onboard ports (VGA and 2x DisplayPort™), more displays support via discrete graphics

Notes:

- Onboard video ports are only available for the models with integrated graphics

Chipset

Chipset

Intel B360 chipset

Memory

Max Memory^[1]

Up to 64GB DDR4-2666

Memory Slots

Four DDR4 DIMM slots, dual-channel capable

Memory Type

DDR4-2666

Notes:

- The max memory is based on the test results with current Lenovo® memory offerings. The system may support more memory as the technology develops.

Storage

Storage Support

Up to three drives, 1x 2.5"/3.5" HDD/SSD + 1x 2.5" HDD/SSD + 1x M.2 SSD

- 2.5" HDD up to 1TB each
- 3.5" HDD up to 2TB
- 2.5" SSD up to 256GB each
- M.2 SSD up to 1TB
- Optional Intel Optane™ Memory, M.2

Storage Type^{***}

Disk Type	Interface	RPM	Security
2.5" SATA HDD	SATA 6Gb/s	7.2K	-
2.5" SATA SSD	SATA 6Gb/s	-	Opal
2.5" SATA SSD	SATA 6Gb/s	-	-
3.5" SATA HDD	SATA 6Gb/s	7.2K	-
M.2 2242 SSD	PCIe NVMe, PCIe 3.0 x2	-	-
M.2 2280 SSD	PCIe NVMe, PCIe 3.0 x4	-	Opal

ThinkCentre M720 Tower

M.2 2280 SSD	PCIe NVMe, PCIe 3.0 x4	-	-
Intel Optane Memory M10	PCIe NVMe, PCIe 3.0 x2	-	-

RAID

No support

Removable Storage

Optical**

- DVD-ROM, SATA 1.5Gb/s, slim (9.0mm)
- DVD burner (DVD±RW), SATA 1.5Gb/s, slim (9.0mm)
- None

Card Reader

- 7-in-1 card reader
- No card reader

Multi-Media

Audio Chip

High Definition (HD) Audio, Realtek® ALC233VB2 codec

Speakers

Single speaker, 2W x1

Power Supply

Power Supply**

Power	Type	Efficiency	Key Features
180W	Fixed	85%	-
210W	Fixed	85%	-
260W	Fixed	92%	-

DESIGN

Input Device

Keyboard**

- Lenovo Calliope Keyboard (USB connector), black
- Lenovo Calliope Wireless Keyboard (2.4GHz via USB receiver), black
- Lenovo Keyboard (PS/2 connector), black
- Lenovo Traditional Keyboard (USB connector), black
- No keyboard

Mouse**

- Lenovo Calliope Mouse (USB connector), black
- Lenovo Calliope Wireless Mouse (2.4GHz via USB receiver), black
- Lenovo Mouse (PS/2 connector), black (only available via special bid)
- Lenovo Fingerprint Mouse (USB connector), Windows Hello support, black
- No mouse

Mechanical

Form Factor

Tower (15L)

Dimensions (WxDxH)

Models	Dimensions
All models	150 x 270.5 x 360 mm (5.91 x 10.65 x 14.17 inches)

Weight

Models	Weight
--------	--------

All models	6.9 kg (15.21 lbs)
------------	--------------------

Case Color

Black

Bays

- 1x 3.5" disk bay
- 1x 3.5" disk bay (optional, or bay comes with disk)
- 1x slim ODD bay

Expansion Slots

- Two PCIe 3.0 x1, half-length (< 189mm) full-height (< 104mm)
- One PCIe 3.0 x16, half-length (< 189mm) full-height (< 104mm)
- One dummy slot, only bracket for optional port extension
- Two M.2 slots (one for WLAN, one for SSD)

Stand

No stand

Others

(Optional) Dust filter

CONNECTIVITY**Network****Onboard Ethernet**

Gigabit Ethernet, Intel Ethernet Connection I219-V, 1x RJ45, supports Wake-on-LAN

Optional Ethernet**

- Gigabit Ethernet, Bitland BN8E88, 1x RJ-45, PCIe x1
- Gigabit Ethernet, Intel Ethernet Server Adapter I350-T4, 4x RJ-45, PCIe x4
- No optional Ethernet

WLAN + Bluetooth**

- Realtek RTL8821CE, 802.11ac Dual Band 1x1 Wi-Fi® + Bluetooth 4.2, M.2 card
- Realtek RTL8822BE, 802.11ac Dual Band 2x2 Wi-Fi + Bluetooth 4.2, M.2 card
- Intel Dual Band Wireless-AC 3165, 802.11ac Dual Band 1x1 Wi-Fi + Bluetooth 4.2, M.2 Card
- Intel Dual Band Wireless-AC 8265, 802.11ac Dual Band 2x2 Wi-Fi + Bluetooth 4.2, M.2 Card
- No WLAN and Bluetooth

Ports^[1]**Front Ports**

- 2x USB 3.1 Gen 1
- 2x USB 3.1 Gen 2
- 1x USB-C 3.1 Gen 1
- 1x headphone / microphone combo jack (3.5mm)
- 1x microphone (3.5mm)

Optional Front Ports

- 1x card reader
- None

Rear Ports^[2]

- 4x USB 2.0
- 1x VGA
- 2x DisplayPort
- 1x serial (9-pin)
- 1x Ethernet (RJ-45)
- 1x line-out (3.5mm)

Optional Rear Ports***

- 1x USB 2.0 (via 1-port adapter)
- 2x USB 2.0 (via 2-port adapter)
- 2x USB 3.2 Gen 1 (via 2-port USB expansion card, PCIe x1)
- 2x USB-C 3.2 Gen 2 (via 2-port USB-C expansion card, PCIe x4)

- 1x serial
- 4x serial (via 4-port serial expansion card, PCIe x1)
- 1x parallel
- 2x PS/2

Notes:

1. The transfer speed of following ports will vary and, depending on many factors, such as the processing speed of the host device, file attributes and other factors related to system configuration and your operating environment, will be slower than theoretical speed.
USB 2.0: 480 Mbit/s;
USB 3.2 Gen 1 (SuperSpeed USB 5Gbps, formerly USB 3.0 / USB 3.1 Gen 1): 5 Gbit/s;
USB 3.2 Gen 2 (SuperSpeed USB 10Gbps, formerly USB 3.1 Gen 2): 10 Gbit/s;
USB 3.2 Gen 2x2 (SuperSpeed USB 20Gbps): 20 Gbit/s;
Thunderbolt™ 3: 40 Gbit/s;
FireWire 400: 400 Mbit/s;
FireWire 800: 800 Mbit/s
2. For video ports on discrete graphics, please see graphics section

Monitor Cable

Monitor Cable***

- DP to dual DP dongle
- DP to DVI-D dongle
- DP to HDMI 1.4 dongle
- DP to VGA cable (1.5M)
- DP to VGA dongle
- No monitor cable

SECURITY & PRIVACY

Security

Security Chip

Discrete TPM 2.0, TCG certified

Physical Locks

- (Optional) E-lock
- (Optional) Smart Cable Clip
- Kensington® Security Slot
- Padlock Loop

Chassis Intrusion Switch

- Chassis intrusion switch
- No chassis intrusion switch

Fingerprint Reader

- Touch style fingerprint reader on mouse
- No fingerprint reader

BIOS Security

- Administrator password
- Power-on password
- Hard disk password
- Boot sequence control
- Boot without keyboard and mouse
- Smart USB protection (allows keyboard / mouse only, blocks all storage devices)
- Individual USB port disablement

MANAGEABILITY

System Management

System Management

None

SERVICE

Warranty

Base Warranty**

- 1-year depot service
- 1-year limited onsite service
- 3-year depot service
- 3-year limited onsite service
- 3-year split limited onsite service
- No base warranty

ENVIRONMENTAL

Operating Environment

Temperature

- Operating: 5°C (41°F) to 35°C (95°F)
- Storage: -40°C (-40°F) to 60°C (140°F)

Humidity

- Operating: 20% to 80%
- Storage: 10% to 90%

Altitude

- Operating: -15.2 m (-50 ft) to 3048 m (10,000 ft)
- Storage: -15.2 m (-50 ft) to 12192 m (40,000 ft)

CERTIFICATIONS

Green Certifications

Green Certifications

- EPEAT™ Silver
- ENERGY STAR® 8.0
- ErP Lot 3
- TCO
- RoHS compliant

Other Certifications

Other Certifications

(Optional) TÜV Rheinland® Low Noise

- Feature with ** means that only one offering listed under the feature is configured on selected models.
- Feature with *** means that one or more offerings listed under the feature could be configured on selected models.
- Lenovo reserves the right to change specifications or other product information without notice. Lenovo is not responsible for photographic or typographical errors. **LENOVO PROVIDES THIS PUBLICATION "AS IS," WITHOUT WARRANTY OF ANY KIND, EITHER EXPRESS OR IMPLIED, INCLUDING THE IMPLIED WARRANTIES OF MERCHANTABILITY OR FITNESS FOR A PARTICULAR PURPOSE.** Some jurisdictions do not allow disclaimer of express or implied warranties in certain transactions, therefore this disclaimer may not apply to you.
- The specifications on this page may not be available in all regions, and may be changed or updated without notice.





OVERVIEW

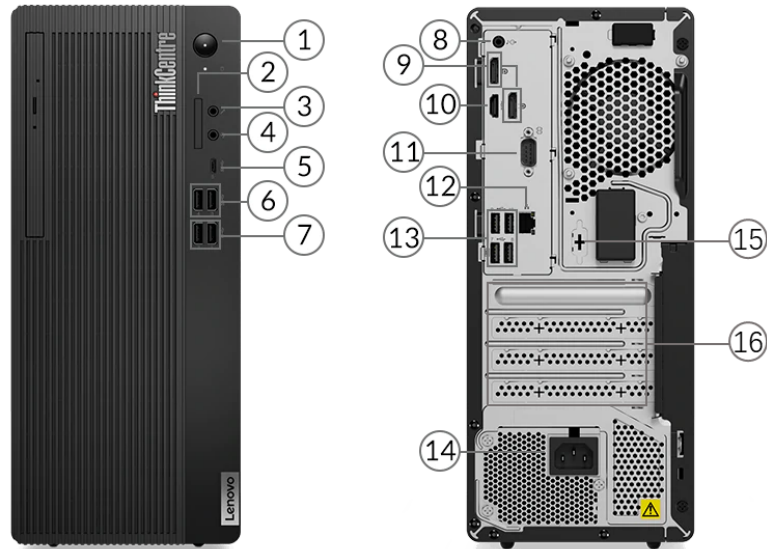

1. Power button	9. 2x DisplayPort
2. Card reader *	10. HDMI
3. Microphone (3.5mm)	11. Serial
4. Headphone / microphone combo jack (3.5mm)	12. Ethernet (RJ-45)
5. USB-C 3.2 Gen 1	13. 4x USB 2.0
6. 2x USB 3.2 Gen 1	14. Power connector
7. 2x USB 3.2 Gen 2	15. Serial *
8. Line-out (3.5mm)	16. Optional ports on expansion cards *

Notes:

- Ports with * are only available on selected models

PERFORMANCE

Processor

Processor Family

AMD Athlon™ or AMD Ryzen™ 3 / 5 / 7 / 9 Processor

Processor**

Processor Name	Cores	Threads	Base Frequency	Max Frequency	Cache	Memory Support	Processor Graphics
AMD Athlon Silver 3050GE	2	4	3.4GHz	3.4GHz	1MB L2 / 4MB L3	DDR4-2666	AMD Radeon™ Graphics
AMD Athlon Gold PRO 3150G	4	4	3.5GHz	3.9GHz	2MB L2 / 4MB L3	DDR4-2933	AMD Radeon Graphics
AMD Ryzen 3 3200G	4	4	3.6GHz	4.0GHz	2MB L2 / 4MB L3	DDR4-2933	AMD Radeon Vega 8 Graphics
AMD Ryzen 3 4300G	4	8	3.8GHz	4.0GHz	2MB L2 / 4MB L3	DDR4-3200	AMD Radeon Graphics
AMD Ryzen 3 5300G	4	8	4.0GHz	4.2GHz	2MB L2 / 8MB L3	DDR4-3200	AMD Radeon Graphics
AMD Ryzen 3 PRO 4350G	4	8	3.8GHz	4.0GHz	2MB L2 / 4MB L3	DDR4-3200	AMD Radeon Graphics
AMD Ryzen 3 PRO 5350G	4	8	4.0GHz	4.2GHz	2MB L2 / 8MB L3	DDR4-3200	AMD Radeon Graphics
AMD Ryzen 5 4600G	6	12	3.7GHz	4.2GHz	3MB L2 / 8MB L3	DDR4-3200	AMD Radeon Graphics
AMD Ryzen 5 5600G	6	12	3.9GHz	4.4GHz	3MB L2 / 16MB L3	DDR4-3200	AMD Radeon Graphics
AMD Ryzen 5 PRO 3350G	4	8	3.6GHz	4.0GHz	2MB L2 / 4MB L3	DDR4-2933	AMD Radeon Vega 11 Graphics
AMD Ryzen 5 PRO 3400G	4	8	3.7GHz	4.2GHz	2MB L2 / 4MB L3	DDR4-2933	AMD Radeon Vega 11 Graphics
AMD Ryzen 5 PRO 3600	6	12	3.6GHz	4.2GHz	3MB L2 / 32MB L3	DDR4-3200	-
AMD Ryzen 5 PRO 4650G	6	12	3.7GHz	4.2GHz	3MB L2 / 8MB L3	DDR4-3200	AMD Radeon Graphics
AMD Ryzen 5 PRO 5650G	6	12	3.9GHz	4.4GHz	3MB L2 / 16MB L3	DDR4-3200	AMD Radeon Graphics
AMD Ryzen 7 4700G	8	16	3.6GHz	4.4GHz	4MB L2 / 8MB L3	DDR4-3200	AMD Radeon Graphics
AMD Ryzen 7 5700G	8	16	3.8GHz	4.6GHz	4MB L2 / 16MB L3	DDR4-3200	AMD Radeon Graphics
AMD Ryzen 7 PRO 3700	8	16	3.6GHz	4.4GHz	4MB L2 / 32MB L3	DDR4-3200	-
AMD Ryzen 7 PRO 4750G	8	16	3.6GHz	4.4GHz	4MB L2 / 8MB L3	DDR4-3200	AMD Radeon Graphics
AMD Ryzen 7 PRO 5750G	8	16	3.8GHz	4.6GHz	4MB L2 / 16MB L3	DDR4 3200	AMD Radeon Graphics
AMD Ryzen 9 PRO 3900	12	24	3.1GHz	4.3GHz	6MB L2 / 64MB L3	DDR4-3200	-

Operating System

Operating System**

- Windows® 10 Pro 64

ThinkCentre M75t Gen 2

- Windows 10 Home 64
- Windows 10 IoT Enterprise
- Ubuntu Linux
- No operating system

Graphics

Graphics**^[1]

Graphics	Type	Memory	Connector	Max Resolution	Key Features
AMD Radeon Graphics	Integrated	Shared	2x DisplayPort™ 1.4, 1x HDMI® 1.4	4096x2160@60Hz(DP), 4096x2160@24Hz(HDMI)	DirectX® 12
AMD Radeon Vega 8 Graphics	Integrated	Shared	2x DisplayPort 1.4, 1x HDMI 1.4	4096x2160@60Hz(DP), 4096x2160@24Hz(HDMI)	DirectX 12
AMD Radeon Vega 11 Graphics	Integrated	Shared	2x DisplayPort 1.4, 1x HDMI 1.4	4096x2160@60Hz(DP), 4096x2160@24Hz(HDMI)	DirectX 12
AMD Radeon 520	Discrete	2GB GDDR5	2x DP 1.2	4096x2160@60Hz(DP)	DirectX 12
AMD Radeon RX 550X	Discrete	4GB GDDR5	1x HDMI 2.0, 1x VGA, 1x DP 1.4	4096x2160@60Hz(HDMI), 2048x1536@85Hz(VGA), 3840x2160@60Hz(DP)	DirectX 12

Notes:

1. The information of integrated graphics are not applicable for the models without integrated graphics (for the details, please refer to processor section)

Monitor Support

Monitor Support

Supports up to 3 independent displays via onboard ports (HDMI and 2x DisplayPort), more displays support via discrete graphics

Chipset

Chipset

AMD PRO 565 chipset

Memory^[1]

Max Memory^[2]

Up to 128GB DDR4-3200

Memory Slots

Four DDR4 DIMM slots, dual-channel capable

Memory Type**^[3]

- DDR4-1866
- DDR4-2133
- DDR4-2400
- DDR4-2666
- DDR4-3200

Notes:

1. Recommend to choose the models with more than 4GB for better performance and experience
2. The max memory is based on the test results with current Lenovo® memory offerings. The system may support more memory as the technology develops.
3. Installed memory is actually 3200MHz, but may run at 1866MHz, 2133MHz, 2400MHz or 2666MHz depending on the memory support capability of processor

Storage

Storage Support

Up to three drives, 1x 2.5"/3.5" HDD + 1x 2.5" HDD + 1x M.2 SSD

- 2.5" HDD up to 1TB each

ThinkCentre M75t Gen 2

- 3.5" HDD up to 2TB
- M.2 SSD up to 2TB

Storage Type***

Disk Type	Interface	RPM	Security
2.5" SATA HDD	SATA 6Gb/s	7.2K	-
3.5" SATA HDD	SATA 6Gb/s	7.2K	-
M.2 2242 SSD	PCIe NVMe, PCIe 3.0 x2	-	-
M.2 2242 SSD	PCIe NVMe, PCIe 3.0 x4	-	-
M.2 2280 SSD	PCIe NVMe, PCIe 3.0 x4	-	Opal

RAID

RAID 0/1 support for HDDs (RAID preset only available via special bid model)

Removable Storage

Optical**

- DVD-ROM, SATA 1.5Gb/s, slim (9.0mm)
- DVD burner (DVD±RW), SATA 1.5Gb/s, slim (9.0mm)
- None

Card Reader

- 3-in-1 card reader (SD, SDHC, SDXC)
- No card reader

Multi-Media

Audio Chip

High Definition (HD) Audio, Realtek® ALC623-CG codec

Speakers

- Single speaker, 2W x1
- No speakers

Power Supply

Power Supply**

Power	Type	Efficiency	Key Features
180W	Fixed	85%	-
260W	Fixed	85%	-
310W	Fixed	92%	-

DESIGN

Input Device

Keyboard**

- Lenovo Calliope Keyboard (USB connector), black
- Lenovo Calliope Wireless Keyboard (2.4GHz via USB receiver), black
- Lenovo Traditional Keyboard (USB connector), black
- No keyboard

Mouse**

- Lenovo Calliope Mouse (USB connector), black
- Lenovo Calliope Wireless Mouse (2.4GHz via USB receiver), black
- Lenovo Fingerprint Mouse (USB connector), Windows Hello support, black
- No mouse

Mechanical

Form Factor

Tower (13.6L)

Dimensions (WxDxH)

Models	Dimensions
All models	145 x 296 x 346 mm (5.7 x 11.7 x 13.6 inches)

Weight

Models	Weight
All models	4.8 kg (10.6 lbs)

Case Color

Black

Bays

- 1x 2.5" disk bay (bay comes with disk)
- 1x 3.5" disk bay
- 1x slim ODD bay

Expansion Slots

- One PCIe 3.0 x1, full-height (length < 215mm)
- One PCIe 3.0 x16, full-height (length < 215mm)
- Two M.2 slots (one for WLAN, one for SSD)

EOU

EOU design for HDD

CONNECTIVITY**Network^[1]****Onboard Ethernet****

- Gigabit Ethernet, Realtek RTL8111HN, 1x RJ45, supports Wake-on-LAN
- Gigabit Ethernet, Realtek RTL8111EPV, 1x RJ45, supports Wake-on-LAN

Optional Ethernet^[2]**

- Gigabit Ethernet, Bitland BN8E88, 1x RJ-45, PCIe x1
- Gigabit Ethernet, Bitland RTL8111FP, 1x RJ-45, PCIe x1
- No optional Ethernet

WLAN + Bluetooth®**

- Realtek RTL8852AE, Wi-Fi® 6, 802.11ax Dual Band 2x2 Wi-Fi + Bluetooth 5.2, M.2 card
- Realtek RTL8822CE, 802.11ac Dual Band 2x2 Wi-Fi + Bluetooth 5.0, M.2 card
- Intel® Wireless-AC 9260, 802.11ac Dual Band 2x2 Wi-Fi + Bluetooth 5.0, M.2 card
- No WLAN and Bluetooth

Notes:

1. This system does not support Power Over Ethernet (PoE). If the system is used in a PoE environment, then a Network Isolator is required to prevent possible damage to the system, PoE equipment, or both.
2. RTL8111FP is not available for AP countries.

Ports^[1]**Front Ports**

- 2x USB 3.2 Gen 1
- 2x USB 3.2 Gen 2
- 1x USB-C 3.2 Gen 1
- 1x headphone / microphone combo jack (3.5mm)
- 1x microphone (3.5mm)

Optional Front Ports

- 1x card reader
- None

Rear Ports^[2]

- 4x USB 2.0
- 1x HDMI
- 2x DisplayPort

ThinkCentre M75t Gen 2

- 1x serial (9-pin)
- 1x Ethernet (RJ-45)
- 1x line-out (3.5mm)

Optional Rear Ports***

- 2x USB 3.2 Gen 1 (via 2-port USB expansion card, PCIe x1)
- 2x USB-C 3.2 Gen 2 (via 2-port USB-C expansion card, PCIe x4)
- 1x serial
- 1x parallel
- None

Notes:

1. The transfer speed of following ports will vary and, depending on many factors, such as the processing speed of the host device, file attributes and other factors related to system configuration and your operating environment, will be slower than theoretical speed.
 USB 2.0: 480 Mbit/s;
 USB 3.2 Gen 1 (SuperSpeed USB 5Gbps, formerly USB 3.0 / USB 3.1 Gen 1): 5 Gbit/s;
 USB 3.2 Gen 2 (SuperSpeed USB 10Gbps, formerly USB 3.1 Gen 2): 10 Gbit/s;
 USB 3.2 Gen 2x2 (SuperSpeed USB 20Gbps): 20 Gbit/s;
 Thunderbolt™ 3: 40 Gbit/s;
 FireWire 400: 400 Mbit/s;
 FireWire 800: 800 Mbit/s
2. For video ports on discrete graphics, please see graphics section

Monitor Cable

Monitor Cable***

- DP to dual DP dongle
- DP to DVI-D dongle
- DP to HDMI 1.4 dongle
- DP to VGA cable (1.5M)
- DP to VGA dongle
- HDMI to DVI dongle
- HDMI to HDMI cable (1.5m)
- HDMI to VGA dongle
- No monitor cable

SECURITY & PRIVACY

Security

Security Chip

Discrete TPM 2.0, TCG certified

Physical Locks

- (Optional) E-lock
- (Optional) Smart Cable Clip
- Kensington® Security Slot

Chassis Intrusion Switch

- Chassis intrusion switch
- No chassis intrusion switch

Fingerprint Reader

- Touch style fingerprint reader on mouse
- No fingerprint reader

BIOS Security

- Administrator password
- Power-on password
- Hard disk password
- Boot sequence control
- Boot without keyboard and mouse
- Smart USB protection (allows keyboard / mouse only, blocks all storage devices)
- Individual USB port disablement

MANAGEABILITY

System Management

System Management^[1]

- DASH 1.1
- No DASH

Notes:

1. DASH 1.1 is an optional feature for the selected MTs

SERVICE

Warranty

Base Warranty**

- 1-year depot service
- 1-year limited onsite service
- 3-year limited onsite service
- No base warranty

ENVIRONMENTAL

Operating Environment

Temperature

- Operating: 5°C (41°F) to 35°C (95°F)
- Storage: -40°C (-40°F) to 60°C (140°F)

Humidity

- Operating: 20% to 80%
- Storage: 10% to 90%

Altitude

- Operating: -15.2 m (-50 ft) to 3048 m (10,000 ft)
- Storage: -15.2 m (-50 ft) to 12192 m (40,000 ft)

CERTIFICATIONS

Green Certifications

Green Certifications^[1]

- (Optional) EPEAT™ Gold
- (Optional) EPEAT Silver
- (Optional) ENERGY STAR® 8.0
- ErP Lot 3
- TCO Certified 8.0
- RoHS compliant

Notes:

1. ENERGY STAR 8.0 and EPEAT are only available for MT 11KB/11KC

Other Certifications

Other Certifications

- (Optional) TÜV Rheinland® Low Noise
- (Optional) TÜV Rheinland Ultra Low Noise

Mil-Spec Test

MIL-STD-810H military test passed (Low Pressure [Altitude], High Temperature, Low Temperature, Temperature Shock, Humidity, Sand and Dust, Vibration, Shock, Fungus, Solar Radiation)

- Feature with ** means that only one offering listed under the feature is configured on selected models.
- Feature with *** means that one or more offerings listed under the feature could be configured on selected models.
- Lenovo reserves the right to change specifications or other product information without notice. Lenovo is not responsible for photographic or typographical errors. LENOVO PROVIDES THIS PUBLICATION “AS IS,” WITHOUT WARRANTY OF ANY KIND, EITHER EXPRESS OR IMPLIED, INCLUDING THE IMPLIED WARRANTIES OF MERCHANTABILITY OR FITNESS FOR A PARTICULAR PURPOSE. Some jurisdictions do not allow disclaimer of express or implied warranties in certain transactions, therefore this disclaimer may not apply to you.
- The specifications on this page may not be available in all regions, and may be changed or updated without notice.



AMD



AMD



AMD

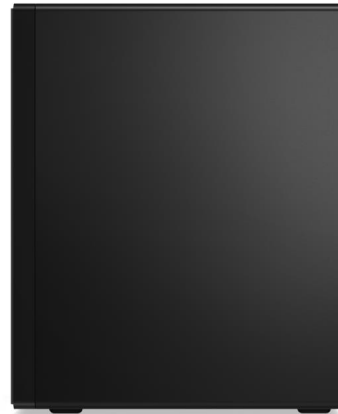

AMD

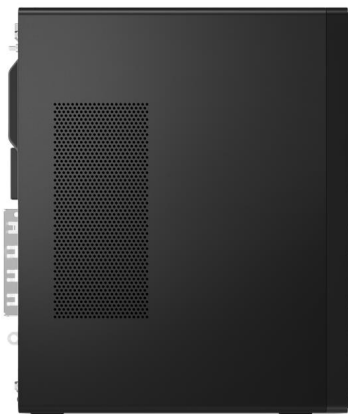

AMD



AMD

OVERVIEW

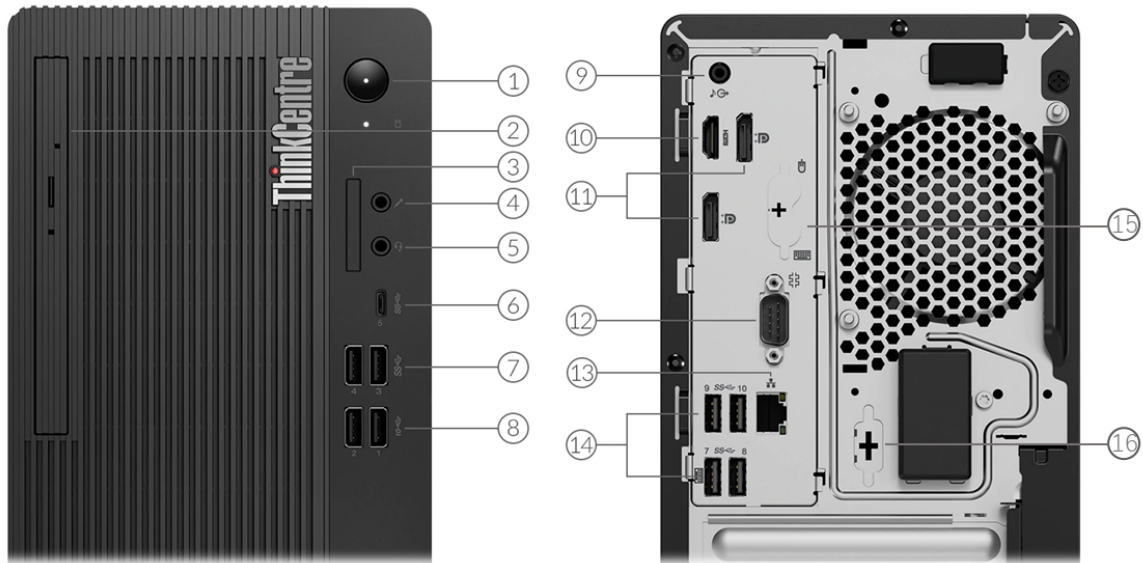

1. Optical drive *	9. Line-out (3.5mm)
2. Power button	10. HDMI
3. Card reader *	11. 2x DisplayPort
4. Microphone (3.5mm)	12. Serial
5. Headphone / microphone combo jack (3.5mm)	13. Ethernet (RJ-45)
6. USB-C 3.2 Gen 1	14. 4x USB 3.2 Gen 1
7. 2x USB 3.2 Gen 1	15. 2x PS/2 ports (keyboard / mouse) *
8. 2x USB 3.2 Gen 2	16. Serial *

Notes:

- Ports with * are only available on selected models
- More ports are available through the optional expansion cards (not shown on the sample product above)

PERFORMANCE

Processor

Processor Family

Intel® Celeron®, Intel Pentium®, or 10th Generation Intel Core™ i3 / i5 / i7 / i9 Processor

Processor**

Processor Name	Cores	Threads	Base Frequency	Max Frequency	Cache	Memory Support	Processor Graphics
Celeron G5900	2	2	3.4GHz	-	2MB	DDR4-2666	Intel UHD Graphics 610
Celeron G5905	2	2	3.5GHz	-	4MB	DDR4-2666	Intel UHD Graphics 610
Celeron G5920	2	2	3.5GHz	-	2MB	DDR4-2666	Intel UHD Graphics 610
Celeron G5925	2	2	3.6GHz	-	4MB	DDR4-2666	Intel UHD Graphics 610
Pentium Gold G6400	2	4	4.0GHz	-	4MB	DDR4-2666	Intel UHD Graphics 610
Pentium Gold G6500	2	4	4.1GHz	-	4MB	DDR4-2666	Intel UHD Graphics 630
Pentium Gold G6600	2	4	4.2GHz	-	4MB	DDR4-2666	Intel UHD Graphics 630
Core i3-10100	4	8	3.6GHz	4.3GHz	6MB	DDR4-2666	Intel UHD Graphics 630
Core i3-10300	4	8	3.7GHz	4.4GHz	8MB	DDR4-2666	Intel UHD Graphics 630
Core i3-10320	4	8	3.8GHz	4.6GHz	8MB	DDR4-2666	Intel UHD Graphics 630
Core i5-10400	6	12	2.9GHz	4.3GHz	12MB	DDR4-2666	Intel UHD Graphics 630
Core i5-10400F	6	12	2.9GHz	4.3GHz	12MB	DDR4-2666	-
Core i5-10500	6	12	3.1GHz	4.5GHz	12MB	DDR4-2666	Intel UHD Graphics 630
Core i5-10600	6	12	3.3GHz	4.8GHz	12MB	DDR4-2666	Intel UHD Graphics 630
Core i7-10700	8	16	2.9GHz	4.8GHz	16MB	DDR4-2933	Intel UHD Graphics 630
Core i7-10700F	8	16	2.9GHz	4.8GHz	16MB	DDR4-2933	-
Core i9-10900	10	20	2.8GHz	5.2GHz	20MB	DDR4-2933	Intel UHD Graphics 630
Core i9-10900F	10	20	2.8GHz	5.2GHz	20MB	DDR4-2933	-

Operating System

Operating System**

- Windows® 10 Pro 64
- Windows 10 Home 64
- Windows 10 IoT Enterprise
- Ubuntu Linux
- No operating system

Graphics

Graphics**[1]

Graphics	Type	Memory	Connector	Max Resolution	Key Features
Intel UHD graphics 610	Integrated	Shared	1x HDMI®, 2x DP	1920x1080@60Hz(HDMI), 4096x2304@60Hz(DP)	DirectX® 12
Intel UHD graphics 630	Integrated	Shared	1x HDMI, 2x DP	1920x1080@60Hz(HDMI), 4096x2304@60Hz(DP)	DirectX 12
AMD Radeon™ 520	Discrete	2GB GDDR5	2x DP 1.2	4096x2160@60Hz(DP)	DirectX 12
AMD Radeon RX 550X	Discrete	4GB GDDR5	1x HDMI 2.0, 1x VGA, 1x DP 1.4	4096x2160@60Hz(HDMI), 2048x1536@85Hz(VGA), 3840x2160@60Hz(DP)	DirectX 12
NVIDIA® GeForce® GT 730	Discrete	2GB GDDR5	1x VGA, 1x HDMI 1.4	2048x1536@75Hz(VGA), 3840x2160@30Hz(HDMI)	DirectX 12

Notes:

- The information of integrated graphics are not applicable for the models without integrated graphics (for the details, please refer to processor section)

Monitor Support

Monitor Support^[1]

Supports up to 3 independent displays via onboard ports (HDMI and 2x DisplayPort™), more displays support via discrete graphics

Notes:

- Onboard video ports are only available for the models with integrated graphics

Chipset

Chipset

Intel Q470 chipset

Memory

Max Memory^[1]

Up to 128GB DDR4-2933

Memory Slots

Four DDR4 DIMM slots, dual-channel capable

Memory Type**

- DDR4-2666
- DDR4-2933

Notes:

- The max memory is based on the test results with current Lenovo® memory offerings. The system may support more memory as the technology develops.

Storage

Storage Support

Up to three drives, 1x 2.5"/3.5" HDD + 1x 2.5" HDD + 1x M.2 SSD

- 2.5" HDD up to 1TB each
- 3.5" HDD up to 2TB
- M.2 SSD up to 2TB
- Optional Intel Optane™ Memory, M.2

Storage Type***

Disk Type	Interface	RPM	Security
2.5" SATA HDD	SATA 6Gb/s	7.2K	-
3.5" SATA HDD	SATA 6Gb/s	7.2K	-
M.2 2242 SSD	PCIe NVMe, PCIe 3.0 x2	-	-
M.2 2280 SSD	PCIe NVMe, PCIe 3.0 x4	-	Opal
M.2 2280 SSD	PCIe NVMe, PCIe 3.0 x4	-	-
Intel Optane Memory M10	PCIe NVMe, PCIe 3.0 x2	-	-

RAID

RAID 0/1 support for HDDs (RAID preset only available via special bid model)

Removable Storage

Optical**

- DVD-ROM, SATA 1.5Gb/s, slim (9.0mm)
- DVD burner (DVD±RW), SATA 1.5Gb/s, slim (9.0mm)
- None

Card Reader

- 3-in-1 card reader (SD, SDHC, SDXC)
- No card reader

Multi-Media

Audio Chip

High Definition (HD) Audio, Realtek® ALC623-CG codec

Speakers

Single speaker, 2W x1

Power Supply

Power Supply**

Power	Type	Efficiency	Key Features
180W	Fixed	85%	-
260W	Fixed	85%	-
310W	Fixed	92%	-
380W	Fixed	92%	-

DESIGN

Input Device

Keyboard**

- Lenovo Calliope Keyboard (USB connector), black
- Lenovo Calliope Wireless Keyboard (2.4GHz via USB receiver), black
- Lenovo Traditional Keyboard (USB connector), black
- No keyboard

Mouse**

- Lenovo Calliope Mouse (USB connector), black
- Lenovo Calliope Wireless Mouse (2.4GHz via USB receiver), black
- Lenovo Fingerprint Mouse (USB connector), Windows Hello support, black
- No mouse

Mechanical

Form Factor

Tower (13.6L)

Dimensions (WxDxH)

Models	Dimensions
All models	145 x 296 x 346 mm (5.7 x 11.7 x 13.6 inches)

Weight

Models	Weight
All models	4.8 kg (10.6 lbs)

Case Color

Black

Bays

- 1x 2.5" disk bay (optional, or bay comes with disk)
- 1x 3.5" disk bay
- 1x slim ODD bay

Expansion Slots

- One PCIe 3.0 x1, full-height (length < 215mm)
- One PCIe 3.0 x4, full-height (length < 215mm)
- One PCIe 3.0 x16, full-height (length < 215mm)
- One dummy slot, only bracket for optional port extension
- Two M.2 slots (one for WLAN, one for SSD)

Others

- (Optional) Dust filter
- Supports Smart Power On

CONNECTIVITY**Network****Onboard Ethernet**

Gigabit Ethernet, Intel Ethernet Connection I219-LM, 1x RJ45, supports Wake-on-LAN

Optional Ethernet**

- Gigabit Ethernet, Bitland BN8E88, 1x RJ-45, PCIe x1
- Gigabit Ethernet, Intel Ethernet Server Adapter I350-T4, 4x RJ-45, PCIe x4
- No optional Ethernet

WLAN + Bluetooth®**

- Realtek RTL8822CE, 802.11ac Dual Band 2x2 Wi-Fi® + Bluetooth 5.0, M.2 card
- Intel Wireless-AC 9560, 802.11ac Dual Band 2x2 Wi-Fi + Bluetooth 5.0, M.2 card
- Intel Wi-Fi 6 AX201, 802.11ax 2x2 Wi-Fi + Bluetooth 5.1, Intel vPro technology support, M.2 Card
- No WLAN and Bluetooth

Ports^[1]**Front Ports**

- 2x USB 3.2 Gen 1
- 2x USB 3.2 Gen 2
- 1x USB-C 3.2 Gen 1
- 1x headphone / microphone combo jack (3.5mm)
- 1x microphone (3.5mm)

Optional Front Ports

- 1x card reader
- None

Rear Ports^[2]

- 4x USB 3.2 Gen 1
- 1x HDMI
- 2x DisplayPort
- 1x serial (9-pin)
- 1x Ethernet (RJ-45)
- 1x line-out (3.5mm)

Optional Rear Ports***

- 2x USB 2.0 (via 2-port adapter)
- 2x USB 3.2 Gen 1 (via 2-port USB expansion card, PCIe x1)
- 2x USB-C 3.2 Gen 2 (via 2-port USB-C expansion card, PCIe x4)
- 1x serial
- 4x serial (via 4-port serial expansion card, PCIe x1)
- 1x parallel
- 2x PS/2

Notes:

1. The transfer speed of following ports will vary and, depending on many factors, such as the processing speed of the host device, file attributes and other factors related to system configuration and your operating environment, will be slower than theoretical speed.
USB 2.0: 480 Mbit/s;
USB 3.2 Gen 1 (SuperSpeed USB 5Gbps, formerly USB 3.0 / USB 3.1 Gen 1): 5 Gbit/s;
USB 3.2 Gen 2 (SuperSpeed USB 10Gbps, formerly USB 3.1 Gen 2): 10 Gbit/s;
USB 3.2 Gen 2x2 (SuperSpeed USB 20Gbps): 20 Gbit/s;
Thunderbolt™ 3: 40 Gbit/s;
FireWire 400: 400 Mbit/s;
FireWire 800: 800 Mbit/s
2. For video ports on discrete graphics, please see graphics section

Monitor Cable**Monitor Cable*****

- DP to dual DP dongle
- DP to DVI-D dongle
- DP to HDMI 1.4 dongle
- DP to VGA cable (1.5M)
- DP to VGA dongle
- HDMI to HDMI cable (1.5m)
- HDMI to VGA dongle
- No monitor cable

SECURITY & PRIVACY

Security

Security Chip

Discrete TPM 2.0, TCG certified

Physical Locks

- (Optional) E-lock
- (Optional) Smart Cable Clip
- Kensington® Security Slot
- Padlock Loop

Chassis Intrusion Switch

- Chassis intrusion switch
- No chassis intrusion switch

Fingerprint Reader

- Touch style fingerprint reader on mouse
- No fingerprint reader

BIOS Security

- Administrator password
- Power-on password
- Hard disk password
- Boot sequence control
- Boot without keyboard and mouse
- Smart USB protection (allows keyboard / mouse only, blocks all storage devices)
- Individual USB port disablement

MANAGEABILITY

System Management

System Management¹

- Intel vPro with Intel AMT 14.0
- None

Notes:

1. Require choosing a vPro-support Wi-Fi adapter to enable vPro function through wireless connection

SERVICE

Warranty

Base Warranty**

- 1-year depot service
- 1-year limited onsite service
- 3-year limited onsite service
- No base warranty

ENVIRONMENTAL

Operating Environment

Temperature

- Operating: 5°C (41°F) to 35°C (95°F)
- Storage: -40°C (-40°F) to 60°C (140°F)

Humidity

- Operating: 20% to 80%
- Storage: 10% to 90%

Altitude

- Operating: -15.2 m (-50 ft) to 3048 m (10,000 ft)
- Storage: -15.2 m (-50 ft) to 12192 m (40,000 ft)

CERTIFICATIONS

Green Certifications

Green Certifications¹

- (Optional) EPEAT™ Gold
- (Optional) EPEAT Silver
- (Optional) ENERGY STAR® 8.0
- ErP Lot 3
- TCO Certified 8.0
- RoHS compliant

Notes:

1. ENERGY STAR 8.0 and EPEAT are only available for MT 11CS/11CT

Other Certifications

Other Certifications

- (Optional) TÜV Rheinland® Low Noise
- (Optional) TÜV Rheinland Ultra Low Noise

- Feature with ** means that only one offering listed under the feature is configured on selected models.
- Feature with *** means that one or more offerings listed under the feature could be configured on selected models.
- Lenovo reserves the right to change specifications or other product information without notice. Lenovo is not responsible for photographic or typographical errors. LENOVO PROVIDES THIS PUBLICATION “AS IS,” WITHOUT WARRANTY OF ANY KIND, EITHER EXPRESS OR IMPLIED, INCLUDING THE IMPLIED WARRANTIES OF MERCHANTABILITY OR FITNESS FOR A PARTICULAR PURPOSE. Some jurisdictions do not allow disclaimer of express or implied warranties in certain transactions, therefore this disclaimer may not apply to you.
- The specifications on this page may not be available in all regions, and may be changed or updated without notice.

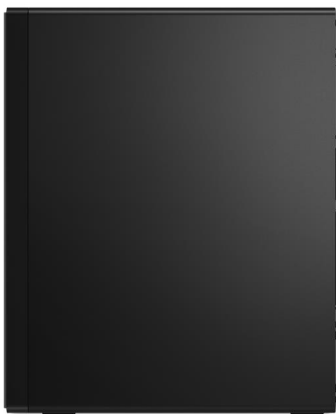
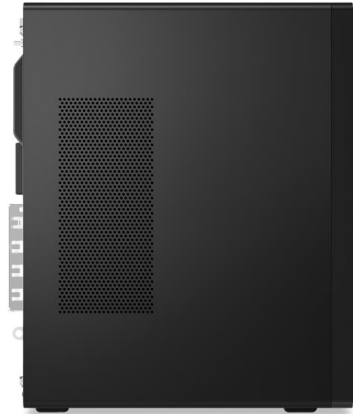

OVERVIEW

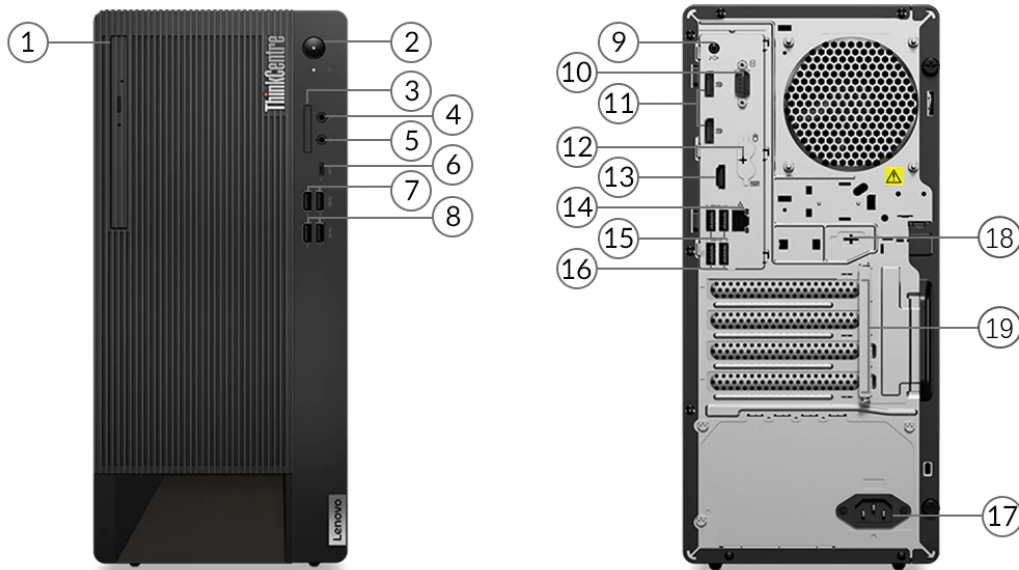

1. Optical drive *	11. 2x DisplayPort
2. Power button	12. 2x PS/2 ports (keyboard / mouse) *
3. Card reader *	13. Optional Video Port (HDMI / DP / USB-C) *
4. Microphone (3.5mm)	14. Ethernet (RJ-45)
5. Headphone / microphone combo jack (3.5mm)	15. 2x USB 3.2 Gen 1
6. USB-C 3.2 Gen 1	16. 2x USB 3.2 Gen 1
7. 2x USB 3.2 Gen 1	17. Power connector
8. 2x USB 3.2 Gen 2	18. Serial *
9. Line-out (3.5mm)	19. Optional ports on expansion cards *
10. Serial	

Notes:

- Ports with * are only available on selected models

PERFORMANCE

Processor

Processor Family

Intel® Celeron®, Intel Pentium®, or 10th Generation Intel Core™ i3 / i5 / i7 / i9 Processor

Processor**

Processor Name	Cores	Threads	Base Frequency	Max Frequency	Cache	Memory Support	Processor Graphics
Celeron G5900	2	2	3.4GHz	-	2MB	DDR4-2666	Intel UHD Graphics 610
Celeron G5905	2	2	3.5GHz	-	4MB	DDR4-2666	Intel UHD Graphics 610
Celeron G5920	2	2	3.5GHz	-	2MB	DDR4-2666	Intel UHD Graphics 610
Celeron G5925	2	2	3.6GHz	-	4MB	DDR4-2666	Intel UHD Graphics 610
Pentium Gold G6400	2	4	4.0GHz	-	4MB	DDR4-2666	Intel UHD Graphics 610
Pentium Gold G6500	2	4	4.1GHz	-	4MB	DDR4-2666	Intel UHD Graphics 630
Pentium Gold G6600	2	4	4.2GHz	-	4MB	DDR4-2666	Intel UHD Graphics 630
Core i3-10100	4	8	3.6GHz	4.3GHz	6MB	DDR4-2666	Intel UHD Graphics 630
Core i3-10300	4	8	3.7GHz	4.4GHz	8MB	DDR4-2666	Intel UHD Graphics 630
Core i3-10320	4	8	3.8GHz	4.6GHz	8MB	DDR4-2666	Intel UHD Graphics 630
Core i5-10400	6	12	2.9GHz	4.3GHz	12MB	DDR4-2666	Intel UHD Graphics 630
Core i5-10400F	6	12	2.9GHz	4.3GHz	12MB	DDR4-2666	-
Core i5-10500	6	12	3.1GHz	4.5GHz	12MB	DDR4-2666	Intel UHD Graphics 630
Core i5-10600	6	12	3.3GHz	4.8GHz	12MB	DDR4-2666	Intel UHD Graphics 630
Core i7-10700	8	16	2.9GHz	4.8GHz	16MB	DDR4-2933	Intel UHD Graphics 630
Core i7-10700F	8	16	2.9GHz	4.8GHz	16MB	DDR4-2933	-
Core i9-10900	10	20	2.8GHz	5.2GHz	20MB	DDR4-2933	Intel UHD Graphics 630
Core i9-10900F	10	20	2.8GHz	5.2GHz	20MB	DDR4-2933	-

Operating System

Operating System**

- Windows® 10 Pro 64
- Windows 10 Home 64
- Windows 10 IoT Enterprise
- Ubuntu Linux
- No operating system

Graphics

Graphics**[1]

Graphics	Type	Memory	Connector	Max Resolution	Key Features
Intel UHD graphics 610	Integrated	Shared	2x DP, 1x optional video port (HDMI® / 3rd DP / USB-C)	4096x2160@24Hz(onboard HDMI), 4096x2304@60Hz(DP), 4096x2304@60Hz(USB-C)	DirectX® 12
Intel UHD graphics 630	Integrated	Shared	2x DP, 1x optional video port (HDMI / 3rd DP / USB-C)	4096x2160@24Hz(onboard HDMI), 4096x2304@60Hz(DP), 4096x2304@60Hz(USB-C)	DirectX 12
AMD Radeon™ 520	Discrete	2GB GDDR5	2x DP 1.2	4096x2160@60Hz(DP)	DirectX 12
AMD Radeon RX 550X	Discrete	4GB GDDR5	1x HDMI 2.0, 1x VGA, 1x DP 1.4	4096x2160@60Hz(HDMI), 2048x1536@85Hz(VGA), 3840x2160@60Hz(DP)	DirectX 12
NVIDIA®	Discrete	2GB	1x VGA, 1x HDMI 1.4	2048x1536@75Hz(VGA),	DirectX 12

GeForce® GT 730		GDDR5		3840x2160@30Hz(HDMI)	
NVIDIA GeForce GTX 1660 SUPER	Discrete	6GB GDDR6	1x HDMI 2.0b, 1x DP 1.4, 1x DVI-D	4096x2160@60Hz(HDMI), 7680x4320@60Hz with DSC(DP), 2560x1600@60Hz(DVI-D)	DirectX 12, PCIe 3.0 x16, 125 watts, occupies two slots
NVIDIA GeForce RTX™ 2060	Discrete	6GB GDDR6	1x HDMI 3x DP	4096x2160@60Hz(HDMI), 7680x4320@60Hz with DSC(DP)	DirectX 12, PCIe 3.0 x16, 125 watts

Notes:

- The information of integrated graphics are not applicable for the models without integrated graphics (for the details, please refer to processor section)

Monitor Support

Monitor Support^[1]

Supports up to 3 independent displays via onboard ports (2x DisplayPort™ and 1x optional port [HDMI / 3rd DP / USB-C]), more displays support via discrete graphics

Notes:

- Onboard video ports are only available for the models with integrated graphics

Chipset

Chipset

Intel Q470 chipset

Memory

Max Memory^[1]

Up to 128GB DDR4-2933

Memory Slots

Four DDR4 DIMM slots, dual-channel capable

Memory Type**

- DDR4-2666
- DDR4-2933

Notes:

- The max memory is based on the test results with current Lenovo® memory offerings. The system may support more memory as the technology develops.

Storage

Storage Support

Up to five drives, 2x 2.5"/3.5" HDD + 1x 2.5" HDD + 2x M.2 SSD

- 2.5" HDD up to 1TB each
- 3.5" HDD up to 2TB each
- M.2 SSD up to 2TB each
- Optional Intel Optane™ Memory, M.2

Storage Type***

Disk Type	Interface	RPM	Security
2.5" SATA HDD	SATA 6Gb/s	7.2K	-
3.5" SATA HDD	SATA 6Gb/s	7.2K	-
M.2 2242 SSD	PCIe NVMe, PCIe 3.0 x2	-	-
M.2 2280 SSD	PCIe NVMe, PCIe 3.0 x4	-	Opal
Intel Optane Memory M10	PCIe NVMe, PCIe 3.0 x2	-	-

RAID

RAID 0/1 support (RAID preset only available via special bid model)

Removable Storage

Optical**

- DVD-ROM, SATA 1.5Gb/s, slim (9.0mm)
- DVD burner (DVD±RW), SATA 1.5Gb/s, slim (9.0mm)
- None

Card Reader

- 3-in-1 card reader (SD, SDHC, SDXC)
- No card reader

Multi-Media

Audio Chip

High Definition (HD) Audio, Realtek® ALC623-CG codec

Speakers

Single speaker, 2W x1

Power Supply

Power Supply**

Power	Type	Efficiency	Key Features
180W	Fixed	85%	-
300W	Fixed	85%	-
300W	Fixed	90%	-
500W	Fixed	92%	-

DESIGN

Input Device

Keyboard**

- Lenovo Calliope Keyboard (USB connector), black
- Lenovo Calliope Wireless Keyboard (2.4GHz via USB receiver), black
- Lenovo Traditional Keyboard (USB connector), black
- No keyboard

Mouse**

- Lenovo Calliope Mouse (USB connector), black
- Lenovo Calliope Wireless Mouse (2.4GHz via USB receiver), black
- Lenovo Fingerprint Mouse (USB connector), Windows Hello support, black
- No mouse

Mechanical

Form Factor

Tower (17L)

Dimensions (WxDxH)

Models	Dimensions
All models	170 x 298 x 376 mm (6.7 x 11.7 x 14.8 inches)

Weight

Models	Weight
All models	6.5 kg (14.3 lbs)

Case Color

Black

Bays

- 1x 2.5" disk bay (bay comes with disk)

- 1x 3.5" disk bay
- 1x 3.5" disk bay (optional, or bay comes with disk)
- 1x slim ODD bay

Expansion Slots

- One PCIe 3.0 x1, full-height (length < 245mm)
- One PCIe 3.0 x4, full-height (length < 245mm)
- One PCIe 3.0 x16, full-height (length < 245mm)
- One dummy slot, only bracket for optional port extension
- Three M.2 slots (one for WLAN, two for SSD)

Others

- (Optional) Dust filter
- Supports Smart Power On

CONNECTIVITY

Network

Onboard Ethernet

Gigabit Ethernet, Intel Ethernet Connection I219-LM, 1x RJ45, supports Wake-on-LAN

Optional Ethernet**

- Gigabit Ethernet, Bitland BN8E88, 1x RJ-45, PCIe x1
- Gigabit Ethernet, Intel Ethernet Server Adapter I350-T4, 4x RJ-45, PCIe x4
- 2.5 Gigabit Ethernet, Realtek RTL8125BS, 1x RJ-45, PCIe x1
- No optional Ethernet

WLAN + Bluetooth®**

- Realtek RTL8822CE, 802.11ac Dual Band 2x2 Wi-Fi® + Bluetooth 5.0, M.2 card
- Intel Wireless-AC 9560, 802.11ac Dual Band 2x2 Wi-Fi + Bluetooth 5.0, M.2 card
- Intel Wi-Fi 6 AX201, 802.11ax 2x2 Wi-Fi + Bluetooth 5.1, Intel vPro technology support, M.2 Card
- No WLAN and Bluetooth

Ports^[1]

Front Ports

- 2x USB 3.2 Gen 1
- 2x USB 3.2 Gen 2
- 1x USB-C 3.2 Gen 1
- 1x headphone / microphone combo jack (3.5mm)
- 1x microphone (3.5mm)

Optional Front Ports

- 1x card reader
- None

Rear Ports^[2]

- 4x USB 3.2 Gen 1
- 2x DisplayPort
- 1x serial (9-pin)
- 1x Ethernet (RJ-45)
- 1x line-out (3.5mm)

Optional Rear Ports***

- 2x USB 2.0 (via 2-port adapter)
- 2x USB 3.2 Gen 1 (via 2-port USB expansion card, PCIe x1)
- 2x USB-C 3.2 Gen 2 (via 2-port USB-C expansion card, PCIe x4)
- Optional video port (one of HDMI / DisplayPort / USB-C 3.2 Gen 1 with DisplayPort function)
- 1x serial
- 4x serial (via 4-port serial expansion card, PCIe x1)
- 1x parallel
- 2x PS/2

Notes:

1. The transfer speed of following ports will vary and, depending on many factors, such as the processing speed of the host device, file attributes and other factors related to system configuration and your operating environment, will be slower than theoretical speed.

USB 2.0: 480 Mbit/s;
USB 3.2 Gen 1 (SuperSpeed USB 5Gbps, formerly USB 3.0 / USB 3.1 Gen 1): 5 Gbit/s;
USB 3.2 Gen 2 (SuperSpeed USB 10Gbps, formerly USB 3.1 Gen 2): 10 Gbit/s;
USB 3.2 Gen 2x2 (SuperSpeed USB 20Gbps): 20 Gbit/s;
Thunderbolt™ 3: 40 Gbit/s;
FireWire 400: 400 Mbit/s;
FireWire 800: 800 Mbit/s

2. For video ports on discrete graphics, please see graphics section

Monitor Cable

Monitor Cable***

- DP to dual DP dongle
- DP to DVI-D dongle
- DP to HDMI 1.4 dongle
- DP to VGA cable (1.5M)
- DP to VGA dongle
- No monitor cable

SECURITY & PRIVACY

Security

Security Chip

Discrete TPM 2.0, TCG certified

Physical Locks

- (Optional) E-lock
- (Optional) Smart Cable Clip
- Kensington® Security Slot
- Padlock Loop

Chassis Intrusion Switch

- Chassis intrusion switch
- No chassis intrusion switch

Fingerprint Reader

- Touch style fingerprint reader on mouse
- No fingerprint reader

BIOS Security

- Administrator password
- Power-on password
- Hard disk password
- Boot sequence control
- Boot without keyboard and mouse
- Self-healing BIOS
- Smart USB protection (allows keyboard / mouse only, blocks all storage devices)
- Individual USB port disablement

MANAGEABILITY

System Management

System Management^[1]

- Intel vPro with Intel AMT 14.0
- None

Notes:

1. Require choosing a vPro-support Wi-Fi adapter to enable vPro function through wireless connection

SERVICE

Warranty

Base Warranty**

- 1-year limited onsite service
- 3-year limited onsite service
- No base warranty

ENVIRONMENTAL**Operating Environment****Temperature**

- Operating: 5°C (41°F) to 35°C (95°F)
- Storage: -40°C (-40°F) to 60°C (140°F)

Humidity

- Operating: 20% to 80%
- Storage: 10% to 90%

Altitude

- Operating: -15.2 m (-50 ft) to 3048 m (10,000 ft)
- Storage: -15.2 m (-50 ft) to 12192 m (40,000 ft)

CERTIFICATIONS**Green Certifications****Green Certifications**

- EPEAT™ Gold
- EPEAT Silver
- ENERGY STAR® 8.0 (only available for MT 11D0/11CY)
- ErP Lot 3
- TCO Certified 8.0
- RoHS compliant

Other Certifications**Other Certifications**

(Optional) TÜV Rheinland® Ultra Low Noise

- Feature with ** means that only one offering listed under the feature is configured on selected models.
- Feature with *** means that one or more offerings listed under the feature could be configured on selected models.
- Lenovo reserves the right to change specifications or other product information without notice. Lenovo is not responsible for photographic or typographical errors. LENOVO PROVIDES THIS PUBLICATION “AS IS,” WITHOUT WARRANTY OF ANY KIND, EITHER EXPRESS OR IMPLIED, INCLUDING THE IMPLIED WARRANTIES OF MERCHANTABILITY OR FITNESS FOR A PARTICULAR PURPOSE. Some jurisdictions do not allow disclaimer of express or implied warranties in certain transactions, therefore this disclaimer may not apply to you.
- The specifications on this page may not be available in all regions, and may be changed or updated without notice.

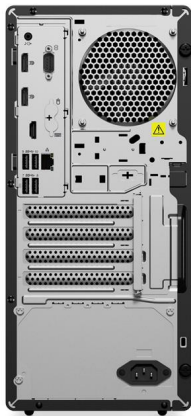

OVERVIEW

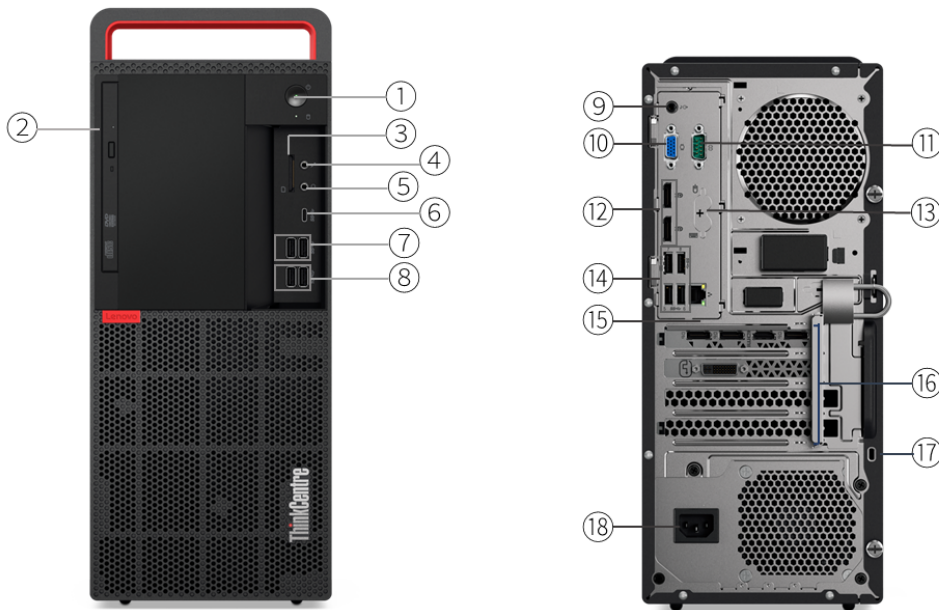

1. Power button	10. VGA
2. Optical drive *	11. Serial
3. Card reader *	12. 2x DisplayPort
4. Microphone (3.5mm)	13. 2x PS/2 ports (keyboard / mouse) *
5. Headphone / microphone combo jack (3.5mm)	14. 4x USB 3.1 Gen 1
6. USB-C 3.1 Gen 1	15. Ethernet (RJ-45)
7. 2x USB 3.1 Gen 1	16. Optional ports on expansion cards *
8. 2x USB 3.1 Gen 2	17. Kensington Security Slot
9. Line-out (3.5mm)	18. Power connector

Notes:

- Ports with * are only available on selected models

PERFORMANCE

Processor

Processor Family

Intel® Celeron®, Intel Pentium®, 8th Generation Intel Core™ i3 / i5 / i7, or 9th Generation Intel Core i3 / i5 / i7 / i9 Processor

Processor**

Processor Name	Cores	Threads	Base Frequency	Max Frequency	Cache	Memory Support	Processor Graphics
Celeron G4900	2	2	3.1GHz	-	2MB	DDR4-2400	Intel UHD Graphics 610
Celeron G4920	2	2	3.2GHz	-	2MB	DDR4-2400	Intel UHD Graphics 610
Celeron G4930	2	2	3.2GHz	-	2MB	DDR4-2400	Intel UHD Graphics 610
Celeron G4950	2	2	3.3GHz	-	2MB	DDR4-2400	Intel UHD Graphics 610
Pentium Gold G5400	2	4	3.7GHz	-	4MB	DDR4-2400	Intel UHD Graphics 610
Pentium Gold G5420	2	4	3.8GHz	-	4MB	DDR4-2400	Intel UHD Graphics 610
Pentium Gold G5500	2	4	3.8GHz	-	4MB	DDR4-2400	Intel UHD Graphics 630
Pentium Gold G5600	2	4	3.9GHz	-	4MB	DDR4-2400	Intel UHD Graphics 630
Pentium Gold G5620	2	4	4.0GHz	-	4MB	DDR4-2400	Intel UHD Graphics 630
Core i3-8100	4	4	3.6GHz	-	6MB	DDR4-2400	Intel UHD Graphics 630
Core i3-8300	4	4	3.7GHz	-	8MB	DDR4-2400	Intel UHD Graphics 630
Core i3-9100	4	4	3.6GHz	4.2GHz	6MB	DDR4-2400	Intel UHD Graphics 630
Core i3-9100F	4	4	3.6GHz	4.2GHz	6MB	DDR4-2400	-
Core i3-9300	4	4	3.7GHz	4.3GHz	8MB	DDR4-2400	Intel UHD Graphics 630
Core i3-9320	4	4	3.7GHz	4.4GHz	8MB	DDR4-2400	Intel UHD Graphics 630
Core i5-8400	6	6	2.8GHz	4.0GHz	9MB	DDR4-2666	Intel UHD Graphics 630
Core i5-8500	6	6	3.0GHz	4.1GHz	9MB	DDR4-2666	Intel UHD Graphics 630
Core i5-8600	6	6	3.1GHz	4.3GHz	9MB	DDR4-2666	Intel UHD Graphics 630
Core i5-9400	6	6	2.9GHz	4.1GHz	9MB	DDR4-2666	Intel UHD Graphics 630
Core i5-9400F	6	6	2.9GHz	4.1GHz	9MB	DDR4-2666	-
Core i5-9500	6	6	3.0GHz	4.4GHz	9MB	DDR4-2666	Intel UHD Graphics 630
Core i5-9500F	6	6	3.0GHz	4.4GHz	9MB	DDR4-2666	-
Core i5-9600	6	6	3.1GHz	4.6GHz	9MB	DDR4-2666	Intel UHD Graphics 630
Core i7-8700	6	12	3.2GHz	4.6GHz	12MB	DDR4-2666	Intel UHD Graphics 630
Core i7-9700	8	8	3.0GHz	4.7GHz	12MB	DDR4-2666	Intel UHD Graphics 630
Core i9-9900	8	16	3.1GHz	5.0GHz	16MB	DDR4-2666	Intel UHD Graphics 630

Operating System

Operating System**

- Windows® 10 Pro 64
- Windows 10 Home 64
- Ubuntu Linux
- No operating system

Graphics

Graphics***[1]

Graphics	Type	Memory	Connector	Max Resolution	Key Features
Intel UHD graphics 610	Integrated	Shared	1x VGA, 2x DP	2048x1536@50Hz(VGA), 4096x2304@60Hz(DP)	DirectX® 12
Intel UHD	Integrated	Shared	1x VGA, 2x DP	2048x1536@50Hz(VGA),	DirectX 12

graphics 630				4096x2304@60Hz(DP)	
AMD Radeon™ 520	Discrete	2GB GDDR5	2x DP 1.2	4096x2160@60Hz(DP)	DirectX 12
AMD Radeon RX 550X	Discrete	4GB GDDR5	1x HDMI® 2.0, 1x VGA, 1x DP 1.4	4096x2160@60Hz(HDMI), 2048x1536@85Hz(VGA), 3840x2160@60Hz(DP)	DirectX 12
NVIDIA® GeForce® GT 730	Discrete	2GB GDDR5	2x DP	3840x2160@60Hz(DP)	DirectX 12, PCIe 2.0 x16, 35 watts
NVIDIA GeForce GTX 1060	Discrete	6GB GDDR5	1x HDMI, 3x DP, 1x DVI-D	4096x2160@60Hz(HDMI), 5120x3200@60Hz(DP), 2560x1600@60Hz(DVI-D)	DirectX 12, PCIe 3.0 x16, 120 watts, occupies two slots

Notes:

- The information of integrated graphics are not applicable for the models without integrated graphics (for the details, please refer to processor section)

Monitor Support

Monitor Support^[1]

Supports up to 3 independent displays via onboard ports (VGA and 2x DisplayPort™), more displays support via discrete graphics

Notes:

- Onboard video ports are only available for the models with integrated graphics

Chipset

Chipset

Intel Q370 chipset

Memory

Max Memory^[1]

Up to 64GB DDR4-2666

Memory Slots

Four DDR4 DIMM slots, dual-channel capable

Memory Type

DDR4-2666

Notes:

- The max memory is based on the test results with current Lenovo® memory offerings. The system may support more memory as the technology develops.

Storage

Storage Support

Up to four drives, 2x 2.5"/3.5" HDD/SSD + 1x 2.5" HDD + 1x M.2 SSD

- 2.5" HDD up to 1TB each
- 3.5" HDD up to 2TB each
- 2.5" SSD up to 256GB each
- M.2 SSD up to 1TB
- Optional Intel Optane™ Memory, M.2

Storage Type^{***}

Disk Type	Interface	RPM	Security
2.5" SATA HDD	SATA 6Gb/s	7.2K	-
2.5" SATA SSD	SATA 6Gb/s	-	Opal
2.5" SATA SSD	SATA 6Gb/s	-	-
3.5" SATA HDD	SATA 6Gb/s	7.2K	-

ThinkCentre M920 Tower

M.2 2242 SSD	PCIe NVMe, PCIe 3.0 x2	-	-
M.2 2280 SSD	PCIe NVMe, PCIe 3.0 x4	-	Opal
M.2 2280 SSD	PCIe NVMe, PCIe 3.0 x4	-	-
Intel Optane Memory M10	PCIe NVMe, PCIe 3.0 x2	-	-

RAID

RAID 0/1 support for HDDs (RAID preset only available via special bid model)

Removable Storage

Optical**

- DVD-ROM, SATA 1.5Gb/s, slim (9.0mm)
- DVD burner (DVD±RW), SATA 1.5Gb/s, slim (9.0mm)

Card Reader

- 7-in-1 card reader (SD, SDHC, SDXC, MMC, MS, MS-Pro, XD)
- No card reader

Multi-Media

Audio Chip

High Definition (HD) Audio, Realtek® ALC233VB2 codec

Speakers

Single speaker, 2W x1

Power Supply

Power Supply**

Power	Type	Efficiency	Key Features
180W	Fixed	85%	100V - 240V
250W	Fixed	85%	100V - 240V
400W	Fixed	92%	100V - 240V

DESIGN

Input Device

Keyboard**

- Lenovo Calliope Wireless Keyboard (2.4GHz via USB receiver), black
- Lenovo Keyboard (PS/2 connector), black
- Lenovo Traditional Keyboard (USB connector), black
- No keyboard

Mouse**

- Lenovo Calliope Mouse (USB connector), black
- Lenovo Calliope Wireless Mouse (2.4GHz via USB receiver), black
- Lenovo Mouse (PS/2 connector), black (only available via special bid)
- Lenovo Fingerprint Mouse (USB connector), Windows Hello support, black
- No mouse

Mechanical

Form Factor

Tower (18L)

Dimensions (WxDxH)

Models	Dimensions
All models	165 x 321.35 x 410.25 mm (6.5 x 12.65 x 16.15 inches)

Weight

Models	Weight
--------	--------

All models	7 kg (15.45 lbs)
------------	------------------

Case Color

Black

Bays

- 1x 2.5" disk bay (optional, or bay comes with disk)
- 1x 3.5" disk bay
- 1x 3.5" disk bay (optional, or bay comes with disk)
- 1x slim ODD bay
- 1x 5.25" ODD / optional front access HDD

Expansion Slots

- One PCIe 3.0 x1, full-length (< 268mm) full-height (< 112mm)
- One PCIe 3.0 x16 (x4 signal), full-length (< 268mm) full-height (< 112mm)
- One PCIe 3.0 x16, full-length (< 268mm) full-height (< 112mm)
- One dummy slot, only bracket for optional port extension

EOU

Toolless cover, disk, optical, extension card assembly / removal

Others

- (Optional) Carry handle
- (Optional) Dust filter
- (Optional) Front access HDD

CONNECTIVITY

Network

Onboard Ethernet

Gigabit Ethernet, Intel Ethernet Connection I219-LM, 1x RJ45, supports Wake-on-LAN

Optional Ethernet**

- Gigabit Ethernet, Bitland BN8E88, 1x RJ-45, PCIe x1
- Gigabit Ethernet, Intel Ethernet Server Adapter I350-T4, 4x RJ-45, PCIe x4
- No optional Ethernet

WLAN + Bluetooth®**

- Realtek RTL8821CE, 802.11ac Dual Band 1x1 Wi-Fi® + Bluetooth 4.2, M.2 card
- Realtek RTL8822BE, 802.11ac Dual Band 2x2 Wi-Fi + Bluetooth 4.2, M.2 card
- Intel Dual Band Wireless-AC 3165, 802.11ac Dual Band 1x1 Wi-Fi + Bluetooth 4.2, M.2 Card
- Intel Dual Band Wireless-AC 8265, 802.11ac Dual Band 2x2 Wi-Fi + Bluetooth 4.2, M.2 Card
- Intel Wireless-AC 9560, 802.11ac Dual Band 2x2 Wi-Fi + Bluetooth 5.0, Intel vPro technology support, M.2 card
- No WLAN and Bluetooth

Ports^[1]

Front Ports

- 2x USB 3.1 Gen 1
- 2x USB 3.1 Gen 2
- 1x USB-C 3.1 Gen 1
- 1x headphone / microphone combo jack (3.5mm)
- 1x microphone (3.5mm)

Optional Front Ports

- 1x card reader
- None

Rear Ports^[2]

- 4x USB 3.1 Gen 1
- 1x VGA
- 2x DisplayPort
- 1x serial (9-pin)
- 1x Ethernet (RJ-45)
- 1x line-out (3.5mm)

Optional Rear Ports***

- 2x USB 2.0 (via 2-port adapter)
- 2x USB 3.1 Gen 1 (via 2-port USB expansion card, PCIe x1)
- 2x USB-C 3.1 Gen 2 (via 2-port USB-C expansion card, PCIe x4)
- 1x Thunderbolt™ 3 (combo USB-C 3.1 Gen 2 / DisplayPort, via Thunderbolt expansion card, PCIe x4)
- 1x serial
- 4x serial (via 4-port serial expansion card, PCIe x1)
- 1x parallel
- 2x PS/2

Notes:

1. The transfer speed of following ports will vary and, depending on many factors, such as the processing speed of the host device, file attributes and other factors related to system configuration and your operating environment, will be slower than theoretical speed.
 - USB 2.0: 480 Mbit/s;
 - USB 3.2 Gen 1 (SuperSpeed USB 5Gbps, formerly USB 3.0 / USB 3.1 Gen 1): 5 Gbit/s;
 - USB 3.2 Gen 2 (SuperSpeed USB 10Gbps, formerly USB 3.1 Gen 2): 10 Gbit/s;
 - USB 3.2 Gen 2x2 (SuperSpeed USB 20Gbps): 20 Gbit/s;
 - Thunderbolt 3: 40 Gbit/s;
 - FireWire 400: 400 Mbit/s;
 - FireWire 800: 800 Mbit/s
2. For video ports on discrete graphics, please see graphics section

Monitor Cable

Monitor Cable***

- DP to dual DP dongle
- DP to DVI-D dongle
- DP to HDMI 1.4 dongle
- DP to VGA cable (1.5M)
- DP to VGA dongle
- No monitor cable

SECURITY & PRIVACY

Security

Security Chip

Discrete TPM 2.0, TCG certified

Physical Locks

- (Optional) E-lock
- (Optional) Smart Cable Clip
- Kensington® Security Slot
- Padlock Loop

Chassis Intrusion Switch

- Chassis intrusion switch
- No chassis intrusion switch

Fingerprint Reader

- Touch style fingerprint reader on mouse
- No fingerprint reader

BIOS Security

- Administrator password
- Power-on password
- Hard disk password
- Boot sequence control
- Boot without keyboard and mouse
- Smart USB protection (allows keyboard / mouse only, blocks all storage devices)
- Individual USB port disablement

MANAGEABILITY

System Management

System Management^[1]

- Intel vPro with Intel AMT 12.0
- None

Notes:

1. Require choosing a vPro-support Wi-Fi adapter to enable vPro function through wireless connection

SERVICE

Warranty

Base Warranty**

- 1-year depot service
- 1-year limited onsite service
- 3-year depot service
- 3-year limited onsite service
- 3-year split limited onsite service

ENVIRONMENTAL

Operating Environment

Temperature

- Operating: 5°C (41°F) to 35°C (95°F)
- Storage: -40°C (-40°F) to 60°C (140°F)

Humidity

- Operating: 20% to 80%
- Storage: 10% to 90%

Altitude

- Operating: -15.2 m (-50 ft) to 3048 m (10,000 ft)
- Storage: -15.2 m (-50 ft) to 12192 m (40,000 ft)

CERTIFICATIONS

Green Certifications

Green Certifications

- EPEAT™ Silver
- ENERGY STAR® 8.0 (only available for MT 10U0/10U1 models with i3/i5/i7/i9 processor)
- ErP Lot 3
- TCO
- RoHS compliant

Other Certifications

Other Certifications

(Optional) TÜV Rheinland® Low Noise

- Feature with ** means that only one offering listed under the feature is configured on selected models.
- Feature with *** means that one or more offerings listed under the feature could be configured on selected models.
- Lenovo reserves the right to change specifications or other product information without notice. Lenovo is not responsible for photographic or typographical errors. LENOVO PROVIDES THIS PUBLICATION “AS IS,” WITHOUT WARRANTY OF ANY KIND, EITHER EXPRESS OR IMPLIED, INCLUDING THE IMPLIED WARRANTIES OF MERCHANTABILITY OR FITNESS FOR A PARTICULAR PURPOSE. Some jurisdictions do not allow

disclaimer of express or implied warranties in certain transactions, therefore this disclaimer may not apply to you.

- The specifications on this page may not be available in all regions, and may be changed or updated without notice.



This publication was developed for products and services offered in the North America, E.M.E.A and Asia & Pacific countries. Lenovo may not offer the products, services or features discussed in this document in other countries. Lenovo may withdraw an offering at any time. Information is subject to change without notice. Consult your local representative for information on offerings available in your area.

Lenovo reserves the right to change specifications or other product information without notice. Lenovo is not responsible for photographic or typographical errors.

LENOVO PROVIDES THIS PUBLICATION "AS IS," WITHOUT WARRANTY OF ANY KIND, EITHER EXPRESS OR IMPLIED, INCLUDING THE IMPLIED WARRANTIES OF MERCHANTABILITY OR FITNESS FOR A PARTICULAR PURPOSE.

Some jurisdictions do not allow disclaimer of express or implied warranties in certain transactions, therefore this disclaimer may not apply to you.

Availability: All offers subject to availability. Lenovo reserves the right to alter product offerings and specifications at any time, without notice. Lenovo is not responsible for photographic or typographic errors.

General: Review key information provided by Microsoft that may apply to your system purchase, including details on Windows 10, Windows 8, Windows 7, and potential upgrades/downgrades. Lenovo makes no representation or warranty regarding third-party products or services.

Trademarks: Lenovo, ThinkPad, ThinkBook, ThinkCentre, ThinkStation, ThinkVision and the Lenovo logo are trademarks of Lenovo. Microsoft, Windows, Windows NT, and the Windows logo are trademarks of Microsoft Corporation. Ultrabook, Celeron, Celeron Inside, Core Inside, Intel, Intel Logo, Intel Atom, Intel Atom Inside, Intel Core, Intel Inside, Intel Inside Logo, Intel vPro, Itanium, Itanium Inside, Pentium, Pentium Inside, vPro Inside, Xeon, Xeon Phi, and Xeon Inside are trademarks of Intel Corporation in the U.S. and/or other countries. Other company, product or service names may be trademarks or service marks of others.

Warranty: For a copy of applicable warranties, write to: Lenovo Warranty Information, 1009 Think Place, Morrisville, NC, 27560. Lenovo makes no representation or warranty regarding third party products or services. The Lenovo Limited Warranty applies only to Lenovo hardware products purchased for your own use, and does not transfer upon resale.

Limited warranty: Support unrelated to a warranty issue may be subject to additional charges.

Lenovo Services:

Carry-in or Mail-in Service: Parts and labor repair coverage where the customer is responsible for shipping (including packaging) or delivery to authorized warranty provider or repair center.

Depot or Courier Service: Parts and labor repair coverage where shipping (including packaging) or delivery to the repair center is paid for by Lenovo.

Expedited Depot: Parts and labor coverage with expedited turnaround. Shipping (including packaging) or delivery to the repair center is paid for by Lenovo.

Onsite / In-home Service: Parts and labor repair coverage where labor is provided onsite at your place of business.

If Lenovo determines your product problem is covered by the product warranty and cannot be resolved over the telephone, a technician will be dispatched to arrive onsite, typically the next day.

International Warranty Service (IWS): PC repair coverage for customers who require a critical warranty repair while travelling internationally. Visit www.lenovo.com/internationalwarranty for details. Visit www.lenovo.com/warranty for Lenovo Warranty Services terms and conditions for complete details and restrictions.

Included software: may differ from its retail version (if available), and may not include user manuals or all program functionality. Software license agreements may apply.

Battery life: Battery life (and recharge times) will vary based on many factors including screen brightness, applications, features, power management, battery conditioning, and other customer preferences.

Visit <http://psref.lenovo.com/> for the latest version of Product Specifications Reference.

© Lenovo, 2021. All rights reserved.

Lenovo 1009 Think Place Morrisville, NC 27560 U.S.A.