

FCC TEST REPORT
for
Anker Technology Co., Limited

PowerTouch Stand
Model No.: A2517

Prepared for : Anker Technology Co., Limited
Address : Room 1318-19, Hollywood Plaza, 610 Nathan Road, Mongkok,
Kowloon, Hong Kong

Prepared By : Shenzhen Anbotek Compliance Laboratory Limited
Address : 1/F., Building 1, SEC Industrial Park, No.0409 Qianhai Road,
Nanshan District, Shenzhen, Guangdong, China
Tel: (86) 755-26066544
Fax: (86) 755-26014772

Report Number : R011612146Y
Date of Test : Dec. 06~ 16, 2016
Date of Report : Dec. 19, 2016

TABLE OF CONTENT

Description

Page

Test Report

1. GENERAL INFORMATION.....	4
1.1. Description of Device (EUT).....	4
1.2. Auxiliary Equipment Used during Test.....	5
1.3. Description of Test Facility.....	5
1.4. Measurement Uncertainty.....	5
2. TEST METHODOLOGY.....	6
2.1. Summary of Test Results.....	6
3. CONDUCTED EMISSION TEST.....	7
3.1. Block Diagram of Test Setup.....	7
3.2. Power Line Conducted Emission Measurement Limits (15.207).....	7
3.3. Configuration of EUT on Measurement.....	7
3.4. Operating Condition of EUT.....	7
3.5. Test Procedure.....	8
3.6. Test equipment.....	8
3.7. Power Line Conducted Emission Measurement Results.....	8
4. RADIATED EMISSIONS.....	13
4.6.1.1. Test Limits (< 30 MHZ).....	13
4.6.1.2. Test Limits (≥ 30 MHz).....	13
4.6.2. Test Configuration:.....	15
4.6.3. Test Procedure.....	16
4.6.4. Test Results.....	17
6. PHOTOGRAPH.....	21
6.1 Photo of Conducted Emission Test.....	21
6.2 Photo of Radiation Emission Test.....	21
APPENDIX I (EXTERNAL PHOTOS).....	23
APPENDIX II (INTERNAL PHOTOS).....	27

TEST REPORT

Applicant : Anker Technology Co., Limited
Manufacturer : Anker Technology Co., Limited
EUT : PowerTouch Stand
Model No. : A2517
Serial No. : N.A.
Trade Mark : **ANKER**
Rating : Input DC 5V, 2A, Output DC 5V, 0.95A

Measurement Procedure Used:
FCC Part15 Subpart C 2016, Paragraph 15.209

The device described above is tested by Shenzhen Anbotek Compliance Laboratory Limited to determine the maximum emission levels emanating from the device and the severe levels of the device can endure and its performance criterion. The measurement results are contained in this test report and Shenzhen Anbotek Compliance Laboratory Limited is assumed full of responsibility for the accuracy and completeness of these measurements. Also, this report shows that the EUT (Equipment Under Test) is technically compliant with the FCC Part 15 Subpart C requirements.

This report applies to above tested sample only and shall not be reproduced in part without written approval of Shenzhen Anbotek Compliance Laboratory Limited.

Date of Test : Dec. 06~ 16, 2016

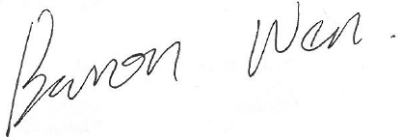
Prepared by : 
(Tested Engineer / Baron Wen)

Reviewer : 
(Project Manager / Amy Ding)

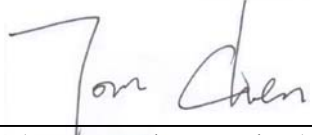
Approved & Authorized Signer : 
(Manager / Tom Chen)

1. GENERAL INFORMATION

1.1. Description of Device (EUT)

EUT : PowerTouch Stand

Model Number : A2517

Test Power Supply : DC 5V

Frequency : 110~ 205kHz

Applicant : Anker Technology Co., Limited
Address : Room 1318-19, Hollywood Plaza, 610 Nathan Road, Mongkok, Kowloon, Hong Kong

Manufacturer : Anker Technology Co., Limited
Address : Room 1318-19, Hollywood Plaza, 610 Nathan Road, Mongkok, Kowloon, Hong Kong

Factory : Shenzhen New Technology Co., LTD.
Address : FL 3, Building 3, MeiXiMei Industrial Park, FuZhou Rd, QiaoTou, FuYong Street, Bao'An District, ShenZhen, Guangdong, China

Date of receiver : Dec. 06, 2016

Date of Test : Dec. 06~ 16, 2016

1.2. Auxiliary Equipment Used during Test

- Adapter : Model No.: ETA-U90CBC
Manufacturer: SAMSUNG
Input: AC 100-240V, 50-60Hz, 0.35A
Output: DC 5V, 2A
- Mobile Phone : Model No.: GALAXY S6 Edge plus G9280
Manufacturer: SAMSUNG

1.3. Description of Test Facility

The test facility is recognized, certified, or accredited by the following organizations:

FCC-Registration No.: 752021

Shenzhen Anbotek Compliance Laboratory Limited, EMC Laboratory has been registered and fully described in a report filed with the (FCC) Federal Communications Commission. The acceptance letter from the FCC is maintained in our files. Registration 752021, July 06, 2016.

IC-Registration No.: 8058A-1

Shenzhen Anbotek Compliance Laboratory Limited., EMC Laboratory has been registered and fully described in a report filed with the (IC) Industry Canada. The acceptance letter from the IC is maintained in our files. Registration 8058A, Jun. 13, 2016.

Test Location

All Emissions tests were performed at
Shenzhen Anbotek Compliance Laboratory Limited. at 1/F., Building 1, SEC
Industrial Park, No.0409 Qianhai Road, Nanshan District, Shenzhen, Guangdong,
China

1.4. Measurement Uncertainty

- Radiation Uncertainty : Ur = 4.1 dB (Horizontal)
Ur = 4.3 dB (Vertical)
- Conduction Uncertainty : Uc = 3.4dB

2. TEST METHODOLOGY

The tests documented in this report were performed in accordance with ANSI C63.10: 2013 and FCC Part 15, Paragraph 15.209.

2.1. Summary of Test Results

The EUT has been tested according to the following specifications:

Standard	Test Type	Result	Notes
FCC Part 15, Paragraph 15.207	Conducted Emission Test	PASS	Complies
FCC Part 15, Paragraph 15.209(a)(f)	Spurious Emission	PASS	Complies

Anbotek

3. Conducted Emission Test

3.1. Block Diagram of Test Setup

3.1.1. Block diagram of connection between the EUT and simulators

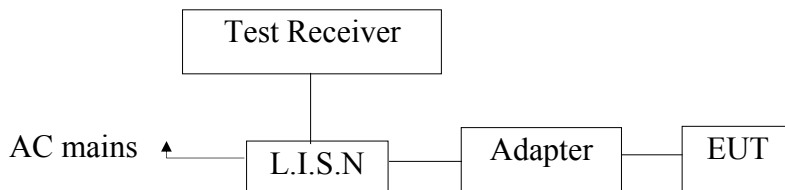

3.2. Power Line Conducted Emission Measurement Limits (15.207)

Frequency MHz	Limits dB(μV)	
	Quasi-peak Level	Average Level
0.15 ~ 0.50	66 ~ 56*	56 ~ 46*
0.50 ~ 5.00	56	46
5.00 ~ 30.00	60	50

- Notes: 1. *Decreasing linearly with logarithm of frequency.
2. The lower limit shall apply at the transition frequencies.

3.3. Configuration of EUT on Measurement

The following equipments are installed on Power Line Conducted Emission Measurement to meet the commission requirement and operating regulations in a manner which tends to maximize its emission characteristics in a normal application.

3.4. Operating Condition of EUT

- 3.4.1. Setup the EUT and simulator as shown as Section 3.1.
- 3.4.2. Turn on the power of all equipment.
- 3.4.3. Let the EUT work in test mode (Phone Charge Mode) and measure it.

3.5. Test Procedure

The EUT system is connected to the power mains through a line impedance stabilization network (L.I.S.N.). This provides a 50ohm coupling impedance for the EUT system. Please refer the block diagram of the test setup and photographs. Both sides of AC line are checked to find out the maximum conducted emission. In order to find the maximum emission levels, the relative positions of equipment and all of the interface cables shall be changed according to FCC ANSI C63.10-2013 on Conducted Emission Measurement.

The bandwidth of test receiver (ESCI) set at 9KHz.

The frequency range from 150KHz to 30MHz is checked.

The test results are reported on Section 3.7.

3.6. Test equipment

Item	Equipment	Manufacturer	Model No.	Serial No.	Last Cal.	Cal. Interval
1.	Two-Line V-network	Rohde & Schwarz	ENV216	100055	Jul. 19, 2016	1 Year
2.	EMI Test Receiver	Rohde & Schwarz	ESCI	100627	Jun. 17, 2016	1 Year
3.	RF Switching Unit	Compliance Direction	RSU-M2	38303	Jun. 17, 2016	1 Year

3.7. Power Line Conducted Emission Measurement Results

PASS.

The frequency range from 150KHz to 30 MHz is investigated.

Please refer the following pages.

CONDUCTED EMISSION TEST DATA

Test Site: 1# Shielded Room
 Operating Condition: Phone Charge Mode
 Test Specification: AC 120V, 60Hz for adapter
 Comment: Live Line
 Tem.:24°C Hum.:49%

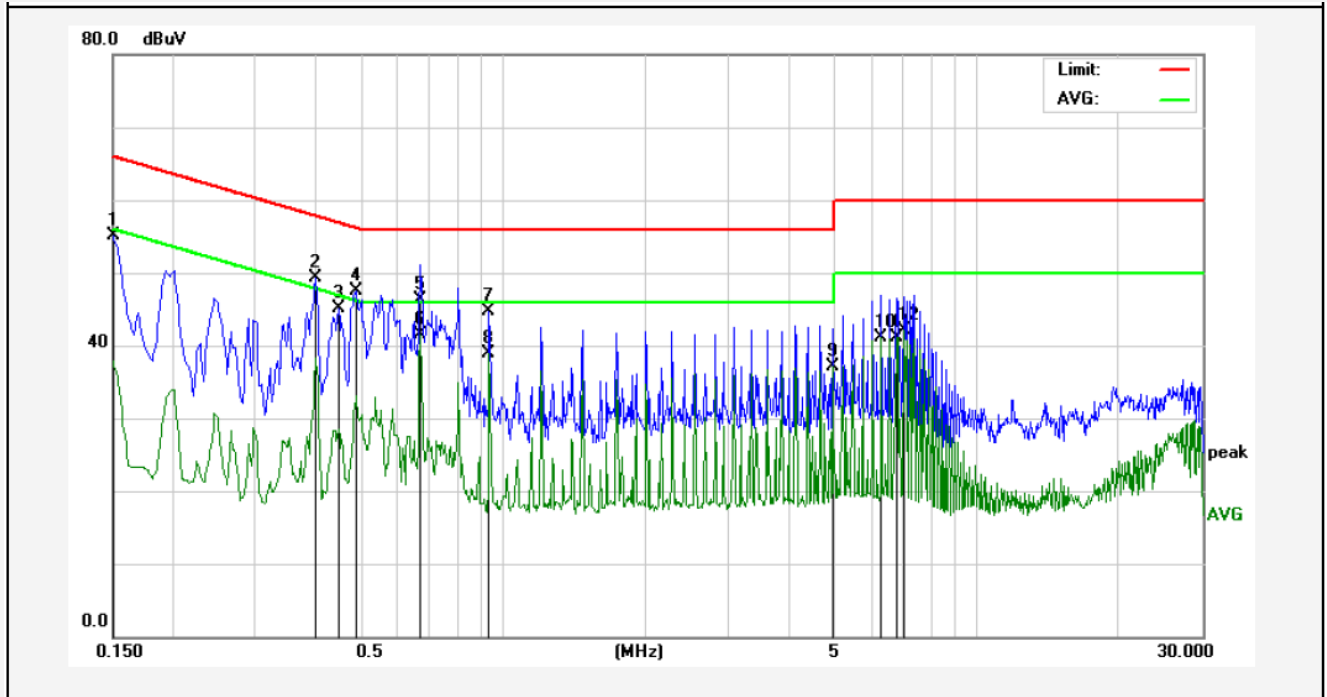

No.	Freq. (MHz)	Reading (dBuV)	Factor (dB)	Result (dBuV)	Limit dBuV	Over Limit (dB)	Detector	Remark
1	0.1500	35.25	19.90	55.15	65.99	-10.84	QP	
2	0.4020	29.38	19.94	49.32	57.81	-8.49	QP	
3	0.4500	25.10	19.96	45.06	56.87	-11.81	QP	
4	0.4900	27.43	19.98	47.41	56.17	-8.76	QP	
5	0.6700	26.33	20.03	46.36	56.00	-9.64	QP	
6	0.6700	21.41	20.03	41.44	46.00	-4.56	AVG	
7	0.9380	24.61	20.10	44.71	56.00	-11.29	QP	
8	0.9380	18.75	20.10	38.85	46.00	-7.15	AVG	
9	4.9580	16.96	20.21	37.17	46.00	-8.83	AVG	
10	6.3100	20.81	20.24	41.05	50.00	-8.95	AVG	
11	6.7740	20.95	20.25	41.20	50.00	-8.80	AVG	
12	7.0340	21.89	20.26	42.15	50.00	-7.85	AVG	

CONDUCTED EMISSION TEST DATA

Test Site: 1# Shielded Room
 Operating Condition: Phone Charge Mode
 Test Specification: AC 120V, 60Hz for adapter
 Comment: Neutral Line
 Tem.:24°C Hum.:49%

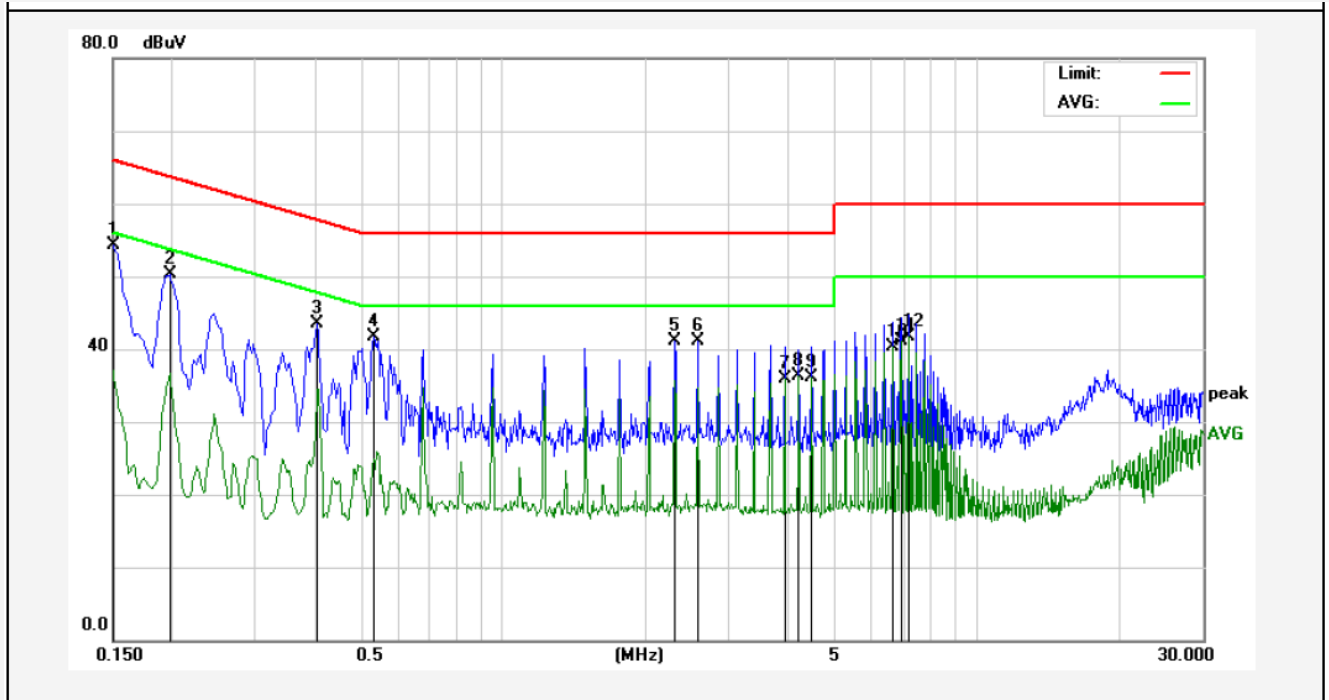

No.	Freq. (MHz)	Reading (dBuV)	Factor (dB)	Result (dBuV)	Limit dBuV	Over Limit (dB)	Detector	Remark
1	0.1500	34.42	19.90	54.32	65.99	-11.67	QP	
2	0.1980	30.32	19.90	50.22	63.69	-13.47	QP	
3	0.4060	23.54	19.94	43.48	57.73	-14.25	QP	
4	0.5340	21.64	19.99	41.63	56.00	-14.37	QP	
5	2.3060	20.97	20.15	41.12	56.00	-14.88	QP	
6	2.5780	20.99	20.15	41.14	56.00	-14.86	QP	
7	3.9340	15.64	20.18	35.82	46.00	-10.18	AVG	
8	4.2060	16.02	20.19	36.21	46.00	-9.79	AVG	
9	4.4780	15.82	20.19	36.01	46.00	-9.99	AVG	
10	6.6460	20.01	20.25	40.26	50.00	-9.74	AVG	
11	6.9180	20.88	20.26	41.14	50.00	-8.86	AVG	
12	7.1900	21.43	20.26	41.69	50.00	-8.31	AVG	

CONDUCTED EMISSION TEST DATA

Test Site: 1# Shielded Room
 Operating Condition: Phone Charge Mode
 Test Specification: AC 240V, 60Hz for adapter
 Comment: Live Line
 Tem.:24°C Hum.:49%

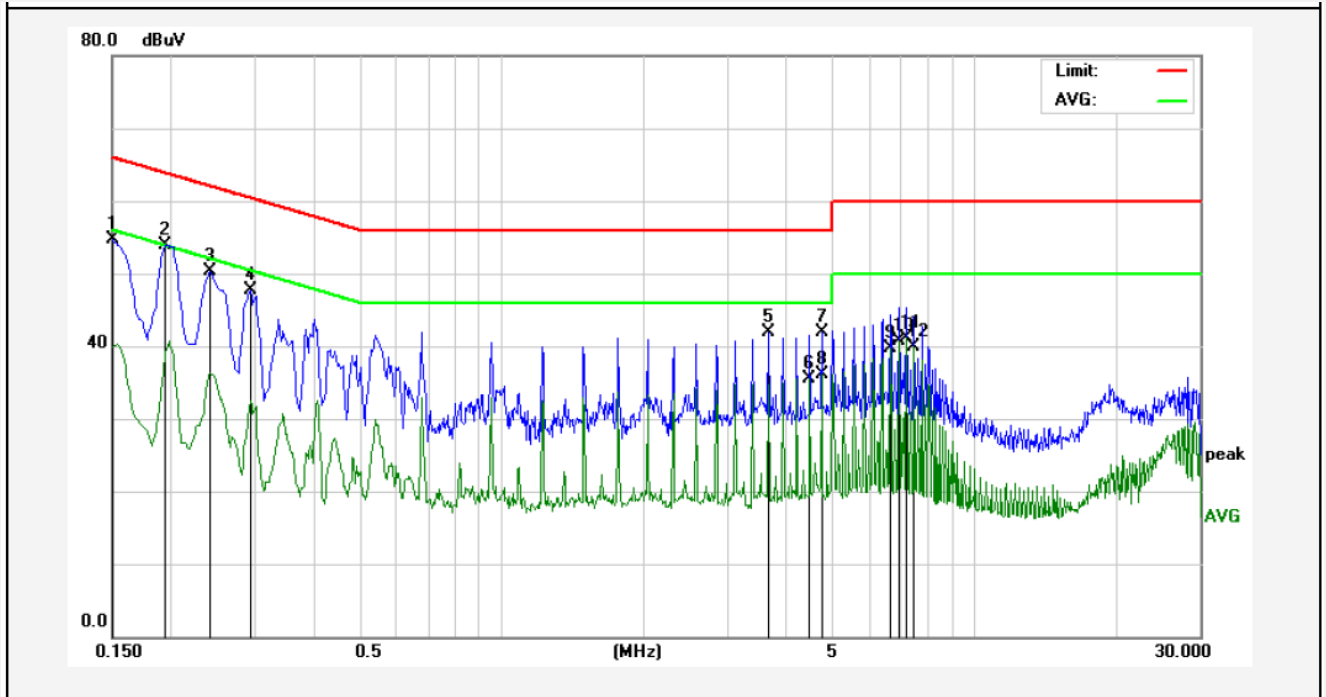

No.	Freq. (MHz)	Reading (dBuV)	Factor (dB)	Result (dBuV)	Limit dBuV	Over Limit (dB)	Detector	Remark
1	0.1500	34.78	19.90	54.68	65.99	-11.31	QP	
2	0.1940	34.09	19.90	53.99	63.86	-9.87	QP	
3	0.2420	30.41	19.89	50.30	62.02	-11.72	QP	
4	0.2940	27.74	19.89	47.63	60.41	-12.78	QP	
5	3.6700	21.71	20.17	41.88	56.00	-14.12	QP	
6	4.4820	15.35	20.19	35.54	46.00	-10.46	AVG	
7	4.7540	21.76	20.20	41.96	56.00	-14.04	QP	
8	4.7540	15.89	20.20	36.09	46.00	-9.91	AVG	
9	6.6580	19.41	20.25	39.66	50.00	-10.34	AVG	
10	6.9300	20.46	20.26	40.72	50.00	-9.28	AVG	
11	7.2020	20.82	20.27	41.09	50.00	-8.91	AVG	
12	7.4740	19.71	20.27	39.98	50.00	-10.02	AVG	

CONDUCTED EMISSION TEST DATA

Test Site: 1# Shielded Room
 Operating Condition: Phone Charge Mode
 Test Specification: AC 240V, 60Hz for adapter
 Comment: Neutral Line
 Tem.:24°C Hum.:49%

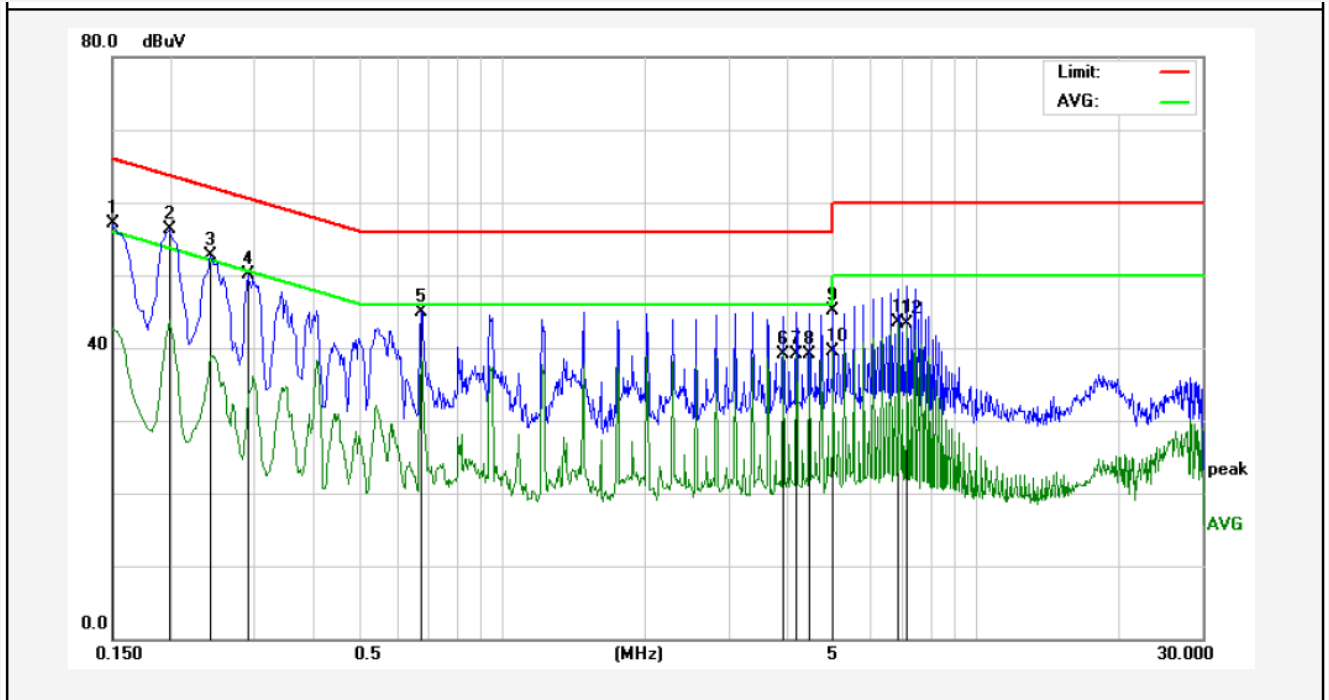

No.	Freq. (MHz)	Reading (dBuV)	Factor (dB)	Result (dBuV)	Limit dBuV	Over Limit (dB)	Detector	Remark
1	0.1500	37.15	19.90	57.05	65.99	-8.94	QP	
2	0.1980	36.44	19.90	56.34	63.69	-7.35	QP	
3	0.2420	32.90	19.89	52.79	62.02	-9.23	QP	
4	0.2900	30.30	19.89	50.19	60.52	-10.33	QP	
5	0.6740	24.91	20.03	44.94	56.00	-11.06	QP	
6	3.9060	19.00	20.18	39.18	46.00	-6.82	AVG	
7	4.1779	18.97	20.18	39.15	46.00	-6.85	AVG	
8	4.4460	19.00	20.19	39.19	46.00	-6.81	AVG	
9	4.9860	24.92	20.21	45.13	56.00	-10.87	QP	
10	4.9860	19.37	20.21	39.58	46.00	-6.42	AVG	
11	6.8700	23.32	20.26	43.58	50.00	-6.42	AVG	
12	7.1420	23.12	20.26	43.38	50.00	-6.62	AVG	

4. RADIATED EMISSIONS

4.6.1.1. Test Limits (< 30 MHz)

Frequency (MHz)	Field Strength (microvolts/meter)	Measurement Distance (meter)
0.009-0.490	2400/F(kHz)	300
0.490-1.705	24000/F(kHz)	30
1.705-30.0	30	30

4.6.1.2. Test Limits (≥ 30 MHz)

FIELD STRENGTH of Fundamental: @3M	FIELD STRENGTH of Harmonics	S15.209	
902-928 MHz		30 - 88 MHz	40 dBuV/m
2.4-2.4835 GHz		88 - 216 MHz	43.5
94 dBμV/m @3m	54 dBμV/m @3m	216 - 960 MHz	46
		ABOVE 960 MHz	54dBuV/m

In any 100 kHz bandwidth outside the frequency band in which the spread spectrum or digitally modulated intentional radiator is operating, the radio frequency power that is produced by the intentional radiator shall be at least 20 dB below that in the 100 kHz bandwidth within the band that contains the highest level of the desired power, based on either an RF conducted or a radiated measurement. Attenuation below the general limits specified in Section 15.209(a) is not required. In addition, radiated emissions which fall in the restricted bands, as defined in Section 15.205(a), must also comply with the radiated emission limits specified in Section 15.209(a) (see Section 15.205(c)).

Test Equipment

Item	Equipment	Manufacturer	Model No.	Serial No.	Last Cal.	Cal. Interval
1.	Spectrum Analysis	Agilent	E4407B	US39390582	Jul. 12, 2016	1 Year
2.	Preamplifier	Instruments corporation	EMC011830	980100	Jun. 17, 2016	1 Year
3.	EMI Test Receiver	Rohde & Schwarz	ESPI	101604	Jun. 17, 2016	1 Year
4.	Double Ridged Horn Antenna	Instruments corporation	GTH-0118	351600	May 06, 2016	1 Year
5.	Bilog Broadband Antenna	Schwarzbeck	VULB9163	VULB 9163-289	May 06, 2016	1 Year
6.	Pre-amplifier	SONOMA	310N	186860	Jun. 17, 2016	1 Year
7.	EMI Test Software EZ-EMC	SHURPLE	N/A	N/A	N/A	N/A
8	Power Sensor	Agilent	KFSW150502	15I00041SN045	Jun. 17, 2016	1 Year
9	MXA Spectrum Analysis	Agilent	N9020A	MY51170037	Jun. 17, 2016	1 Year
10	MXG RF Vector Signal Generator	Agilent	N5182A	MY48180656	Jun. 17, 2016	1 Year
11	Signal Generator	Agilent	E4421B	MY41000743	Jun. 17, 2016	1 Year
12	DC Power supply	IV	IV-8080	YQSB0096	Jun. 17, 2016	1 Year
13	TEMP&HUMI PROGRAMMABLE CHAMBER	Bell Group	BE-THK-150M8	SE-0137	Jun. 17, 2016	1 Year
14.	Loop Antenna	Schwarzbeck	FMZB 1519	012	May 11, 2016	1 Year

4.6.2. Test Configuration:

4.6.2.1. 9k to 30MHz emissions:

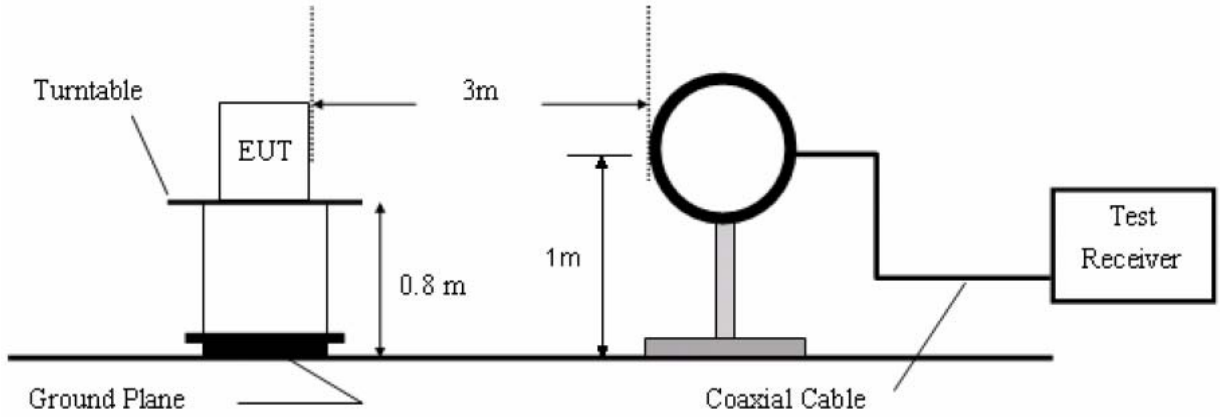

4.6.2.2. 30M to 1GHz emissions:

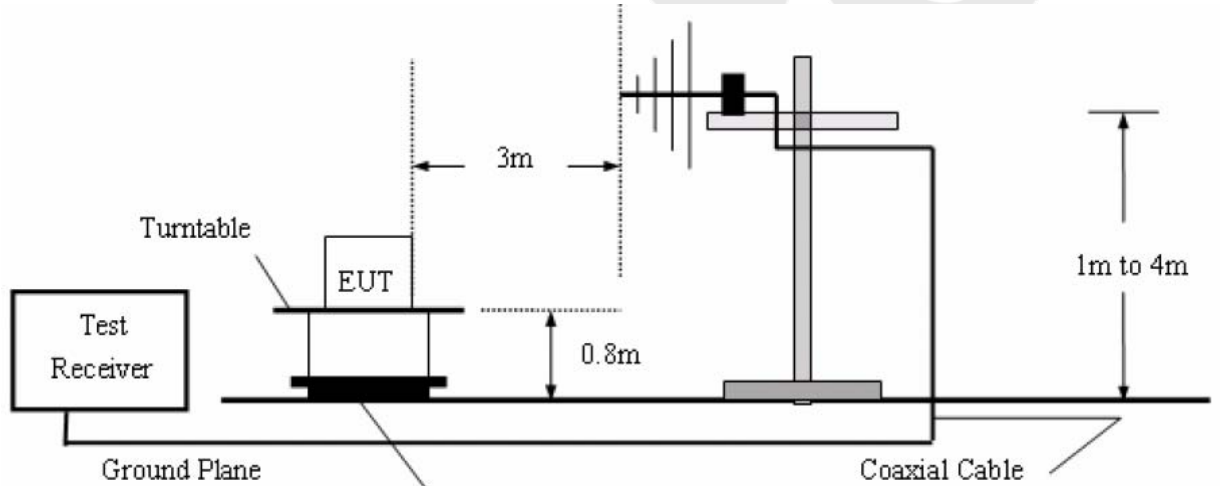

4.6.3. Test Procedure

For below 1GHz: The EUT is placed on a turntable, which is 0.8m above the ground plane. The turn table can rotate 360 degrees to determine the position of the maximum emission level. The EUT is set 3 meters away from the receiving antenna which is mounted on a antenna tower. The antenna can be moved up and down from 1 to 4 meters to find out the maximum emission level. Both horizontal and vertical polarization of the antenna are set on test.

All readings from 30MHz to 1GHz are quasi-peak values with a resolution bandwidth of 120kHz.

The EUT is tested in 9*6*6 Chamber. The device is evaluated in xyz orientation.

The test results are listed in Section 4.6.4.

Anbotek

4.6.4. Test Results

(Between 9KHz – 30 MHz)

Job No.:	011612146I	Polarization:	Horizontal
Standard:	FCC PART15 C_3m	Power Source:	AC 120V, 60Hz for adapter
Test item:	Radiation Test	Temp.(C)/Hum.(%RH):	24.4(C)/50%RH
Test Mode:	Phone Charge Mode	Distance:	3m

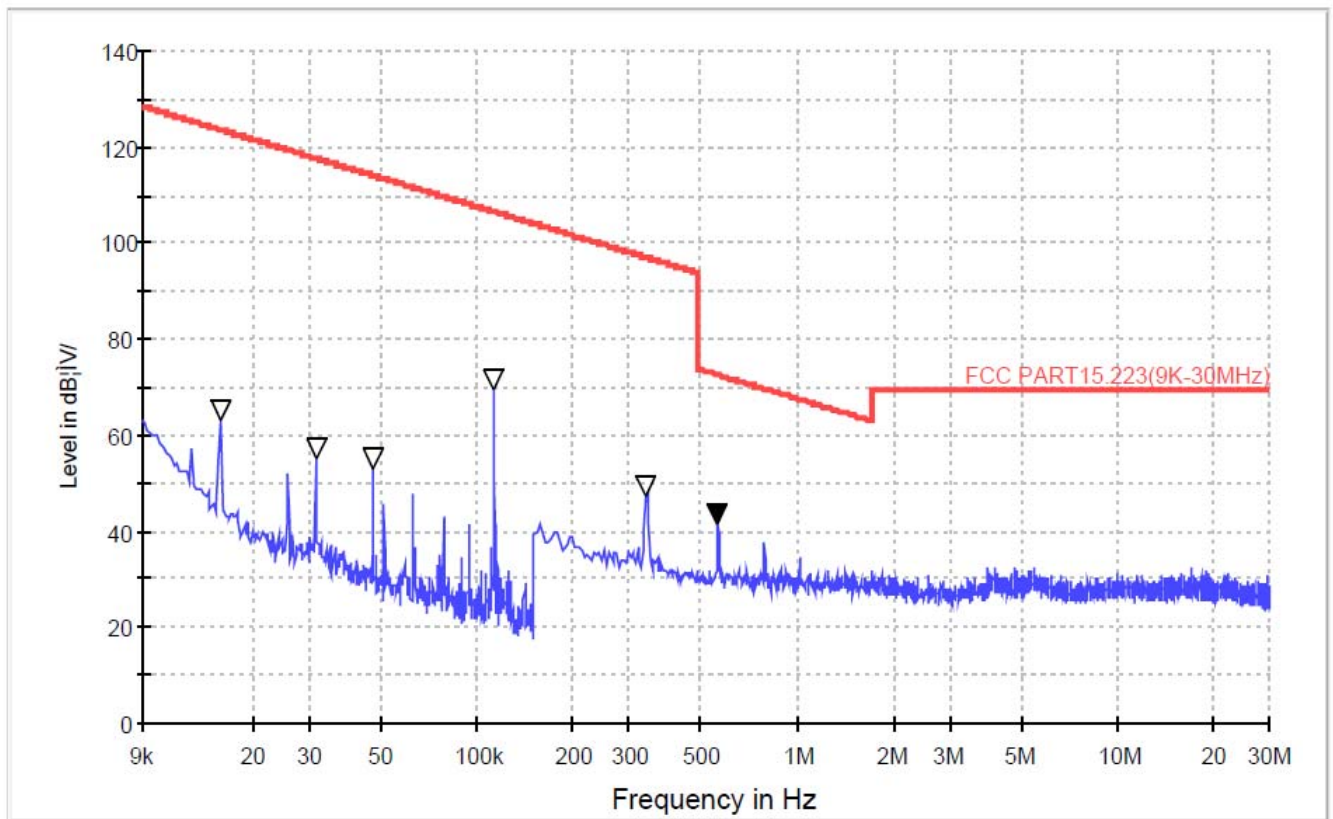

Frequency (MHz)	Read Level (dBuV)	Antenna Factor (dB/m)	Cable Loss (dB)	Preamp Factor (dB)	Level (dBuV/m)	Remark
0.0143	41.779	18.55	2.37	0	62.699	Pass
0.0278	34.734	18.67	2.39	0	55.794	Pass
0.0467	31.767	19.42	2.38	0	53.567	Pass
0.1221	58.681	20.57	2.39	0	81.641	Pass
0.3635	36.045	21.55	2.71	0	60.305	Pass
0.6024	25.639	22.90	2.52	0	51.059	Pass

Job No.:	011612146I	Polarization:	Vertical
Standard:	FCC PART15 C _3m	Power Source:	AC 120V, 60Hz for adapter
Test item:	Radiation Test	Temp.(C)/Hum.(%RH):	24.4(C)/50%RH
Test Mode:	Phone Charge Mode	Distance:	3m

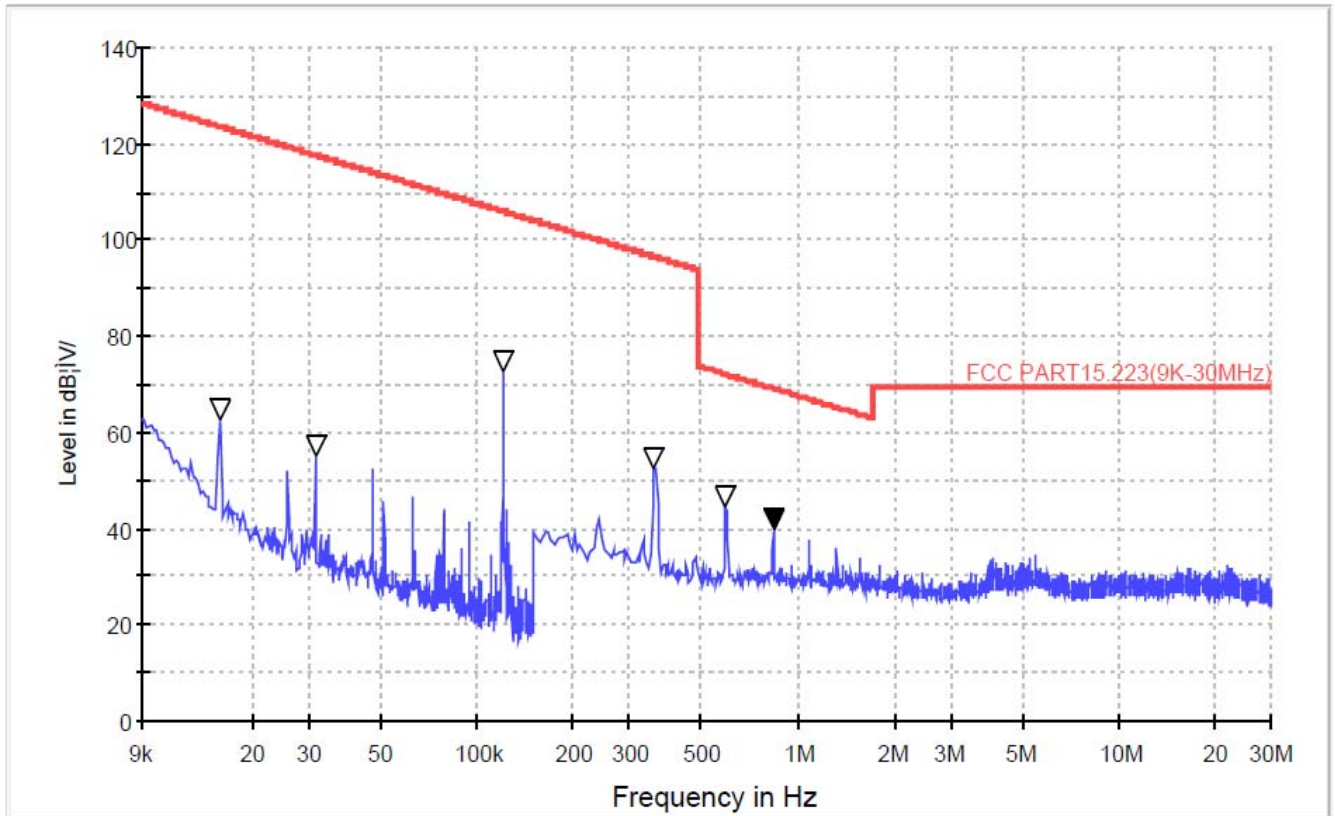

Frequency (MHz)	Read Level (dBuV)	Antenna Factor (dB/m)	Cable Loss (dB)	Preamp Factor (dB)	Level (dBuV/m)	Remark
0.0158	41.635	18.56	2.37	0	62.565	Pass
0.0312	34.159	18.69	2.39	0	55.239	Pass
0.1213	49.851	20.61	2.38	0	72.841	Pass
0.3570	27.966	21.55	2.76	0	52.276	Pass
0.5950	18.923	22.81	2.54	0	44.273	Pass
0.8420	14.633	22.81	2.54	0	39.983	Pass

(Between 30MHz –1000 MHz)

Job No.:	011612146I	Polarization:	Horizontal
Standard:	FCC PART15 C _3m	Power Source:	AC 120V, 60Hz for adapter
Test item:	Radiation Test	Temp.(C)/Hum.(%RH):	24.4(C)/50%RH
Test Mode:	Phone Charge Mode	Distance:	3m

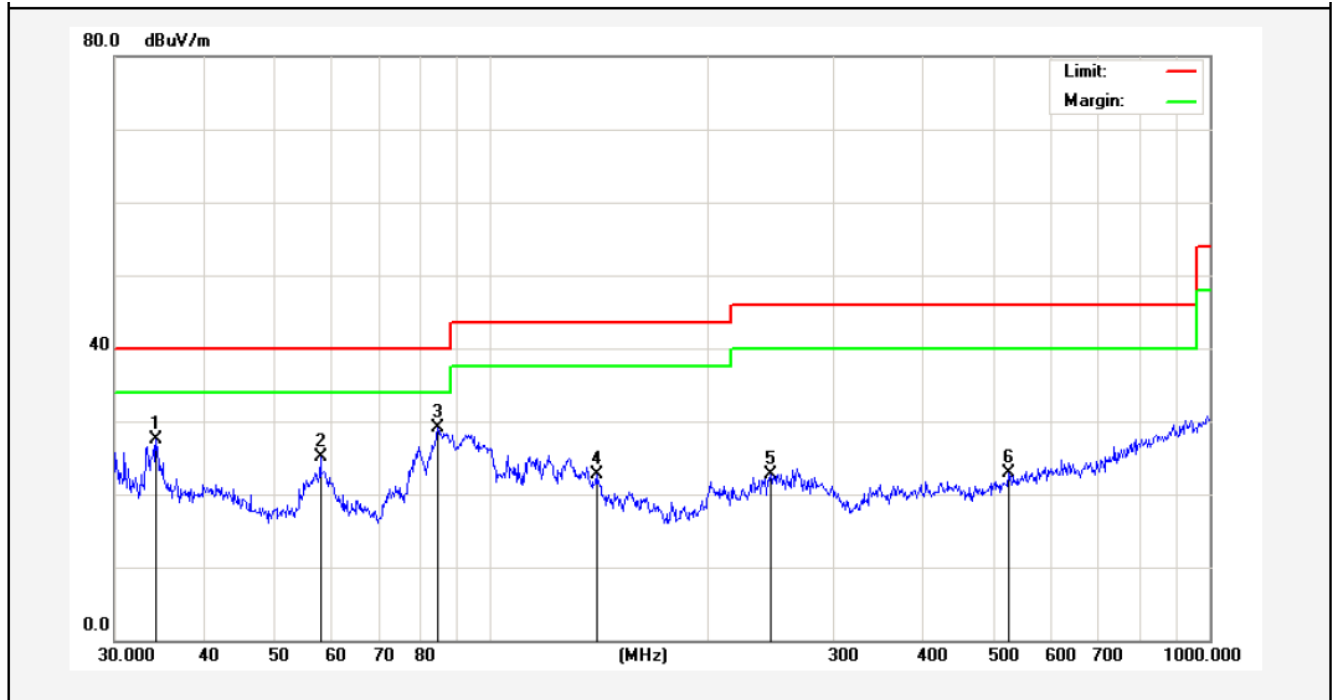

No.	Freq. (MHz)	Reading (dBuV/m)	Factor (dB/m)	Result (dBuV/m)	Limit (dBuV/)	Over Limit (dB)	Detector	Height (cm)	degree (deg)	Remark
1	34.2760	42.09	-14.68	27.41	40.00	-12.59	peak			
2	57.9993	40.35	-15.21	25.14	40.00	-14.86	peak			
3	84.4054	49.74	-20.54	29.20	40.00	-10.80	peak			
4	140.3421	46.19	-23.48	22.71	43.50	-20.79	peak			
5	245.0900	41.00	-18.31	22.69	46.00	-23.31	peak			
6	524.5541	33.94	-11.02	22.92	46.00	-23.08	peak			

Job No.:	011612146I	Polarization:	Vertical
Standard:	FCC PART15 C _3m	Power Source:	AC 120V, 60Hz for adapter
Test item:	Radiation Test	Temp.(C)/Hum.(%RH):	24.4(C)/50%RH
Test Mode:	Phone Charge Mode	Distance:	3m

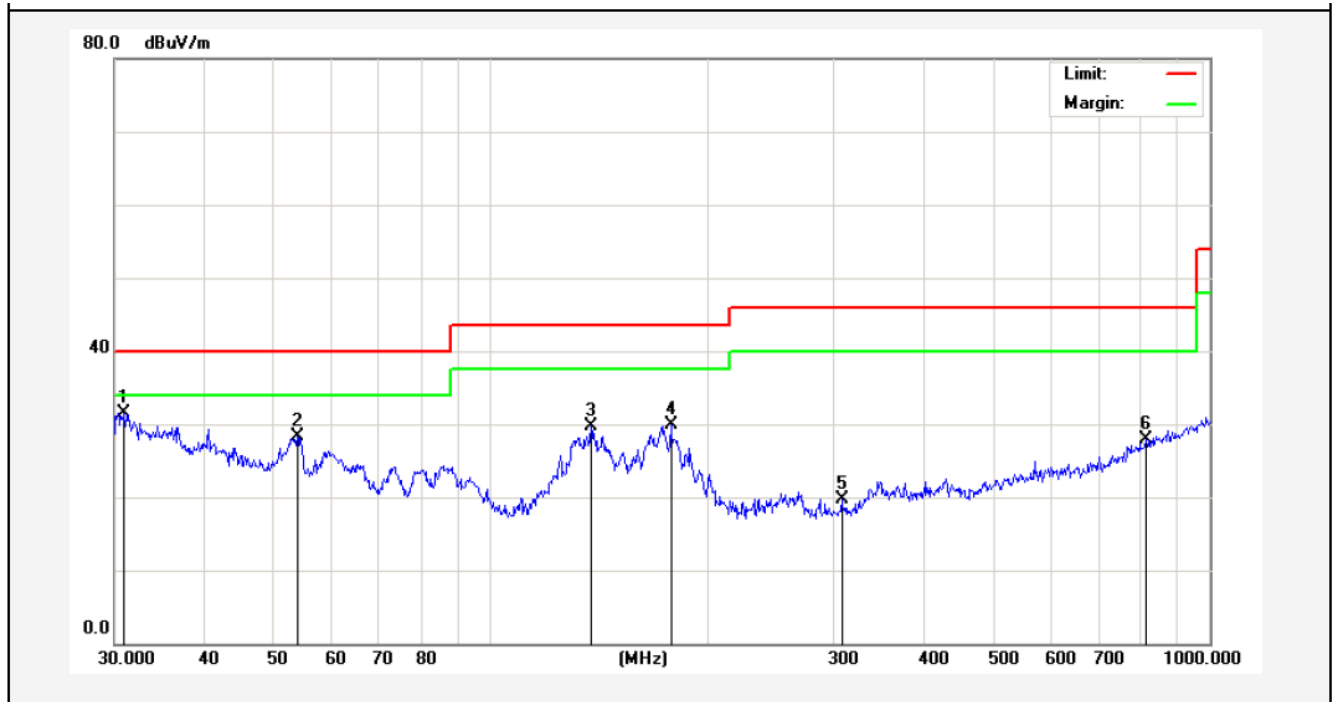

No.	Freq. (MHz)	Reading (dBuV/m)	Factor (dB/m)	Result (dBuV/m)	Limit (dBuV/)	Over Limit (dB)	Detector	Height (cm)	degree (deg)	Remark
1	30.9619	48.00	-16.44	31.56	40.00	-8.44	peak			
2	53.8818	43.21	-14.85	28.36	40.00	-11.64	peak			
3	137.9028	47.96	-18.35	29.61	43.50	-13.89	peak			
4	178.1327	46.88	-16.98	29.90	43.50	-13.60	peak			
5	307.8313	34.28	-14.51	19.77	46.00	-26.23	peak			
6	815.9678	33.17	-5.28	27.89	46.00	-18.11	peak			

6. PHOTOGRAPH

6.1 Photo of Conducted Emission Test



6.2 Photo of Radiation Emission Test

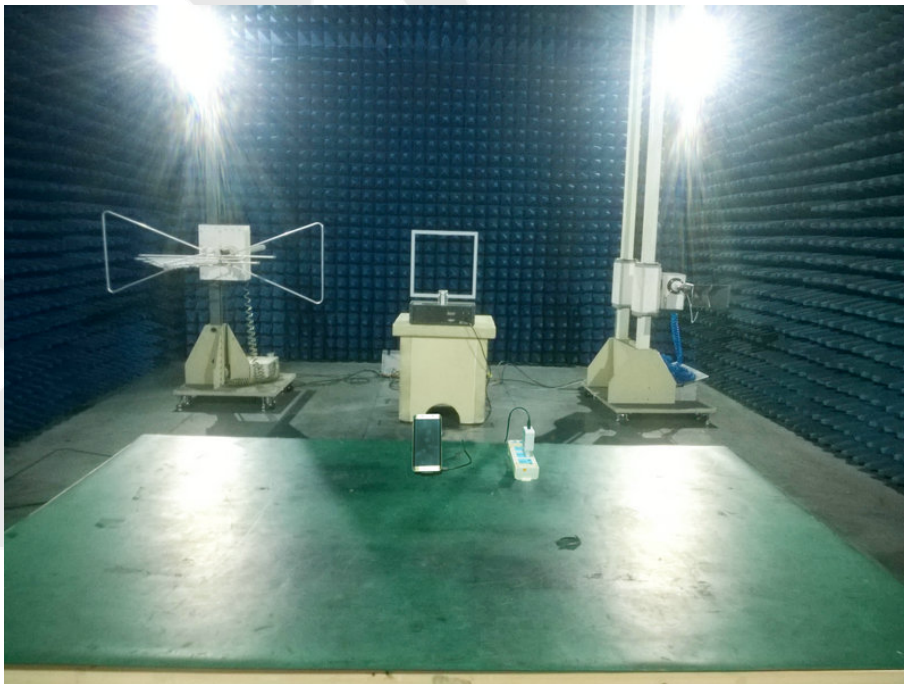

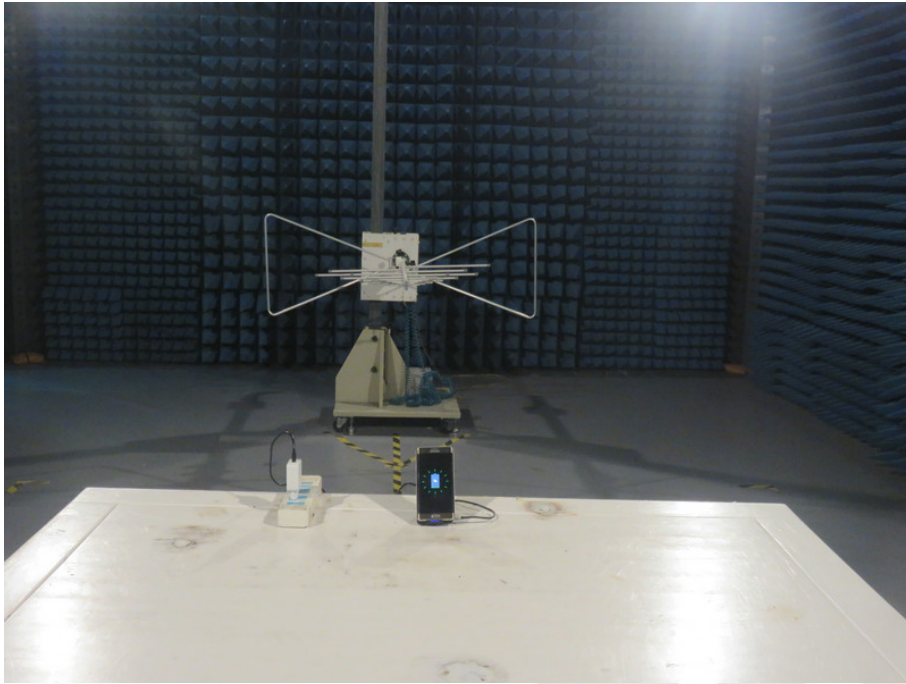

Anbotek

APPENDIX I (EXTERNAL PHOTOS)

1. Figure

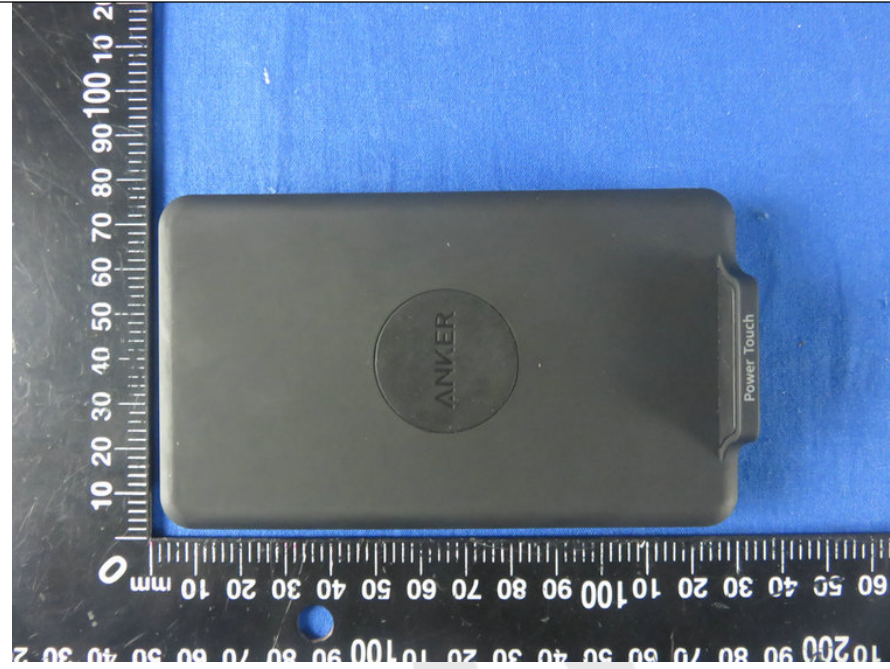

2. Figure

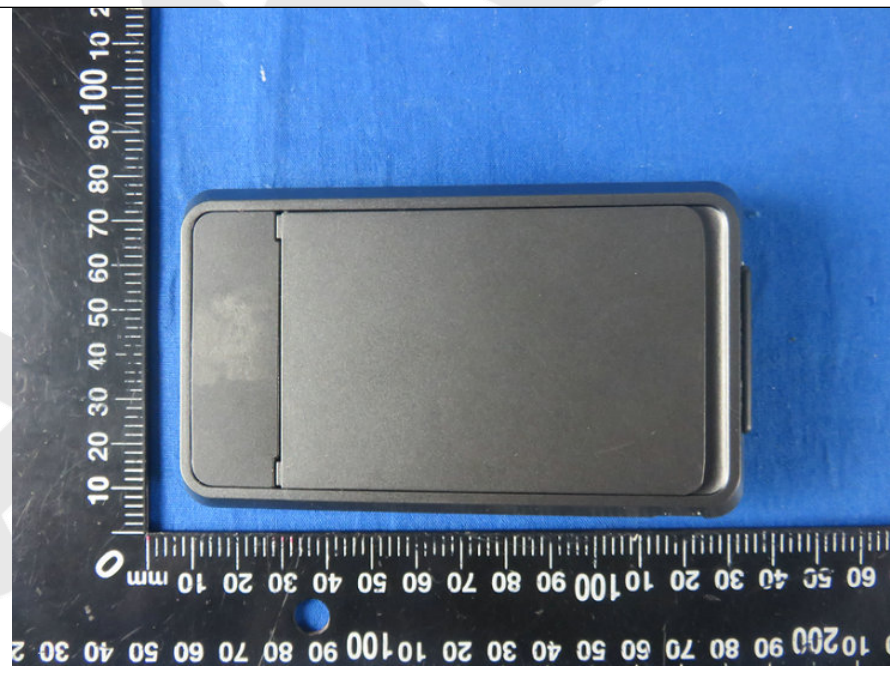

3. Figure



4. Figure

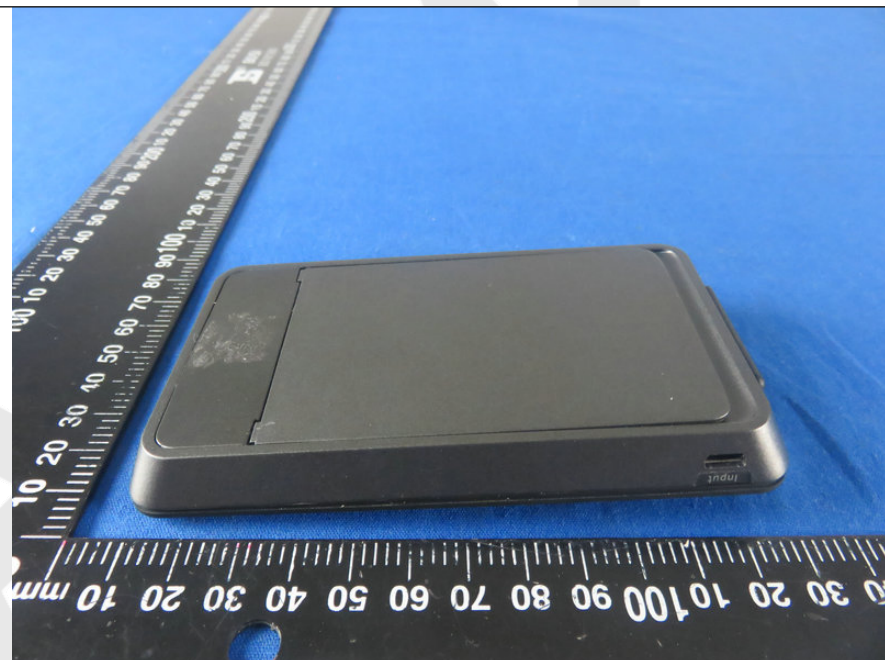

5. Figure

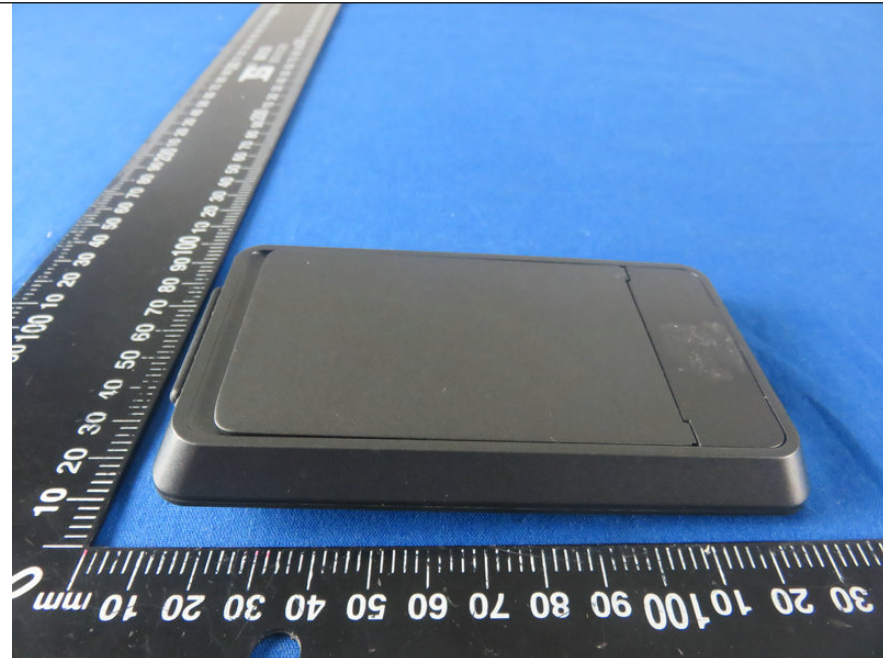

6. Figure



7. Figure



Anbotek

APPENDIX II (INTERNAL PHOTOS)

1. Figure

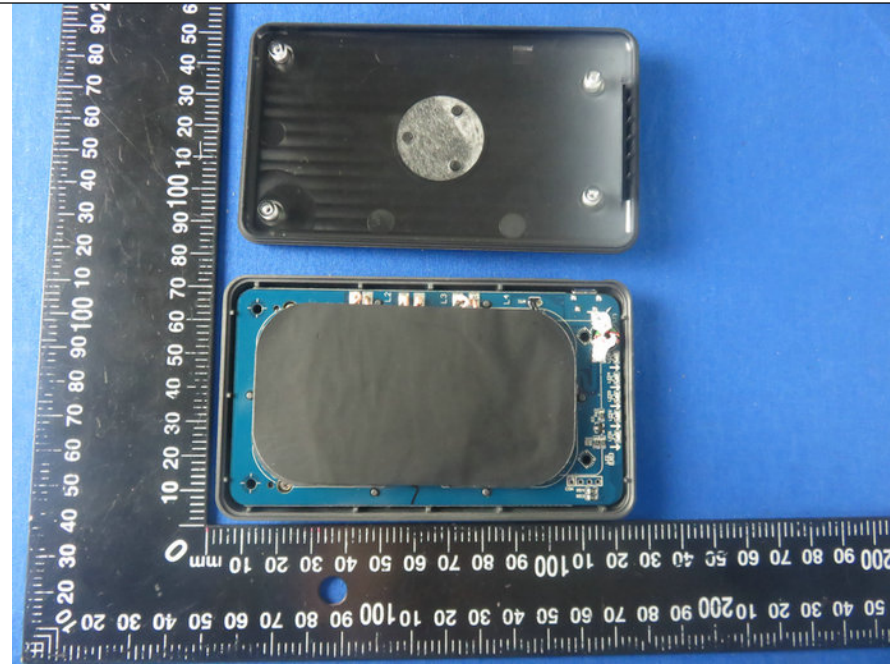

2. Figure

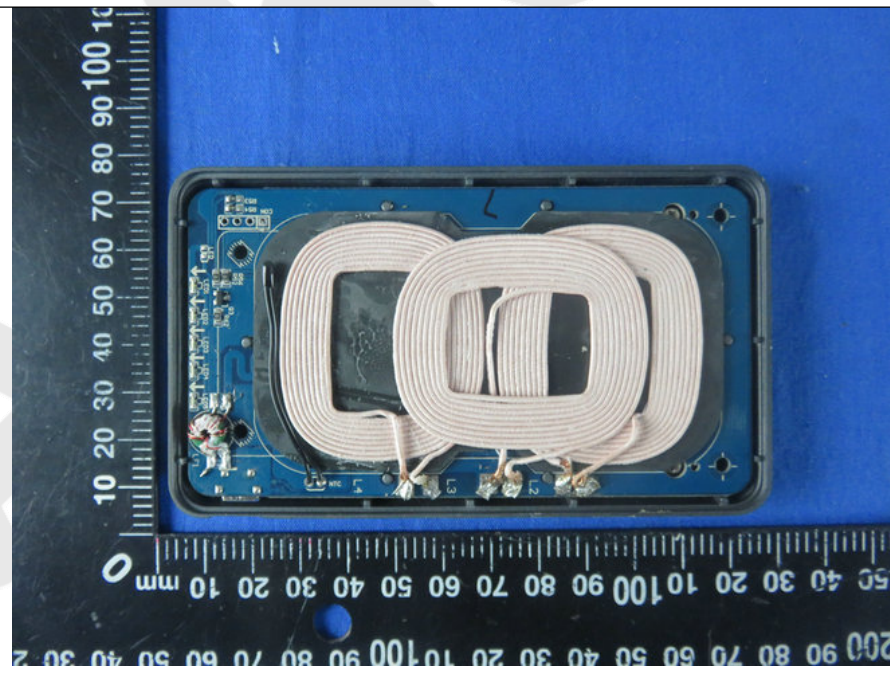

3. Figure

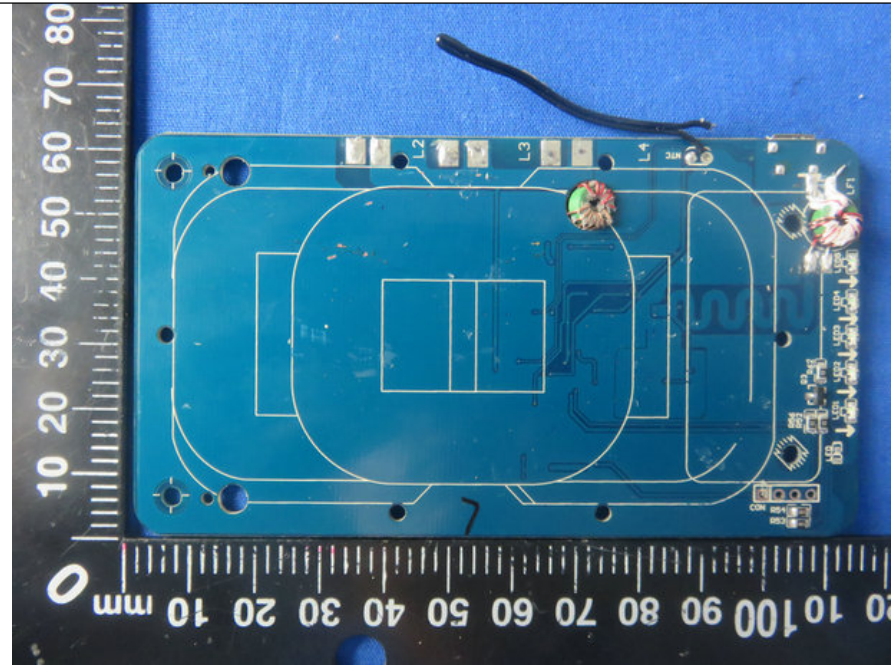

4. Figure

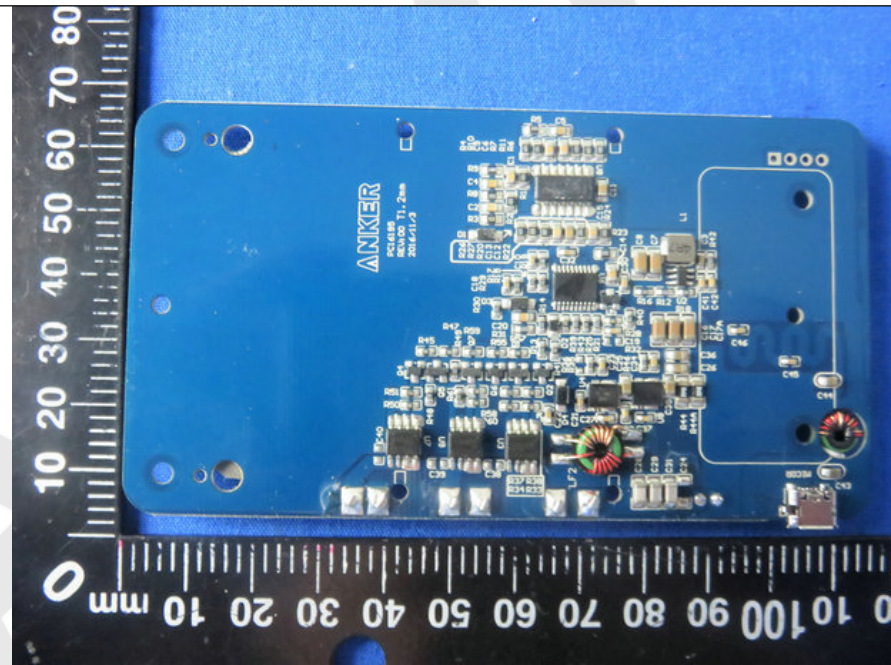

5. Figure

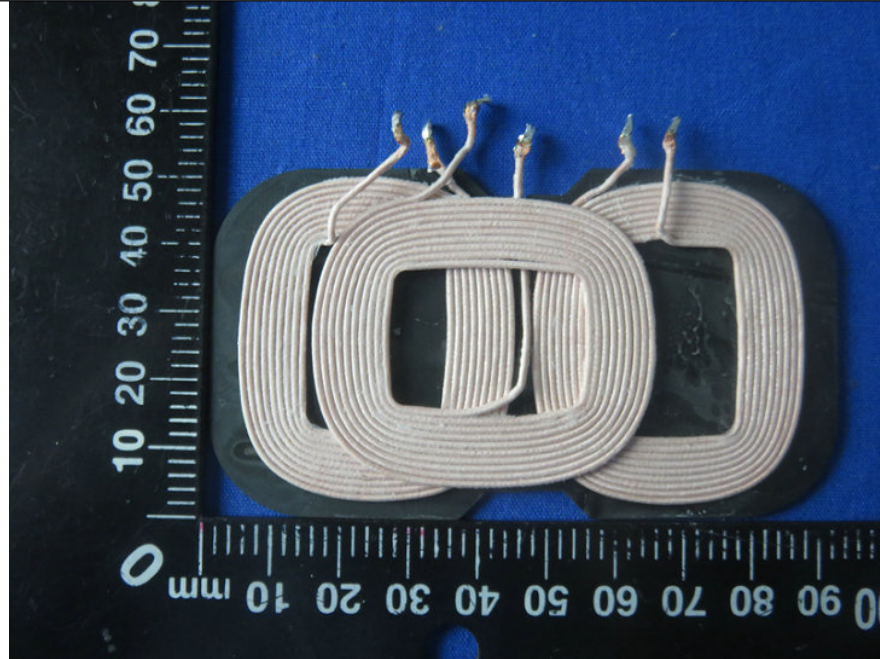

6. Figure

