



EMC Test Report

Product Name: WCDMA Digital Mobile Phone

Model Number: HUAWEI Y330-U17, Y330-U17

Report No: SYBH(Z-EMC)037032014-2

FCC ID: QISY330-U17

Reliability Laboratory of Huawei Technologies Co., Ltd.

Administration Building, Headquarters of Huawei Technologies Co., Ltd., Bantian, Longgang District,
Shenzhen, 518129, P.R.C

Tel: +86 755 28780808 Fax: +86 755 89652518



Notice

1. The laboratory has obtained the accreditation of China National Accreditation Service for Conformity Assessment (CNAS), and accreditation number: L0310.
2. The laboratory has passed the accreditation by The American Association for Laboratory Accreditation (A2LA). The accreditation number is 2174.01.
3. The laboratory has been listed on the US Federal Communications Commission list of test facilities recognized to perform electromagnetic emissions measurements. The site recognition number is 97456.
4. The laboratory has been listed by industry Canada to perform electromagnetic emission measurement. The site recognition number is 6369A-1.
5. The test report is invalid if not marked with "exclusive stamp for the test report".
6. The test report is invalid if not marked with the stamps or the signatures of the persons responsible for performing and approving the test report.
7. The test report is invalid if there is any evidence of erasure and/or falsification.
8. If there is any dissidence for the test report, please file objection to the test centre within 15 days from the date of receiving the test report.
9. Normally, the test report is only responsible for the samples that have undergone the test.
10. Context of the test report cannot be used partially or in full for publicity and/or promotional purposes without previous written approval of the laboratory.



Applicant: Huawei Technologies Co., Ltd.

Address: Administration Building, Headquarters of Huawei Technologies Co., Ltd., Bantian, Longgang District, Shenzhen, 518129, P.R.C

Date of Receipt Test Item: Mar.09,2014

Start Date of Test: Mar.30,2014

End Date of Test: Apr.03,2014

Test Result: Pass

**Approved By
(Lab Manager)**

2014-04-14
Date

Liu Chunlin
Name

Signature

**Prepared by
(Test Engineer)**

2014-04-14
Date

Wu Yafeng
Name

Signature



TABLE OF CONTENT

1	General Information.....	5
1.1	EUT Description	5
1.2	Test Site Information	7
1.3	Applied Standards	7
2	Summary of Results	8
3	System Configuration during EMC Test.....	9
3.1	Test Mode.....	9
3.2	Test System Configuration.....	9
3.3	Cables Used during Test.....	11
3.4	Associated Equipment Used during Test.....	11
4	Electromagnetic Interference (EMI)	12
4.1	Radiated Disturbance 30MHz to 18GHz.....	12
4.2	Conducted Disturbance 0.15 MHz to 30MHz.....	14
5	Main Test Instruments	15
6	System Measurement Uncertainty	16
7	Test Data and Graph	17
7.1	Radiated Disturbance.....	17
7.2	Conducted Disturbance.....	19







1 General Information

1.1 EUT Description

EUT Description	
Product Name	WCDMA Digital Mobile Phone
Model Number	HUAWEI Y330-U17, Y330-U17
Input voltage	DC 3.7V
TX Frequency	GSM 850:824MHz to 849MHz GSM1900:1850MHz to 1910MHz WCDMA Band V: 824MHz to 849MHz BT: 2402MHz to 2480MHz WIFI: 2412MHz to 2462MHz
RX Frequency	GSM850:869MHz to 894MHz GSM1900:1930MHz to 1990MHz WCDMA Band V: 869MHz to 894MHz BT: 2402 MHz to 2480MHz WIFI: 2412MHz to 2462MHz GPS: 1575.42MHz
S/N	Q9KDU14117000014
HW Version	HU1Y330TM2 Ver.A
SW Version	Y330-U17 V100R001C00B104
EUT Accessory	
Data cable	Data Cable USB A Male to Micro USB, Shielded
Adapter	Brand: HUAWEI Model: HW-050055E1W Input voltage: 100-240V~50/60Hz, 0.2A Output voltage: 5.0V $\overline{\overline{\overline{\quad}}}$ 550mA Rated Power: 2.75W S/N: BYADC1849097 S/N: HKAC52873298
Adapter	Brand: HUAWEI Model: HW-050055U1W Input voltage: 100-240V~50/60Hz, 0.2A Output voltage: 5.0V $\overline{\overline{\overline{\quad}}}$ 550mA Rated Power: 2.75W S/N: HKADC0159018 S/N: BYADB2550557
Adapter	Brand: HUAWEI Model: HW-050055B1W Input voltage: 100-240V~50/60Hz, 0.2A Output voltage: 5.0V $\overline{\overline{\overline{\quad}}}$ 550mA Rated Power: 2.75W S/N: HKAC22569748 S/N: BYADC2128448
Adapter	Brand: HUAWEI Model: HW-050055A1W Input voltage: 100-240V~50/60Hz, 0.2A Output voltage: 5.0V $\overline{\overline{\overline{\quad}}}$ 550mA Rated Power: 2.75W



	S/N: UEADA2286054 S/N: BYAD92928341
Rechargeable Li-ion	Brand: HUAWEI Battery Model: HB5N1 Rated capacity: 1350mAh Nominal Voltage:  +3.7V Charging Voltage:  +4.2V S/N: BAADC05L15800080 S/N: GAGDB17L15830509
Rechargeable Li-ion	Brand: HUAWEI Battery Model: HB5N1H Rated capacity: 1500mAh Nominal Voltage:  +3.7V Charging Voltage:  +4.2V S/N: MLCD7189218H7314 S/N:CAID302X13830928 S/N: BAADC30F20200662 S/N:UBDC204XXAS02052 S/N: GAGE101Z20221531

Remark: The above EUT's information is declared by manufacturer. Please refer to the specifications or user's manual for more detailed information.



1.2 Test Site Information

Test Site:	RELIABILITY LABORATORY OF HUAWEI TECHNOLOGIES CO., LTD.
Test Site Location:	Administration Building, Headquarters of Huawei Technologies Co., Ltd., Bantian, Longgang District, Shenzhen, 518129, P.R.C

1.3 Applied Standards

APPLIED STANDARD

47 CFR FCC Part 15:2013, Subpart B



2 Summary of Results

Summary of Results				
Test Items	Test Mode	Performance Class & Required Performance Criteria	Result	Site
<u>Radiated Emissions</u> Enclosure Port	Mode1-Mode2 Mode 4	CLASS B	Pass	Site1
<u>Conducted Emissions</u> <input checked="" type="checkbox"/> DC Power Port <input checked="" type="checkbox"/> AC Power Port <input type="checkbox"/> Telecommunication Ports	Mode 1-Mode 4	CLASS B	Pass	Site1
Note: 1, Measurement taken is within the measurement uncertainty of measurement system. 2, <input checked="" type="checkbox"/> The item has been tested; <input type="checkbox"/> The item has not been tested.				

During the measurement, the environmental conditions complied with the range listed as below.

Item	Required
Ambient temperature	15°C ~ 35°C
Relative humidity	25% ~ 75%
Atmospheric pressure	86kPa ~ 106kPa

3 System Configuration during EMC Test

3.1 Test Mode

Huawei has verified the construction and function in typical operation. All the test modes were carried out with the EUT under normal operation, which were shown in this test report and defined as below:

Test Mode	
Mode 1:	Adapter + Earphone + Camera On + Idle
Mode 2:	Adapter + Earphone + Playing + Idle
Mode 3:	Adapter + Earphone + Traffic
Mode 4:	USB Copy(EUT with PC) + Earphone + Idle

Remark:

- 1) If there is one kind of accessories with different models, each one should be applied throughout the compliance test respectively, however, only the worst case will be recorded in this report.
- 2) If EUT has more than one typical operation, only the worst test mode will be recorded in this report.

Traffic Mode:

When the EUT state is switched on and with Radio Resource Control (RRC) connection established.

Idle Mode:

When the EUT state is switched on but without Radio Resource Control (RRC) connection.

3.2 Test System Configuration

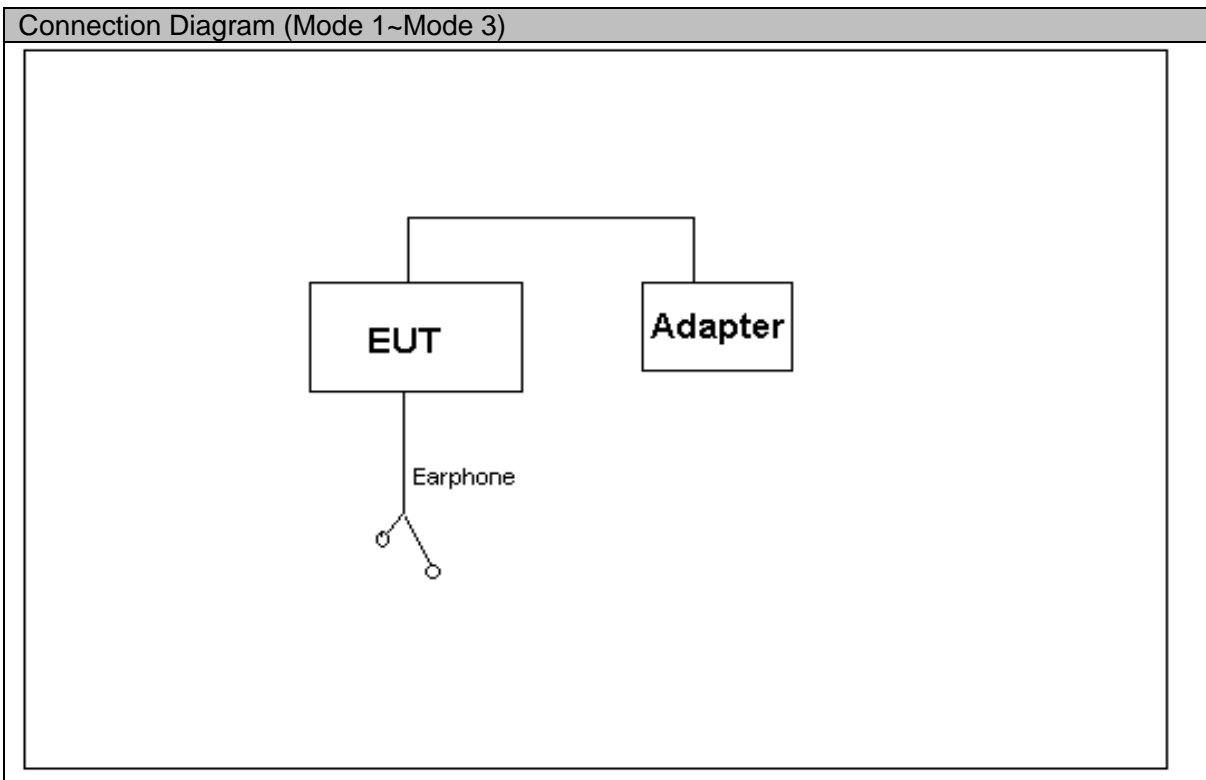

Connection Diagram (Mode 4)

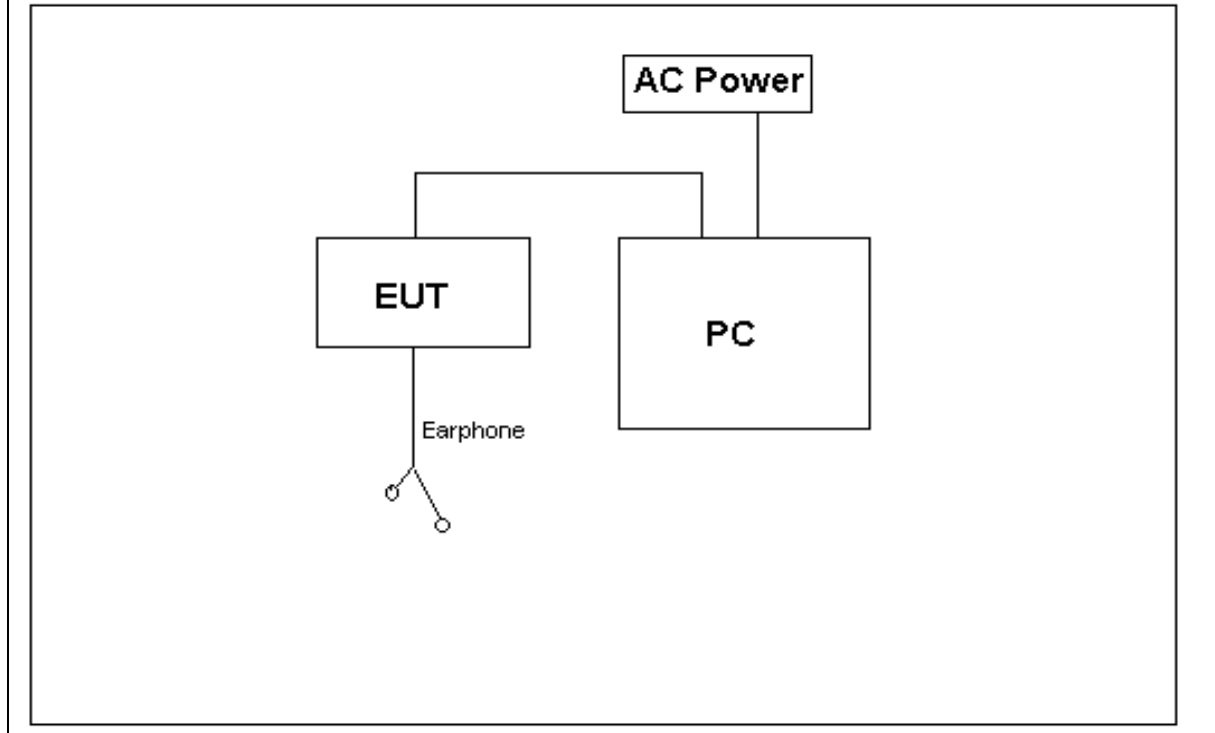



3.3 Cables Used during Test

Cable	Quantity	Length	Type of Cable
USB	1	<3m	Shielded
Earphone	1	<3m	Unshielded

3.4 Associated Equipment Used during Test

Name	Model	Manufacturer	S/N	Calibrated Deadline	Cal interval (month)
Radio Communication Tester	CMU200	R&S	3607033573	2014-10-14	12
Notebook	X200	ThinkPad	31090403588	/	/

4 Electromagnetic Interference (EMI)

4.1 Radiated Disturbance 30MHz to 18GHz

4.1.1 Test Procedure

The test site semi-anechoic chamber has met the requirement of NSA tolerance 4dB according to the standards: ANSI C63.4-2009. The test distance was 3m. The set-up and test methods were according to ANSI C63.4-2009.

A preliminary scan and a final scan of the emissions were made from 30 MHz to 18 GHz by using test script of software; The emissions were measured using Quasi-Peak Detector (30MHz~1GHz) and AV/PK detector (above 1GHz). The maximal emission value was acquired by adjusting the antenna height, polarisation and turntable azimuth in accordance with the software setup. Normally, the height range of antenna was 1m to 4m. The azimuth range of turntable was 0° to 360°. The receiving antenna has two polarizations V and H.

Measurement bandwidth (RBW) for 30MHz to 1000 MHz: 120 kHz;

Measurement bandwidth (RBW) for 1000MHz to 18000 MHz: 1MHz;

EUT was configured in idle mode and the test performed at worst emission state.

4.1.2 Test setup

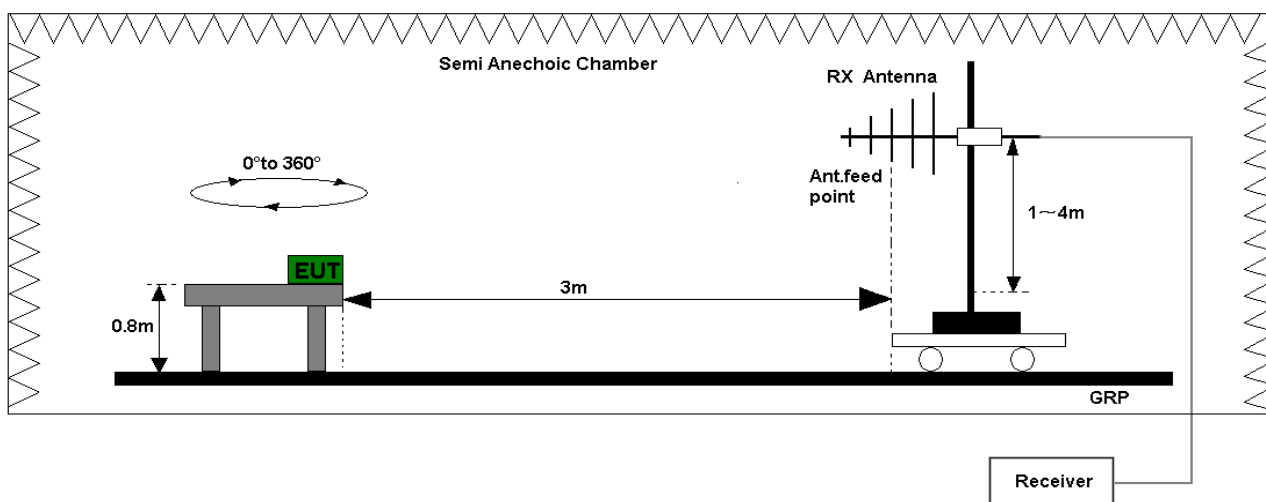

Figure 1. Test set-up of radiated disturbance(30MHz-1GHz)

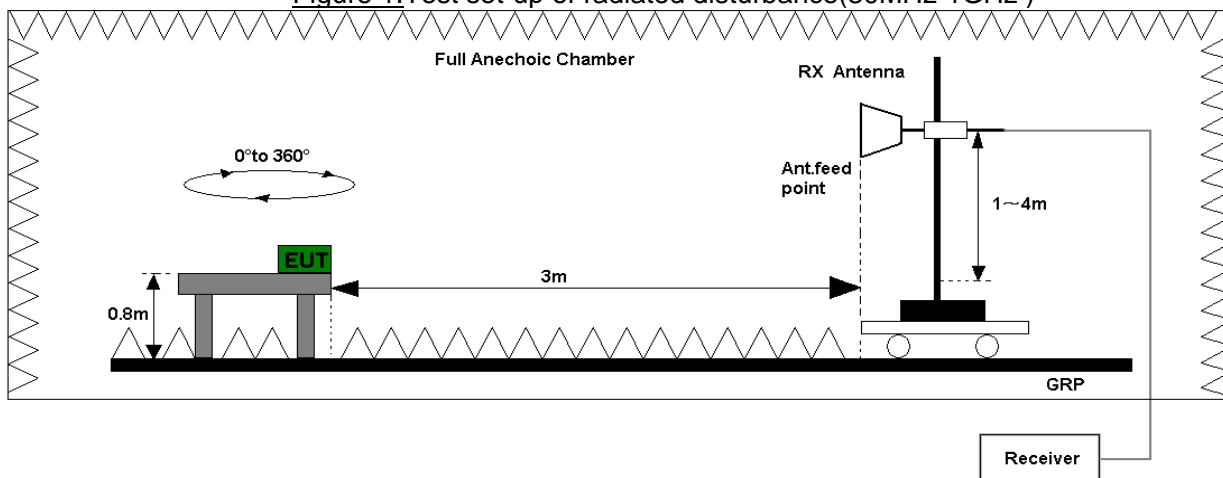

Figure 2. Test set-up of radiated disturbance(above 1GHz)



4.1.3 Test Results

The EUT has met the requirements for Radiated Emission of enclosure port.
 Refer to the section 7.1 of this report for test data..

Test Limits (Class B)				
Frequency of Emission (MHz)	Radiated Limit			
	Unit(μ V/m)		Unit(dB μ V/m)	
30-88	100		40	
88-216	150		43.5	
216-960	200		46	
Above 960	500		54	
Above 1000	AV	PK	AV	PK
	500	5000	54	74

4.2 Conducted Disturbance 0.15 MHz to 30MHz

4.2.1 Test Procedure

The Table-top EUT was placed upon a non-metallic table 0.8 m above the horizontal metal reference ground plane. EUT was connected to LISN and LISN was connected to reference Ground Plane. EUT was 80cm away from LISN. The set-up and test methods were according to ANSI C63.4-2009. Conducted Disturbance at AC Port measurements were undertaken on the L and N Lines. The emissions were measured using a Quasi-Peak Detector and Average Detector.

EUT was communicated with the simulator through Air interface, the simulator controls the EUT to transmitter the maximum power which defined in specification of product. The EUT operated on the typical channel.

Measurement bandwidth (RBW) for 150 kHz to 30 MHz: 9 kHz;

The EUT was set in the shielded chamber and operated under nominal conditions.

4.2.2 Test Setup

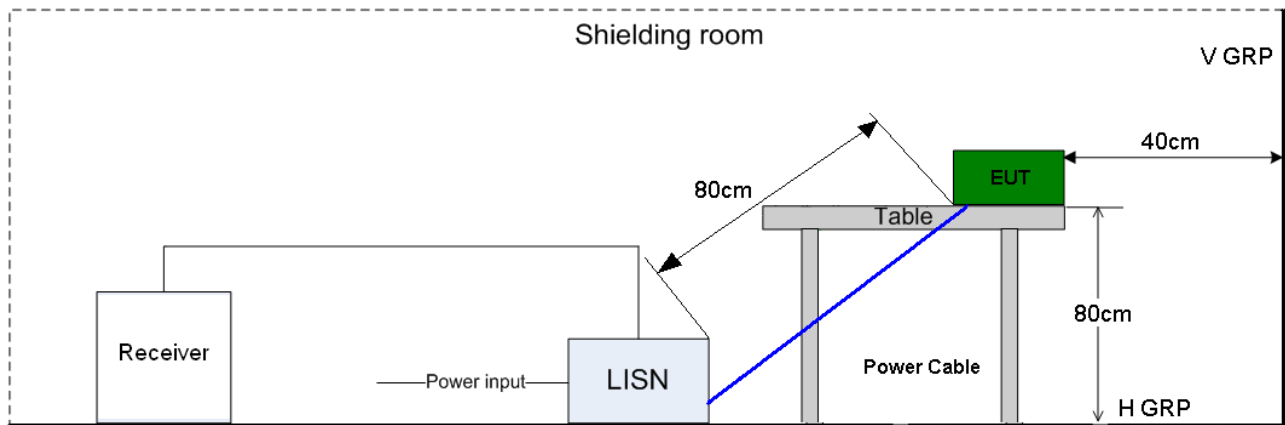

Figure 3. Test Set-up of conducted disturbance

4.2.3 Test Results

The EUT has met requirements for Conducted disturbance.

Refer to the section 7.2 of this report for test data.

Test Limit of AC Power Port		
Frequency range	150kHz ~ 30MHz	
Frequency	Voltage limits	
	QP	AV
0.15MHz~0.5MHz	66-56dB μ V	56-46 dB μ V
0.5MHz-5MHz	56dB μ V	46 dB μ V
5MHz~30MHz	60dB μ V	50 dB μ V



5 Main Test Instruments

Main Test Equipments						
Test item	Test Instrument	Model	S/N	Manufacturer	Calibrated deadline	Cal interval (month)
RE	EMI Test receiver	ESU26	100150	R&S	May.14, 2014	12
	Broadband Antenna	VULB 9163	9163-520	SCHWARZBECK	Dec.20 2015	24
	Horn Antenna	HF906	100683	R&S	Feb.01, 2015	24
CE	EMI Test receiver	ESCI	101163	R&S	Dec. 23, 2014	12
	Artificial Mains Network	ENV216	100382	R&S	Dec. 23, 2014	12
Software Information						
Test Item	Software Name		Manufacturer		Version	
RE	ES-K1		R&S		1.7.1	
CE	EMC32		R&S		V8.40.0	



6 System Measurement Uncertainty

For a 95% confidence level, the measurement expanded uncertainties for defined systems, in accordance with the recommendations of ISO 17025 were:

System Measurement Uncertainty		
Items		Extended Uncertainty
RE(30MHz-1GHz)	Field strength (dB μ V/m)	U=4.1dB; k=2
RE(1GHz-18GHz)	Field strength (dB μ V/m)	U=5.1dB; k=2
CE	Disturbance Voltage (dB μ V)	U=2.6dB; k=2



7 Test Data and Graph

Only the worst test result was shown in this report.

7.1 Radiated Disturbance

30MHz~1GHz

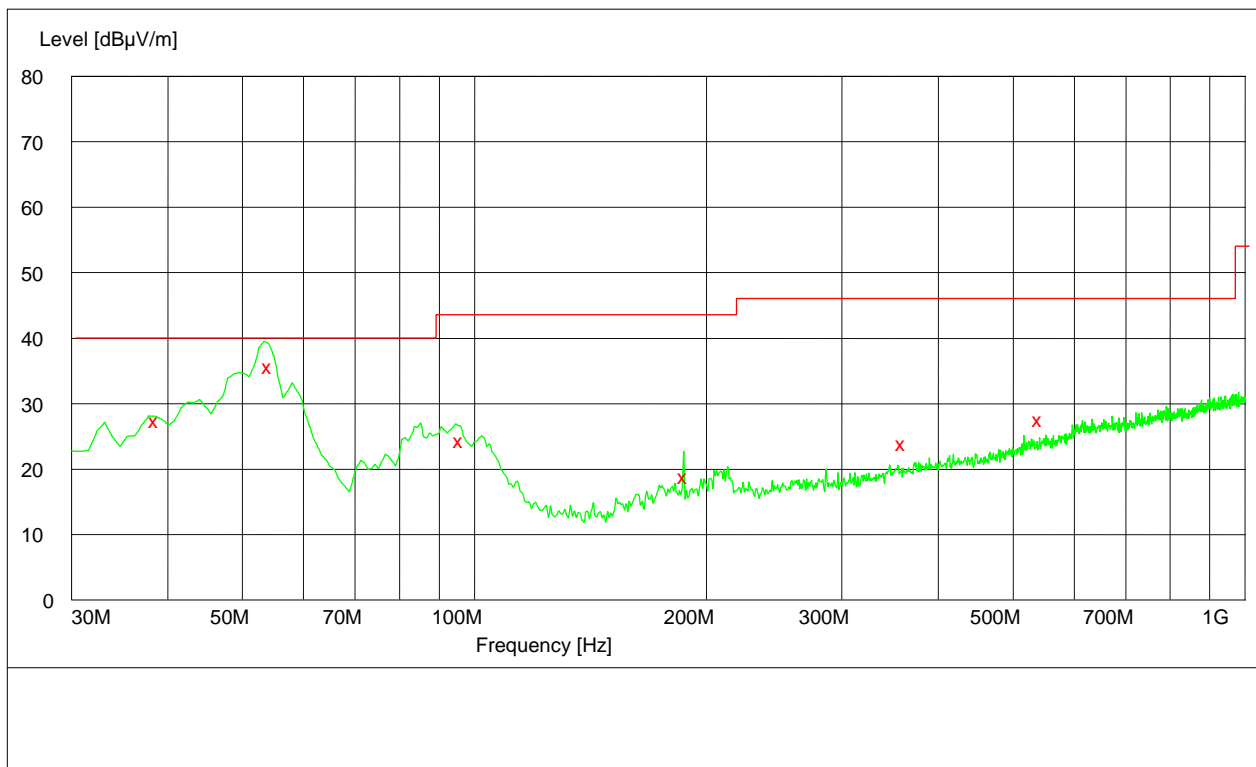

MEASUREMENT RESULT: QP Detector

Frequency MHz	Level dBµV/m	Transd dB	Limit dBµV/m	Margin dB	Height cm	Azimuth deg	Polarisation
38.580000	27.50	14.8	40.0	12.5	115.0	64.00	VERTICAL
54.180000	35.70	14.5	40.0	4.3	100.0	280.00	VERTICAL
96.000000	24.50	12.9	43.5	19.0	106.0	117.00	VERTICAL
187.500000	18.90	11.9	43.5	24.6	171.0	306.00	HORIZONTAL
360.000000	24.00	16.8	46.0	22.0	132.0	197.00	VERTICAL
541.500000	27.60	20.2	46.0	18.4	108.0	24.00	VERTICAL

Note:

Level = Reading level by receiver + Transd (Antenna factor + cable loss – preamplifier gain)

The reading level is calculated by software which is not shown in the sheet.



1GHz~18GHz

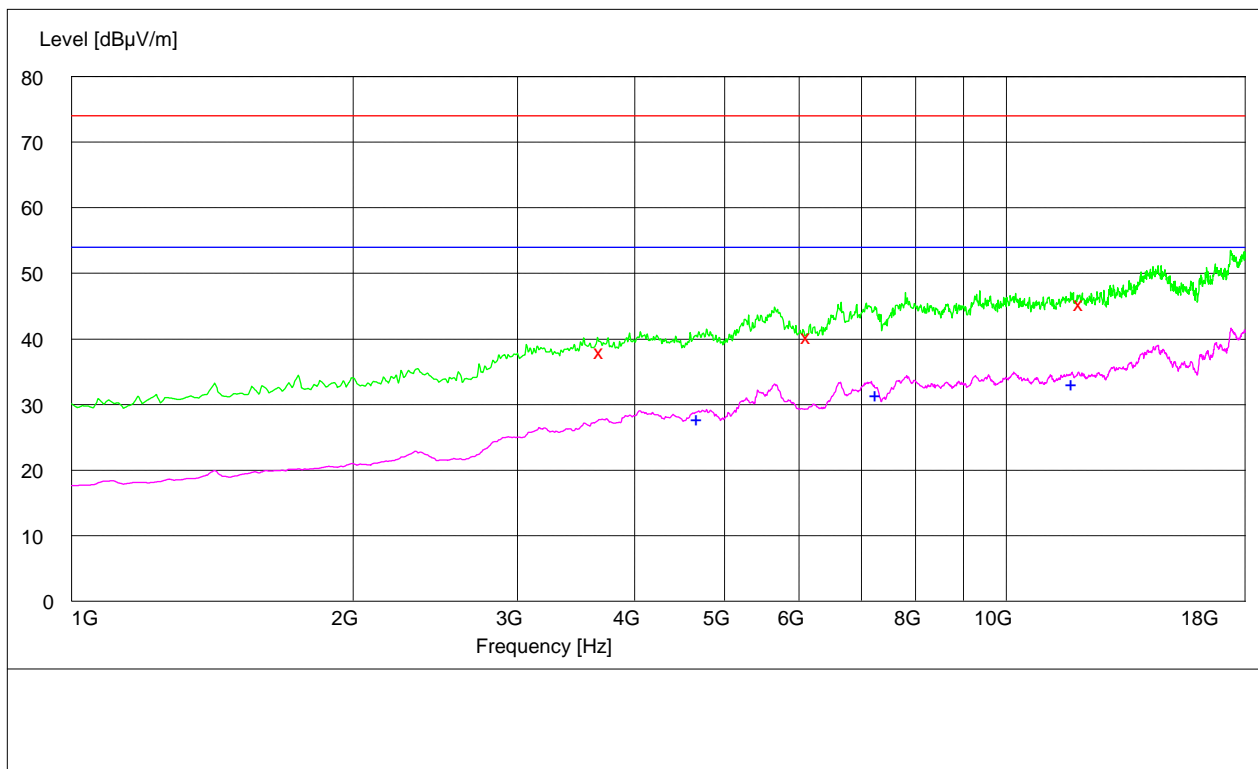

MEASUREMENT RESULT: PK Detector

Frequency MHz	Level dBµV/m	Transd dB	Limit dBµV/m	Margin dB	Height cm	Azimuth deg	Polarisation
3685.200000	38.10	-4.6	74.0	35.9	100.0	30.00	VERTICAL
6146.800000	40.40	1.1	74.0	33.6	111.0	80.00	HORIZONTAL
12032.100000	45.50	8.5	74.0	28.5	150.0	74.00	VERTICAL

MEASUREMENT RESULT: AV Detector

Frequency MHz	Level dBµV/m	Transd dB	Limit dBµV/m	Margin dB	Height cm	Azimuth deg	Polarisation
4679.700000	27.90	-2.5	54.0	26.1	147.0	152.00	HORIZONTAL
7279.700000	31.50	2.5	54.0	22.5	144.0	252.00	VERTICAL
11787.000000	33.20	8.6	54.0	20.8	100.0	263.00	HORIZONTAL

Note:

Level = Reading level by receiver + Transd (Antenna factor + cable loss – preamplifier gain)
The reading level is calculated by software which is not shown in the sheet.

7.2 Conducted Disturbance

AC Port Test Data

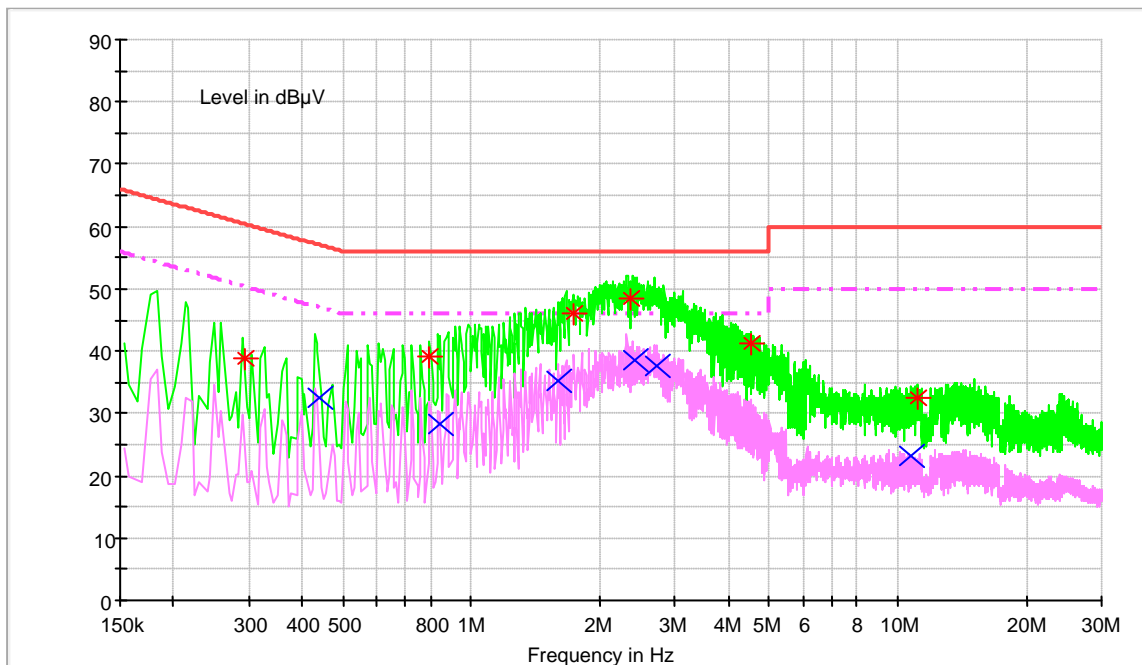

MEASUREMENT RESULT: QP Detector

Frequency MHz	Level dBµV	Line	Transd dB	Margin dB	Limit dBµV	PE
0.293692	38.8	L1	9.7	21.6	60.4	FLO
0.799568	39.3	N	9.7	16.7	56.0	FLO
1.740480	46.1	N	9.7	9.9	56.0	FLO
2.348670	48.4	N	9.7	7.6	56.0	FLO
4.524825	41.3	N	9.8	14.7	56.0	FLO
11.109863	32.5	N	10.0	27.5	60.0	FLO

MEASUREMENT RESULT: AV Detector

Frequency MHz	Level dBµV	Line	Transd dB	Margin dB	Limit dBµV	PE
0.440985	32.6	N	9.7	14.4	47.0	FLO
0.840742	28.4	N	9.7	17.6	46.0	FLO
1.606084	35.3	N	9.7	10.7	46.0	FLO
2.406394	38.5	N	9.7	7.5	46.0	FLO
2.729055	37.6	N	9.7	8.4	46.0	FLO
10.664340	23.2	N	9.9	26.8	50.0	FLO

Note:

Level= Reading level+ Transd (cable loss + correction factor)

The reading level is calculated by software which is not shown in the sheet.

-----END-----