



SAR TEST REPORT

No. I15Z43213-SEM01

For

TCL Communication Ltd.

HSUPA/HSDPA/UMTS quad band /GSM quad band mobile phone

Model Name: 4034G

With

Hardware Version: PIO

Software Version: SW3D51

FCC ID: 2ACCJH044

Issued Date: 2016-3-7



中国认可
国际互认
检测
TESTING
CNAS L0570

Note:

The test results in this test report relate only to the devices specified in this report. This report shall not be reproduced except in full without the written approval of CTTL.

Test Laboratory:

CTTL, Telecommunication Technology Labs, Academy of Telecommunication Research, MIIT
No. 51 Shouxiang Science Building, Xueyuan Road, Haidian District, Beijing, P. R. China100191
Tel:+86(0)10-62304633-2512,Fax:+86(0)10-62304633-2504
Email:cttl_terminals@catr.cn, website:www.chinattl.com



REPORT HISTORY

Report Number	Revision	Issue Date	Description
I15Z43213-SEM01	Rev.0	2016-1-29	Initial creation of test report
I15Z43213-SEM01	Rev.1	2016-3-7	Modify the data of System Verification test and the probe convF



TABLE OF CONTENT

1 TEST LABORATORY	5
1.1 TESTING LOCATION	5
1.2 TESTING ENVIRONMENT.....	5
1.3 PROJECT DATA	5
1.4 SIGNATURE.....	5
2 STATEMENT OF COMPLIANCE	6
3 CLIENT INFORMATION	8
3.1 APPLICANT INFORMATION	8
3.2 MANUFACTURER INFORMATION	8
4 EQUIPMENT UNDER TEST (EUT) AND ANCILLARY EQUIPMENT (AE)	9
4.1 ABOUT EUT	9
4.2 INTERNAL IDENTIFICATION OF EUT USED DURING THE TEST	9
4.3 INTERNAL IDENTIFICATION OF AE USED DURING THE TEST	9
5 TEST METHODOLOGY	10
5.1 APPLICABLE LIMIT REGULATIONS	10
5.2 APPLICABLE MEASUREMENT STANDARDS.....	10
6 SPECIFIC ABSORPTION RATE (SAR)	11
6.1 INTRODUCTION.....	11
6.2 SAR DEFINITION.....	11
7 TISSUE SIMULATING LIQUIDS	12
7.1 TARGETS FOR TISSUE SIMULATING LIQUID	12
7.2 DIELECTRIC PERFORMANCE	12
8 SYSTEM VERIFICATION	16
8.1 SYSTEM SETUP.....	16
8.2 SYSTEM VERIFICATION.....	17
9 MEASUREMENT PROCEDURES	18
9.1 TESTS TO BE PERFORMED	18
9.2 GENERAL MEASUREMENT PROCEDURE.....	19
9.3 WCDMA MEASUREMENT PROCEDURES FOR SAR	20
9.4 BLUETOOTH & WI-FI MEASUREMENT PROCEDURES FOR SAR	21
9.5 POWER DRIFT.....	21
10 AREA SCAN BASED 1-G SAR	22
10.1 REQUIREMENT OF KDB.....	22
10.2 FAST SAR ALGORITHMS	22
11 CONDUCTED OUTPUT POWER	23



11.1 MANUFACTURING TOLERANCE	23
11.2 GSM MEASUREMENT RESULT	26
11.3 WCDMA MEASUREMENT RESULT.....	27
11.4 WI-FI AND BT MEASUREMENT RESULT	27
12 SIMULTANEOUS TX SAR CONSIDERATIONS.....	29
12.1 INTRODUCTION.....	29
12.2 TRANSMIT ANTENNA SEPARATION DISTANCES	29
12.3 SAR MEASUREMENT POSITIONS	30
12.4 STANDALONE SAR TEST EXCLUSION CONSIDERATIONS	30
13 EVALUATION OF SIMULTANEOUS.....	31
14 SAR TEST RESULT	32
14.1 THE EVALUATION OF MULTI-BATTERIES	32
14.2 SAR RESULTS FOR FAST SAR.....	33
14.3 SAR RESULTS FOR STANDARD PROCEDURE.....	36
14.4 WLAN EVALUATION	38
15 SAR MEASUREMENT VARIABILITY.....	40
16 MEASUREMENT UNCERTAINTY	41
16.1 MEASUREMENT UNCERTAINTY FOR NORMAL SAR TESTS (300MHZ~3GHZ)	41
16.2 MEASUREMENT UNCERTAINTY FOR NORMAL SAR TESTS (3~6GHZ)	42
16.3 MEASUREMENT UNCERTAINTY FOR FAST SAR TESTS (300MHZ~3GHZ)	43
16.4 MEASUREMENT UNCERTAINTY FOR FAST SAR TESTS (3~6GHZ).....	44
17 MAIN TEST INSTRUMENTS.....	45
ANNEX A GRAPH RESULTS.....	46
ANNEX B SYSTEMVERIFICATION RESULTS	66
ANNEX C SAR MEASUREMENT SETUP	73
ANNEX D POSITION OF THE WIRELESS DEVICE IN RELATION TO THE PHANTOM	79
ANNEX E EQUIVALENT MEDIA RECIPES.....	82
ANNEX F SYSTEM VALIDATION	83
ANNEX G PROBE CALIBRATION CERTIFICATE.....	84
ANNEX H DIPOLE CALIBRATION CERTIFICATE	95
ANNEX I ACCREDITATION CERTIFICATE.....	119

1 Test Laboratory

1.1 Testing Location

Company Name:	CTTL(Shouxiang)
Address:	No. 51 Shouxiang Science Building, Xueyuan Road, Haidian District, Beijing, P. R. China100191

1.2 Testing Environment

Temperature:	18°C~25°C,
Relative humidity:	30%~ 70%
Ground system resistance:	< 0.5 Ω
Ambient noise & Reflection:	< 0.012 W/kg

1.3 Project Data

Project Leader:	Qi Dianyuan
Test Engineer:	Lin Xiaojun
Testing Start Date:	January 1, 2016
Testing End Date:	January 3, 2016

1.4 Signature



Lin Xiaojun
(Prepared this test report)

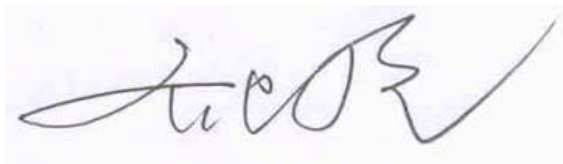

Qi Dianyuan
(Reviewed this test report)



Xiao Li
Deputy Director of the laboratory
(Approved this test report)

2 Statement of Compliance

The maximum results of Specific Absorption Rate (SAR) found during testing for TCL Communication Ltd HSUPA/HSDPA/UMTS quad band /GSM quad band mobile phone 4034G are as follows:

Table 2.1: Highest Reported SAR (1g)

Exposure Configuration	Technology Band	Highest Reported SAR 1g(W/Kg)	Equipment Class
Head (Separation Distance 0mm)	GSM 850	0.97	PCE
	PCS 1900	0.47	
	UMTS FDD 5	0.94	
	UMTS FDD 2	0.55	
	WLAN 2.4 GHz	0.20	DTS
Body-worn (Separation Distance 10mm)	GSM 850	0.83	PCE
	PCS 1900	0.81	
	UMTS FDD 5	1.01	
	UMTS FDD 2	0.87	
	WLAN 2.4 GHz	0.10	DTS

The SAR values found for the Mobile Phone are below the maximum recommended levels of 1.6 W/Kg as averaged over any 1g tissue according to the ANSI C95.1-1992.

For body worn operation, this device has been tested and meets FCC RF exposure guidelines when used with any accessory that contains no metal and which provides a minimum separation distance of 10 mm between this device and the body of the user. Use of other accessories may not ensure compliance with FCC RF exposure guidelines.

The EUT battery must be fully charged and checked periodically during the test to ascertain uniform power output.

The measurement together with the test system set-up is described in annex C of this test report. A detailed description of the equipment under test can be found in chapter 4 of this test report.

The highest reported SAR value is obtained at the case of **(Table 2.1)**, and the values are: **1.01 W/kg(1g)**.

Table 2.2: The sum of reported SAR values for main antenna and WiFi

	Position	Main antenna	WiFi	Sum
Highest reported SAR value for Head	Left hand, Touch cheek	0.97	0.20	1.17
Highest reported SAR value for Body	Rear	1.01	0.10	1.11

Table 2.3: The sum of reported SAR values for main antenna and Bluetooth

	Position	Main antenna	BT*	Sum
Highest reported SAR value for Head	Left hand, Touch cheek	0.97	0.29	1.26
Highest reported SAR value for Body	Rear	1.01	0.15	1.16

BT* - Estimated SAR for Bluetooth (see the table 13.3)

According to the above tables, the highest sum of reported SAR values is **1.26 W/kg (1g)**. The detail for simultaneous transmission consideration is described in chapter 13.



3 Client Information

3.1 Applicant Information

Company Name:	TCL Communication Ltd
Address /Post:	5F, C building, No. 232, Liang Jing Road ZhangJiang High-Tech Park, Pudong Area Shanghai, P.R. China. 201203
City:	Shanghai
Postal Code:	201203
Country:	P.R.China
Contact:	Gong Zhizhou
Email:	zhizhou.gong@tcl.com
Telephone:	0086-21-51798260
Fax:	0086-21-61460602

3.2 Manufacturer Information

Company Name:	TCL Communication Ltd
Address /Post:	5F, C building, No. 232, Liang Jing Road ZhangJiang High-Tech Park, Pudong Area Shanghai, P.R. China. 201203
City:	Shanghai
Postal Code:	201203
Country:	P.R.China
Contact:	Gong Zhizhou
Email:	zhizhou.gong@tcl.com
Telephone:	0086-21-51798260
Fax:	0086-21-61460602

4 Equipment Under Test (EUT) and Ancillary Equipment (AE)

4.1 About EUT

Description:	HSUPA/HSDPA/UMTS quad band /GSM quad band mobile phone
Model Name:	4034G
Operating mode(s):	GSM 850/900/1800/1900, WCDMA 850/900/1900/2100, BT, Wi-Fi
Tested Tx Frequency:	825 – 848.8 MHz (GSM 850)
	1850.2 – 1910 MHz (GSM 1900)
	826.4–846.6 MHz (WCDMA850 Band V)
	1852.4–1907.6 MHz (WCDMA1900 Band II)
	2412 – 2462 MHz (Wi-Fi 2.4G)
GPRS/EGPRS Multislot Class:	12
GPRS capability Class:	B
Device type:	Portable device
Antenna type:	Integrated antenna
Accessories/Body-worn configurations:	Headset
Hotspot mode:	Support simultaneous transmission of hotspot and voice(or data)

4.2 Internal Identification of EUT used during the test

EUT ID*	SN or IMEI	HW Version	SW Version
EUT1	014528000100523	PIO	SW3D51
EUT2	014528000100531	PIO	SW3D51
EUT3	014528000100515	PIO	SW3D51
EUT4	014528000100903	PIO	SW3D51

*EUT ID: is used to identify the test sample in the lab internally.

Note: It is performed to test SAR with the EUT 1&2 and conducted power with the EUT 3&4.

4.3 Internal Identification of AE used during the test

AE ID*	Description	Model	SN	Manufacturer
AE1	Battery	CAB1500040C1	/	BYD
AE2	Battery	CAB1500041C1	/	BYD
AE3	Battery	CAB1500042C7	/	WEKEN
AE4	Battery	CAB1500043C7	/	WEKEN
AE5	Headset	CCB3160A15C1	/	Juwei
AE6	Headset	CCB3160A11C1	/	Juwei
AE7	Headset	CCB3160A15C4	/	Meihao
AE8	Headset	CCB3160A11C4	/	Meihao
AE9	Headset	CCB0002A10C1	/	Juwei
AE10	Headset	CCB0002A10C4	/	Meihao

*AE ID: is used to identify the test sample in the lab internally.

Note: AE1 and AE2 are the same, so they can use the same results. AE3 and AE4 are the same, so they can use the same results. AE5 and AE6 are the same, so they can use the same results. AE7 and AE8 are the same, so they can use the same results.



5 TEST METHODOLOGY

5.1 Applicable Limit Regulations

ANSI C95.1–1992: IEEE Standard for Safety Levels with Respect to Human Exposure to Radio Frequency Electromagnetic Fields, 3 kHz to 300 GHz.

It specifies the maximum exposure limit of **1.6 W/kg** as averaged over any 1 gram of tissue for portable devices being used within 20 cm of the user in the uncontrolled environment.

5.2 Applicable Measurement Standards

IEEE 1528–2013: Recommended Practice for Determining the Peak Spatial-Average Specific Absorption Rate (SAR) in the Human Head from Wireless Communications Devices: Measurement Techniques.

KDB447498 D01: General RF Exposure Guidance v06: Mobile and Portable Devices RF Exposure Procedures and Equipment Authorization Policies.

KDB648474 D04 Handset SAR v01r03: SAR Evaluation Considerations for Wireless Handsets.

KDB941225 D01 SAR test for 3G devices v03r01: SAR Measurement Procedures for 3G Devices

KDB941225 D05 SAR for LTE Devices v02r05: SAR Evaluation Considerations for LTE Devices

KDB941225 D06 Hotspot Mode SAR v02r01: SAR Evaluation Procedures for Portable Devices with Wireless Router Capabilities

KDB248227 D01 802.11 Wi-Fi SAR v02r02: SAR GUIDANCE FOR IEEE 802.11 (Wi-Fi) TRANSMITTERS

KDB865664 D01 SAR measurement 100 MHz to 6 GHz v01r04: SAR Measurement Requirements for 100 MHz to 6 GHz.

KDB865664 D02 RF Exposure Reporting v01r02: RF Exposure Compliance Reporting and Documentation Considerations

6 Specific Absorption Rate (SAR)

6.1 Introduction

SAR is related to the rate at which energy is absorbed per unit mass in an object exposed to a radio field. The SAR distribution in a biological body is complicated and is usually carried out by experimental techniques or numerical modeling. The standard recommends limits for two tiers of groups, occupational/controlled and general population/uncontrolled, based on a person's awareness and ability to exercise control over his or her exposure. In general, occupational/controlled exposure limits are higher than the limits for general population/uncontrolled.

6.2 SAR Definition

The SAR definition is the time derivative (rate) of the incremental energy (dW) absorbed by (dissipated in) an incremental mass (dm) contained in a volume element (dv) of a given density (ρ). The equation description is as below:

$$SAR = \frac{d}{dt} \left(\frac{dW}{dm} \right) = \frac{d}{dt} \left(\frac{dW}{\rho dv} \right)$$

SAR is expressed in units of Watts per kilogram (W/kg)

SAR measurement can be either related to the temperature elevation in tissue by

$$SAR = c \left(\frac{\delta T}{\delta t} \right)$$

Where: C is the specific heat capacity, δT is the temperature rise and δt is the exposure duration, or related to the electrical field in the tissue by

$$SAR = \frac{\sigma |E|^2}{\rho}$$

Where: σ is the conductivity of the tissue, ρ is the mass density of tissue and E is the RMS electrical field strength.

However for evaluating SAR of low power transmitter, electrical field measurement is typically applied.

7 Tissue Simulating Liquids

7.1 Targets for tissue simulating liquid

Table 7.1: Targets for tissue simulating liquid

Frequency (MHz)	Liquid Type	Conductivity (σ)	$\pm 5\%$ Range	Permittivity (ϵ)	$\pm 5\%$ Range
835	Head	0.90	0.86~0.95	41.5	39.4~43.6
835	Body	0.97	0.92~1.02	55.2	52.4~58.0
1900	Head	1.40	1.33~1.47	40.0	38.0~42.0
1900	Body	1.52	1.44~1.60	53.3	50.6~56.0
2450	Head	1.80	1.71~1.89	39.2	37.2~41.2
2450	Body	1.95	1.85~2.05	52.7	50.1~55.3

7.2 Dielectric Performance

Table 7.2: Dielectric Performance of Tissue Simulating Liquid

Measurement Date (yyyy-mm-dd)	Type	Frequency	Permittivity ϵ	Drift (%)	Conductivity σ (S/m)	Drift (%)
2016-01-01	Head	835 MHz	41.13	-0.89	0.922	2.44
	Body	835 MHz	56.24	1.88	0.973	0.31
2016-01-02	Head	1900 MHz	39.77	-0.57	1.426	1.86
	Body	1900 MHz	54.04	1.39	1.549	1.91
2016-01-03	Head	2450 MHz	38.02	-3.01	1.823	1.28
	Body	2450 MHz	51.64	-2.01	1.975	1.28

Note: The liquid temperature is 22.0°C

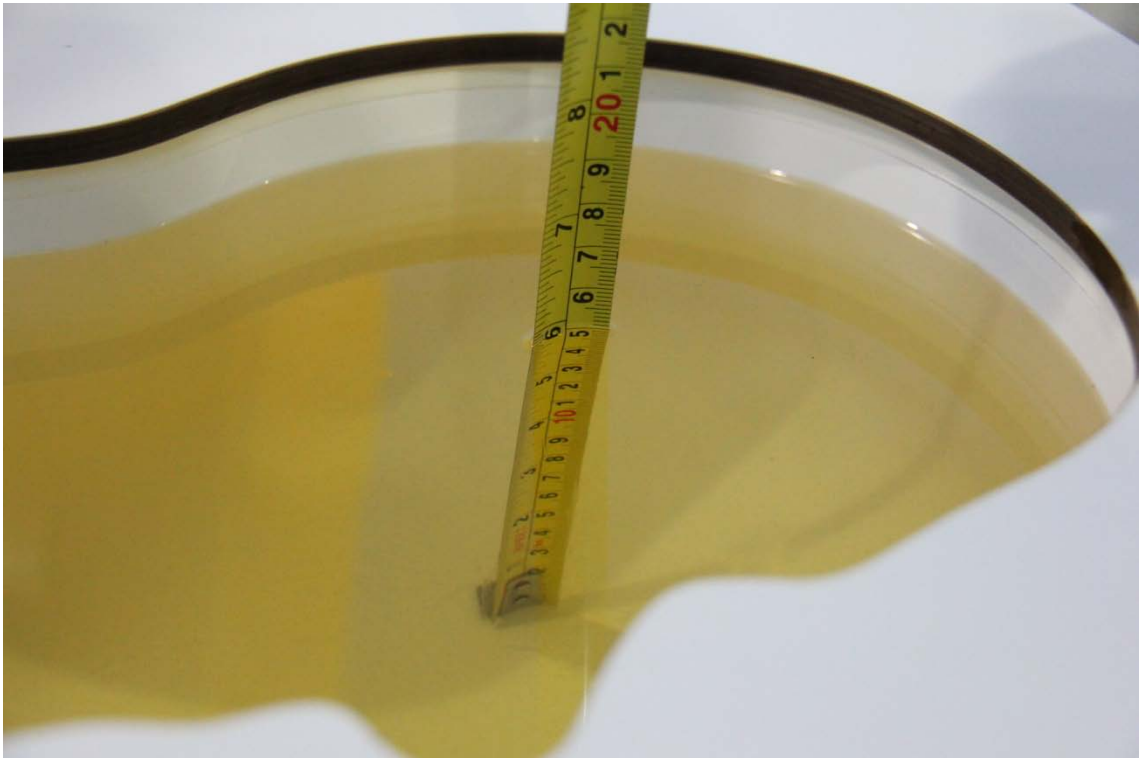

Picture 7-1: Liquid depth in the Head Phantom (835MHz)

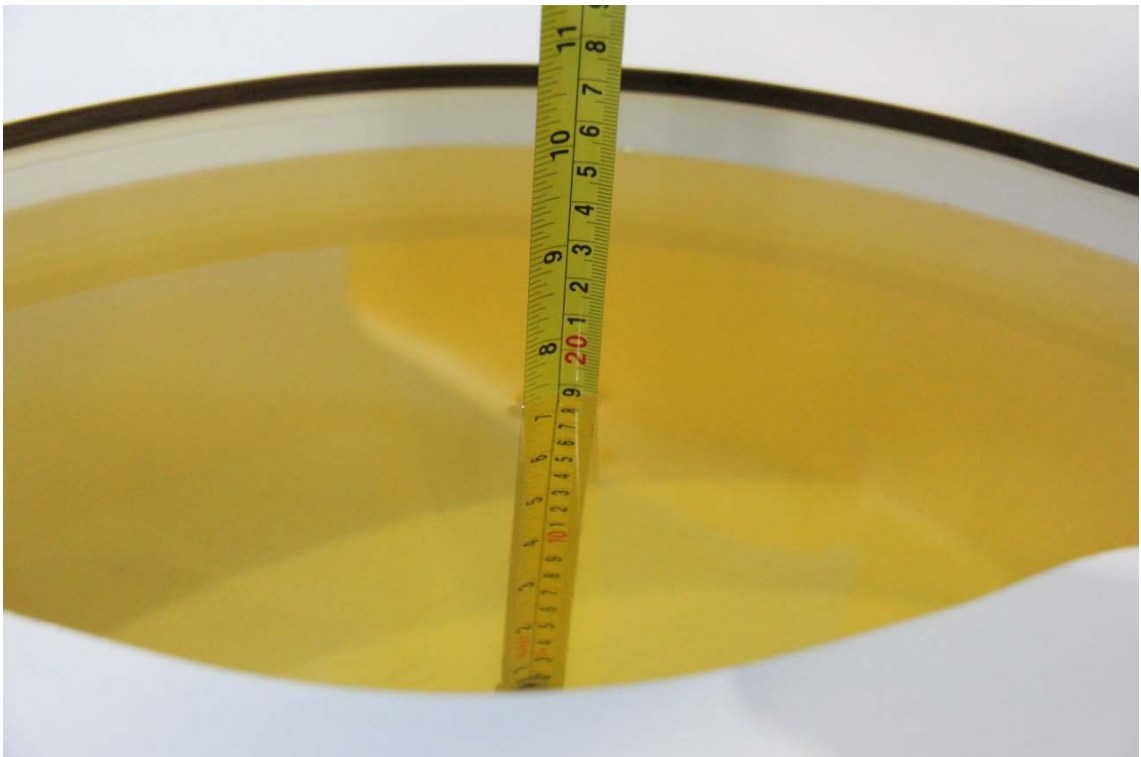

Picture 7-2: Liquid depth in the Flat Phantom (835MHz)

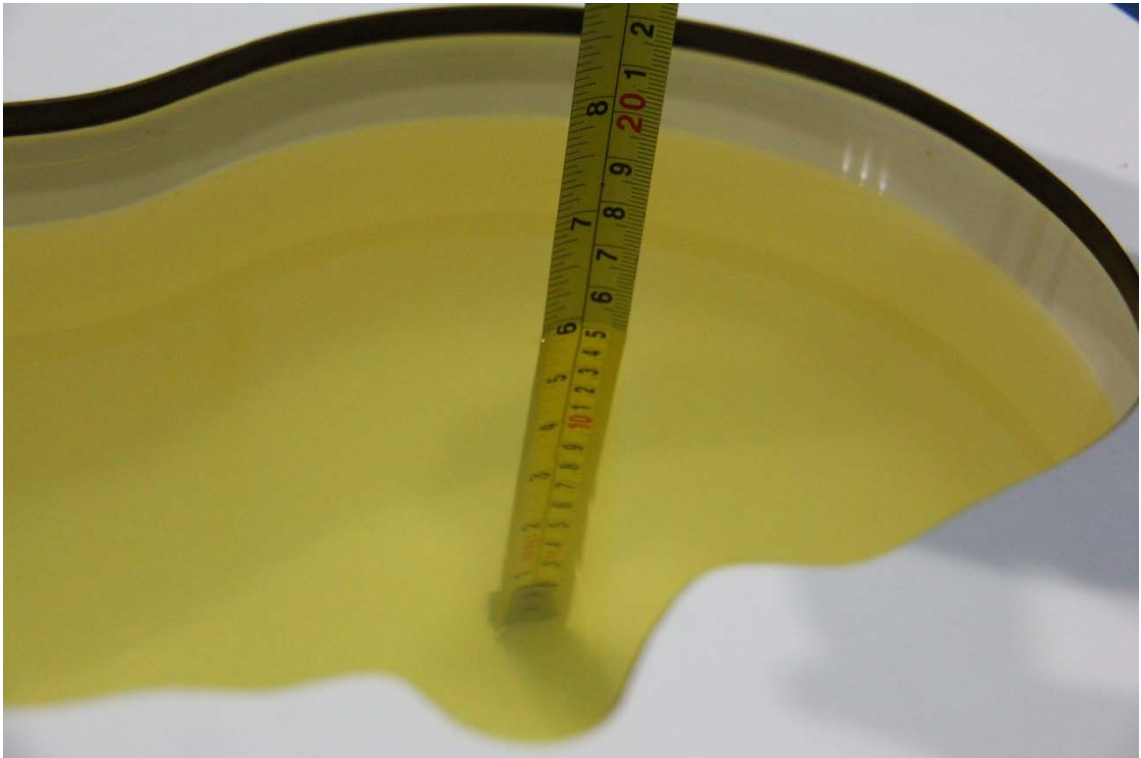

Picture 7-3: Liquid depth in the Head Phantom (1900 MHz)



Picture 7-4 Liquid depth in the Flat Phantom (1900MHz)

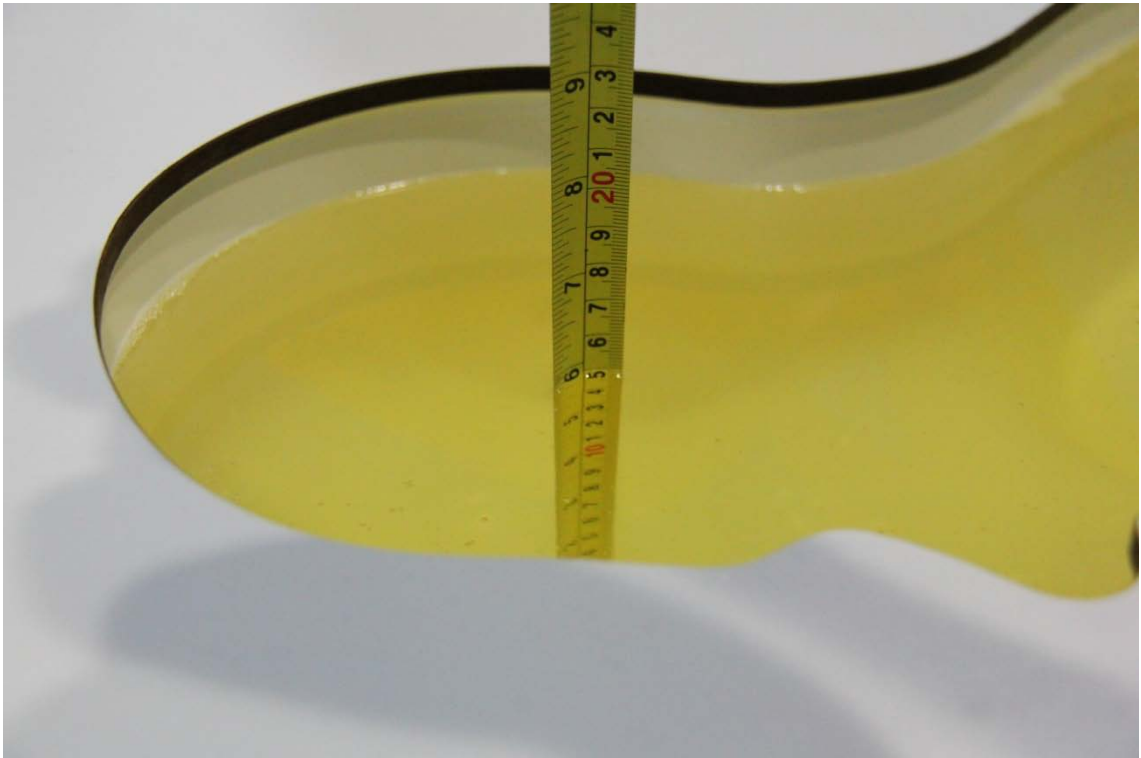

Picture 7-5 Liquid depth in the Head Phantom (2450MHz)



Picture 7-6 Liquid depth in the Flat Phantom (2450MHz)

8 System verification

8.1 System Setup

In the simplified setup for system evaluation, the DUT is replaced by a calibrated dipole and the power source is replaced by a continuous wave that comes from a signal generator. The calibrated dipole must be placed beneath the flat phantom section of the SAM twin phantom with the correct distance holder. The distance holder should touch the phantom surface with a light pressure at the reference marking and be oriented parallel to the long side of the phantom. The equipment setup is shown below:

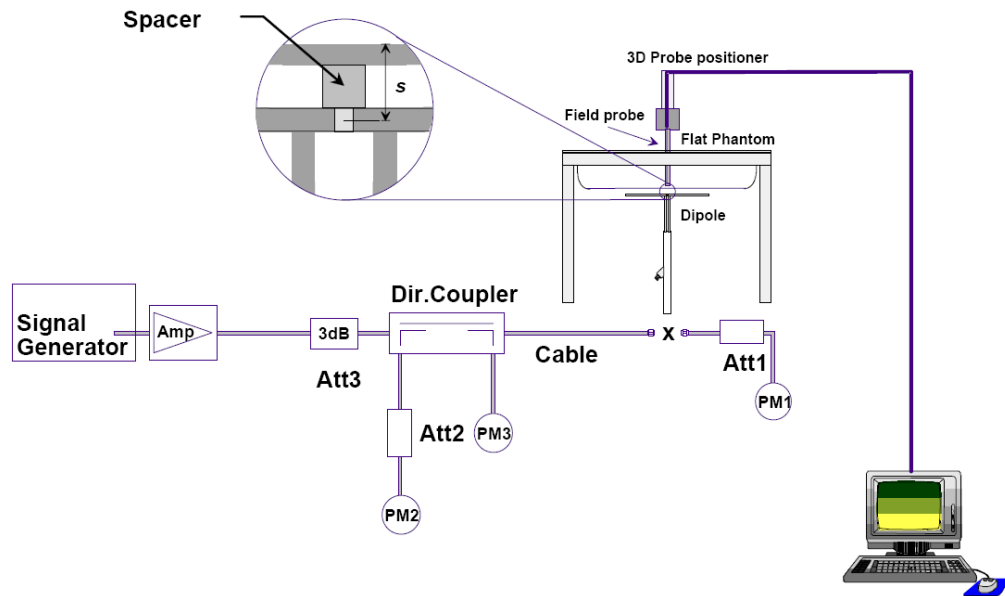

Picture 8.1 System Setup for System Evaluation



Picture 8.2 Photo of Dipole Setup

8.2 System Verification

SAR system verification is required to confirm measurement accuracy, according to the tissue dielectric media, probe calibration points and other system operating parameters required for measuring the SAR of a test device. The system verification must be performed for each frequency band and within the valid range of each probe calibration point required for testing the device.

The system verification results are required that the area scan estimated 1-g SAR is within 3% of the zoom scan 1-g SAR. The details are presented in annex B.

Table 8.1: System Verification of Head

Measurement Date (yyyy-mm-dd)	Frequency	Target value (W/kg)		Measured value(W/kg)		Deviation	
		10 g Average	1 g Average	10 g Average	1 g Average	10 g Average	1 g Average
2016-01-01	835 MHz	5.86	9.01	5.92	9.16	1.02%	1.66%
2016-01-02	1900 MHz	21.5	40.7	21.88	41.56	1.77%	2.11%
2016-01-03	2450 MHz	24.5	52.5	24.56	52.52	0.24%	0.04%

Table 8.2: System Verification of Body

Measurement Date (yyyy-mm-dd)	Frequency	Target value (W/kg)		Measured value (W/kg)		Deviation	
		10 g Average	1 g Average	10 g Average	1 g Average	10 g Average	1 g Average
2016-01-01	835 MHz	6.12	9.29	6.20	9.36	1.31%	0.75%
2016-01-02	1900 MHz	21.7	40.4	21.96	41.36	1.20%	2.38%
2016-01-03	2450 MHz	24.4	52.1	24.00	50.84	-1.64%	-2.42%

9 Measurement Procedures

9.1 Tests to be performed

In order to determine the highest value of the peak spatial-average SAR of a handset, all device positions, configurations and operational modes shall be tested for each frequency band according to steps 1 to 3 below. A flowchart of the test process is shown in picture 9.1.

Step 1: The tests described in 9.2 shall be performed at the channel that is closest to the centre of the transmit frequency band (f_c) for:

- a) all device positions (cheek and tilt, for both left and right sides of the SAM phantom, as described in annex D),
- b) all configurations for each device position in a), e.g., antenna extended and retracted, and
- c) all operational modes, e.g., analogue and digital, for each device position in a) and configuration in b) in each frequency band.

If more than three frequencies need to be tested according to 11.1 (i.e., $N_c > 3$), then all frequencies, configurations and modes shall be tested for all of the above test conditions.

Step 2: For the condition providing highest peak spatial-average SAR determined in Step 1, perform all tests described in 9.2 at all other test frequencies, i.e., lowest and highest frequencies. In addition, for all other conditions (device position, configuration and operational mode) where the peak spatial-average SAR value determined in Step 1 is within 3 dB of the applicable SAR limit, it is recommended that all other test frequencies shall be tested as well.

Step 3: Examine all data to determine the highest value of the peak spatial-average SAR found in Steps 1 to 2.

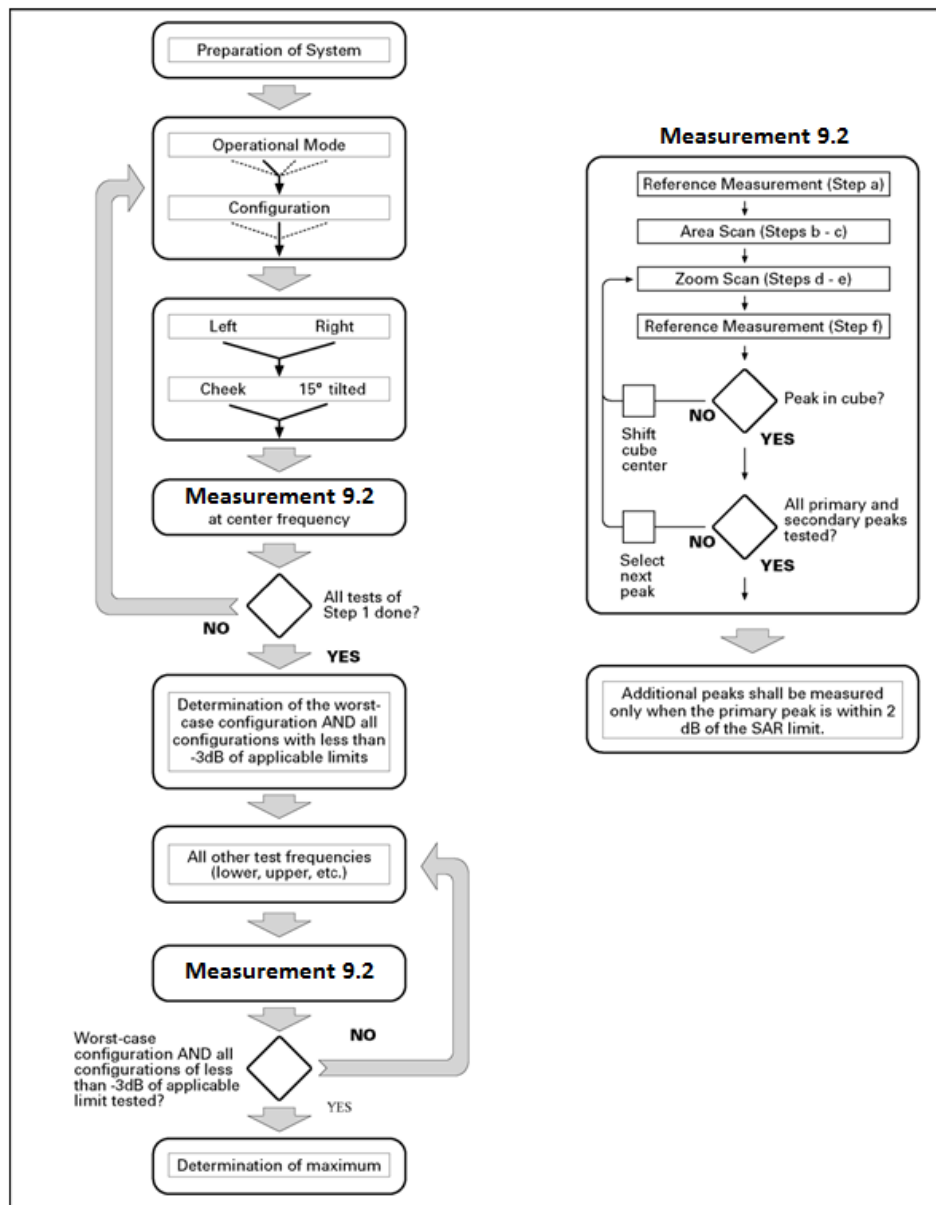

Picture 9.1 Block diagram of the tests to be performed

9.2 General Measurement Procedure

The area and zoom scan resolutions specified in the table below must be applied to the SAR measurements and fully documented in SAR reports to qualify for TCB approval. Probe boundary effect error compensation is required for measurements with the probe tip closer than half a probe tip diameter to the phantom surface. Both the probe tip diameter and sensor offset distance must satisfy measurement protocols; to ensure probe boundary effect errors are minimized and the higher fields closest to the phantom surface can be correctly measured and extrapolated to the phantom surface for computing 1-g SAR. Tolerances of the post-processing algorithms must be verified by the test laboratory for the scan resolutions used in the SAR measurements, according to the reference distribution functions specified in IEEE Std 1528-2003. The results should be documented as part of the system validation records and may be requested to support test results

when all the measurement parameters in the following table are not satisfied.

		≤ 3 GHz	> 3 GHz
Maximum distance from closest measurement point (geometric center of probe sensors) to phantom surface		5 ± 1 mm	$\frac{1}{2} \delta \ln(2) \pm 0.5$ mm
Maximum probe angle from probe axis to phantom surface normal at the measurement location		$30^\circ \pm 1^\circ$	$20^\circ \pm 1^\circ$
Maximum area scan spatial resolution: $\Delta x_{Area}, \Delta y_{Area}$		≤ 2 GHz: ≤ 15 mm 2 – 3 GHz: ≤ 12 mm	3 – 4 GHz: ≤ 12 mm 4 – 6 GHz: ≤ 10 mm
		When the x or y dimension of the test device, in the measurement plane orientation, is smaller than the above, the measurement resolution must be \leq the corresponding x or y dimension of the test device with at least one measurement point on the test device.	
Maximum zoom scan spatial resolution: $\Delta x_{Zoom}, \Delta y_{Zoom}$		≤ 2 GHz: ≤ 8 mm 2 – 3 GHz: ≤ 5 mm*	3 – 4 GHz: ≤ 5 mm* 4 – 6 GHz: ≤ 4 mm*
Maximum zoom scan spatial resolution, normal to phantom surface	uniform grid: $\Delta z_{Zoom}(n)$	≤ 5 mm	3 – 4 GHz: ≤ 4 mm 4 – 5 GHz: ≤ 3 mm 5 – 6 GHz: ≤ 2 mm
	graded grid $\Delta z_{Zoom}(1)$: between 1 st two points closest to phantom surface	≤ 4 mm	3 – 4 GHz: ≤ 3 mm 4 – 5 GHz: ≤ 2.5 mm 5 – 6 GHz: ≤ 2 mm
	$\Delta z_{Zoom}(n>1)$: between subsequent points	$\leq 1.5 \cdot \Delta z_{Zoom}(n-1)$	
Minimum zoom scan volume	x, y, z	≥ 30 mm	3 – 4 GHz: ≥ 28 mm 4 – 5 GHz: ≥ 25 mm 5 – 6 GHz: ≥ 22 mm
Note: δ is the penetration depth of a plane-wave at normal incidence to the tissue medium; see draft standard IEEE P1528-2011 for details. * When zoom scan is required and the <i>reported</i> SAR from the area scan based <i>I-g SAR estimation</i> procedures of KDB 447498 is ≤ 1.4 W/kg, ≤ 8 mm, ≤ 7 mm and ≤ 5 mm zoom scan resolution may be applied, respectively, for 2 GHz to 3 GHz, 3 GHz to 4 GHz and 4 GHz to 6 GHz.			

9.3 WCDMA Measurement Procedures for SAR

The following procedures are applicable to WCDMA handsets operating under 3GPP Release99, Release 5 and Release 6. The default test configuration is to measure SAR with an established radio link between the DUT and a communication test set using a 12.2kbps RMC (reference measurement channel) configured in Test Loop Mode 1. SAR is selectively confirmed for other physical channel configurations (DPCCH & DPDCH_n), HSDPA and HSPA (HSUPA/HSDPA) modes according to output power, exposure conditions and device operating capabilities. Both uplink and downlink should be configured with the same RMC or AMR, when required. SAR for Release 5 HSDPA and Release 6 HSPA are measured using the applicable FRC (fixed reference channel) and E-DCH reference channel configurations. Maximum output power is verified according to applicable versions of 3GPP TS 34.121 and SAR must be measured according to these maximum output conditions. When Maximum Power Reduction (MPR) is not implemented according to Cubic Metric (CM) requirements for Release 6 HSPA, the following procedures do not apply.

For Release 5 HSDPA Data Devices:

Sub-test	β_c	β_d	β_d (SF)	β_c / β_d	β_{hs}	CM/dB
1	2/15	15/15	64	2/15	4/15	0.0
2	12/15	15/15	64	12/15	24/25	1.0
3	15/15	8/15	64	15/8	30/15	1.5
4	15/15	4/15	64	15/4	30/15	1.5

For Release 6 HSPA Data Devices

Sub-test	β_c	β_d	β_d (SF)	β_c / β_d	β_{hs}	β_{ec}	β_{ed}	β_{ed} (SF)	β_{ed} (codes)	CM (dB)	MPR (dB)	AG Index	E-TFCI
1	11/15	15/15	64	11/15	22/15	209/225	1039/225	4	1	4.5	4.5	20	75
2	6/15	15/15	64	6/15	12/15	12/15	12/15	4	1	4.5	4.5	12	67
3	15/15	9/15	64	15/9	30/15	30/15	$\beta_{ed1}:47/15$ $\beta_{ed2}:47/15$	4	2	4.5	4.5	15	92
4	2/15	15/15	64	2/15	4/15	4/15	56/75	4	1	4.5	4.5	17	71
5	15/15	15/15	64	15/15	24/15	30/15	134/15	4	1	2.0	2.0	21	81

9.4 Bluetooth & Wi-Fi Measurement Procedures for SAR

Normal network operating configurations are not suitable for measuring the SAR of 802.11 transmitters in general. Unpredictable fluctuations in network traffic and antenna diversity conditions can introduce undesirable variations in SAR results. The SAR for these devices should be measured using chipset based test mode software to ensure that the results are consistent and reliable.

Chipset based test mode software is hardware dependent and generally varies among manufacturers. The device operating parameters established in a test mode for SAR measurements must be identical to those programmed in production units, including output power levels, amplifier gain settings and other RF performance tuning parameters. The test frequencies should correspond to actual channel frequencies defined for domestic use. SAR for devices with switched diversity should be measured with only one antenna transmitting at a time during each SAR measurement, according to a fixed modulation and data rate. The same data pattern should be used for all measurements.

9.5 Power Drift

To control the output power stability during the SAR test, DASY4 system calculates the power drift by measuring the E-field at the same location at the beginning and at the end of the measurement for each test position. These drift values can be found in section 14 labeled as: (Power Drift [dB]). This ensures that the power drift during one measurement is within 5%.

10 Area Scan Based 1-g SAR

10.1 Requirement of KDB

According to the KDB447498 D01 v05, when the implementation is based the specific polynomial fit algorithm as presented at the 29th Bioelectromagnetics Society meeting (2007) and the estimated 1-gSAR is ≤ 1.2 W/kg, a zoom scan measurement is not required provided it is also not needed for any other purpose; for example, if the peak SAR location required for simultaneous transmission SAR test exclusion can be determined accurately by the SAR system or manually to discriminate between distinctive peaks and scattered noisy SAR distributions from area scans.

There must not be any warning or alert messages due to various measurement concerns identified by the SAR system; for example, noise in measurements, peaks too close to scan boundary, peaks are too sharp, spatial resolution and uncertainty issues etc. The SAR system verification must also demonstrate that the area scan estimated 1-g SAR is within 3% of the zoom scan 1-g SAR (See Annex B). When all the SAR results for each exposure condition in a frequency band and wireless mode are based on estimated 1-g SAR, the 1-g SAR for the highest SAR configuration must be determined by a zoom scan.

10.2 Fast SAR Algorithms

The approach is based on the area scan measurement applying a frequency dependent attenuation parameter. This attenuation parameter was empirically determined by analyzing a large number of phones. The MOTOROLA FAST SAR was developed and validated by the MOTOROLA Research Group in Ft. Lauderdale.

In the initial study, an approximation algorithm based on Linear fit was developed. The accuracy of the algorithm has been demonstrated across a broad frequency range (136-2450 MHz) and for both 1- and 10-g averaged SAR using a sample of 264 SAR measurements from 55 wireless handsets. For the sample size studied, the root-mean-squared errors of the algorithm are 1.2% and 5.8% for 1- and 10-g averaged SAR, respectively. The paper describing the algorithm in detail is expected to be published in August 2004 within the Special Issue of Transactions on MTT.

In the second step, the same research group optimized the fitting algorithm to an Polynomial fit whereby the frequency validity was extended to cover the range 30-6000MHz. Details of this study can be found in the BEMS 2007 Proceedings.

Both algorithms are implemented in DASY software.

11 Conducted Output Power

11.1 Manufacturing tolerance

Table 11.1: GSM Speech

GSM 850			
Channel	Channel 251	Channel 190	Channel 128
Target (dBm)	32.3	32.3	32.3
Tune-up(dBm)	33.3	33.3	33.3
GSM 1900			
Channel	Channel 810	Channel 661	Channel 512
Target (dBm)	29.3	29.3	29.3
Tune-up(dBm)	30.3	30.3	30.3

Table 11.2: GPRS and EGPRS

GSM 850 GPRS (GMSK)				
Channel		251	190	128
1 Txslot	Target (dBm)	32.3	32.3	32.3
	Tune-up(dBm)	33.3	33.3	33.3
2 Txslots	Target (dBm)	29.5	29.5	29.5
	Tune-up(dBm)	30.5	30.5	30.5
3Txslots	Target (dBm)	27.5	27.5	27.5
	Tune-up(dBm)	28.5	28.5	28.5
4 Txslots	Target (dBm)	26.5	26.5	26.5
	Tune-up(dBm)	27.5	27.5	27.5
GSM 850 EGPRS (GMSK)				
Channel		251	190	128
1 Txslot	Target (dBm)	32.3	32.3	32.3
	Tune-up(dBm)	33.3	33.3	33.3
2 Txslots	Target (dBm)	29.5	29.5	29.5
	Tune-up(dBm)	30.5	30.5	30.5
3Txslots	Target (dBm)	27.5	27.5	27.5
	Tune-up(dBm)	28.5	28.5	28.5
4 Txslots	Target (dBm)	26.5	26.5	26.5
	Tune-up(dBm)	27.5	27.5	27.5
GSM 1900 GPRS (GMSK)				
Channel		810	661	512
1 Txslot	Target (dBm)	29.3	29.3	29.3
	Tune-up(dBm)	30.3	30.3	30.3
2 Txslots	Target (dBm)	27	27	27
	Tune-up(dBm)	28	28	28
3Txslots	Target (dBm)	25	25	25
	Tune-up(dBm)	26	26	26
4 Txslots	Target (dBm)	24	24	24
	Tune-up(dBm)	25	25	25

GSM 1900 EGPRS (GMSK)				
Channel		810	661	512
1 Txslot	Target (dBm)	29.3	29.3	29.3
	Tune-up(dBm)	30.3	30.3	30.3
2 Txslots	Target (dBm)	27	27	27
	Tune-up(dBm)	28	28	28
3Txslots	Target (dBm)	25	25	25
	Tune-up(dBm)	26	26	26
4 Txslots	Target (dBm)	24	24	24
	Tune-up(dBm)	25	25	25

Table 11.3: WCDMA

WCDMA 850 CS				
Channel	Channel 4233	Channel 4182	Channel 4132	
Target (dBm)	23	23	23	
Tune-up(dBm)	24	24	24	
HSUPA (sub-test 1~2)				
Channel	Channel 4233	Channel 4182	Channel 4132	
Target (dBm)	20	20	20	
Tune-up(dBm)	21	21	21	
HSUPA (sub-test 3)				
Channel	Channel 4233	Channel 4182	Channel 4132	
Target (dBm)	21	21	21	
Tune-up(dBm)	22	22	22	
HSUPA (sub-test 4)				
Channel	Channel 4233	Channel 4182	Channel 4132	
Target (dBm)	19.5	19.5	19.5	
Tune-up(dBm)	20.5	20.5	20.5	
HSUPA (sub-test 5)				
Channel	Channel 4233	Channel 4182	Channel 4132	
Target (dBm)	22	22	22	
Tune-up(dBm)	23	23	23	
WCDMA 1900 CS				
Channel	Channel 9538	Channel 9400	Channel 9262	
Target (dBm)	22	22	22	
Tune-up(dBm)	23	23	23	
HSUPA (sub-test 1~2)				
Channel	Channel 9538	Channel 9400	Channel 9262	
Target (dBm)	19	19	19	
Tune-up(dBm)	20	20	20	
HSUPA (sub-test 3)				
Channel	Channel 9538	Channel 9400	Channel 9262	
Target (dBm)	20	20	20	

Tune-up(dBm)	21	21	21
HSUPA (sub-test 4)			
Channel	Channel 9538	Channel 9400	Channel 9262
Target (dBm)	18.5	18.5	18.5
Tune-up(dBm)	19.5	19.5	19.5
HSUPA (sub-test 5)			
Channel	Channel 9538	Channel 9400	Channel 9262
Target (dBm)	21	21	21
Tune-up(dBm)	22	22	22

Table 11.4: Bluetooth

Mode	Target (dBm)	Tune-up(dBm)
GFSK	6	7
EDR2M-4_DQPSK ch0	5	6
EDR2M-4_DQPSK ch39	7	8
EDR2M-4_DQPSK ch78	5	6
EDR3M-8DPSK	5	6

Table 11.5: WiFi

Mode	Target (dBm)	Tune-up(dBm)
802.11 b (2.4GHz)	15.5	16.5
802.11g CH1 6-24Mbps	12.5	13.5
802.11g CH1 36-54Mbps	12.5	13.5
802.11g CH6 6-24Mbps	13.5	14.5
802.11g CH6 36-54Mbps	13	14
802.11g CH11 6-24Mbps	12.5	13.5
802.11g CH11 36-54Mbps	12	13
802.11n HT20 CH1 MCS0-4	12	13
802.11n HT20 CH1 MCS5-7	11.5	12.5
802.11n HT20 CH6 MCS0-4	11.5	12.5
802.11n HT20 CH6 MCS5-7	11	12
802.11n HT20 CH11 MCS0-3	10.5	11.5
802.11n HT20 CH1 1MCS4-7	10	11
802.11n HT40 CH1 MCS0-3	9	10
802.11n HT40 CH1 MCS4-7	8	9
802.11n HT40 CH6 MCS0-2	8.5	9.5
802.11n HT40 CH6 MCS3-7	8	9
802.11n HT40 CH11 MCS0-3	8.5	9.5
802.11n HT40 CH1 1MCS4-7	7.5	8.5

11.2 GSM Measurement result

During the process of testing, the EUT was controlled via Agilent Digital Radio Communication tester (E5515C) to ensure the maximum power transmission and proper modulation. This result contains conducted output power for the EUT. In all cases, the measured peak output power should be greater and within 5% than EMI measurement.

Table 11.6: The conducted power measurement results for GSM850/1900

GSM 850MHz	Conducted Power (dBm)		
	Channel 251(848.8MHz)	Channel 190(836.6MHz)	Channel 128(824.2MHz)
	32.83	32.84	32.80
GSM 1900MHz	Conducted Power(dBm)		
	Channel 810(1909.8MHz)	Channel 661(1880MHz)	Channel 512(1850.2MHz)
	29.58	29.55	29.49

Table 11.7: The conducted power measurement results for GPRS and EGPRS

GSM 850 GPRS (GMSK)	Measured Power (dBm)			calculation	Averaged Power (dBm)		
	251	190	128		251	190	128
1 Txslot	32.82	32.82	32.77	-9.03	23.79	23.79	23.74
2 Txslots	29.73	29.70	29.66	-6.02	23.71	23.68	23.64
3Txslots	27.91	27.94	27.91	-4.26	23.65	23.68	23.65
4 Txslots	26.61	26.61	26.57	-3.01	23.60	23.60	23.56
GSM 850 EGPRS (GMSK)	Measured Power (dBm)			calculation	Averaged Power (dBm)		
	251	190	128		251	190	128
1 Txslot	32.82	32.82	32.78	-9.03	23.79	23.79	23.75
2 Txslots	29.73	29.71	29.68	-6.02	23.71	23.69	23.66
3Txslots	27.90	27.95	27.91	-4.26	23.64	23.69	23.65
4 Txslots	26.61	26.61	26.57	-3.01	23.60	23.60	23.56
PCS1900 GPRS (GMSK)	Measured Power (dBm)			calculation	Averaged Power (dBm)		
	810	661	512		810	661	512
1 Txslot	29.56	29.53	29.47	-9.03	20.53	20.50	20.44
2 Txslots	27.35	27.28	27.19	-6.02	21.33	21.26	21.17
3Txslots	25.34	25.27	25.16	-4.26	21.08	21.01	20.90
4 Txslots	24.18	24.12	24.02	-3.01	21.17	21.11	21.01
PCS1900 EGPRS (GMSK)	Measured Power (dBm)			calculation	Averaged Power (dBm)		
	810	661	512		810	661	512
1 Txslot	29.56	29.53	29.48	-9.03	20.53	20.50	20.45
2 Txslots	27.35	27.27	27.19	-6.02	21.33	21.25	21.17
3Txslots	25.32	25.25	25.15	-4.26	21.06	20.99	20.89
4 Txslots	24.19	24.13	24.03	-3.01	21.18	21.12	21.02

NOTES:

1) Division Factors

To average the power, the division factor is as follows:

1TX-slot = 1 transmit time slot out of 8 time slots=> conducted power divided by (8/1) => -9.03dB
 2TX-slots = 2 transmit time slots out of 8 time slots=> conducted power divided by (8/2) => -6.02dB
 3TX-slots = 3 transmit time slots out of 8 time slots=> conducted power divided by (8/3) => -4.26dB
 4TX-slots = 4 transmit time slots out of 8 time slots=> conducted power divided by (8/4) => -3.01dB

According to the conducted power as above, the body measurements are performed with 1Txslots for GSM850 and 2Txslots for PCS1900.

11.3 WCDMA Measurement result

Table 11.8: The conducted Power for WCDMA850/1900

Item	band	FDDV result		
	ARFCN	4233(846.6MHz)	4182(836.4MHz)	4132(826.4MHz)
WCDMA	\	23.63	23.62	23.64
HSUPA	1	20.42	20.41	20.56
	2	20.4	20.39	20.57
	3	21.37	21.37	21.54
	4	19.86	19.86	20.01
	5	22.37	22.36	22.52
Item	band	FDDII result		
	ARFCN	9538(1907.6MHz)	9400(1880MHz)	9262(1852.4MHz)
WCDMA	\	22.65	22.53	22.56
HSUPA	1	19.47	19.39	19.42
	2	19.44	19.41	19.41
	3	20.43	20.39	20.39
	4	18.92	18.84	18.86
	5	21.5	21.46	21.46

11.4 Wi-Fi and BT Measurement result

The output power of BT antenna is as following:

Mode	Conducted Power (dBm)		
	Channel 0 (2402MHz)	Channel 39 (2441MHz)	Channel 78(2480MHz)
GFSK	5.14	6.03	6.13
EDR2M-4_DQPSK	4.23	7.80	5.22
EDR3M-8DPSK	4.28	5.08	5.25

The average conducted power for Wi-Fi is as following:
802.11b (dBm)

Channel\data rate	1Mbps	2Mbps	5.5Mbps	11Mbps
1	16.11	16.09	16.18	16.04
6	15.78	/	15.13	/
11	15.13	/	15.01	/



802.11g (dBm)

Channel\data rate	6Mbps	9Mbps	12Mbps	18Mbps	24Mbps	36Mbps	48Mbps	54Mbps
1	13.12	/	/	/	/	/	/	/
6	13.57	13.55	13.51	13.43	13.32	13.16	13.04	12.96
11	12.82	/	/	/	/	/	/	/

802.11n (dBm) - HT20 (2.4G)

Channel\data rate	MCS0	MCS1	MCS2	MCS3	MCS4	MCS5	MCS6	MCS7
1	12.05	11.94	11.88	11.82	11.62	11.61	11.55	11.28
6	11.66	/	/	/	/	/	/	/
11	10.86	/	/	/	/	/	/	/

802.11n (dBm) - HT40 (2.4G)

Channel\data rate	MCS0	MCS1	MCS2	MCS3	MCS4	MCS5	MCS6	MCS7
3	9.56	9.16	9.01	8.87	8.55	8.52	8.11	7.85
6	8.75	/	/	/	/	/	/	/
9	8.54	/	/	/	/	/	/	/

12 Simultaneous TX SAR Considerations

12.1 Introduction

The following procedures adopted from “FCC SAR Considerations for Cell Phones with Multiple Transmitters” are applicable to handsets with built-in unlicensed transmitters such as 802.11 a/b/g and Bluetooth devices which may simultaneously transmit with the licensed transmitter.

For this device, the BT and Wi-Fi can transmit simultaneous with other transmitters.

12.2 Transmit Antenna Separation Distances

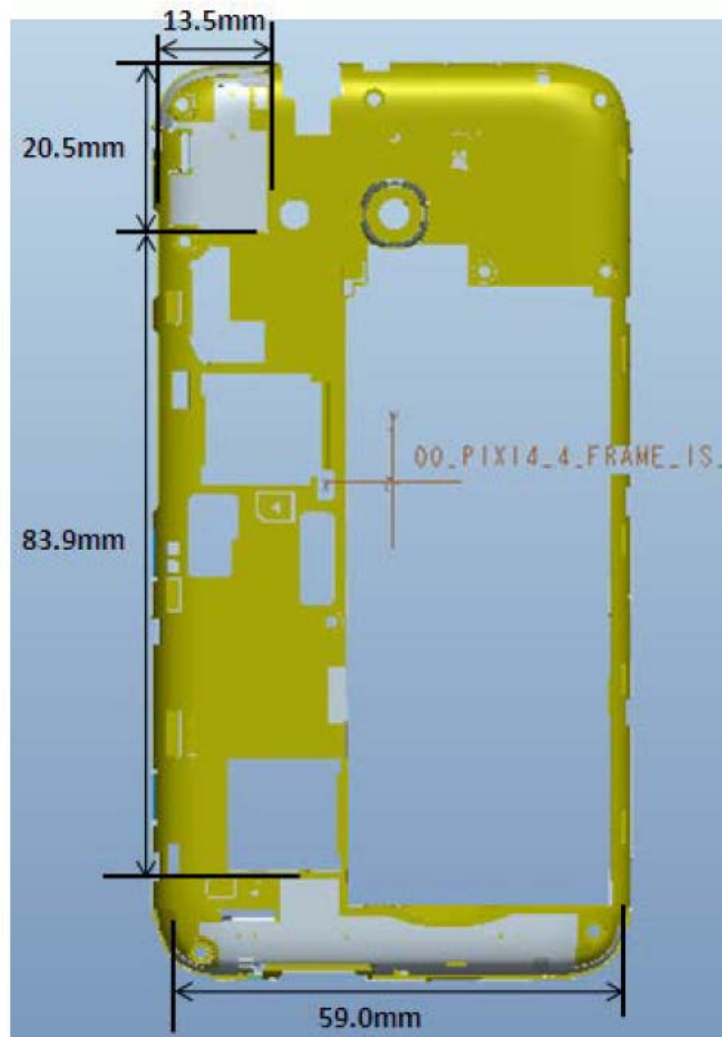

Picture 12.1 Antenna Locations

12.3 SAR Measurement Positions

According to the KDB941225 D06 Hot Spot SAR v01, the edges with less than 2.5 cm distance to the antennas need to be tested for SAR.

SAR measurement positions						
Mode	Front	Rear	Left edge	Right edge	Top edge	Bottom edge
Main antenna	Yes	Yes	Yes	Yes	No	Yes
WLAN	Yes	Yes	No	Yes	Yes	No

12.4 Standalone SAR Test Exclusion Considerations

Standalone 1-g head or body SAR evaluation by measurement or numerical simulation is not required when the corresponding SAR Exclusion Threshold condition, listed below, is satisfied. The 1-g SAR test exclusion threshold for 100 MHz to 6 GHz at test separation distances ≤ 50 mm are determined by:

$[(\text{max. power of channel, including tune-up tolerance, mW}) / (\text{min. test separation distance, mm})] \cdot [\sqrt{f(\text{GHz})}] \leq 3.0$ for 1-g SAR, where

- $f(\text{GHz})$ is the RF channel transmit frequency in GHz
- Power and distance are rounded to the nearest mW and mm before calculation
- The result is rounded to one decimal place for comparison

Table 12.1: Standalone SAR test exclusion considerations

Band/Mode	F(GHz)	Position	SAR test exclusion threshold(mW)	RF output power		SAR test exclusion
				dBm	mW	
Bluetooth	2.441	Head	9.60	7	5.01	Yes
		Body	19.20	7	5.01	Yes
2.4GHz WLAN 802.11 b	2.45	Head	9.58	16.5	44.67	No
		Body	19.17	16.5	44.67	No

13 Evaluation of Simultaneous

Table 13.1: The sum of reported SAR values for main antenna and WiFi

	Position	Main antenna	WiFi	Sum
Highest reported SAR value for Head	Left hand, Touch cheek	0.97	0.20	1.17
Highest reported SAR value for Body	Rear	1.01	0.10	1.11

Table 13.2: The sum of reported SAR values for main antenna and Bluetooth

	Position	Main antenna	BT*	Sum
Highest reported SAR value for Head	Left hand, Touch cheek	0.97	0.29	1.26
Highest reported SAR value for Body	Rear	1.01	0.15	1.16

BT* - Estimated SAR for Bluetooth (see the table 13.3)

Table 13.3: Estimated SAR for Bluetooth

Position	F (GHz)	Distance (mm)	Upper limit of power *		Estimated _{1g} (W/kg)
			dBm	mW	
Head	2.441	5	7	5.01	0.29
Body	2.441	10	7	5.01	0.15

* - Maximum possible output power declared by manufacturer

When standalone SAR test exclusion applies to an antenna that transmits simultaneously with other antennas, the standalone SAR must be estimated according to following to determine simultaneous transmission SAR test exclusion:

$(\text{max. power of channel, including tune-up tolerance, mW}) / (\text{min. test separation distance, mm}) \cdot [\sqrt{f(\text{GHz})} / x] \text{ W/kg}$ for test separation distances $\leq 50 \text{ mm}$;

where $x = 7.5$ for 1-g SAR.

When the minimum test separation distance is $< 5 \text{ mm}$, a distance of 5 mm is applied to determine SAR test exclusion

Conclusion:

According to the above tables, the sum of reported SAR values is $< 1.6 \text{ W/kg}$. So the simultaneous transmission SAR with volume scans is not required.

14 SAR Test Result

It is determined by user manual for the distance between the EUT and the phantom bottom.

The distance is 10mm and just applied to the condition of body worn accessory.

It is performed for all SAR measurements with area scan based 1-g SAR estimation (Fast SAR). A zoom scan measurement is added when the estimated 1-gSAR is the highest measured SAR in each exposure configuration, wireless mode and frequency band combination or >1.2W/kg.

The calculated SAR is obtained by the following formula:

$$\text{Reported SAR} = \text{Measured SAR} \times 10^{(P_{\text{Target}} - P_{\text{Measured}}) / 10}$$

Where P_{Target} is the power of manufacturing upper limit;

P_{Measured} is the measured power in chapter 11.

Table 14.1: Duty Cycle

Mode	Duty Cycle
Speech for GSM850/1900	1:8.3
GPRS&EGPRS for GSM850	1:8.3
GPRS&EGPRS for PCS1900	1:4
WCDMA850/1900	1:1

14.1 The evaluation of multi-batteries

We'll perform the head measurement in all bands with the primary battery depending on the evaluation of multi-batteries and retest on highest value point with other batteries. Then, repeat the measurement in the Body test.

Table 14.1-1: The evaluation of multi-batteries for Head Test

Frequency		Mode/Band	Side	Test Position	Battery Type	SAR(1g)	Power Drift(dB)
MHz	Ch.					(W/kg)	
848.8	251	GSM850	Right	Touch	CAB1500040C1	0.652	0.03
848.8	251	GSM850	Right	Touch	CAB1500042C7	0.693	-0.15

Note: According to the values in the above table, the battery, CAB1500042C7, is the primary battery. We'll perform the head measurement with this battery and retest on highest value point with others.

Table 14.1-2: The evaluation of multi-batteries for Body Test

Frequency		Mode/Band	Test Position	Spacing (mm)	Battery Type	SAR(1g)	Power Drift(dB)
MHz	Ch.					(W/kg)	
836.6	190	GSM850	Rear	10	CAB1500040C1	0.674	0.09
836.6	190	GSM850	Rear	10	CAB1500042C7	0.681	0.04

Note: According to the values in the above table, the battery, CAB1500042C7, is the primary battery. We'll perform the Body measurement with this battery and retest on highest value point with others.

14.2 SAR results for Fast SAR

Table 14.2-1: SAR Values (GSM 850 MHz Band - Head)

Frequency		Side	Test Position	Figure No.	Conducted Power (dBm)	Max. tune-up Power (dBm)	Measured SAR(10g) (W/kg)	Reported SAR(10g) (W/kg)	Measured SAR(1g) (W/kg)	Reported SAR(1g)(W/kg)	Power Drift (dB)	
MHz	Ch.											
		Ambient Temperature: 22.5°C Liquid Temperature: 22.0°C										
848.8	251	Left	Touch	/	32.83	33.3	0.543	0.60	0.801	0.89	-0.05	
836.6	190	Left	Touch	Fig.1	32.84	33.3	0.657	0.73	0.876	0.97	-0.17	
824.2	128	Left	Touch	/	32.80	33.3	0.519	0.58	0.761	0.85	-0.14	
836.6	190	Left	Tilt	/	32.84	33.3	0.28	0.31	0.404	0.45	-0.18	
836.6	190	Right	Touch	/	32.84	33.3	0.477	0.53	0.702	0.78	0.06	
836.6	190	Right	Tilt	/	32.84	33.3	0.245	0.27	0.357	0.40	-0.05	

Table 14.2-2: SAR Values (GSM 850 MHz Band-Body)

Frequency		Mode (number of timeslots)	Test Position	Figure No.	Conducted Power (dBm)	Max. tune-up Power (dBm)	Measured SAR(10g) (W/kg)	Reported SAR(10g) (W/kg)	Measured SAR(1g) (W/kg)	Reported SAR(1g) (W/kg)	Power Drift (dB)	
MHz	Ch.											
		Ambient Temperature: 22.5°C Liquid Temperature: 22.0°C										
848.8	251	GPRS (1)	Front	/	32.82	33.3	0.455	0.51	0.655	0.73	-0.14	
836.6	190	GPRS (1)	Front	Fig.2	32.82	33.3	0.511	0.57	0.739	0.83	-0.04	
824.2	128	GPRS (1)	Front	/	32.77	33.3	0.503	0.57	0.723	0.82	-0.01	
836.6	190	GPRS (1)	Rear	/	32.82	33.3	0.5	0.56	0.712	0.79	-0.05	
836.6	190	GPRS (1)	Left	/	32.82	33.3	0.286	0.32	0.42	0.47	-0.12	
836.6	190	GPRS (1)	Right	/	32.82	33.3	0.287	0.32	0.423	0.47	-0.02	
836.6	190	GPRS (1)	Bottom	/	32.82	33.3	0.0864	0.10	0.143	0.16	-0.01	
836.6	190	EGPRS (1)	Front	/	32.82	33.3	0.497	0.55	0.711	0.79	-0.04	

Note1: The distance between the EUT and the phantom bottom is 10mm.

Table 14.2-3: SAR Values (GSM1900 MHz Band - Head)

Frequency		Side	Test Position	Figure No.	Conducted Power (dBm)	Max. tune-up Power (dBm)	Measured SAR(10g) (W/kg)	Reported SAR(10g) (W/kg)	Measured SAR(1g) (W/kg)	Reported SAR(1g)(W/kg)	Power Drift (dB)	
MHz	Ch.											
		Ambient Temperature: 22.5°C Liquid Temperature: 22.0°C										
1909.8	810	Left	Touch	Fig.3	29.58	30.3	0.232	0.27	0.398	0.47	-0.12	
1880	661	Left	Touch	/	29.55	30.3	0.188	0.22	0.318	0.38	-0.11	
1850.2	512	Left	Touch	/	29.49	30.3	0.198	0.24	0.334	0.40	0.05	
1880	661	Left	Tilt	/	29.55	30.3	0.0927	0.11	0.154	0.18	-0.08	
1880	661	Right	Touch	/	29.55	30.3	0.163	0.19	0.273	0.32	0.07	
1880	661	Right	Tilt	/	29.55	30.3	0.107	0.13	0.189	0.22	0.15	

Table 14.2-4: SAR Values (GSM 1900 MHz Band-Body)

Frequency		Mode (number of timeslots)	Test Position	Figure No.	Conducted Power (dBm)	Max. tune-up Power (dBm)	Measured SAR(10g) (W/kg)	Reported SAR(10g) (W/kg)	Measured SAR(1g) (W/kg)	Reported SAR(1g) (W/kg)	Power Drift (dB)	
MHz	Ch.											
		Ambient Temperature: 22.5 °C						Liquid Temperature: 22.0 °C				
1880	661	GPRS (2)	Front	/	27.28	28	0.238	0.28	0.392	0.46	-0.07	
1909.8	810	GPRS (2)	Rear	/	27.35	28	0.363	0.42	0.646	0.75	0.01	
1880	661	GPRS (2)	Rear	/	27.28	28	0.316	0.37	0.556	0.66	-0.10	
1850.2	512	GPRS (2)	Rear	Fig.4	27.19	28	0.395	0.48	0.674	0.81	-0.02	
1909.8	810	GPRS (2)	Left	/	27.28	28	0.0556	0.07	0.0969	0.11	-0.10	
1880	661	GPRS (2)	Right	/	27.28	28	0.0979	0.12	0.174	0.21	-0.13	
1880	661	GPRS (2)	Bottom	/	27.28	28	0.229	0.27	0.421	0.50	-0.01	
1850.2	512	EGPRS (2)	Rear	/	27.28	28	0.378	0.45	0.635	0.75	-0.02	

Note1: The distance between the EUT and the phantom bottom is 10mm.

Table 14.2-5: SAR Values (WCDMA 850 MHz Band - Head)

Frequency		Side	Test Position	Figure No.	Conducted Power (dBm)	Max. tune-up Power (dBm)	Measured SAR(10g) (W/kg)	Reported SAR(10g) (W/kg)	Measured SAR(1g) (W/kg)	Reported SAR(1g) (W/kg)	Power Drift (dB)	
MHz	Ch.											
		Ambient Temperature: 22.5 °C						Liquid Temperature: 22.0 °C				
846.6	4233	Left	Touch	/	23.63	24	0.507	0.55	0.746	0.81	-0.07	
836.4	4182	Left	Touch	Fig.5	23.62	24	0.659	0.72	0.865	0.94	-0.12	
826.4	4132	Left	Touch	/	23.64	24	0.471	0.51	0.692	0.75	-0.03	
836.4	4182	Left	Tilt	/	23.62	24	0.273	0.30	0.396	0.43	-0.18	
846.6	4233	Right	Touch	/	23.63	24	0.436	0.47	0.634	0.69	0.03	
836.4	4182	Right	Touch	/	23.62	24	0.532	0.58	0.772	0.84	-0.07	
826.4	4132	Right	Touch	/	23.64	24	0.425	0.46	0.617	0.67	0.16	
836.4	4182	Right	Tilt	/	23.62	24	0.297	0.32	0.43	0.47	0.03	

Table 14.2-6: SAR Values (WCDMA 850 MHz Band-Body)

Frequency		Test Position	Figure No.	Conducted Power (dBm)	Max. tune-up Power (dBm)	Measured SAR(10g) (W/kg)	Reported SAR(10g) (W/kg)	Measured SAR(1g) (W/kg)	Reported SAR(1g) (W/kg)	Power Drift (dB)		
MHz	Ch.											
		Ambient Temperature: 22.5 °C						Liquid Temperature: 22.0 °C				
846.6	4233	Front	/	23.63	24	0.588	0.64	0.843	0.92	-0.01		
836.4	4182	Front	/	23.62	24	0.618	0.67	0.894	0.98	0.02		
826.4	4132	Front	/	23.64	24	0.484	0.53	0.697	0.76	-0.12		
846.6	4233	Rear	/	23.63	24	0.592	0.64	0.853	0.93	0.04		
836.4	4182	Rear	Fig.6	23.62	24	0.689	0.75	0.927	1.01	-0.04		
826.4	4132	Rear	/	23.64	24	0.534	0.58	0.77	0.84	-0.02		
836.4	4182	Left	/	23.62	24	0.354	0.39	0.518	0.57	-0.08		
836.4	4182	Right	/	23.62	24	0.352	0.38	0.52	0.57	-0.05		
836.4	4182	Bottom	/	23.62	24	0.0986	0.11	0.163	0.18	-0.07		

Note1: The distance between the EUT and the phantom bottom is 10mm.

Table 14.2-7: SAR Values (WCDMA1900 MHz Band - Head)

Ambient Temperature: 22.5°C Liquid Temperature: 22.0°C											
Frequency		Side	Test Position	Figure No.	Conducted Power (dBm)	Max. tune-up Power (dBm)	Measured SAR(10g) (W/kg)	Reported SAR(10g) (W/kg)	Measured SAR(1g) (W/kg)	Reported SAR(1g) (W/kg)	Power Drift (dB)
MHz	Ch.										
1907.6	9538	Left	Touch	/	22.65	23	0.242	0.26	0.408	0.44	-0.08
1880	9400	Left	Touch	Fig.7	22.53	23	0.296	0.33	0.491	0.55	-0.11
1852.4	9262	Left	Touch	/	22.56	23	0.237	0.26	0.398	0.44	0.04
1880	9400	Left	Tilt	/	22.53	23	0.115	0.13	0.191	0.21	0.06
1880	9400	Right	Touch	/	22.53	23	0.205	0.23	0.348	0.39	0.10
1880	9400	Right	Tilt	/	22.53	23	0.133	0.15	0.236	0.26	-0.07

Table 14.2-8: SAR Values (WCDMA1900 MHz Band-Body)

Ambient Temperature: 22.5°C Liquid Temperature: 22.0°C											
Frequency		Test Position	Figure No.	Conducted Power (dBm)	Max. tune-up Power (dBm)	Measured SAR(10g) (W/kg)	Reported SAR(10g) (W/kg)	Measured SAR(1g) (W/kg)	Reported SAR(1g) (W/kg)	Power Drift (dB)	
MHz	Ch.										
1880	9400	Front	/	22.53	23	0.25	0.28	0.428	0.48	-0.16	
1907.6	9538	Rear	/	22.65	23	0.409	0.44	0.721	0.78	-0.01	
1880	9400	Rear	Fig.8	22.53	23	0.456	0.51	0.779	0.87	-0.01	
1852.4	9262	Rear	/	22.56	23	0.422	0.47	0.735	0.81	0.02	
1880	9400	Left	/	22.53	23	0.0899	0.10	0.158	0.18	0.19	
1880	9400	Right	/	22.53	23	0.143	0.16	0.253	0.28	0.05	
1880	9400	Bottom	/	22.53	23	0.253	0.28	0.466	0.52	0.02	

Note1: The distance between the EUT and the phantom bottom is 10mm.

Table 14.2-9: SAR Values (GSM850 MHz Band - Head)– other batteries

Ambient Temperature: 22.5°C Liquid Temperature: 22.0°C											
Frequency		Side	Test Position	Battery	Conducted Power (dBm)	Max. tune-up Power (dBm)	Measured SAR(10g) (W/kg)	Reported SAR(10g) (W/kg)	Measured SAR(1g) (W/kg)	Reported SAR(1g) (W/kg)	Power Drift (dB)
MHz	Ch.										
836.6	190	Left	Touch	1	32.84	33.3	0.645	0.72	0.846	0.94	0.05

Note1: The battery 1 is CAB1500040C1

Table 14.2-10: SAR Values (WCDMA850 MHz Band-Body)– other batteries

Ambient Temperature: 22.5°C Liquid Temperature: 22.0°C											
Frequency		Test Position	Battery	Conducted Power (dBm)	Max. tune-up Power (dBm)	Measured SAR(10g) (W/kg)	Reported SAR(10g) (W/kg)	Measured SAR(1g) (W/kg)	Reported SAR(1g) (W/kg)	Power Drift (dB)	
MHz	Ch.										
836.4	4182	Rear	1	23.62	24	0.593	0.65	0.875	0.96	-0.04	

Note1: The distance between the EUT and the phantom bottom is 10mm.

Note2: The battery 1 is CAB1500040C1

14.3 SAR results for Standard procedure

There is zoom scan measurement to be added for the highest measured SAR in each exposure configuration/band.

Table 14.3-1: SAR Values (GSM 850 MHz Band - Head)

Frequency		Side	Test Position	Figure No.	Conducted Power (dBm)	Max. tune-up Power (dBm)	Measured SAR(10g) (W/kg)	Reported SAR(10g) (W/kg)	Measured SAR(1g) (W/kg)	Reported SAR(1g) (W/kg)	Power Drift (dB)
MHz	Ch.										
836.6	190	Left	Touch	Fig.1	32.84	33.3	0.657	0.73	0.876	0.97	-0.17

Table 14.3-2: SAR Values (GSM 850 MHz Band-Body)

Frequency		Mode (number of timeslots)	Test Position	Figure No.	Conducted Power (dBm)	Max. tune-up Power (dBm)	Measured SAR(10g) (W/kg)	Reported SAR(10g) (W/kg)	Measured SAR(1g) (W/kg)	Reported SAR(1g) (W/kg)	Power Drift (dB)
MHz	Ch.										
836.6	190	GPRS (1)	Front	Fig.2	32.82	33.3	0.511	0.57	0.739	0.83	-0.04

Note1: The distance between the EUT and the phantom bottom is 10mm.

Table 14.3-3: SAR Values (GSM1900 MHz Band - Head)

Frequency		Side	Test Position	Figure No.	Conducted Power (dBm)	Max. tune-up Power (dBm)	Measured SAR(10g) (W/kg)	Reported SAR(10g) (W/kg)	Measured SAR(1g) (W/kg)	Reported SAR(1g) (W/kg)	Power Drift (dB)
MHz	Ch.										
1909.8	810	Left	Touch	Fig.3	29.58	30.3	0.232	0.27	0.398	0.47	-0.12

Table 14.3-4: SAR Values (GSM 1900 MHz Band-Body)

Frequency		Mode (number of timeslots)	Test Position	Figure No.	Conducted Power (dBm)	Max. tune-up Power (dBm)	Measured SAR(10g) (W/kg)	Reported SAR(10g) (W/kg)	Measured SAR(1g) (W/kg)	Reported SAR(1g) (W/kg)	Power Drift (dB)
MHz	Ch.										
1850.2	512	GPRS (2)	Rear	Fig.4	27.19	28	0.395	0.48	0.674	0.81	-0.02

Note1: The distance between the EUT and the phantom bottom is 10mm.

Table 14.3-5: SAR Values (WCDMA 850 MHz Band - Head)

Frequency		Side	Test Position	Figure No.	Conducted Power (dBm)	Max. tune-up Power (dBm)	Measured SAR(10g) (W/kg)	Reported SAR(10g) (W/kg)	Measured SAR(1g) (W/kg)	Reported SAR(1g) (W/kg)	Power Drift (dB)
MHz	Ch.										
836.4	4182	Left	Touch	Fig.5	23.62	24	0.659	0.72	0.865	0.94	-0.12

Table 14.3-6: SAR Values (WCDMA 850 MHz Band-Body)

Frequency		Test Position	Figure No.	Conducted Power (dBm)	Max. tune-up Power (dBm)	Measured SAR(10g) (W/kg)	Reported SAR(10g) (W/kg)	Measured SAR(1g) (W/kg)	Reported SAR(1g)(W/kg)	Power Drift (dB)	
MHz	Ch.										
		Ambient Temperature: 22.5 °C				Liquid Temperature: 22.0 °C					
836.4	4182	Rear	Fig.6	23.62	24	0.689	0.75	0.927	1.01	-0.04	

Note1: The distance between the EUT and the phantom bottom is 10mm.

Table 14.3-7: SAR Values (WCDMA1900 MHz Band - Head)

Frequency		Side	Test Position	Figure No.	Conducted Power (dBm)	Max. tune-up Power (dBm)	Measured SAR(10g) (W/kg)	Reported SAR(10g) (W/kg)	Measured SAR(1g) (W/kg)	Reported SAR(1g)(W/kg)	Power Drift (dB)
MHz	Ch.										
		Ambient Temperature: 22.5 °C				Liquid Temperature: 22.0 °C					
1880	9400	Left	Touch	Fig.7	22.53	23	0.296	0.33	0.491	0.55	-0.11

Table 14.3-8: SAR Values (WCDMA1900 MHz Band-Body)

Frequency		Test Position	Figure No.	Conducted Power (dBm)	Max. tune-up Power (dBm)	Measured SAR(10g) (W/kg)	Reported SAR(10g) (W/kg)	Measured SAR(1g) (W/kg)	Reported SAR(1g)(W/kg)	Power Drift (dB)	
MHz	Ch.										
		Ambient Temperature: 22.5 °C				Liquid Temperature: 22.0 °C					
1880	9400	Rear	Fig.8	22.53	23	0.456	0.51	0.779	0.87	-0.01	

Note1: The distance between the EUT and the phantom bottom is 10mm.

14.4 WLAN Evaluation

According to the KDB248227 D01, SAR is measured for 2.4GHz 802.11b DSSS using the initial test position procedure.

Head Evaluation

Table 14.4-1: SAR Values (WLAN - Head) – 802.11b 5.5Mbps (Fast SAR)

Frequency		Side	Test Position	Figure No.	Conducted Power (dBm)	Max. tune-up Power (dBm)	Measured SAR(10g) (W/kg)	Reported SAR(10g) (W/kg)	Measured SAR(1g) (W/kg)	Reported SAR(1g) (W/kg)	Power Drift (dB)
MHz	Ch.										
2412	1	Left	Touch	/	16.18	16.5	0.0862	0.09	0.164	0.18	0.12
2412	1	Left	Tilt	/	16.18	16.5	0.0529	0.06	0.111	0.12	-0.12
2412	1	Right	Touch	/	16.18	16.5	0.0459	0.05	0.0874	0.09	0.11
2412	1	Right	Tilt	/	16.18	16.5	0.0336	0.04	0.0668	0.07	0.10

As shown above table, the initial test position for head is “Left Touch”. So the head SAR of WLAN is presented as below:

Table 14.4-2: SAR Values (WLAN - Head) – 802.11b 5.5Mbps (Full SAR)

Frequency		Side	Test Position	Figure No.	Conducted Power (dBm)	Max. tune-up Power (dBm)	Measured SAR(10g) (W/kg)	Reported SAR(10g) (W/kg)	Measured SAR(1g) (W/kg)	Reported SAR(1g) (W/kg)	Power Drift (dB)
MHz	Ch.										
2412	1	Left	Touch	Fig.9	16.18	16.5	0.0904	0.10	0.189	0.20	0.12

According to the KDB248227 D01, The reported SAR must be scaled to 100% transmission duty factor to determine compliance at the maximum tune-up tolerance limit. The scaled reported SAR is presented as below:

Table 14.4-3: SAR Values (WLAN - Head) – 802.11b 5.5Mbps (Scaled Reported SAR)

Frequency		Side	Test Position	Actual duty factor	maximum duty factor	Reported SAR (1g) (W/kg)	Scaled reported SAR (1g) (W/kg)
MHz	Ch.						
2412	1	Left	Touch	98%	100%	0.20	0.20

SAR is not required for OFDM because the 802.11b adjusted SAR \leq 1.2 W/kg.

Body Evaluation

Table 14.4-4: SAR Values (WLAN - Body) – 802.11b 5.5Mbps (Fast SAR)

Frequency		Test Position	Figure No.	Conducted Power (dBm)	Max. tune-up Power (dBm)	Ambient Temperature: 22.0 °C		Liquid Temperature: 21.6 °C		Power Drift (dB)
MHz	Ch.					Measured SAR(10g) (W/kg)	Reported SAR(10g) (W/kg)	Measured SAR(1g) (W/kg)	Reported SAR(1g) (W/kg)	
2412	1	Front	/	16.18	16.5	0.0239	0.03	0.0468	0.05	0.12
2412	1	Rear	/	16.18	16.5	0.0422	0.05	0.0891	0.10	0.11
2412	1	Right	/	16.18	16.5	0.00613	0.01	0.0104	0.01	-0.14
2412	1	Top	/	16.18	16.5	0.0127	0.01	0.0233	0.03	-0.05

As shown above table, the initial test position for body is “Rear”. So the body SAR of WLAN is presented as below:

Table 14.4-5: SAR Values (WLAN - Body) – 802.11b 5.5Mbps (Full SAR)

Frequency		Test Position	Figure No.	Conducted Power (dBm)	Max. tune-up Power (dBm)	Ambient Temperature: 22.5 °C		Liquid Temperature: 22.0 °C		Power Drift (dB)
MHz	Ch.					Measured SAR(10g) (W/kg)	Reported SAR(10g) (W/kg)	Measured SAR(1g) (W/kg)	Reported SAR(1g) (W/kg)	
2412	1	Rear	Fig.10	16.18	16.5	0.0408	0.04	0.091	0.10	0.11

According to the KDB248227 D01, The reported SAR must be scaled to 100% transmission duty factor to determine compliance at the maximum tune-up tolerance limit. The scaled reported SAR is presented as below.

Table 14.4-6: SAR Values (WLAN - Body) – 802.11b 5.5Mbps (Scaled Reported SAR)

Frequency		Test Position	Actual duty factor	maximum duty factor	Ambient Temperature: 22.5 °C		Liquid Temperature: 22.0 °C	
MHz	Ch.				Reported SAR (1g) (W/kg)	Scaled reported SAR (1g) (W/kg)		
2412	1	Rear	98%	100%	0.10	0.10		

SAR is not required for OFDM because the 802.11b adjusted SAR \leq 1.2 W/kg.

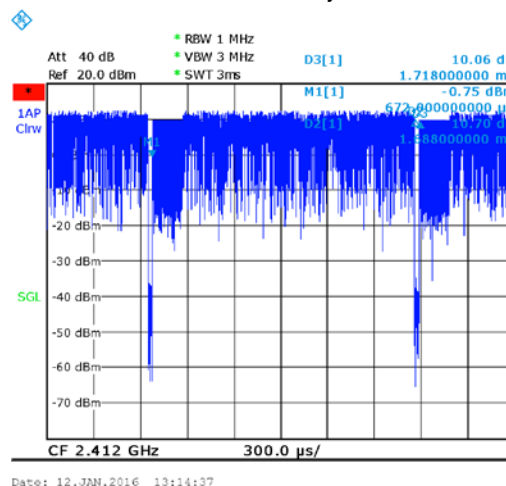

Picture 14.1 The plot of duty factor for WLAN-2.4G

15 SAR Measurement Variability

SAR measurement variability must be assessed for each frequency band, which is determined by the SAR probe calibration point and tissue-equivalent medium used for the device measurements. When both head and body tissue-equivalent media are required for SAR measurements in a frequency band, the variability measurement procedures should be applied to the tissue medium with the highest measured SAR, using the highest measured SAR configuration for that tissue-equivalent medium.

The following procedures are applied to determine if repeated measurements are required.

- 1) Repeated measurement is not required when the original highest measured SAR is < 0.80 W/kg; steps 2) through 4) do not apply.
- 2) When the original highest measured SAR is ≥ 0.80 W/kg, repeat that measurement once.
- 3) Perform a second repeated measurement only if the ratio of largest to smallest SAR for the original and first repeated measurements is > 1.20 or when the original or repeated measurement is ≥ 1.45 W/kg ($\sim 10\%$ from the 1-g SAR limit).
- 4) Perform a third repeated measurement only if the original, first or second repeated measurement is ≥ 1.5 W/kg and the ratio of largest to smallest SAR for the original, first and second repeated measurements is > 1.20 .

Table 15.1: SAR Measurement Variability for Head GSM 850 (1g)

Frequency		Side	Test Position	Original SAR (W/kg)	First Repeated SAR (W/kg)	The Ratio	Second Repeated SAR (W/kg)
MHz	Ch.						
836.6	190	Left	Touch	0.876	0.869	1.01	/

Table 15.2: SAR Measurement Variability for Head WCDMA 850 (1g)

Frequency		Side	Test Position	Original SAR (W/kg)	First Repeated SAR (W/kg)	The Ratio	Second Repeated SAR (W/kg)
MHz	Ch.						
836.4	4182	Left	Touch	0.865	0.869	1.00	/

Table 15.3: SAR Measurement Variability for Body WCDMA 850 (1g)

Frequency		Test Position	Spacing (mm)	Original SAR (W/kg)	First Repeated SAR (W/kg)	The Ratio	Second Repeated SAR (W/kg)
MHz	Ch.						
836.4	4182	Rear	10	0.927	0.924	1.00	/