

TC52x/TC57x/ TC52ax Suporte de Mão para Acionamento

Guia de Instalação



MN-004211-01PTBR - 06/21

Zebra Technologies | 3 Overlook Point | Lincolnshire, IL 60069 EUA
www.zebra.com/br/pt

ZEBRA e a cabeça estilizada da Zebra são marcas comerciais da Zebra Technologies Corp. registradas em várias jurisdições ao redor do mundo. Todas as demais marcas comerciais são de propriedade de seus respectivos proprietários. © 2021 Zebra Technologies Corp. e/ou suas afiliadas. Todos os direitos reservados.

Recursos

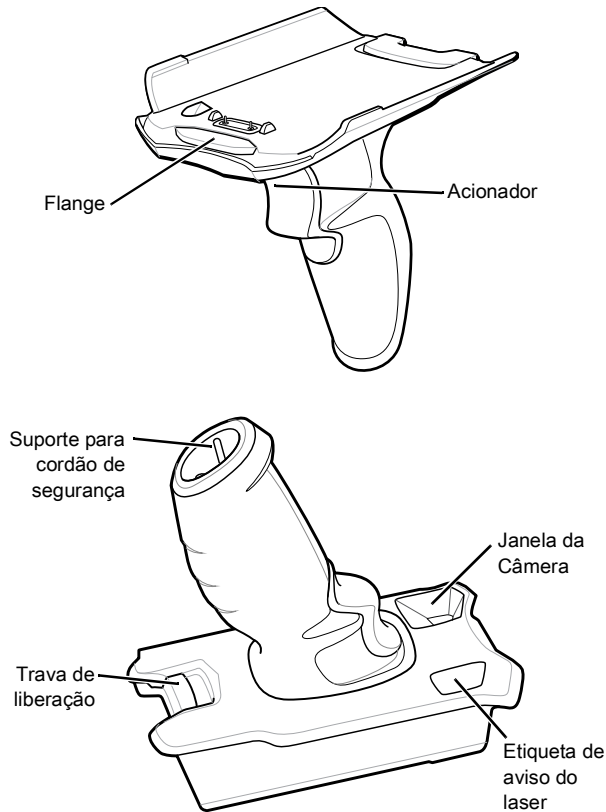

Instalação inicial necessária



NOTA: Se a alça de mão estiver instalada, remova-a antes de instalar a capa robusta.

1

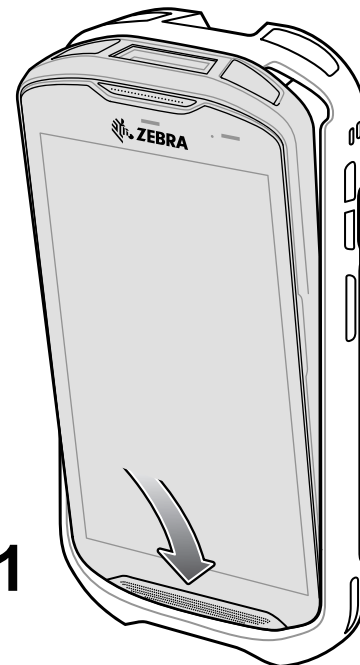

2



3

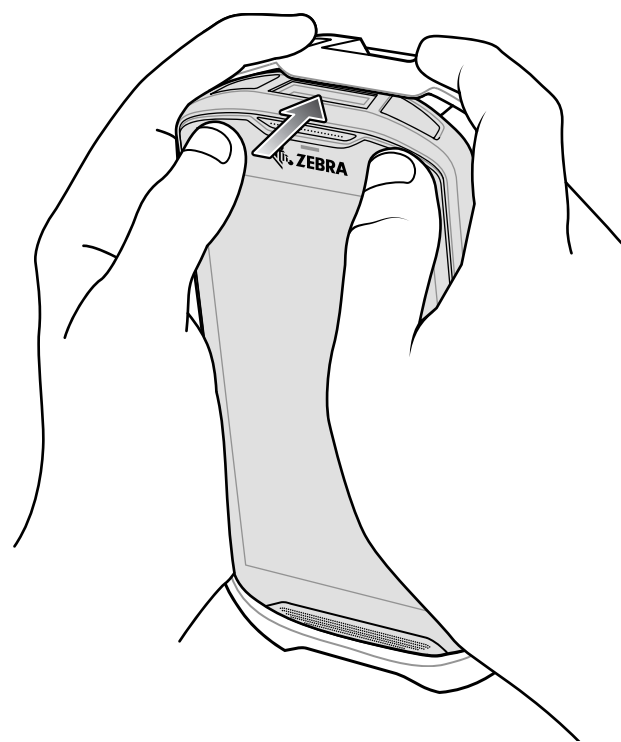

Instalação do dispositivo

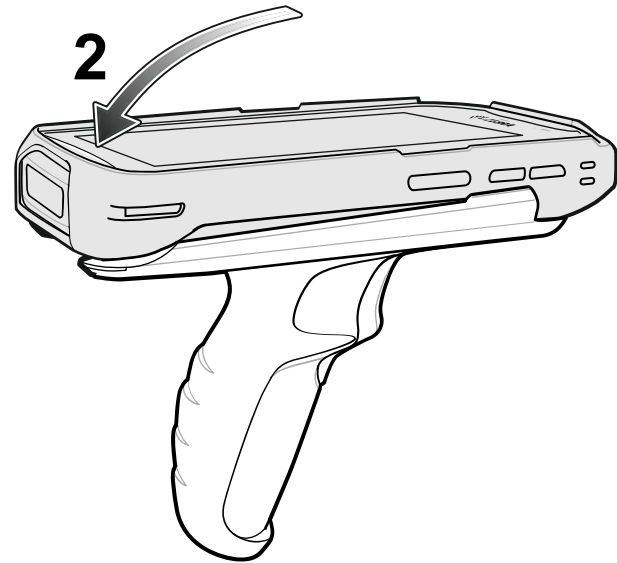
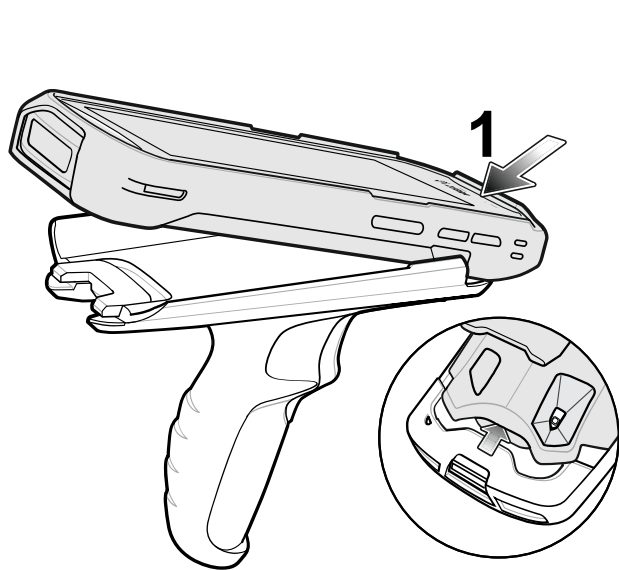

Carregamento



NOTA: Remova a proteção do cabo antes de instalá-lo no dispositivo.

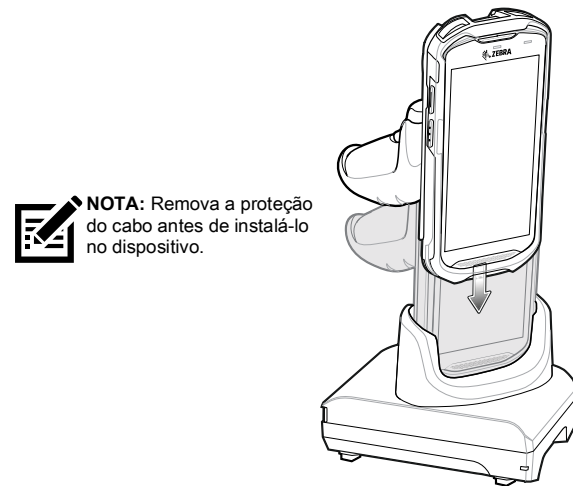

NOTA: Remova a proteção do cabo antes de instalá-lo no dispositivo.

Instalação do cordão de segurança opcional

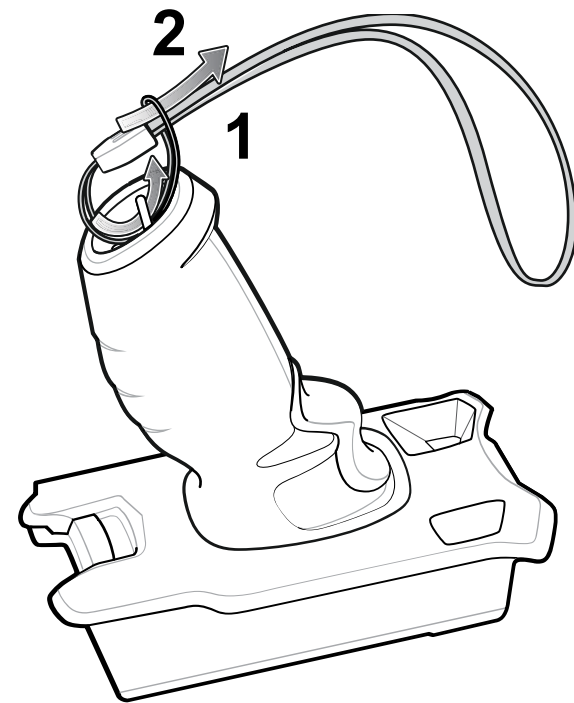

Remoção

