



MUFU

More Unique For You

V10S
Moto Cam
User Manual

Thank you for purchase MUFU moto cam. This product is specifically designed to record real time video when riding a scooter or motorcycle. The content in this document is for informational purpose only and is subject to change without prior notice. We have made every effort to ensure that this User Guide is accurate and complete, however, no liability is assumed for any errors or omissions.

The manufacturer reserves the right to change the technical specifications or accessories without prior notice.

Notice

1. Please peel off the protective film from the camera lens before use.
2. Do not touch the lens with your fingers. Finger grease may be left on the lens, resulting in unclear videos or pictures. Inspect and clean the lens with a soft, non-abrasive cloth regularly.
3. Please charge the unit to full before first use using the provided USB Type-C cable or optional charge station. Please do not use another brand of charging cable to avoid a potential equipment malfunction. The red LED on the camera will illuminate when charging, and will turn off upon reaching full charge.
4. If the unit will not be used for an extended period of time, please charge at least once every 6 months to maintain the battery's health and avoid low-voltage related damage.
5. Please download MUFU MoTo app from iOS app store or Google Play Store before use. The Wi-Fi password is **12345678**.
6. By default, Wi-Fi is ON for 3 minutes when the camera is powered on. If it doesn't connect to the MUFU MoTo app within 3 minutes, the camera will disable Wi-Fi automatically to save power. To turn on again Wi-Fi, simply power the camera OFF then ON again.

NOTE: An active Wi-Fi connection will affect total recording time.

7. Recommend to use microSD card V30 or higher and capacity 16GB or higher (up to 128GB).
8. Format microSD card regularly and synchronize date/time. (Recommended: Once per month.)
9. **In a high humidity environment or when travelling between areas with**

a large temperature difference, light moisture or fog may appear on the lens. This is normal. If this happens, remove the microSD card, and remain the microSD card slot cover opening, let the microSD card slot face up for several hours until the internal moisture or fog evaporates, and then reinsert the card and resume use.

10. Due to local laws and for your own safety, DO NOT operate the camera or MUFU MoTo app while driving or riding.
11. Use the MUFU MoTo app to synchronize your date and time before first use.
12. This product is intended only for non-commercial use, within the maximum limits permitted by law. We take no responsibility for any losses as a result of use of this product.
13. The camera may get warm during use; this is normal.
14. Improper use or operation of the camera may result in damage to the camera or its accessories and will void the warranty.

Prohibition of co-location

This device and its antenna(s) must not be co-located or operated in conjunction with any other antenna or transmitter.

WEEE Notice

Disposal of Waste Electrical and Electronic Equipment and/or Battery by users in private households in the European Union



WEEE



Battery

This symbol on the product or on the packaging indicates that this cannot be disposed of as a household waste. You must dispose of your waste equipment and/or battery by handing it over to the applicable take-back scheme for the recycling of electrical and electronic equipment and/or battery. For more information about recycling of this equipment and/or battery, please contact your city office, the shop where you purchased the equipment or your household waste disposal service. The

recycling of materials will help to conserve natural resources and ensure that it is recycled in a manner that protects human health and environment.

CE Regulatory Notice

The product herewith complies with the requirements of IEC 62368-1:2014, the EMC Directive 2014/30/EU, the RED-Directive 2014/53/EU and the RoHS Directive 2011/65/EU.

EU Health Protection: This equipment should be installed and operated with minimum distance 20cm between the radiator & your body.

FCC Regulatory Compliance

This device complies with Part 15 of the FCC Rules. Operation is subject to the following two conditions: (1) this device may not cause harmful interference, and (2) this device must accept any interference received, including interference that may cause undesired operation.

Note: This equipment has been tested and found to comply with the limits for a Class B digital device, pursuant to Part 15 of the FCC Rules. These limits are designed to provide reasonable protection against harmful interference in a residential installation. This equipment generates, uses and can radiate radio frequency energy and, if not installed and used in accordance with the instructions, may cause harmful interference to radio communications.

However, there is no guarantee that interference will not occur in a particular installation.

If this equipment does cause harmful interference to radio or television reception, which can be determined by turning the equipment off and on, the user is encouraged to try to correct the interference by one or more of the following measures:

- Reorient or relocate the receiving antenna.
- Increase the separation between the equipment and receiver.
- Connect the equipment into an outlet on a circuit different from that to which the receiver is connected.
- Consult the dealer or an experienced radio/TV technician for help.

Warning: changes or modifications not expressly approved by the party responsible for compliance could void the user's authority to operate the equipment.

RF Exposure Compliance

This equipment complies with FCC radiation exposure limits set forth for an uncontrolled environment. This equipment should be installed and operated with minimum distance 20cm between the radiator and your body. This transmitter must not be co-located or operating in conjunction with any other antenna or transmitter.

Regulatory Notice

- ❖ This document provides country- and region-specific non-wireless and wireless regulatory notices and compliance information for your product. Some of these notices may not apply to your product.
- ❖ Disposal of a battery into fire or a hot oven, or mechanically crushing or cutting of a battery, that can result in an explosion.
- ❖ Leaving a battery in an extremely high temperature surrounding environment that can result in an explosion or the leakage of flammable liquid or gas.
- ❖ Wi-Fi Signals are unable to pass through the building. The limit of signal transmission is 5m.
- ❖ Wi-Fi Operation Channel: Ch1~Ch11
- ❖ The product employs wireless data communication which may interfere, or be interfered by, a near-by camcorder.
- ❖ Never use this camcorder in the vicinity of a microwave oven or at places where there is radio interference.
- ❖ Radio wave reception may be worsened in specific environments.
- ❖ Please be advised that if another camcorder is also using the same 2.4GHz band as this product, the processing speed of both camcorders may slow down.
- ❖ The radio frequency (RF) generated by this RF electronic camcorder may cause adverse effects on the operation of other electronic camcorders and result in malfunctioning. Wireless transmitters and

circuitry may also interfere with other electronic camcorders.





Therefore, do observe the following precautions:

- **Aircraft:** Never use a radio transmitter when you are in an airplane. Please switch off the Wi-Fi function of the camcorder.
 - **Vehicle:** The radio frequency transmitted by this camcorder may affect the electronic system in a motorized vehicle. Please consult the manufacturer or dealer of your vehicle on the possible effect.
 - **Pacemaker:** In order to prevent any potential interference to a pacemaker, anyone who uses a pacemaker should be advised, that, when using this camcorder, a minimum distance of 15cm (6 inch) should be kept between the camcorder and the pacemaker; and never put this camcorder in a chest pocket. In case of any doubt of interference, switch off the camcorder immediately.
 - **Medical Camcorder:** If you use a personal medical camcorder, consult the camcorder manufacturer or your physician to confirm if your camcorder is sufficiently shielded from the RF transmission of this camcorder.
 - **Medical Facilities:** Hospitals and medical institutes may use facilities that are sensitive to an external RF energy. Observe such instructions when the medical care personnel or any posted sign requests you to switch off any camcorder that may interfere the radio frequency.
 - **Explosion sites or any location with a posted sign:** In order to prevent interfering with an explosion activity, observe all the signage and instructions in the Explosion Area or in a zone with a “Switch Off 2-way Radios” sign by switching off camcorders that may interfere with the radio frequency.
- ❖ MUFU is NOT responsible for the loss of any data/content during operation.

By using the product, it is assumed that you agree to all of the above statements.

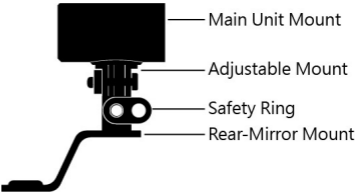
Step 1: Check What's Inside

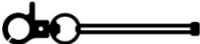
The package contains the following items. If any items are missing or damaged, please contact the original place of purchase immediately.

Main Unit	3-in-1 Mount	
		
Hex Wrench		
		
Safety Cord	USB Cable (type C)	User Manual
		

Step 2: Product Overview

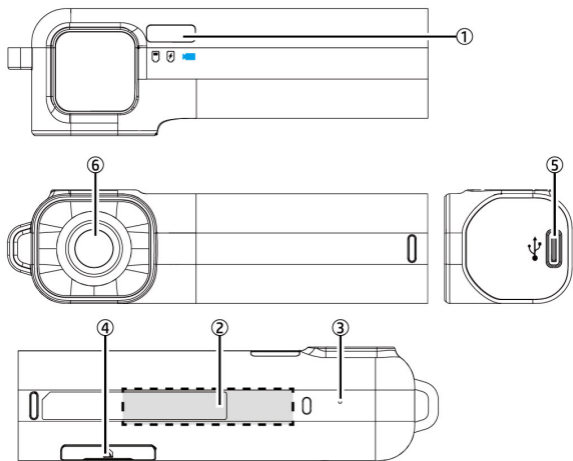

No	Description	No	Description
1	LED indicator	4	microSD slot / Reset
2	Power on/off sensor area	5	USB port (type C)
3	Microphone	6	Lens

Step 3: Insert microSD Card

Insert the micro SD memory card with the pins facing forward and the Main Unit lens facing forward too. (See below for proper installation orientation.) Once the memory card locks into place, replace the slot cover securely over the slot.



The slot cover must be tightly sealed to prevent moisture from entering, causing the lens to fog. Insert the lower edge of the slot cover, then press the top edge and sides of the slot cover to create a good seal. See below.

(1)



(2)



(3)





(4)



(5)



Step 4: LED Indicator

Indicator	Light Status	Description
 Recording	Blue, slow flashing	Recording
	Blue, solid	Power on, No recording
	Blue, rapid flashing	Emergency recording
 Charging	Red, solid	Charging
	No Red light	Full charged
 Battery	Green, rapid flashing	Low battery

Note: Before first use, use the supplied USB type-C charging cable to fully charge the Main Unit. Charge for at least 5 hours until the red LED turns off.

Step 5: Download the App

When using the camera for the first time, use your smartphone to download and install the **MUFU MoTo** app.

Scan below QR code or search “MUFU MoTo” in the iOS App Store Google Play Store.



iOS



Android

APP layout and features may be changed subject to different software versions. Please refer to Google Play Store or iOS App Store for the latest version.

Step 6: Wi-Fi Connection

- 1 Put Main Unit into Main Unit Mount, the Main Unit will automatically power on. Using your smartphone, search nearby Wi-Fi networks for **MUFU_V10S_XXXXXX** (last 6 digits are system random numbers) and tap to connect. Enter initial password **12345678** to connect to and control V10S main unit.
- 2 Once Wi-Fi is connected, open the MUFU MoTo app  and start to set up preferred options or operate other functions. For detail app operation, please refer to **[Step10. App Operation]**

Note:

1. Wi-Fi is turned on automatically when Main Unit powers on. If the Main Unit doesn't connect with the MUFU MoTo app within 3 minutes, Wi-Fi will be disabled automatically to save battery life. If you want to turn on Wi-Fi once again, simply unplug the Main Unit from the mount, wait for all indicator lights to turn off, and plug it in once again to power on the camera and activate the Wi-Fi.
2. Your smartphone must be within a maximum of 5-meter distance from the Main Unit with no buildings in between.
3. The language of MUFU MoTo app will be consistent with your smartphone. Beyond the language options, the app will be activated with default language.

Step 7: Main Unit Installation

Main Unit can be installed either on the right or left rearview mirror. Please use Rear-mirror Mount and Adjustable Mount to adjust and fine tune installation position of the camera. See below for an example of a left side installation.

1 Unbolt the rearview mirror and install 3-in-1 Mount as seen below.



2 Reinstall the mirror and 3-in-1 Mount onto the handlebar.

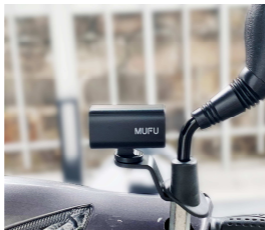

Note: Regardless of whether the Main Unit is installed on left or right side, the MUFU logo on the mount must always be upright and face out, with the LED indicator lights always facing up. Below are installation examples for reference.



Right side (inner) installation.



Left side installation.



Right side (outer) installation.

- 3 Slip the safety cord into the safety cord hole of the Main Unit.



- 4 Plug in Main Unit into Main Unit Mount, and push it to the bottom until “click” sound is heard. The blue LED light will blink slowly to indicate that the camera is now recording. If blue LED light is not blinking, check if microSD card is inserted properly.



- 5 Make Sure your smartphone is connected via Wi-Fi with

MUFU_V10S_XXXXXX, open the MUFU MoTo app  to check preview image, and adjust Rear-mirror Mount and Adjustable Mount to optimize recording view angle. When you have the desired position, use the included hex tool to tighten the mount screws.



- 6** Fasten the safety cord from the Main Unit to the safety ring on the mount to protect your camera from accidentally falling out of the mount while riding.



Step 8: Main Unit Calibration and Use

After adjusting your viewing angle, tap  in the MUFU MoTo app to enter “Camera Setting”. On first use, be sure to calibrate “Tilt Sensor” and “Format” microSD card.

1 Calibrate the Tilt Sensor

Hold your motorcycle upright, straight and still as possible, then tap on “Tilt Sensor” in the menu so the Main Unit can calibrate the internal tilt sensor. After the calibration is completed, if the camera detects that the motorcycle is toppled over, it will trigger emergency recording automatically. This is indicated by the blue LED going from a slow flash to a rapid flash. Emergency recordings are stored in the emergency video folder.

2 Format microSD card



Tap “Format” in the menu to format microSD card. It is recommended to format your card at least once a month to ensure that it is working properly.

Note :

1. When the Main Unit is inserted into Main Unit Mount (or used with the optional carry-on Power Key), it will automatically power on and start recording, indicated by a slow-flashing blue LED indicator light. The recording file will be saved onto the microSD card. When the card reaches capacity, the loop recording function will overwrite the oldest file to make room for new files and continue recording.
2. Memory cards have a service life. Long-term use may lead to write speed degradation and file save failure. If this happens, it is recommended that you purchase a new memory card to use.

Step 9: Change Password

To change the Wi-Fi password, follow the steps below. If left unchanged, the default password is **12345678**.

- 1 Open MUFU MoTo app , and tap  to enter “Camera Setting”. Next, tap “Wi-Fi Password”,



Enter old password. (Default password: **12345678**)

→ Enter your new password.

→ Enter your new password again to confirm.

→ tap “Yes”, and screen will show message of “Setting Success, Connect Wi-Fi again”

→ close app, and follow by step **2** to re-connect Wi-Fi

- 2 iPhone users: Open the Wi-Fi connection and tap the icon (i) by side of MUFU_V10S_xxxxxx. Next, tap “Forget This Network”. Below image will show up, tap “Forget”.

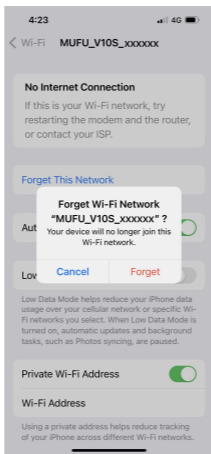

*Note: Android phone user can skip this step.







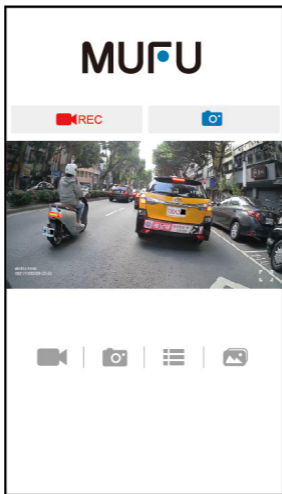

- 3 Next, tap MUFU_V10S_xxxxxx network again to re-enter your new password and reconnect your smartphone to the camera.

Note : Be sure to remember your new password. If you forget your new password, a factory reset will be necessary.

Step 10: App Operation

1 Main Screen





icon	Description
	Start/Stop Recording
	Take snapshot
	Recorded video files (check V10S microSD files)
	Picture files (check V10S microSD files)
	Camera Setting
	Local Album (review downloaded files on your smartphone)
	Full screen preview
	Preview image

Note:



1. The MUFU MoTo App will auto synchronize camera's date/time with your smartphone.
2. App layout and features are subject to change depending on the software version. Refer to Google Play Store or iOS App Store for the latest updates.

2 Playback, delete and download

Use this feature to playback or delete the file saved in the Main Unit, or to download the file from Main Unit to your smartphone.

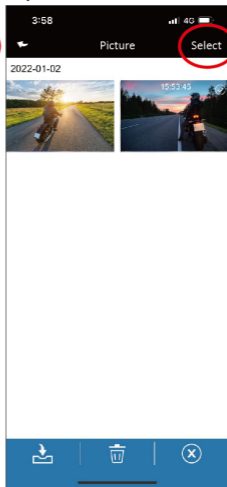
1. Tap the icon  [Video playback] or  [Picture playback] to enter file playback list. Recording will stop.
2. The files saved in the Main Unit's microSD card will be listing on your smartphone. Tap the preview thumbnail to playback.
3. Tap the right top corner "Select" and pick up the files that you want to delete or download, and tap below icon to execute.



Icon	Description
	Download file to smartphone
	Delete file
	Exit

Note :

1. If recording has no audio, check if Audio Recording is OFF in the menu. If you do turn it on, it means the smartphone itself doesn't support the video decoding. It's not the problem of the file. We recommend you to install free media player such as VLC to playback the file.
2. Deleted files cannot be recovered. Backup any important files before deleting them.
- 3. If you plan to download or read a large number of videos and photos, we recommend you to connect to a computer via USB type-C cable.**

3 Local Album

Use this feature to playback or delete the file that you download to your smartphone.

1. Tap the icon  [Local Album]. Recording will stop.
2. Tap the file from preview thumbnail you are going to playback.
3. Tap the right top corner “Select” and pick up the files that you

want to delete, and tap icon  to execute.

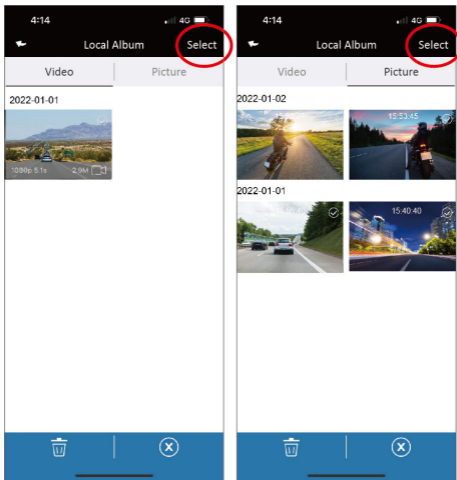

4 Camera Setting

Use this feature to set up your preferred options.

1. Tap icon  [Camera Setting] on main screen. Recording will stop.
2. See available settings below and adjust your preferred options.

Menu	Description	Options
Recording Interval	Set the length of each individual recording.	1min / 3min / 5min
Time Lapse	In the Time Lapse mode, the camera will record one frame per second.	On / Off
Audio Recording	Enable/Disable audio recording.	On / Off
AI Noise Reduction	AI Noise Reduction suppresses surrounding noises so conversation are more audible in recordings.	On / Off
Flicker Frequency	Flicker Frequency (Hz) varies by country/region. Check the "Table of voltage and frequency of different countries" for the correct setting.	50Hz / 60Hz
Tilt Sensor	Calibrate the Tilt Sensor for topple-over detection.	Yes / No
Default Setting	Reset the camera to factory default settings.	Yes / No
Format	Format the memory card in V10S. This will delete all contents permanently.	Yes / No
Wi-Fi Turn-on Time	Set the Wi-Fi activation duration. *Active Wi-Fi will decrease total recording hours.	Always on / 3min off
Wi-Fi Password	Change the Wi-Fi password. (Default: 12345678)	

Firmware Version	Indicates the current firmware version of V10S.	
APP Version	Indicates the current application version.	

Step 11: Final Checks

- Peel off lens protective film**
- Fully charge the Main Unit (Red LED off)**
- Tilt Sensor calibration done**
- Format microSD card done**
- MicroSD card slot cover is closed tightly**
- All Mounts are fixed tightly**
- The safety cord from the main unit is secured to the safety ring on the mount.**

Specifications

Item	Description
Image Sensor	SONY's Starvis Sensor
Effective Pixels	1920 (H) x 1080 (V)
Storage Media	Suggest V30 or higher microSD card, up to 128GB
Lens	Wide angle fixed focus lens Aperture : up to F/2.2
Video File	Resolution : 1080P/ 30 fps
	Format : TS
Picture File	Use App to take snapshot
	Format : JPG
G-Sensor	3-Axls G-Force sensor
Microphone	Built-in
Battery	3200mAh
Operation Temperature	-10° ~ 60° C
Operation Humidity	20 ~ 70% RH
Storage Temperature	-20° ~ 70° C
Main Unit Size	107 x 32 x 29 mm
Main Unit Weight	Approximately 96g

Built-in IEEE 802.11g/n (HT20) Wi-Fi chip: RTL8188FTV

Wi-Fi Frequency	2412~2462MHz
Wi-Fi Channel	Ch1~Ch11



Hall sensor detection design, plug and recording.



Easy DIY installation



High-capacity battery for up to 8.5 hours of continuous recording. (max recording hours may vary, depending on current battery life)



Main Unit waterproof



Sony's Starvis Sensor, perfect night vision.



AI noise reduction



TS video format



Topple-over detection, auto emergency recording and lock the file.



Dedicated MUFU app for preview, download and setting.



Multiple optional accessories for various demands.

Terms & Conditions of Warranty

- Within the scope of the warranty, we commit a 12-month warranty of the MUFU products from the date of purchase.
- If there is no purchase receipt to prove the date of purchase, the manufacture date of this device should be deemed as the effective date of this warranty.
- The scope of the warranty: This warranty covers any manufacturing defects and defects arising from normal usage within 12 months warranty period. This warranty does not cover damages resulting from,
 - Artificial negligence, misuse, improper operation
 - Alteration, adjustment, disassembling or repair by the user or an unauthorized person.
 - Natural disaster, fire, flood, earthquake, accident, acts of God, abnormal voltage or unforeseen circumstances such as wetting, contamination, lightning, etc.
 - The accessories such as the mount, charger, battery, cable/wire/cord, headset, etc. Manufacturing defects will swap new accessory within 7 days from the date of purchase.
- Please note you are required to present the purchase receipt for your warranty service. Failing to do so will make the authorized dealer reserve the right to decline any warranty claims.