

RF29BB8900

SAMSUNG

Bespoke 4-Door French Door Refrigerator (29 cu. ft.) with Family Hub™



Signature Features

Customizable Door Colors

Customize the design of your refrigerator with changeable door panels. Choose from a variety of colors and two finishes to create a space that fits your style.

Family Hub™

Samsung's Family Hub™ refrigerator helps you connect to what's most important: your family and home. Family Hub™ lets you see inside your refrigerator, manage your family's calendars, stream music, see who's at the front door and much more, all right from your fridge.

Beverage Center™

Quick access to refreshingly cool, filtered water two ways. Choose from an internal dispenser or a built-in pitcher that automatically refills, with the option to infuse with a flavor.

Extra-large Capacity

With 29 cu. ft. of capacity, this spacious refrigerator is designed for convenience, offering flexibility and organization to store and access all your favorite foods with ease.

Bespoke 4-Door Refrigerator Standard Color Models



Custom Panel-Ready
with Charcoal Glass
Family Hub™ Panel



Custom Panel-Ready
with White Glass
Family Hub™ Panel



Charcoal Glass Top and Family
Hub™ Panels with Matte Black
Steel Middle and Bottom Panels

Stainless Steel

Tuscan Steel

Charcoal Glass

Matte Black
Steel

Matte Grey
Glass

White Glass

Navy Steel

Pink Glass

Emerald
Green Steel

Morning Blue
Glass

Clementine
Glass

Sunrise Yellow
Glass



Design

- Customizable Door Colors
- Modern Design
- Recessed Handle

Technology

- Family Hub™
- Beverage Center™
- Wi-Fi Enabled

Performance

- Dual Ice Maker with Ice Bites
- FlexZone™ Drawer
- Metal Cooling
- 29 cu. ft. Capacity
- Twin Cooling Plus

Rating



ENERGY STAR® rated:
683 kWh/yr

RF29BB8900

SAMSUNG

Bespoke 4-Door French Door Refrigerator (29 cu. ft.) with Family Hub™

Installation Specifications

1. Measure the height, width and depth of the opening, making sure to include baseboards, molding tile, countertop overhang, etc. Check to be sure there is enough room to open the door (consider walls, islands or other obstacles when measuring).
2. Refer to illustration below to determine dimensions.
3. Allow 2.5" of clearance on hinge side of refrigerator when installing next to a wall where handle may make contact.
4. Allow 1" minimum clearance at rear for proper air circulation and water/electrical connections. Allow a 3/8" minimum clearance at sides and top for ease of installation.
5. Ensure each door and entryway in the home is wide enough for the refrigerator to be moved through easily.

For optimal usage and ability to open refrigerator doors completely, do not install next to a wall.

Please note: The following dimension and cutout information is for planning purposes only. For complete installation details, consult manual packed with product, or download manual online at samsung.com.



Dimensions

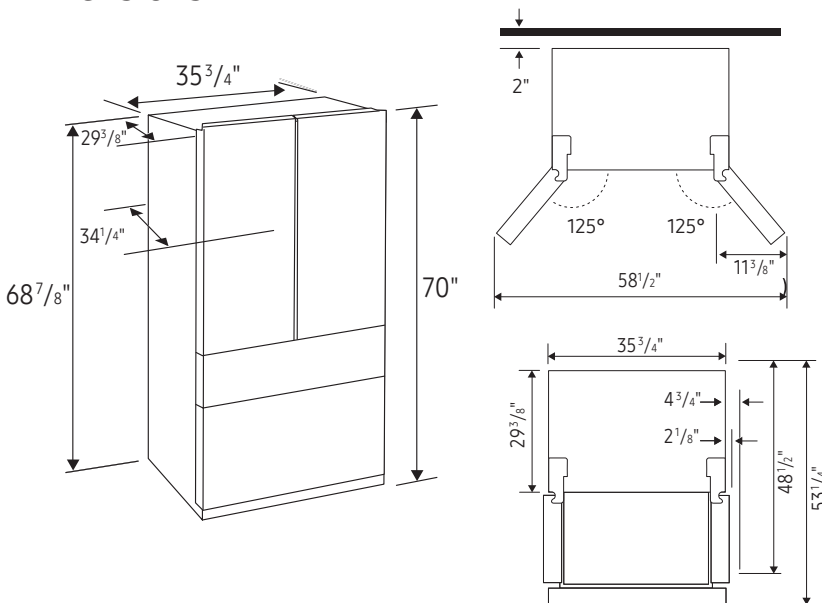

Total Capacity: 28.6 cu. ft.

Refrigerator: 16.5 cu. ft.

- 4 Tempered Glass Spill-Proof Shelves
- 2 Clear Drawers, Including Crisper+
- 6 Door Bins
Right: 1 Gallon Bin, 2 Regular Bins
Left: 3 Regular Bins
- Surface Lighting

FlexZone™ Drawer: 3.1 cu. ft.

- 5 Temperature Zones
 - Soft Freeze (23°F)
 - Meat/Fish (30°F)
 - Cold Drinks (34°F)
 - Deli/Snacks (37°F)
 - Wine/Party Dishes (41°F)
- 2 Drawer Dividers
- High Efficiency LED Lighting

Freezer: 9.0 cu. ft.

- Dual Ice Maker in Freezer (Cubed Ice AND Ice Bites)
- Ice Bucket with Cover and 1 Scoop
- Produces up to 5.3 lbs ice/day, stores up to 9.9 lbs
- High Efficiency LED Lighting

Accessories

Water Filter: HAF-QIN

Warranty

Two (2) Years Parts and Labor on Refrigerator*
Five (5) Years Parts and Labor on Sealed Refrigeration System Only**
Ten (10) Years Parts and Five (5) Years Labor on Digital Inverter Compressor

*Effective for purchases made between 9/1/22 - 7/31/23; proof of purchase required.
**Compressor, evaporator, condenser, drier and connecting tubing.

Product Dimensions

Dimensions (WxHxD with hinges and doors):
35 3/4" x 70" x 34 1/4"

Dimensions (WxHxD without hinges and door):
35 3/4" x 68 7/8" x 29 3/8"

Shipping Dimensions (WxHxD)

Dimensions: 38 1/4" x 75 3/4" x 36 1/4"

Color	Model #	UPC Code	Product & Shipping Weight (lbs)	
Panel-Ready with Charcoal Glass Family Hub™ Panel	RF29BB8900AC	887276624365	359.4	383.6
Panel-Ready with White Glass Family Hub™ Panel	RF29BB8900AW	887276639888	359.4	383.6
Charcoal Glass Top and Family Hub™ Panels with Matte Black Steel Middle and Bottom Panels	RF29BB89008M	887276639864	374.8	399.0