



Test Report No.: W7L-P22120012RF03



FCC TEST REPORT (PART 24)

Applicant:	HMD Global Oy
Address:	Bertel Jungin aukio 9,02600 Espoo,Finland

Manufacturer or Supplier:	HMD Global Oy
Address:	Bertel Jungin aukio 9,02600 Espoo,Finland
Product:	GSM/WCDMA/LTE Mobile Phone
Brand Name:	NOKIA
Model Name:	TA-1563
FCC ID:	2AJOTTA-1563
Date of tests:	Feb. 14, 2023 ~ Feb. 28, 2023

The tests have been carried out according to the requirements of the following standard:

- FCC PART 24, Subpart E
- FCC PART 2
- ANSI/TIA/EIA-603-D
- ANSI/TIA/EIA-603-E
- ANSI C63.26-2015

CONCLUSION: The submitted sample was found to COMPLY with the test requirement

Prepared by Simon Wang
Engineer / Mobile Department

Approved by Luke Lu
Manager / Mobile Department

Date: Feb. 28, 2023

Date: Feb. 28, 2023

This report is governed by, and incorporates by reference, the Conditions of Testing as posted at the date of issuance of this report at <http://www.bureauveritas.com/home/about-us/our-business/cps/about-us/terms-conditions/> and is intended for your exclusive use. Any copying or replication of this report to or for any other person or entity, or use of our name or trademark, is permitted only with our prior written permission. This report sets forth our findings solely with respect to the test samples identified herein. The results set forth in this report are not indicative or representative of the quality or characteristics of the lot from which a test sample was taken or any similar or identical product unless specifically and expressly noted. Our report includes all of the tests requested by you and the results thereof based upon the information that you provided to us. Measurement uncertainty is only provided upon request for accredited tests. Statements of conformity are based on simple acceptance criteria without taking measurement uncertainty into account, unless otherwise requested in writing. You have 60 days from date of issuance of this report to notify us of any material error or omission caused by our negligence or if you require measurement uncertainty; provided, however, that such notice shall be in writing and shall specifically address the issue you wish to raise. A failure to raise such issue within the prescribed time shall constitute your unqualified acceptance of the completeness of this report, the tests conducted and the correctness of the report contents.



TABLE OF CONTENTS

RELEASE CONTROL RECORD	4
1 SUMMARY OF TEST RESULTS	5
1.1 MEASUREMENT UNCERTAINTY	5
1.2 TEST SITE AND INSTRUMENTS	6
2 GENERAL INFORMATION	7
2.1 GENERAL DESCRIPTION OF EUT	7
2.2 CONFIGURATION OF SYSTEM UNDER TEST	10
2.3 DESCRIPTION OF SUPPORT UNITS	11
2.4 TEST ITEM AND TEST CONFIGURATION.....	11
2.5 EUT OPERATING CONDITIONS	14
2.6 GENERAL DESCRIPTION OF APPLIED STANDARDS	14
3 TEST TYPES AND RESULTS	15
3.1 OUTPUT POWER MEASUREMENT	15
3.1.1 LIMITS OF OUTPUT POWER MEASUREMENT	15
3.1.2 TEST PROCEDURES	15
3.1.3 TEST SETUP	16
3.1.4 TEST RESULTS	16
3.2 FREQUENCY STABILITY MEASUREMENT	30
3.2.1 LIMITS OF FREQUENCY STABILITY MEASUREMENT	30
3.2.2 TEST PROCEDURE	30
3.2.3 TEST SETUP	30
3.2.4 TEST RESULTS	31
3.3 OCCUPIED BANDWIDTH MEASUREMENT	32
3.3.1 LIMITS OF OCCUPIED BANDWIDTH MEASUREMENT	32
3.3.2 TEST SETUP	32
3.3.3 TEST PROCEDURES	32
3.3.4 TEST RESULTS	33
3.4 BAND EDGE MEASUREMENTC	34
3.4.1 LIMITS OF BAND EDGE MEASUREMENT	34
3.4.2 TEST SETUP	34
3.4.3 TEST PROCEDURES	35
3.4.4. TEST RESULTS	36
3.5 CONDUCTED SPURIOUS EMISSIONS.....	37
3.5.1 LIMITS OF CONDUCTED SPURIOUS EMISSIONS MEASUREMENT	37
3.5.2 TEST PROCEDURE	37
3.5.3 TEST SETUP	37
3.5.4 TEST RESULTS	38
3.6 RADIATED EMISSION MEASUREMENT	39
3.6.1 LIMITS OF RADIATED EMISSION MEASUREMENT	39
3.6.2 TEST PROCEDURES.....	39



BUREAU
VERITAS

Test Report No.: W7L-P22120012RF03

3.6.3 DEVIATION FROM TEST STANDARD	39
3.6.4 TEST SETUP	40
3.6.5 TEST RESULTS	42
3.7 PEAK TO AVERAGE RATIO	72
3.7.1 LIMITS OF PEAK TO AVERAGE RATIO MEASUREMENT	72
3.7.2 TEST SETUP	72
3.7.3 TEST PROCEDURES	72
3.7.4 TEST RESULTS	73
4 INFORMATION ON THE TESTING LABORATORIES	74
5 MODIFICATIONS RECORDERS FOR ENGINEERING CHANGES TO THE EUT BY THE LAB.....	75
6 APPENDIX	76
GSM1900	76
WCDMA BAND 2	95
LTE BAND2	108



BUREAU
VERITAS

Test Report No.: W7L-P22120012RF03

RELEASE CONTROL RECORD

ISSUE NO.	REASON FOR CHANGE	DATE ISSUED
W7L-P22120012RF03	Original release	Feb. 28, 2023



1 SUMMARY OF TEST RESULTS

The EUT has been tested according to the following specifications:

APPLIED STANDARD: FCC Part 24 & Part 2		
STANDARD SECTION	TEST TYPE	RESULT
§2.1046	Coducted Output Power	Compliance
§24.232(c)	Equivalent Isotropic Radiated Power	Compliance
§2.1055 §24.235	Frequency Stability	Compliance
§2.1049	Occupied Bandwidth	Compliance
§24.232(d)	Peak to average ratio	Compliance
§24.238(a)(b)	Band Edge Measurements	Compliance
§2.1051 §24.238(a)(b)	Conducted Spurious Emissions	Compliance
§2.1053 §24.238(a)(b)	Radiated Spurious Emissions	Compliance

1.1 MEASUREMENT UNCERTAINTY

Where relevant, the following measurement uncertainty levels have been estimated for tests performed on the EUT as specified in CISPR 16-4-2:

MEASUREMENT	UNCERTAINTY
Frequency Stability	± 76.97Hz
Radiated emissions (9KHz~30MHz)	±2.68dB
Radiated emissions & Radiated Power (30MHz~1GHz)	±4.98dB
Radiated emissions & Radiated Power (1GHz ~6GHz)	±4.70dB
Radiated emissions (6GHz ~18GHz)	±4.60dB
Radiated emissions (18GHz ~40GHz)	±4.12dB
Conducted emissions	±4.01dB
Occupied Channel Bandwidth	±43.58KHz
Conducted Output power	±2.06dB
Band Edge Measurements	±4.70dB
Peak to average ratio	±0.76dB

This uncertainty represents an expanded uncertainty expressed at approximately the 95% confidence level using a coverage factor of k=2.



1.2 TEST SITE AND INSTRUMENTS

Equipment	Manufacturer	Model No.	Serial No.	Last Cal.	Next Cal.
MXE EMI Receiver	KEYSIGHT	N9038A-544	MY54450026	Feb. 21,22	Feb. 20,23
MXE EMI Receiver	KEYSIGHT	N9038A-544	MY54450026	Feb. 20,23	Feb. 19,24
EXA Signal Analyzer	KEYSIGHT	N9010A-544	MY54510355	May.15,22	May.14,23
Loop Antenna	Schwarzbeck	FMZB 1519B	00173	Sep.04,22	Sep.03,23
Bilog Antenna	ETS-LINDGRE N	3143B	00161965	Mar. 06,22	Mar. 05,23
Horn Antenna	ETS-LINDGRE N	3117	00168692	Mar. 06,22	Mar. 05,23
Horn Antenna (18GHz-40GHz)	N/A	QWH-SL-18-40-K- SG/QMS-00361	15433	Sep.04,22	Sep.03,23
Radio Communication Analyzer	ANRITSU	MT8820C	6201465426	Feb. 14,23	Feb. 13,24
Signal Pre-Amplifier	EMSI	EMC 9135	980249	May.12,22	May.11,23
Signal Pre-Amplifier	EMSI	EMC 012645B	980257	May.12,22	May.11,23
Signal Pre-Amplifier	EMSI	EMC 184045B	980259	Feb. 21,22	Feb.20,23
Signal Pre-Amplifier	EMSI	EMC 184045B	980259	Feb. 20,23	Feb.19,24
3m Semi-anechoic Chamber	ETS-LINDGRE N	9m*6m*6m	Euroshieldpn- CT0001143-121 6	May. 19,20	May. 18,23
Test Software	E3	V 9.160323	N/A	N/A	N/A
Test Software	JS1120	3.1.36	N/A	N/A	N/A
10dB Attenuator	JFW/USA	50HF-010-SMA	1505	May. 07,22	May. 06,23
Power Meter	Anritsu	ML2495A	1506002	Feb. 22,22	Feb. 21,23
Power Meter	Anritsu	ML2495A	1506002	Feb. 21,23	Feb. 20,24
Power Sensor	Anritsu	MA2411B	1339352	May. 07,22	May. 06,23
Temperature Chamber	ESPEC	SH-242	93000855	May. 12,22	May. 11,23
MXG Analog Microwave Signal Generator	KEYSIGHT	N5183A	MY50143024	Feb. 18,22	Feb. 17,23
MXG Analog Microwave Signal Generator	KEYSIGHT	N5183A	MY50143024	Feb. 17,23	Feb. 16,24
Base station R&S CMW500	Rohde&Schwa rz	CMW500	153085	May.12,22	May.11,23
DC Source	Kikusui/JP	PMX18-5A	0000001	Aug. 24,22	Aug. 23,23

- NOTE:**
1. The calibration interval of the above test instruments is 12 months or 36 months and the calibrations are traceable to CEPREI/CHINA, GRGT/CHINA and NIM/CHINA.
 2. The test was performed in 3m Semi-anechoic Chamber and RF Oven Room.
 3. The horn antenna is used only for the measurement of emission frequency above 1GHz if tested.
 4. The FCC Site Registration No. is 525120; The Designation No. is CN1171.



2 GENERAL INFORMATION

2.1 GENERAL DESCRIPTION OF EUT

PRODUCT	GSM/WCDMA/LTE Mobile Phone	
BRAND NAME	NOKIA	
MODEL NAME	TA-1563	
NOMINAL VOLTAGE	5.0Vdc(adapter or host equipment) 3.7Vdc (Li-ion, battery)	
MODULATION TYPE	GSM: GMSK WCDMA: BPSK, QPSK LTE Band 2: QPSK, 16QAM	
FREQUENCY RANGE	GSM	1850.2MHz ~ 1909.8MHz
	WCDMA	1852.4MHz ~ 1907.6MHz
	LTE Band 2 Channel Bandwidth: 1.4MHz	1850.7MHz ~ 1909.3MHz
	LTE Band 2 Channel Bandwidth: 3MHz	1851.5MHz ~ 1908.5MHz
	LTE Band 2 Channel Bandwidth: 5MHz	1852.5MHz ~ 1907.5MHz
	LTE Band 2 Channel Bandwidth: 10MHz	1855.0MHz ~ 1905.0MHz
	LTE Band 2 Channel Bandwidth: 15MHz	1857.5MHz ~ 1902.5MHz
	LTE Band 2 Channel Bandwidth: 20MHz	1860.0MHz ~ 1900.0MHz
	MAX. EIRP POWER	GSM
WCDMA		261.22mW
LTE Band 2 Channel Bandwidth: 1.4MHz		270.4mW
LTE Band 2 Channel Bandwidth: 3MHz		271.64mW
LTE Band 2 Channel Bandwidth: 5MHz		269.77mW
LTE Band 2 Channel Bandwidth: 10MHz		272.9mW
LTE Band 2 Channel Bandwidth: 15MHz		269.77mW
LTE Band 2 Channel Bandwidth: 20MHz		273.53mW



EMISSION DESIGNATOR EMISSION DESIGNATOR	GSM	246KGXW
	WCDMA	4M17F9W
	LTE Band 2 Channel Bandwidth: 1.4MHz	QPSK: 1M09G7D
		16QAM: 1M09W7D
		64QAM: /
	LTE Band 2 Channel Bandwidth: 3MHz	QPSK: 2M70G7D
		16QAM: 2M69W7D
		64QAM: /
	LTE Band 2 Channel Bandwidth: 5MHz	QPSK: 4M50G7D
		16QAM: 4M50W7D
		64QAM: /
	LTE Band 2 Channel Bandwidth: 10MHz	QPSK: 8M99G7D
		16QAM: 8M99W7D
64QAM: /		
LTE Band 2 Channel Bandwidth: 15MHz	QPSK: 13M5G7D	
	16QAM: 13M5W7D	
	64QAM: /	
LTE Band 2 Channel Bandwidth: 20MHz	QPSK: 18M0G7D	
	16QAM: 18M0W7D	
	64QAM: /	
ANTENNA TYPE	Fixed Internal Antenna with 1.35dBi gain for GSM1900/WCDMA II/LTE B2	
HW VERSION	V0.2	
SW VERSION	HMDSW_TA-1563_0.2	
I/O PORTS	Refer to user's manual	
CABLE SUPPLIED	USB cable: non-shielded cable, with w/o ferrite core, 1.0 meter Earphone cable: non-shielded cable, with w/o ferrite core, 1.5 meter	
EXTREME TEMPERATURE	-10-55 °C	
EXTREME VOLTAGE	3.65V - 4.15V	

NOTE:

1. For a more detailed features description, please refer to the manufacturer's specifications or the user's manual.



- 2. The EUT incorporates a SISO function. Physically, the EUT provides one completed transmitter and one receiver.

MODULATION MODE	TX FUNCTION
GSM/GPRS	1TX/1RX
WCDMA	1TX/1RX
LTE	1TX/1RX

- 3. For the test results, the EUT had been tested with all conditions. But only the worst case was shown in test report.
- 4. There were Sample 1 and 2 for this project, the difference is as below:

SAMPLE	EUT CONFIGURATION INFORMATION
1	LCD Panel 1 (SICHUAN)+Photo Camera 1(Chengxiangtong) +PCB 1(Zhiboxin)+ Speaker 1 (Xingrongda)
2	LCD Panel 2 (Zhongxian intelligent)+Photo Camera 2(Union Image) + PCB (Honggao) + Speaker 2 (Guanyintai)

List of Accessory:

ACCESSORIES	BRAND	MANUFACTURER	MODEL	SPECIFICATION
Battery 1	FHE	Guangdong Fenghua New Energy Co.,Ltd.	BL-L5H	Capacity : 3.7Vdc, 1400mAh
Battery 2	/	Shenzhen Aerospace Electronic Co., Ltd..	BL-L5H	Capacity : 3.7Vdc, 1400mAh
AC Adapter 1	/	Shenzhen BaiJunda Electronics Co., Ltd.	AC-18U	I/P: 100-240Vac, 0.1A, O/P: 5.0Vdc, 0.55A
AC Adapter 2	/	JIANGXI JIAN AOHA TECHNOLOGY CO.,LTD	AC-18U	I/P: 100-240Vac, 0.1A, O/P: 5.0Vdc, 0.55A
USB Cable	/	Saibao(Jiangxi) Communication Industrial Co.,Ltd	SAT-A002A	Signal Line,1.0meter
Earphone Cable	/	HUIZHOU JUWEI ELECTRONICS CO.,LTD	WH-108	Signal Line,1.5meter



2.2 CONFIGURATION OF SYSTEM UNDER TEST

FOR RADIATION EMISSION TEST

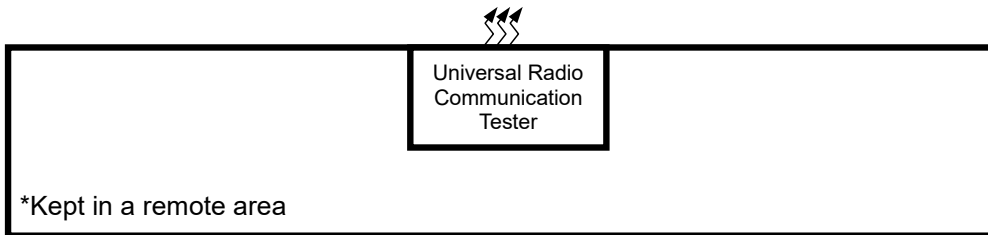
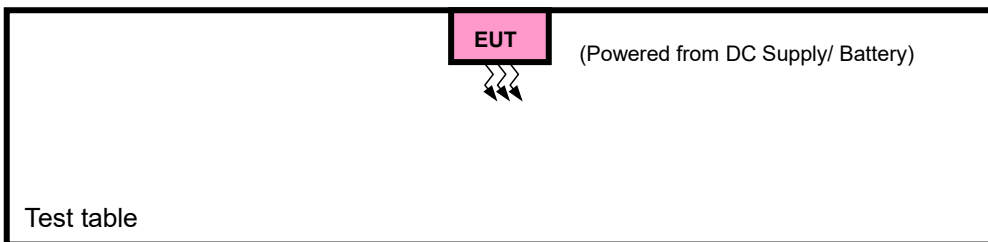
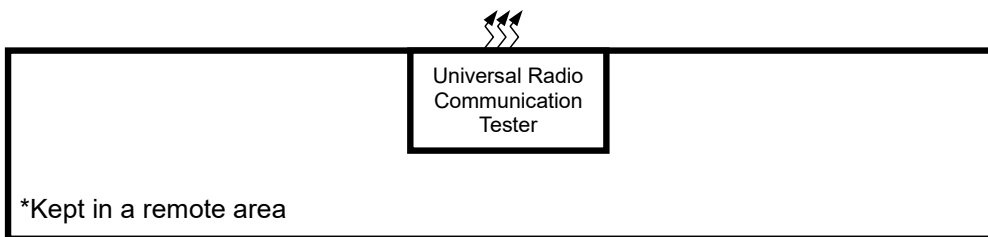
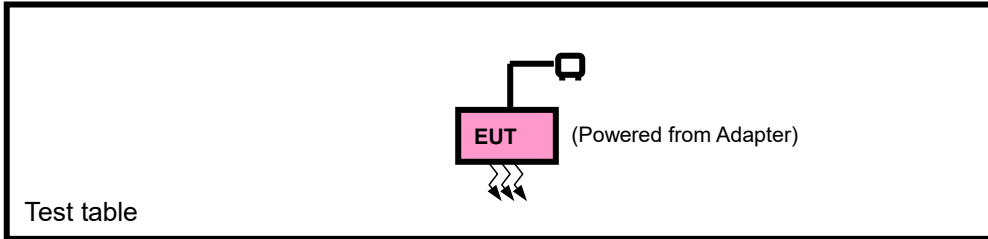



2.3 DESCRIPTION OF SUPPORT UNITS

The EUT has been tested as an independent unit together with other necessary accessories or support units. The following support units or accessories were used to form a representative test configuration during the tests.

NO.	PRODUCT	BRAND	MODEL NO.	SERIAL NO.	FCC ID
1	DC source	Kikusui/JP	PMX18-5A	0000001	N/A

NO.	SIGNAL CABLE DESCRIPTION OF THE ABOVE SUPPORT UNITS
1	DC Line: Unshielded, Detachable 1.0m

2.4 TEST ITEM AND TEST CONFIGURATION

Pre-Scan has been conducted to determine the worst-case mode from all possible combinations between available modulations, data rates, XYZ axis and antenna ports. The worst case in EIRP and radiated emission was found when positioned on X-plane for GSM/WCDMA/ LTE. Following channel(s) was (were) selected for the final test as listed below:

EUT CONFIGURE MODE	DESCRIPTION
A	EUT + Adapter with GSM or WCDMA or LTE link
B	EUT + DC supply with GSM or WCDMA or LTE link

GSM MODE

EUT CONFIGURE MODE	TEST ITEM	AVAILABLE CHANNEL	TESTED CHANNEL	MODE
A	EIRP	512 to 810	512, 661, 810	GSM
B	FREQUENCY STABILITY	512 to 810	512, 661, 810	GSM
A	OCCUPIED BANDWIDTH	512 to 810	512, 661, 810	GSM
A	PEAK TO AVERAGE RATIO	512 to 810	512, 661, 810	GSM
A	BAND EDGE	512 to 810	512, 810	GSM
A	CONDUCTED EMISSION	512 to 810	512, 661, 810	GSM
A	RADIATED EMISSION	512 to 810	512, 661, 810	GSM



**BUREAU
VERITAS**

Test Report No.: W7L-P22120012RF03

WCDMA

EUT CONFIGURE MODE	TEST ITEM	AVAILABLE CHANNEL	TESTED CHANNEL	MODE
A	EIRP	9262 to 9538	9262, 9400, 9538	WCDMA
B	FREQUENCY STABILITY	9262 to 9538	9262, 9400, 9538	WCDMA
A	OCCUPIED BANDWIDTH	9262 to 9538	9262, 9400, 9538	WCDMA
A	PEAK TO AVERAGE RATIO	9262 to 9538	9262, 9400, 9538	WCDMA
A	BAND EDGE	9262 to 9538	9262, 9538	WCDMA
A	CONDCUDED EMISSION	9262 to 9538	9262, 9400, 9538	WCDMA
A	RADIATED EMISSION	9262 to 9538	9262, 9400, 9538	WCDMA

LTE BAND 2 MODE

EUT CONFIGURE MODE	TEST ITEM	AVAILABLE CHANNEL	TESTED CHANNEL	CHANNEL BANDWIDTH	MODULATION	MODE
A	EIRP	18607 to 19193	18607, 18900, 19193	1.4MHz	QPSK,16QAM	1 RB / 0 RB Offset
		18615 to 19185	18615, 18900, 19185	3MHz	QPSK,16QAM	1 RB / 0 RB Offset
		18625 to 19175	18625, 18900, 19175	5MHz	QPSK,16QAM	1 RB / 0 RB Offset
		18650 to 19150	18650, 18900, 19150	10MHz	QPSK,16QAM	1 RB / 0 RB Offset
		18675 to 19125	18675, 18900, 19125	15MHz	QPSK,16QAM	1 RB / 0 RB Offset
		18700 to 19100	18700, 18900, 19100	20MHz	QPSK,16QAM	1 RB / 0 RB Offset
B	FREQUENCY STABILITY	18607 to 19193	18607, 19193	1.4MHz	QPSK	1 RB / 0 RB Offset
		18615 to 19185	18615, 19185	3MHz	QPSK	1 RB / 0 RB Offset
		18625 to 19175	18625, 19175	5MHz	QPSK	1 RB / 0 RB Offset
		18650 to 19150	18650, 19150	10MHz	QPSK	1 RB / 0 RB Offset
		18675 to 19125	18675, 19125	15MHz	QPSK	1 RB / 0 RB Offset
		18700 to 19100	18700, 19100	20MHz	QPSK	1 RB / 0 RB Offset
A	OCCUPIED BANDWIDTH	18607 to 19193	18607, 18900, 19193	1.4MHz	QPSK,16QAM	6 RB / 0 RB Offset
		18615 to 19185	18615, 18900, 19185	3MHz	QPSK,16QAM	15 RB / 0 RB Offset
		18625 to 19175	18625, 18900, 19175	5MHz	QPSK,16QAM	25 RB / 0 RB Offset
		18650 to 19150	18650, 18900, 19150	10MHz	QPSK,16QAM	50 RB / 0 RB Offset
		18675 to 19125	18675, 18900, 19125	15MHz	QPSK,16QAM	75 RB / 0 RB Offset
		18700 to 19100	18700, 18900, 19100	20MHz	QPSK,16QAM	100 RB / 0 RB Offset
A	PEAK TO AVERAGE RATIO	18607 to 19193	18607, 18900, 19193	1.4MHz	QPSK,16QAM	1 RB / 0 RB Offset 6 RB / 0 RB Offset
		18615 to 19185	18615, 18900, 19185	3MHz	QPSK,16QAM	1 RB / 0 RB Offset 15 RB / 0 RB Offset
		18625 to 19175	18625, 18900, 19175	5MHz	QPSK,16QAM	1 RB / 0 RB Offset 25 RB / 0 RB Offset
		18650 to 19150	18650, 18900, 19150	10MHz	QPSK,16QAM	1 RB / 0 RB Offset 50 RB / 0 RB Offset
		18675 to 19125	18675, 18900, 19125	15MHz	QPSK,16QAM	1 RB / 0 RB Offset 75 RB / 0 RB Offset



**BUREAU
VERITAS**

Test Report No.: W7L-P22120012RF03

		18700 to 19100	18700, 18900, 19100	20MHz	QPSK, 16QAM	1 RB / 0 RB Offset 100 RB / 0 RB Offset		
A	BAND EDGE	18607 to 19193	18607	1.4MHz	QPSK, 16QAM	1 RB / 0 RB Offset 6 RB / 0 RB Offset		
			19193	1.4MHz	QPSK, 16QAM	1 RB / 5 RB Offset 6 RB / 0 RB Offset		
		18615 to 19185	18615	3MHz	QPSK, 16QAM	1 RB / 0 RB Offset 15 RB / 0 RB Offset		
			19185	3MHz	QPSK, 16QAM	1 RB / 14 RB Offset 15 RB / 0 RB Offset		
		18625 to 19175	18625	5MHz	QPSK, 16QAM	1 RB / 0 RB Offset 25 RB / 0 RB Offset		
			19175	5MHz	QPSK, 16QAM	1 RB / 24 RB Offset 25 RB / 0 RB Offset		
		18650 to 19150	18650	10MHz	QPSK, 16QAM	1 RB / 0 RB Offset 50 RB / 0 RB Offset		
			19150	10MHz	QPSK, 16QAM	1 RB / 49 RB Offset 50 RB / 0 RB Offset		
		18675 to 19125	18675	15MHz	QPSK, 16QAM	1 RB / 0 RB Offset 75 RB / 0 RB Offset		
			19125	15MHz	QPSK, 16QAM	1 RB / 74 RB Offset 75 RB / 0 RB Offset		
		18700 to 19100	18700	20MHz	QPSK, 16QAM	1 RB / 0 RB Offset 100 RB / 0 RB Offset		
			19100	20MHz	QPSK, 16QAM	1 RB / 99 RB Offset 100 RB / 0 RB Offset		
		A	CONDCUDED EMISSION	18607 to 19193	18607, 18900, 19193	1.4MHz	QPSK	1 RB / 0 RB Offset
				18615 to 19185	18615, 18900, 19185	3MHz	QPSK	1 RB / 0 RB Offset
18625 to 19175	18625, 18900, 19175			5MHz	QPSK	1 RB / 0 RB Offset		
18650 to 19150	18650, 18900, 19150			10MHz	QPSK	1 RB / 0 RB Offset		
18675 to 19125	18675, 18900, 19125			15MHz	QPSK	1 RB / 0 RB Offset		
18700 to 19100	18700, 18900, 19100			20MHz	QPSK	1 RB / 0 RB Offset		
A	RADIATED EMISSION	18607 to 19193	18900	1.4MHz	QPSK	1 RB / 0 RB Offset		
		18615 to 19185	18900	3MHz	QPSK	1 RB / 0 RB Offset		
		18625 to 19175	18625, 18900, 19175	5MHz	QPSK	1 RB / 0 RB Offset		
		18650 to 19150	18900	10MHz	QPSK	1 RB / 0 RB Offset		
		18675 to 19125	18900	15MHz	QPSK	1 RB / 0 RB Offset		
		18700 to 19100	18900	20MHz	QPSK	1 RB / 0 RB Offset		

Note: This device was tested under all bandwidths, RB configurations and modulations. The worst case was found in QPSK modulation.



TEST CONDITION:

TEST ITEM	ENVIRONMENTAL CONDITIONS	INPUT POWER	TESTED BY
EIRP	25deg. C, 57%RH	DC 5V By Adapter	Jace Hu
FREQUENCY STABILITY	23deg. C, 61%RH	DC 3.65V/3.7V/4.15V By DC Supply	James Fu
OCCUPIED BANDWIDTH	23deg. C, 61%RH	DC5V By Adapter	James Fu
PEAK TO AVERAGE RATIO	23deg. C, 61%RH	DC 5V By Adapter	James Fu
BAND EDGE	23deg. C, 61%RH	DC5V By Adapter	James Fu
CONDCUDETED EMISSION	23deg. C, 61%RH	DC5V By Adapter	James Fu
RADIATED EMISSION	23deg. C, 70%RH	DC5V By Adapter	Jace Hu

2.5 EUT OPERATING CONDITIONS

The EUT makes a call to the communication simulator. The communication simulator station system controlled a EUT to export maximum output power under transmission mode and specific channel frequency

2.6 GENERAL DESCRIPTION OF APPLIED STANDARDS

The EUT is a RF product. According to the specifications of the manufacturer, it must comply with the requirements of the following standards:

FCC 47 CFR Part 2

FCC 47 CFR Part 24

KDB 971168 D01 Power Meas License Digital Systems v03r01

ANSI/TIA/EIA-603-D

ANSI/TIA/EIA-603-E

ANSI C63.26-2015

NOTE: All test items have been performed and recorded as per the above standards.

3 TEST TYPES AND RESULTS

3.1 OUTPUT POWER MEASUREMENT

3.1.1 LIMITS OF OUTPUT POWER MEASUREMENT

Mobile and portable stations are limited to 2 watts EIRP.

3.1.2 TEST PROCEDURES

EIRP MEASUREMENT:

Per KDB 971168 D01 Power Meas License Digital Systems v03r01 or subclause 5.2.5.5 of ANSI C63.26-2015, the relevant equation for determining the ERP or EIRP from the conducted RF output power measured using the guidance provided above is:

$$\text{ERP or EIRP} = P_{\text{Meas}} + G_{\text{T}} - L_{\text{C}}$$

Where:

ERP or EIRP = effective radiated power or equivalent isotropically radiated power, respectively

(expressed in the same units as P_{Meas} , typically dBW or dBm);

P_{Meas} = measured transmitter output power or PSD, in dBm or dBW;

G_{T} = gain of the transmitting antenna, in dBd (ERP) or dBi (EIRP);

L_{C} = signal attenuation in the connecting cable between the transmitter and antenna, in dB.

CONDUCTED POWER MEASUREMENT:

The EUT was set up for the maximum power with GSM/WCDMA/LTE link data modulation and link up with simulator. Set the EUT to transmit under low, middle and high channel and record the power level shown on simulator.



3.1.3 TEST SETUP

EIRP / ERP Measurement:

CONDUCTED POWER MEASUREMENT:



3.1.4 TEST RESULTS

CONDUCTED OUTPUT POWER (dBm)

Band	GSM1900		
Channel	512	661	810
Frequency	1850.2	1880	1909.8
GSM	29.81	29.74	29.76
GPRS (GMSK, 1Tx-slot)	29.79	29.73	29.74
GPRS (GMSK, 2Tx-slot)	27.65	27.62	27.73
GPRS (GMSK, 3Tx-slot)	26.07	26.08	26.17
GPRS (GMSK, 4Tx-slot)	23.97	23.96	24.04

Band	WCDMA II		
Channel	9262	9400	9538
Frequency	1852.4	1880	1907.6
RMC 12.2K	22.75	22.79	22.82
HSDPA Subtest-1	21.67	21.75	21.77
HSDPA Subtest-2	21.72	21.73	21.80
HSDPA Subtest-3	21.21	21.18	21.22
HSDPA Subtest-4	21.11	21.22	21.23
HSUPA Subtest-1	21.73	21.78	21.78
HSUPA Subtest-2	19.73	19.71	19.81
HSUPA Subtest-3	20.71	20.63	20.80
HSUPA Subtest-4	19.71	19.70	19.77
HSUPA Subtest-5	21.70	21.77	21.72



BUREAU
VERITAS

Test Report No.: W7L-P22120012RF03

LTE BAND 2

Band/BW	Modulation	RB Size	RB Offset	Low CH 18607	Mid CH 18900	High CH 19193
				Frequency 1850.7 MHz	Frequency 1880 MHz	Frequency 1909.3 MHz
2/ 1.4	QPSK	1	0	22.97	22.91	22.96
		1	2	22.95	22.78	22.93
		1	5	22.87	22.78	22.83
		3	0	22.71	22.58	22.72
		3	1	22.69	22.55	22.55
		3	3	22.65	22.52	22.64
	16QAM	6	0	21.67	21.53	21.55
		1	0	21.72	21.61	21.69
		1	2	21.67	21.50	21.64
		1	5	21.62	21.46	21.59
		3	0	21.71	21.60	21.70
		3	1	21.70	21.63	21.70
		3	3	21.70	21.65	21.72
		6	0	20.70	20.60	20.68



BUREAU
VERITAS

Test Report No.: W7L-P22120012RF03

Band/BW	Modulation	RB Size	RB Offset	Low CH 18615	Mid CH 18900	High CH 19185
				Frequency 1851.5 MHz	Frequency 1880 MHz	Frequency 1908.5 MHz
2/3	QPSK	1	0	22.96	22.90	22.99
		1	7	22.96	22.76	22.93
		1	14	22.84	22.77	22.87
		8	0	21.73	21.61	21.69
		8	3	21.62	21.56	21.58
		8	7	21.66	21.55	21.69
		15	0	21.62	21.57	21.52
	16QAM	1	0	21.70	21.63	21.72
		1	7	21.61	21.56	21.61
		1	14	21.65	21.46	21.58
		8	0	20.67	20.59	20.67
		8	3	20.72	20.62	20.69
		8	7	20.67	20.65	20.71
		15	0	20.70	20.55	20.68



**BUREAU
VERITAS**

Test Report No.: W7L-P22120012RF03

Band/BW	Modulation	RB Size	RB Offset	Low CH 18625	Mid CH 18900	High CH 19175
				Frequency 1852.5 MHz	Frequency 1880 MHz	Frequency 1907.5 MHz
2/5	QPSK	1	0	22.96	22.96	22.95
		1	12	22.91	22.79	22.93
		1	24	22.83	22.78	22.83
		12	0	21.70	21.61	21.72
		12	6	21.62	21.55	21.57
		12	13	21.62	21.59	21.68
		25	0	21.64	21.54	21.49
	16QAM	1	0	21.69	21.67	21.72
		1	12	21.64	21.53	21.62
		1	24	21.65	21.46	21.59
		12	0	20.67	20.61	20.70
		12	6	20.75	20.58	20.73
		12	13	20.72	20.63	20.68
		25	0	20.70	20.54	20.71



**BUREAU
VERITAS**

Test Report No.: W7L-P22120012RF03

Band/BW	Modulation	RB Size	RB Offset	Low CH 18650	Mid CH 18900	High CH 19150
				Frequency 1855 MHz	Frequency 1880 MHz	Frequency 1905 MHz
2/ 10	QPSK	1	0	23.01	22.94	22.93
		1	24	22.94	22.81	22.89
		1	49	22.87	22.84	22.84
		25	0	21.71	21.61	21.73
		25	12	21.69	21.55	21.58
		25	25	21.62	21.53	21.68
		50	0	21.67	21.55	21.54
	16QAM	1	0	21.74	21.67	21.68
		1	24	21.65	21.53	21.64
		1	49	21.61	21.52	21.57
		25	0	20.73	20.57	20.74
		25	12	20.70	20.60	20.70
		25	25	20.71	20.64	20.71
		50	0	20.75	20.57	20.65



BUREAU
VERITAS

Test Report No.: W7L-P22120012RF03

Band/BW	Modulation	RB Size	RB Offset	Low CH 18675	Mid CH 18900	High CH 19125
				Frequency 1857.5 MHz	Frequency 1880 MHz	Frequency 1902.5 MHz
2/ 15	QPSK	1	0	22.94	22.94	22.96
		1	37	22.96	22.76	22.94
		1	74	22.81	22.81	22.83
		36	0	21.74	21.60	21.72
		36	19	21.68	21.50	21.58
		36	39	21.64	21.52	21.68
		75	0	21.67	21.57	21.49
	16QAM	1	0	21.70	21.60	21.68
		1	37	21.66	21.52	21.64
		1	74	21.65	21.47	21.55
		36	0	20.69	20.57	20.73
		36	19	20.76	20.56	20.74
		36	39	20.66	20.66	20.68
		75	0	20.74	20.54	20.72



**BUREAU
VERITAS**

Test Report No.: W7L-P22120012RF03

Band/BW	Modulation	RB Size	RB Offset	Low CH 18700	Mid CH 18900	High CH 19100
				Frequency 1860 MHz	Frequency 1880 MHz	Frequency 1900 MHz
2/ 20	QPSK	1	0	23.02	22.98	23.01
		1	50	22.98	22.84	22.95
		1	99	22.89	22.85	22.88
		50	0	21.77	21.66	21.74
		50	25	21.70	21.57	21.63
		50	50	21.70	21.60	21.70
		100	0	21.68	21.59	21.57
	16QAM	1	0	21.77	21.68	21.74
		1	50	21.69	21.58	21.66
		1	99	21.67	21.54	21.60
		50	0	20.75	20.65	20.75
		50	25	20.78	20.64	20.75
		50	50	20.74	20.70	20.73
		100	0	20.76	20.62	20.73



**BUREAU
VERITAS**

Test Report No.: W7L-P22120012RF03

EIRP POWER (dBm)

GSM

Channel	Frequency (MHz)	Conducted Power (dBm)	G _{T-Lc} (dB)	EIRP (dBm)	EIRP (mW)	Limit (W)
512	1850.2	29.81	1.35	31.16	1306.17	2
661	1880.0	29.74	1.35	31.09	1285.29	2
810	1909.8	29.76	1.35	31.11	1291.22	2

WCDMA

Channel	Frequency (MHz)	Conducted Power (dBm)	G _{T-Lc} (dB)	EIRP (dBm)	EIRP (mW)	Limit (W)
9262	1852.4	22.75	1.35	24.1	257.04	2
9400	1880	22.79	1.35	24.14	259.42	2
9538	1907.6	22.82	1.35	24.17	261.22	2



LTE BAND 2

CHANNEL BANDWIDTH: 1.4MHz QPSK

Channel	Frequency (MHz)	Conducted Power (dBm)	G _{T-Lc} (dB)	EIRP (dBm)	EIRP (mW)	Limit (W)
18607	1850.7	22.97	1.35	24.32	270.4	2
18900	1880.0	22.91	1.35	24.26	266.69	2
19193	1909.3	22.96	1.35	24.31	269.77	2

CHANNEL BANDWIDTH: 1.4MHz 16QAM

Channel	Frequency (MHz)	Conducted Power (dBm)	G _{T-Lc} (dB)	EIRP (dBm)	EIRP (mW)	Limit (W)
18607	1850.7	21.72	1.35	23.07	202.77	2
18900	1880.0	21.65	1.35	23	199.53	2
19193	1909.3	21.72	1.35	23.07	202.77	2



CHANNEL BANDWIDTH: 3MHz QPSK

Channel	Frequency (MHz)	Conducted Power (dBm)	G _{T-Lc} (dB)	EIRP (dBm)	EIRP (mW)	Limit (W)
18615	1851.5	22.96	1.35	24.31	269.77	2
18900	1880.0	22.9	1.35	24.25	266.07	2
19185	1908.5	22.99	1.35	24.34	271.64	2

CHANNEL BANDWIDTH: 3MHz 16QAM

Channel	Frequency (MHz)	Conducted Power (dBm)	G _{T-Lc} (dB)	EIRP (dBm)	EIRP (mW)	Limit (W)
18615	1851.5	21.7	1.35	23.05	201.84	2
18900	1880.0	21.63	1.35	22.98	198.61	2
19185	1908.5	21.72	1.35	23.07	202.77	2



**BUREAU
VERITAS**

Test Report No.: W7L-P22120012RF03

CHANNEL BANDWIDTH: 5MHz QPSK

Channel	Frequency (MHz)	Conducted Power (dBm)	G _{T-Lc} (dB)	EIRP (dBm)	EIRP (mW)	Limit (W)
18625	1852.5	22.96	1.35	24.31	269.77	2
18900	1880.0	22.96	1.35	24.31	269.77	2
19175	1907.5	22.95	1.35	24.3	269.15	2

CHANNEL BANDWIDTH: 5MHz 16QAM

Channel	Frequency (MHz)	Conducted Power (dBm)	G _{T-Lc} (dB)	EIRP (dBm)	EIRP (mW)	Limit (W)
18625	1852.5	21.69	1.35	23.04	201.37	2
18900	1880.0	21.67	1.35	23.02	200.45	2
19175	1907.5	21.72	1.35	23.07	202.77	2



CHANNEL BANDWIDTH: 10MHz QPSK

Channel	Frequency (MHz)	Conducted Power (dBm)	G _{T-Lc} (dB)	EIRP (dBm)	EIRP (mW)	Limit (W)
18650	1855.0	23.01	1.35	24.36	272.9	2
18900	1880.0	22.94	1.35	24.29	268.53	2
19150	1905.0	22.93	1.35	24.28	267.92	2

CHANNEL BANDWIDTH: 10MHz 16QAM

Channel	Frequency (MHz)	Conducted Power (dBm)	G _{T-Lc} (dB)	EIRP (dBm)	EIRP (mW)	Limit (W)
18650	1855.0	21.74	1.35	23.09	203.7	2
18900	1880.0	21.67	1.35	23.02	200.45	2
19150	1905.0	21.68	1.35	23.03	200.91	2



**BUREAU
VERITAS**

Test Report No.: W7L-P22120012RF03

CHANNEL BANDWIDTH: 15MHz QPSK

Channel	Frequency (MHz)	Conducted Power (dBm)	G _{T-Lc} (dB)	EIRP (dBm)	EIRP (mW)	Limit (W)
18675	1857.5	22.96	1.35	24.31	269.77	2
18900	1880.0	22.94	1.35	24.29	268.53	2
19125	1902.5	22.96	1.35	24.31	269.77	2

CHANNEL BANDWIDTH: 15MHz 16QAM

Channel	Frequency (MHz)	Conducted Power (dBm)	G _{T-Lc} (dB)	EIRP (dBm)	EIRP (mW)	Limit (W)
18675	1857.5	21.7	1.35	23.05	201.84	2
18900	1880.0	21.6	1.35	22.95	197.24	2
19125	1902.5	21.68	1.35	23.03	200.91	2



CHANNEL BANDWIDTH: 20MHz QPSK

Channel	Frequency (MHz)	Conducted Power (dBm)	G _{T-Lc} (dB)	EIRP (dBm)	EIRP (mW)	Limit (W)
18700	1860	23.02	1.35	24.37	273.53	2
18900	1880	22.98	1.35	24.33	271.02	2
19100	1900	23.01	1.35	24.36	272.9	2

CHANNEL BANDWIDTH: 20MHz 16QAM

Channel	Frequency (MHz)	Conducted Power (dBm)	G _{T-Lc} (dB)	EIRP (dBm)	EIRP (mW)	Limit (W)
18700	1860	21.77	1.35	23.12	205.12	2
18900	1880	21.68	1.35	23.03	200.91	2
19100	1900	21.74	1.35	23.09	203.7	2



3.2 FREQUENCY STABILITY MEASUREMENT

3.2.1 LIMITS OF FREQUENCY STABILITY MEASUREMENT

The frequency stability shall be sufficient to ensure that the fundamental emission stays within the authorized frequency block.

3.2.2 TEST PROCEDURE

- Device is placed at the oven room. The oven room could control the temperatures and humidity. Power warm up is at least 15 min and power applied should perform before recording frequency error.
- EUT is connected the external power supply to control the DC input power. The test voltage range is from minimum to maximum working voltage. Each step shall be record the frequency error rate.
- The temperature range step is 10 degrees in this test items. All temperature levels shall be hold the $\pm 0.5^{\circ}\text{C}$ during the measurement testing. The each temperature step shall be at least 0.5 hours, consider the EUT could be test under the stability condition.

NOTE: The frequency error was recorded frequency error from the communication simulator.

3.2.3 TEST SETUP

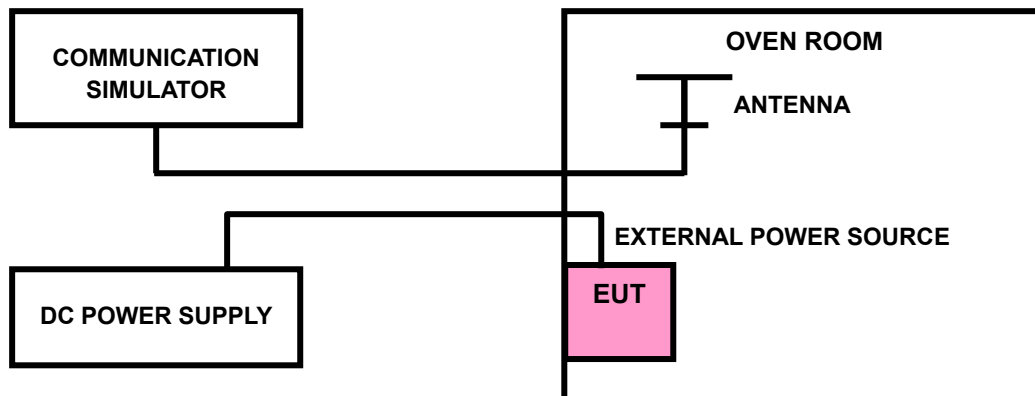



**BUREAU
VERITAS**

Test Report No.: W7L-P22120012RF03

3.2.4 TEST RESULTS

Please Refer to Appendix Of this test report.

Note: VL = Low voltage(3.65V); VN/NV = Normal voltage(3.7V); VH = High voltage(4.15V);
NT = Normal temperature (25°C)



3.3 OCCUPIED BANDWIDTH MEASUREMENT

3.3.1 LIMITS OF OCCUPIED BANDWIDTH MEASUREMENT

The width of a frequency band such that, below the lower and above the upper frequency limits, the mean powers emitted are each equal to a specified percentage 0.5 % of the total mean power of a given emission.

3.3.2 TEST SETUP

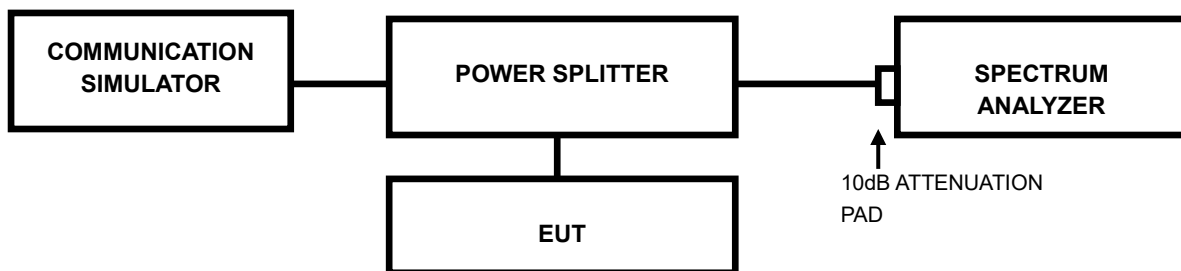

3.3.3 TEST PROCEDURES

- The conducted occupied bandwidth used the power splitter via EUT RF power connector between simulation base station and spectrum analyzer.
- Use OBW measurement function of Spectrum analyzer to measure 99 % occupied bandwidth.



Test Report No.: W7L-P22120012RF03

3.3.4 TEST RESULTS

Please Refer to Appendix Of this test report.



3.4 BAND EDGE MEASUREMENTC

3.4.1 LIMITS OF BAND EDGE MEASUREMENT

Power of any emission outside of the authorized operating frequency ranges must be attenuated below the transmitting power (P) by a factor of at least $43 + 10 \log(P)$ dB. In the 1 MHz bands immediately outside and adjacent to the frequency block a resolution bandwidth of at least one percent of the emission bandwidth of the fundamental emission of the transmitter may be employed.

3.4.2 TEST SETUP

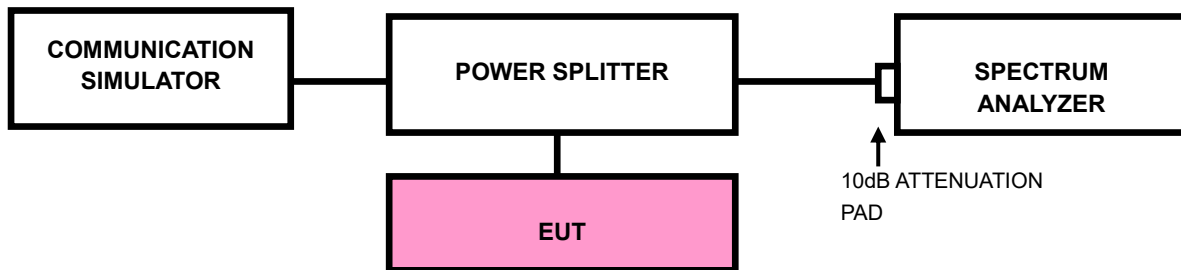



3.4.3 TEST PROCEDURES

- a) All measurements were done at low and high operational frequency range
- b) Connect the transmitter to the spectrum analyzer via coaxial cable while ensuring proper impedance matching.
- c) Tune the analyzer to the nominal center frequency of the emission bandwidth (EBW)
- d) .Set the resolution bandwidth (RBW) $\geq 1\%$ EBW in the 1MHz band immediately outside and adjacent to the band edge.
- e) Beyond the 1MHz band from the band edge, RBW=1MHz was used.
- f) Set the video bandwidth (VBW) to $\geq 3 \times$ RBW.
- g) Select the average power (RMS) display detector.
- h) Set the number of measurement points to ≥ 1001 .
- i) Use auto-coupled sweep time.
- j) Perform the measurement over an interval of time when the transmission is continuous and at its maximum power level.
- k) The RF fundamental frequency should be excluded against the limit line in the operating frequency band and use RBW is 10KHz or 100KHz.
- l) Record the max trace plot into the test report.



Test Report No.: W7L-P22120012RF03

3.4.4. TEST RESULTS

Please Refer to Appendix Of this test report.



3.5 CONDUCTED SPURIOUS EMISSIONS

3.5.1 LIMITS OF CONDUCTED SPURIOUS EMISSIONS MEASUREMENT

The power of any emission outside of the authorized operating frequency ranges must be attenuated below the transmitting power (P) by a factor of at least $43 + 10 \log(P)$ dB. The emission limit equal to -13dBm .

3.5.2 TEST PROCEDURE

- a. The EUT makes a phone call to the communication simulator. All measurements were done at low, middle and high operational frequency range.
- b. Measuring frequency range is from 30MHz up to a frequency including its 10th harmonic. 10dB attenuation pad is connected with spectrum. RBW=1MHz and VBW=3MHz is used for conducted emission measurement.

3.5.3 TEST SETUP

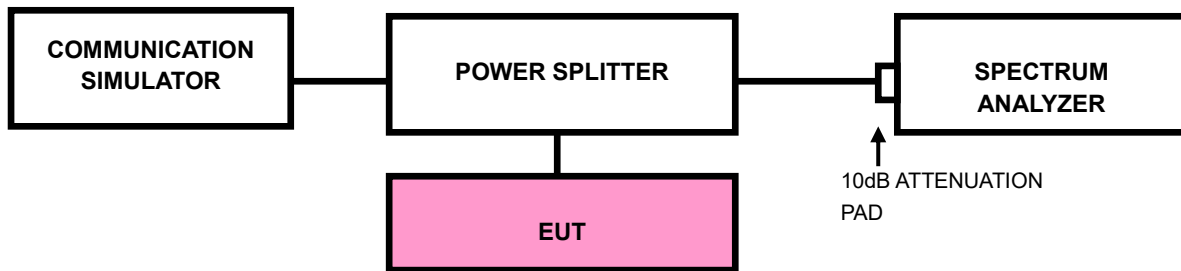



**BUREAU
VERITAS**

Test Report No.: W7L-P22120012RF03

3.5.4 TEST RESULTS

NOTE : The 9K~30MHz amplitude of spurious emissions attenuated more than 20 dB below the permissible value is not required in the report.

Please Refer to Appendix Of this test report.



3.6 RADIATED EMISSION MEASUREMENT

3.6.1 LIMITS OF RADIATED EMISSION MEASUREMENT

The power of any emission outside of the authorized operating frequency ranges must be attenuated below the transmitting power (P) by a factor of at least $43 + 10 \log(P)$ dB. The emission limit equal to -13dBm .

3.6.2 TEST PROCEDURES

- a. Substitution method is used for E.I.R.P measurement. In the semi-anechoic chamber, EUT placed on the 0.8m height of Turn Table, rotated the table around 360 degrees to search the maximum radiation power and receiver antenna shall be rotated vertical and horizontal polarization and moved height from 1m to 4m to find the maximum polar radiated power. The "Read Value" is the spectrum reading the maximum power value.
- b. The substitution horn antenna is substituted for EUT at the same position and signals generator export the CW signal to the substitution antenna via a TX cable. Rotated the Turn Table and moved receiving antenna to find the maximum radiation power. Adjust output power level of S.G to get a Value of spectrum reading equal to "Read Value" of step a. Record the power level of S.G
- c. $\text{EIRP} = \text{Output power level of S.G} - \text{TX cable loss} + \text{Antenna gain of substitution horn}$.

NOTE: The resolution bandwidth and video bandwidth of test receiver/spectrum analyzer is 1MHz/3MHz.

3.6.3 DEVIATION FROM TEST STANDARD

No deviation



3.6.4 TEST SETUP

< Frequency Range below 30MHz >

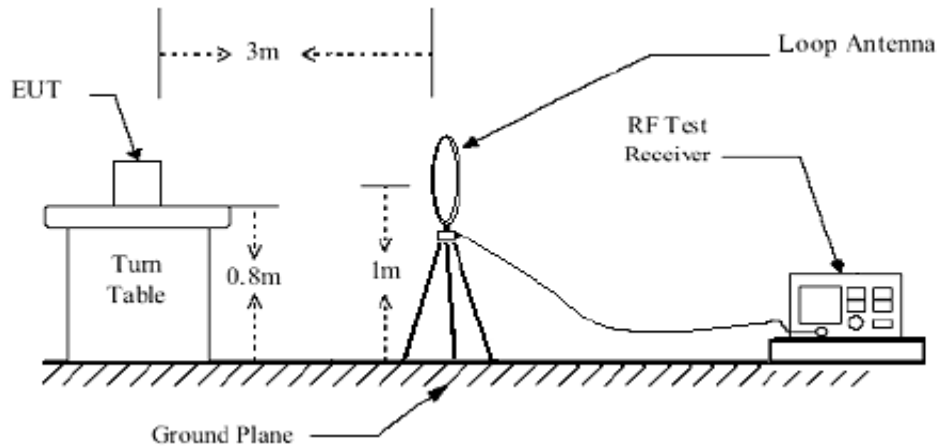

< Frequency Range 30MHz~1GHz >

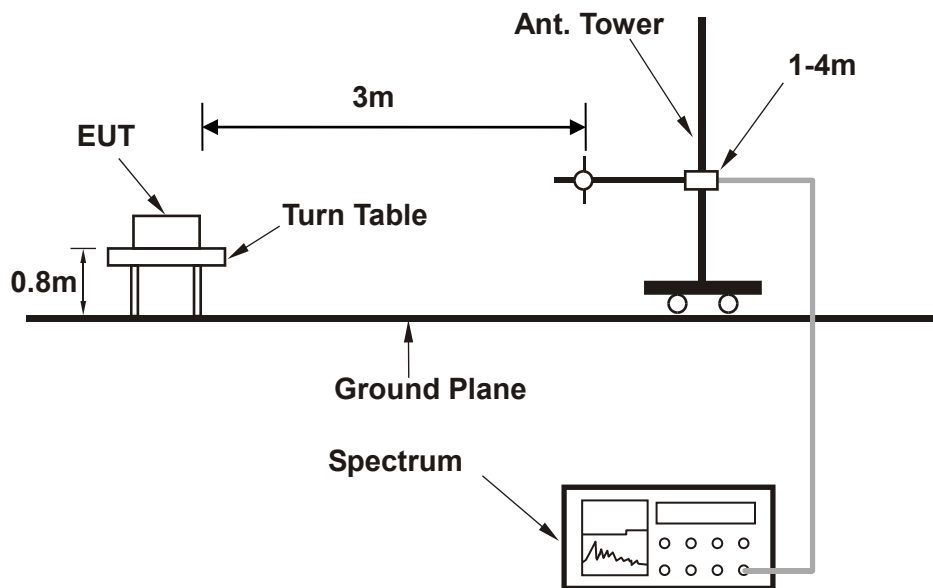



<Frequency Range above 1GHz>

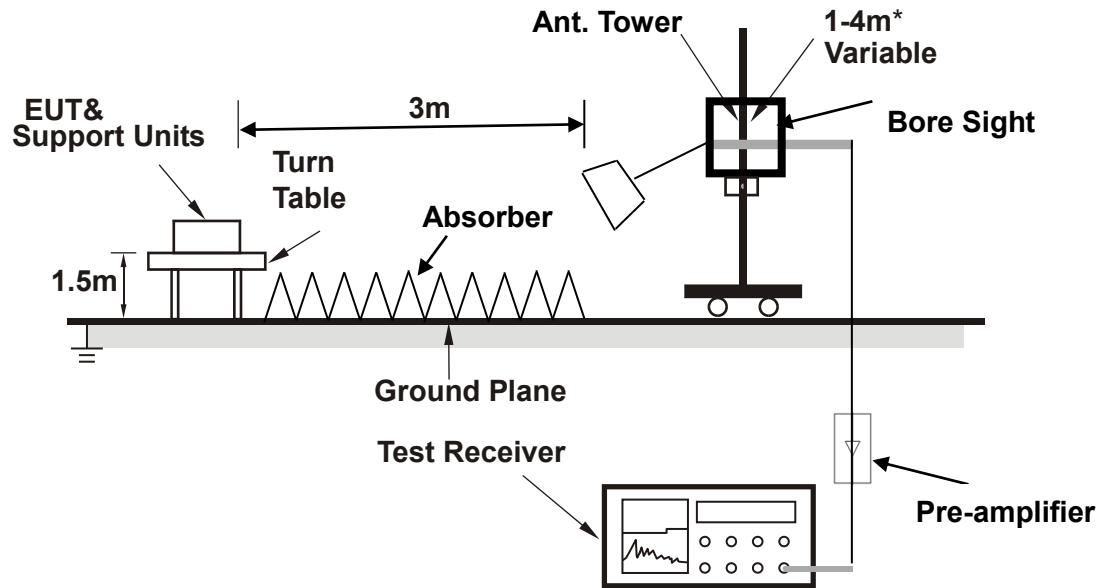

Note: Above 1G is a directional antenna

Depends on the EUT height and the antenna 3dB beamwidth both, refer to section 7.3 of CISPR 16-2-3.

For the actual test configuration, please refer to the attached file (Test Setup Photo).



**BUREAU
VERITAS**

Test Report No.: W7L-P22120012RF03

3.6.5 TEST RESULTS

NOTE : The 9K~30MHz amplitude of spurious emissions attenuated more than 20 dB below the permissible value is not required in the report.

BELOW 1GHz WORST-CASE DATA

30 MHz – 1GHz data:

LTE Band 2

CHANNEL BANDWIDTH: 5MHz / QPSK

MODE	TX channel 18625	FREQUENCY RANGE	Below 1000MHz
ENVIRONMENTAL CONDITIONS	23deg. C, 70%RH	INPUT POWER	AC 120V/60Hz
TESTED BY	Jace Hu		
ANTENNA POLARITY & TEST DISTANCE: HORIZONTAL AT 3 M			

	Freq	Level	Read Level	Limit Line	Over Limit	Factor	Remark	Pol/Phase
	MHz	dBm/m	dBm	dBm/m	dB	dB/m		
1	52.310	-71.20	-53.83	-13.00	-58.20	-17.37	Peak	Horizontal
2	87.230	-68.52	-47.41	-13.00	-55.52	-21.11	Peak	Horizontal
3	143.490	-70.55	-51.32	-13.00	-57.55	-19.23	Peak	Horizontal
4	187.140	-68.97	-50.40	-13.00	-55.97	-18.57	Peak	Horizontal
5 PP	243.400	-63.98	-51.74	-13.00	-50.98	-12.24	Peak	Horizontal
6	418.970	-68.44	-58.75	-13.00	-55.44	-9.69	Peak	Horizontal

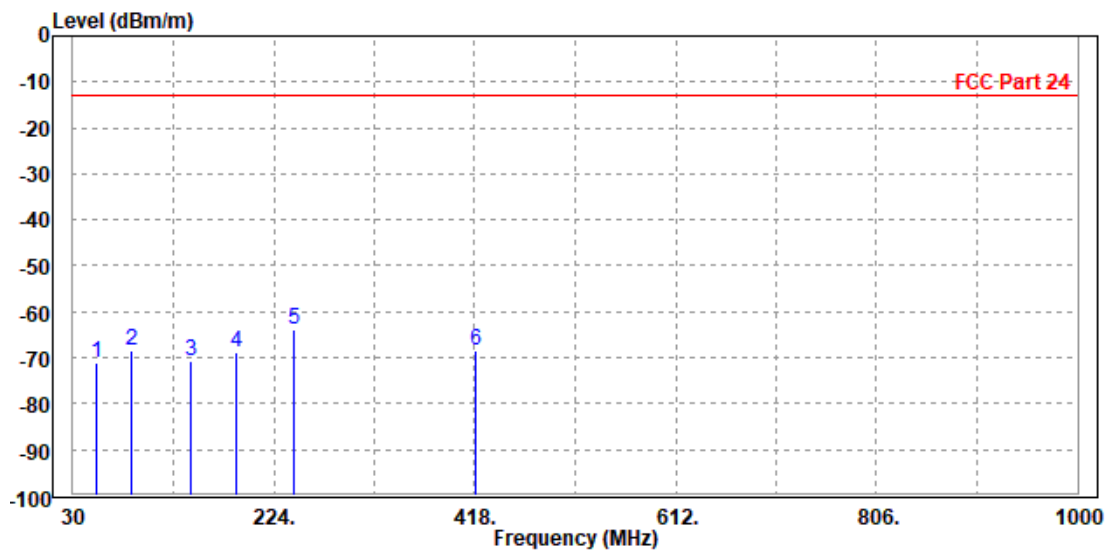



**BUREAU
VERITAS**

Test Report No.: W7L-P22120012RF03

MODE	TX channel 18625	FREQUENCY RANGE	Below 1000MHz
ENVIRONMENTAL CONDITIONS	23deg. C, 70%RH	INPUT POWER	AC 120V/60Hz
TESTED BY	Jace Hu		
ANTENNA POLARITY & TEST DISTANCE: VERTICAL AT 3 M			

	Freq	Level	Read Level	Limit Line	Over Limit	Factor	Remark	Pol/Phase
	MHz	dBm/m	dBm	dBm/m	dB	dB/m		
1	35.820	-75.77	-54.39	-13.00	-62.77	-21.38	Peak	Vertical
2 PP	80.440	-60.23	-41.23	-13.00	-47.23	-19.00	Peak	Vertical
3	99.840	-61.97	-55.46	-13.00	-48.97	-6.51	Peak	Vertical
4	118.270	-70.71	-56.68	-13.00	-57.71	-14.03	Peak	Vertical
5	236.610	-69.43	-54.65	-13.00	-56.43	-14.78	Peak	Vertical
6	468.440	-70.43	-62.06	-13.00	-57.43	-8.37	Peak	Vertical

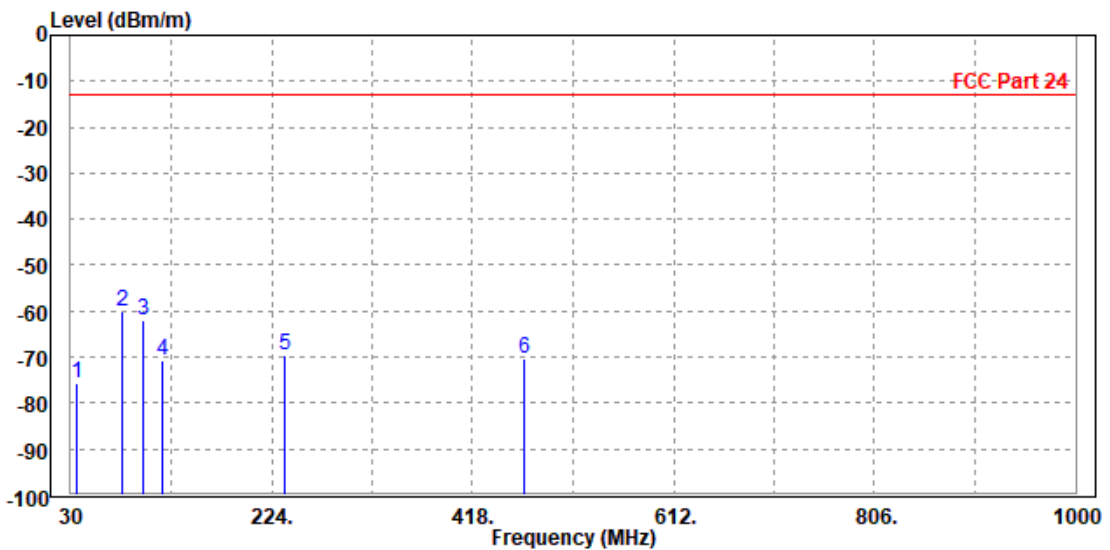



**BUREAU
VERITAS**

Test Report No.: W7L-P22120012RF03

ABOVE 1GHz DATA

Note: For higher frequency, the emission is too low to be detected.

WORST-CASE DATA

GSM 1900:

CH 512

MODE	TX channel 512	FREQUENCY RANGE	Above 1000MHz
ENVIRONMENTAL CONDITIONS	23deg. C, 70%RH	INPUT POWER	AC 120V/60HZ
TESTED BY	Jace Hu		
ANTENNA POLARITY & TEST DISTANCE: HORIZONTAL AT 3 M			

	Freq	Level	Read Level	Limit Line	Over Limit	Factor	Remark	Pol/Phase
	MHz	dBm/m	dBm	dBm/m	dB	dB/m		
1	3700.400	-52.22	-60.06	-13.00	-39.22	7.84	Peak	Horizontal
2 PP	5560.000	-51.40	-61.99	-13.00	-38.40	10.59	Peak	Horizontal

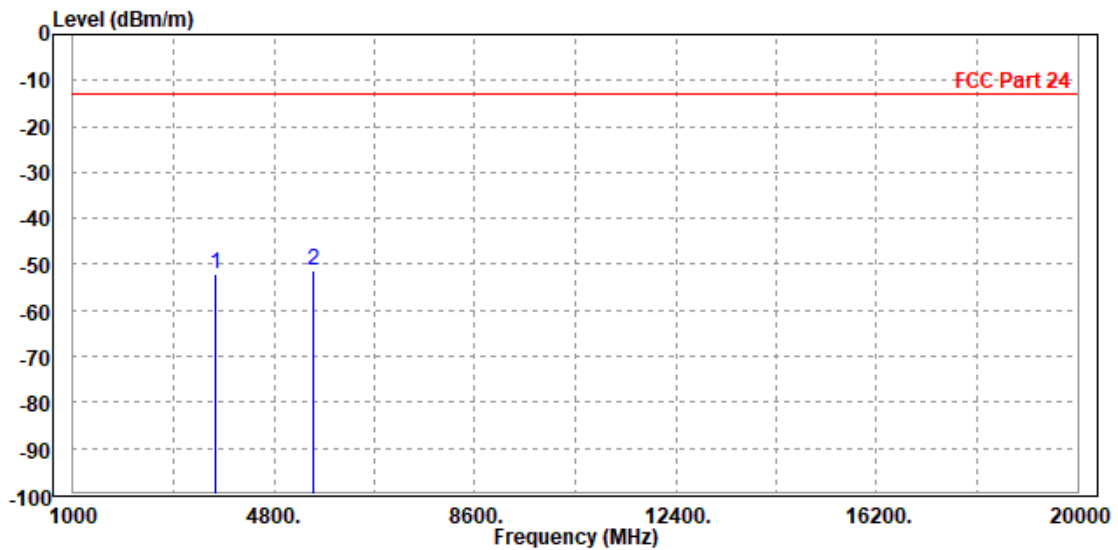



**BUREAU
VERITAS**

Test Report No.: W7L-P22120012RF03

MODE	TX channel 512	FREQUENCY RANGE	Above 1000MHz
ENVIRONMENTAL CONDITIONS	23deg. C, 70%RH	INPUT POWER	AC 120V/60HZ
TESTED BY	Jace Hu		
ANTENNA POLARITY & TEST DISTANCE: VERTICAL AT 3 M			

	Freq	Level	Read Level	Limit Line	Over Limit	Factor	Remark	Pol/Phase
	MHz	dBm/m	dBm	dBm/m	dB	dB/m		
1	3698.000	-53.13	-60.74	-13.00	-40.13	7.61	Peak	Vertical
2 PP	5550.600	-50.37	-61.24	-13.00	-37.37	10.87	Peak	Vertical

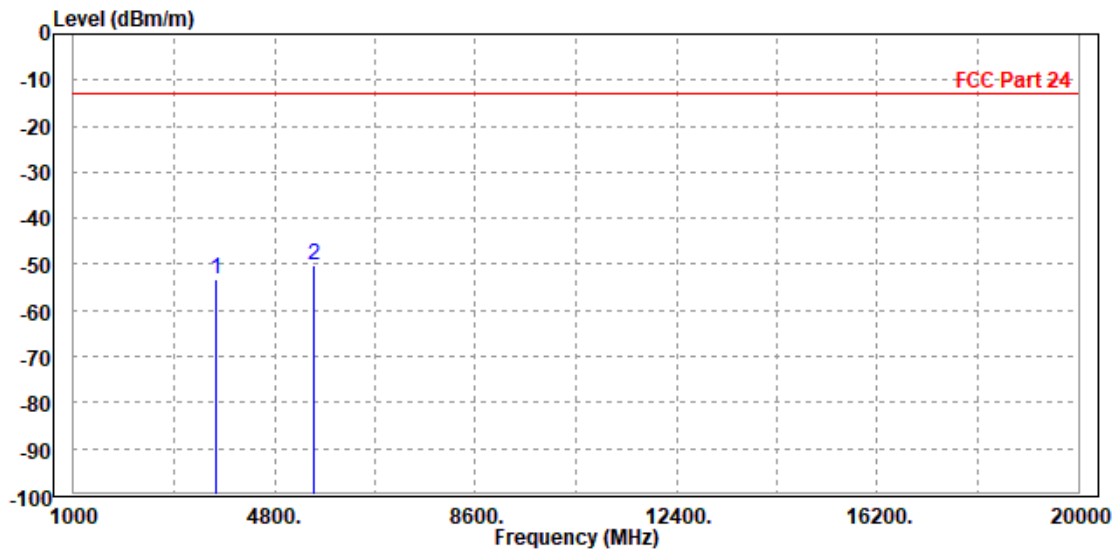



**BUREAU
VERITAS**

Test Report No.: W7L-P22120012RF03

CH 661

MODE	TX channel 661	FREQUENCY RANGE	Above 1000MHz
ENVIRONMENTAL CONDITIONS	23deg. C, 70%RH	INPUT POWER	AC 120V/60HZ
TESTED BY	Jace Hu		
ANTENNA POLARITY & TEST DISTANCE: HORIZONTAL AT 3 M			

	Freq	Level	Read Level	Limit Line	Over Limit	Factor	Remark	Pol/Phase
	MHz	dBm/m	dBm	dBm/m	dB	dB/m		
1	3755.000	-52.71	-60.69	-13.00	-39.71	7.98	Peak	Horizontal
2 PP	5640.000	-49.82	-60.56	-13.00	-36.82	10.74	Peak	Horizontal

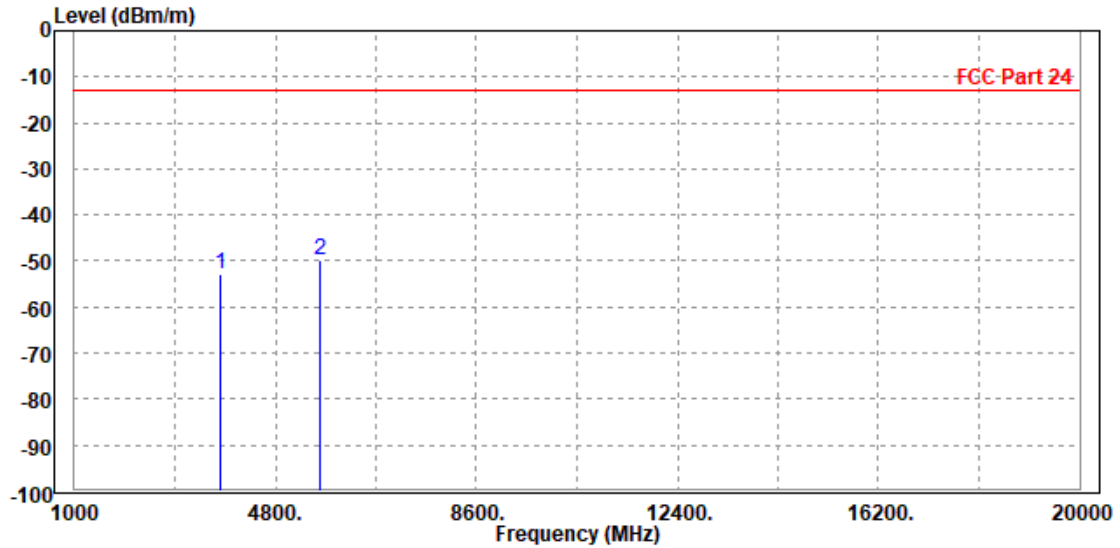



**BUREAU
VERITAS**

Test Report No.: W7L-P22120012RF03

MODE	TX channel 661	FREQUENCY RANGE	Above 1000MHz
ENVIRONMENTAL CONDITIONS	23deg. C, 70%RH	INPUT POWER	AC 120V/60HZ
TESTED BY	Jace Hu		
ANTENNA POLARITY & TEST DISTANCE: VERTICAL AT 3 M			

	Freq	Level	Read Level	Limit Line	Over Limit	Factor	Remark	Pol/Phase
	MHz	dBm/m	dBm	dBm/m	dB	dB/m		
1	3760.000	-52.73	-60.43	-13.00	-39.73	7.70	Peak	Vertical
2 PP	5636.000	-50.51	-61.63	-13.00	-37.51	11.12	Peak	Vertical

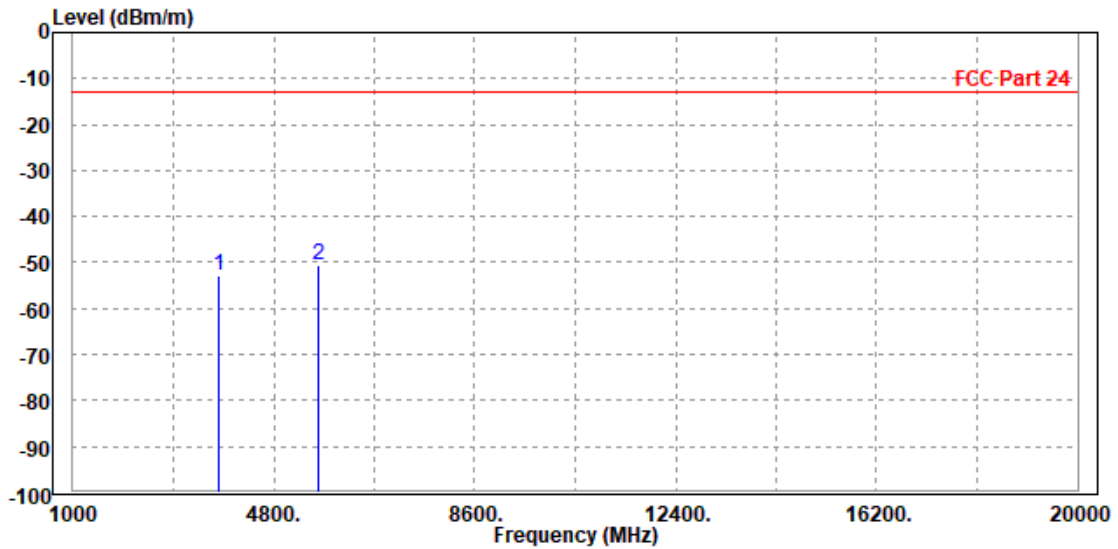



**BUREAU
VERITAS**

Test Report No.: W7L-P22120012RF03

CH 810

MODE	TX channel 810	FREQUENCY RANGE	Above 1000MHz
ENVIRONMENTAL CONDITIONS	23deg. C, 70%RH	INPUT POWER	AC 120V/60HZ
TESTED BY	Jace Hu		
ANTENNA POLARITY & TEST DISTANCE: HORIZONTAL AT 3 M			

	Freq	Level	Read Level	Limit Line	Over Limit	Factor	Remark	Pol/Phase
	MHz	dBm/m	dBm	dBm/m	dB	dB/m		
1	3812.000	-52.84	-60.96	-13.00	-39.84	8.12	Peak	Horizontal
2 PP	5729.400	-48.90	-59.81	-13.00	-35.90	10.91	Peak	Horizontal

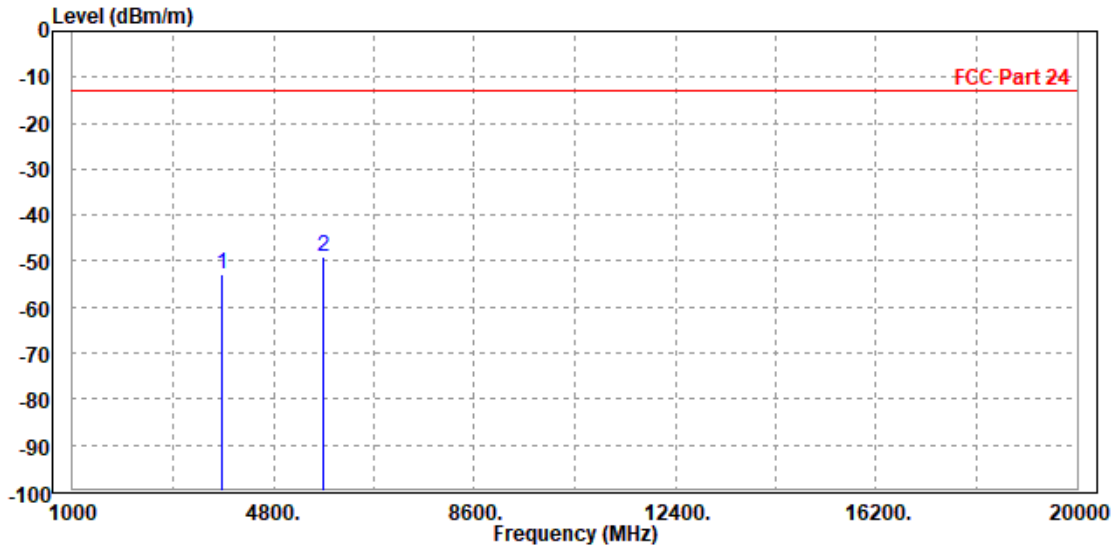



**BUREAU
VERITAS**

Test Report No.: W7L-P22120012RF03

MODE	TX channel 810	FREQUENCY RANGE	Above 1000MHz
ENVIRONMENTAL CONDITIONS	23deg. C, 70%RH	INPUT POWER	AC 120V/60HZ
TESTED BY	Jace Hu		
ANTENNA POLARITY & TEST DISTANCE: VERTICAL AT 3 M			

	Freq	Level	Read Level	Limit Line	Over Limit	Factor	Remark	Pol/Phase
	MHz	dBm/m	dBm	dBm/m	dB	dB/m		
1	3819.600	-52.23	-60.01	-13.00	-39.23	7.78	Peak	Vertical
2 PP	5731.000	-49.14	-60.53	-13.00	-36.14	11.39	Peak	Vertical

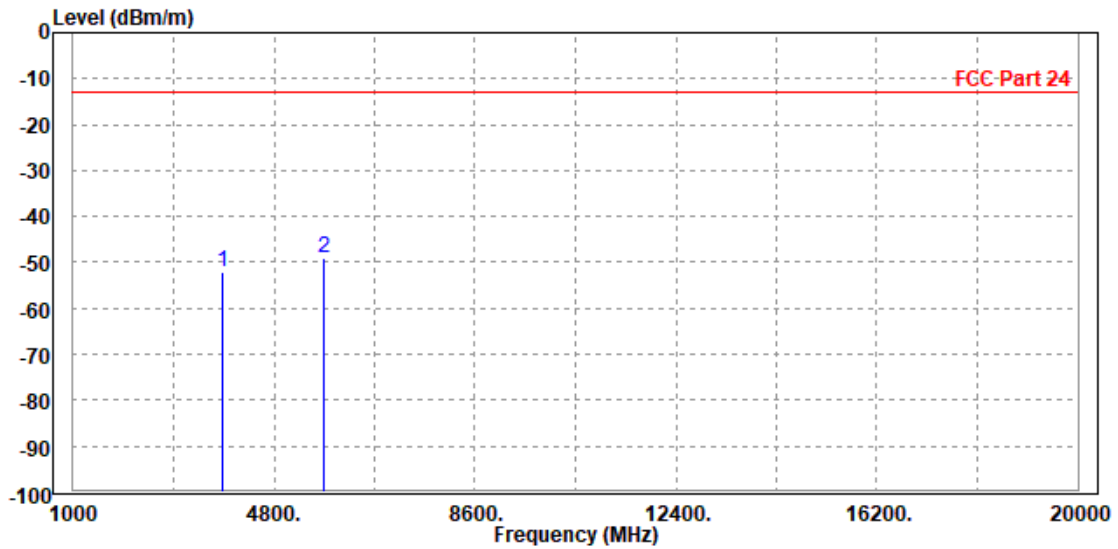



**BUREAU
VERITAS**

Test Report No.: W7L-P22120012RF03

WCDMA Band II

CH 9262

MODE	TX channel 9262	FREQUENCY RANGE	Above 1000MHz
ENVIRONMENTAL CONDITIONS	23deg. C, 70%RH	INPUT POWER	AC 120V/60HZ
TESTED BY	Jace Hu		
ANTENNA POLARITY & TEST DISTANCE: HORIZONTAL AT 3 M			

	Freq	Level	Read Level	Limit Line	Over Limit	Factor	Remark	Pol/Phase
	MHz	dBm/m	dBm	dBm/m	dB	dB/m		
1	PP 3698.000	-50.60	-58.43	-13.00	-37.60	7.83	Peak	Horizontal
2	5557.200	-51.02	-61.60	-13.00	-38.02	10.58	Peak	Horizontal

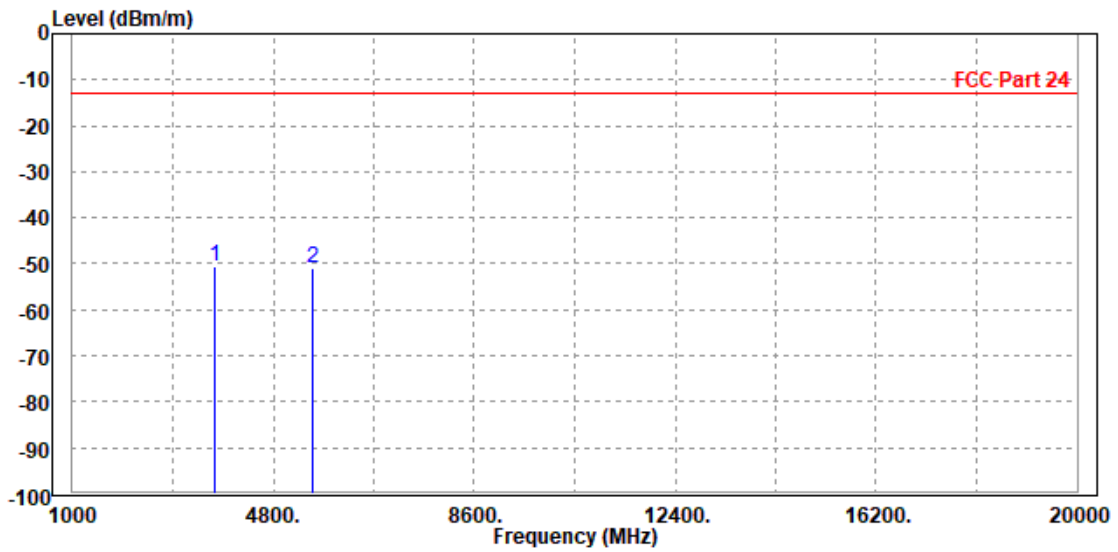



**BUREAU
VERITAS**

Test Report No.: W7L-P22120012RF03

MODE	TX channel 9262	FREQUENCY RANGE	Above 1000MHz
ENVIRONMENTAL CONDITIONS	23deg. C, 70%RH	INPUT POWER	AC 120V/60HZ
TESTED BY	Jace Hu		
ANTENNA POLARITY & TEST DISTANCE: VERTICAL AT 3 M			

	Freq	Level	Read Level	Limit Line	Over Limit	Factor	Remark	Pol/Phase
	MHz	dBm/m	dBm	dBm/m	dB	dB/m		
1	3704.800	-51.53	-59.15	-13.00	-38.53	7.62	Peak	Vertical
2	PP 5560.000	-51.14	-62.04	-13.00	-38.14	10.90	Peak	Vertical

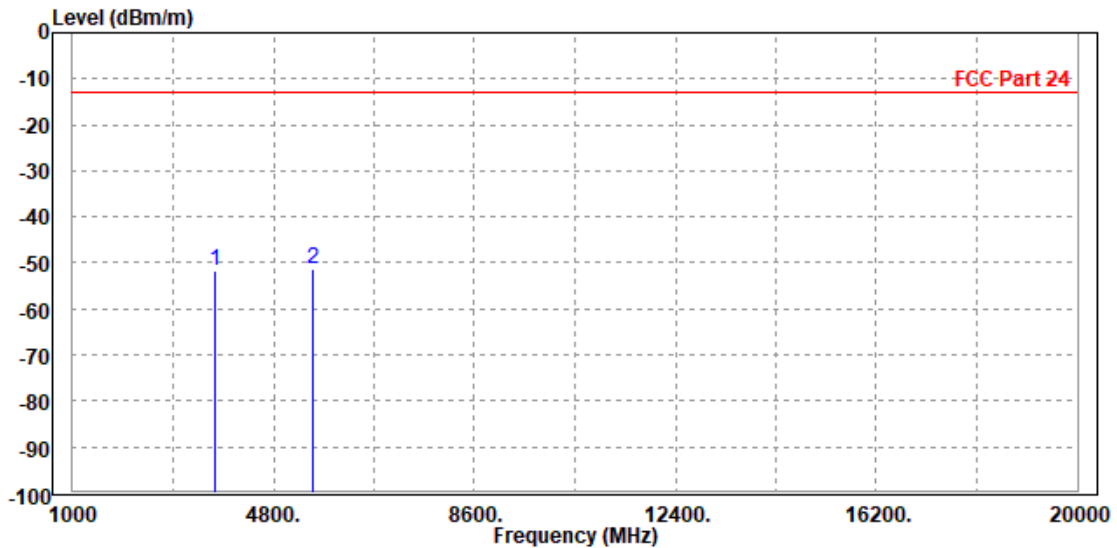



**BUREAU
VERITAS**

Test Report No.: W7L-P22120012RF03

CH 9400

MODE	TX channel 9400	FREQUENCY RANGE	Above 1000MHz
ENVIRONMENTAL CONDITIONS	23deg. C, 70%RH	INPUT POWER	AC 120V/60HZ
TESTED BY	Jace Hu		
ANTENNA POLARITY & TEST DISTANCE: HORIZONTAL AT 3 M			

	Freq	Level	Read Level	Limit Line	Over Limit	Factor	Remark	Pol/Phase
	MHz	dBm/m	dBm	dBm/m	dB	dB/m		
1	3760.000	-49.70	-57.69	-13.00	-36.70	7.99	Peak	Horizontal
2	PP 5636.000	-48.85	-59.58	-13.00	-35.85	10.73	Peak	Horizontal

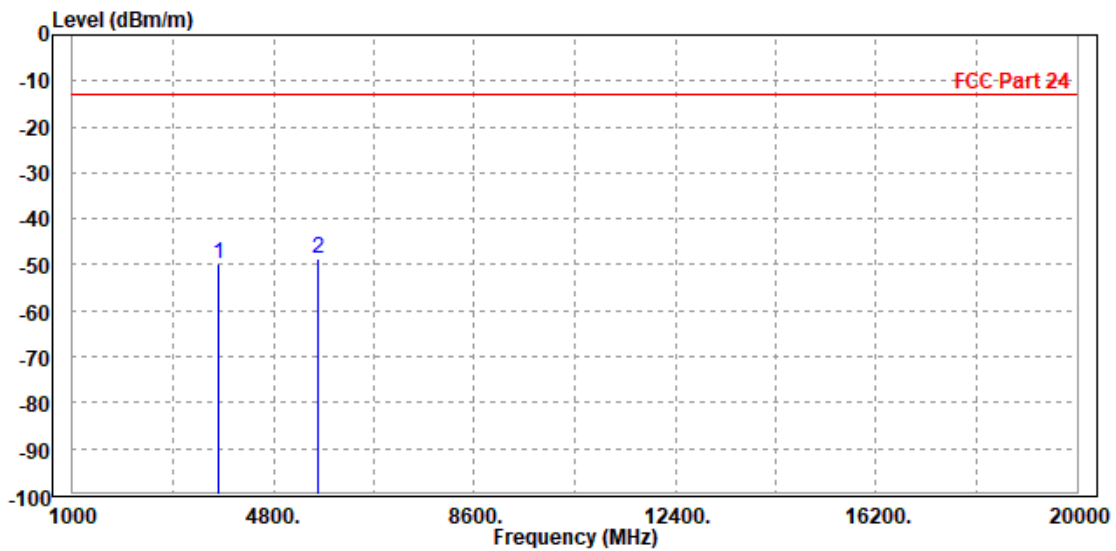



**BUREAU
VERITAS**

Test Report No.: W7L-P22120012RF03

MODE	TX channel 9400	FREQUENCY RANGE	Above 1000MHz
ENVIRONMENTAL CONDITIONS	23deg. C, 70%RH	INPUT POWER	AC 120V/60HZ
TESTED BY	Jace Hu		
ANTENNA POLARITY & TEST DISTANCE: VERTICAL AT 3 M			

	Freq	Level	Read Level	Limit Line	Over Limit	Factor	Remark	Pol/Phase
	MHz	dBm/m	dBm	dBm/m	dB	dB/m		
1	3755.000	-49.48	-57.17	-13.00	-36.48	7.69	Peak	Vertical
2 PP	5640.000	-47.99	-59.12	-13.00	-34.99	11.13	Peak	Vertical

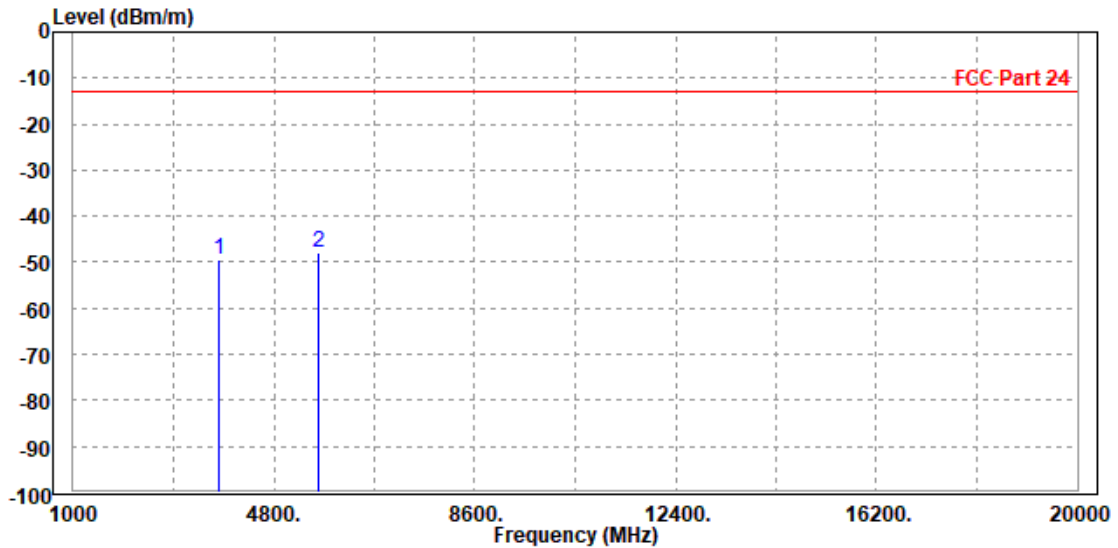



**BUREAU
VERITAS**

Test Report No.: W7L-P22120012RF03

CH 9538

MODE	TX channel 9538	FREQUENCY RANGE	Above 1000MHz
ENVIRONMENTAL CONDITIONS	23deg. C, 70%RH	INPUT POWER	AC 120V/60HZ
TESTED BY	Jace Hu		
ANTENNA POLARITY & TEST DISTANCE: HORIZONTAL AT 3 M			

	Freq	Level	Read Level	Limit Line	Over Limit	Factor	Remark	Pol/Phase
	MHz	dBm/m	dBm	dBm/m	dB	dB/m		
1	3815.200	-49.33	-57.46	-13.00	-36.33	8.13	Peak	Horizontal
2 PP	5731.000	-47.63	-58.54	-13.00	-34.63	10.91	Peak	Horizontal

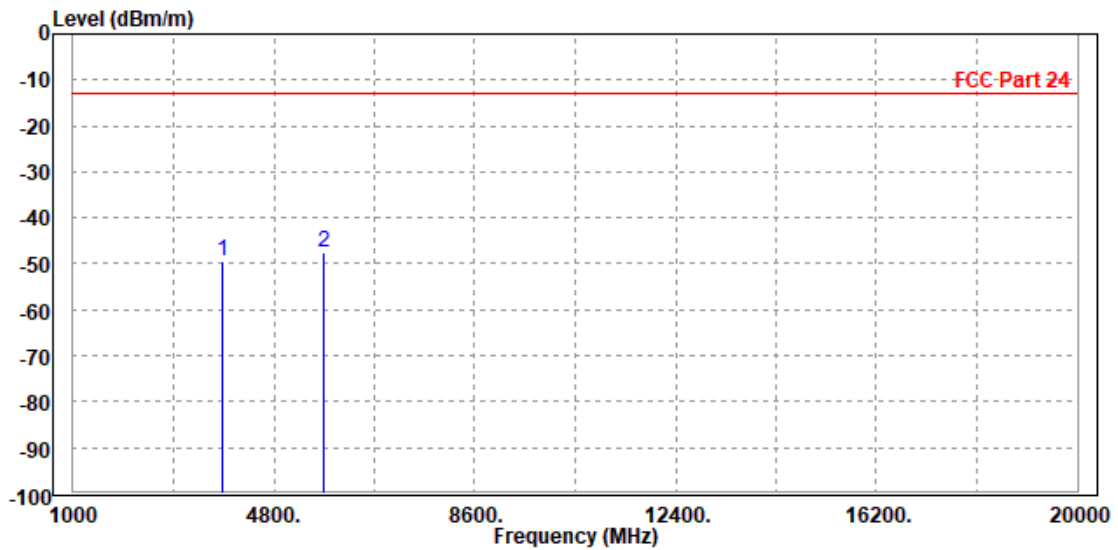



**BUREAU
VERITAS**

Test Report No.: W7L-P22120012RF03

MODE	TX channel 9538	FREQUENCY RANGE	Above 1000MHz
ENVIRONMENTAL CONDITIONS	23deg. C, 70%RH	INPUT POWER	AC 120V/60HZ
TESTED BY	Jace Hu		
ANTENNA POLARITY & TEST DISTANCE: VERTICAL AT 3 M			

	Read	Limit	Over				
Freq	Level	Level	Line	Limit	Factor	Remark	Pol/Phase
MHz	dBm/m	dBm	dBm/m	dB	dB/m		
1	3812.000	-49.78	-57.55	-13.00	-36.78	7.77 Peak	Vertical
2 PP	5722.800	-48.44	-59.80	-13.00	-35.44	11.36 Peak	Vertical

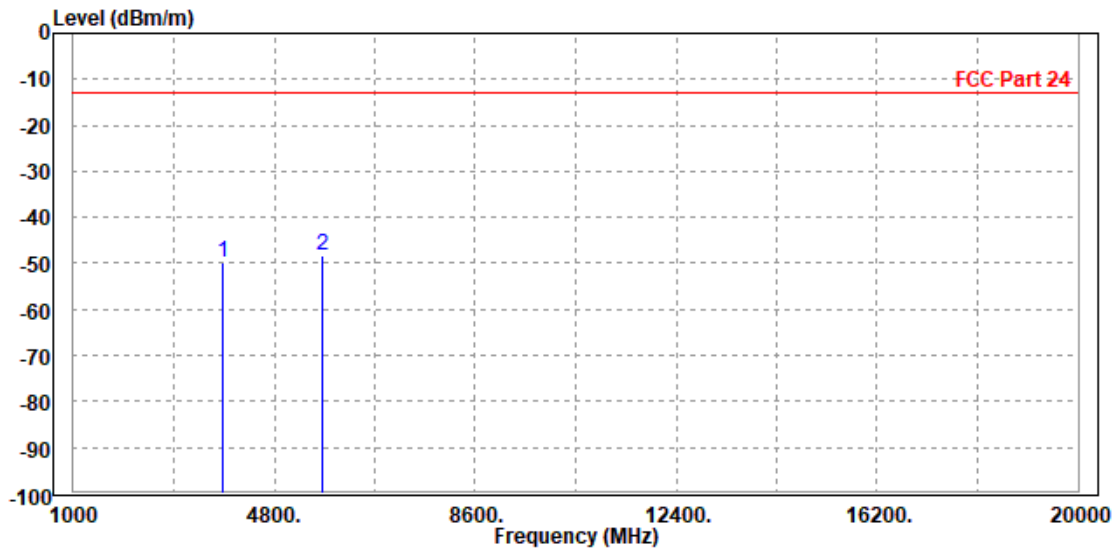



Test Report No.: W7L-P22120012RF03

LTE Band 2

CHANNEL BANDWIDTH: 1.4MHz / QPSK

MODE	TX channel 18900	FREQUENCY RANGE	Above 1000MHz
ENVIRONMENTAL CONDITIONS	23deg. C, 70%RH	INPUT POWER	AC 120V/60Hz
TESTED BY	Jace Hu		
ANTENNA POLARITY & TEST DISTANCE: HORIZONTAL AT 3 M			

	Freq	Level	Read Level	Limit Line	Over Limit	Factor	Remark	Pol/Phase
	MHz	dBm/m	dBm	dBm/m	dB	dB/m		
1	PP 3760.000	-52.00	-59.99	-13.00	-39.00	7.99	Peak	Horizontal
2	5636.000	-52.44	-63.17	-13.00	-39.44	10.73	Peak	Horizontal

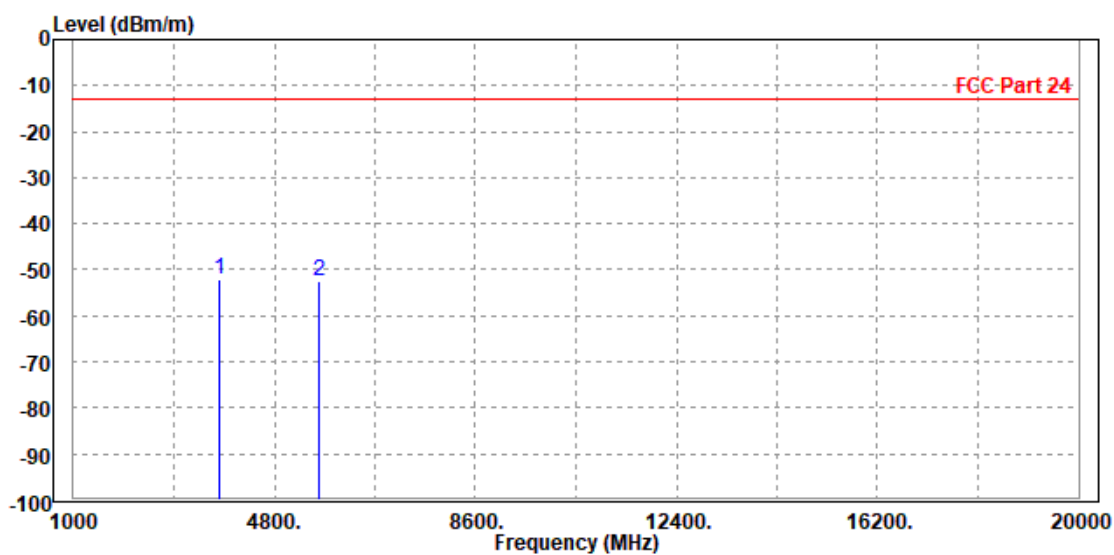



**BUREAU
VERITAS**

Test Report No.: W7L-P22120012RF03

MODE	TX channel 18900	FREQUENCY RANGE	Above 1000MHz
ENVIRONMENTAL CONDITIONS	23deg. C, 70%RH	INPUT POWER	AC 120V/60Hz
TESTED BY	Jace Hu		
ANTENNA POLARITY & TEST DISTANCE: VERTICAL AT 3 M			

	Freq	Level	Read Level	Limit Line	Over Limit	Factor	Remark	Pol/Phase
	MHz	dBm/m	dBm	dBm/m	dB	dB/m		
1	3755.000	-52.62	-60.31	-13.00	-39.62	7.69	Peak	Vertical
2 PP	5640.000	-49.70	-60.83	-13.00	-36.70	11.13	Peak	Vertical

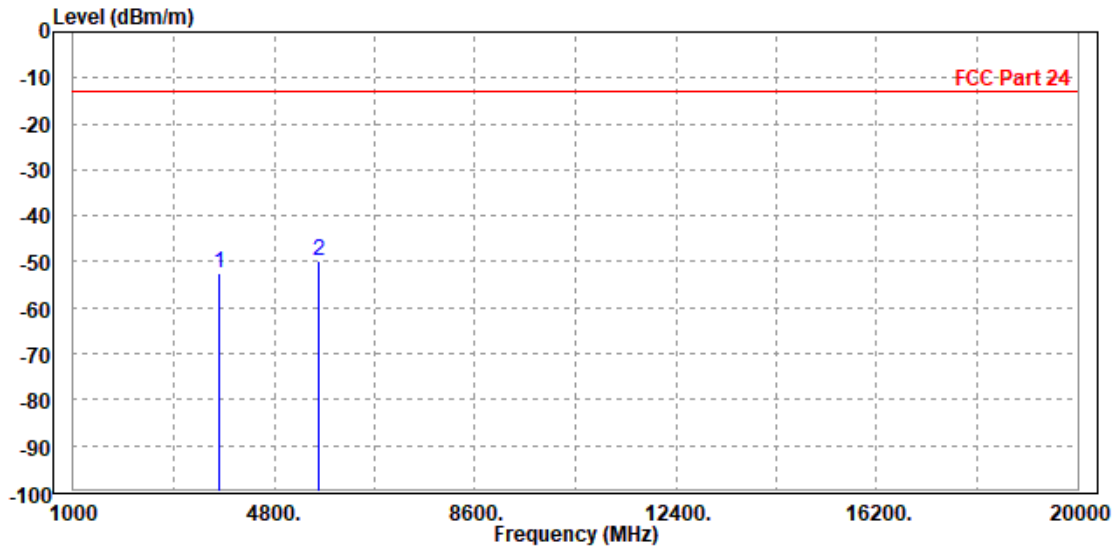



BUREAU VERITAS

Test Report No.: W7L-P22120012RF03

CHANNEL BANDWIDTH: 3MHz / QPSK

MODE	TX channel 18900	FREQUENCY RANGE	Above 1000MHz
ENVIRONMENTAL CONDITIONS	23deg. C, 70%RH	INPUT POWER	AC 120V/60Hz
TESTED BY	Jace Hu		
ANTENNA POLARITY & TEST DISTANCE: HORIZONTAL AT 3 M			

	Freq	Level	Read Level	Limit Line	Over Limit	Factor	Remark	Pol/Phase
	MHz	dBm/m	dBm	dBm/m	dB	dB/m		
1	3755.000	-52.35	-60.33	-13.00	-39.35	7.98	Peak	Horizontal
2	PP 5640.000	-51.60	-62.34	-13.00	-38.60	10.74	Peak	Horizontal

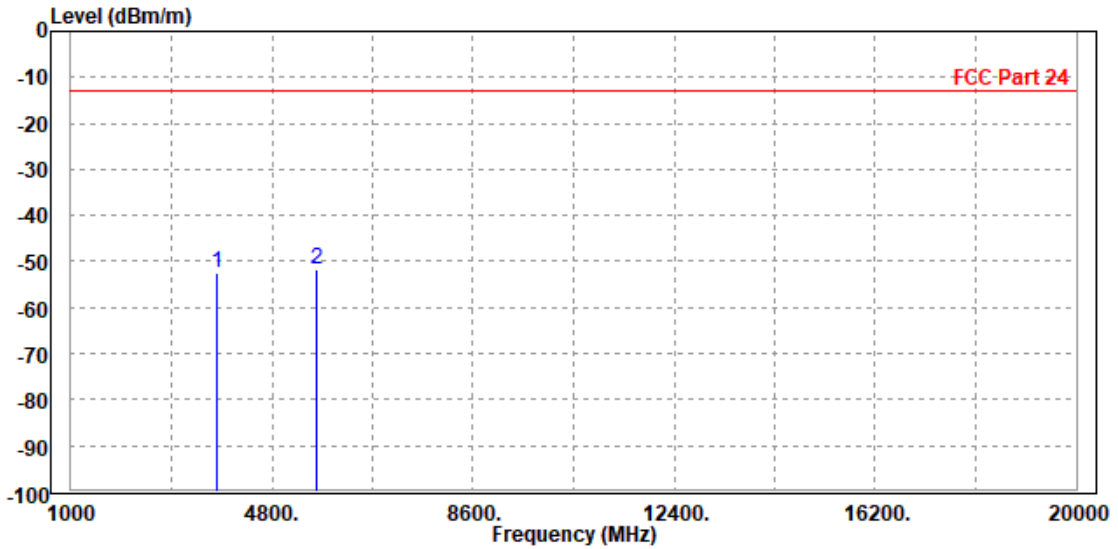



**BUREAU
VERITAS**

Test Report No.: W7L-P22120012RF03

MODE	TX channel 18900	FREQUENCY RANGE	Above 1000MHz
ENVIRONMENTAL CONDITIONS	23deg. C, 70%RH	INPUT POWER	AC 120V/60Hz
TESTED BY	Jace Hu		
ANTENNA POLARITY & TEST DISTANCE: VERTICAL AT 3 M			

	Freq	Level	Read Level	Limit Line	Over Limit	Factor	Remark	Pol/Phase
	MHz	dBm/m	dBm	dBm/m	dB	dB/m		
1	3760.000	-52.88	-60.58	-13.00	-39.88	7.70	Peak	Vertical
2	PP 5636.000	-50.50	-61.62	-13.00	-37.50	11.12	Peak	Vertical

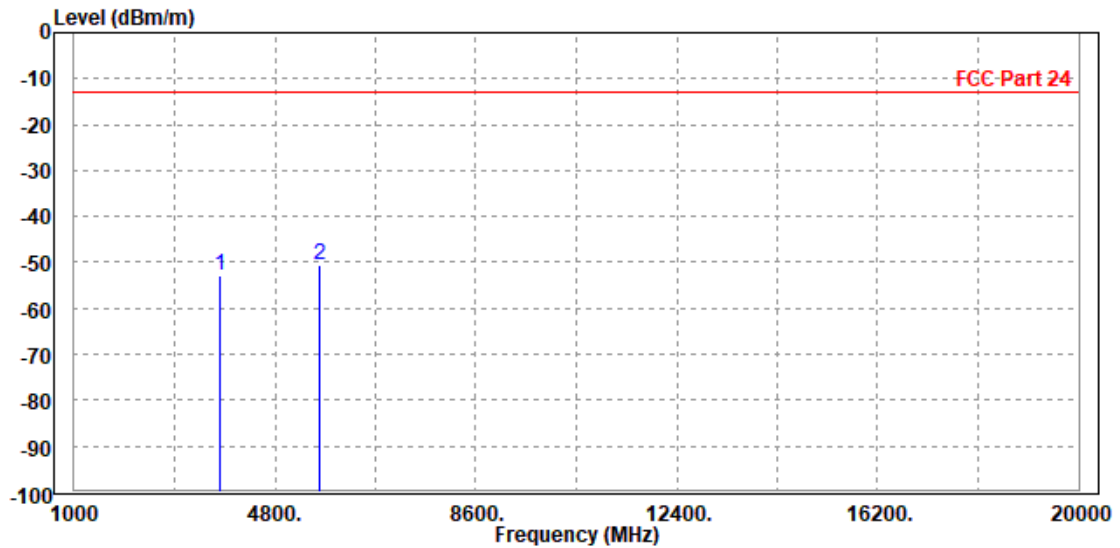



BUREAU VERITAS

Test Report No.: W7L-P22120012RF03

CHANNEL BANDWIDTH: 5MHz / QPSK

CH18900

MODE	TX channel 18900	FREQUENCY RANGE	Above 1000MHz
ENVIRONMENTAL CONDITIONS	23deg. C, 70%RH	INPUT POWER	AC 120V/60Hz
TESTED BY	Jace Hu		
ANTENNA POLARITY & TEST DISTANCE: HORIZONTAL AT 3 M			

	Freq	Level	Read Level	Limit Line	Over Limit	Factor	Remark	Pol/Phase
	MHz	dBm/m	dBm	dBm/m	dB	dB/m		
1	3760.000	-52.01	-60.00	-13.00	-39.01	7.99	Peak	Horizontal
2 PP	5636.000	-50.53	-61.26	-13.00	-37.53	10.73	Peak	Horizontal

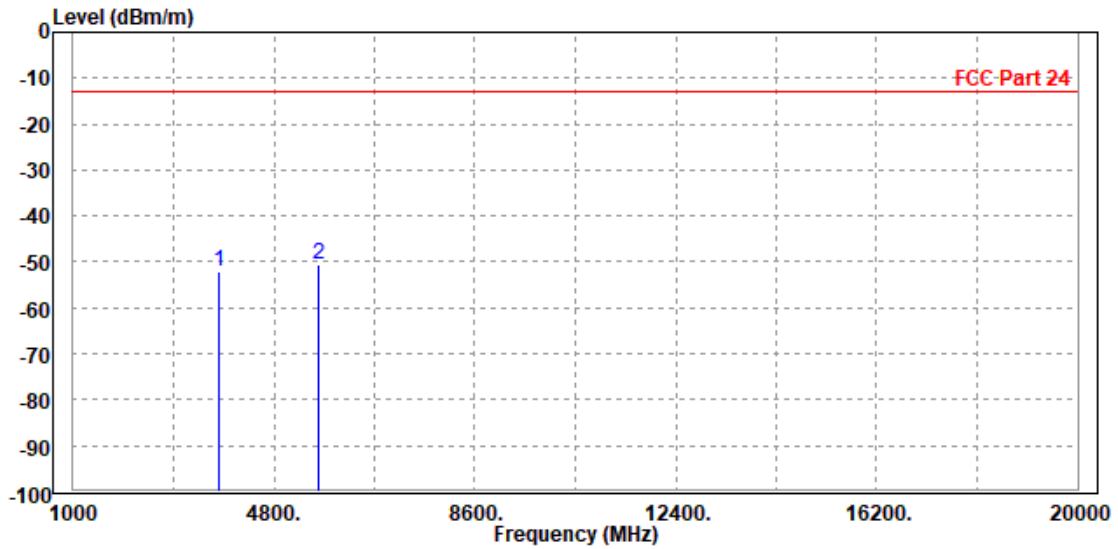



**BUREAU
VERITAS**

Test Report No.: W7L-P22120012RF03

MODE	TX channel 18900	FREQUENCY RANGE	Above 1000MHz
ENVIRONMENTAL CONDITIONS	23deg. C, 70%RH	INPUT POWER	AC 120V/60Hz
TESTED BY	Jace Hu		
ANTENNA POLARITY & TEST DISTANCE: VERTICAL AT 3 M			

	Freq	Level	Read Level	Limit Line	Over Limit	Factor	Remark	Pol/Phase
	MHz	dBm/m	dBm	dBm/m	dB	dB/m		
1	3755.000	-52.39	-60.08	-13.00	-39.39	7.69	Peak	Vertical
2 PP	5640.000	-51.37	-62.50	-13.00	-38.37	11.13	Peak	Vertical

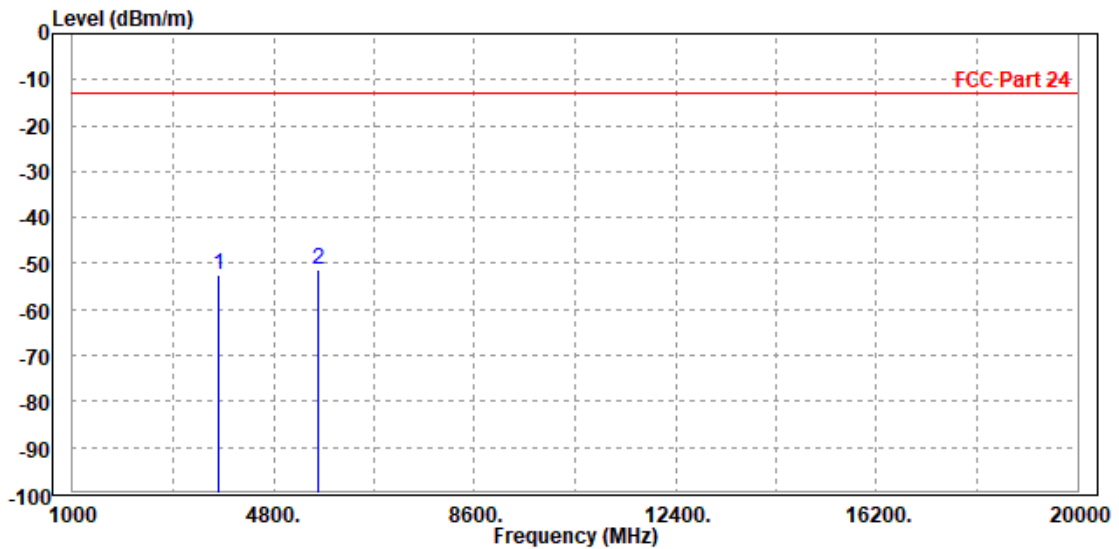



BUREAU VERITAS

Test Report No.: W7L-P22120012RF03

CHANNEL BANDWIDTH: 10MHz / QPSK

CH18650

MODE	TX channel 18650	FREQUENCY RANGE	Above 1000MHz
ENVIRONMENTAL CONDITIONS	23deg. C, 70%RH	INPUT POWER	AC 120V/60Hz
TESTED BY	Jace Hu		
ANTENNA POLARITY & TEST DISTANCE: HORIZONTAL AT 3 M			

	Freq	Level	Read Level	Limit Line	Over Limit	Factor	Remark	Pol/Phase
	MHz	dBm/m	dBm	dBm/m	dB	dB/m		
1	3717.000	-51.82	-59.70	-13.00	-38.82	7.88	Peak	Horizontal
2 PP	5565.000	-51.41	-62.01	-13.00	-38.41	10.60	Peak	Horizontal

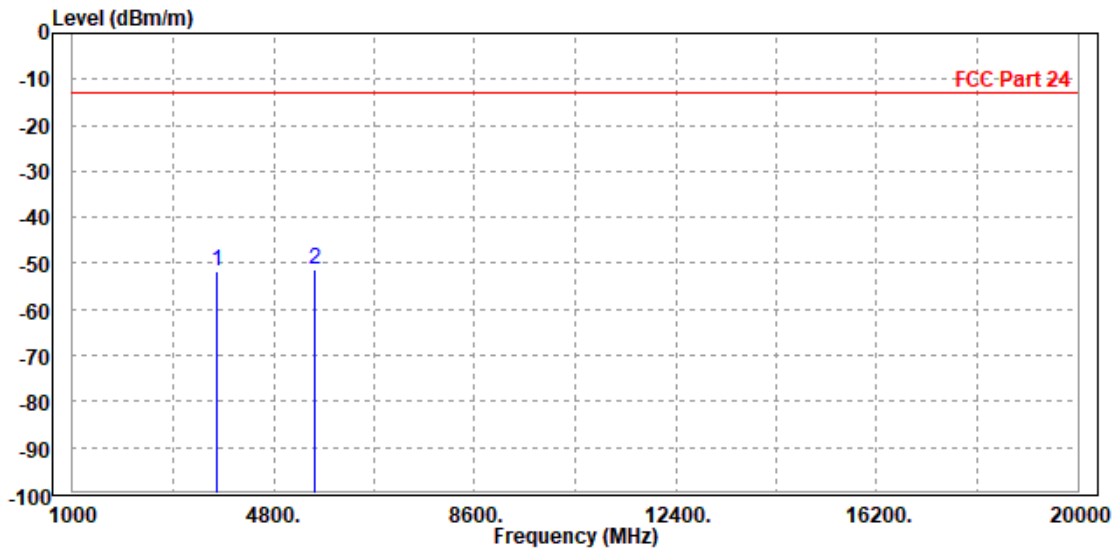



**BUREAU
VERITAS**

Test Report No.: W7L-P22120012RF03

MODE	TX channel 18650	FREQUENCY RANGE	Above 1000MHz
ENVIRONMENTAL CONDITIONS	23deg. C, 70%RH	INPUT POWER	AC 120V/60Hz
TESTED BY	Jace Hu		
ANTENNA POLARITY & TEST DISTANCE: VERTICAL AT 3 M			

	Freq	Level	Read Level	Limit Line	Over Limit	Factor	Remark	Pol/Phase
	MHz	dBm/m	dBm	dBm/m	dB	dB/m		
1	3710.000	-52.87	-60.49	-13.00	-39.87	7.62	Peak	Vertical
2	PP 5560.000	-50.35	-61.25	-13.00	-37.35	10.90	Peak	Vertical

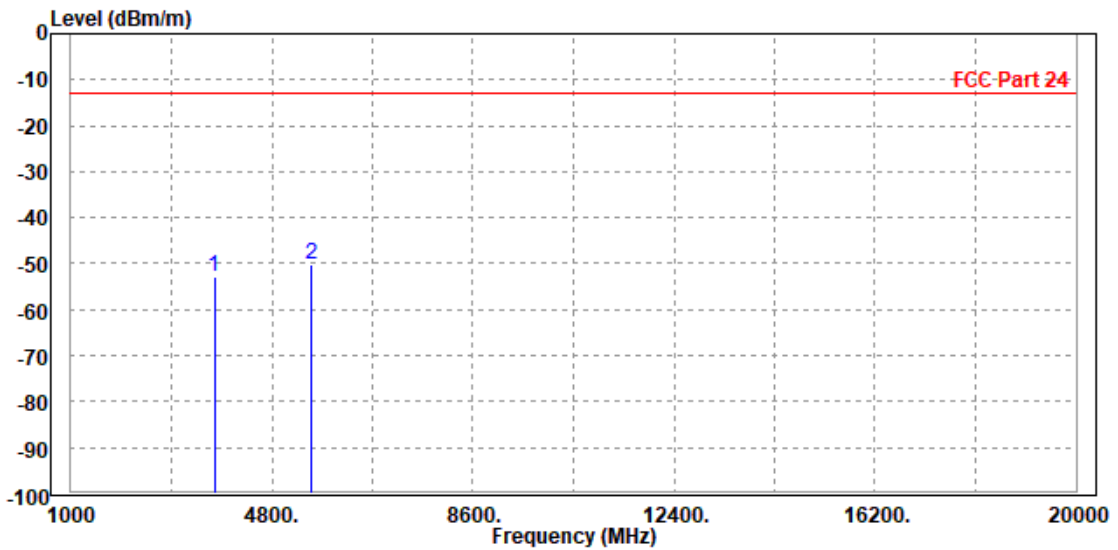



**BUREAU
VERITAS**

Test Report No.: W7L-P22120012RF03

CH18900

MODE	TX channel 18900	FREQUENCY RANGE	Above 1000MHz
ENVIRONMENTAL CONDITIONS	23deg. C, 70%RH	INPUT POWER	AC 120V/60Hz
TESTED BY	Jace Hu		
ANTENNA POLARITY & TEST DISTANCE: HORIZONTAL AT 3 M			

	Freq	Level	Read Level	Limit Line	Over Limit	Factor	Remark	Pol/Phase
	MHz	dBm/m	dBm	dBm/m	dB	dB/m		
1 PP	3760.000	-47.15	-55.14	-13.00	-34.15	7.99	Peak	Horizontal
2	5636.000	-50.64	-61.37	-13.00	-37.64	10.73	Peak	Horizontal

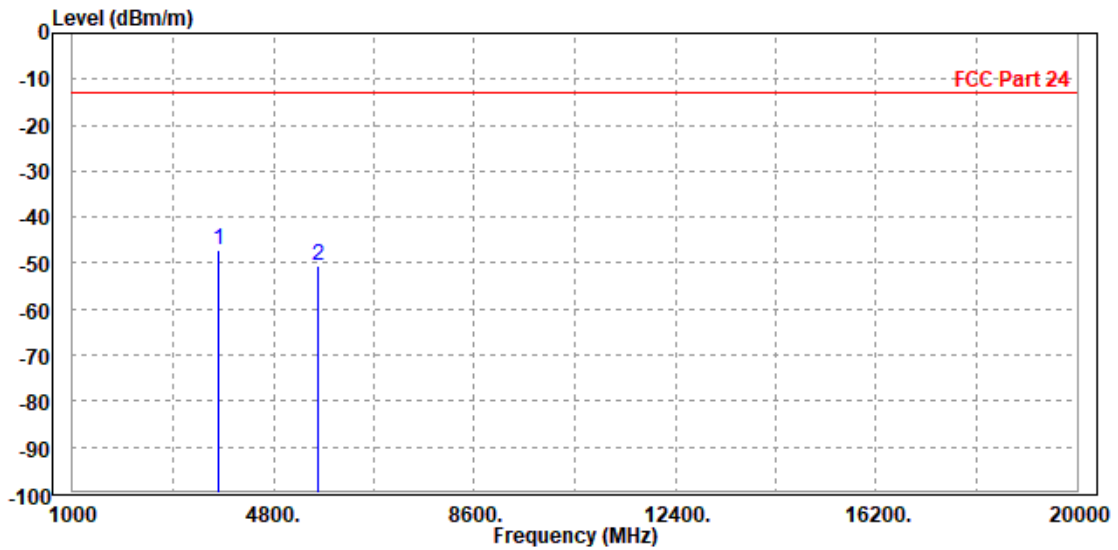



**BUREAU
VERITAS**

Test Report No.: W7L-P22120012RF03

MODE	TX channel 18900	FREQUENCY RANGE	Above 1000MHz
ENVIRONMENTAL CONDITIONS	23deg. C, 70%RH	INPUT POWER	AC 120V/60Hz
TESTED BY	Jace Hu		
ANTENNA POLARITY & TEST DISTANCE: VERTICAL AT 3 M			

	Freq	Level	Read Level	Limit	Over Limit	Factor	Remark	Pol/Phase
	MHz	dBm/m	dBm	dBm/m	dB	dB/m		
1	PP 3755.000	-48.98	-56.67	-13.00	-35.98	7.69	Peak	Vertical
2	5640.000	-49.10	-60.23	-13.00	-36.10	11.13	Peak	Vertical

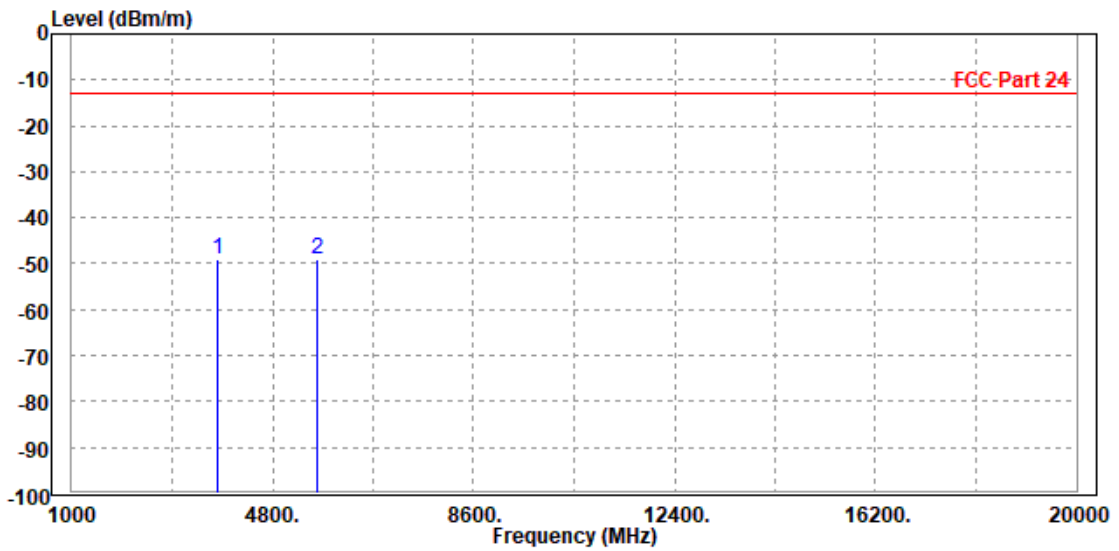



**BUREAU
VERITAS**

Test Report No.: W7L-P22120012RF03

CH19150

MODE	TX channel 19150	FREQUENCY RANGE	Above 1000MHz
ENVIRONMENTAL CONDITIONS	23deg. C, 70%RH	INPUT POWER	AC 120V/60Hz
TESTED BY	Jace Hu		
ANTENNA POLARITY & TEST DISTANCE: HORIZONTAL AT 3 M			

	Freq	Level	Read Level	Limit Line	Over Limit	Factor	Remark	Pol/Phase
	MHz	dBm/m	dBm	dBm/m	dB	dB/m		
1	3810.000	-51.77	-59.89	-13.00	-38.77	8.12	Peak	Horizontal
2 PP	5712.000	-50.09	-60.97	-13.00	-37.09	10.88	Peak	Horizontal

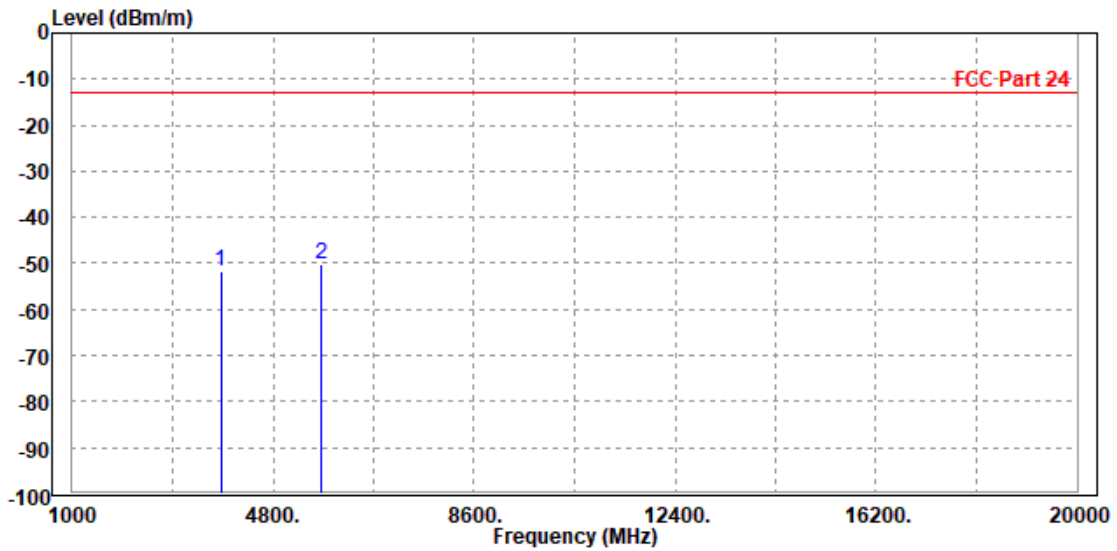



**BUREAU
VERITAS**

Test Report No.: W7L-P22120012RF03

MODE	TX channel 19150	FREQUENCY RANGE	Above 1000MHz
ENVIRONMENTAL CONDITIONS	23deg. C, 70%RH	INPUT POWER	AC 120V/60Hz
TESTED BY	Jace Hu		
ANTENNA POLARITY & TEST DISTANCE: VERTICAL AT 3 M			

	Freq	Level	Read Level	Limit Line	Over Limit	Factor	Remark	Pol/Phase
	MHz	dBm/m	dBm	dBm/m	dB	dB/m		
1	3812.000	-51.33	-59.10	-13.00	-38.33	7.77	Peak	Vertical
2 PP	5715.000	-49.89	-61.23	-13.00	-36.89	11.34	Peak	Vertical

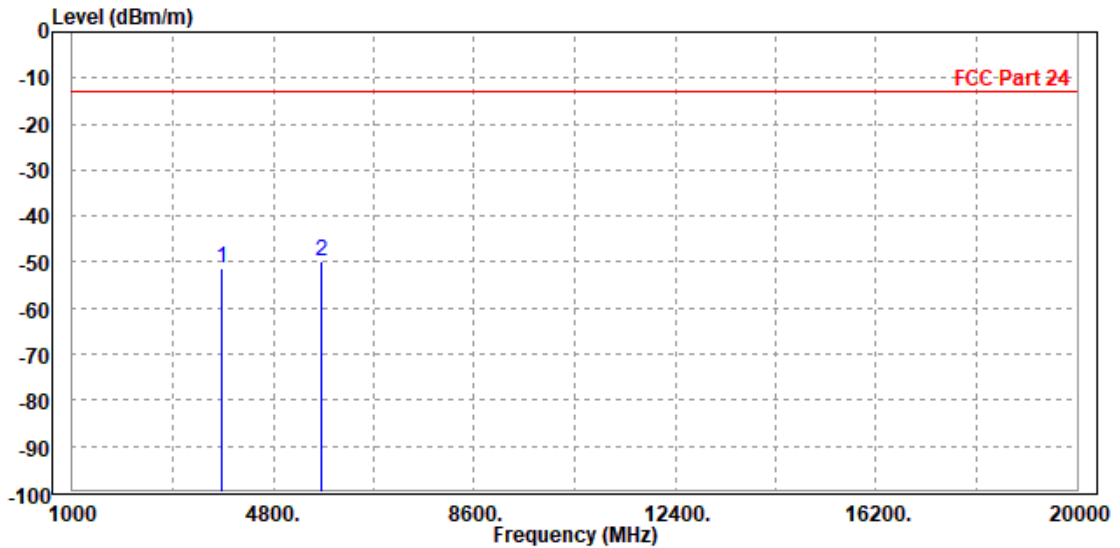



**BUREAU
VERITAS**

Test Report No.: W7L-P22120012RF03

CHANNEL BANDWIDTH: 15MHz / QPSK

MODE	TX channel 18900	FREQUENCY RANGE	Above 1000MHz
ENVIRONMENTAL CONDITIONS	23deg. C, 70%RH	INPUT POWER	AC 120V/60Hz
TESTED BY	Jace Hu		
ANTENNA POLARITY & TEST DISTANCE: HORIZONTAL AT 3 M			

	Freq	Level	Read Level	Limit Line	Over Limit	Factor	Remark	Pol/Phase
	MHz	dBm/m	dBm	dBm/m	dB	dB/m		
1	3755.000	-52.28	-60.26	-13.00	-39.28	7.98	Peak	Horizontal
2 PP	5640.000	-51.64	-62.38	-13.00	-38.64	10.74	Peak	Horizontal

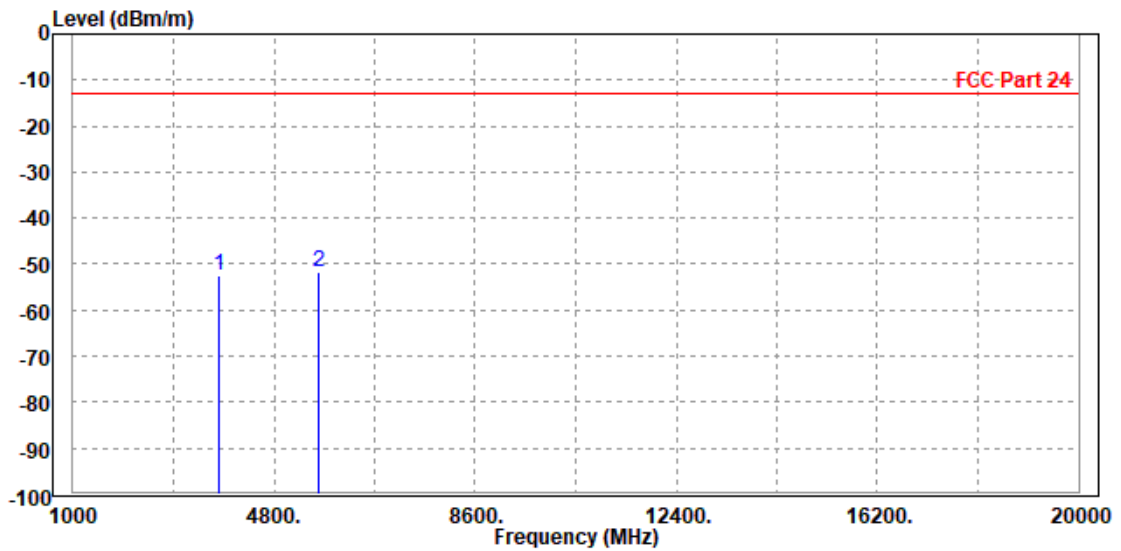



**BUREAU
VERITAS**

Test Report No.: W7L-P22120012RF03

MODE	TX channel 18900	FREQUENCY RANGE	Above 1000MHz
ENVIRONMENTAL CONDITIONS	23deg. C, 70%RH	INPUT POWER	AC 120V/60Hz
TESTED BY	Jace Hu		
ANTENNA POLARITY & TEST DISTANCE: VERTICAL AT 3 M			

	Freq	Level	Read Level	Limit Line	Over Limit	Factor	Remark	Pol/Phase
	MHz	dBm/m	dBm	dBm/m	dB	dB/m		
1	3760.000	-52.93	-60.63	-13.00	-39.93	7.70	Peak	Vertical
2 PP	5636.000	-50.98	-62.10	-13.00	-37.98	11.12	Peak	Vertical

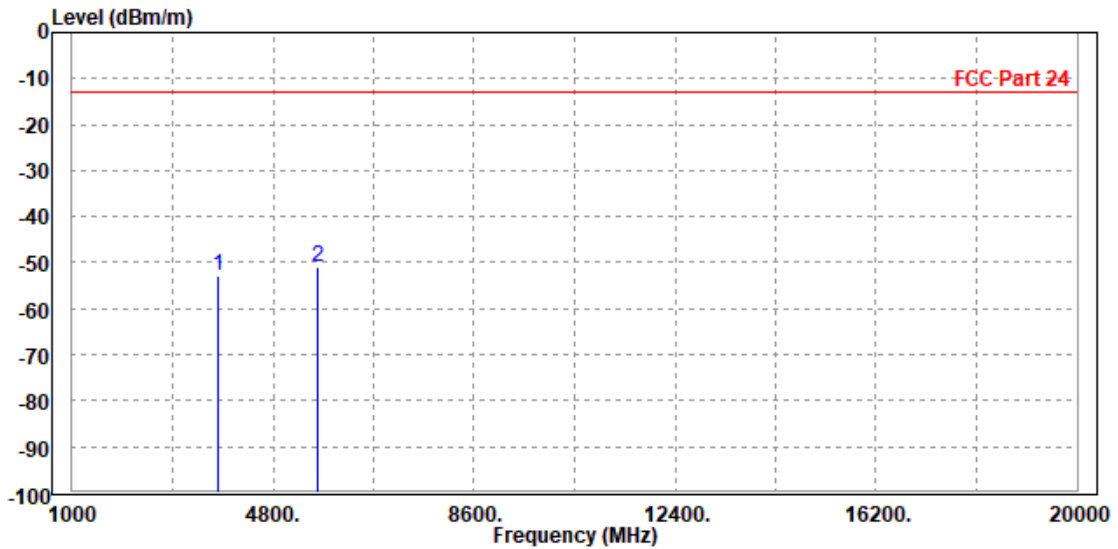



**BUREAU
VERITAS**

Test Report No.: W7L-P22120012RF03

CHANNEL BANDWIDTH: 20MHz / QPSK

MODE	TX channel 18900	FREQUENCY RANGE	Above 1000MHz
ENVIRONMENTAL CONDITIONS	23deg. C, 70%RH	INPUT POWER	AC 120V/60Hz
TESTED BY	Jace Hu		
ANTENNA POLARITY & TEST DISTANCE: HORIZONTAL AT 3 M			

	Freq	Level	Read Level	Limit Line	Over Limit	Factor	Remark	Pol/Phase
	MHz	dBm/m	dBm	dBm/m	dB	dB/m		
1	3760.000	-52.22	-60.21	-13.00	-39.22	7.99	Peak	Horizontal
2 PP	5636.000	-50.23	-60.96	-13.00	-37.23	10.73	Peak	Horizontal

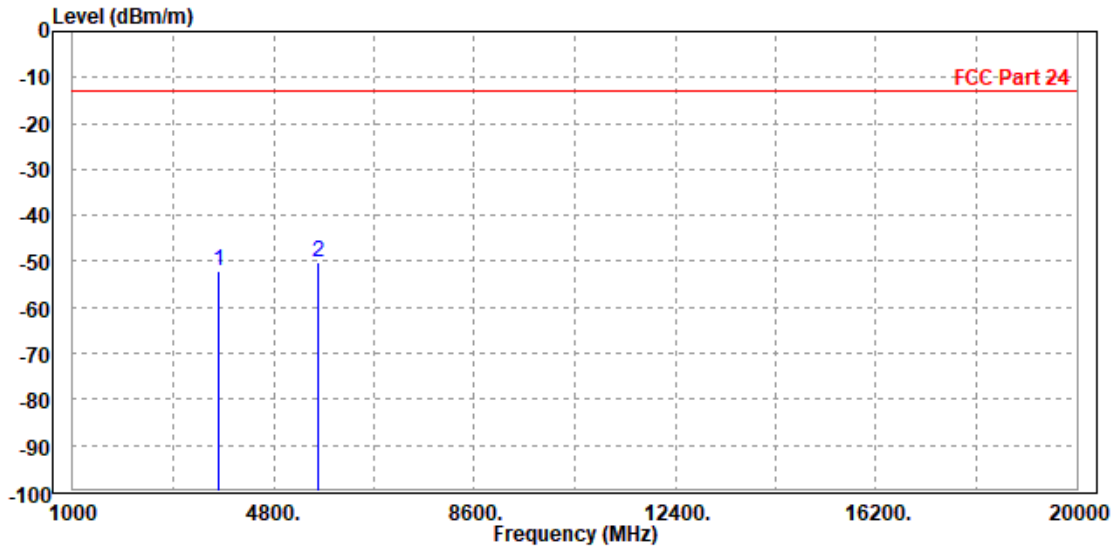



**BUREAU
VERITAS**

Test Report No.: W7L-P22120012RF03

MODE	TX channel 18900	FREQUENCY RANGE	Above 1000MHz
ENVIRONMENTAL CONDITIONS	23deg. C, 70%RH	INPUT POWER	AC 120V/60Hz
TESTED BY	Jace Hu		
ANTENNA POLARITY & TEST DISTANCE: VERTICAL AT 3 M			

	Freq	Read Level	Limit Level	Over Line	Over Limit	Factor	Remark	Pol/Phase
	MHz	dBm/m	dBm	dBm/m	dB	dB/m		
1	3755.000	-52.02	-59.71	-13.00	-39.02	7.69	Peak	Vertical
2 PP	5640.000	-49.80	-60.93	-13.00	-36.80	11.13	Peak	Vertical

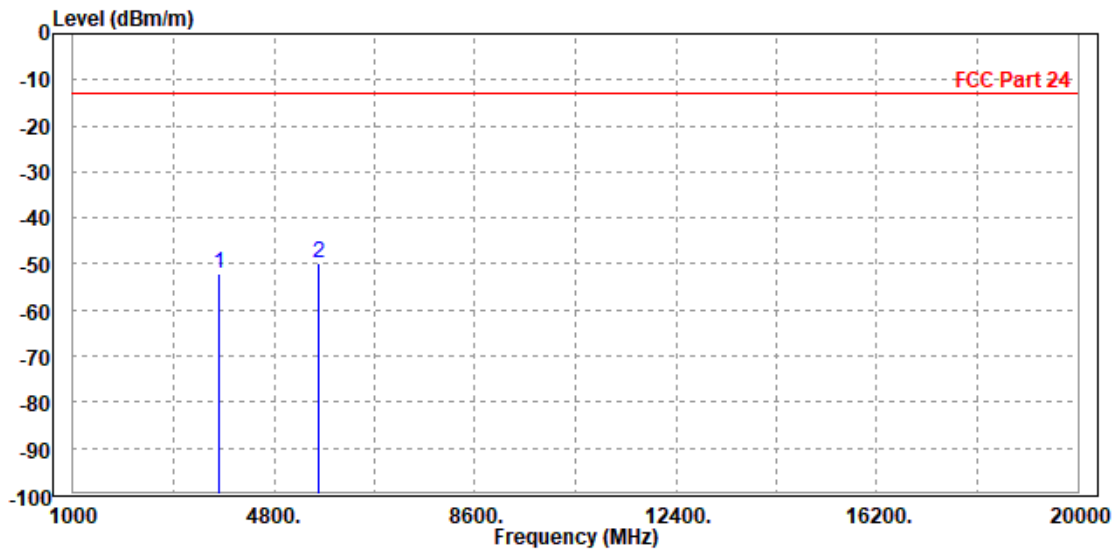



3.7 PEAK TO AVERAGE RATIO

3.7.1 LIMITS OF PEAK TO AVERAGE RATIO MEASUREMENT

In measuring transmissions in this band using an average power technique, the peak to-average ratio (PAR) of the transmission may not exceed 13 dB

3.7.2 TEST SETUP

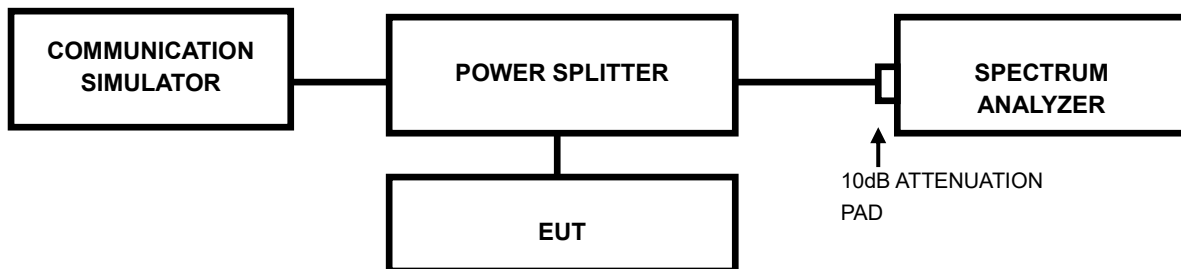

3.7.3 TEST PROCEDURES

1. Set resolution/measurement bandwidth \geq signal's occupied bandwidth;
2. Set the number of counts to a value that stabilizes the measured CCDF curve;
3. Record the maximum PAPR level associated with a probability of 0.1%.



**BUREAU
VERITAS**

Test Report No.: W7L-P22120012RF03

3.7.4 TEST RESULTS

Please Refer to Appendix Of this test report.



**BUREAU
VERITAS**

Test Report No.: W7L-P22120012RF03

4 INFORMATION ON THE TESTING LABORATORIES

We, BV 7LAYERS COMMUNICATIONS TECHNOLOGY (SHENZHEN) CO. LTD., were founded in 2015 to provide our best service in EMC, Radio, Telecom and Safety consultation. Our laboratories are accredited and approved according to ISO/IEC 17025.

If you have any comments, please feel free to contact us at the following:

Shenzhen EMC/RF Lab:

Tel: +86-755-88696566

Fax: +86-755-88696577

Email: customerservice.sw@bureauveritas.com

Web Site: www.adt.com.tw

The address and road map of all our labs can be found in our web site also.



Test Report No.: W7L-P22120012RF03

5 MODIFICATIONS RECORDERS FOR ENGINEERING CHANGES TO THE EUT BY THE LAB

No any modifications are made to the EUT by the lab during the test.



**BUREAU
VERITAS**

Test Report No.: W7L-P22120012RF03

6 Appendix

GSM1900

PEAK-TO-AVERAGE RATIO(CCDF)

Test Result

Band	Channel	Result(dB)	Limit(dB)	Verdict
GSM1900	512	2.63	13	PASS
GSM1900	661	2.63	13	PASS
GSM1900	810	2.62	13	PASS
GPRS1900	512	2.63	13	PASS
GPRS1900	661	2.63	13	PASS
GPRS1900	810	2.62	13	PASS



BUREAU VERITAS

Test Report No.: W7L-P22120012RF03

Test Graphs

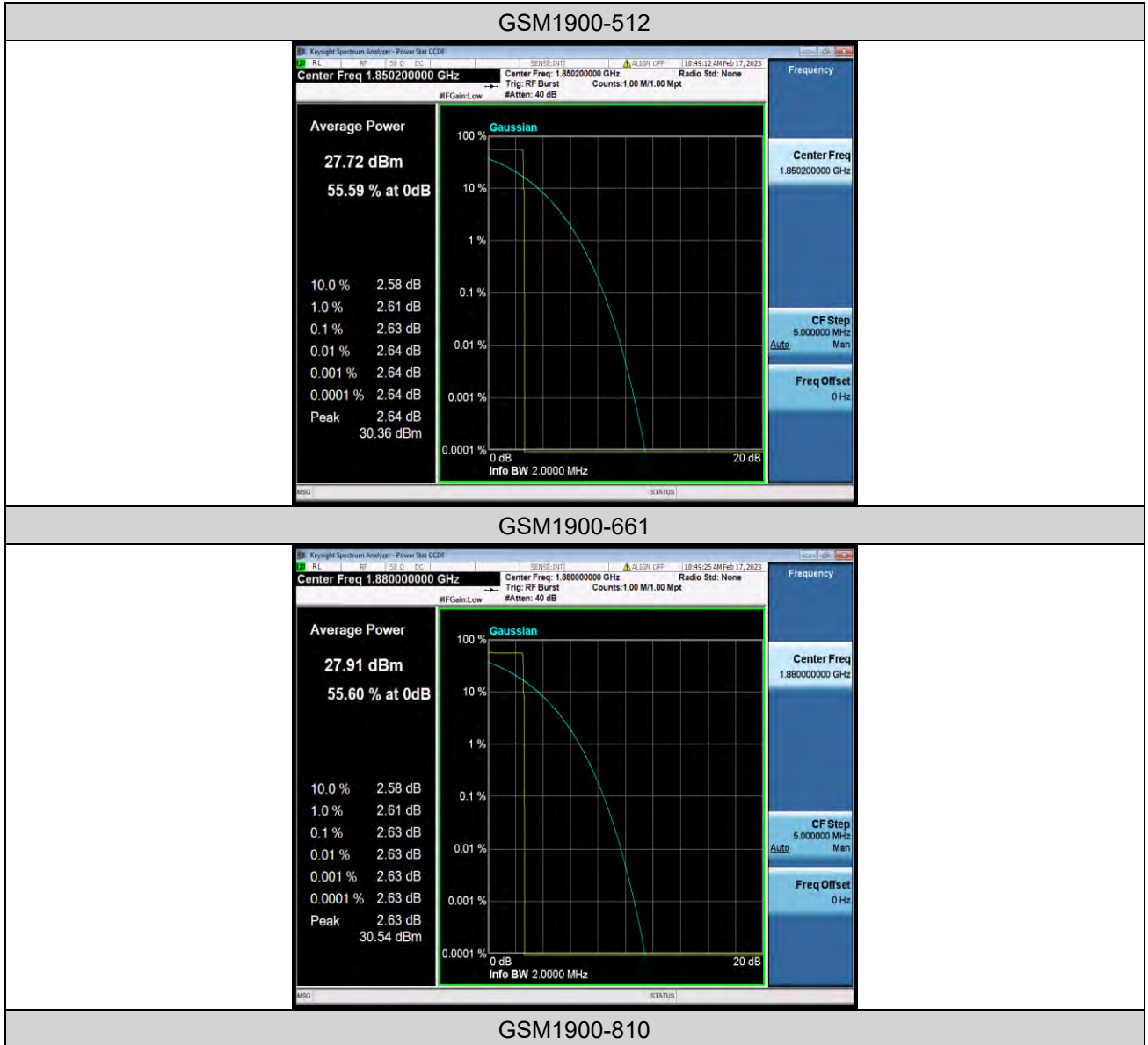



BUREAU VERITAS

Test Report No.: W7L-P22120012RF03

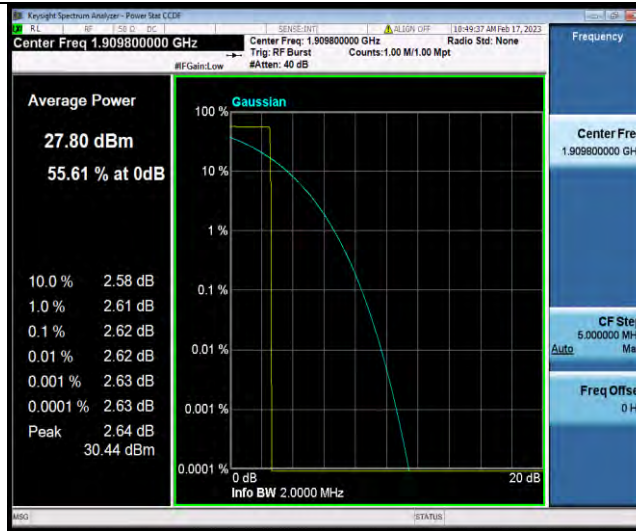

GPRS1900-512

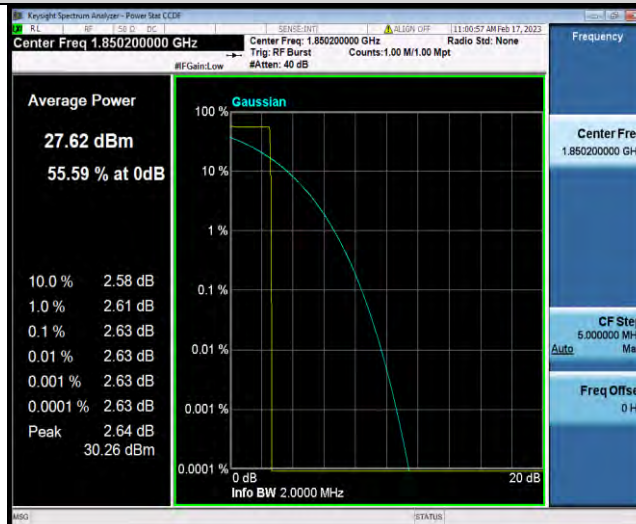

GPRS1900-661

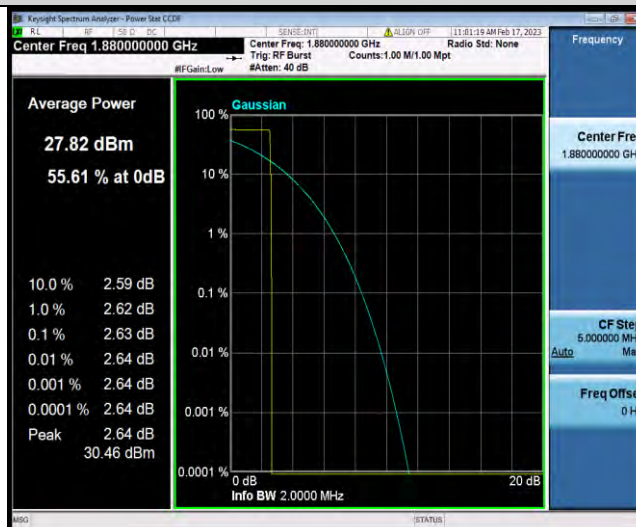

GPRS1900-810



BUREAU
VERITAS

Test Report No.: W7L-P22120012RF03

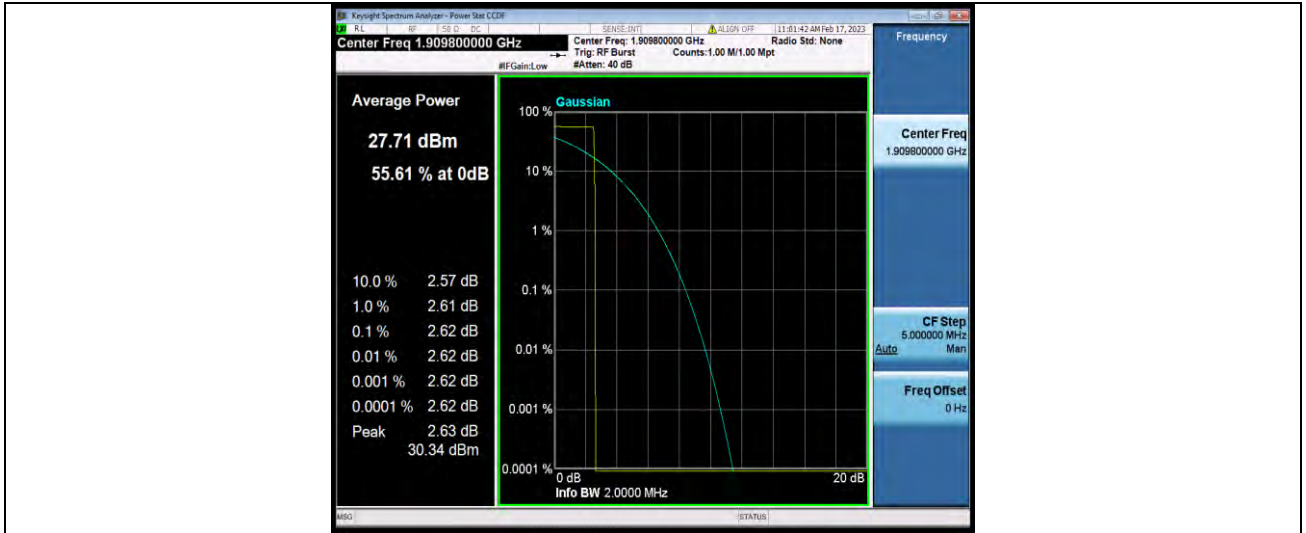



Test Report No.: W7L-P22120012RF03

26DB BANDWIDTH AND OCCUPIED BANDWIDTH

Test Result

Band	Channel	Occupied Bandwidth (MHz)	26dB Bandwidth (MHz)	Limit (MHz)	Verdict
GSM1900	512	0.24267	0.3075	---	PASS
GSM1900	661	0.24263	0.3046	---	PASS
GSM1900	810	0.24531	0.3079	---	PASS
GPRS1900	512	0.24296	0.3129	---	PASS
GPRS1900	661	0.23932	0.3093	---	PASS
GPRS1900	810	0.24581	0.3126	---	PASS



BUREAU
VERITAS

Test Report No.: W7L-P22120012RF03

Test Graphs

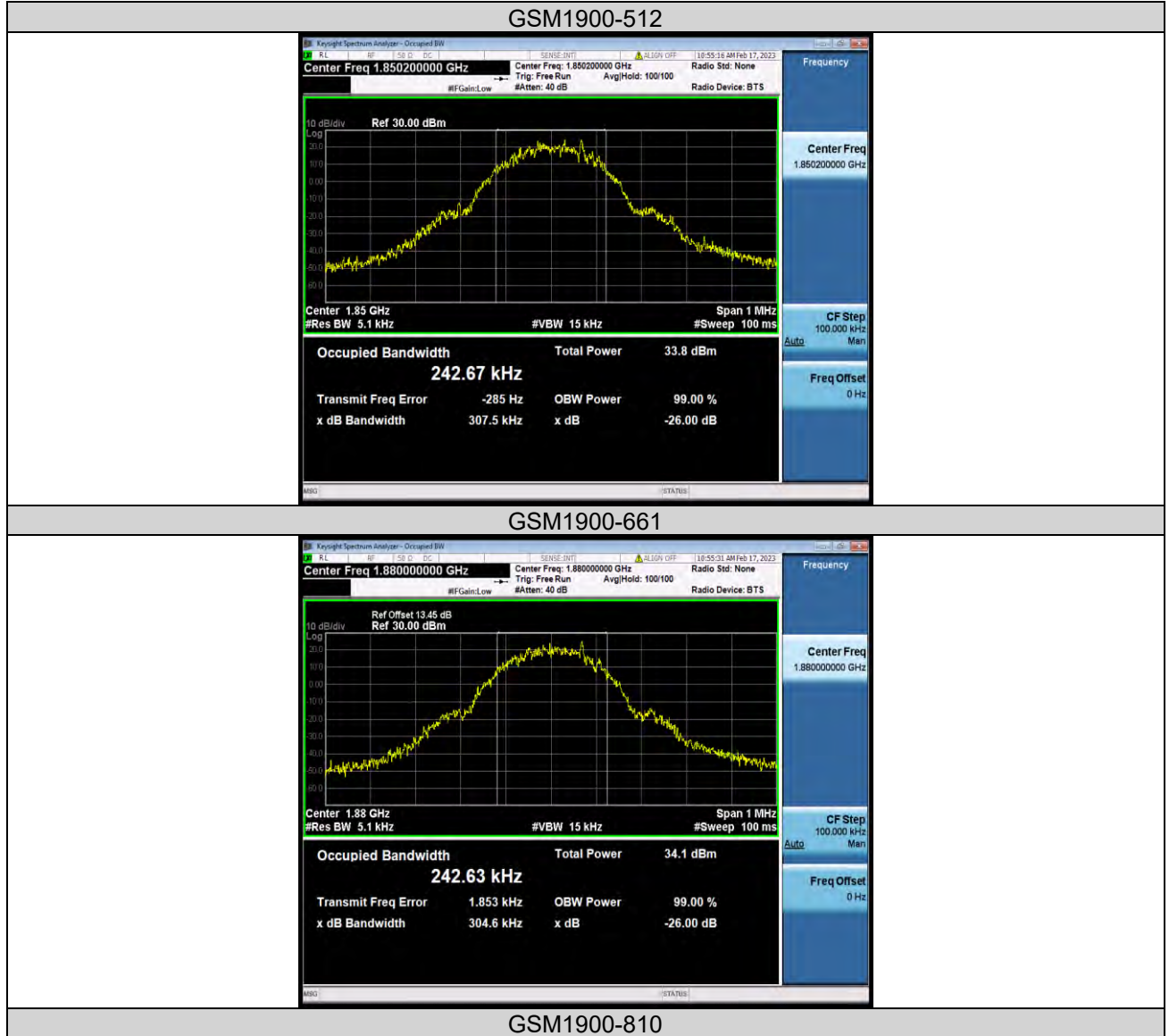



BUREAU VERITAS

Test Report No.: W7L-P22120012RF03

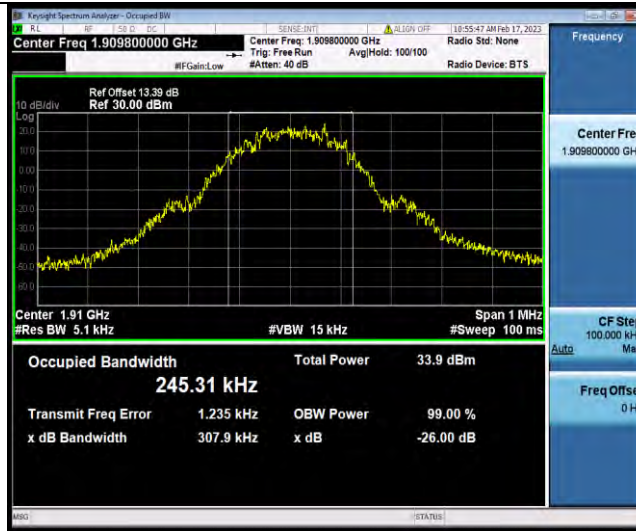

GPRS1900-512

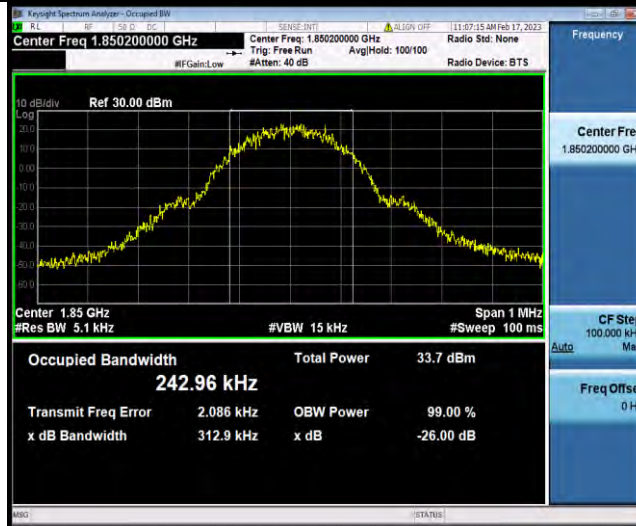

GPRS1900-661

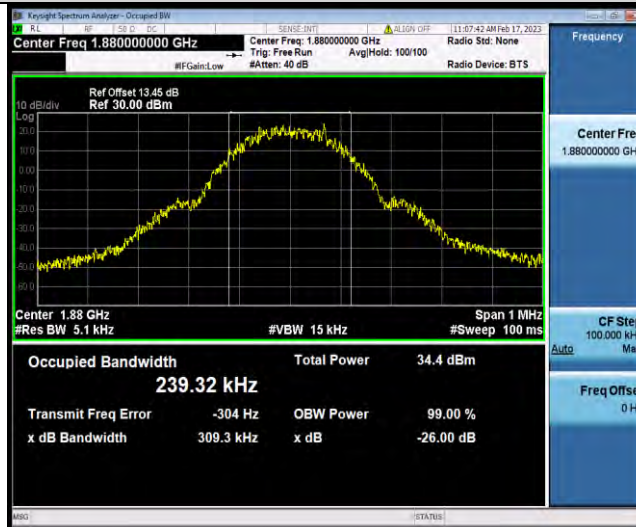

GPRS1900-810



BUREAU
VERITAS

Test Report No.: W7L-P22120012RF03

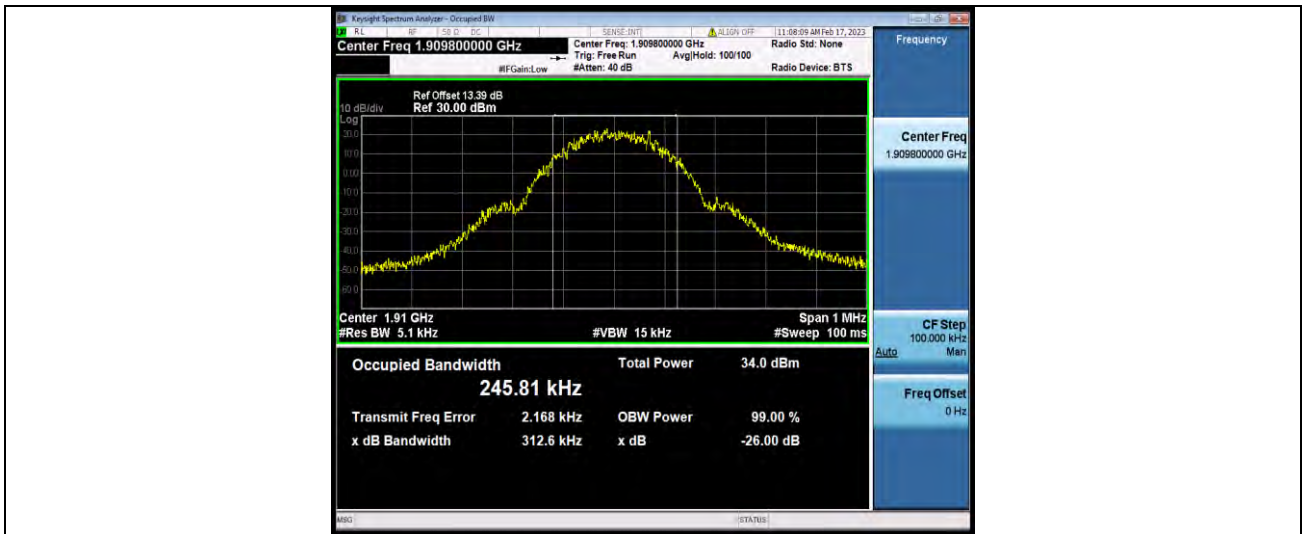



BUREAU
VERITAS

Test Report No.: W7L-P22120012RF03

BAND EDGE

Test Result

Band	Channel	Freq (MHz)	Result (dBm)	Limit(dBm)	Verdict
GSM1900	512	1850.00	-20.30	-13	PASS
GSM1900	810	1910.03	-19.40	-13	PASS
GPRS1900	512	1850.00	-19.88	-13	PASS
GPRS1900	810	1910.02	-19.12	-13	PASS



BUREAU VERITAS

Test Report No.: W7L-P22120012RF03

Test Graphs

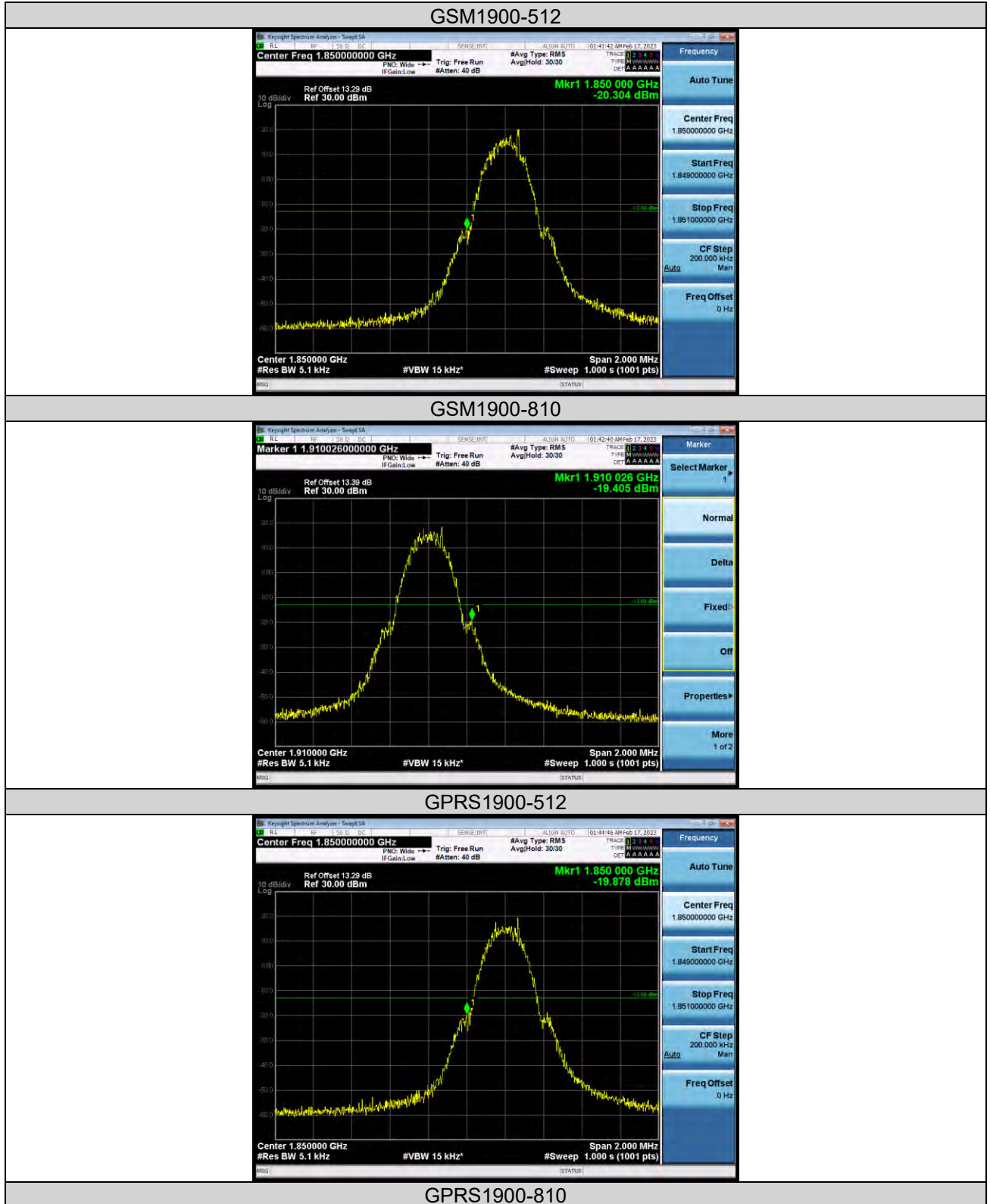



BUREAU VERITAS

Test Report No.: W7L-P22120012RF03

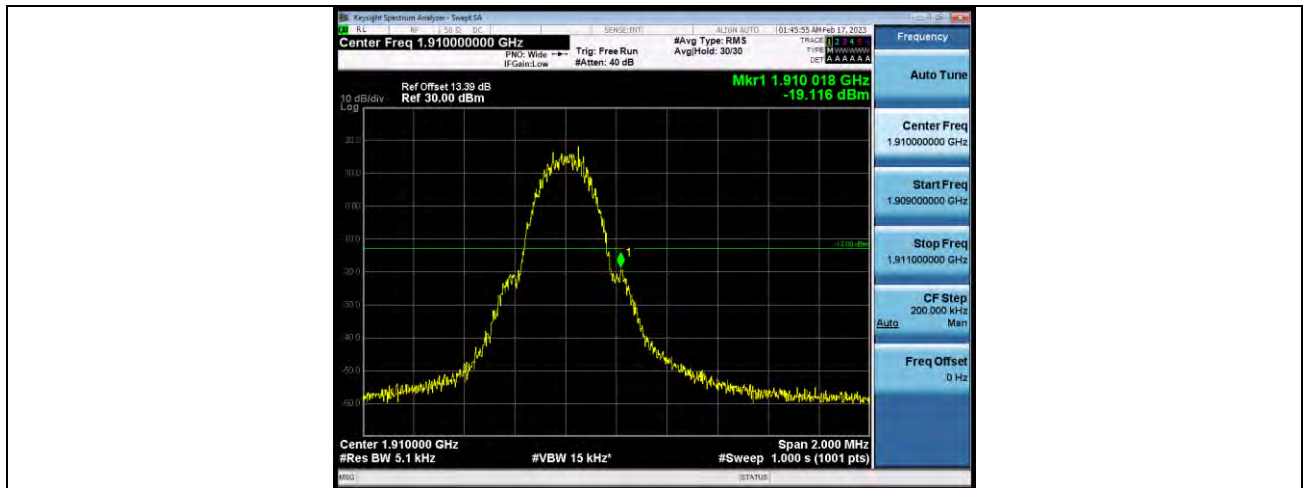

BV 7Layers Communications Technology (Shenzhen) Co., Ltd

No.B102, Dazu Chuangxin Mansion, North of Beihuan Avenue, North Area, Hi-Tech Industrial Park, Nanshan District, Shenzhen, Guangdong, China

Tel: +86 755 8869 6566
Fax: +86 755 8869 6577
Email: customerservice.sw@bureauveritas.com



**BUREAU
VERITAS**

Test Report No.: W7L-P22120012RF03

CONDUCTED SPURIOUS EMISSION

Test Result

Band	Channel	Frequency Range(MHz)	Max.Freq. (MHz)	Result (dBm)	Limit (dBm)	Verdict
GSM1900	512	30~1000MHz	961.56	-41.04	-13	PASS
GSM1900	512	1000~20000MHz	18809.33	-31.78	-13	PASS
GSM1900	661	30~1000MHz	934.33	-40.91	-13	PASS
GSM1900	661	1000~20000MHz	19376.8	-32.48	-13	PASS
GSM1900	810	30~1000MHz	886.15	-41.29	-13	PASS
GSM1900	810	1000~20000MHz	19986.7	-32.51	-13	PASS
GPRS1900	512	30~1000MHz	688.76	-40.66	-13	PASS
GPRS1900	512	1000~20000MHz	19592.77	-32.27	-13	PASS
GPRS1900	661	30~1000MHz	932.26	-39.99	-13	PASS
GPRS1900	661	1000~20000MHz	19245.07	-32.11	-13	PASS
GPRS1900	810	30~1000MHz	92.47	-40.92	-13	PASS
GPRS1900	810	1000~20000MHz	19133.6	-31.92	-13	PASS



BUREAU
VERITAS

Test Report No.: W7L-P22120012RF03

Test Graphs

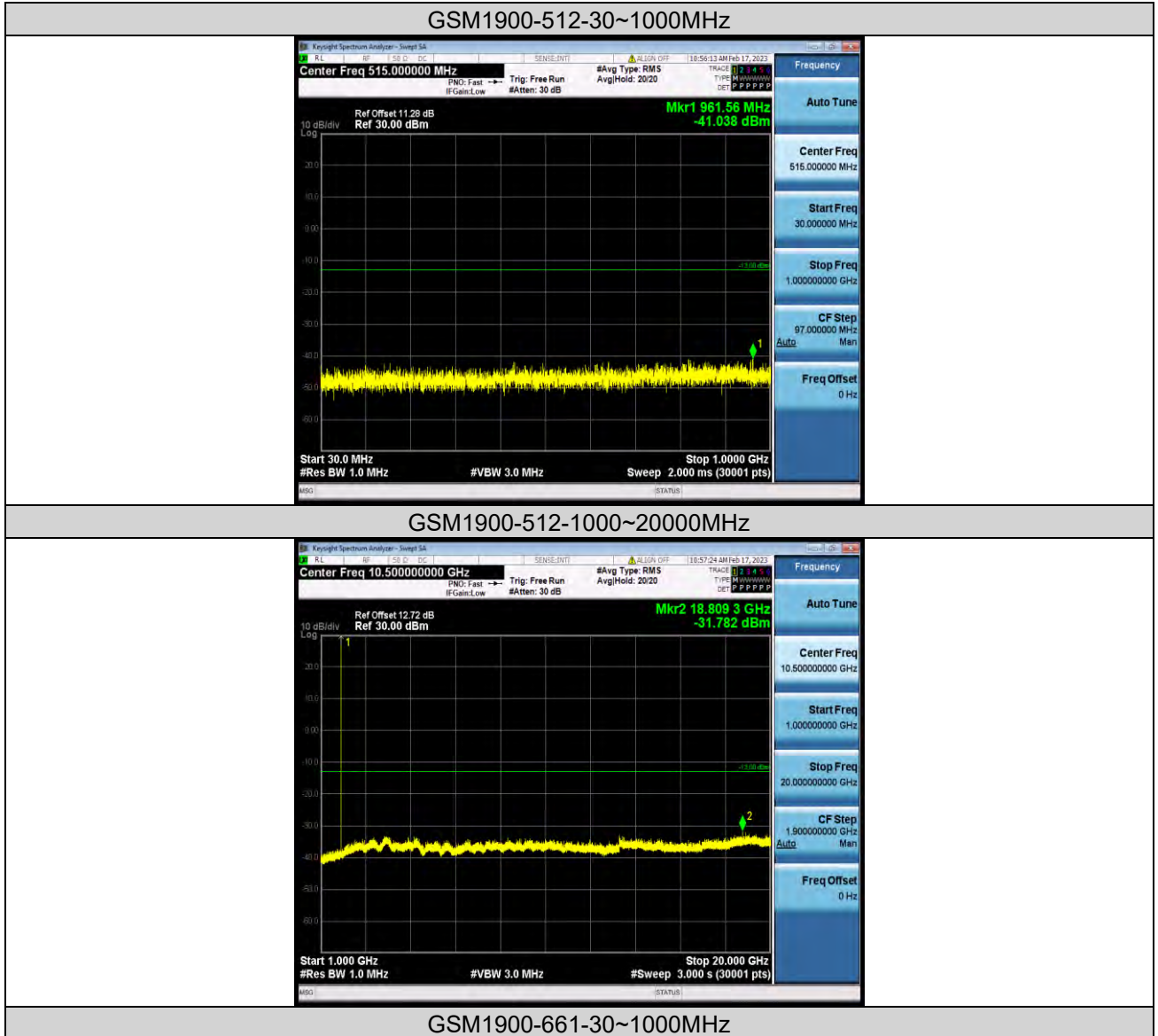



BUREAU VERITAS

Test Report No.: W7L-P22120012RF03

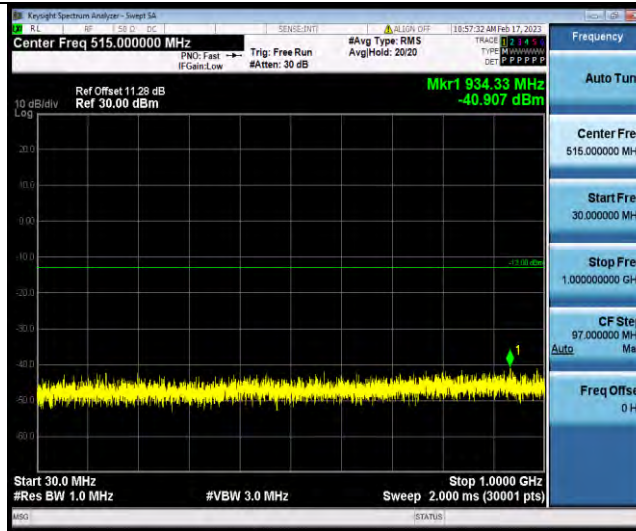

GSM1900-661-1000~20000MHz



GSM1900-810-30~1000MHz

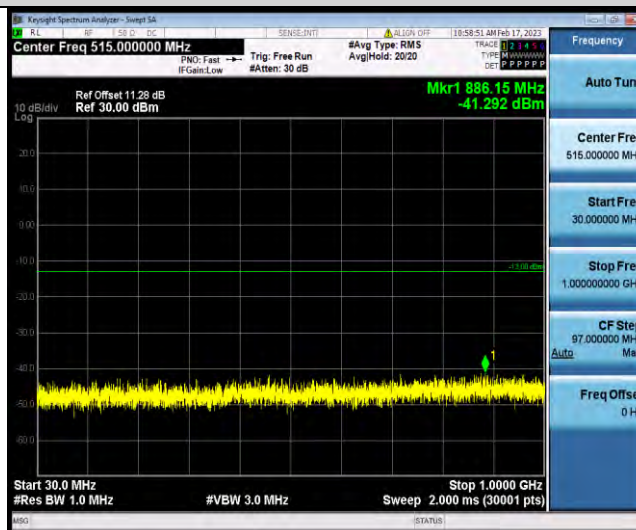

GSM1900-810-1000~20000MHz

BV 7Layers Communications Technology (Shenzhen) Co., Ltd

No.B102, Dazu Chuangxin Mansion, North of Beihuan Avenue, North Area, Hi-Tech Industrial Park, Nanshan District, Shenzhen, Guangdong, China

Tel: +86 755 8869 6566
 Fax: +86 755 8869 6577
 Email: customerservice.sw@bureauveritas.com



BUREAU VERITAS

Test Report No.: W7L-P22120012RF03



GPRS1900-512-30~1000MHz

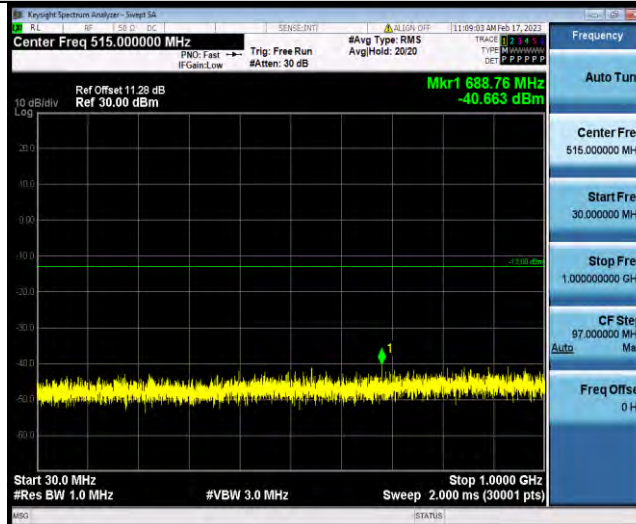

GPRS1900-512-1000~20000MHz

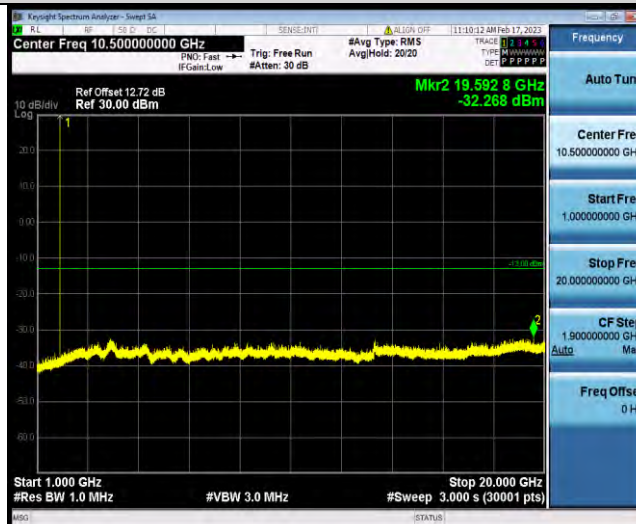

GPRS1900-661-30~1000MHz



BUREAU VERITAS

Test Report No.: W7L-P22120012RF03

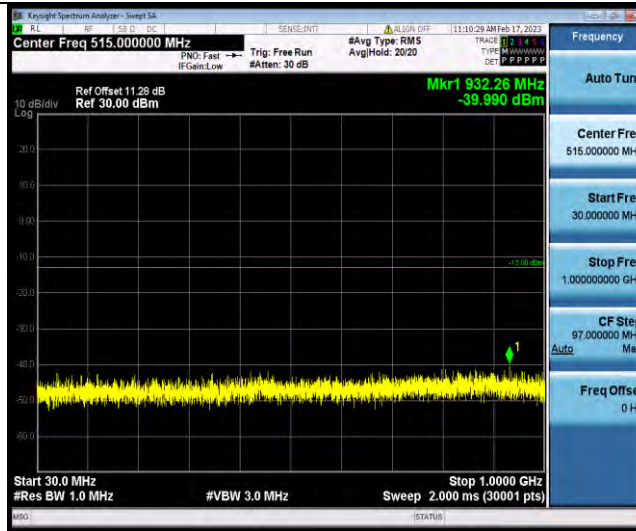

GPRS1900-661-1000~20000MHz



GPRS1900-810-30~1000MHz

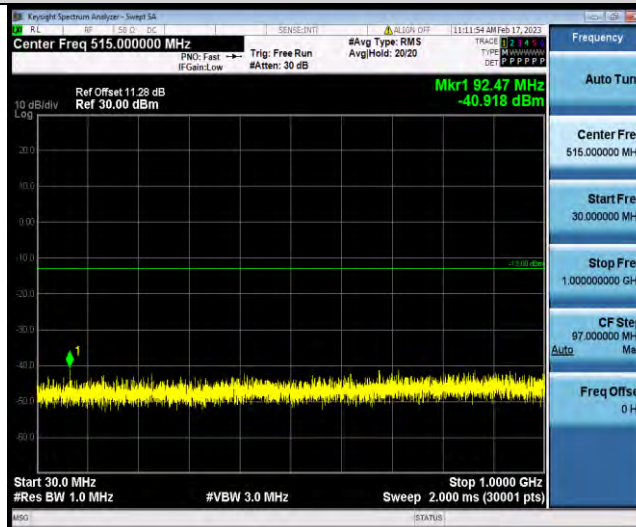

GPRS1900-810-1000~20000MHz



BUREAU
VERITAS

Test Report No.: W7L-P22120012RF03

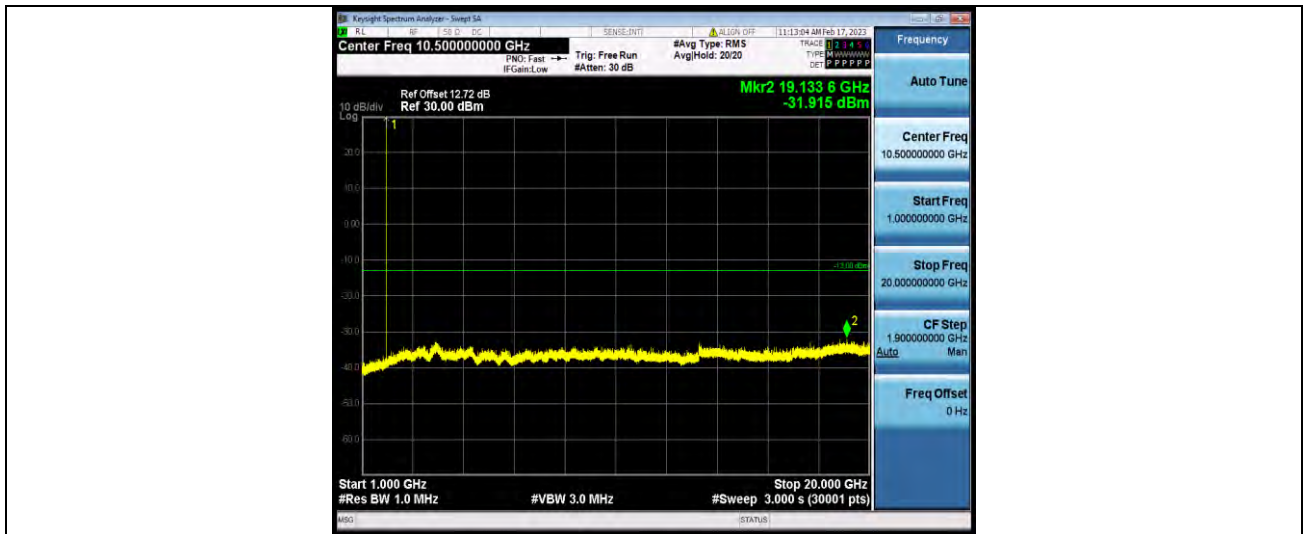



FREQUENCY STABILITY

Test Result

Voltage							
Band	Channel	Voltage [Vdc]	Temperature (°C)	Deviation (Hz)	Deviation (ppm)	Limit (ppm)	Verdict
GSM1900	512	VL	NT	7.01	0.003789	±2.5	PASS
GSM1900	512	VN	NT	6.23	0.003367	±2.5	PASS
GSM1900	512	VH	NT	9.14	0.004940	±2.5	PASS
GSM1900	661	VL	NT	1.78	0.000947	±2.5	PASS
GSM1900	661	VN	NT	-2.00	-0.001064	±2.5	PASS
GSM1900	661	VH	NT	4.65	0.002473	±2.5	PASS
GSM1900	810	VL	NT	4.16	0.002178	±2.5	PASS
GSM1900	810	VN	NT	1.52	0.000796	±2.5	PASS
GSM1900	810	VH	NT	2.97	0.001555	±2.5	PASS
GPRS1900	512	VL	NT	16.63	0.008988	±2.5	PASS
GPRS1900	512	VN	NT	8.62	0.004659	±2.5	PASS
GPRS1900	512	VH	NT	1.00	0.000540	±2.5	PASS
GPRS1900	661	VL	NT	11.75	0.006250	±2.5	PASS
GPRS1900	661	VN	NT	16.05	0.008537	±2.5	PASS
GPRS1900	661	VH	NT	6.46	0.003436	±2.5	PASS
GPRS1900	810	VL	NT	6.59	0.003451	±2.5	PASS
GPRS1900	810	VN	NT	14.46	0.007571	±2.5	PASS
GPRS1900	810	VH	NT	13.56	0.007100	±2.5	PASS

Temperature							
Band	Channel	Voltage [Vdc]	Temperature (°C)	Deviation (Hz)	Deviation (ppm)	Limit (ppm)	Verdict
GSM1900	512	NV	-30	14.11	0.007626	±2.5	PASS
GSM1900	512	NV	-20	7.04	0.003805	±2.5	PASS
GSM1900	512	NV	-10	2.16	0.001167	±2.5	PASS
GSM1900	512	NV	0	2.87	0.001551	±2.5	PASS
GSM1900	512	NV	10	4.36	0.002357	±2.5	PASS
GSM1900	512	NV	20	0.42	0.000227	±2.5	PASS
GSM1900	512	NV	30	1.49	0.000805	±2.5	PASS
GSM1900	512	NV	40	-1.03	-0.000557	±2.5	PASS
GSM1900	512	NV	50	-3.07	-0.001659	±2.5	PASS
GSM1900	661	NV	-30	6.65	0.003537	±2.5	PASS
GSM1900	661	NV	-20	-2.20	-0.001170	±2.5	PASS
GSM1900	661	NV	-10	13.11	0.006973	±2.5	PASS
GSM1900	661	NV	0	13.88	0.007383	±2.5	PASS
GSM1900	661	NV	10	10.49	0.005580	±2.5	PASS
GSM1900	661	NV	20	14.17	0.007537	±2.5	PASS
GSM1900	661	NV	30	10.75	0.005718	±2.5	PASS
GSM1900	661	NV	40	8.81	0.004686	±2.5	PASS
GSM1900	661	NV	50	11.07	0.005888	±2.5	PASS



**BUREAU
VERITAS**

Test Report No.: W7L-P22120012RF03

GSM1900	810	NV	-30	5.75	0.003011	±2.5	PASS
GSM1900	810	NV	-20	4.91	0.002571	±2.5	PASS
GSM1900	810	NV	-10	1.13	0.000592	±2.5	PASS
GSM1900	810	NV	0	2.97	0.001555	±2.5	PASS
GSM1900	810	NV	10	1.19	0.000623	±2.5	PASS
GSM1900	810	NV	20	-0.16	-0.000084	±2.5	PASS
GSM1900	810	NV	30	2.68	0.001403	±2.5	PASS
GSM1900	810	NV	40	-9.94	-0.005205	±2.5	PASS
GSM1900	810	NV	50	-2.32	-0.001215	±2.5	PASS
GPRS1900	512	NV	-30	-0.65	-0.000351	±2.5	PASS
GPRS1900	512	NV	-20	3.00	0.001621	±2.5	PASS
GPRS1900	512	NV	-10	9.36	0.005059	±2.5	PASS
GPRS1900	512	NV	0	11.88	0.006421	±2.5	PASS
GPRS1900	512	NV	10	1.45	0.000784	±2.5	PASS
GPRS1900	512	NV	20	12.14	0.006561	±2.5	PASS
GPRS1900	512	NV	30	9.94	0.005372	±2.5	PASS
GPRS1900	512	NV	40	1.36	0.000735	±2.5	PASS
GPRS1900	512	NV	50	2.16	0.001167	±2.5	PASS
GPRS1900	661	NV	-30	-0.58	-0.000309	±2.5	PASS
GPRS1900	661	NV	-20	4.62	0.002457	±2.5	PASS
GPRS1900	661	NV	-10	-1.97	-0.001048	±2.5	PASS
GPRS1900	661	NV	0	-0.03	-0.000016	±2.5	PASS
GPRS1900	661	NV	10	1.16	0.000617	±2.5	PASS
GPRS1900	661	NV	20	-0.55	-0.000293	±2.5	PASS
GPRS1900	661	NV	30	4.20	0.002234	±2.5	PASS
GPRS1900	661	NV	40	8.56	0.004553	±2.5	PASS
GPRS1900	661	NV	50	-3.45	-0.001835	±2.5	PASS
GPRS1900	810	NV	-30	7.94	0.004158	±2.5	PASS
GPRS1900	810	NV	-20	5.68	0.002974	±2.5	PASS
GPRS1900	810	NV	-10	8.56	0.004482	±2.5	PASS
GPRS1900	810	NV	0	4.75	0.002487	±2.5	PASS
GPRS1900	810	NV	10	4.75	0.002487	±2.5	PASS
GPRS1900	810	NV	20	9.04	0.004733	±2.5	PASS
GPRS1900	810	NV	30	2.29	0.001199	±2.5	PASS
GPRS1900	810	NV	40	9.75	0.005105	±2.5	PASS
GPRS1900	810	NV	50	4.62	0.002419	±2.5	PASS



Test Report No.: W7L-P22120012RF03

WCDMA BAND 2

PEAK-TO-AVERAGE RATIO

Test Result

Band	Channel	Peak-to-Average Ratio(dB)	Limit(dBm)	Verdict
Band2	9262	3.25	13	PASS
Band2	9400	3.05	13	PASS
Band2	9538	3.03	13	PASS



BUREAU
VERITAS

Test Report No.: W7L-P22120012RF03

Test Graphs

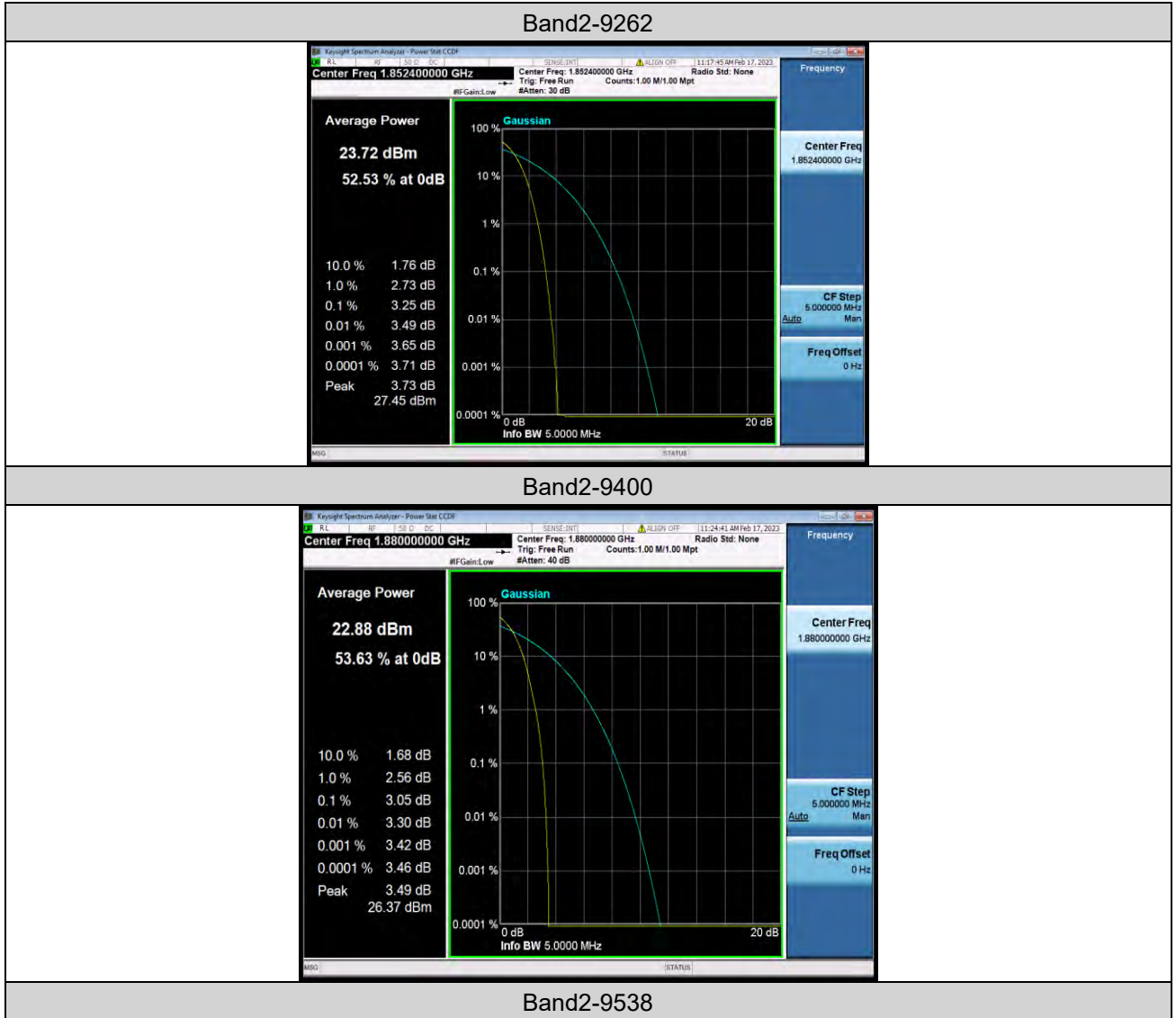



BUREAU
VERITAS

Test Report No.: W7L-P22120012RF03

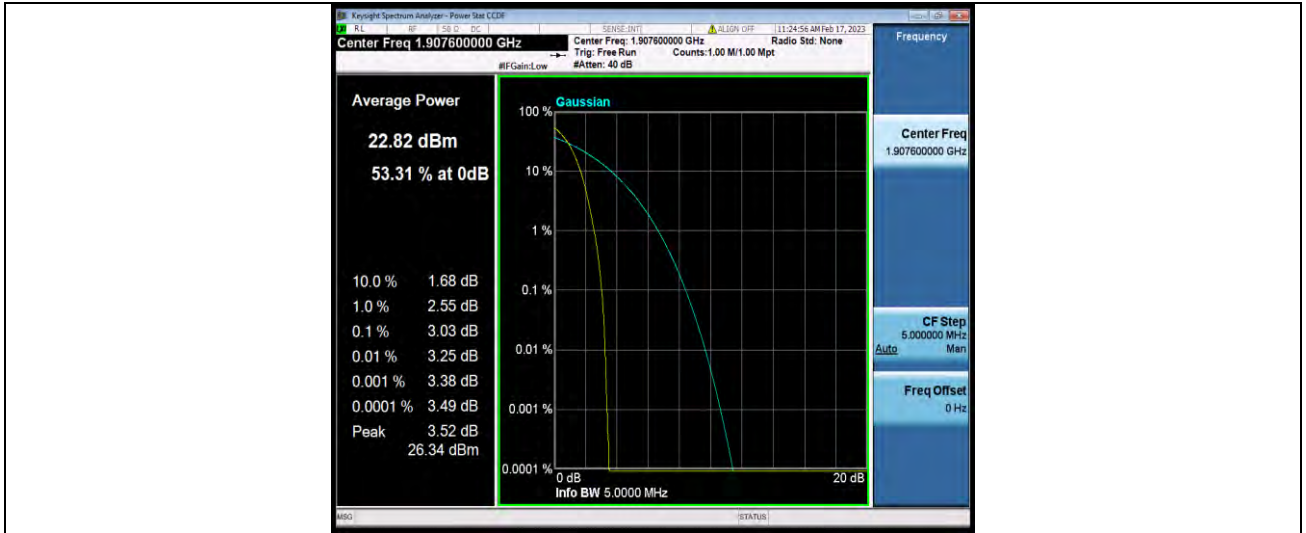



**BUREAU
VERITAS**

Test Report No.: W7L-P22120012RF03

26DB BANDWIDTH AND OCCUPIED BANDWIDTH

Test Result

Band	Channel	Occupied Bandwidth (MHz)	26dB Bandwidth (MHz)	Limit(kHz)	Verdict
Band2	9262	4.1624	4.692	---	PASS
Band2	9400	4.1645	4.682	---	PASS
Band2	9538	4.1653	4.686	---	PASS



BUREAU
VERITAS

Test Report No.: W7L-P22120012RF03

Test Graphs

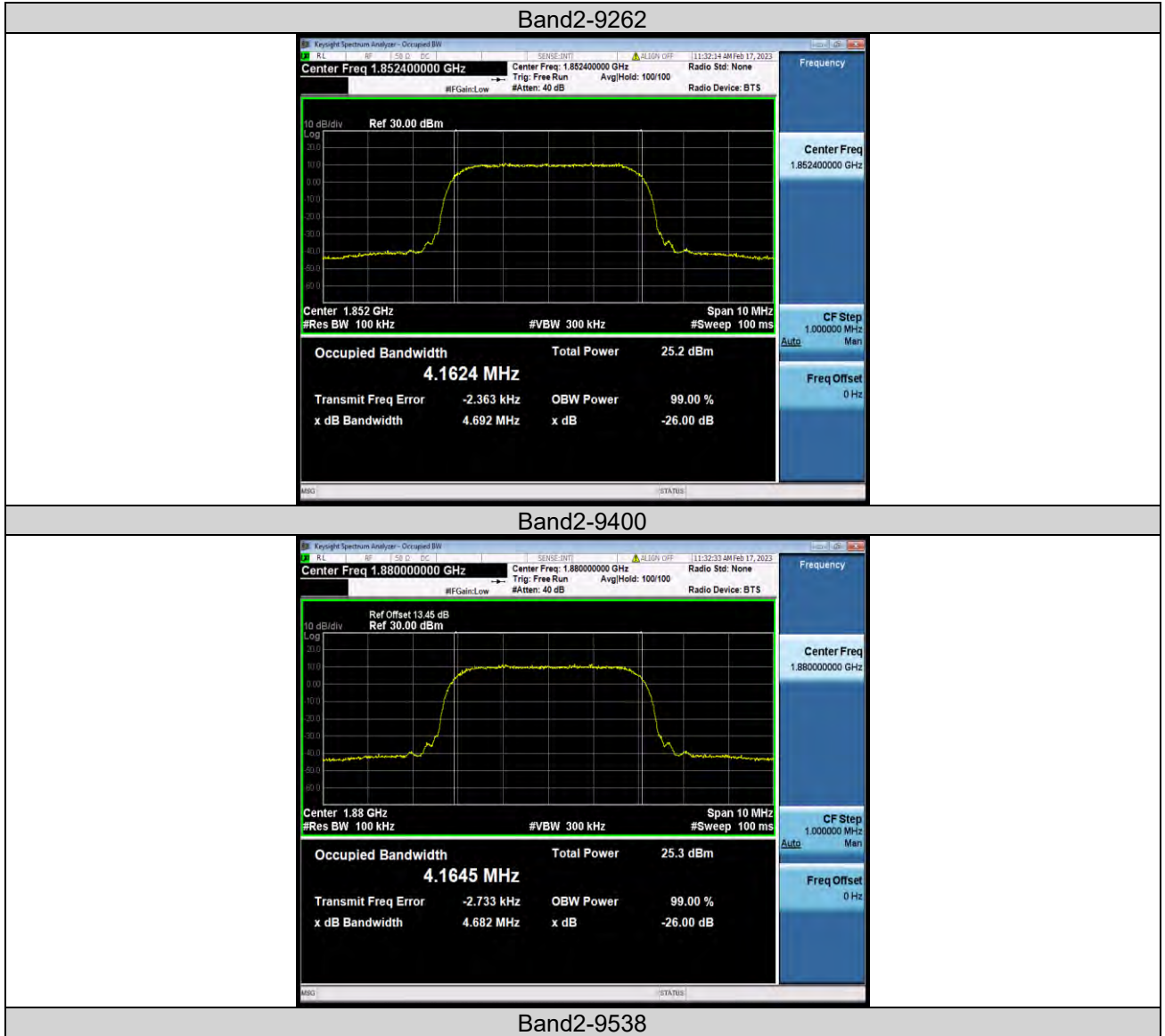



BUREAU
VERITAS

Test Report No.: W7L-P22120012RF03

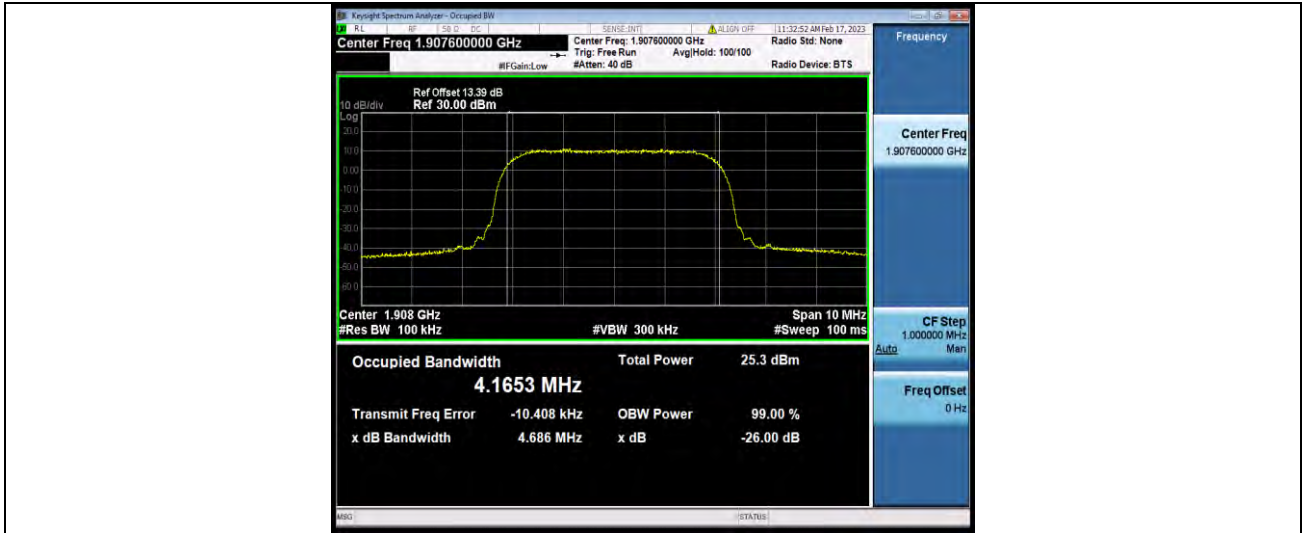



Test Report No.: W7L-P22120012RF03

BAND EDGE

Test Result

Band	Channel	Frequency (MHz)	Result (dBm)	Limit(dBm)	Verdict
Band2	9262	1849.94	-31.44	-13	PASS
Band2	9538	1910.10	-30.63	-13	PASS



BUREAU
VERITAS

Test Report No.: W7L-P22120012RF03

Test Graphs

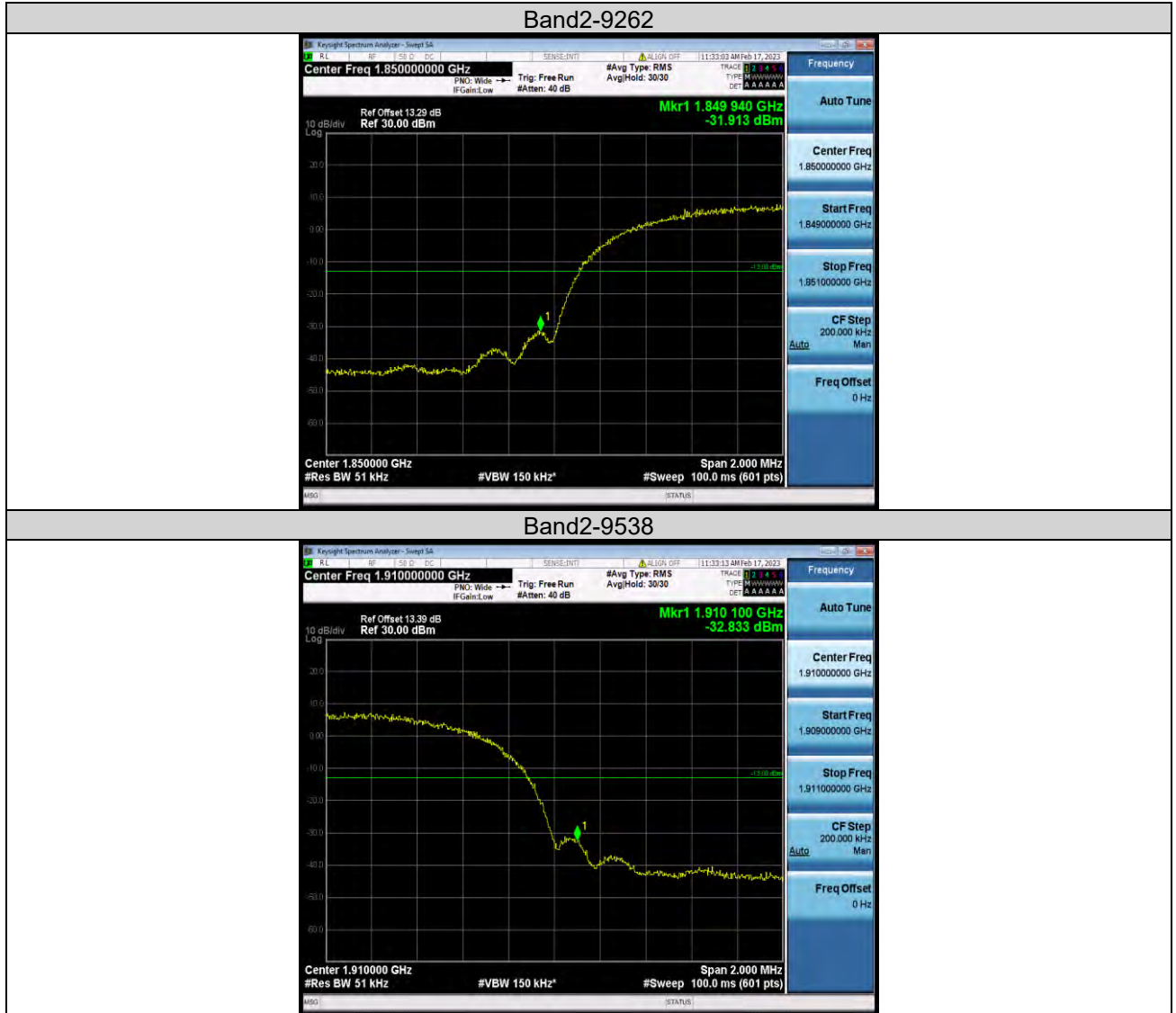



CONDUCTED SPURIOUS EMISSION

Test Result

Band	Channel	Frequency Range (Mhz)	Frequency (dBm)	Result (dBm)	Limit (dBm)	Verdict
Band2	9262	30~1000MHz	827.18	-40.7	-13	PASS
Band2	9262	1000~20000MHz	19441.4	-31.95	-13	PASS
Band2	9400	30~1000MHz	766.59	-39.92	-13	PASS
Band2	9400	1000~20000MHz	19999.37	-32.15	-13	PASS
Band2	9538	30~1000MHz	859.35	-40.08	-13	PASS
Band2	9538	1000~20000MHz	19340.07	-32.38	-13	PASS



BUREAU
VERITAS

Test Report No.: W7L-P22120012RF03

Test Graphs

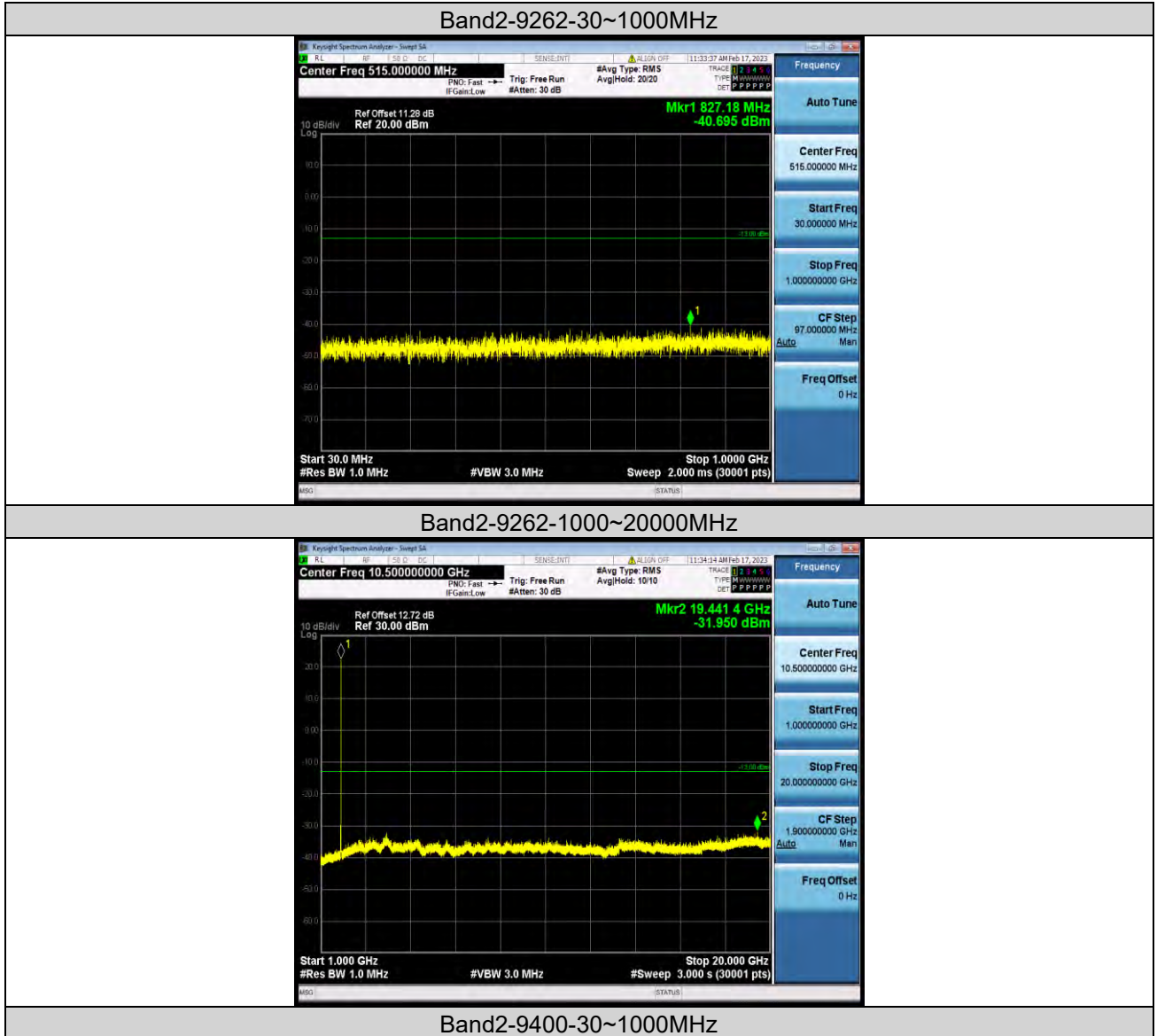



BUREAU VERITAS

Test Report No.: W7L-P22120012RF03

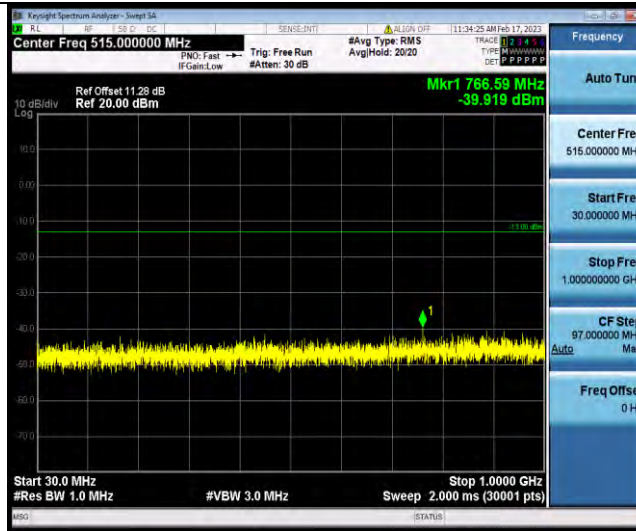

Band2-9400-1000~20000MHz



Band2-9538-30~1000MHz

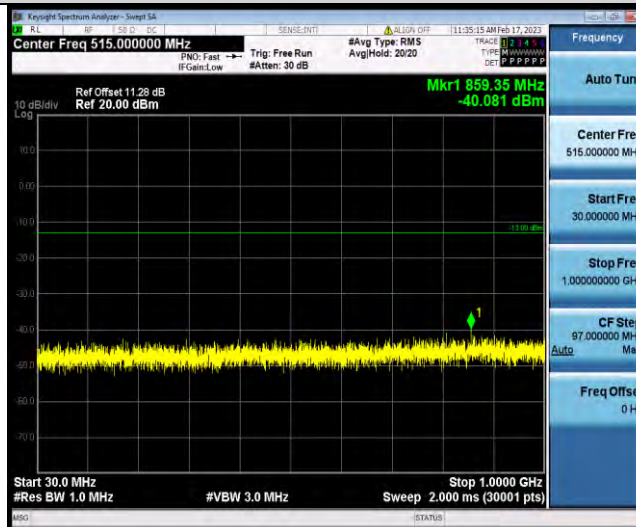

Band2-9538-1000~20000MHz

BV 7Layers Communications Technology (Shenzhen) Co., Ltd

No.B102, Dazu Chuangxin Mansion, North of Beihuan Avenue, North Area, Hi-Tech Industrial Park, Nanshan District, Shenzhen, Guangdong, China

Tel: +86 755 8869 6566
Fax: +86 755 8869 6577

Email: customerservice.sw@bureauveritas.com



BUREAU
VERITAS

Test Report No.: W7L-P22120012RF03

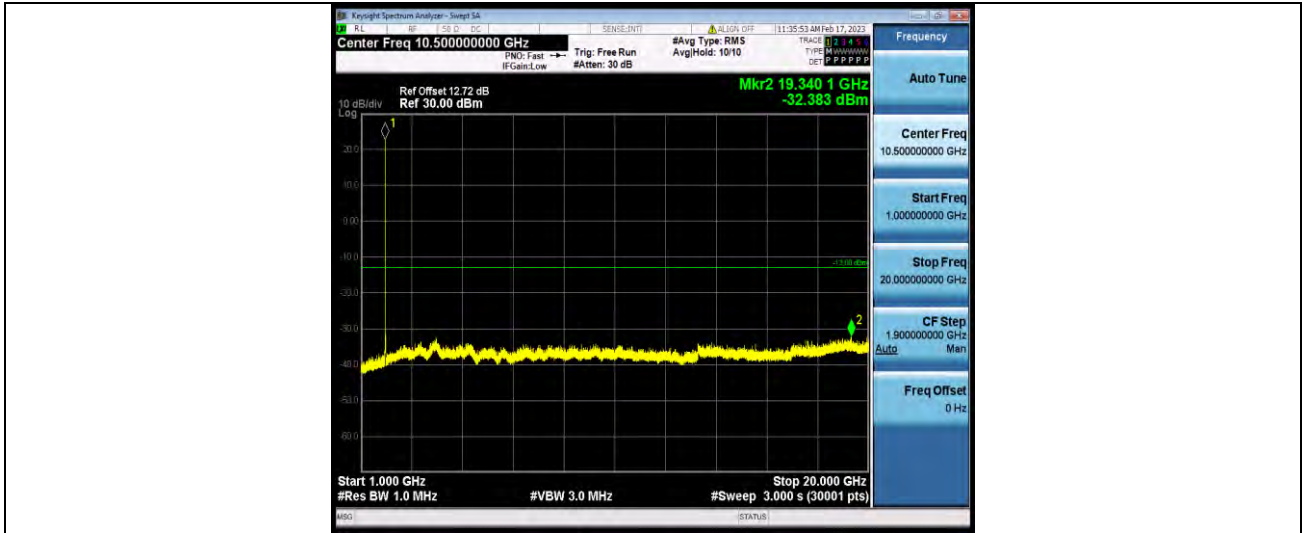



FREQUENCY STABILITY

Test Result

Voltage							
Band	Channel	Voltage (Vdc)	Temperature (°C)	Deviation (Hz)	Deviation (ppm)	Limit (ppm)	Verdict
Band2	9262	VL	NT	-2.20	-0.001188	±2.5	PASS
Band2	9262	VN	NT	-2.49	-0.001344	±2.5	PASS
Band2	9262	VH	NT	-5.03	-0.002715	±2.5	PASS
Band2	9400	VL	NT	-0.25	-0.000133	±2.5	PASS
Band2	9400	VN	NT	-1.24	-0.000660	±2.5	PASS
Band2	9400	VH	NT	0.99	0.000527	±2.5	PASS
Band2	9538	VL	NT	-1.00	-0.000524	±2.5	PASS
Band2	9538	VN	NT	-2.98	-0.001562	±2.5	PASS
Band2	9538	VH	NT	-6.84	-0.003586	±2.5	PASS

Temperature							
Band	Channel	Voltage (Vdc)	Temperature (°C)	Deviation (Hz)	Deviation (ppm)	Limit (ppm)	Verdict
Band2	9262	NV	-30	-2.99	-0.001614	±2.5	PASS
Band2	9262	NV	-20	6.28	0.003390	±2.5	PASS
Band2	9262	NV	-10	0.96	0.000518	±2.5	PASS
Band2	9262	NV	0	-2.35	-0.001269	±2.5	PASS
Band2	9262	NV	10	4.57	0.002467	±2.5	PASS
Band2	9262	NV	20	-6.07	-0.003277	±2.5	PASS
Band2	9262	NV	30	-0.34	-0.000184	±2.5	PASS
Band2	9262	NV	40	5.79	0.003126	±2.5	PASS
Band2	9262	NV	50	-1.34	-0.000723	±2.5	PASS
Band2	9400	NV	-30	-3.31	-0.001761	±2.5	PASS
Band2	9400	NV	-20	-8.02	-0.004266	±2.5	PASS
Band2	9400	NV	-10	4.90	0.002606	±2.5	PASS
Band2	9400	NV	0	5.44	0.002894	±2.5	PASS
Band2	9400	NV	10	3.99	0.002122	±2.5	PASS
Band2	9400	NV	20	-4.19	-0.002229	±2.5	PASS
Band2	9400	NV	30	-4.73	-0.002516	±2.5	PASS
Band2	9400	NV	40	-3.48	-0.001851	±2.5	PASS
Band2	9400	NV	50	-4.48	-0.002383	±2.5	PASS
Band2	9538	NV	-30	-0.45	-0.000236	±2.5	PASS
Band2	9538	NV	-20	0.58	0.000304	±2.5	PASS
Band2	9538	NV	-10	0.34	0.000178	±2.5	PASS
Band2	9538	NV	0	0.32	0.000168	±2.5	PASS
Band2	9538	NV	10	0.29	0.000152	±2.5	PASS
Band2	9538	NV	20	0.76	0.000398	±2.5	PASS
Band2	9538	NV	30	0.35	0.000183	±2.5	PASS
Band2	9538	NV	40	-0.47	-0.000246	±2.5	PASS
Band2	9538	NV	50	-0.62	-0.000325	±2.5	PASS



LTE BAND2

PEAK-TO-AVERAGE RATIO(CCDF)

Test Result

Band	Bandwidth	Modulation	Channel	RB Configuration	Result(dB)	Limit(dB)	Verdict
Band2	1.4MHz	QPSK	18607	1RB#0	5.39	13	PASS
Band2	1.4MHz	QPSK	18607	6RB#0	5.82	13	PASS
Band2	1.4MHz	QPSK	18900	1RB#0	5.48	13	PASS
Band2	1.4MHz	QPSK	18900	6RB#0	5.76	13	PASS
Band2	1.4MHz	QPSK	19193	1RB#0	5.03	13	PASS
Band2	1.4MHz	QPSK	19193	6RB#0	5.52	13	PASS
Band2	1.4MHz	16QAM	18607	1RB#0	6.48	13	PASS
Band2	1.4MHz	16QAM	18607	6RB#0	6.50	13	PASS
Band2	1.4MHz	16QAM	18900	1RB#0	6.45	13	PASS
Band2	1.4MHz	16QAM	18900	6RB#0	6.81	13	PASS
Band2	1.4MHz	16QAM	19193	1RB#0	5.47	13	PASS
Band2	1.4MHz	16QAM	19193	6RB#0	6.55	13	PASS
Band2	3MHz	QPSK	18615	1RB#0	5.34	13	PASS
Band2	3MHz	QPSK	18615	15RB#0	5.74	13	PASS
Band2	3MHz	QPSK	18900	1RB#0	5.39	13	PASS
Band2	3MHz	QPSK	18900	15RB#0	5.78	13	PASS
Band2	3MHz	QPSK	19185	1RB#0	4.97	13	PASS
Band2	3MHz	QPSK	19185	15RB#0	5.55	13	PASS
Band2	3MHz	16QAM	18615	1RB#0	6.29	13	PASS
Band2	3MHz	16QAM	18615	15RB#0	6.43	13	PASS
Band2	3MHz	16QAM	18900	1RB#0	6.16	13	PASS
Band2	3MHz	16QAM	18900	15RB#0	6.63	13	PASS
Band2	3MHz	16QAM	19185	1RB#0	5.45	13	PASS
Band2	3MHz	16QAM	19185	15RB#0	6.49	13	PASS
Band2	5MHz	QPSK	18625	1RB#0	5.46	13	PASS
Band2	5MHz	QPSK	18625	25RB#0	5.76	13	PASS
Band2	5MHz	QPSK	18900	1RB#0	5.55	13	PASS
Band2	5MHz	QPSK	18900	25RB#0	5.85	13	PASS
Band2	5MHz	QPSK	19175	1RB#0	5.20	13	PASS
Band2	5MHz	QPSK	19175	25RB#0	5.73	13	PASS
Band2	5MHz	16QAM	18625	1RB#0	6.93	13	PASS
Band2	5MHz	16QAM	18625	25RB#0	6.43	13	PASS
Band2	5MHz	16QAM	18900	1RB#0	6.71	13	PASS
Band2	5MHz	16QAM	18900	25RB#0	6.47	13	PASS
Band2	5MHz	16QAM	19175	1RB#0	6.48	13	PASS
Band2	5MHz	16QAM	19175	25RB#0	6.42	13	PASS
Band2	10MHz	QPSK	18650	1RB#0	5.28	13	PASS
Band2	10MHz	QPSK	18650	50RB#0	5.74	13	PASS
Band2	10MHz	QPSK	18900	1RB#0	5.39	13	PASS
Band2	10MHz	QPSK	18900	50RB#0	5.88	13	PASS
Band2	10MHz	QPSK	19150	1RB#0	5.01	13	PASS
Band2	10MHz	QPSK	19150	50RB#0	5.77	13	PASS



**BUREAU
VERITAS**

Test Report No.: W7L-P22120012RF03

Band2	10MHz	16QAM	18650	1RB#0	6.05	13	PASS
Band2	10MHz	16QAM	18650	50RB#0	6.53	13	PASS
Band2	10MHz	16QAM	18900	1RB#0	6.08	13	PASS
Band2	10MHz	16QAM	18900	50RB#0	6.54	13	PASS
Band2	10MHz	16QAM	19150	1RB#0	5.57	13	PASS
Band2	10MHz	16QAM	19150	50RB#0	6.45	13	PASS
Band2	15MHz	QPSK	18675	1RB#0	5.30	13	PASS
Band2	15MHz	QPSK	18675	75RB#0	5.98	13	PASS
Band2	15MHz	QPSK	18900	1RB#0	5.29	13	PASS
Band2	15MHz	QPSK	18900	75RB#0	6.14	13	PASS
Band2	15MHz	QPSK	19125	1RB#0	4.99	13	PASS
Band2	15MHz	QPSK	19125	75RB#0	5.91	13	PASS
Band2	15MHz	16QAM	18675	1RB#0	5.74	13	PASS
Band2	15MHz	16QAM	18675	75RB#0	6.43	13	PASS
Band2	15MHz	16QAM	18900	1RB#0	5.99	13	PASS
Band2	15MHz	16QAM	18900	75RB#0	6.60	13	PASS
Band2	15MHz	16QAM	19125	1RB#0	5.50	13	PASS
Band2	15MHz	16QAM	19125	75RB#0	6.42	13	PASS
Band2	20MHz	QPSK	18700	1RB#0	5.22	13	PASS
Band2	20MHz	QPSK	18700	100RB#0	5.73	13	PASS
Band2	20MHz	QPSK	18900	1RB#0	5.20	13	PASS
Band2	20MHz	QPSK	18900	100RB#0	5.92	13	PASS
Band2	20MHz	QPSK	19100	1RB#0	5.06	13	PASS
Band2	20MHz	QPSK	19100	100RB#0	5.65	13	PASS
Band2	20MHz	16QAM	18700	1RB#0	6.28	13	PASS
Band2	20MHz	16QAM	18700	100RB#0	6.38	13	PASS
Band2	20MHz	16QAM	18900	1RB#0	5.99	13	PASS
Band2	20MHz	16QAM	18900	100RB#0	6.58	13	PASS
Band2	20MHz	16QAM	19100	1RB#0	6.00	13	PASS
Band2	20MHz	16QAM	19100	100RB#0	6.37	13	PASS



BUREAU
VERITAS

Test Report No.: W7L-P22120012RF03

Test Graphs

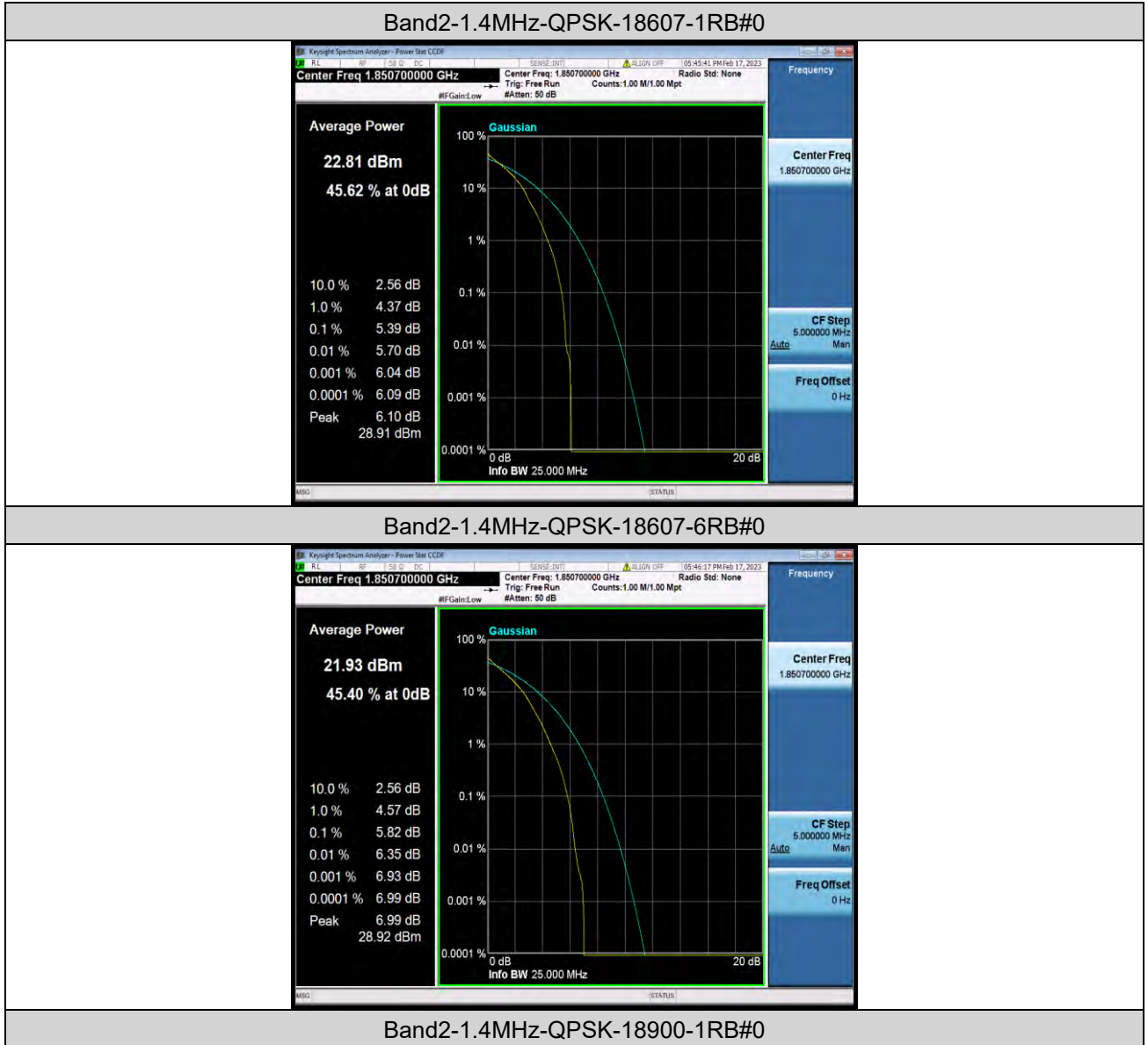



BUREAU VERITAS

Test Report No.: W7L-P22120012RF03



Band2-1.4MHz-QPSK-18900-6RB#0

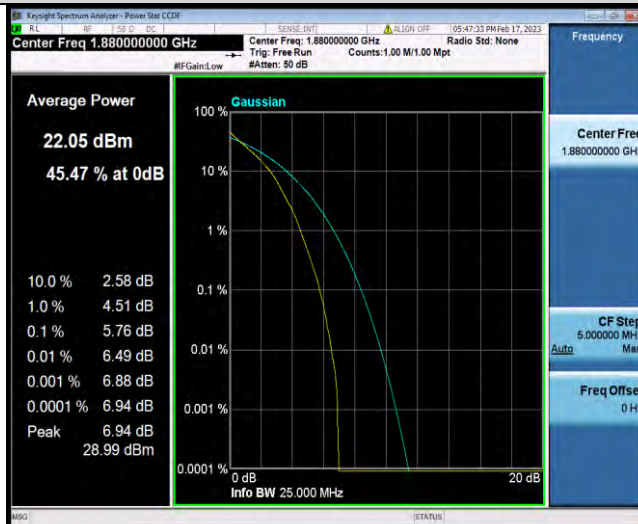

Band2-1.4MHz-QPSK-19193-1RB#0

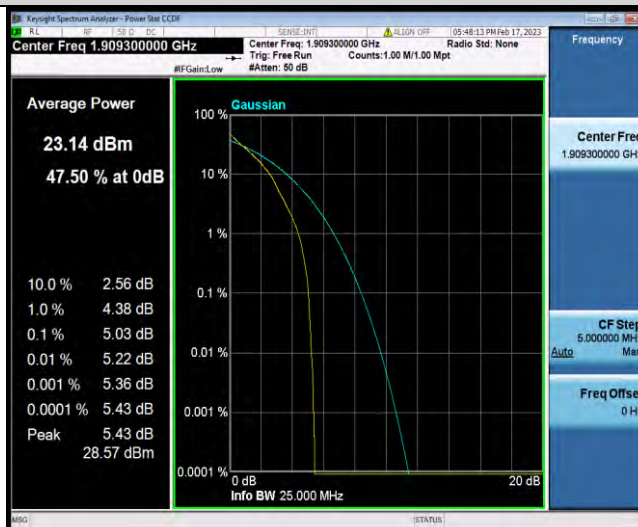

Band2-1.4MHz-QPSK-19193-6RB#0



BUREAU VERITAS

Test Report No.: W7L-P22120012RF03



Band2-1.4MHz-16QAM-18607-1RB#0



Band2-1.4MHz-16QAM-18607-6RB#0

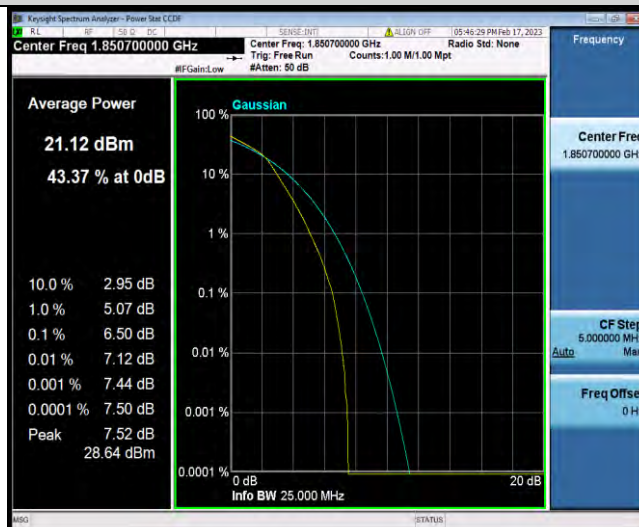

Band2-1.4MHz-16QAM-18900-1RB#0



BUREAU VERITAS

Test Report No.: W7L-P22120012RF03



Band2-1.4MHz-16QAM-18900-6RB#0

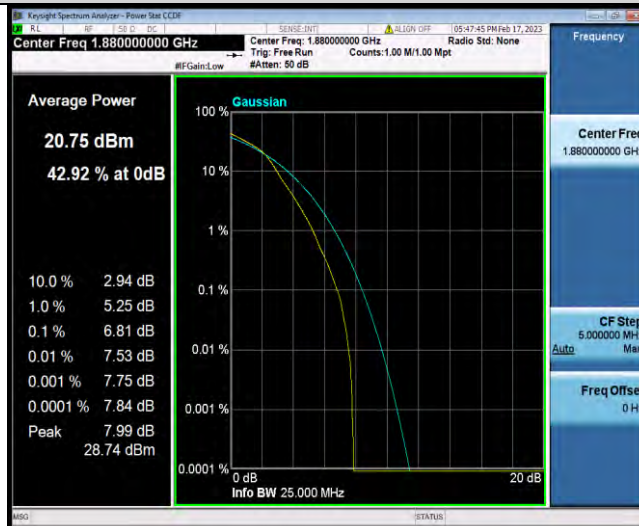

Band2-1.4MHz-16QAM-19193-1RB#0



Band2-1.4MHz-16QAM-19193-6RB#0



BUREAU VERITAS

Test Report No.: W7L-P22120012RF03



Band2-3MHz-QPSK-18615-1RB#0



Band2-3MHz-QPSK-18615-15RB#0



Band2-3MHz-QPSK-18900-1RB#0