



[Huawei IP Phone eSpace 6805](#)

## **User Manual**

HUAWEI TECHNOLOGIES CO., LTD.





[Huawei IP Phone eSpace 6805](#)

V100R001C02

## **User Manual**

**Issue** 01

**Date** [2011-12-07](#)

Huawei Technologies Co., Ltd. provides customers with comprehensive technical support and service. Please feel free to contact our local office or company headquarters.

## Huawei Technologies Co., Ltd.

Address: Huawei Industrial Base  
Bantian, Longgang  
Shenzhen 518129  
People's Republic of China

Website: <http://www.huawei.com>

Email: [Support@huawei.com](mailto:Support@huawei.com).

### **Copyright © Huawei Technologies Co., Ltd. 2011. All rights reserved.**

No part of this document may be reproduced or transmitted in any form or by any means without prior written consent of Huawei Technologies Co., Ltd.

### **Trademarks and Permissions**



**HUAWEI** and other Huawei trademarks are trademarks of Huawei Technologies Co., Ltd.

All other trademarks and trade names mentioned in this document are the property of their respective holders.

### **Notice**

The information in this document is subject to change without notice. Every effort has been made in the preparation of this document to ensure accuracy of the contents, but all statements, information, and recommendations in this document do not constitute the warranty of any kind, express or implied.

# Contents

<b><u>1 Safety Precautions.....</u></b>	<b><u>2</u></b>
<b><u>2 Product Overview.....</u></b>	<b><u>5</u></b>
<u>Packing List.....</u>	<u>5</u>
<u>Features.....</u>	<u>6</u>
<u>Hardware specifications.....</u>	<u>7</u>
<u>Technical specifications.....</u>	<u>8</u>
<b><u>3 Installing the eSpace 6805.....</u></b>	<b><u>11</u></b>
<u>Cable Connections of the eSpace 6805.....</u>	<u>11</u>
<u>Starting the eSpace 6805.....</u>	<u>12</u>
<u>Safety Compliance.....</u>	<u>12</u>
<u>Warranty of Quality.....</u>	<u>13</u>
<b><u>4 Configuring the eSpace 6805.....</u></b>	<b><u>14</u></b>
<u>Configuring the Phone Through the Keypad.....</u>	<u>14</u>
<u>Configuring the Phone Through Web Browser.....</u>	<u>17</u>
<u>Accessing the Web Configuration Menu.....</u>	<u>17</u>
<u>Configuration Page.....</u>	<u>18</u>
<u>Saving the Configuration Changes.....</u>	<u>22</u>
<u>Rebooting the eSpace 6805 Remotely.....</u>	<u>23</u>
<b><u>5 Using the eSpace 6805.....</u></b>	<b><u>24</u></b>
<u>Getting to Know the Keyboard.....</u>	<u>24</u>

<a href="#"><u>Instructions of Using the Phone .....</u></a>	<a href="#"><u>25</u></a>
<a href="#"><u>Handset, Speakerphone, and Headset Modes .....</u></a>	<a href="#"><u>25</u></a>
<a href="#"><u>Multiple SIP Accounts and Lines .....</u></a>	<a href="#"><u>26</u></a>
<a href="#"><u>Making a Call .....</u></a>	<a href="#"><u>26</u></a>
<a href="#"><u>Making a Call by Using an IP Address .....</u></a>	<a href="#"><u>27</u></a>
<a href="#"><u>Quick IP Call Mode .....</u></a>	<a href="#"><u>28</u></a>
<a href="#"><u>Answering a Call .....</u></a>	<a href="#"><u>28</u></a>
<a href="#"><u>Do-Not-Disturb .....</u></a>	<a href="#"><u>28</u></a>
<a href="#"><u>Call Waiting/Call Holding .....</u></a>	<a href="#"><u>29</u></a>
<a href="#"><u>Muting .....</u></a>	<a href="#"><u>29</u></a>
<a href="#"><u>Call Transfer .....</u></a>	<a href="#"><u>29</u></a>
<a href="#"><u>Three-Way Conference Call .....</u></a>	<a href="#"><u>30</u></a>
<a href="#"><u>Voice Messages .....</u></a>	<a href="#"><u>30</u></a>
<a href="#"><u>Manager and Secretary Function .....</u></a>	<a href="#"><u>31</u></a>
<a href="#"><b><u>6 Restoring Factory Default Settings .....</u></b></a>	<a href="#"><b><u>33</u></b></a>
<a href="#"><b><u>7 FAQs .....</u></b></a>	<a href="#"><b><u>34</u></b></a>

# Huawei IP Phone eSpace 6810

## User Manual

Thank you for purchasing the Huawei IP Phone eSpace [6805](#) (the eSpace [6805](#) for short).

eSpace [6805](#) is an high-quality IP phone.

# 1 Safety Precautions

---



## General Requirements:

- Before you install and use the device, read these safety precautions carefully and observe them during operation.
- During storage, transportation, and operation of the device, keep the device dry.
- During storage, transportation, and operation of the device, avoid collision and crash of the device.
- Never attempt to dismantle the device by yourself. In case of any fault, contact the appointed maintenance center for repair.
- Without prior written consent, no organization or individual is permitted to make any change to the structure or safety design of the device. Huawei Technologies Co., Ltd. is not liable to any consequences or legal issues due to such changes.
- While using the device, observe all applicable laws, directives and regulations, and respect the legal rights of other people.



## Environmental Requirements:

- Place the device at a well-ventilated place. Do not dispose the device to direct sunlight.
- Keep the device clean and free of dusts.
- Place the device on a stable platform.
- Do not place any object on top of the device. Otherwise, the device may be too hot during operation. It can even be deformed or damaged by the heavy load.
- Keep at least 10 cm between the device and the closest object for heat dissipation.
- Do not place the device on or near any object that can easily catch fire, such as something made of rubber.
- Keep the device far away from any heat source or bare fire, such as a candle or an electric heater.
- Keep the device far away from any household appliance with strong magnetic field or electromagnetic field, such as a microwave oven or a refrigerator.



## Operating Requirements:

- Do not let a child operate the device without guidance.
- Do not let a child play with the device or any accessory. Swallowing the accessories may lead to peril.
- Use the accessories provided or authorized by the manufacturer only.
- The power supply of the device shall meet the requirements of the input voltage of the device. Use the provided lightning protection power socket only.
- Before plugging or unplugging any cable, shut down the device and disconnect it from the power supply.
- While plugging or unplugging any cable, make sure that your hands are completely dry.
- Do not tread on, pull, or over-bend any cable. Otherwise, the cable may be damaged, leading to malfunction of the device.
- Do not use an old or a damaged power cable.
- During lightning weather, stop using the device and disconnect it from the power supply. Unplug the power plug and the ADSL (Asymmetric Digital Subscriber Line) twisted pair (the radio frequency cable) to avoid lightning strike.
- If the device is not used for a long time, disconnect it from the power supply and unplug the power plug.
- Do not look directly into the optical interface and the laser-transmitting interface on the device, or the infrared transmitting interface on the remote control with your eyes. Otherwise, your eyes may be injured.
- In any of the following cases, stop using the device, disconnect it from the power supply, and unplug the power plug immediately: there is smoke emitted from the device, or there is some abnormal noise or smell. Contact the specified maintenance center for repair.
- Avoid any object (such as metal shavings) from entering the device from the heat dissipation intakes.
- Before connecting any other cable, connect the grounding cable of the device first. Do not disconnect the grounding cable until you disconnect all other cables.
- Make sure that the three-phase power socket is grounded reliably. The neutral line and the live line shall not be connected inversely.
- Do not scratch or abrade the shell of the device. This may lead to malfunctions of the device. The shed painting material may also lead to skin allergy.





### **Cleaning Requirements:**

- Before cleaning the device, stop using it and disconnect it from the power supply.
- Use a piece of soft dry cloth to clean the device.
- Keep the power plug clean and dry. Using a dirty or wet power plug may lead to electric shock or other perils.

# 2 Product Overview

## Packing List

The following items are included in the eSpace [6805](#) package. Verify the packing items. Contact your distributor immediately if any one is missing.

**Table 2-1** Packing items

Item	Quantity
Main case	1
Handset	1
Coiled handset cord	1
Specialized power adapter	1
Straight-through cable	1
Phone Stand	1
Wall-mount bracket	<a href="#">2</a>
eSpace <a href="#">6805</a> Quick Start	1
CD	1
Warranty card	1
Certificate of quality	1

**Product Picture**



**Product Overview**

The eSpace [6805](#) is a next-generation enterprise IP phone. The eSpace [6805](#) provides rich functions, is easy to use, and supports integrated PoE and HD Voice.

## Features

**Table 2-2** Key features of the eSpace [6805](#)

Feature	Description
Open standard compatibility	SIP 2.0, TCP/IP/UDP, RTP/RTC, HTTP/HTTPS, ARP/RARP, ICMP, DNS (A record and SRV record), DHCP, PPPoE, TFTP, NTP and Telnet.
High audio quality	Adopting the advanced DSP technology.
Traditional features	Standard voice features including caller ID display, call waiting, call holding, call transferring, call forwarding, call blocking, call rejecting, mute and off-hook autodial.

Feature	Description
Advanced functions	Supporting the following functions: <ul style="list-style-type: none"> <li>● Multi-lines</li> <li>● Headset enabled</li> <li>● Backlit graphic LCD</li> <li>● Five navigation keys</li> <li>● Function keys such as call holding, headset mode, call forward, three-party conference, do not disturb, address book, voice message box, and mute</li> </ul>
Advanced features	<ul style="list-style-type: none"> <li>● Customized ring tones</li> <li>● Download of ring tones</li> <li>● Download of address book in xml format and screensaver files</li> <li>● SRTP voice call encrypted with the <i>Advanced Encryption Standard (AES)</i></li> <li>● Setting of dialing rule and advance business functions, such as BroadSoft SCA</li> <li>● For details of advanced features, see the <i>Huawei IP Phone eSpace 6810&amp;6805&amp;6850&amp;6870 Administrator Manual</i></li> </ul>

## Hardware specifications

**Table 2-3** Hardware specifications

Item	Specification
Ethernet ports	Providing two Ethernet ports of 10/100 Mbit/s and full/half duplex Ethernet polarity can be automatically detected.
Graphic LCD display	Pixel:180 x <a href="#">60</a>
Headset port	RJ22 headset port and 2.5 mm earphone jack
LED	LED indicators that can be on in two colors (green and red)

Item	Specification
PoE	The build-in automatic detector obtains the PoE that is based on the IEEE 802.3af standard.
Universal switching	Input: 100–240 V AC 50Hz or 60Hz
Power adapter	Output: +5V DC, 1200mA, UL certified
Dimension (W × H × D)	222mm × 210mm × 93mm
Weight	0.98kg
Temperature	0°C to 40°C
Humidity	10% to 90% (non-condensing)
Compliance	FCC/CE/C-Tick

## Technical specifications

**Table 2-4** Technical specifications of the eSpace [6805](#)

Item	Specification
Lines	<a href="#">Two</a> straight-through lines.
Supported protocol	Supporting the SIP 2.0, TCP/UDP/IP, HTTP, HTTPS, PPPoE, RTP/RTCP, SRTP by SDES, HTTP, ARP/RARP, ICMP, DNS, DHCP, NTP, TFTP, NTP/SNTP, and SIMPLE/PRESENCE protocols.
	Supporting RFC3903, RFC3856, RFC3863, and RFC4235.
	Supporting RFC 3428. Up to 50 incoming IM messages can be stored. If more than 50 incoming IM messages are present, the system drops the latest IM message.
Function keys	<ul style="list-style-type: none"> <li>• <a href="#">Ten</a> dedicated keys: Hold, SEND, SPEAKER, Headset Mode, TRNF (transfer), CONF (conference), MUTE/DEL, DND, Phone Book, and MSG (message).</li> <li>• Five navigation keys.</li> <li>• <a href="#">Three</a> XML programmable soft keys.</li> </ul>
Device management	Supporting the upgrade of the NAT-friendly remote software (through TFTP or HTTP) for the devices that are deployed behind the firewall or the NAT.

Item	Specification
Audio features	Supporting the address book function.
	Handset, Hands-free, and headset modes in full duplex.
	Advanced DSP.
	Dynamic negotiation of codec and voice payload length.
	HD Voice.
	Supporting the G.723.1 (6.3K or 5.3K), G.729A/B, G.711 $\mu$ /A, G.726-32K, G.722 (broadband), and iLBC CODECS.
	In-band and out-of-band DTMF (in audio, RFC2833, or SIP INFO mode).
	Echo Cancellation. Supporting the sidetone cancellation, advanced jitter buffer control, and packet delay and loss concealment.
Telephony features	Intuitive GUI, download of the phone book (XML), voice mail indicator, download of custom ring tones. Call holding, call transferring (attended/blind), Do-Not-Disturb, call forwarding, call waiting, call waiting mute, redial, call log, volume control, caller ID display, multi-party conference call, dialing with a prefix, off-hook autodial, automatic answer, and dialing.
Network and provisioning	Supporting manual configuration for static network through keyboard and LCD, or by logging in to the Web page. Dynamic network parameters are provided by the DHCP server.
	Supporting NAT traversal by using IETF STUN and symmetric RTP.
	Supporting AES-based IP phone configuration file update. Supporting unified IP phone configuration through the BroadSoft XML Provision server.
	Supporting 802.1x-based network accessing authentication.
	Supporting the IEEE 802.1p/q tagging (VLAN) and Layer 3 ToS protocols.
Software upgrade	Supporting firmware upgrade through TFTP or HTTP and authentication of configuration files before changing.

Item	Specification
	Providing the specific URL for users to download configuration files and upgrade files.
Advanced server features	Message waiting indicator light. Supporting DNS SRV query.
Security	Supporting DIGEST authentication and encryption by using MD5, MD5-sess, and SRTP.

# 3 Installing the eSpace 6805

## Cable Connections of the eSpace 6805

Figure 3-1 Connecting the eSpace 6805

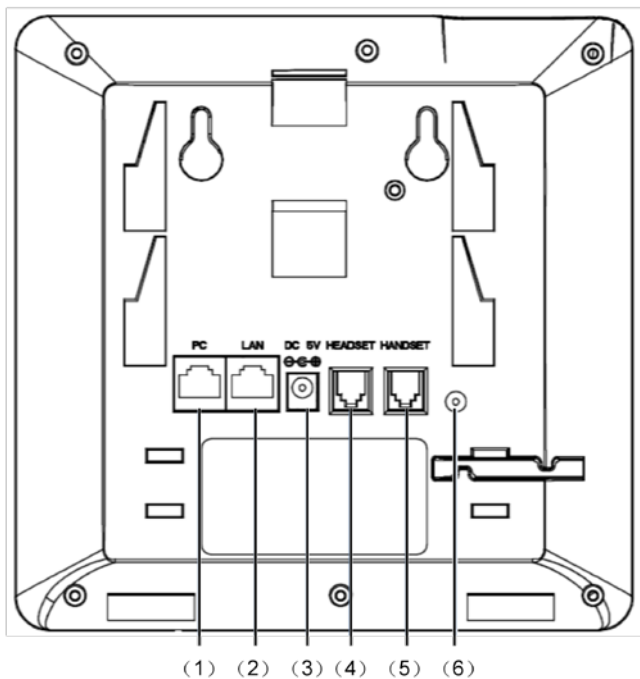



**Table 3-1** Description of the connectors

No.	Connector	Description
(1)	PC port	The port is the 10/100 Mbit/s RJ-45 PC port. You can use the straight-through cable to connect the PC port. When using the PC phone, you can configure the port. (Optional)
(2)	LAN port	The port is the 10/100 Mbit/s RJ-45 LAN port. You need to use the straight-through cable to connect the LAN port to the Ethernet port. The phone supports PoE (802.3af) power. In this case, you must connect the port to the switch supporting PoE power.
(3)	Power port	5V power port. After the network cable connection is complete, use the special power adapter of the phone to connect the power port and power to switch on the phone.
(4)	Headset port	RJ-22 port. If you want to use the headset for communication, install the headset socket to the port.
(5)	Handset port	RJ-22 port. If you want to use the headset for communication, install the headset socket to the port.

## Starting the eSpace [6805](#)

After the eSpace [6805](#) is powered on, a progress bar is displayed on its screen. This progress bar disappears after the startup page is accessed.

## Safety Compliance

The eSpace [6805](#) complies with the Federal Communications Commission (FCC), Conformance Européenne (CE), China Compulsory Certification (CCC), and various safety standards. The eSpace [6805](#) specialized power adapter is compliant with the Underwriter Laboratories (UL) standard. Use only the matching power adapter provided with the package. The manufacturer's warranty does not cover damages to the phone caused by unsupported power adapters.

## Warranty of Quality

If you purchased the eSpace [6805](#) from a distributor, contact the distributor for replacement, repair, or refund. If you purchased the product directly from Huawei, contact Huawei sales and service representatives for a return materials authorization (RMA) number before you return the product. Huawei reserves the right to remedy the warranty policy without prior notification.



Use a power adapter provided by the eSpace [6805](#); otherwise, damages can be caused to the products and the manufacturer warranty is void.

# 4 Configuring the eSpace [6805](#)

## Configuring the Phone Through the Keypad

To enter the configuration menu, press **MENU**. View the menu by pressing **UP**, **DOWN**, **LEFT**, or **RIGHT**. Press **MENU** to confirm the selection of a menu item, and delete an entry by pressing **BackSpace**. The phone automatically exits the menu when an incoming call comes or the phone is off-hook. If no keypad operation is performed within one minute, the IP phone automatically displays the standby image.

**Table 4-1** Keypad configuration menu

Menu	Configuration Description
Call History	Displays history records of received, dialed, transfered and missed calls.
Status	Displays the network status, account status, software version, MAC address, and hardware version of the phone.
Phone Book	Displays the phone book and related option. <ul style="list-style-type: none"><li>• [New Entry] Add a phone book record. After the fields such as <b>First Name</b>, <b>Last name</b>, <b>Number</b>, and <b>Acct</b> are set or selected, select <b>Confirm Add</b> and press <b>MENU</b> to confirm the operation. Select <b>Cancel &amp; Return</b> and press <b>MENU</b> to cancel the added information and return to the previous menu.</li><li>• [Download Phonebook] Select <b>Download Phonebook</b> and press <b>MENU</b>. Then the phone downloads the updated phone book from the TFTP or HTTP server. This requires corresponding configuration of the download items of the phone book on the Web page.</li><li>• [Delete All Entries] Delete all contacts in the phone book.</li></ul>

Menu	Configuration Description
Direct IP call	<p>The input field of the destination IP address is provided when <b>Direct IP call</b> is selected. Type the destination IP address such as <b>10.10.10.2</b>, press <b>OK</b> soft key to confirm the operation and send the call; press the <b>Cancel</b> soft key to cancel the call and return to previous menu. If the input information is incorrect, press <b>BackSpace</b> soft key to delete it.</p>
Preference	<p>Displays the preference submenus of a user.</p> <ul style="list-style-type: none"> <li>• [Do Not Disturb] Choose this menu to enable or disable the DND function.</li> <li>• [Ring Tone] Choose this menu to set different ring tones.</li> <li>• [Ring Volume] Press <b>MENU</b> to hear the selected ring volume. Press <b>LEFT</b> or <b>RIGHT</b> to turn up or turn down the volume.</li> <li>• [LCD Contrast] Choose this menu to set the LCD screen contrast.</li> <li>• [LCD Brightness] Set the LCD brightness of the IP phone in active and idle states. The value ranges from 0 to 8.</li> <li>• [Download SCR XML] Send a request to the HTTP/TFTP server for downloading a screen saver to replace the original one. For details on how to configure this service, see the <i>Huawei IP Phone eSpace 6810&amp;6805&amp;6850&amp;6870 Administrator Guide</i> or contact the administrator.</li> <li>• [Erase Custom SCR] Restore the factory setting for the standby image.</li> <li>• [Display Language] Choose this menu to select the language.</li> <li>• [Time Settings] Set the date and time of the IP phone.</li> </ul> <p>Press <b>LEFT</b> or select <b>Back</b> to return to the main menu.</p>

Menu	Configuration Description
Config	<p>Display the configuration submenus.</p> <ul style="list-style-type: none"> <li>• [SIP] Set the SIP server for each account, including <b>Account</b>, <b>SIP proxy</b>, <b>Outbound proxy</b>, <b>SIP user ID</b>, <b>SIP Auth ID</b>, <b>SIP password</b>, <b>SIP transport</b>, and <b>Audio CODECs</b>.</li> <li>• [Upgrade] Configure the firmware server and the file download server. Select either TFTP or HTTP to upgrade the firmware or configure the phone.</li> <li>• [Factory Reset] Type the MAC address on back of the phone. Press <b>OK</b> softkey to restore the factory reset settings. Factory reset clears all configurations and restores the phone to factory settings.</li> <li>• [Layer 2 QoS] Configure the 802.1Q VLAN tag and 802.1P priority.</li> </ul> <hr/> <p>Press <b>LEFT</b> or select <b>Back</b> to return to the main menu.</p>
Factory Functions	<p>These items are used for factory testing and not recommended for users.</p> <ul style="list-style-type: none"> <li>• [Audio Loopback] Speak to the handset. If you hear your voice in the handset, your audio works well. Press <b>MENU</b> to exit the mode.</li> <li>• [Diagnostic Mode] All LEDs are on. Press any key on the keypad to display the key name on the LCD. Pick up the handset or press <b>MENU</b> to exit the diagnostic mode.</li> </ul> <hr/> <p>Press <b>LEFT</b> or select <b>Back</b> to return to the main menu.</p>
Network	<p>Enable or disable the DHCP protocol. Set the IP address, subnet mask, and gateway address by using the keypad if the static IP mode is selected.</p>
Reboot	<p>Reboot the device.</p>
Exit	<p>Exit the menu.</p>

## Configuring the Phone Through Web Browser

The Web server embedded in the eSpace [6805](#) responds to the HTTP, HTTPS GET, or POST requests. Embedded HTML pages allow a user to configure the IP phone through any Web browser such as Microsoft Internet Explorer or Mozilla Firefox.

### Accessing the Web Configuration Menu

Connect the phone and computer on a reachable network. Do as follows:

Connect the computer to the same hub or switch as the phone is connected to. In absence of a hub/switch (or free ports on the hub/switch), connect the computer directly to the phone by using the PC port on the phone. Make sure that the phone is powered on and displays the IP address.

To access the Web configuration menu of the phone, do as follows:

- Step 1** Start the Web browser on your computer.
- Step 2** Enter the IP address of the phone in the address box of the browser. If the phone is properly connected to a working Internet. The format of the address is `xxx.xxx.xxx.xxx`, in which `xxx` stands for a number from 0-255. You can use this number to access the Web configuration menu. For example, if the phone displays **10.10.10.1**, enter **http://10.10.10.1** in the address box of the browser.
- Step 3** Enter the administrator password(the default password is **admin**.) to access the Web configuration menu.

**Figure 4-1** Login page



## Configuration Page

This section describes the options of **Status** and **Basic Settings** on the Web configuration page.

The functions available for the end user are as follows:

- **Status:** Display the network status, account status, software version, and MAC address of the phone.
- **Basic Settings:** Basic preferences such as date and time settings.

Figure 4-2 Status page

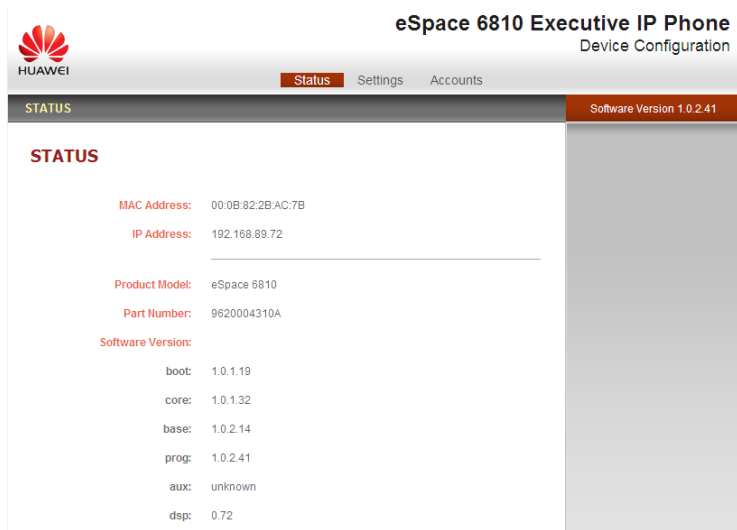

Table 4-2 Device configuration on the Status tab page

Field	Description
MAC Address	The device ID in the hexadecimal format. This is an important ID for service provider to solve problems.
IP Address	The IP address of the eSpace <a href="#">6805</a> .
Part Number	The code of a product.
Product Model	The product model.
Software Version	Information about the current software version. The value of <b>prog</b> indicates the main version number.
System Up Time	The power-on duration since the last reboot.
System Time	The current time of the system.
Registered	Whether accounts are registered on the related SIP server(s). The eSpace <a href="#">680</a> supports <a href="#">two</a> unique SIP accounts.



Field	Description
PPPoE Link Up	Whether the PPPoE connection is enabled when the phone is connected to a DSL modem.

**Figure 4-3** Basic setting page

**Table 4-3** Description of the basic setting page

Field	Description
End User Password	This parameter allows changing the login password of an end user. This field is case sensitive with a maximum length of 30 characters.

Field	Description
IP Address	<p>The eSpace 6805 operates in two modes:</p> <ul style="list-style-type: none"> <li>• DHCP/PPPoE Mode: All the field values for the static IP mode are not available even though they are stored in the Flash memory. The eSpace 6805 acquires its IP address from the first DHCP server that the eSpace 6805 detects on its LAN. To use the PPPoE feature, set the PPPoE account. The eSpace 6805 establishes a PPPoE session if any of the PPPoE fields are set. Host Name and Domain Name: The special DHCP options that are added to the DHCP Discover and DHCP Request after configuration. Preferred DNS: The eSpace 6805 uses the DNS server if <b>Preferred DNS</b> is configured.</li> <li>• Static IP Mode: Configure all of the following fields: <b>IP address</b>, <b>Subnet Mask</b>, <b>Gateway</b>, <b>Default Router IP address</b>, <b>DNS Server 1</b> (primary), and <b>DNS Server 2</b> (secondary).</li> </ul>
802.1X mode	<p>This parameter is set to perform the 802.1X authentication when the IP phone is connected to a switch. You can click <b>Disable</b> to disable the authentication function, and click <b>EAP-MD5</b> to perform the registration authentication.</p> <ul style="list-style-type: none"> <li>• Identify ID used during the 802.1x authentication</li> <li>• MD5 Password MD5 password used during the 802.1X authentication</li> </ul>
Line Keys	<p>This parameter is set for specifying function modes of line keys. By default, the value of <b>Key Mode</b> is <b>Line</b>, which is used by common lines. If the value of <b>Key Mode</b> is <b>Shared Line</b>, it indicates that the BroadSoft SCA functions are enabled and that accounts scattered in various areas can share the line.</p>
Time Zone	<p>This parameter controls the date and time display according to the specified time zone. If the <b>DHCP Option 2</b> is enabled, the DHCP server overrides and centrally controls the setting of <b>Time Zone</b> in the phone. The feature functions on the phone only when you set the NTP server correctly.</p>

Field	Description
LCD Backlight Brightness	This parameter is set for adjusting the LCD brightness of the IP phone in active and idle states. The value ranges from 0 to 8.
LCD Contrast	LCD contrast. The value ranges from 0 to 20.
Time Display Format	The LCD time is displayed in 12-hour or 24-hour format.
Disable in-call DTMF display	The default value is <b>No</b> . If the parameter is set to <b>Yes</b> , the DTMF digits that are pressed during the call will not be displayed on the LCD for security reasons.
Disable Missed Call Backlight	The default value is <b>No</b> . By default, the LCD backlight is on when a missed call exists.
HEADSET Key Mode	Select default answering or dialing mode as the headset mode. When selecting a default mode, press <b>HEADSET</b> to enter the headset dialing status. If you press <b>HEADSET</b> when setting <b>Toggle Headset/Speaker</b> , the headset icon is displayed on the LCD. In this case, press  , you can make a call or answer a call in Headset mode.
Call History Flash Writing	<p>This parameter is set for configuring the duration of recording data of Call History, Phone Book, and Settings on the Web configuration page into flash memory.</p> <ul style="list-style-type: none"> <li>• <b>Write Timeout</b> Write timeout indicates that the duration of flash writing. The range is 30-3600, in seconds. The default value is 300s.</li> <li>• <b>Max Unsaved Log</b> This parameter is set for adjusting the max flash writing items during the recording duration. The range is 0-500. 0 means this option is disabled.</li> </ul> <p>Do not change the value optionally. Consult the enterprise administrator before any change.</p>

## Saving the Configuration Changes

After changing the settings, click **Update** on the bottom of the page to save the change. If you want to change an item after submitting the setting, click a tab to access the configuration page. Then click **Reboot** to reboot the phone, and all the changes take effect.

## Rebooting the eSpace [6805](#) Remotely

Click **Reboot** in the configuration menu to reboot the eSpace [6805](#) remotely. Wait 60 seconds to log in again.

# 5 Using the eSpace [6805](#)



## Getting to Know the Keyboard

Figure 5-1 Getting to know the keypad



Table 5-1 eSpace [6805](#) keypad

Key	Description
<a href="#">LINE Key</a>	<ul style="list-style-type: none"><li>• <a href="#">Two</a> line keys with dual-color LED indicator lights. Each line key supports an independent SIP account.</li><li>• The <a href="#">two</a> line keys provide the hands-free feature.</li></ul>
TRANSFER	Transfer the current call to another number.
CONF	Set up a three-party conference call for the caller and callee.
MUTE	Mute the call (the other party cannot hear your voice).
HOLD	Hold the current call, and press the corresponding LINE key to resume the call.

Key	Description
	Press the key to receive voice mails or other messages.
	Press the key to enter the hands-free mode. Press it again to exit the hands-free mode.
	Press the key to display the phone book and associated items.
SEND	<p>Press the key to send a call after you have dialed phone numbers.</p> <p><b>Note:</b></p> <p>If you do not press <b>SEND</b>, the number will be sent after a pre-configured time delay.</p> <p>After the phone is off-hook, press the key to redial the last dialed number.</p>
HEADSET	Dial or answer with the headset.
MENU	<ul style="list-style-type: none"> <li>Enter the keypad configuration <b>MENU</b> mode when the phone is in idle mode.</li> <li>Use as <b>MENU</b> key to confirm the operation during keypad configuration.</li> </ul>
<0>-<9>,<*>, and <#>	Standard phone pad: 10 digits, the corresponding 26 alphanumeric letters, and special characters.
Soft keys 1- <a href="#">3</a>	XML soft keys, which can provide different functions, such as <b>BackSpace</b> and <b>Cancel</b> .



The operation of pressing **SEND** is effective only in the specified dialing time.

## Instructions of Using the Phone

### Handset, Speakerphone, and Headset Modes

You can switch the modes among handset, speakerphone, and headset.

- To switch between the handset and speakerphone modes, press **SPEAKER**, that is,



- To switch between the handset and headset modes, press **HEADSET**.
- To switch between the speakerphone and headset modes, press **HEADSET** or **SPEAKER**, that is, .

## Multiple SIP Accounts and Lines

The eSpace [6805](#) supports [two](#) independent SIP accounts. Each SIP account matches with a SIP server, users, and NAT. Each of the [two](#) line keys matches with one SIP account.

For example, set the account name of the two SIP accounts as **VoIP 1** and **VoIP 2**. Ensure that each account is activated and registered. When LINE1 is pressed, you will hear a dial tone and see "VoIP 1" on the LCD. When LINE2 is pressed, you will hear a dial tone and see "VoIP 2" on the LCD. When LINE1 is pressed, the LCD displays "VoIP 1." To make a call, select the line you wish to use. You can switch lines before dialing any number.

- When the phone is idle, press the corresponding key to answer the incoming call that is designated to an account.
- If the line is occupied, the LED of the next available LINE key blinks to remind you of an incoming call. This feature should be supported by the SIP server.

## Making a Call

### Dialing

You can use headset and handset or press  to make a phone call.

- Step 1** Pick up the handset; or press , or enable the headset. Or press a LINE $x$  key to activate the speakerphone. The corresponding LED is on.
- Step 2** Hear a dial tone. The LED light of the first line (LINE1) LED is on. You can also select another SIP account by pressing the corresponding LINE key.
- Step 3** Enter the phone number and press **SEND** or **Dial** soft key.

### Redialing

You can press **SEND** or the **Redial** soft key to redial the last dialed phone number. For the redialed number, the phone will use the same SIP account for dialing the last phone number.

### Dialing Through the Call History

Call a phone number from the phone's call history. When you dial a call from the history, the phone uses the same SIP account that is used for this call last time.

- Step 1** Press **MENU** to access the main menu.
- Step 2** Select **Call History** and press **MENU** to confirm.
- Step 3** Select **Answered Calls, Dialed Calls, Missed Calls, Transferred Calls** or **Forwarded Calls** depending on your requirements and press **MENU** to confirm.
- Step 4** Select a phone number by using arrow keys and press **Dial** soft key to dial the number.

## Dialing Through the Phone Book

You can call a number through the phone book.

Each entry in the phone book can be assigned with an individual SIP account. The phone uses the SIP account to make a phone call.

- Step 1** Access the phone book by:
  - Pressing **DOWN**.
  - Pressing .
  - Pressing **MENU**. Then select **Phone book** and press **MENU**.
- Step 2** Select a phone number by using arrow keys and press **MENU** to confirm.
- Step 3** Select **Dial** and press **MENU** to dial the number.

## Making a Call by Using an IP Address

Direct IP calls allow two phones to talk to each other in a special way without a SIP proxy. VoIP calls can be made between two phones when:

- Both phones have public IP addresses.
- Both phones obtain the private or public IP addresses on the same LAN network.
- Both phones can be connected through a router by using public or private IP addresses (with a valid port or DMZ).

All the necessary ports on the two phones must be enabled.

To make a direct IP call, do as follows:

- Step 1** Press **MENU** to access the main menu.
- Step 2** Select **Direct IP Call** by using the **UP** and **DOWN** keys.
- Step 3** Press **MENU** to confirm.
- Step 4** Type the destination IP address.
- Step 5** Press the **OK** soft key to initiate a call.



For example, if the destination IP address is 10.10.10.1, type **10\*10\*10\*1**. The \* key represents the dot.

## Quick IP Call Mode

Dial an IP address in the same LAN by typing the last octet of the IP address. This simulates a PBX function using the CMSA or CD without a SIP server. In this mode, the controlled static IP address is recommended.

On the **Advanced Settings** page, set **Use Quick IP-call Mode** to **Yes**. When **#xxx** is dialed (The range of **x** is 0–9 and **xxx** cannot be larger than 255.), a direct IP call is initiated as **aaa.bbb.ccc.XXX**. **aaa.bbb.ccc** is the local IP address regardless of the subnet mask. The numbers **#xx** or **#x** are also valid.

The following is an example.

- 10.10.10.2 calls 10.10.10.3 — dial **#3**, followed by SEND.
- 10.10.10.2 calls 10.10.10.23 — dial **#23**, followed by SEND.
- 10.10.10.2 calls 10.10.10.123 — dial **#123**, followed by SEND.



If the SIP server is configured, a direct IP-IP call still works. If you use the STUN, the direct IP-IP call also uses the STUN. Set **Use Random Port** to **No** when completing direct IP calls.

## Answering a Call

- An incoming call: The phone rings. The corresponding account LINE $x$  blinks. Pick up the handset, press , enable the headset, or press the blinking LINE $x$  key to answer the call.
- Multiple incoming calls: The call waiting tone is played. The next available line will blink in red. Answer an incoming call by pressing the LINE $x$  key.

## Do-Not-Disturb

To block all incoming calls, you can enable the Do-Not-Disturb (DND) function. The phone will not ring when an incoming call comes.

**Method 1:** When the phone is in idle mode, press DND to enable the DND function and press DND again to disable the DND function.

**Method 2:** Toggle the DND function as follows:

**Step 1** Press **MENU**.

**Step 2** Select **Preference** by pressing the arrow keys, and then press **MENU**.

**Step 3** Select **Do Not Disturb** by pressing the arrow keys and press **MENU**.

**Step 4** Select **Enable DND** or **Disable DND** and press **MENU**.

## Call Waiting/Call Holding

- **Hold:** Keep a call on hold by pressing **HOLD**.
- **Resume:** Resume the call by pressing the corresponding LINEx key with a blinking LED.
- **Multiple calls:** Automatically keep an active call on hold by selecting another available LINEx key or answering another call. If an incoming call comes when all lines are in use, the call waiting tone (discontinuous tone) is displayed.

## Muting

To enable or disable the muting function during a call, press **MUTE**. Then "LINEx: MUTE" is displayed on the LCD for the muted call.

## Call Transfer

The eSpace [6805](#) supports both blind and attended (or supervised) transfer:

### Blind transfer:

- Step 1** Pick up the handset; press , or enable the headset by pressing **HEADSET** to establish a conversation.
- Step 2** Press **TRANSFER** for a dial tone.
- Step 3** Dial the number of a third party and press **SEND** to transfer the active call.

### Attended (or supervised) transfer:



To transfer calls by one account, the other one must be unoccupied.

- Step 1** Pick up the handset; press , or enable the headset by pressing **HEADSET** to establish a conversation.
- Step 2** Press another available LINE key for a dial tone.
- Step 3** Dial the number of a third party and press **SEND**.
- Step 4** If the call is established, press **TRANSFER** and select the previous LINE key, the transfer is finished.
- If the call is not established, press the previous LINE key to return to the previous conversation.

- If the call is canceled and terminated before the call of the third party is connected, the eSpace 6805 rings, indicating that a call is held.



To transfer calls across different SIP domains, the VoIP service providers must support this feature.

## Three-Way Conference Call

The eSpace 6805 can host conference calls and support three-way conference calls.

### Initiating a Conference Call

- Step 1** Pick up the handset, press , or enable the headset by pressing **HEADSET** to establish a call.
- Step 2** Press another available **LINE** key to wait for the dial tone. Dial the phone number of the third party and press **SEND**. If the call is established, press **CONF** to initiate a three-way conference call. If the call is not established, press **LINEx** key to resume the previous call.
- Step 3** Press the previous **LINE** key to enable the call to join the conference.

### Ending a Conference Call

Press **HOLD** to pause the conference call and put all parties on hold. If you want to speak to an individual party, select the corresponding blinking **LINEx** key.

If the caller hangs up, the other two parties hang up automatically and the conference ends. If either the second party or the third party hangs up, the rest two parties establish the two-way conversation.

If both the second party and the third party hang up, the caller will hang up automatically. In this case, the conference ends.

## Voice Messages

A blinking red message waiting indicator (MWI) indicates a message is waiting. This function takes effective only when the **Subscribe for MWI** field is set to **Yes**. The default value is **No**. Press the  key to retrieve the message. The interactive voice response (IVR) system prompts the user to retrieve the message. Press a specific **LINEx** to retrieve messages for a specific line account.



Each line has a separate voice mail account. Each account requires a voice mail portal number to be configured through the **Voice Mail User ID** field.

The ways to check voice messages are as follows:

- Press  to check the voice message of the primary account.
- Check each line for waiting tone (discontinuous).

## Manager and Secretary Function

After a line of the manager's phone is bound to a line of the secretary's phone, all calls to the manager will be connected to the secretary's phone at the same time. The secretary determines whether to transfer the call to the manager.

Assume that manager A's phone has two lines. LINE 1 is bound to LINE 1 of secretary B's phone, and LINE 2 is a private line. The following describes the manager and secretary function's process.



For details on how to configure the manager and secretary service, see the *Huawei IP Phone eSpace 6810&6805&6850&6870 Administrator Manual* or contact the administrator.

**Step 1** Customer C calls manager A.

The phone of secretary B rings. The LINE 1 indicator on both manager A's phone and secretary B's phone blinks.

**Step 2** Secretary B presses the **LINE1** key and answers the call.

**Step 3** Secretary B presses the soft key **SeizeLine** soft key and enters the number of the manager A's private line to call manager A.

The call between secretary B and customer C is held.

**Step 4** Manager A presses the **LINE2** key and answers the call from secretary B.

**Step 5** Manager A presses the **LINE1** key and talks with customer C.

The call between manager A and secretary B is held. If secretary B hangs up, the call ends.

**Step 6** Manager A or customer C hangs up.

The call ends, and the LINE 1 indicator is off.

# 6 Restoring Factory Default Settings



Restoring the factory default settings can clear all configuration information about the eSpace [6805](#). Back up or print all the settings before you restore factory default settings. Huawei is not responsible for parameter loss or failier to connect to your VoIP service provider due to the operation of restoring the factory default settings.

To restore the factory default settings, do as follows:

**Step 1** Press **MENU** to access the keypad configuration UI menu, and select **Config**. Press **MENU** to access submenus, and select **Factory Reset**. For details, see Table 4-1.

**Step 2** Type the MAC address that is printed on the bottom of the sticker by using the following rules:

- 0–9: 0–9
- A: 22 (Press the **2** key twice and **A** is displayed on the LCD.)
- B: 222
- C: 2222
- D: 33 (Press the **3** key twice and **D** is displayed on the LCD.)
- E: 333
- F: 3333

For example, if the MAC address is **0018820E3956**, type **00188203333956**. The LCD displays the entered MAC address **0018820E3956**.



If digits are duplicate in the MAC address, for example, 22, you need to press **RIGHT** to move the cursor or wait for four seconds for typing another 2.

**Step 3** Press the **OK** soft key.

# 7 FAQs

Question: What codecs are supported by the eSpace [6805](#)?

Answer: The eSpace [6805](#) supports a wide range of codecs: G711 a/μ, G729, G723.1, G726-32k, G722 (broadband), GSM, and iLBC.

Question: How many VoIP accounts are supported on the eSpace [6805](#)?

Answer: The eSpace [6805](#) IP phone supports [two](#) different SIP (VoIP) accounts. These accounts can be on the same server or different servers of different service providers.

Question: How to reject an incoming call?

Answer: Press **Reject** softkey when receiving an incoming call or press **DND** to enable the DND function when the phone is idle. The call is rejected and forwarded to your voice mailbox if you configure the voice mailbox.

## **FCC Caution**

Any Changes or modifications not expressly approved by the party responsible for compliance could void the user's authority to operate the equipment. This device complies with part 15 of the FCC Rules. Operation is subject to the following two conditions: (1) This device may not cause harmful interference, and (2) this device must accept any interference received, including interference that may cause undesired operation.

**Note:** This equipment has been tested and found to comply with the limits for a Class B digital device, pursuant to part 15 of the FCC Rules. These limits are designed to provide reasonable protection against harmful interference in a residential installation. This equipment generates uses and can radiate radio frequency energy and, if not installed and used in accordance with the instructions, may cause harmful interference to radio communications. However, there is no guarantee that interference will not occur in a particular installation. If this equipment does cause harmful interference to radio or television reception, which can be determined by turning the equipment off and on, the user is encouraged to try to correct the interference by one or more of the following measures:

- Reorient or relocate the receiving antenna.
- Increase the separation between the equipment and receiver.
- Connect the equipment into an outlet on a circuit different from that to which the receiver is connected.
- Consult the dealer or an experienced radio/TV technician for help.



**HUAWEI TECHNOLOGIES CO., LTD.**

Huawei Industrial Base  
Bantian, Longgang  
Shenzhen 518129  
People's Republic of China

[www.huawei.com](http://www.huawei.com)