

FCC SAR Test Report

APPLICANT : TCL Communication Ltd.
EQUIPMENT : LTE / UMTS / GSM Band Mobile Phone
MODEL NAME : 7053E
FCC ID : 2ACCJB034
STANDARD : FCC 47 CFR Part 2 (2.1093)
ANSI/IEEE C95.1-1992
IEEE 1528-2013

We, SPORTON INTERNATIONAL (SHENZHEN) INC., would like to declare that the tested sample has been evaluated in accordance with the procedures and had been in compliance with the applicable technical standards.

The test results in this report apply exclusively to the tested model / sample. Without written approval of SPORTON INTERNATIONAL (SHENZHEN) INC., the test report shall not be reproduced except in full.



Prepared by: Mark Qu / Manager



Approved by: Jones Tsai / Manager



SPORTON INTERNATIONAL (SHENZHEN) INC.
1F & 2F, Building A, Morning Business Center, No. 4003 ShiGu Rd., Xili Town,
Nanshan District, Shenzhen, Guangdong, P. R. China



Table of Contents

1. Statement of Compliance 4

2. Administration Data 5

3. Guidance Standard 5

4. Equipment Under Test (EUT) Information 6

 4.1 General Information 6

 4.2 Specification of Accessory 7

 4.3 General LTE SAR Test and Reporting Considerations 8

5. RF Exposure Limits 10

 5.1 Uncontrolled Environment 10

 5.2 Controlled Environment 10

6. Specific Absorption Rate (SAR) 11

 6.1 Introduction 11

 6.2 SAR Definition 11

7. System Description and Setup 12

8. Measurement Procedures 13

 8.1 Spatial Peak SAR Evaluation 13

 8.2 Power Reference Measurement 14

 8.3 Area Scan 14

 8.4 Zoom Scan 15

 8.5 Volume Scan Procedures 15

 8.6 Power Drift Monitoring 15

9. Test Equipment List 16

10. System Verification 17

 10.1 Tissue Verification 17

 10.2 System Performance Check Results 18

11. RF Exposure Positions 19

 11.1 Ear and handset reference point 19

 11.2 Definition of the cheek position 20

 11.3 Definition of the tilt position 21

 11.4 Body Worn Accessory 22

 11.5 Wireless Router 22

12. Conducted RF Output Power (Unit: dBm) 23

13. Antenna Location 45

14. SAR Test Results 46

 14.1 Head SAR 48

 14.2 Hotspot SAR 51

 14.3 Body Worn Accessory SAR 55

 14.4 Repeated SAR Measurement 57

15. Simultaneous Transmission Analysis 58

 15.1 Head Exposure Conditions 59

 15.2 Hotspot Exposure Conditions 61

 15.3 Body-Worn Accessory Exposure Conditions 63

16. Uncertainty Assessment 65

17. References 67

Appendix A. Plots of System Performance Check

Appendix B. Plots of High SAR Measurement

Appendix C. DASY Calibration Certificate

Appendix D. Test Setup Photos



Revision History

REPORT NO.	VERSION	DESCRIPTION	ISSUED DATE
FA591604	Rev. 01	Initial issue of report	Oct. 26, 2015
FA591604	Rev. 02	Add BT head SAR test.	Oct. 29, 2015



1. Statement of Compliance

The maximum results of Specific Absorption Rate (SAR) found during testing for **TCL Communication Ltd., LTE / UMTS / GSM Band Mobile Phone, 7053E**, are as follows.

Equipment Class	Frequency Band	Highest SAR Summary			Highest Simultaneous Transmission 1g SAR (W/kg)
		Head (Separation 0mm)	Body-worn (Separation 10mm)	Wireless Router (Separation 10mm)	
		1g SAR (W/kg)	1g SAR (W/kg)	1g SAR (W/kg)	
PCE	GSM850	0.45	1.01	1.01	1.52
	GSM1900	0.21	0.71	1.01	
	WCDMA Band V	0.19	0.56	0.56	
	WCDMA Band IV	0.24	0.77	0.97	
	WCDMA Band II	0.32	0.99	1.52	
	LTE Band 12	0.20	0.44	0.44	
	LTE Band 5	0.31	0.71	0.71	
	LTE Band 4	0.32	0.69	0.90	
	LTE Band 2	0.20	0.88	1.29	
LTE Band 7	<0.10	0.32	0.65		
DTS	WLAN 2.4GHz Band	0.50	<0.10	0.19	1.52
DSS	Bluetooth	<0.10	<0.10		1.02
Date of Testing:		Sep. 28, 2015 ~ Oct. 28, 2015			

Note: The SAR value list above are all rounded to two decimal digits.

This device is in compliance with Specific Absorption Rate (SAR) for general population/uncontrolled exposure limits (1.6 W/kg) specified in FCC 47 CFR part 2 (2.1093) and ANSI/IEEE C95.1-1992, and had been tested in accordance with the measurement methods and procedures specified in IEEE 1528-2013 and FCC KDB publications



2. Administration Data

Testing Laboratory	
Test Site	SPORTON INTERNATIONAL (SHENZHEN) INC.
Test Site Location	1F & 2F, Building A, Morning Business Center, No. 4003 ShiGu Rd., Xili Town, Nanshan District, Shenzhen, Guangdong, P. R. China TEL: +86-755-8637-9589 FAX: +86-755-8637-9595

Applicant	
Company Name	TCL Communication Ltd.
Address	5F, C-Tower, No. 232, Liang Jing Road, ZhangJiang High-Tech Park, Pudong Area, Shanghai, 201203, P.R. China

Manufacturer	
Company Name	TCL Communication Ltd.
Address	5F, C-Tower, No. 232, Liang Jing Road, ZhangJiang High-Tech Park, Pudong Area, Shanghai, 201203, P.R. China

3. Guidance Standard

The Specific Absorption Rate (SAR) testing specification, method, and procedure for this device is in accordance with the following standards:

- FCC 47 CFR Part 2 (2.1093)
- ANSI/IEEE C95.1-1992
- IEEE 1528-2013
- FCC KDB 865664 D01 SAR Measurement 100 MHz to 6 GHz v01r04
- FCC KDB 865664 D02 SAR Reporting v01r02
- FCC KDB 447498 D01 General RF Exposure Guidance v06
- FCC KDB 648474 D04 SAR Evaluation Considerations for Wireless Handsets v01r03
- FCC KDB 248227 D01 802.11 Wi-Fi SAR v02r02
- FCC KDB 941225 D01 3G SAR Procedures v03r01
- FCC KDB 941225 D05 SAR for LTE Devices v02r04
- FCC KDB 941225 D06 Hotspot Mode SAR v02r01



4. Equipment Under Test (EUT) Information

4.1 General Information

Product Feature & Specification	
Equipment Name	LTE / UMTS / GSM Band Mobile Phone
Model Name	7053E
FCC ID	2ACCJB034
IMEI Code	014466000100229
Wireless Technology and Frequency Range	GSM850: 824.2 MHz ~ 848.8 MHz GSM1900: 1850.2 MHz ~ 1909.8 MHz WCDMA Band II: 1852.4 MHz ~ 1907.6 MHz WCDMA Band IV: 1712.4 MHz ~ 1752.6 MHz WCDMA Band V: 826.4 MHz ~ 846.6 MHz LTE Band 2: 1850.7 MHz ~ 1909.3 MHz LTE Band 4: 1710.7 MHz ~ 1754.3 MHz LTE Band 5: 824.7 MHz ~ 848.3 MHz LTE Band 7: 2502.5 MHz ~ 2567.5 MHz LTE Band 12: 699.7 MHz ~ 715.3 MHz LTE Band 17: 706.5 MHz ~ 713.5 MHz WLAN 2.4GHz Band: 2412 MHz ~ 2462 MHz Bluetooth: 2402 MHz ~ 2480 MHz
Mode	<ul style="list-style-type: none"> · GSM/GPRS/EGPRS · RMC/AMR 12.2Kbps · HSDPA · HSUPA · DC-HSDPA · HSPA+ (16QAM uplink is not supported) · LTE: QPSK, 16QAM · 802.11b/g/n HT20 · Bluetooth v3.0+EDR, Bluetooth v4.0 LE
HW Version	PIO
SW Version	V1.0
GSM / (E)GPRS Transfer mode	Class B – EUT cannot support Packet Switched and Circuit Switched Network simultaneously but can automatically switch between Packet and Circuit Switched Network.
EUT Stage	Production Unit
Remark: <ol style="list-style-type: none"> 1. This device 2.4GHz supports hotspot operation and 802.11n-HT40 is not supported in 2.4GHz WLAN. 2. This device supported VoIP in GPRS, EGPRS, WCDMA and LTE (e.g. 3rd party VoIP). 3. This device supports GRPS/EGPRS mode up to multi-slot class 12. 4. This device does not support DTM operation. 	

4.2 Specification of Accessory

Specification of Accessory			
AC Adapter	Brand Name	TENPAO	Model Name UC11US
	Power Rating	I/P: 100-240Vac, 200mA, O/P: 5Vdc, 1000mA	
	P/N	CBA0058AG0C2	
Battery	Brand Name	JIADÉ	Model Name TLp021CF
	Power Rating	3.8Vdc, 2150mAh	
	S/N	C2150009CFJ004UV	
USB Cable 1	Brand Name	JUWEI	Model Name CDA0000025C2
	Signal Line Type	1.0m, shielded cable, without core	
USB Cable 2	Brand Name	JUWEI	Model Name CDA0000026C2
	Signal Line Type	1.0m, shielded cable, without core	
Earphone 1	Brand Name	JUWEI	Model Name CCB0023A10C1
	Signal Line Type	1.2m, non-shielded cable, without core	
Earphone 2	Brand Name	JUWEI	Model Name CCB0023B10C1
	Signal Line Type	1.2m, non-shielded cable, without core	



4.3 General LTE SAR Test and Reporting Considerations

Summarized necessary items addressed in KDB 941225 D05 v02r04																																															
FCC ID	2ACCJB034																																														
Equipment Name	LTE / UMTS / GSM Band Mobile Phone																																														
Operating Frequency Range of each LTE transmission band	LTE Band 2: 1850.7 MHz ~ 1909.3 MHz LTE Band 4: 1710.7 MHz ~ 1754.3 MHz LTE Band 5: 824.7 MHz ~ 848.3 MHz LTE Band 7: 2502.5 MHz ~ 2567.5 MHz LTE Band 12: 699.7 MHz ~ 715.3 MHz LTE Band 17: 706.5 MHz ~ 713.5 MHz																																														
Channel Bandwidth	LTE Band 2: 1.4MHz, 3MHz, 5MHz, 10MHz, 15MHz, 20MHz LTE Band 4: 1.4MHz, 3MHz, 5MHz, 10MHz, 15MHz, 20MHz LTE Band 5: 1.4MHz, 3MHz, 5MHz, 10MHz LTE Band 7: 5MHz, 10MHz, 15MHz, 20MHz LTE Band 12: 1.4MHz, 3MHz, 5MHz, 10MHz LTE Band 17: 5MHz, 10MHz																																														
uplink modulations used	QPSK, and 16QAM																																														
LTE Voice / Data requirements	Data only																																														
LTE MPR permanently built-in by design	<table border="1"> <thead> <tr> <th colspan="8">Table 6.2.3-1: Maximum Power Reduction (MPR) for Power Class 3</th> </tr> <tr> <th rowspan="2">Modulation</th> <th colspan="6">Channel bandwidth / Transmission bandwidth (RB)</th> <th rowspan="2">MPR (dB)</th> </tr> <tr> <th>1.4 MHz</th> <th>3.0 MHz</th> <th>5 MHz</th> <th>10 MHz</th> <th>15 MHz</th> <th>20 MHz</th> </tr> </thead> <tbody> <tr> <td>QPSK</td> <td>> 5</td> <td>> 4</td> <td>> 8</td> <td>> 12</td> <td>> 16</td> <td>> 18</td> <td>≤ 1</td> </tr> <tr> <td>16 QAM</td> <td>≤ 5</td> <td>≤ 4</td> <td>≤ 8</td> <td>≤ 12</td> <td>≤ 16</td> <td>≤ 18</td> <td>≤ 1</td> </tr> <tr> <td>16 QAM</td> <td>> 5</td> <td>> 4</td> <td>> 8</td> <td>> 12</td> <td>> 16</td> <td>> 18</td> <td>≤ 2</td> </tr> </tbody> </table>	Table 6.2.3-1: Maximum Power Reduction (MPR) for Power Class 3								Modulation	Channel bandwidth / Transmission bandwidth (RB)						MPR (dB)	1.4 MHz	3.0 MHz	5 MHz	10 MHz	15 MHz	20 MHz	QPSK	> 5	> 4	> 8	> 12	> 16	> 18	≤ 1	16 QAM	≤ 5	≤ 4	≤ 8	≤ 12	≤ 16	≤ 18	≤ 1	16 QAM	> 5	> 4	> 8	> 12	> 16	> 18	≤ 2
Table 6.2.3-1: Maximum Power Reduction (MPR) for Power Class 3																																															
Modulation	Channel bandwidth / Transmission bandwidth (RB)						MPR (dB)																																								
	1.4 MHz	3.0 MHz	5 MHz	10 MHz	15 MHz	20 MHz																																									
QPSK	> 5	> 4	> 8	> 12	> 16	> 18	≤ 1																																								
16 QAM	≤ 5	≤ 4	≤ 8	≤ 12	≤ 16	≤ 18	≤ 1																																								
16 QAM	> 5	> 4	> 8	> 12	> 16	> 18	≤ 2																																								
LTE Release Version	R8. Cat 4																																														
LTE A-MPR	In the base station simulator configuration, Network Setting value is set to NS_01 to disable A-MPR during SAR testing and the LTE SAR tests was transmitting on all TTI frames (Maximum TTI)																																														
Spectrum plots for RB configuration	A properly configured base station simulator was used for the SAR and power measurement; therefore, spectrum plots for each RB allocation and offset configuration are not included in the SAR report.																																														



Transmission (H, M, L) channel numbers and frequencies in each LTE band																
LTE Band 2																
	Bandwidth 1.4 MHz		Bandwidth 3 MHz		Bandwidth 5 MHz		Bandwidth 10 MHz		Bandwidth 15 MHz		Bandwidth 20 MHz					
	Ch. #	Freq. (MHz)	Ch. #	Freq. (MHz)	Ch. #	Freq. (MHz)	Ch. #	Freq. (MHz)	Ch. #	Freq. (MHz)	Ch. #	Freq. (MHz)				
L	18607	1850.7	18615	1851.5	18625	1852.5	18650	1855	18675	1857.5	18700	1860				
M	18900	1880	18900	1880	18900	1880	18900	1880	18900	1880	18900	1880				
H	19193	1909.3	19185	1908.5	19175	1907.5	19150	1905	19125	1902.5	19100	1900				
LTE Band 4																
	Bandwidth 1.4 MHz		Bandwidth 3 MHz		Bandwidth 5 MHz		Bandwidth 10 MHz		Bandwidth 15 MHz		Bandwidth 20 MHz					
	Ch. #	Freq. (MHz)	Ch. #	Freq. (MHz)	Ch. #	Freq. (MHz)	Ch. #	Freq. (MHz)	Ch. #	Freq. (MHz)	Ch. #	Freq. (MHz)				
L	19957	1710.7	19965	1711.5	19975	1712.5	20000	1715	20025	1717.5	20050	1720				
M	20175	1732.5	20175	1732.5	20175	1732.5	20175	1732.5	20175	1732.5	20175	1732.5				
H	20393	1754.3	20385	1753.5	20375	1752.5	20350	1750	20325	1747.5	20300	1745				
LTE Band 5																
	Bandwidth 1.4 MHz		Bandwidth 3 MHz		Bandwidth 5 MHz		Bandwidth 10 MHz		Bandwidth 15 MHz		Bandwidth 20 MHz					
	Ch. #	Freq. (MHz)	Ch. #	Freq. (MHz)	Ch. #	Freq. (MHz)	Ch. #	Freq. (MHz)	Ch. #	Freq. (MHz)	Ch. #	Freq. (MHz)				
L	20407	824.7	20415	825.5	20425	826.5	20450	829	20450	829	20450	829				
M	20525	836.5	20525	836.5	20525	836.5	20525	836.5	20525	836.5	20525	836.5				
H	20643	848.3	20635	847.5	20625	846.5	20600	844	20600	844	20600	844				
LTE Band 7																
	Bandwidth 5 MHz		Bandwidth 10 MHz		Bandwidth 15 MHz		Bandwidth 20 MHz		Bandwidth 15 MHz		Bandwidth 20 MHz					
	Ch. #	Freq. (MHz)	Ch. #	Freq. (MHz)	Ch. #	Freq. (MHz)	Ch. #	Freq. (MHz)	Ch. #	Freq. (MHz)	Ch. #	Freq. (MHz)				
L	20775	2502.5	20800	2505	20825	2507.5	20850	2510	20850	2510	20850	2510				
M	21100	2535	21100	2535	21100	2535	21100	2535	21100	2535	21100	2535				
H	21425	2567.5	21400	2565	21375	2562.5	21350	2560	21350	2560	21350	2560				
LTE Band 12																
	Bandwidth 1.4 MHz		Bandwidth 3 MHz		Bandwidth 5 MHz		Bandwidth 10 MHz		Bandwidth 15 MHz		Bandwidth 20 MHz					
	Ch. #	Freq. (MHz)	Ch. #	Freq. (MHz)	Ch. #	Freq. (MHz)	Ch. #	Freq. (MHz)	Ch. #	Freq. (MHz)	Ch. #	Freq. (MHz)				
L	23017	699.7	23025	700.5	23035	701.5	23060	704	23060	704	23060	704				
M	23095	707.5	23095	707.5	23095	707.5	23095	707.5	23095	707.5	23095	707.5				
H	23173	715.3	23165	714.5	23155	713.5	23130	711	23130	711	23130	711				
LTE Band 17																
	Bandwidth 5 MHz				Bandwidth 10 MHz				Bandwidth 15 MHz				Bandwidth 20 MHz			
	Channel #		Freq.(MHz)		Channel #		Freq. (MHz)		Channel #		Freq. (MHz)		Channel #		Freq. (MHz)	
L	23755		706.5		23780		709		23780		709		23780		709	
M	23790		710		23790		710		23790		710		23790		710	
H	23825		713.5		23800		711		23800		711		23800		711	



5. RF Exposure Limits

5.1 Uncontrolled Environment

Uncontrolled Environments are defined as locations where there is the exposure of individuals who have no knowledge or control of their exposure. The general population/uncontrolled exposure limits are applicable to situations in which the general public may be exposed or in which persons who are exposed as a consequence of their employment may not be made fully aware of the potential for exposure or cannot exercise control over their exposure. Members of the general public would come under this category when exposure is not employment-related; for example, in the case of a wireless transmitter that exposes persons in its vicinity.

5.2 Controlled Environment

Controlled Environments are defined as locations where there is exposure that may be incurred by persons who are aware of the potential for exposure, (i.e. as a result of employment or occupation). In general, occupational/controlled exposure limits are applicable to situations in which persons are exposed as a consequence of their employment, who have been made fully aware of the potential for exposure and can exercise control over their exposure. The exposure category is also applicable when the exposure is of a transient nature due to incidental passage through a location where the exposure levels may be higher than the general population/uncontrolled limits, but the exposed person is fully aware of the potential for exposure and can exercise control over his or her exposure by leaving the area or by some other appropriate means.

Limits for Occupational/Controlled Exposure (W/kg)

Whole-Body	Partial-Body	Hands, Wrists, Feet and Ankles
0.4	8.0	20.0

Limits for General Population/Uncontrolled Exposure (W/kg)

Whole-Body	Partial-Body	Hands, Wrists, Feet and Ankles
0.08	1.6	4.0

1. Whole-Body SAR is averaged over the entire body, partial-body SAR is averaged over any 1gram of tissue defined as a tissue volume in the shape of a cube. SAR for hands, wrists, feet and ankles is averaged over any 10 grams of tissue defined as a tissue volume in the shape of a cube.

6. Specific Absorption Rate (SAR)

6.1 Introduction

SAR is related to the rate at which energy is absorbed per unit mass in an object exposed to a radio field. The SAR distribution in a biological body is complicated and is usually carried out by experimental techniques or numerical modeling. The standard recommends limits for two tiers of groups, occupational/controlled and general population/uncontrolled, based on a person's awareness and ability to exercise control over his or her exposure. In general, occupational/controlled exposure limits are higher than the limits for general population/uncontrolled.

6.2 SAR Definition

The SAR definition is the time derivative (rate) of the incremental energy (dW) absorbed by (dissipated in) an incremental mass (dm) contained in a volume element (dv) of a given density (ρ). The equation description is as below:

$$SAR = \frac{d}{dt} \left(\frac{dW}{dm} \right) = \frac{d}{dt} \left(\frac{dW}{\rho dv} \right)$$

SAR is expressed in units of Watts per kilogram (W/kg)

$$SAR = \frac{\sigma |E|^2}{\rho}$$

Where: σ is the conductivity of the tissue, ρ is the mass density of the tissue and E is the RMS electrical field strength.

7. System Description and Setup

The DASY system used for performing compliance tests consists of the following items:

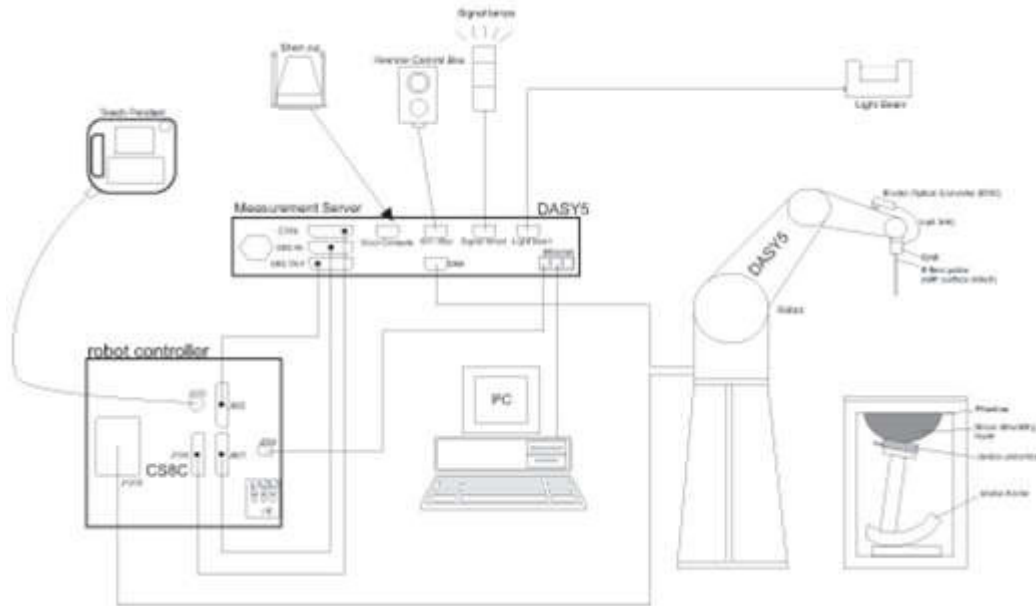

- A standard high precision 6-axis robot with controller, teach pendant and software. An arm extension for accommodating the data acquisition electronics (DAE).
- An isotropic Field probe optimized and calibrated for the targeted measurement.
- A data acquisition electronics (DAE) which performs the signal amplification, signal multiplexing, AD-conversion, offset measurements, mechanical surface detection, collision detection, etc. The unit is battery powered with standard or rechargeable batteries. The signal is optically transmitted to the EOC.
- The Electro-optical converter (EOC) performs the conversion from optical to electrical signals for the digital communication to the DAE. To use optical surface detection, a special version of the EOC is required. The EOC signal is transmitted to the measurement server.
- The function of the measurement server is to perform the time critical tasks such as signal filtering, control of the robot operation and fast movement interrupts.
- The Light Beam used is for probe alignment. This improves the (absolute) accuracy of the probe positioning.
- A computer running WinXP or Win7 and the DASY5 software.
- Remote control and teach pendant as well as additional circuitry for robot safety such as warning lamps, etc.
- The phantom, the device holder and other accessories according to the targeted measurement.

8. Measurement Procedures

The measurement procedures are as follows:

<Conducted power measurement>

- (a) For WWAN power measurement, use base station simulator to configure EUT WWAN transmission in conducted connection with RF cable, at maximum power in each supported wireless interface and frequency band.
- (b) Read the WWAN RF power level from the base station simulator.
- (c) For WLAN/BT power measurement, use engineering software to configure EUT WLAN/BT continuously transmission, at maximum RF power in each supported wireless interface and frequency band
- (d) Connect EUT RF port through RF cable to the power meter, and measure WLAN/BT output power

<SAR measurement>

- (a) Use base station simulator to configure EUT WWAN transmission in radiated connection, and engineering software to configure EUT WLAN/BT continuously transmission, at maximum RF power, in the highest power channel.
- (b) Place the EUT in the positions as Appendix D demonstrates.
- (c) Set scan area, grid size and other setting on the DASY software.
- (d) Measure SAR results for the highest power channel on each testing position.
- (e) Find out the largest SAR result on these testing positions of each band
- (f) Measure SAR results for other channels in worst SAR testing position if the reported SAR of highest power channel is larger than 0.8 W/kg

According to the test standard, the recommended procedure for assessing the peak spatial-average SAR value consists of the following steps:

- (a) Power reference measurement
- (b) Area scan
- (c) Zoom scan
- (d) Power drift measurement

8.1 Spatial Peak SAR Evaluation

The procedure for spatial peak SAR evaluation has been implemented according to the test standard. It can be conducted for 1g and 10g, as well as for user-specific masses. The DASY software includes all numerical procedures necessary to evaluate the spatial peak SAR value.

The base for the evaluation is a "cube" measurement. The measured volume must include the 1g and 10g cubes with the highest averaged SAR values. For that purpose, the center of the measured volume is aligned to the interpolated peak SAR value of a previously performed area scan.

The entire evaluation of the spatial peak values is performed within the post-processing engine (SEMCAD). The system always gives the maximum values for the 1g and 10g cubes. The algorithm to find the cube with highest averaged SAR is divided into the following stages:

- (a) Extraction of the measured data (grid and values) from the Zoom Scan
- (b) Calculation of the SAR value at every measurement point based on all stored data (A/D values and measurement parameters)
- (c) Generation of a high-resolution mesh within the measured volume
- (d) Interpolation of all measured values from the measurement grid to the high-resolution grid
- (e) Extrapolation of the entire 3-D field distribution to the phantom surface over the distance from sensor to surface
- (f) Calculation of the averaged SAR within masses of 1g and 10g

8.2 Power Reference Measurement

The Power Reference Measurement and Power Drift Measurements are for monitoring the power drift of the device under test in the batch process. The minimum distance of probe sensors to surface determines the closest measurement point to phantom surface. This distance cannot be smaller than the distance of sensor calibration points to probe tip as defined in the probe properties.

8.3 Area Scan

The area scan is used as a fast scan in two dimensions to find the area of high field values, before doing a fine measurement around the hot spot. The sophisticated interpolation routines implemented in DASY software can find the maximum found in the scanned area, within a range of the global maximum. The range (in dB) is specified in the standards for compliance testing. For example, a 2 dB range is required in IEEE standard 1528 and IEC 62209 standards, whereby 3 dB is a requirement when compliance is assessed in accordance with the ARIB standard (Japan), if only one zoom scan follows the area scan, then only the absolute maximum will be taken as reference. For cases where multiple maximums are detected, the number of zoom scans has to be increased accordingly.

Area scan parameters extracted from FCC KDB 865664 D01v01r04 SAR measurement 100 MHz to 6 GHz.

	≤ 3 GHz	> 3 GHz
Maximum distance from closest measurement point (geometric center of probe sensors) to phantom surface	5 ± 1 mm	$\frac{1}{2} \cdot \delta \cdot \ln(2) \pm 0.5$ mm
Maximum probe angle from probe axis to phantom surface normal at the measurement location	30° ± 1°	20° ± 1°
Maximum area scan spatial resolution: $\Delta x_{Area}, \Delta y_{Area}$	≤ 2 GHz: ≤ 15 mm 2 – 3 GHz: ≤ 12 mm	3 – 4 GHz: ≤ 12 mm 4 – 6 GHz: ≤ 10 mm
	When the x or y dimension of the test device, in the measurement plane orientation, is smaller than the above, the measurement resolution must be ≤ the corresponding x or y dimension of the test device with at least one measurement point on the test device.	

8.4 Zoom Scan

Zoom scans are used assess the peak spatial SAR values within a cubic averaging volume containing 1 gram and 10 gram of simulated tissue. The zoom scan measures points (refer to table below) within a cube shoes base faces are centered on the maxima found in a preceding area scan job within the same procedure. When the measurement is done, the zoom scan evaluates the averaged SAR for 1 gram and 10 gram and displays these values next to the job's label.

Zoom scan parameters extracted from FCC KDB 865664 D01v01r04 SAR measurement 100 MHz to 6 GHz.

		≤ 3 GHz	> 3 GHz	
Maximum zoom scan spatial resolution: Δx_{Zoom} , Δy_{Zoom}		≤ 2 GHz: ≤ 8 mm 2 – 3 GHz: ≤ 5 mm*	3 – 4 GHz: ≤ 5 mm* 4 – 6 GHz: ≤ 4 mm*	
Maximum zoom scan spatial resolution, normal to phantom surface	uniform grid: $\Delta z_{Zoom}(n)$	≤ 5 mm	3 – 4 GHz: ≤ 4 mm 4 – 5 GHz: ≤ 3 mm 5 – 6 GHz: ≤ 2 mm	
	graded grid	$\Delta z_{Zoom}(1)$: between 1 st two points closest to phantom surface	≤ 4 mm	3 – 4 GHz: ≤ 3 mm 4 – 5 GHz: ≤ 2.5 mm 5 – 6 GHz: ≤ 2 mm
		$\Delta z_{Zoom}(n>1)$: between subsequent points	$\leq 1.5 \cdot \Delta z_{Zoom}(n-1)$	
Minimum zoom scan volume	x, y, z	≥ 30 mm	3 – 4 GHz: ≥ 28 mm 4 – 5 GHz: ≥ 25 mm 5 – 6 GHz: ≥ 22 mm	
Note: δ is the penetration depth of a plane-wave at normal incidence to the tissue medium; see draft standard IEEE P1528-2011 for details. * When zoom scan is required and the <i>reported</i> SAR from the <i>area scan based 1-g SAR estimation</i> procedures of KDB 447498 is ≤ 1.4 W/kg, ≤ 8 mm, ≤ 7 mm and ≤ 5 mm zoom scan resolution may be applied, respectively, for 2 GHz to 3 GHz, 3 GHz to 4 GHz and 4 GHz to 6 GHz.				

8.5 Volume Scan Procedures

The volume scan is used for assess overlapping SAR distributions for antennas transmitting in different frequency bands. It is equivalent to an oversized zoom scan used in standalone measurements. The measurement volume will be used to enclose all the simultaneous transmitting antennas. For antennas transmitting simultaneously in different frequency bands, the volume scan is measured separately in each frequency band. In order to sum correctly to compute the 1g aggregate SAR, the EUT remain in the same test position for all measurements and all volume scan use the same spatial resolution and grid spacing. When all volume scan were completed, the software, SEMCAD postprocessor can combine and subsequently superpose these measurement data to calculating the multiband SAR.

8.6 Power Drift Monitoring

All SAR testing is under the EUT install full charged battery and transmit maximum output power. In DASy measurement software, the power reference measurement and power drift measurement procedures are used for monitoring the power drift of EUT during SAR test. Both these procedures measure the field at a specified reference position before and after the SAR testing. The software will calculate the field difference in dB. If the power drifts more than 5%, the SAR will be retested.



9. Test Equipment List

Table with 6 columns: Manufacturer, Name of Equipment, Type/Model, Serial Number, Last Cal., Due Date. Rows include various test equipment like SPEAG System Validation Kits, Anritsu analyzers, Agilent test sets, etc.

General Note:

- 1. Prior to system verification and validation, the path loss from the signal generator to the system check source and the power meter, which includes the amplifier, cable, attenuator and directional coupler, was measured by the network analyzer.



10. System Verification

10.1 Tissue Verification

The following tissue formulations are provided for reference only as some of the parameters have not been thoroughly verified. The composition of ingredients may be modified accordingly to achieve the desired target tissue parameters required for routine SAR evaluation.

Frequency (MHz)	Water (%)	Sugar (%)	Cellulose (%)	Salt (%)	Preventol (%)	DGBE (%)	Conductivity (σ)	Permittivity (ϵ_r)
For Head								
750	41.1	57.0	0.2	1.4	0.2	0	0.89	41.9
835	40.3	57.9	0.2	1.4	0.2	0	0.90	41.5
1800, 1900, 2000	55.2	0	0	0.3	0	44.5	1.40	40.0
2450	55.0	0	0	0	0	45.0	1.80	39.2
2600	54.8	0	0	0.1	0	45.1	1.96	39.0
For Body								
750	51.7	47.2	0	0.9	0.1	0	0.96	55.5
835	50.8	48.2	0	0.9	0.1	0	0.97	55.2
1800, 1900, 2000	70.2	0	0	0.4	0	29.4	1.52	53.3
2450	68.6	0	0	0	0	31.4	1.95	52.7
2600	68.1	0	0	0.1	0	31.8	2.16	52.5

<Tissue Dielectric Parameter Check Results>

Frequency (MHz)	Tissue Type	Liquid Temp. (°C)	Conductivity (σ)	Permittivity (ϵ_r)	Conductivity Target (σ)	Permittivity Target (ϵ_r)	Delta (σ) (%)	Delta (ϵ_r) (%)	Limit (%)	Date
750	Head	22.8	0.890	40.918	0.89	41.90	0.00	-2.34	±5	Oct. 05, 2015
835	Head	22.6	0.910	42.910	0.90	41.50	1.11	3.40	±5	Oct. 05, 2015
1750	Head	22.8	1.392	40.573	1.37	40.10	1.61	1.18	±5	Oct. 07, 2015
1900	Head	22.7	1.452	39.039	1.40	40.00	3.71	-2.40	±5	Oct. 07, 2015
2450	Head	22.9	1.729	37.305	1.80	39.20	-3.94	-4.83	±5	Oct. 09, 2015
2450	Head	22.9	1.752	39.797	1.80	39.20	-2.67	1.52	±5	Oct. 28, 2015
2600	Head	22.7	2.055	38.316	1.96	39.00	4.85	-1.75	±5	Oct. 10, 2015
750	Body	22.6	0.970	54.642	0.96	55.50	1.04	-1.55	±5	Sep. 29, 2015
835	Body	22.7	0.961	55.830	0.97	55.20	-0.93	1.14	±5	Sep. 28, 2015
835	Body	22.7	0.998	54.379	0.97	55.20	2.89	-1.49	±5	Sep. 29, 2015
1750	Body	22.9	1.514	53.575	1.49	53.40	1.61	0.33	±5	Sep. 29, 2015
1750	Body	22.8	1.522	52.519	1.49	53.40	2.15	-1.65	±5	Sep. 30, 2015
1900	Body	22.8	1.551	54.273	1.52	53.30	2.04	1.83	±5	Sep. 29, 2015
1900	Body	22.7	1.584	54.212	1.52	53.30	4.21	1.71	±5	Sep. 30, 2015
2450	Body	22.6	2.033	50.608	1.95	52.70	4.26	-3.97	±5	Oct. 09, 2015
2600	Body	22.8	2.217	50.697	2.16	52.50	2.64	-3.43	±5	Oct. 09, 2015

10.2 System Performance Check Results

Comparing to the original SAR value provided by SPEAG, the verification data should be within its specification of 10 %. Below table shows the target SAR and measured SAR after normalized to 1W input power. The table below indicates the system performance check can meet the variation criterion and the plots can be referred to Appendix A of this report.

Date	Frequency (MHz)	Tissue Type	Input Power (mW)	Dipole S/N	Probe S/N	DAE S/N	Measured SAR (W/kg)	Targeted SAR (W/kg)	Normalized SAR (W/kg)	Deviation (%)
Oct. 05, 2015	750	Head	250	1065	3958	1386	1.89	8.14	7.56	-7.13
Oct. 05, 2015	835	Head	250	4d091	3958	1386	2.36	9.11	9.44	3.62
Oct. 07, 2015	1750	Head	250	1069	3958	1386	9.54	37.10	38.16	2.86
Oct. 07, 2015	1900	Head	250	5d118	3958	1386	10.50	40.10	42	4.74
Oct. 09, 2015	2450	Head	250	926	3958	1386	12.80	52.10	51.2	-1.73
Oct. 28, 2015	2450	Head	250	926	3958	1386	13.00	52.10	52	-0.19
Oct. 10, 2015	2600	Head	250	1061	3958	1386	13.50	56.90	54	-5.10
Sep. 29, 2015	750	Body	250	1065	3958	1386	2.32	8.64	9.28	7.41
Sep. 28, 2015	835	Body	250	4d091	3958	1386	2.49	9.60	9.96	3.75
Sep. 29, 2015	835	Body	250	4d091	3958	1386	2.25	9.60	9	-6.25
Sep. 29, 2015	1750	Body	250	1069	3958	1386	9.06	38.10	36.24	-4.88
Sep. 30, 2015	1750	Body	250	1069	3958	1386	9.04	38.10	36.16	-5.09
Sep. 29, 2015	1900	Body	250	5d118	3958	1386	9.83	40.00	39.32	-1.7
Sep. 30, 2015	1900	Body	250	5d118	3958	1386	10.10	40.00	40.4	1.0
Oct. 09, 2015	2450	Body	250	926	3958	1386	12.30	51.70	49.2	-4.84
Oct. 09, 2015	2600	Body	250	1061	3958	1386	13.30	54.90	53.2	-3.10

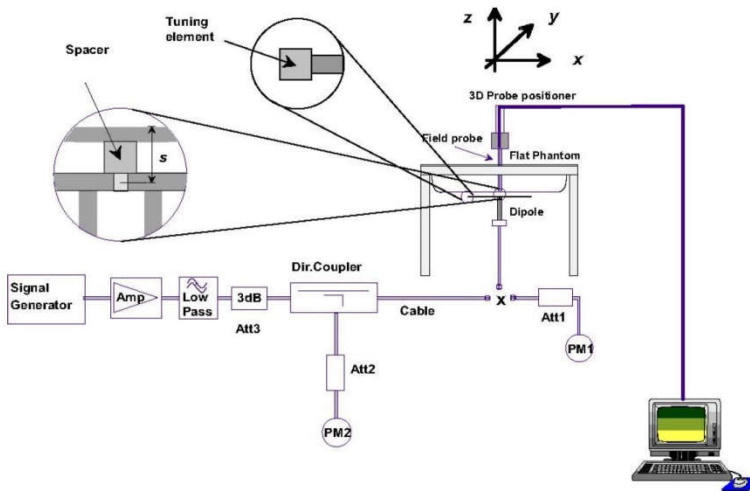

Fig 8.3.1 System Performance Check Setup



Fig 8.3.2 Setup Photo

11. RF Exposure Positions

11.1 Ear and handset reference point

Figure 9.1.1 shows the front, back, and side views of the SAM phantom. The center-of-mouth reference point is labeled "M," the left ear reference point (ERP) is marked "LE," and the right ERP is marked "RE." Each ERP is 15 mm along the B-M (back-mouth) line behind the entrance-to-ear-canal (EEC) point, as shown in Figure 9.1.2 The Reference Plane is defined as passing through the two ear reference points and point M. The line N-F (neck-front), also called the reference pivoting line, is normal to the Reference Plane and perpendicular to both a line passing through RE and LE and the B-M line (see Figure 9.1.3). Both N-F and B-M lines should be marked on the exterior of the phantom shell to facilitate handset positioning. Posterior to the N-F line the ear shape is a flat surface with 6 mm thickness at each ERP, and forward of the N-F line the ear is truncated, as illustrated in Figure 9.1.2. The ear truncation is introduced to preclude the ear lobe from interfering with handset tilt, which could lead to unstable positioning at the cheek.

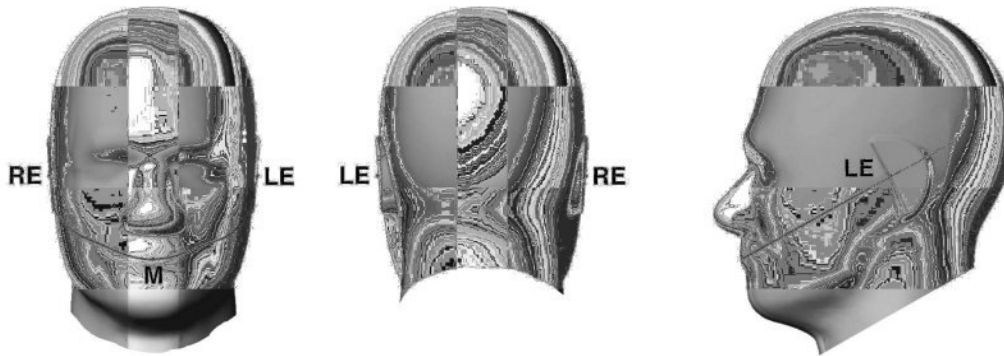

Fig 9.1.1 Front, back, and side views of SAM twin phantom

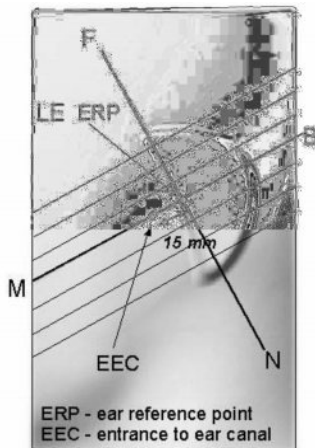

Fig 9.1.2 Close-up side view of phantom showing the ear region.

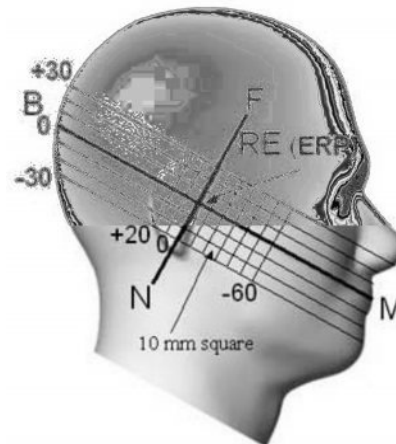

Fig 9.1.3 Side view of the phantom showing relevant markings and seven cross-sectional plane locations

11.2 Definition of the cheek position

1. Ready the handset for talk operation, if necessary. For example, for handsets with a cover piece (flip cover), open the cover. If the handset can transmit with the cover closed, both configurations must be tested.
2. Define two imaginary lines on the handset—the vertical centerline and the horizontal line. The vertical centerline passes through two points on the front side of the handset—the midpoint of the width w_t of the handset at the level of the acoustic output (point A in Figure 9.2.1 and Figure 9.2.2), and the midpoint of the width w_b of the bottom of the handset (point B). The horizontal line is perpendicular to the vertical centerline and passes through the center of the acoustic output (see Figure 9.2.1). The two lines intersect at point A. Note that for many handsets, point A coincides with the center of the acoustic output; however, the acoustic output may be located elsewhere on the horizontal line. Also note that the vertical centerline is not necessarily parallel to the front face of the handset (see Figure 9.2.2), especially for clamshell handsets, handsets with flip covers, and other irregularly-shaped handsets.
3. Position the handset close to the surface of the phantom such that point A is on the (virtual) extension of the line passing through points RE and LE on the phantom (see Figure 9.2.3), such that the plane defined by the vertical centerline and the horizontal line of the handset is approximately parallel to the sagittal plane of the phantom.
4. Translate the handset towards the phantom along the line passing through RE and LE until handset point A touches the pinna at the ERP.
5. While maintaining the handset in this plane, rotate it around the LE-RE line until the vertical centerline is in the plane normal to the plane containing B-M and N-F lines, i.e., the Reference Plane.
6. Rotate the handset around the vertical centerline until the handset (horizontal line) is parallel to the N-F line.
7. While maintaining the vertical centerline in the Reference Plane, keeping point A on the line passing through RE and LE, and maintaining the handset contact with the pinna, rotate the handset about the N-F line until any point on the handset is in contact with a phantom point below the pinna on the cheek. See Figure 9.2.3. The actual rotation angles should be documented in the test report.

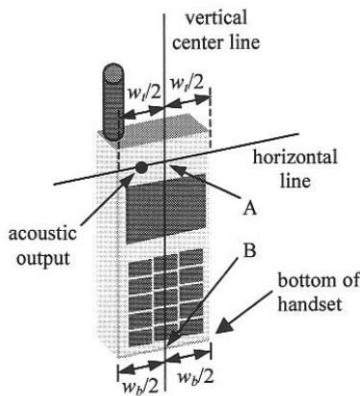

Fig 9.2.1 Handset vertical and horizontal reference lines—“fixed case”

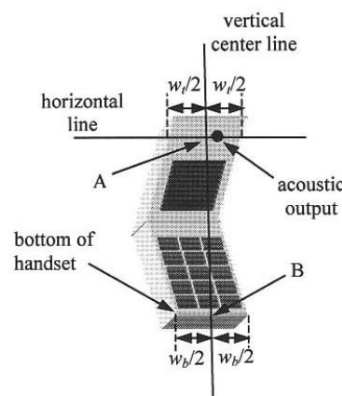

Fig 9.2.2 Handset vertical and horizontal reference lines—“clam-shell case”

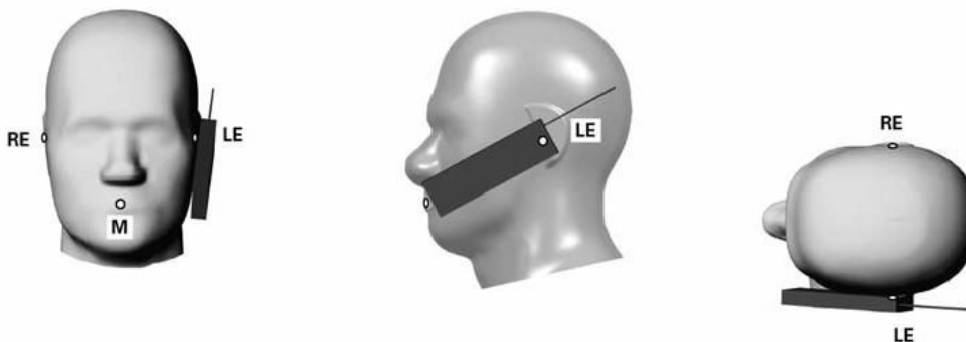

Fig 9.2.3 cheek or touch position. The reference points for the right ear (RE), left ear (LE), and mouth (M), which establish the Reference Plane for handset positioning, are indicated.

11.3 Definition of the tilt position

1. Ready the handset for talk operation, if necessary. For example, for handsets with a cover piece (flip cover), open the cover. If the handset can transmit with the cover closed, both configurations must be tested.
2. While maintaining the orientation of the handset, move the handset away from the pinna along the line passing through RE and LE far enough to allow a rotation of the handset away from the cheek by 15°.
3. Rotate the handset around the horizontal line by 15°.
4. While maintaining the orientation of the handset, move the handset towards the phantom on the line passing through RE and LE until any part of the handset touches the ear. The tilt position is obtained when the contact point is on the pinna. See Figure 9.3.1. If contact occurs at any location other than the pinna, e.g., the antenna at the back of the phantom head, the angle of the handset should be reduced. In this case, the tilt position is obtained if any point on the handset is in contact with the pinna and a second point

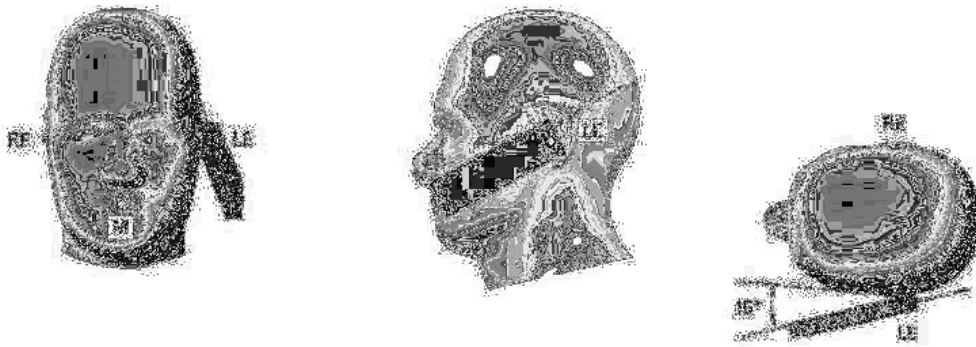

Fig 9.3.1 Tilt position. The reference points for the right ear (RE), left ear (LE), and mouth (M), which define the Reference Plane for handset positioning, are indicated.

11.4 Body Worn Accessory

Body-worn operating configurations are tested with the belt-clips and holsters attached to the device and positioned against a flat phantom in a normal use configuration (see Figure 9.4). Per KDB 648474 D04v01r03, body-worn accessory exposure is typically related to voice mode operations when handsets are carried in body-worn accessories. The body-worn accessory procedures in FCC KDB 447498 D01v06 should be used to test for body-worn accessory SAR compliance, without a headset connected to it. This enables the test results for such configuration to be compatible with that required for hotspot mode when the body-worn accessory test separation distance is greater than or equal to that required for hotspot mode, when applicable. When the reported SAR for body-worn accessory, measured without a headset connected to the handset is $< 1.2 \text{ W/kg}$, the highest reported SAR configuration for that wireless mode and frequency band should be repeated for that body-worn accessory with a headset attached to the handset.

Accessories for body-worn operation configurations are divided into two categories: those that do not contain metallic components and those that do contain metallic components. When multiple accessories that do not contain metallic components are supplied with the device, the device is tested with only the accessory that dictates the closest spacing to the body. Then multiple accessories that contain metallic components are test with the device with each accessory. If multiple accessories share an identical metallic component (i.e. the same metallic belt-clip used with different holsters with no other metallic components) only the accessory that dictates the closest spacing to the body is tested.

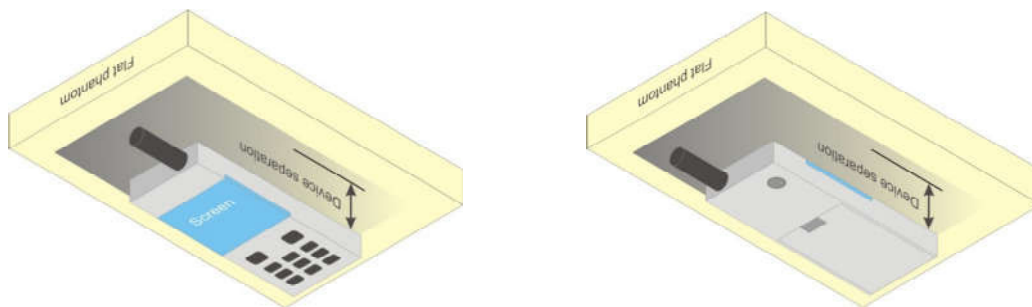

Fig 9.4 Body Worn Position

11.5 Wireless Router

Some battery-operated handsets have the capability to transmit and receive user through simultaneous transmission of WIFI simultaneously with a separate licensed transmitter. The FCC has provided guidance in FCC KDB Publication 941225 D06 v02r01 where SAR test considerations for handsets ($L \times W \geq 9 \text{ cm} \times 5 \text{ cm}$) are based on a composite test separation distance of 10mm from the front, back and edges of the device containing transmitting antennas within 2.5cm of their edges, determined from general mixed use conditions for this type of devices. Since the hotspot SAR results may overlap with the body-worn accessory SAR requirements, the more conservative configurations can be considered, thus excluding some body-worn accessory SAR tests.

When the user enables the personal wireless router functions for the handset, actual operations include simultaneous transmission of both the WIFI transmitter and another licensed transmitter. Both transmitters often do not transmit at the same transmitting frequency and thus cannot be evaluated for SAR under actual use conditions due to the limitations of the SAR assessment probes. Therefore, SAR must be evaluated for each frequency transmission and mode separately and spatially summed with the WIFI transmitter according to FCC KDB Publication 447498 D01v06 publication procedures. The "Portable Hotspot" feature on the handset was NOT activated during SAR assessments, to ensure the SAR measurements were evaluated for a single transmission frequency RF signal at a time.



12. Conducted RF Output Power (Unit: dBm)

<GSM Conducted Power>

General Note:

1. Per KDB 447498 D01v06, the maximum output power channel is used for SAR testing and for further SAR test reduction.
2. Per KDB 941225 D01v03r01, considering the possibility of e.g. 3rd party VoIP operation for Head and body-worn SAR test reduction for GSM and GPRS and EDGE modes is determined by the source-based time-averaged output power including tune-up tolerance. The mode with highest specified time-averaged output power should be tested for SAR compliance in the applicable exposure conditions. For modes with the same specified maximum output power and tolerance, the higher number time-slot configuration should be tested. Therefore, the EUT was set in GPRS (4Tx slots) for GSM850/GSM1900.
3. Per KDB 941225 D01v03r01, for Hotspot SAR test reduction for GPRS and EDGE modes is determined by the source-based time-averaged output power including tune-up tolerance, for modes with the same specified maximum output power and tolerance, the higher number time-slot configuration should be tested, therefore, the EUT was set in GPRS (4Tx slots) for GSM850/GSM1900.

Band GSM850	Burst Average Power (dBm)			Tune-up Limit (dBm)	Frame-Average Power (dBm)			Tune-up Limit (dBm)
	TX Channel	128	189		251	128	189	
Frequency (MHz)	824.2	836.4	848.8		824.2	836.4	848.8	
GSM (GMSK, 1 Tx slot)	32.02	32.04	32.08	32.50	23.02	23.04	23.08	23.50
GPRS (GMSK, 1 Tx slot)	31.98	32.03	32.06	32.50	22.98	23.03	23.06	23.50
GPRS (GMSK, 2 Tx slots)	31.94	31.95	31.98	32.50	25.94	25.95	25.98	26.50
GPRS (GMSK, 3 Tx slots)	31.83	31.85	31.89	32.50	27.57	27.59	27.63	28.24
GPRS (GMSK, 4 Tx slots)	31.69	31.70	31.77	32.50	28.69	28.70	28.77	29.50
EDGE (8PSK, 1 Tx slot)	25.83	25.85	25.86	26.00	16.83	16.85	16.86	17.00
EDGE (8PSK, 2 Tx slots)	25.72	25.74	25.75	26.00	19.72	19.74	19.75	20.00
EDGE (8PSK, 3 Tx slots)	25.65	25.69	25.70	26.00	21.39	21.43	21.44	21.74
EDGE (8PSK, 4 Tx slots)	25.55	25.56	25.58	26.00	22.55	22.56	22.58	23.00
Band GSM1900	Burst Average Power (dBm)			Tune-up Limit (dBm)	Frame-Average Power (dBm)			Tune-up Limit (dBm)
TX Channel	512	661	810		512	661	810	
Frequency (MHz)	1850.2	1880	1909.8		1850.2	1880	1909.8	
GSM (GMSK, 1 Tx slot)	29.02	29.04	29.06	29.50	20.02	20.04	20.06	20.50
GPRS (GMSK, 1 Tx slot)	29.00	29.03	29.05	29.50	20.00	20.03	20.05	20.50
GPRS (GMSK, 2 Tx slots)	28.93	28.94	28.96	29.50	22.93	22.94	22.96	23.50
GPRS (GMSK, 3 Tx slots)	28.82	28.84	28.88	29.50	24.56	24.58	24.62	25.24
GPRS (GMSK, 4 Tx slots)	28.70	28.75	28.77	29.50	25.70	25.75	25.77	26.50
EDGE (8PSK, 1 Tx slot)	25.21	25.03	25.01	25.50	16.21	16.03	16.01	16.50
EDGE (8PSK, 2 Tx slots)	25.14	24.95	24.90	25.50	19.14	18.95	18.90	19.50
EDGE (8PSK, 3 Tx slots)	25.07	24.91	24.83	25.50	20.81	20.65	20.57	21.24
EDGE (8PSK, 4 Tx slots)	24.96	24.80	24.77	25.50	21.96	21.80	21.77	22.50

Remark: The frame-averaged power is linearly scaled the maximum burst averaged power over 8 time slots.

The calculated method are shown as below:

Frame-averaged power = Maximum burst averaged power (1 Tx Slot) - 9 dB

Frame-averaged power = Maximum burst averaged power (2 Tx Slots) - 6 dB

Frame-averaged power = Maximum burst averaged power (3 Tx Slots) - 4.26 dB

Frame-averaged power = Maximum burst averaged power (4 Tx Slots) - 3 dB

<WCDMA Conducted Power>

1. The following tests were conducted according to the test requirements outlines in 3GPP TS 34.121 specification.
2. The procedures in KDB 941225 D01v03r01 are applied for 3GPP Rel. 6 HSPA to configure the device in the required sub-test mode(s) to determine SAR test exclusion.
3. For DC-HSDPA, the device was configured according to the H-Set 12, Fixed Reference Channel (FRC) configuration in Table C.8.1.12 of 3GPP TS 34.121-1, with the primary and the secondary serving HS-DSCH Cell enabled during the power measurement.

A summary of these settings are illustrated below:

HSDPA Setup Configuration:

- a. The EUT was connected to Base Station Agilent E5515C referred to the Setup Configuration.
- b. The RF path losses were compensated into the measurements.
- c. A call was established between EUT and Base Station with following setting:
 - i. Set Gain Factors (β_c and β_d) and parameters were set according to each
 - ii. Specific sub-test in the following table, C10.1.4, quoted from the TS 34.121
 - iii. Set RMC 12.2Kbps + HSDPA mode.
 - iv. Set Cell Power = -86 dBm
 - v. Set HS-DSCH Configuration Type to FRC (H-set 1, QPSK)
 - vi. Select HSDPA Uplink Parameters
 - vii. Set Delta ACK, Delta NACK and Delta CQI = 8
 - viii. Set Ack-Nack Repetition Factor to 3
 - ix. Set CQI Feedback Cycle (k) to 4 ms
 - x. Set CQI Repetition Factor to 2
 - xi. Power Ctrl Mode = All Up bits
- d. The transmitted maximum output power was recorded.

Table C.10.1.4: β values for transmitter characteristics tests with HS-DPCCH

Sub-test	β_c	β_d	β_d (SF)	β_c/β_d	β_{HS} (Note 1, Note 2)	CM (dB) (Note 3)	MPR (dB) (Note 3)
1	2/15	15/15	64	2/15	4/15	0.0	0.0
2	12/15 (Note 4)	15/15 (Note 4)	64	12/15 (Note 4)	24/15	1.0	0.0
3	15/15	8/15	64	15/8	30/15	1.5	0.5
4	15/15	4/15	64	15/4	30/15	1.5	0.5

Note 1: $\Delta_{ACK}, \Delta_{NACK}$ and $\Delta_{CQI} = 30/15$ with $\beta_{HS} = 30/15 * \beta_c$.

Note 2: For the HS-DPCCH power mask requirement test in clause 5.2C, 5.7A, and the Error Vector Magnitude (EVM) with HS-DPCCH test in clause 5.13.1A, and HSDPA EVM with phase discontinuity in clause 5.13.1AA, Δ_{ACK} and $\Delta_{NACK} = 30/15$ with $\beta_{HS} = 30/15 * \beta_c$, and $\Delta_{CQI} = 24/15$ with $\beta_{HS} = 24/15 * \beta_c$.

Note 3: CM = 1 for $\beta_c/\beta_d = 12/15, \beta_{HS}/\beta_c = 24/15$. For all other combinations of DPDCCH, DPCCH and HS-DPCCH the MPR is based on the relative CM difference. This is applicable for only UEs that support HSDPA in release 6 and later releases.

Note 4: For subtest 2 the β_c/β_d ratio of 12/15 for the TFC during the measurement period (TF1, TF0) is achieved by setting the signalled gain factors for the reference TFC (TF1, TF1) to $\beta_c = 11/15$ and $\beta_d = 15/15$.

Setup Configuration

HSUPA Setup Configuration:

- a. The EUT was connected to Base Station Agilent E5515C referred to the Setup Configuration.
- b. The RF path losses were compensated into the measurements.
- c. A call was established between EUT and Base Station with following setting * :
 - i. Call Configs = 5.2B, 5.9B, 5.10B, and 5.13.2B with QPSK
 - ii. Set the Gain Factors (β_c and β_d) and parameters (AG Index) were set according to each specific sub-test in the following table, C11.1.3, quoted from the TS 34.121
 - iii. Set Cell Power = -86 dBm
 - iv. Set Channel Type = 12.2k + HSPA
 - v. Set UE Target Power
 - vi. Power Ctrl Mode= Alternating bits
 - vii. Set and observe the E-TFCl
 - viii. Confirm that E-TFCl is equal to the target E-TFCl of 75 for sub-test 1, and other subtest's E-TFCl
- d. The transmitted maximum output power was recorded.

Table C.11.1.3: β values for transmitter characteristics tests with HS-DPCCH and E-DCH

Sub-test	β_c	β_d	β_d (SF)	β_c/β_d	β_{HS} (Note 1)	β_{ec}	β_{ed} (Note 5) (Note 6)	β_{ed} (SF)	β_{ed} (Codes)	CM (dB) (Note 2)	MPR (dB) (Note 2)	AG Index (Note 6)	E-TFCl
1	11/15 (Note 3)	15/15 (Note 3)	64	11/15 (Note 3)	22/15	209/25	1309/225	4	1	1.0	0.0	20	75
2	6/15	15/15	64	6/15	12/15	12/15	94/75	4	1	3.0	2.0	12	67
3	15/15	9/15	64	15/9	30/15	30/15	$\beta_{ed1}: 47/15$ $\beta_{ed2}: 47/15$	4 4	2	2.0	1.0	15	92
4	2/15	15/15	64	2/15	4/15	2/15	56/75	4	1	3.0	2.0	17	71
5	15/15 (Note 4)	15/15 (Note 4)	64	15/15 (Note 4)	30/15	24/15	134/15	4	1	1.0	0.0	21	81

Note 1: $\Delta_{ACK}, \Delta_{NACK}$ and $\Delta_{CQI} = 30/15$ with $\beta_{hs} = 30/15 * \beta_c$.

Note 2: CM = 1 for $\beta_c/\beta_d = 12/15, \beta_{hs}/\beta_c = 24/15$. For all other combinations of DPDCH, DPCCH, HS- DPCCH, E-DPDCH and E-DPCCH the MPR is based on the relative CM difference.

Note 3: For subtest 1 the β_c/β_d ratio of 11/15 for the TFC during the measurement period (TF1, TF0) is achieved by setting the signalled gain factors for the reference TFC (TF1, TF1) to $\beta_c = 10/15$ and $\beta_d = 15/15$.

Note 4: For subtest 5 the β_c/β_d ratio of 15/15 for the TFC during the measurement period (TF1, TF0) is achieved by setting the signalled gain factors for the reference TFC (TF1, TF1) to $\beta_c = 14/15$ and $\beta_d = 15/15$.

Note 5: In case of testing by UE using E-DPDCH Physical Layer category 1, Sub-test 3 is omitted according to TS25.306 Table 5.1g.

Note 6: β_{ed} can not be set directly, it is set by Absolute Grant Value.

Setup Configuration

DC-HSDPA 3GPP release 8 Setup Configuration:

- a. The EUT was connected to Base Station Agilent E5515C referred to the Setup Configuration below
- b. The RF path losses were compensated into the measurements.
- c. A call was established between EUT and Base Station with following setting:
 - i. Set RMC 12.2Kbps + HSDPA mode.
 - ii. Set Cell Power = -25 dBm
 - iii. Set HS-DSCH Configuration Type to FRC (H-set 12, QPSK)
 - iv. Select HSDPA Uplink Parameters
 - v. Set Gain Factors (β_c and β_d) and parameters were set according to each Specific sub-test in the following table, C10.1.4, quoted from the TS 34.121
 - a). Subtest 1: $\beta_c/\beta_d=2/15$
 - b). Subtest 2: $\beta_c/\beta_d=12/15$
 - c). Subtest 3: $\beta_c/\beta_d=15/8$
 - d). Subtest 4: $\beta_c/\beta_d=15/4$
 - vi. Set Delta ACK, Delta NACK and Delta CQI = 8
 - vii. Set Ack-Nack Repetition Factor to 3
 - viii. Set CQI Feedback Cycle (k) to 4 ms
 - ix. Set CQI Repetition Factor to 2
 - x. Power Ctrl Mode = All Up bits
- d. The transmitted maximum output power was recorded.

The following tests were conducted according to the test requirements outlines in 3GPP TS 34.121 specification. A summary of these settings are illustrated below:

C.8.1.12 Fixed Reference Channel Definition H-Set 12

Table C.8.1.12: Fixed Reference Channel H-Set 12

Parameter	Unit	Value
Nominal Avg. Inf. Bit Rate	kbps	60
Inter-TTI Distance	TTI's	1
Number of HARQ Processes	Processes	6
Information Bit Payload (N_{INF})	Bits	120
Number Code Blocks	Blocks	1
Binary Channel Bits Per TTI	Bits	960
Total Available SML's in UE	SML's	19200
Number of SML's per HARQ Proc.	SML's	3200
Coding Rate		0.15
Number of Physical Channel Codes	Codes	1
Modulation		QPSK
Note 1: The RMC is intended to be used for DC-HSDPA mode and both cells shall transmit with identical parameters as listed in the table. Note 2: Maximum number of transmission is limited to 1, i.e., retransmission is not allowed. The redundancy and constellation version 0 shall be used.		

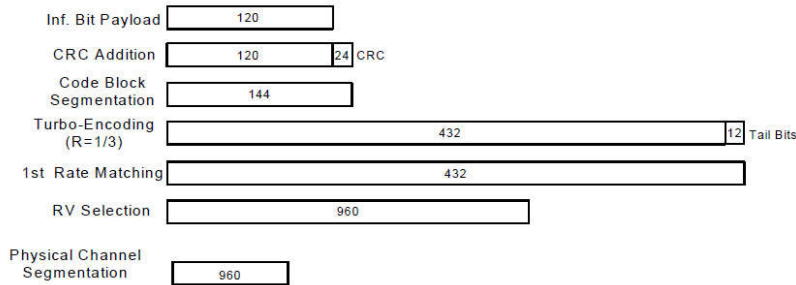

Figure C.8.19: Coding rate for Fixed reference Channel H-Set 12 (QPSK)

Setup Configuration



<WCDMA Conducted Power>

General Note:

- Per KDB 941225 D01v03r01, SAR for Head / Hotspot / Body-worn exposure is measured using a 12.2 kbps RMC with TPC bits configured to all "1's".
- Per KDB 941225 D01v03r01, RMC 12.2kbps setting is used to evaluate SAR. If the maximum output power and tune-up tolerance specified for production units in HSDPA / HSUPA / DC-HSDPA is $\leq \frac{1}{4}$ dB higher than RMC 12.2Kbps or when the highest reported SAR of the RMC12.2Kbps is scaled by the ratio of specified maximum output power and tune-up tolerance of HSDPA / HSUPA / DC-HSDPA to RMC12.2Kbps and the adjusted SAR is ≤ 1.2 W/kg, SAR measurement is not required for HSDPA / HSUPA / DC-HSDPA.

Band		WCDMA Band V			Tune-up Limit (dBm)	WCDMA Band II			Tune-up Limit (dBm)
TX Channel		4132	4182	4233		9262	9400	9538	
Rx Channel		4357	4407	4458		9662	9800	9938	
Frequency (MHz)		826.4	836.4	846.6		1852.4	1880	1907.6	
3GPP Rel 99	AMR 12.2Kbps	23.56	23.60	23.51	24.00	22.63	22.75	22.62	23.00
3GPP Rel 99	RMC 12.2Kbps	23.59	23.62	23.54	24.00	22.67	22.77	22.65	23.00
3GPP Rel 6	HSDPA Subtest-1	22.31	22.22	22.20	22.50	21.31	21.30	21.21	21.50
3GPP Rel 6	HSDPA Subtest-2	22.33	22.30	22.32	22.50	21.41	21.40	21.28	21.50
3GPP Rel 6	HSDPA Subtest-3	21.84	21.81	21.82	22.00	20.92	20.99	20.79	21.00
3GPP Rel 6	HSDPA Subtest-4	21.85	21.81	21.82	22.00	20.92	20.97	20.79	21.00
3GPP Rel 8	DC-HSDPA Subtest-1	21.60	21.66	21.63	22.00	20.70	20.69	20.69	21.00
3GPP Rel 8	DC-HSDPA Subtest-2	21.57	21.57	21.55	22.00	20.76	20.68	20.70	21.00
3GPP Rel 8	DC-HSDPA Subtest-3	21.04	21.13	21.10	22.00	20.19	20.26	20.22	21.00
3GPP Rel 8	DC-HSDPA Subtest-4	21.11	21.26	21.12	22.00	20.22	20.30	20.25	21.00
3GPP Rel 6	HSUPA Subtest-1	21.61	21.62	22.13	22.50	21.32	21.47	20.98	21.50
3GPP Rel 6	HSUPA Subtest-2	21.19	21.30	20.68	22.50	20.39	20.20	20.28	21.50
3GPP Rel 6	HSUPA Subtest-3	20.90	20.68	20.80	22.50	19.97	19.98	19.85	21.50
3GPP Rel 6	HSUPA Subtest-4	21.50	21.29	21.42	22.50	20.56	20.54	20.14	21.50
3GPP Rel 6	HSUPA Subtest-5	22.40	22.40	22.40	22.50	21.40	21.40	21.20	21.50

Band		WCDMA Band IV			Tune-up Limit (dBm)	
TX Channel		1312	1413	1513		
Rx Channel		1537	1638	1738		
Frequency (MHz)		1712.4	1732.6	1752.6		
3GPP Rel 99	AMR 12.2Kbps	22.98	23.05	23.21	23.50	
3GPP Rel 99	RMC 12.2Kbps	23.00	23.10	23.25	23.50	
3GPP Rel 6	HSDPA Subtest-1	21.65	21.83	21.86	22.00	
3GPP Rel 6	HSDPA Subtest-2	21.65	21.85	21.97	22.00	
3GPP Rel 6	HSDPA Subtest-3	21.16	21.35	21.48	21.50	
3GPP Rel 6	HSDPA Subtest-4	21.16	21.35	21.48	21.50	
3GPP Rel 8	DC-HSDPA Subtest-1	21.58	21.50	21.56	22.00	
3GPP Rel 8	DC-HSDPA Subtest-2	21.56	21.42	21.54	22.00	
3GPP Rel 8	DC-HSDPA Subtest-3	21.09	20.96	21.02	22.00	
3GPP Rel 8	DC-HSDPA Subtest-4	21.10	20.93	20.98	22.00	
3GPP Rel 6	HSUPA Subtest-1	21.45	21.79	21.58	22.00	
3GPP Rel 6	HSUPA Subtest-2	19.99	20.54	20.87	21.00	
3GPP Rel 6	HSUPA Subtest-3	20.11	20.46	20.57	22.00	
3GPP Rel 6	HSUPA Subtest-4	20.63	21.04	20.75	22.00	
3GPP Rel 6	HSUPA Subtest-5	21.70	21.80	21.90	22.00	



<LTE Conducted Power>

General Note:

1. Anritsu MT8820C base station simulator was used to setup the connection with EUT; the frequency band, channel bandwidth, RB allocation configuration, modulation type are set in the base station simulator to configure EUT transmitting at maximum power and at different configurations which are requested to be reported to FCC, for conducted power measurement and SAR testing.
2. Per KDB 941225 D05v02r04, when a properly configured base station simulator is used for the SAR and power measurements, spectrum plots for each RB allocation and offset configuration is not required.
3. Per KDB 941225 D05v02r04, start with the largest channel bandwidth and measure SAR for QPSK with 1 RB allocation, using the RB offset and required test channel combination with the highest maximum output power for RB offsets at the upper edge, middle and lower edge of each required test channel.
4. Per KDB 941225 D05v02r04, 50% RB allocation for QPSK SAR testing follows 1RB QPSK allocation procedure.
5. Per KDB 941225 D05v02r04, For QPSK with 100% RB allocation, SAR is not required when the highest maximum output power for 100 % RB allocation is less than the highest maximum output power in 50% and 1 RB allocations and the highest reported SAR for 1 RB and 50% RB allocation are ≤ 0.8 W/kg. Otherwise, SAR is measured for the highest output power channel; and if the reported SAR is > 1.45 W/kg, the remaining required test channels must also be tested.
6. Per KDB 941225 D05v02r04, 16QAM output power for each RB allocation configuration is $>$ not $\frac{1}{2}$ dB higher than the same configuration in QPSK and the reported SAR for the QPSK configuration is ≤ 1.45 W/kg; Per KDB 941225 D05v02r04, 16QAM SAR testing is not required.
7. Per KDB 941225 D05v02r04, Smaller bandwidth output power for each RB allocation configuration is $>$ not $\frac{1}{2}$ dB higher than the same configuration in the largest supported bandwidth, and the reported SAR for the largest supported bandwidth is ≤ 1.45 W/kg; Per KDB 941225 D05v02r04, smaller bandwidth SAR testing is not required.
8. For LTE B12 / B5 / B4 the maximum bandwidth does not support three non-overlapping channels, per KDB 941225 D05v02r03, when a device supports overlapping channel assignment in a channel bandwidth configuration, the middle channel of the group of overlapping channels should be selected for testing.
9. LTE band 17 SAR test was covered by Band 12; according to April 2015 TCB workshop, SAR test for overlapping LTE bands can be reduced if
 - a. the maximum output power, including tolerance, for the smaller band is \leq the larger band to qualify for the SAR test exclusion
 - b. the channel bandwidth and other operating parameters for the smaller band are fully supported by the larger band



<LTE Band 12>

BW [MHz]	Modulation	RB Size	RB Offset	Power Low Ch. / Freq.	Power Middle Ch. / Freq.	Power High Ch. / Freq.	Tune-up limit (dBm)	MPR (dB)
Channel				23060	23095	23130		
Frequency (MHz)				704	707.5	711		
10	QPSK	1	0	22.65	22.59	23.17	23.50	0
10	QPSK	1	25	22.90	22.66	22.91		
10	QPSK	1	49	22.93	22.68	23.20		
10	QPSK	25	0	21.81	21.83	21.94	22.50	0-1
10	QPSK	25	12	21.74	21.81	21.77		
10	QPSK	25	25	21.80	21.69	21.70		
10	QPSK	50	0	21.78	21.76	21.79	22.50	0-1
10	16QAM	1	0	22.06	22.09	21.99		
10	16QAM	1	25	22.15	21.84	21.83		
10	16QAM	1	49	22.18	21.86	21.54	21.50	0-2
10	16QAM	25	0	20.61	20.68	20.94		
10	16QAM	25	12	20.68	20.70	20.72		
10	16QAM	25	25	20.75	20.69	20.64	21.50	0-2
10	16QAM	50	0	20.72	20.66	20.75		
Channel				23035	23095	23155		
Frequency (MHz)				701.5	707.5	713.5		
5	QPSK	1	0	22.29	22.62	22.88	23.50	0
5	QPSK	1	12	22.95	22.60	22.74		
5	QPSK	1	24	22.72	22.58	22.97		
5	QPSK	12	0	21.58	21.72	21.72	22.50	0-1
5	QPSK	12	7	21.73	21.56	21.56		
5	QPSK	12	13	21.94	21.74	21.74		
5	QPSK	25	0	21.80	21.80	21.80	22.50	0-1
5	16QAM	1	0	21.58	22.37	22.37		
5	16QAM	1	12	21.70	21.86	21.86		
5	16QAM	1	24	21.65	21.92	21.92	21.50	0-2
5	16QAM	12	0	20.67	20.58	20.58		
5	16QAM	12	7	20.64	20.51	20.51		
5	16QAM	12	13	20.75	20.53	20.53	21.50	0-2
5	16QAM	25	0	20.68	20.58	20.58		



Channel				23025	23095	23165	Tune-up limit (dBm)	MPR (dB)
Frequency (MHz)				700.5	707.5	714.5		
3	QPSK	1	0	22.66	22.62	22.74	23.50	0
3	QPSK	1	8	22.82	22.60	22.95		
3	QPSK	1	14	22.61	22.58	22.81		
3	QPSK	8	0	21.74	21.95	21.74	22.50	0-1
3	QPSK	8	4	21.77	21.97	21.78		
3	QPSK	8	7	21.86	21.86	21.88		
3	QPSK	15	0	21.71	21.89	21.84		
3	16QAM	1	0	21.80	22.46	22.12	22.50	0-1
3	16QAM	1	8	22.16	22.10	22.17		
3	16QAM	1	14	22.43	22.23	22.44		
3	16QAM	8	0	20.62	20.96	20.87	21.50	0-2
3	16QAM	8	4	20.66	20.94	20.76		
3	16QAM	8	7	20.67	20.95	20.92		
3	16QAM	15	0	20.63	20.93	20.84		
Channel				23017	23095	23173	Tune-up limit (dBm)	MPR (dB)
Frequency (MHz)				699.7	707.5	715.3		
1.4	QPSK	1	0	22.57	22.60	22.82	23.50	0
1.4	QPSK	1	3	22.61	22.58	22.92		
1.4	QPSK	1	5	22.68	22.57	22.86		
1.4	QPSK	3	0	22.71	22.57	22.84		
1.4	QPSK	3	1	22.86	22.60	23.01		
1.4	QPSK	3	3	22.76	22.52	22.95	22.50	0-1
1.4	QPSK	6	0	21.57	21.90	21.88	22.50	0-1
1.4	16QAM	1	0	21.93	22.18	22.25		
1.4	16QAM	1	3	21.69	22.15	22.17		
1.4	16QAM	1	5	21.91	22.07	22.35		
1.4	16QAM	3	0	21.72	22.26	21.84		
1.4	16QAM	3	1	21.73	21.99	22.05		
1.4	16QAM	3	3	21.97	22.00	21.98	21.50	0-2
1.4	16QAM	6	0	20.54	20.70	20.85		



<LTE Band 17>

BW [MHz]	Modulation	RB Size	RB Offset	Power Low Ch. / Freq.	Power Middle Ch. / Freq.	Power High Ch. / Freq.	Tune-up limit (dBm)	MPR (dB)
Channel				23780	23790	23800		
Frequency (MHz)				709	710	711		
10	QPSK	1	0	22.86	22.71	22.84	23.50	0
10	QPSK	1	25	22.79	22.64	22.70		
10	QPSK	1	49	22.69	22.66	22.80		
10	QPSK	25	0	21.80	21.78	21.79	22.50	0-1
10	QPSK	25	12	21.76	21.71	21.64		
10	QPSK	25	25	21.76	21.73	21.69		
10	QPSK	50	0	21.74	21.70	21.71		
10	16QAM	1	0	21.85	22.04	22.06	22.50	0-1
10	16QAM	1	25	21.84	21.32	21.86		
10	16QAM	1	49	21.67	21.93	22.03		
10	16QAM	25	0	20.65	20.77	20.59	21.50	0-2
10	16QAM	25	12	20.62	20.57	20.54		
10	16QAM	25	25	20.58	20.54	20.57		
10	16QAM	50	0	20.70	20.50	20.65		
Channel				23755	23790	23825	Tune-up limit (dBm)	MPR (dB)
Frequency (MHz)				706.5	710	713.5		
5	QPSK	1	0	22.62	22.73	22.69	23.50	0
5	QPSK	1	12	22.78	22.70	22.49		
5	QPSK	1	24	22.37	22.38	22.53		
5	QPSK	12	0	21.73	21.65	21.66	22.50	0-1
5	QPSK	12	7	21.76	21.79	21.67		
5	QPSK	12	13	21.76	21.65	21.67		
5	QPSK	25	0	21.72	21.75	21.72		
5	16QAM	1	0	22.30	21.91	21.86	22.50	0-1
5	16QAM	1	12	22.29	22.23	21.81		
5	16QAM	1	24	22.12	22.20	21.87		
5	16QAM	12	0	20.55	20.62	20.67	21.50	0-2
5	16QAM	12	7	20.68	20.56	20.58		
5	16QAM	12	13	20.98	20.64	20.49		
5	16QAM	25	0	20.62	20.64	20.48		



<LTE Band 5>

BW [MHz]	Modulation	RB Size	RB Offset	Power Low Ch. / Freq.	Power Middle Ch. / Freq.	Power High Ch. / Freq.	Tune-up limit (dBm)	MPR (dB)
Channel				20450	20525	20600		
Frequency (MHz)				829	836.5	844		
10	QPSK	1	0	22.57	22.81	22.64	23.50	0
10	QPSK	1	25	22.50	22.69	22.56		
10	QPSK	1	49	22.56	22.50	22.52		
10	QPSK	25	0	21.57	21.73	21.73	22.50	0-1
10	QPSK	25	12	21.58	21.73	21.71		
10	QPSK	25	25	21.64	21.77	21.75		
10	QPSK	50	0	21.59	21.72	21.64	22.50	0-1
10	16QAM	1	0	21.96	22.10	22.09		
10	16QAM	1	25	21.48	22.01	21.99		
10	16QAM	1	49	22.03	21.92	22.00	21.50	0-2
10	16QAM	25	0	20.69	20.51	20.74		
10	16QAM	25	12	20.70	20.86	20.65		
10	16QAM	25	25	20.53	20.61	20.72	21.50	0-2
10	16QAM	50	0	20.41	20.53	20.63		
Channel				20425	20525	20625		
Frequency (MHz)				826.5	836.5	846.5		
5	QPSK	1	0	22.26	22.79	22.62	23.50	0
5	QPSK	1	12	22.54	22.79	22.61		
5	QPSK	1	24	22.53	22.68	22.60		
5	QPSK	12	0	21.44	21.60	21.67	22.50	0-1
5	QPSK	12	7	21.62	21.75	21.70		
5	QPSK	12	13	21.63	21.70	21.66		
5	QPSK	25	0	21.51	21.60	21.61	22.50	0-1
5	16QAM	1	0	21.80	21.80	22.26		
5	16QAM	1	12	22.24	21.77	21.87		
5	16QAM	1	24	21.65	21.73	21.73	21.50	0-2
5	16QAM	12	0	20.50	20.68	20.74		
5	16QAM	12	7	20.63	20.62	20.62		
5	16QAM	12	13	20.69	20.69	20.58	21.50	0-2
5	16QAM	25	0	20.84	20.56	20.58		



Channel				20415	20525	20635	Tune-up limit (dBm)	MPR (dB)
Frequency (MHz)				825.5	836.5	847.5		
3	QPSK	1	0	22.42	22.61	22.55	23.50	0
3	QPSK	1	8	22.40	22.64	22.58		
3	QPSK	1	14	22.39	22.50	22.28		
3	QPSK	8	0	21.64	21.65	21.67	22.50	0-1
3	QPSK	8	4	21.52	21.68	21.75		
3	QPSK	8	7	21.57	21.70	21.63		
3	QPSK	15	0	21.46	21.70	21.67		
3	16QAM	1	0	21.38	21.67	21.77	22.50	0-1
3	16QAM	1	8	21.14	21.73	21.80		
3	16QAM	1	14	21.00	21.67	21.13		
3	16QAM	8	0	20.48	20.84	20.62	21.50	0-2
3	16QAM	8	4	20.52	20.73	20.70		
3	16QAM	8	7	20.53	20.72	20.74		
3	16QAM	15	0	20.35	20.44	20.33		
Channel				20407	20525	20643	Tune-up limit (dBm)	MPR (dB)
Frequency (MHz)				824.7	836.5	848.3		
1.4	QPSK	1	0	22.12	22.44	22.37	23.50	0
1.4	QPSK	1	3	22.13	22.53	22.36		
1.4	QPSK	1	5	22.05	22.41	22.39		
1.4	QPSK	3	0	22.20	22.50	22.56		
1.4	QPSK	3	1	22.18	22.56	22.59		
1.4	QPSK	3	3	22.15	22.57	22.67	22.50	0-1
1.4	QPSK	6	0	21.60	21.71	21.65	22.50	0-1
1.4	16QAM	1	0	21.31	21.95	22.00		
1.4	16QAM	1	3	22.12	22.03	22.14		
1.4	16QAM	1	5	21.23	22.03	22.02		
1.4	16QAM	3	0	21.25	21.77	21.79		
1.4	16QAM	3	1	22.04	21.83	21.84		
1.4	16QAM	3	3	21.88	21.83	21.87		
1.4	16QAM	6	0	20.08	20.49	20.44	21.50	0-2



<LTE Band 4>

BW [MHz]	Modulation	RB Size	RB Offset	Power Low Ch. / Freq.	Power Middle Ch. / Freq.	Power High Ch. / Freq.	Tune-up limit (dBm)	MPR (dB)
Channel				20050	20175	20300		
Frequency (MHz)				1720	1732.5	1745		
20	QPSK	1	0	22.60	22.88	22.87	24.00	0
20	QPSK	1	49	22.77	23.01	22.88		
20	QPSK	1	99	22.76	22.93	22.38		
20	QPSK	50	0	21.79	21.98	22.03	23.00	0-1
20	QPSK	50	24	21.71	21.93	21.92		
20	QPSK	50	50	21.78	21.87	21.87		
20	QPSK	100	0	21.65	21.96	21.92	23.00	0-1
20	16QAM	1	0	21.86	22.30	22.17		
20	16QAM	1	49	21.86	22.56	22.16		
20	16QAM	1	99	21.94	22.00	21.75	22.00	0-2
20	16QAM	50	0	20.71	20.90	21.06		
20	16QAM	50	24	20.51	20.85	20.96		
20	16QAM	50	50	20.56	20.81	20.68	22.00	0-2
20	16QAM	100	0	20.64	20.99	20.87		
Channel				20025	20175	20325		
Frequency (MHz)				1717.5	1732.5	1747.5		
15	QPSK	1	0	22.70	23.00	22.85	24.00	0
15	QPSK	1	37	22.65	22.95	22.79		
15	QPSK	1	74	22.66	22.84	22.77		
15	QPSK	36	0	21.73	21.83	22.00	23.00	0-1
15	QPSK	36	20	21.74	21.96	21.85		
15	QPSK	36	39	21.68	21.99	21.87		
15	QPSK	75	0	21.71	21.96	21.88	23.00	0-1
15	16QAM	1	0	22.40	22.58	22.57		
15	16QAM	1	37	22.11	22.30	22.41		
15	16QAM	1	74	22.19	22.18	22.30	22.00	0-2
15	16QAM	36	0	20.83	20.74	20.90		
15	16QAM	36	20	20.61	20.87	20.85		
15	16QAM	36	39	20.58	20.88	20.87	22.00	0-2
15	16QAM	75	0	20.61	20.86	20.87		



Channel				20000	20175	20350	Tune-up limit (dBm)	MPR (dB)
Frequency (MHz)				1715	1732.5	1750		
10	QPSK	1	0	22.74	22.97	22.91	24.00	0
10	QPSK	1	25	22.75	22.95	22.82		
10	QPSK	1	49	22.61	22.96	22.84		
10	QPSK	25	0	21.77	21.89	22.03	23.00	0-1
10	QPSK	25	12	21.74	21.91	21.92		
10	QPSK	25	25	21.68	21.91	21.81		
10	QPSK	50	0	21.74	21.89	21.97	23.00	0-1
10	16QAM	1	0	21.76	22.01	21.97		
10	16QAM	1	25	22.56	21.91	21.82		
10	16QAM	1	49	21.81	21.80	21.76	22.00	0-2
10	16QAM	25	0	20.87	20.86	21.02		
10	16QAM	25	12	20.65	20.88	21.02		
10	16QAM	25	25	20.78	20.90	20.82	22.00	0-2
10	16QAM	50	0	20.63	20.93	20.93		
Channel				19975	20175	20375	Tune-up limit (dBm)	MPR (dB)
Frequency (MHz)				1712.5	1732.5	1752.5		
5	QPSK	1	0	22.68	23.07	22.81	24.00	0
5	QPSK	1	12	22.64	23.01	22.86		
5	QPSK	1	24	22.54	22.96	22.70		
5	QPSK	12	0	21.69	21.80	21.83	23.00	0-1
5	QPSK	12	7	21.62	21.90	21.87		
5	QPSK	12	13	21.67	21.86	21.80		
5	QPSK	25	0	21.71	21.85	21.82	23.00	0-1
5	16QAM	1	0	21.89	21.95	22.10		
5	16QAM	1	12	21.72	21.92	22.01		
5	16QAM	1	24	21.62	21.88	21.91	22.00	0-2
5	16QAM	12	0	20.59	20.60	20.82		
5	16QAM	12	7	20.63	20.62	20.80		
5	16QAM	12	13	20.59	20.58	20.72	22.00	0-2
5	16QAM	25	0	20.62	20.67	20.93		



Channel				19965	20175	20385	Tune-up limit (dBm)	MPR (dB)
Frequency (MHz)				1711.5	1732.5	1753.5		
3	QPSK	1	0	22.55	22.84	22.78	24.00	0
3	QPSK	1	8	22.59	22.84	22.80		
3	QPSK	1	14	22.68	22.77	22.84		
3	QPSK	8	0	21.85	21.90	21.79	23.00	0-1
3	QPSK	8	4	21.66	21.97	21.91		
3	QPSK	8	7	21.77	21.94	21.93		
3	QPSK	15	0	21.65	21.88	21.93	23.00	0-1
3	16QAM	1	0	21.85	22.44	22.34		
3	16QAM	1	8	21.87	22.36	22.85		
3	16QAM	1	14	21.91	22.35	22.80	22.00	0-2
3	16QAM	8	0	20.61	20.78	20.97		
3	16QAM	8	4	20.73	20.86	20.89		
3	16QAM	8	7	20.42	20.91	20.73	22.00	0-2
3	16QAM	15	0	20.46	20.95	20.90		
Channel				19957	20175	20393	Tune-up limit (dBm)	MPR (dB)
Frequency (MHz)				1710.7	1732.5	1754.3		
1.4	QPSK	1	0	22.60	22.98	22.77	24.00	0
1.4	QPSK	1	3	22.60	22.96	22.87		
1.4	QPSK	1	5	22.58	22.86	22.88		
1.4	QPSK	3	0	22.64	22.91	22.61		
1.4	QPSK	3	1	22.85	23.03	22.61		
1.4	QPSK	3	3	22.86	22.92	22.54	23.00	0-1
1.4	QPSK	6	0	21.74	21.82	21.90	23.00	0-1
1.4	16QAM	1	0	22.09	22.38	21.86		
1.4	16QAM	1	3	22.12	22.39	22.95		
1.4	16QAM	1	5	22.11	22.08	22.08		
1.4	16QAM	3	0	21.52	21.89	21.61		
1.4	16QAM	3	1	21.54	21.91	22.51		
1.4	16QAM	3	3	22.40	21.90	22.39	22.00	0-2
1.4	16QAM	6	0	20.40	20.58	20.63		



<LTE Band 2>

BW [MHz]	Modulation	RB Size	RB Offset	Power Low Ch. / Freq.	Power Middle Ch. / Freq.	Power High Ch. / Freq.	Tune-up limit (dBm)	MPR (dB)
Channel				18700	18900	19100		
Frequency (MHz)				1860	1880	1900		
20	QPSK	1	0	22.88	22.84	22.87	23.50	0
20	QPSK	1	49	23.06	23.03	22.98		
20	QPSK	1	99	22.66	22.77	22.45		
20	QPSK	50	0	22.02	21.91	21.85	22.50	0-1
20	QPSK	50	24	21.94	21.87	21.76		
20	QPSK	50	50	21.92	21.90	21.64		
20	QPSK	100	0	21.90	21.88	21.76	22.50	0-1
20	16QAM	1	0	22.33	22.24	22.22		
20	16QAM	1	49	22.20	22.38	21.90		
20	16QAM	1	99	21.90	22.21	22.06	21.50	0-2
20	16QAM	50	0	21.00	20.80	20.93		
20	16QAM	50	24	21.01	20.95	20.72		
20	16QAM	50	50	20.74	20.87	20.60	21.50	0-2
20	16QAM	100	0	20.88	20.94	20.70		
Channel				18675	18900	19125		
Frequency (MHz)				1857.5	1880	1902.5		
15	QPSK	1	0	22.50	22.97	22.76	23.50	0
15	QPSK	1	37	22.81	22.68	22.64		
15	QPSK	1	74	22.67	22.68	22.53		
15	QPSK	36	0	21.86	21.92	21.70	22.50	0-1
15	QPSK	36	20	21.97	21.83	21.73		
15	QPSK	36	39	21.92	21.90	21.73		
15	QPSK	75	0	21.90	21.93	21.73	22.50	0-1
15	16QAM	1	0	22.25	21.90	21.74		
15	16QAM	1	37	22.08	21.75	21.64		
15	16QAM	1	74	21.84	22.04	21.63	21.50	0-2
15	16QAM	36	0	20.76	20.93	20.74		
15	16QAM	36	20	20.89	20.84	20.77		
15	16QAM	36	39	21.01	20.93	20.76	21.50	0-2
15	16QAM	75	0	20.78	20.83	20.76		



Channel				18650	18900	19150	Tune-up limit (dBm)	MPR (dB)
Frequency (MHz)				1855	1880	1905		
10	QPSK	1	0	23.03	22.81	22.74	23.50	0
10	QPSK	1	25	23.04	22.66	23.02		
10	QPSK	1	49	23.03	22.96	22.86		
10	QPSK	25	0	21.90	21.89	21.76	22.50	0-1
10	QPSK	25	12	21.94	21.84	21.79		
10	QPSK	25	25	21.99	21.88	21.67		
10	QPSK	50	0	21.90	21.88	21.67	22.50	0-1
10	16QAM	1	0	22.11	22.11	21.92		
10	16QAM	1	25	21.86	21.83	21.79		
10	16QAM	1	49	22.04	21.97	21.83	21.50	0-2
10	16QAM	25	0	20.84	20.91	20.79		
10	16QAM	25	12	20.85	20.79	20.82		
10	16QAM	25	25	20.93	20.92	20.70	21.50	0-2
10	16QAM	50	0	20.78	20.76	20.65		
Channel				18625	18900	19175	Tune-up limit (dBm)	MPR (dB)
Frequency (MHz)				1852.5	1880	1907.5		
5	QPSK	1	0	22.64	22.85	22.53	23.50	0
5	QPSK	1	12	23.00	22.70	22.83		
5	QPSK	1	24	22.91	22.83	22.45		
5	QPSK	12	0	21.81	21.84	21.61	22.50	0-1
5	QPSK	12	7	21.86	21.77	21.68		
5	QPSK	12	13	21.92	21.81	21.68		
5	QPSK	25	0	21.81	21.80	21.64	22.50	0-1
5	16QAM	1	0	21.87	22.10	21.88		
5	16QAM	1	12	22.09	21.91	21.78		
5	16QAM	1	24	22.33	22.02	21.87	21.50	0-2
5	16QAM	12	0	20.83	20.66	20.64		
5	16QAM	12	7	20.86	20.62	20.60		
5	16QAM	12	13	20.84	20.74	20.73	21.50	0-2
5	16QAM	25	0	20.68	20.78	20.73		



Channel				18615	18900	19185	Tune-up limit (dBm)	MPR (dB)
Frequency (MHz)				1851.5	1880	1908.5		
3	QPSK	1	0	22.90	22.66	22.48	23.50	0
3	QPSK	1	8	22.96	22.87	22.59		
3	QPSK	1	14	23.05	22.87	22.48		
3	QPSK	8	0	21.88	21.85	21.65	22.50	0-1
3	QPSK	8	4	21.91	21.76	21.71		
3	QPSK	8	7	21.88	21.87	21.76		
3	QPSK	15	0	21.84	21.85	21.7		
3	16QAM	1	0	22.42	22.41	22.21	22.50	0-1
3	16QAM	1	8	22.33	22.30	22.16		
3	16QAM	1	14	22.13	22.38	22.07		
3	16QAM	8	0	20.76	20.73	20.63	21.50	0-2
3	16QAM	8	4	20.91	20.84	20.69		
3	16QAM	8	7	20.78	20.74	20.75		
3	16QAM	15	0	20.51	20.72	20.77		
Channel				18607	18900	19193	Tune-up limit (dBm)	MPR (dB)
Frequency (MHz)				1850.7	1880	1909.3		
1.4	QPSK	1	0	22.94	22.79	22.54	23.50	0
1.4	QPSK	1	3	22.95	22.69	22.51		
1.4	QPSK	1	5	22.96	22.66	22.52		
1.4	QPSK	3	0	22.87	22.71	22.49		
1.4	QPSK	3	1	23.02	22.76	22.53		
1.4	QPSK	3	3	22.93	22.77	22.52	22.50	0-1
1.4	QPSK	6	0	21.83	21.79	21.58	22.50	0-1
1.4	16QAM	1	0	22.33	22.30	22.20		
1.4	16QAM	1	3	22.36	22.33	22.13		
1.4	16QAM	1	5	22.47	22.29	22.19		
1.4	16QAM	3	0	21.86	21.92	22.03		
1.4	16QAM	3	1	21.90	21.95	22.07		
1.4	16QAM	3	3	21.90	21.94	21.81	21.50	0-2
1.4	16QAM	6	0	20.72	20.45	20.58		



<LTE Band 7>

BW [MHz]	Modulation	RB Size	RB Offset	Measured Power			Tune-up limit (dBm)	MPR (dB)
				20850	21100	21350		
Channel				2510	2535	2560		
Frequency (MHz)				2510	2535	2560		
20	QPSK	1	0	22.28	22.54	22.72	23.50	0
20	QPSK	1	49	22.29	22.81	22.78		
20	QPSK	1	99	22.13	22.78	22.76		
20	QPSK	50	0	21.33	21.64	21.58	22.50	0-1
20	QPSK	50	24	21.14	21.59	21.60		
20	QPSK	50	50	21.27	21.62	21.61		
20	QPSK	100	0	21.15	21.67	21.65	22.50	0-1
20	16QAM	1	0	21.45	21.98	21.94		
20	16QAM	1	49	21.20	22.04	21.64		
20	16QAM	1	99	21.24	22.12	21.85	21.50	0-2
20	16QAM	50	0	20.19	20.62	20.66		
20	16QAM	50	24	20.02	20.66	20.38		
20	16QAM	50	50	20.09	20.78	20.41	21.50	0-2
20	16QAM	100	0	20.15	20.58	20.41		
Channel				20825	21100	21375		
Channel				2507.5	2535	2562.5	Tune-up limit (dBm)	MPR (dB)
Frequency (MHz)				2507.5	2535	2562.5		
15	QPSK	1	0	22.20	22.48	22.83	23.50	0
15	QPSK	1	37	22.08	22.53	22.63		
15	QPSK	1	74	22.12	22.70	22.56		
15	QPSK	36	0	21.32	21.56	21.79	22.50	0-1
15	QPSK	36	20	21.18	21.57	21.65		
15	QPSK	36	39	21.18	21.61	21.61		
15	QPSK	75	0	21.18	21.56	21.64	22.50	0-1
15	16QAM	1	0	21.55	21.71	22.28		
15	16QAM	1	37	21.27	21.64	22.12		
15	16QAM	1	74	21.68	22.11	22.26	21.50	0-2
15	16QAM	36	0	20.32	20.65	20.57		
15	16QAM	36	20	20.18	20.71	20.65		
15	16QAM	36	39	20.20	20.78	20.43	21.50	0-2
15	16QAM	75	0	20.22	20.56	20.48		



Channel				20800	21100	21400	Tune-up limit (dBm)	MPR (dB)
Frequency (MHz)				2505	2535	2565		
10	QPSK	1	0	22.25	22.68	22.66	23.50	0
10	QPSK	1	25	22.26	22.68	22.34		
10	QPSK	1	49	22.13	22.67	22.73		
10	QPSK	25	0	21.24	21.63	21.73	22.50	0-1
10	QPSK	25	12	21.10	21.54	21.64		
10	QPSK	25	25	21.18	21.69	21.69		
10	QPSK	50	0	21.23	21.65	21.66	22.50	0-1
10	16QAM	1	0	21.77	21.79	21.98		
10	16QAM	1	25	21.14	21.69	21.82		
10	16QAM	1	49	21.22	21.85	22.03	21.50	0-2
10	16QAM	25	0	20.12	20.59	20.71		
10	16QAM	25	12	20.27	20.69	20.71		
10	16QAM	25	25	20.28	20.64	20.75	21.50	0-2
10	16QAM	50	0	20.20	20.57	20.64		
Channel				20775	21100	21425	Tune-up limit (dBm)	MPR (dB)
Frequency (MHz)				2502.5	2535	2567.5		
5	QPSK	1	0	22.09	22.60	22.64	23.50	0
5	QPSK	1	12	22.09	22.57	22.64		
5	QPSK	1	24	22.50	22.64	22.73		
5	QPSK	12	0	21.23	21.60	21.67	22.50	0-1
5	QPSK	12	7	21.11	21.53	21.65		
5	QPSK	12	13	21.07	21.56	21.60		
5	QPSK	25	0	21.14	21.61	21.64	22.50	0-1
5	16QAM	1	0	21.34	21.73	21.89		
5	16QAM	1	12	21.17	21.81	21.93		
5	16QAM	1	24	21.28	21.84	21.93	21.50	0-2
5	16QAM	12	0	20.25	20.46	20.51		
5	16QAM	12	7	20.15	20.48	20.50		
5	16QAM	12	13	20.12	20.48	20.52	21.50	0-2
5	16QAM	25	0	20.08	20.63	20.63		

**<WLAN Conducted Power>****General Note:**

1. Per KDB 248227 D01 v02r02, SAR test reduction is determined according to 802.11 transmission mode configurations and certain exposure conditions with multiple test positions. In the 2.4 GHz band, separate SAR procedures are applied to DSSS and OFDM configurations to simplify DSSS test requirements. For OFDM, in both 2.4 and 5 GHz bands, an initial test configuration must be determined for each standalone and aggregated frequency band, according to the transmission mode configuration with the highest maximum output power specified for production units to perform SAR measurements. If the same highest maximum output power applies to different combinations of channel bandwidths, modulations and data rates, additional procedures are applied to determine which test configurations require SAR measurement. When applicable, an initial test position may be applied to reduce the number of SAR measurements required for next to the ear, UMPC mini-tablet or hotspot mode configurations with multiple test positions.
2. For 2.4 GHz 802.11b DSSS, either the initial test position procedure for multiple exposure test positions or the DSSS procedure for fixed exposure position is applied; these are mutually exclusive. For 2.4 GHz and 5 GHz OFDM configurations, the initial test configuration is applied to measure SAR using either the initial test position procedure for multiple exposure test position configurations or the initial test configuration procedures for fixed exposure test conditions. Based on the reported SAR of the measured configurations and maximum output power of the transmission mode configurations that are not included in the initial test configuration, the subsequent test configuration and initial test position procedures are applied to determine if SAR measurements are required for the remaining OFDM transmission configurations. In general, the number of test channels that require SAR measurement is minimized based on maximum output power measured for the test sample(s).
3. For OFDM transmission configurations in the 2.4 GHz and 5 GHz bands, When the same maximum power is specified for multiple transmission modes in a frequency band, the largest channel bandwidth, lowest order modulation, lowest data rate and lowest order 802.11a/g/n/ac mode is used for SAR measurement, on the highest measured output power channel for each frequency band.
4. DSSS and OFDM configurations are considered separately according to the required SAR procedures. SAR is measured in the initial test position using the 802.11 transmission mode configuration required by the DSSS procedure or initial test configuration and subsequent test configuration(s) according to the OFDM procedures.18 The initial test position procedure is described in the following:
 - a. When the reported SAR of the initial test position is ≤ 0.4 W/kg, further SAR measurement is not required for the other test positions in that exposure configuration and 802.11 transmission mode combinations within the frequency band or aggregated band.
 - b. When the reported SAR of the test position is > 0.4 W/kg, SAR is repeated for the 802.11 transmission mode configuration tested in the initial test position to measure the subsequent next closet/smallest test separation distance and maximum coupling test position on the highest maximum output power channel, until the report SAR is ≤ 0.8 W/kg or all required test position are tested.
 - c. For all positions/configurations, when the reported SAR is > 0.8 W/kg, SAR is measured for these test positions/configurations on the subsequent next highest measured output power channel(s) until the reported SAR is ≤ 1.2 W/kg or all required channels are tested.



<2.4GHz WLAN>

	Mode	Channel	Frequency (MHz)	Data Rate	Average power (dBm)	Tune-Up Limit	Duty Cycle %
2.4GHz WLAN	802.11b	CH 1	2412	1Mbps	13.94	14.50	97.36
		CH 6	2437		15.48	16.00	
		CH 11	2462		14.35	15.00	
	802.11g	CH 1	2412	6Mbps	10.88	11.00	87.18
		CH 6	2437		12.39	12.50	
		CH 11	2462		11.34	11.50	
	802.11n-HT20	CH 1	2412	MCS0	8.79	9.00	87.27
		CH 6	2437		10.26	10.50	
		CH 11	2462		9.23	9.50	



<2.4GHz Bluetooth>

General Note:

For 2.4GHz Bluetooth SAR testing was selected 1Mbps, due to its highest average power.

Mode	Channel	Frequency (MHz)	Average power (dBm)			Tune-Up Limit
			1Mbps	2Mbps	3Mbps	
v3.0 with EDR	CH 00	2402	9.80	7.48	7.51	10.50
	CH 39	2441	11.04	8.72	8.76	11.50
	CH 78	2480	8.34	6.03	6.06	9.00

Mode	Channel	Frequency (MHz)	Average power (dBm)	Tune-Up Limit
			GFSK	
v4.0 with LE	CH 00	2402	0.64	2.00
	CH 19	2440	1.54	
	CH 39	2480	-0.51	

13. Antenna Location

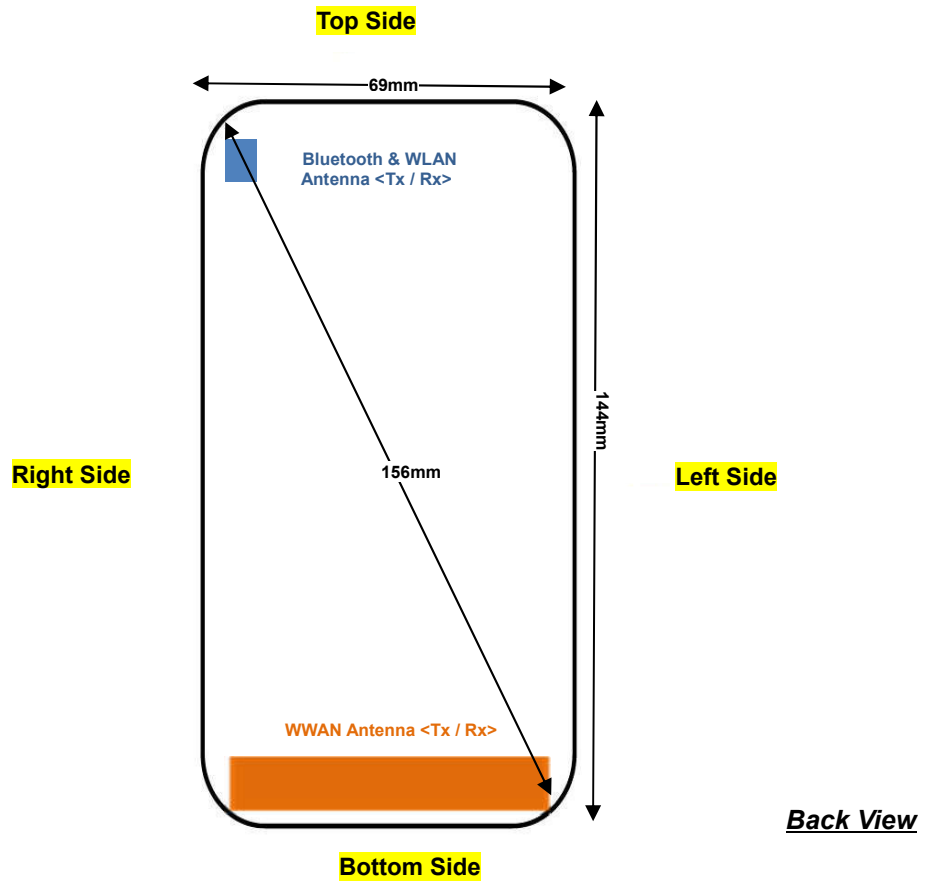

Distance of the Antenna to the EUT surface/edge						
Antennas	Back	Front	Top Side	Bottom Side	Right Side	Left Side
WWAN Main	≤ 25mm	≤ 25mm	134mm	≤ 25mm	≤ 25mm	≤ 25mm
BT&WLAN	≤ 25mm	≤ 25mm	≤ 25mm	135mm	≤ 25mm	65mm

Positions for SAR tests; Hotspot mode						
Antennas	Back	Front	Top Side	Bottom Side	Right Side	Left Side
WWAN Main	Yes	Yes	No	Yes	Yes	Yes
BT&WLAN	Yes	Yes	Yes	No	Yes	No

General Note:

Referring to KDB 941225 D06 v02r01, when the overall device length and width are ≥ 9cm*5cm, the test distance is 10 mm. SAR must be measured for all sides and surfaces with a transmitting antenna located within 25mm from that surface or edge



14. SAR Test Results

General Note:

1. Per KDB 447498 D01v06, the reported SAR is the measured SAR value adjusted for maximum tune-up tolerance.
 - a. Tune-up scaling Factor = tune-up limit power (mW) / EUT RF power (mW), where tune-up limit is the maximum rated power among all production units.
 - b. For SAR testing of WLAN signal with non-100% duty cycle, the measured SAR is scaled-up by the duty cycle scaling factor which is equal to "1/(duty cycle)"
 - c. For WWAN/Bluetooth: Reported SAR(W/kg)= Measured SAR(W/kg)*Tune-up Scaling Factor
 - d. For WLAN: Reported SAR(W/kg)= Measured SAR(W/kg)* Duty Cycle scaling factor * Tune-up scaling factor
2. Per KDB 447498 D01v06, for each exposure position, testing of other required channels within the operating mode of a frequency band is not required when the *reported* 1-g or 10-g SAR for the mid-band or highest output power channel is:
 - ≤ 0.8 W/kg or 2.0 W/kg, for 1-g or 10-g respectively, when the transmission band is ≤ 100 MHz
 - ≤ 0.6 W/kg or 1.5 W/kg, for 1-g or 10-g respectively, when the transmission band is between 100 MHz and 200 MHz
 - ≤ 0.4 W/kg or 1.0 W/kg, for 1-g or 10-g respectively, when the transmission band is ≥ 200 MHz
3. Per KDB 648474 D04v01r03, when the reported SAR for a body-worn accessory measured without a headset connected to the handset is ≤ 1.2 W/kg, SAR testing with a headset connected to the handset is not required.

GSM Note:

1. Per KDB 941225 D01v03r01, considering the possibility of e.g. 3rd party VoIP operation for Head and body-worn SAR test reduction for GSM and GPRS and EDGE modes is determined by the source-based time-averaged output power including tune-up tolerance. The mode with highest specified time-averaged output power should be tested for SAR compliance in the applicable exposure conditions. For modes with the same specified maximum output power and tolerance, the higher number time-slot configuration should be tested. Therefore, the EUT was set in GPRS (4Tx slots) for GSM850/GSM1900.
2. Per KDB 941225 D01v03r01, for Hotspot SAR test reduction for GPRS and EDGE modes is determined by the source-based time-averaged output power including tune-up tolerance, for modes with the same specified maximum output power and tolerance, the higher number time-slot configuration should be tested, therefore, the EUT was set in GPRS (4Tx slots) for GSM850/GSM1900.

UMTS Note:

1. Per KDB 941225 D01v03r01, SAR for Head / Hotspot / Body-worn exposure is measured using a 12.2 kbps RMC with TPC bits configured to all "1's".
2. Per KDB 941225 D01v03r01, RMC 12.2kbps setting is used to evaluate SAR. If the maximum output power and tune-up tolerance specified for production units in HSDPA / HSUPA / DC-HSDPA is $\leq 1/4$ dB higher than RMC 12.2Kbps or when the highest reported SAR of the RMC12.2Kbps is scaled by the ratio of specified maximum output power and tune-up tolerance of HSDPA / HSUPA / DC-HSDPA to RMC12.2Kbps and the adjusted SAR is ≤ 1.2 W/kg, SAR measurement is not required for HSDPA / HSUPA / DC-HSDPA.

**LTE Note:**

1. Per KDB 941225 D05v02r04, start with the largest channel bandwidth and measure SAR for QPSK with 1 RB allocation, using the RB offset and required test channel combination with the highest maximum output power for RB offsets at the upper edge, middle and lower edge of each required test channel.
2. Per KDB 941225 D05v02r04, 50% RB allocation for QPSK SAR testing follows 1RB QPSK allocation procedure.
3. Per KDB 941225 D05v02r04, For QPSK with 100% RB allocation, SAR is not required when the highest maximum output power for 100 % RB allocation is less than the highest maximum output power in 50% and 1 RB allocations and the highest reported SAR for 1 RB and 50% RB allocation are ≤ 0.8 W/kg. Otherwise, SAR is measured for the highest output power channel; and if the reported SAR is > 1.45 W/kg, the remaining required test channels must also be tested.
4. Per KDB 941225 D05v02r04, 16QAM output power for each RB allocation configuration is $>$ not $\frac{1}{2}$ dB higher than the same configuration in QPSK and the reported SAR for the QPSK configuration is ≤ 1.45 W/kg; Per KDB 941225 D05v02r04, 16QAM SAR testing is not required.
5. Per KDB 941225 D05v02r04, Smaller bandwidth output power for each RB allocation configuration is $>$ not $\frac{1}{2}$ dB higher than the same configuration in the largest supported bandwidth, and the reported SAR for the largest supported bandwidth is ≤ 1.45 W/kg; Per KDB 941225 D05v02r04, smaller bandwidth SAR testing is not required.
6. For LTE B12 / B5 / B4 the maximum bandwidth does not support three non-overlapping channels, per KDB 941225 D05v02r04, when a device supports overlapping channel assignment in a channel bandwidth configuration, the middle channel of the group of overlapping channels should be selected for testing.
7. LTE band 17 SAR test was covered by Band 12; according to TCB workshop, SAR test for overlapping LTE bands can be reduced if
 - a. The maximum output power, including tolerance, for the smaller band is \leq the larger band to qualify for the SAR test exclusion.
 - b. The channel bandwidth and other operating parameters for the smaller band are fully supported by the larger band.

WLAN Note:

1. Per KDB 248227 D01 v02r02, for 2.4GHz 802.11g/n SAR testing is not required when the highest reported SAR for DSSS is adjusted by the ratio of OFDM to DSSS specified maximum output power and the adjusted SAR is ≤ 1.2 W/kg.
2. When the reported SAR of the test position is > 0.4 W/kg, SAR is repeated for the 802.11 transmission mode configuration tested in the initial test position to measure the subsequent next closet/smallest test separation distance and maximum coupling test position on the highest maximum output power channel, until the report SAR is ≤ 0.8 W/kg or all required test position are tested.
3. For all positions / configurations, when the reported SAR is > 0.8 W/kg, SAR is measured for these test positions / configurations on the subsequent next highest measured output power channel(s) until the reported SAR is ≤ 1.2 W/kg or all required channels are tested.
4. During SAR testing the WLAN transmission was verified using a spectrum analyzer.



14.1 Head SAR

<GSM SAR>

Plot No.	Band	Mode	Test Position	Ch.	Freq. (MHz)	Average Power (dBm)	Tune-Up Limit (dBm)	Tune-up Scaling Factor	Power Drift (dB)	Measured 1g SAR (W/kg)	Reported 1g SAR (W/kg)
	GSM850	GPRS(4 Tx slots)	Right Cheek	251	848.8	31.77	32.50	1.183	0.06	0.230	0.272
	GSM850	GPRS(4 Tx slots)	Right Tilted	251	848.8	31.77	32.50	1.183	0.13	0.164	0.194
#01	GSM850	GPRS(4 Tx slots)	Left Cheek	251	848.8	31.77	32.50	1.183	-0.08	0.382	0.452
	GSM850	GPRS(4 Tx slots)	Left Tilted	251	848.8	31.77	32.50	1.183	-0.03	0.174	0.206
	GSM850	GPRS(4 Tx slots)	Left Cheek	128	824.2	31.69	32.50	1.205	0.19	0.344	0.415
	GSM850	GPRS(4 Tx slots)	Left Cheek	189	836.4	31.70	32.50	1.202	-0.05	0.360	0.433
	GSM1900	GPRS(4 Tx slots)	Right Cheek	810	1909.8	28.77	29.50	1.183	-0.07	0.136	0.161
	GSM1900	GPRS(4 Tx slots)	Right Tilted	810	1909.8	28.77	29.50	1.183	0.01	0.034	0.040
	GSM1900	GPRS(4 Tx slots)	Left Cheek	810	1909.8	28.77	29.50	1.183	-0.08	0.095	0.112
	GSM1900	GPRS(4 Tx slots)	Left Tilted	810	1909.8	28.77	29.50	1.183	0.02	0.089	0.105
#02	GSM1900	GPRS(4 Tx slots)	Right Cheek	512	1850.2	28.70	29.50	1.202	0.04	0.172	0.207
	GSM1900	GPRS(4 Tx slots)	Right Cheek	661	1880	28.75	29.50	1.189	-0.01	0.160	0.190

<WCDMA SAR>

Plot No.	Band	Mode	Test Position	Ch.	Freq. (MHz)	Average Power (dBm)	Tune-Up Limit (dBm)	Tune-up Scaling Factor	Power Drift (dB)	Measured 1g SAR (W/kg)	Reported 1g SAR (W/kg)
	WCDMA Band V	RMC 12.2Kbps	Right Cheek	4182	836.4	23.62	24.00	1.091	0.09	0.118	0.129
	WCDMA Band V	RMC 12.2Kbps	Right Tilted	4182	836.4	23.62	24.00	1.091	-0.08	0.078	0.085
	WCDMA Band V	RMC 12.2Kbps	Left Cheek	4182	836.4	23.62	24.00	1.091	-0.07	0.171	0.187
	WCDMA Band V	RMC 12.2Kbps	Left Tilted	4182	836.4	23.62	24.00	1.091	-0.02	0.087	0.095
	WCDMA Band V	RMC 12.2Kbps	Left Cheek	4132	826.4	23.59	24.00	1.099	-0.07	0.154	0.169
#03	WCDMA Band V	RMC 12.2Kbps	Left Cheek	4233	846.6	23.54	24.00	1.112	-0.03	0.170	0.189
	WCDMA Band IV	RMC 12.2Kbps	Right Cheek	1513	1752.6	23.25	23.50	1.059	0.09	0.200	0.212
	WCDMA Band IV	RMC 12.2Kbps	Right Tilted	1513	1752.6	23.25	23.50	1.059	-0.02	0.052	0.055
	WCDMA Band IV	RMC 12.2Kbps	Left Cheek	1513	1752.6	23.25	23.50	1.059	0.06	0.109	0.115
	WCDMA Band IV	RMC 12.2Kbps	Left Tilted	1513	1752.6	23.25	23.50	1.059	-0.03	0.075	0.079
	WCDMA Band IV	RMC 12.2Kbps	Right Cheek	1312	1712.4	23.00	23.50	1.122	-0.01	0.163	0.183
#04	WCDMA Band IV	RMC 12.2Kbps	Right Cheek	1413	1732.6	23.10	23.50	1.096	-0.15	0.221	0.242
	WCDMA Band II	RMC 12.2Kbps	Right Cheek	9400	1880	22.77	23.00	1.054	0.07	0.190	0.200
	WCDMA Band II	RMC 12.2Kbps	Right Tilted	9400	1880	22.77	23.00	1.054	-0.07	0.055	0.058
	WCDMA Band II	RMC 12.2Kbps	Left Cheek	9400	1880	22.77	23.00	1.054	-0.07	0.136	0.143
	WCDMA Band II	RMC 12.2Kbps	Left Tilted	9400	1880	22.77	23.00	1.054	0.07	0.127	0.134
	WCDMA Band II	RMC 12.2Kbps	Right Cheek	9262	1852.4	22.67	23.00	1.079	0.08	0.260	0.281
#05	WCDMA Band II	RMC 12.2Kbps	Right Cheek	9538	1907.6	22.65	23.00	1.084	0.05	0.293	0.318



<LTE SAR>

Plot No.	Band	BW (MHz)	RB Size	RB offset	Modulation	Test Position	Ch.	Freq. (MHz)	Average Power (dBm)	Tune-Up Limit (dBm)	Tune-up Scaling Factor	Power Drift (dB)	Measured 1g SAR (W/kg)	Reported 1g SAR (W/kg)
	LTE Band 12	10M	1	49	QPSK	Right Cheek	23095	707.5	22.68	23.50	1.208	0.05	0.155	0.187
	LTE Band 12	10M	1	49	QPSK	Right Tilted	23095	707.5	22.68	23.50	1.208	0.14	0.108	0.130
#06	LTE Band 12	10M	1	49	QPSK	Left Cheek	23095	707.5	22.68	23.50	1.208	-0.15	0.165	0.199
	LTE Band 12	10M	1	49	QPSK	Left Tilted	23095	707.5	22.68	23.50	1.208	0.06	0.099	0.120
	LTE Band 12	10M	25	0	QPSK	Right Cheek	23095	707.5	21.83	22.50	1.167	0.04	0.114	0.133
	LTE Band 12	10M	25	0	QPSK	Right Tilted	23095	707.5	21.83	22.50	1.167	-0.07	0.078	0.091
	LTE Band 12	10M	25	0	QPSK	Left Cheek	23095	707.5	21.83	22.50	1.167	-0.14	0.127	0.148
	LTE Band 12	10M	25	0	QPSK	Left Tilted	23095	707.5	21.83	22.50	1.167	-0.04	0.074	0.086
	LTE Band 5	10M	1	0	QPSK	Right Cheek	20525	836.5	22.81	23.50	1.172	0.03	0.172	0.202
	LTE Band 5	10M	1	0	QPSK	Right Tilted	20525	836.5	22.81	23.50	1.172	0.08	0.126	0.148
#07	LTE Band 5	10M	1	0	QPSK	Left Cheek	20525	836.5	22.81	23.50	1.172	0.04	0.264	0.309
	LTE Band 5	10M	1	0	QPSK	Left Tilted	20525	836.5	22.81	23.50	1.172	-0.06	0.128	0.150
	LTE Band 5	10M	25	25	QPSK	Right Cheek	20525	836.5	21.77	22.50	1.183	-0.16	0.149	0.176
	LTE Band 5	10M	25	25	QPSK	Right Tilted	20525	836.5	21.77	22.50	1.183	0.04	0.104	0.123
	LTE Band 5	10M	25	25	QPSK	Left Cheek	20525	836.5	21.77	22.50	1.183	-0.06	0.222	0.263
	LTE Band 5	10M	25	25	QPSK	Left Tilted	20525	836.5	21.77	22.50	1.183	-0.05	0.108	0.128
#08	LTE Band 4	20M	1	49	QPSK	Right Cheek	20175	1732.5	23.01	24.00	1.256	0.04	0.257	0.323
	LTE Band 4	20M	1	49	QPSK	Right Tilted	20175	1732.5	23.01	24.00	1.256	0.09	0.028	0.035
	LTE Band 4	20M	1	49	QPSK	Left Cheek	20175	1732.5	23.01	24.00	1.256	0.02	0.088	0.111
	LTE Band 4	20M	1	49	QPSK	Left Tilted	20175	1732.5	23.01	24.00	1.256	-0.15	0.071	0.089
	LTE Band 4	20M	50	0	QPSK	Right Cheek	20175	1732.5	21.98	23.00	1.265	0.01	0.177	0.224
	LTE Band 4	20M	50	0	QPSK	Right Tilted	20175	1732.5	21.98	23.00	1.265	0.06	0.027	0.034
	LTE Band 4	20M	50	0	QPSK	Left Cheek	20175	1732.5	21.98	23.00	1.265	0.19	0.079	0.100
	LTE Band 4	20M	50	0	QPSK	Left Tilted	20175	1732.5	21.98	23.00	1.265	0.07	0.041	0.052
	LTE Band 2	20M	1	49	QPSK	Right Cheek	18700	1860	23.06	23.50	1.107	0.06	0.130	0.144
	LTE Band 2	20M	1	49	QPSK	Right Tilted	18700	1860	23.06	23.50	1.107	-0.04	0.032	0.035
	LTE Band 2	20M	1	49	QPSK	Left Cheek	18700	1860	23.06	23.50	1.107	-0.07	0.096	0.106
	LTE Band 2	20M	1	49	QPSK	Left Tilted	18700	1860	23.06	23.50	1.107	0.09	0.074	0.082
	LTE Band 2	20M	1	49	QPSK	Right Cheek	18900	1880	23.03	23.50	1.114	0.04	0.153	0.170
#09	LTE Band 2	20M	1	49	QPSK	Right Cheek	19100	1900	22.98	23.50	1.127	0.08	0.173	0.195
	LTE Band 2	20M	50	0	QPSK	Right Cheek	18700	1860	22.02	22.50	1.117	-0.19	0.114	0.127
	LTE Band 2	20M	50	0	QPSK	Right Tilted	18700	1860	22.02	22.50	1.117	0.03	0.025	0.028
	LTE Band 2	20M	50	0	QPSK	Left Cheek	18700	1860	22.02	22.50	1.117	0.03	0.076	0.085
	LTE Band 2	20M	50	0	QPSK	Left Tilted	18700	1860	22.02	22.50	1.117	0.01	0.053	0.059
	LTE Band 7	20M	1	49	QPSK	Right Cheek	21100	2535	22.81	23.50	1.172	-0.01	0.042	0.049
	LTE Band 7	20M	1	49	QPSK	Right Tilted	21100	2535	22.81	23.50	1.172	0.02	0.014	0.016
	LTE Band 7	20M	1	49	QPSK	Left Cheek	21100	2535	22.81	23.50	1.172	-0.03	0.039	0.046
	LTE Band 7	20M	1	49	QPSK	Left Tilted	21100	2535	22.81	23.50	1.172	0.04	0.020	0.023
	LTE Band 7	20M	1	49	QPSK	Right Cheek	20850	2510	22.29	23.50	1.321	0.11	0.035	0.046
#10	LTE Band 7	20M	1	49	QPSK	Right Cheek	21350	2560	22.78	23.50	1.180	-0.03	0.047	0.055
	LTE Band 7	20M	50	0	QPSK	Right Cheek	21100	2535	21.64	22.50	1.219	0.03	0.029	0.035
	LTE Band 7	20M	50	0	QPSK	Right Tilted	21100	2535	21.64	22.50	1.219	-0.08	0.00698	0.009
	LTE Band 7	20M	50	0	QPSK	Left Cheek	21100	2535	21.64	22.50	1.219	-0.09	0.029	0.035
	LTE Band 7	20M	50	0	QPSK	Left Tilted	21100	2535	21.64	22.50	1.219	-0.09	0.014	0.017



<WLAN SAR>

Plot No.	Band	Mode	Test Position	Ch.	Freq. (MHz)	Average Power (dBm)	Tune-Up Limit (dBm)	Tune-up Scaling Factor	Duty Cycle %	Duty Cycle Scaling Factor	Power Drift (dB)	Measured 1g SAR (W/kg)	Reported 1g SAR (W/kg)
	WLAN 2.4GHz	802.11b 1Mbps	Right Cheek	6	2437	15.48	16.00	1.128	97.36	1.027	-0.04	0.114	0.132
	WLAN 2.4GHz	802.11b 1Mbps	Right Tilted	6	2437	15.48	16.00	1.128	97.36	1.027	-0.08	0.151	0.175
	WLAN 2.4GHz	802.11b 1Mbps	Left Cheek	6	2437	15.48	16.00	1.128	97.36	1.027	-0.01	0.346	0.401
	WLAN 2.4GHz	802.11b 1Mbps	Left Tilted	6	2437	15.48	16.00	1.128	97.36	1.027	0.07	0.251	0.291
	WLAN 2.4GHz	802.11b 1Mbps	Left Cheek	1	2412	13.94	14.50	1.139	97.36	1.027	-0.05	0.299	0.350
#11	WLAN 2.4GHz	802.11b 1Mbps	Left Cheek	11	2462	14.35	15.00	1.163	97.36	1.027	0.01	0.415	0.495

<Bluetooth SAR>

Plot No.	Band	Mode	Test Position	Ch.	Freq. (MHz)	Average Power (dBm)	Tune-Up Limit (dBm)	Tune-up Scaling Factor	Power Drift (dB)	Measured 1g SAR (W/kg)	Reported 1g SAR (W/kg)
	Bluetooth	1Mbps	Right Cheek	39	2441	11.04	11.50	1.113	-0.01	0.021	0.023
	Bluetooth	1Mbps	Right Tilted	39	2441	11.04	11.50	1.113	0.06	0.027	0.030
	Bluetooth	1Mbps	Left Cheek	39	2441	11.04	11.50	1.113	-0.02	0.063	0.070
	Bluetooth	1Mbps	Left Tilted	39	2441	11.04	11.50	1.113	0.02	0.042	0.047
#12	Bluetooth	1Mbps	Left Cheek	0	2402	9.80	10.50	1.176	-0.09	0.062	0.073
	Bluetooth	1Mbps	Left Cheek	78	2480	8.34	9.00	1.165	-0.13	0.051	0.059



14.2 Hotspot SAR

<GSM SAR>

Plot No.	Band	Mode	Test Position	Gap (mm)	Ch.	Freq. (MHz)	Average Power (dBm)	Tune-Up Limit (dBm)	Tune-up Scaling Factor	Power Drift (dB)	Measured 1g SAR (W/kg)	Reported 1g SAR (W/kg)
	GSM850	GPRS(4 Tx slots)	Front	10	251	848.8	31.77	32.50	1.183	-0.05	0.839	0.993
#13	GSM850	GPRS(4 Tx slots)	Back	10	251	848.8	31.77	32.50	1.183	0.1	0.851	1.007
	GSM850	GPRS(4 Tx slots)	Left Side	10	251	848.8	31.77	32.50	1.183	-0.08	0.612	0.724
	GSM850	GPRS(4 Tx slots)	Right Side	10	251	848.8	31.77	32.50	1.183	-0.03	0.143	0.169
	GSM850	GPRS(4 Tx slots)	Bottom Side	10	251	848.8	31.77	32.50	1.183	-0.11	0.607	0.718
	GSM850	GPRS(4 Tx slots)	Front	10	128	824.2	31.69	32.50	1.205	0.02	0.637	0.768
	GSM850	GPRS(4 Tx slots)	Front	10	189	836.4	31.70	32.50	1.202	0.02	0.699	0.840
	GSM850	GPRS(4 Tx slots)	Back	10	128	824.2	31.69	32.50	1.205	-0.02	0.760	0.916
	GSM850	GPRS(4 Tx slots)	Back	10	189	836.4	31.70	32.50	1.202	0.11	0.784	0.943
	GSM1900	GPRS(4 Tx slots)	Front	10	810	1909.8	28.77	29.50	1.183	-0.04	0.338	0.400
	GSM1900	GPRS(4 Tx slots)	Back	10	810	1909.8	28.77	29.50	1.183	0.04	0.597	0.706
	GSM1900	GPRS(4 Tx slots)	Left Side	10	810	1909.8	28.77	29.50	1.183	0.07	0.098	0.116
	GSM1900	GPRS(4 Tx slots)	Right Side	10	810	1909.8	28.77	29.50	1.183	0.11	0.138	0.163
#14	GSM1900	GPRS(4 Tx slots)	Bottom Side	10	810	1909.8	28.77	29.50	1.183	-0.13	0.855	1.012
	GSM1900	GPRS(4 Tx slots)	Back	10	512	1850.2	28.70	29.50	1.202	-0.04	0.565	0.679
	GSM1900	GPRS(4 Tx slots)	Back	10	661	1880	28.75	29.50	1.189	0.09	0.562	0.668
	GSM1900	GPRS(4 Tx slots)	Bottom Side	10	512	1850.2	28.70	29.50	1.202	0.07	0.838	1.007
	GSM1900	GPRS(4 Tx slots)	Bottom Side	10	661	1880	28.75	29.50	1.189	-0.09	0.806	0.958



<WCDMA SAR>

Plot No.	Band	Mode	Test Position	Gap (mm)	Ch.	Freq. (MHz)	Average Power (dBm)	Tune-Up Limit (dBm)	Tune-up Scaling Factor	Power Drift (dB)	Measured 1g SAR (W/kg)	Reported 1g SAR (W/kg)
	WCDMA Band V	RMC12.2Kbps	Front	10	4182	836.4	23.62	24.00	1.091	0.05	0.491	0.536
	WCDMA Band V	RMC12.2Kbps	Back	10	4182	836.4	23.62	24.00	1.091	0.15	0.509	0.556
	WCDMA Band V	RMC12.2Kbps	Left Side	10	4182	836.4	23.62	24.00	1.091	0.05	0.351	0.383
	WCDMA Band V	RMC12.2Kbps	Right Side	10	4182	836.4	23.62	24.00	1.091	-0.05	0.108	0.118
	WCDMA Band V	RMC12.2Kbps	Bottom Side	10	4182	836.4	23.62	24.00	1.091	-0.09	0.340	0.371
	WCDMA Band V	RMC12.2Kbps	Back	10	4132	826.4	23.59	24.00	1.099	-0.16	0.440	0.484
#15	WCDMA Band V	RMC12.2Kbps	Back	10	4233	846.6	23.54	24.00	1.112	-0.01	0.502	0.558
	WCDMA Band IV	RMC12.2Kbps	Front	10	1513	1752.6	23.25	23.50	1.059	-0.13	0.557	0.590
	WCDMA Band IV	RMC12.2Kbps	Back	10	1513	1752.6	23.25	23.50	1.059	0.03	0.725	0.768
	WCDMA Band IV	RMC12.2Kbps	Left Side	10	1513	1752.6	23.25	23.50	1.059	-0.04	0.078	0.083
	WCDMA Band IV	RMC12.2Kbps	Right Side	10	1513	1752.6	23.25	23.50	1.059	-0.07	0.191	0.202
#16	WCDMA Band IV	RMC12.2Kbps	Bottom Side	10	1513	1752.6	23.25	23.50	1.059	-0.03	0.911	0.965
	WCDMA Band IV	RMC12.2Kbps	Back	10	1312	1712.4	23.00	23.50	1.122	-0.05	0.659	0.739
	WCDMA Band IV	RMC12.2Kbps	Back	10	1413	1732.6	23.10	23.50	1.096	-0.06	0.700	0.768
	WCDMA Band IV	RMC12.2Kbps	Bottom Side	10	1312	1712.4	23.00	23.50	1.122	0.11	0.765	0.858
	WCDMA Band IV	RMC12.2Kbps	Bottom Side	10	1413	1732.6	23.10	23.50	1.096	-0.05	0.821	0.900
	WCDMA Band II	RMC12.2Kbps	Front	10	9400	1880	22.77	23.00	1.054	0.04	0.663	0.699
	WCDMA Band II	RMC12.2Kbps	Back	10	9400	1880	22.77	23.00	1.054	0.02	0.869	0.916
	WCDMA Band II	RMC12.2Kbps	Left Side	10	9400	1880	22.77	23.00	1.054	-0.02	0.140	0.148
	WCDMA Band II	RMC12.2Kbps	Right Side	10	9400	1880	22.77	23.00	1.054	0.08	0.231	0.244
	WCDMA Band II	RMC12.2Kbps	Bottom Side	10	9400	1880	22.77	23.00	1.054	-0.07	1.300	1.371
	WCDMA Band II	RMC12.2Kbps	Back	10	9262	1852.4	22.67	23.00	1.079	-0.08	0.872	0.941
	WCDMA Band II	RMC12.2Kbps	Back	10	9538	1907.6	22.65	23.00	1.084	-0.02	0.914	0.991
	WCDMA Band II	RMC12.2Kbps	Bottom Side	10	9262	1852.4	22.67	23.00	1.079	0.01	1.290	1.392
#17	WCDMA Band II	RMC12.2Kbps	Bottom Side	10	9538	1907.6	22.65	23.00	1.084	0.07	1.400	1.517



<LTE SAR>

Plot No.	Band	BW (MHz)	RB Size	RB offset	Modulation	Test Position	Gap (mm)	Ch.	Freq. (MHz)	Average Power (dBm)	Tune-Up Limit (dBm)	Tune-up Scaling Factor	Power Drift (dB)	Measured 1g SAR (W/kg)	Reported 1g SAR (W/kg)
#18	LTE Band 12	10M	1	49	QPSK	Front	10	23095	707.5	22.68	23.50	1.208	-0.05	0.342	0.413
	LTE Band 12	10M	1	49	QPSK	Back	10	23095	707.5	22.68	23.50	1.208	-0.03	0.368	0.444
	LTE Band 12	10M	1	49	QPSK	Left Side	10	23095	707.5	22.68	23.50	1.208	-0.15	0.152	0.184
	LTE Band 12	10M	1	49	QPSK	Right Side	10	23095	707.5	22.68	23.50	1.208	-0.12	0.170	0.205
	LTE Band 12	10M	1	49	QPSK	Bottom Side	10	23095	707.5	22.68	23.50	1.208	0.06	0.142	0.172
	LTE Band 12	10M	25	0	QPSK	Front	10	23095	707.5	21.83	22.50	1.167	-0.06	0.257	0.300
	LTE Band 12	10M	25	0	QPSK	Back	10	23095	707.5	21.83	22.50	1.167	-0.1	0.294	0.343
	LTE Band 12	10M	25	0	QPSK	Left Side	10	23095	707.5	21.83	22.50	1.167	0.02	0.125	0.146
	LTE Band 12	10M	25	0	QPSK	Right Side	10	23095	707.5	21.83	22.50	1.167	0.07	0.130	0.152
	LTE Band 12	10M	25	0	QPSK	Bottom Side	10	23095	707.5	21.83	22.50	1.167	0.01	0.108	0.126
#19	LTE Band 5	10M	1	0	QPSK	Front	10	20525	836.5	22.81	23.50	1.172	-0.07	0.566	0.663
	LTE Band 5	10M	1	0	QPSK	Back	10	20525	836.5	22.81	23.50	1.172	-0.01	0.607	0.712
	LTE Band 5	10M	1	0	QPSK	Left Side	10	20525	836.5	22.81	23.50	1.172	-0.07	0.417	0.489
	LTE Band 5	10M	1	0	QPSK	Right Side	10	20525	836.5	22.81	23.50	1.172	0.05	0.117	0.137
	LTE Band 5	10M	1	0	QPSK	Bottom Side	10	20525	836.5	22.81	23.50	1.172	0.01	0.408	0.478
	LTE Band 5	10M	25	25	QPSK	Front	10	20525	836.5	21.77	22.50	1.183	0.03	0.498	0.589
	LTE Band 5	10M	25	25	QPSK	Back	10	20525	836.5	21.77	22.50	1.183	-0.05	0.505	0.597
	LTE Band 5	10M	25	25	QPSK	Left Side	10	20525	836.5	21.77	22.50	1.183	-0.01	0.343	0.406
	LTE Band 5	10M	25	25	QPSK	Right Side	10	20525	836.5	21.77	22.50	1.183	0.1	0.100	0.118
	LTE Band 5	10M	25	25	QPSK	Bottom Side	10	20525	836.5	21.77	22.50	1.183	0.01	0.346	0.409
#20	LTE Band 4	20M	1	49	QPSK	Front	10	20175	1732.5	23.01	24.00	1.256	0.01	0.438	0.550
	LTE Band 4	20M	1	49	QPSK	Back	10	20175	1732.5	23.01	24.00	1.256	0.06	0.545	0.685
	LTE Band 4	20M	1	49	QPSK	Left Side	10	20175	1732.5	23.01	24.00	1.256	-0.04	0.078	0.098
	LTE Band 4	20M	1	49	QPSK	Right Side	10	20175	1732.5	23.01	24.00	1.256	-0.01	0.155	0.195
	LTE Band 4	20M	1	49	QPSK	Bottom Side	10	20175	1732.5	23.01	24.00	1.256	0.13	0.713	0.896
	LTE Band 4	20M	50	0	QPSK	Front	10	20175	1732.5	21.98	23.00	1.265	0.07	0.426	0.539
	LTE Band 4	20M	50	0	QPSK	Back	10	20175	1732.5	21.98	23.00	1.265	0.04	0.509	0.644
	LTE Band 4	20M	50	0	QPSK	Left Side	10	20175	1732.5	21.98	23.00	1.265	-0.09	0.073	0.092
	LTE Band 4	20M	50	0	QPSK	Right Side	10	20175	1732.5	21.98	23.00	1.265	-0.06	0.146	0.185
	LTE Band 4	20M	50	0	QPSK	Bottom Side	10	20175	1732.5	21.98	23.00	1.265	-0.01	0.668	0.845
	LTE Band 4	20M	100	0	QPSK	Front	10	20175	1732.5	21.96	23.00	1.271	0.09	0.525	0.667
	LTE Band 4	20M	100	0	QPSK	Bottom Side	10	20175	1732.5	21.96	23.00	1.271	-0.09	0.662	0.841



Plot No.	Band	BW (MHz)	RB Size	RB offset	Modulation	Test Position	Gap (mm)	Ch.	Freq. (MHz)	Average Power (dBm)	Tune-Up Limit (dBm)	Tune-up Scaling Factor	Power Drift (dB)	Measured 1g SAR (W/kg)	Reported 1g SAR (W/kg)
	LTE Band 2	20M	1	49	QPSK	Front	10	18700	1860	23.06	23.50	1.107	-0.01	0.486	0.538
	LTE Band 2	20M	1	49	QPSK	Back	10	18700	1860	23.06	23.50	1.107	-0.09	0.639	0.707
	LTE Band 2	20M	1	49	QPSK	Left Side	10	18700	1860	23.06	23.50	1.107	-0.12	0.070	0.077
	LTE Band 2	20M	1	49	QPSK	Right Side	10	18700	1860	23.06	23.50	1.107	-0.08	0.186	0.206
	LTE Band 2	20M	1	49	QPSK	Bottom Side	10	18700	1860	23.06	23.50	1.107	0.18	1.040	1.151
	LTE Band 2	20M	1	49	QPSK	Back	10	18900	1880	23.03	23.50	1.114	-0.03	0.678	0.755
	LTE Band 2	20M	1	49	QPSK	Back	10	19100	1900	22.98	23.50	1.127	0.08	0.781	0.880
#21	LTE Band 2	20M	1	49	QPSK	Bottom Side	10	18900	1880	23.03	23.50	1.114	-0.04	1.160	1.293
	LTE Band 2	20M	1	49	QPSK	Bottom Side	10	19100	1900	22.98	23.50	1.127	0.18	1.140	1.285
	LTE Band 2	20M	50	0	QPSK	Front	10	18700	1860	22.02	22.50	1.117	-0.08	0.393	0.439
	LTE Band 2	20M	50	0	QPSK	Back	10	18700	1860	22.02	22.50	1.117	0.12	0.509	0.568
	LTE Band 2	20M	50	0	QPSK	Left Side	10	18700	1860	22.02	22.50	1.117	-0.04	0.052	0.058
	LTE Band 2	20M	50	0	QPSK	Right Side	10	18700	1860	22.02	22.50	1.117	-0.11	0.148	0.165
	LTE Band 2	20M	50	0	QPSK	Bottom Side	10	18700	1860	22.02	22.50	1.117	-0.01	0.792	0.885
	LTE Band 2	20M	50	0	QPSK	Bottom Side	10	18900	1880	21.91	22.50	1.146	-0.13	0.834	0.955
	LTE Band 2	20M	50	0	QPSK	Bottom Side	10	19100	1900	21.85	22.50	1.161	0.03	0.849	0.986
	LTE Band 2	20M	100	0	QPSK	Back	10	18700	1860	21.90	22.50	1.148	-0.09	0.523	0.600
	LTE Band 2	20M	100	0	QPSK	Bottom Side	10	18700	1860	21.90	22.50	1.148	-0.09	0.798	0.916
	LTE Band 7	20M	1	49	QPSK	Front	10	21100	2535	22.81	23.50	1.172	-0.04	0.182	0.213
	LTE Band 7	20M	1	49	QPSK	Back	10	21100	2535	22.81	23.50	1.172	-0.05	0.273	0.320
	LTE Band 7	20M	1	49	QPSK	Left Side	10	21100	2535	22.81	23.50	1.172	-0.02	0.034	0.040
	LTE Band 7	20M	1	49	QPSK	Right Side	10	21100	2535	22.81	23.50	1.172	-0.01	0.098	0.115
	LTE Band 7	20M	1	49	QPSK	Bottom Side	10	21100	2535	22.81	23.50	1.172	-0.04	0.536	0.628
	LTE Band 7	20M	1	49	QPSK	Back	10	20850	2510	22.29	23.50	1.321	-0.04	0.241	0.318
	LTE Band 7	20M	1	49	QPSK	Back	10	21350	2560	22.78	23.50	1.180	-0.08	0.271	0.320
	LTE Band 7	20M	1	49	QPSK	Bottom Side	10	21100	2510	22.29	23.50	1.321	-0.03	0.458	0.605
#22	LTE Band 7	20M	1	49	QPSK	Bottom Side	10	21100	2560	22.78	23.50	1.180	-0.02	0.552	0.652
	LTE Band 7	20M	50	0	QPSK	Front	10	21100	2535	21.64	22.50	1.219	-0.05	0.139	0.169
	LTE Band 7	20M	50	0	QPSK	Back	10	21100	2535	21.64	22.50	1.219	-0.03	0.210	0.256
	LTE Band 7	20M	50	0	QPSK	Left Side	10	21100	2535	21.64	22.50	1.219	0.18	0.025	0.030
	LTE Band 7	20M	50	0	QPSK	Right Side	10	21100	2535	21.64	22.50	1.219	-0.01	0.073	0.089
	LTE Band 7	20M	50	0	QPSK	Bottom Side	10	21100	2535	21.64	22.50	1.219	-0.14	0.385	0.469

<WLAN SAR>

Plot No.	Band	Mode	Test Position	Gap (mm)	Ch.	Freq. (MHz)	Average Power (dBm)	Tune-Up Limit (dBm)	Tune-up Scaling Factor	Duty Cycle %	Duty Cycle Scaling Factor	Power Drift (dB)	Measured 1g SAR (W/kg)	Reported 1g SAR (W/kg)
	WLAN 2.4GHz	802.11b 1Mbps	Front	10	6	2437	15.48	16.00	1.128	97.36	1.027	-0.01	0.061	0.071
	WLAN 2.4GHz	802.11b 1Mbps	Back	10	6	2437	15.48	16.00	1.128	97.36	1.027	-0.16	0.056	0.065
	WLAN 2.4GHz	802.11b 1Mbps	Right Side	10	6	2437	15.48	16.00	1.128	97.36	1.027	-0.08	0.053	0.061
	WLAN 2.4GHz	802.11b 1Mbps	Top Side	10	6	2437	15.48	16.00	1.128	97.36	1.027	-0.03	0.137	0.159
	WLAN 2.4GHz	802.11b 1Mbps	Front	10	1	2412	13.94	14.50	1.139	97.36	1.027	-0.05	0.047	0.055
	WLAN 2.4GHz	802.11b 1Mbps	Front	10	11	2462	14.35	15.00	1.163	97.36	1.027	0.05	0.060	0.072
	WLAN 2.4GHz	802.11b 1Mbps	Top Side	10	1	2412	13.94	14.50	1.139	97.36	1.027	-0.03	0.108	0.126
#23	WLAN 2.4GHz	802.11b 1Mbps	Top Side	10	11	2462	14.35	15.00	1.163	97.36	1.027	-0.04	0.160	0.191



14.3 Body Worn Accessory SAR

<GSM SAR>

Plot No.	Band	Mode	Test Position	Gap (mm)	Ch.	Freq. (MHz)	Average Power (dBm)	Tune-Up Limit (dBm)	Tune-up Scaling Factor	Power Drift (dB)	Measured 1g SAR (W/kg)	Reported 1g SAR (W/kg)
	GSM850	GPRS(4 Tx slots)	Front	10	251	848.8	31.77	32.50	1.183	-0.05	0.839	0.993
#12	GSM850	GPRS(4 Tx slots)	Back	10	251	848.8	31.77	32.50	1.183	0.1	0.851	1.007
	GSM850	GPRS(4 Tx slots)	Front	10	128	824.2	31.69	32.50	1.205	0.02	0.637	0.768
	GSM850	GPRS(4 Tx slots)	Front	10	189	836.4	31.70	32.50	1.202	0.02	0.699	0.840
	GSM850	GPRS(4 Tx slots)	Back	10	128	824.2	31.69	32.50	1.205	-0.02	0.760	0.916
	GSM850	GPRS(4 Tx slots)	Back	10	189	836.4	31.70	32.50	1.202	0.11	0.784	0.943
	GSM1900	GPRS(4 Tx slots)	Front	10	810	1909.8	28.77	29.50	1.183	-0.04	0.338	0.400
#24	GSM1900	GPRS(4 Tx slots)	Back	10	810	1909.8	28.77	29.50	1.183	0.04	0.597	0.706
	GSM1900	GPRS(4 Tx slots)	Back	10	512	1850.2	28.70	29.50	1.202	-0.04	0.565	0.679
	GSM1900	GPRS(4 Tx slots)	Back	10	661	1880	28.75	29.50	1.189	0.09	0.562	0.668

<WCDMA SAR>

Plot No.	Band	Mode	Test Position	Gap (mm)	Ch.	Freq. (MHz)	Average Power (dBm)	Tune-Up Limit (dBm)	Tune-up Scaling Factor	Power Drift (dB)	Measured 1g SAR (W/kg)	Reported 1g SAR (W/kg)
	WCDMA Band V	RMC12.2Kbps	Front	10	4182	836.4	23.62	24.00	1.091	0.05	0.491	0.536
	WCDMA Band V	RMC12.2Kbps	Back	10	4182	836.4	23.62	24.00	1.091	0.15	0.509	0.556
	WCDMA Band V	RMC12.2Kbps	Back	10	4132	826.4	23.59	24.00	1.099	-0.16	0.440	0.484
#14	WCDMA Band V	RMC12.2Kbps	Back	10	4233	846.6	23.54	24.00	1.112	-0.01	0.502	0.558
	WCDMA Band IV	RMC12.2Kbps	Front	10	1513	1752.6	23.25	23.50	1.059	-0.13	0.557	0.590
#25	WCDMA Band IV	RMC12.2Kbps	Back	10	1513	1752.6	23.25	23.50	1.059	0.03	0.725	0.768
	WCDMA Band IV	RMC12.2Kbps	Back	10	1312	1712.4	23.00	23.50	1.122	-0.05	0.659	0.739
	WCDMA Band IV	RMC12.2Kbps	Back	10	1413	1732.6	23.10	23.50	1.096	-0.06	0.700	0.768
	WCDMA Band II	RMC12.2Kbps	Front	10	9400	1880	22.77	23.00	1.054	0.04	0.663	0.699
	WCDMA Band II	RMC12.2Kbps	Back	10	9400	1880	22.77	23.00	1.054	0.02	0.869	0.916
	WCDMA Band II	RMC12.2Kbps	Back	10	9262	1852.4	22.67	23.00	1.079	-0.08	0.872	0.941
#26	WCDMA Band II	RMC12.2Kbps	Back	10	9538	1907.6	22.65	23.00	1.084	-0.02	0.914	0.991



<LTE SAR>

Plot No.	Band	BW (MHz)	RB Size	RB offset	Modulation	Test Position	Gap (mm)	Ch.	Freq. (MHz)	Average Power (dBm)	Tune-Up Limit (dBm)	Tune-up Scaling Factor	Power Drift (dB)	Measured 1g SAR (W/kg)	Reported 1g SAR (W/kg)
	LTE Band 12	10M	1	49	QPSK	Front	10	23095	707.5	22.68	23.50	1.208	-0.05	0.342	0.413
#17	LTE Band 12	10M	1	49	QPSK	Back	10	23095	707.5	22.68	23.50	1.208	-0.03	0.368	0.444
	LTE Band 12	10M	25	0	QPSK	Front	10	23095	707.5	21.83	22.50	1.167	-0.06	0.257	0.300
	LTE Band 12	10M	25	0	QPSK	Back	10	23095	707.5	21.83	22.50	1.167	-0.1	0.294	0.343
	LTE Band 5	10M	1	0	QPSK	Front	10	20525	836.5	22.81	23.50	1.172	-0.07	0.566	0.663
#18	LTE Band 5	10M	1	0	QPSK	Back	10	20525	836.5	22.81	23.50	1.172	-0.01	0.607	0.712
	LTE Band 5	10M	25	25	QPSK	Front	10	20525	836.5	21.77	22.50	1.183	0.03	0.498	0.589
	LTE Band 5	10M	25	25	QPSK	Back	10	20525	836.5	21.77	22.50	1.183	-0.05	0.505	0.597
	LTE Band 4	20M	1	49	QPSK	Front	10	20175	1732.5	23.01	24.00	1.256	0.01	0.438	0.550
#27	LTE Band 4	20M	1	49	QPSK	Back	10	20175	1732.5	23.01	24.00	1.256	0.06	0.545	0.685
	LTE Band 4	20M	50	0	QPSK	Front	10	20175	1732.5	21.98	23.00	1.265	0.07	0.426	0.539
	LTE Band 4	20M	50	0	QPSK	Back	10	20175	1732.5	21.98	23.00	1.265	0.04	0.509	0.644
	LTE Band 4	20M	100	0	QPSK	Front	10	20175	1732.5	21.96	23.00	1.271	0.09	0.525	0.667
	LTE Band 2	20M	1	49	QPSK	Front	10	18700	1860	23.06	23.50	1.107	-0.01	0.486	0.538
	LTE Band 2	20M	1	49	QPSK	Back	10	18700	1860	23.06	23.50	1.107	-0.09	0.639	0.707
	LTE Band 2	20M	1	49	QPSK	Back	10	18900	1880	23.03	23.50	1.114	-0.03	0.678	0.755
#28	LTE Band 2	20M	1	49	QPSK	Back	10	19100	1900	22.98	23.50	1.127	0.08	0.781	0.880
	LTE Band 2	20M	50	0	QPSK	Front	10	18700	1860	22.02	22.50	1.117	-0.08	0.393	0.439
	LTE Band 2	20M	50	0	QPSK	Back	10	18700	1860	22.02	22.50	1.117	0.12	0.509	0.568
	LTE Band 2	20M	100	0	QPSK	Back	10	18700	1860	21.90	22.50	1.148	-0.09	0.523	0.600
	LTE Band 7	20M	1	49	QPSK	Front	10	21100	2535	22.81	23.50	1.172	-0.04	0.182	0.213
#29	LTE Band 7	20M	1	49	QPSK	Back	10	21100	2535	22.81	23.50	1.172	-0.05	0.273	0.320
	LTE Band 7	20M	1	49	QPSK	Back	10	20850	2510	22.29	23.50	1.321	-0.04	0.241	0.318
	LTE Band 7	20M	1	49	QPSK	Back	10	21350	2560	22.78	23.50	1.180	-0.08	0.271	0.320
	LTE Band 7	20M	50	0	QPSK	Front	10	21100	2535	21.64	22.50	1.219	-0.05	0.139	0.169
	LTE Band 7	20M	50	0	QPSK	Back	10	21100	2535	21.64	22.50	1.219	-0.03	0.210	0.256

<WLAN SAR>

Plot No.	Band	Mode	Test Position	Gap (mm)	Ch.	Freq. (MHz)	Average Power (dBm)	Tune-Up Limit (dBm)	Tune-up Scaling Factor	Duty Cycle %	Duty Cycle Scaling Factor	Power Drift (dB)	Measured 1g SAR (W/kg)	Reported 1g SAR (W/kg)
	WLAN 2.4GHz	802.11b 1Mbps	Front	10	6	2437	15.48	16.00	1.128	97.36	1.027	-0.01	0.061	0.071
	WLAN 2.4GHz	802.11b 1Mbps	Back	10	6	2437	15.48	16.00	1.128	97.36	1.027	-0.16	0.056	0.065
	WLAN 2.4GHz	802.11b 1Mbps	Front	10	1	2412	13.94	14.50	1.139	97.36	1.027	-0.05	0.047	0.055
#30	WLAN 2.4GHz	802.11b 1Mbps	Front	10	11	2462	14.35	15.00	1.163	97.36	1.027	0.05	0.060	0.072

<Bluetooth SAR>

Plot No.	Band	Mode	Test Position	Gap (mm)	Ch.	Freq. (MHz)	Average Power (dBm)	Tune-Up Limit (dBm)	Tune-up Scaling Factor	Power Drift (dB)	Measured 1g SAR (W/kg)	Reported 1g SAR (W/kg)
	Bluetooth	1Mbps	Front	10	39	2441	11.04	11.50	1.113	-0.01	0.00889	0.010
	Bluetooth	1Mbps	Back	10	39	2441	11.04	11.50	1.113	0.04	0.011	0.012
#31	Bluetooth	1Mbps	Back	10	0	2402	9.80	10.50	1.176	0.05	0.012	0.014
	Bluetooth	1Mbps	Back	10	78	2480	8.34	9.00	1.165	0.02	0.00882	0.010

14.4 Repeated SAR Measurement

No.	Band	Mode	Test Position	Gap (cm)	Ch.	Freq. (MHz)	Average Power (dBm)	Tune-Up Limit (dBm)	Tune-up Scaling Factor	Power Drift (dB)	Measured 1g SAR (W/kg)	Ratio	Reported 1g SAR (W/kg)
1st	GSM850	GPRS(4 Tx slots)	Back	10	251	848.8	31.77	32.50	1.183	0.1	0.851	1	1.007
2nd	GSM850	GPRS(4 Tx slots)	Back	10	251	848.8	31.77	32.50	1.183	-0.04	0.780	1.091	0.923
1st	WCDMA Band IV	RMC12.2Kbps	Bottom Side	10	1513	1752.6	23.25	23.50	1.059	-0.03	0.911	1	0.965
2nd	WCDMA Band IV	RMC12.2Kbps	Bottom Side	10	1513	1752.6	23.25	23.50	1.059	0.05	0.899	1.014	0.952
1st	WCDMA Band II	RMC12.2Kbps	Bottom Side	10	9538	1907.6	22.65	23.00	1.084	0.07	1.400	1	1.517
2nd	WCDMA Band II	RMC12.2Kbps	Bottom Side	10	9538	1907.6	22.65	23.00	1.084	0.01	1.380	1.014	1.496

General Note:

1. Per KDB 865664 D01v01r04, for each frequency band, repeated SAR measurement is required only when the measured SAR is ≥ 0.8 W/kg.
2. Per KDB 865664 D01v01r04, if the ratio among the repeated measurement is ≤ 1.2 and the measured SAR < 1.45 W/kg, only one repeated measurement is required.
3. The ratio is the difference in percentage between original and repeated *measured SAR*.
4. All measurement SAR result is scaled-up to account for tune-up tolerance and is compliant.

15. Simultaneous Transmission Analysis

NO.	Simultaneous Transmission Configurations	Portable Handset			Note
		Head	Body-worn	Hotspot	
1.	GSM Voice + WLAN2.4GHz	Yes	Yes		
2.	GPRS/EDGE + WLAN2.4GHz	Yes	Yes	Yes	Hotspot
3.	WCDMA + WLAN2.4GHz	Yes	Yes	Yes	Hotspot
4.	LTE + WLAN2.4GHz	Yes	Yes	Yes	Hotspot
5.	GSM Voice + Bluetooth	Yes	Yes		
6.	GPRS/EDGE + Bluetooth	Yes	Yes		WWAN VoIP
7.	WCDMA+ Bluetooth	Yes	Yes		WWAN VoIP
8.	LTE + Bluetooth	Yes	Yes		WWAN VoIP

General Note:

1. This device supported VoIP in GPRS, EGPRS, WCDMA and LTE (e.g. 3rd party VoIP).
2. This device 2.4GHz WLAN supports Hotspot operation.
3. WLAN and Bluetooth share the same antenna, and cannot transmit simultaneously.
4. EUT will choose each GSM, WCDMA and LTE according to the network signal condition; therefore, they will not operate simultaneously at any moment.
5. The Scaled SAR summation is calculated based on the same configuration and test position.
6. Per KDB 447498 D01v06, simultaneous transmission SAR is compliant if,
 - i) Scalar SAR summation < 1.6W/kg.
 - ii) $SPLSR = (SAR_1 + SAR_2)^{1.5} / (min. \text{ separation distance, mm})$, and the peak separation distance is determined from the square root of $[(x_1-x_2)^2 + (y_1-y_2)^2 + (z_1-z_2)^2]$, where (x_1, y_1, z_1) and (x_2, y_2, z_2) are the coordinates of the extrapolated peak SAR locations in the zoom scan.
 - iii) If $SPLSR \leq 0.04$, simultaneously transmission SAR measurement is not necessary.
 - iv) Simultaneously transmission SAR measurement, and the reported multi-band SAR < 1.6W/kg.



15.1 Head Exposure Conditions

<WWAN + WLAN 2.4GHz >

WWAN Band		Exposure Position	WWAN	WLAN	Summed SAR (W/kg)	SPLSR	Case No
			Max. WWAN SAR (W/kg)	Max. WLAN SAR (W/kg)			
GSM	GSM850	Right Cheek	0.272	0.132	0.40		
		Right Tilted	0.194	0.175	0.37		
		Left Cheek	0.452	0.495	0.95		
		Left Tilted	0.206	0.291	0.50		
	GSM1900	Right Cheek	0.207	0.132	0.34		
		Right Tilted	0.040	0.175	0.22		
		Left Cheek	0.112	0.495	0.61		
		Left Tilted	0.105	0.291	0.40		
WCDMA	Band V	Right Cheek	0.129	0.132	0.26		
		Right Tilted	0.085	0.175	0.26		
		Left Cheek	0.189	0.495	0.68		
		Left Tilted	0.095	0.291	0.39		
	Band IV	Right Cheek	0.242	0.132	0.37		
		Right Tilted	0.055	0.175	0.23		
		Left Cheek	0.115	0.495	0.61		
		Left Tilted	0.079	0.291	0.37		
	Band II	Right Cheek	0.318	0.132	0.45		
		Right Tilted	0.058	0.175	0.23		
		Left Cheek	0.143	0.495	0.64		
		Left Tilted	0.134	0.291	0.43		
LTE	Band 12	Right Cheek	0.187	0.132	0.32		
		Right Tilted	0.130	0.175	0.31		
		Left Cheek	0.199	0.495	0.69		
		Left Tilted	0.120	0.291	0.41		
	Band 5	Right Cheek	0.202	0.132	0.33		
		Right Tilted	0.148	0.175	0.32		
		Left Cheek	0.309	0.495	0.80		
		Left Tilted	0.150	0.291	0.44		
	Band 4	Right Cheek	0.323	0.132	0.46		
		Right Tilted	0.035	0.175	0.21		
		Left Cheek	0.111	0.495	0.61		
		Left Tilted	0.089	0.291	0.38		
	Band 2	Right Cheek	0.195	0.132	0.33		
		Right Tilted	0.035	0.175	0.21		
		Left Cheek	0.106	0.495	0.60		
		Left Tilted	0.082	0.291	0.37		
	Band 7	Right Cheek	0.055	0.132	0.19		
		Right Tilted	0.016	0.175	0.19		
		Left Cheek	0.046	0.495	0.54		
		Left Tilted	0.023	0.291	0.31		



<WWAN + Bluetooth >

WWAN Band		Exposure Position	WWAN	Bluetooth	Summed SAR (W/kg)	SPLSR	Case No
			Max. WWAN SAR (W/kg)	Bluetooth SAR (W/kg)			
GSM	GSM850	Right Cheek	0.272	0.023	0.30		
		Right Tilted	0.194	0.030	0.22		
		Left Cheek	0.452	0.073	0.53		
		Left Tilted	0.206	0.047	0.25		
	GSM1900	Right Cheek	0.207	0.023	0.23		
		Right Tilted	0.040	0.030	0.07		
		Left Cheek	0.112	0.073	0.19		
		Left Tilted	0.105	0.047	0.15		
WCDMA	Band V	Right Cheek	0.129	0.023	0.15		
		Right Tilted	0.085	0.030	0.12		
		Left Cheek	0.189	0.073	0.26		
		Left Tilted	0.095	0.047	0.14		
	Band IV	Right Cheek	0.242	0.023	0.27		
		Right Tilted	0.055	0.030	0.09		
		Left Cheek	0.115	0.073	0.19		
		Left Tilted	0.079	0.047	0.13		
	Band II	Right Cheek	0.318	0.023	0.34		
		Right Tilted	0.058	0.030	0.09		
		Left Cheek	0.143	0.073	0.22		
		Left Tilted	0.134	0.047	0.18		
LTE	Band 12	Right Cheek	0.187	0.023	0.21		
		Right Tilted	0.130	0.030	0.16		
		Left Cheek	0.199	0.073	0.27		
		Left Tilted	0.120	0.047	0.17		
	Band 5	Right Cheek	0.202	0.023	0.23		
		Right Tilted	0.148	0.030	0.18		
		Left Cheek	0.309	0.073	0.38		
		Left Tilted	0.150	0.047	0.20		
	Band 4	Right Cheek	0.323	0.023	0.35		
		Right Tilted	0.035	0.030	0.07		
		Left Cheek	0.111	0.073	0.18		
		Left Tilted	0.089	0.047	0.14		
	Band 2	Right Cheek	0.195	0.023	0.22		
		Right Tilted	0.035	0.030	0.07		
		Left Cheek	0.106	0.073	0.18		
		Left Tilted	0.082	0.047	0.13		
	Band 7	Right Cheek	0.055	0.023	0.08		
		Right Tilted	0.016	0.030	0.05		
		Left Cheek	0.046	0.073	0.12		
		Left Tilted	0.023	0.047	0.07		



15.2 Hotspot Exposure Conditions

<WWAN + WLAN 2.4GHz>

WWAN Band		Exposure Position	WWAN	WLAN	Summed SAR (W/kg)	SPLSR	Case No
			Max. WWAN SAR (W/kg)	Max. WLAN SAR (W/kg)			
GSM	GSM850	Front	0.993	0.072	1.07		
		Back	1.007	0.065	1.07		
		Left side	0.724		0.72		
		Right side	0.169	0.061	0.23		
		Top side		0.191	0.19		
		Bottom side	0.718		0.72		
	GSM1900	Front	0.400	0.072	0.47		
		Back	0.706	0.065	0.77		
		Left side	0.116		0.12		
		Right side	0.163	0.061	0.22		
		Top side		0.191	0.19		
		Bottom side	1.012		1.01		
WCDMA	Band V	Front	0.536	0.072	0.61		
		Back	0.558	0.065	0.62		
		Left side	0.383		0.38		
		Right side	0.118	0.061	0.18		
		Top side		0.191	0.19		
		Bottom side	0.371		0.37		
	Band IV	Front	0.590	0.072	0.66		
		Back	0.768	0.065	0.83		
		Left side	0.083		0.08		
		Right side	0.202	0.061	0.26		
		Top side		0.191	0.19		
		Bottom side	0.965		0.97		
	Band II	Front	0.699	0.072	0.77		
		Back	0.991	0.065	1.06		
		Left side	0.148		0.15		
		Right side	0.244	0.061	0.31		
		Top side		0.191	0.19		
		Bottom side	1.517		1.52		



WWAN Band	Exposure Position	WWAN	WLAN	Summed SAR (W/kg)	SPLSR	Case No
		Max. WWAN SAR (W/kg)	Max. WLAN SAR (W/kg)			
LTE	Band 12	Front	0.413	0.072	0.49	
		Back	0.444	0.065	0.51	
		Left side	0.184		0.18	
		Right side	0.205	0.061	0.27	
		Top side		0.191	0.19	
		Bottom side	0.172		0.17	
	Band 5	Front	0.663	0.072	0.74	
		Back	0.712	0.065	0.78	
		Left side	0.489		0.49	
		Right side	0.137	0.061	0.20	
		Top side		0.191	0.19	
		Bottom side	0.478		0.48	
	Band 4	Front	0.667	0.072	0.74	
		Back	0.685	0.065	0.75	
		Left side	0.098		0.10	
		Right side	0.195	0.061	0.26	
		Top side		0.191	0.19	
		Bottom side	0.896		0.90	
	Band 2	Front	0.538	0.072	0.61	
		Back	0.880	0.065	0.95	
		Left side	0.077		0.08	
		Right side	0.206	0.061	0.27	
		Top side		0.191	0.19	
		Bottom side	1.293		1.29	
	Band 7	Front	0.213	0.072	0.29	
		Back	0.320	0.065	0.39	
		Left side	0.040		0.04	
		Right side	0.115	0.061	0.18	
		Top side		0.191	0.19	
		Bottom side	0.652		0.65	



15.3 Body-Worn Accessory Exposure Conditions

<WWAN + WLAN 2.4GHz>

WWAN Band		Exposure Position	WWAN	WLAN	Summed SAR (W/kg)	SPLSR	Case No
			Max. WWAN SAR (W/kg)	Max. WLAN SAR (W/kg)			
GSM	GSM850	Front	0.993	0.072	1.07		
		Back	1.007	0.065	1.07		
	GSM1900	Front	0.400	0.072	0.47		
		Back	0.706	0.065	0.77		
WCDMA	Band V	Front	0.536	0.072	0.61		
		Back	0.558	0.065	0.62		
	Band IV	Front	0.590	0.072	0.66		
		Back	0.768	0.065	0.83		
	Band II	Front	0.699	0.072	0.77		
		Back	0.991	0.065	1.06		
LTE	Band 12	Front	0.413	0.072	0.49		
		Back	0.444	0.065	0.51		
	Band 5	Front	0.663	0.072	0.74		
		Back	0.712	0.065	0.78		
	Band 4	Front	0.667	0.072	0.74		
		Back	0.685	0.065	0.75		
	Band 2	Front	0.538	0.072	0.61		
		Back	0.880	0.065	0.95		
	Band 7	Front	0.213	0.072	0.29		
		Back	0.320	0.065	0.39		



<WWAN + Bluetooth>

WWAN Band		Exposure Position	WWAN	Bluetooth	Summed SAR (W/kg)	SPLSR	Case No
			Max. WWAN SAR (W/kg)	Bluetooth SAR (W/kg)			
GSM	GSM850	Front	0.993	0.010	1.00		
		Back	1.007	0.014	1.02		
	GSM1900	Front	0.400	0.010	0.41		
		Back	0.706	0.014	0.72		
WCDMA	Band V	Front	0.536	0.010	0.55		
		Back	0.558	0.014	0.57		
	Band IV	Front	0.590	0.010	0.60		
		Back	0.768	0.014	0.78		
	Band II	Front	0.699	0.010	0.71		
		Back	0.991	0.014	1.01		
LTE	Band 12	Front	0.413	0.010	0.42		
		Back	0.444	0.014	0.46		
	Band 5	Front	0.663	0.010	0.67		
		Back	0.712	0.014	0.73		
	Band 4	Front	0.667	0.010	0.68		
		Back	0.685	0.014	0.70		
	Band 2	Front	0.538	0.010	0.55		
		Back	0.880	0.014	0.89		
	Band 7	Front	0.213	0.010	0.22		
		Back	0.320	0.014	0.33		

Test Engineer : Luke Lu

16. Uncertainty Assessment

The component of uncertainty may generally be categorized according to the methods used to evaluate them. The evaluation of uncertainty by the statistical analysis of a series of observations is termed a Type A evaluation of uncertainty. The evaluation of uncertainty by means other than the statistical analysis of a series of observation is termed a Type B evaluation of uncertainty. Each component of uncertainty, however evaluated, is represented by an estimated standard deviation, termed standard uncertainty, which is determined by the positive square root of the estimated variance.

A Type A evaluation of standard uncertainty may be based on any valid statistical method for treating data. This includes calculating the standard deviation of the mean of a series of independent observations; using the method of least squares to fit a curve to the data in order to estimate the parameter of the curve and their standard deviations; or carrying out an analysis of variance in order to identify and quantify random effects in certain kinds of measurement.

A type B evaluation of standard uncertainty is typically based on scientific judgment using all of the relevant information available. These may include previous measurement data, experience, and knowledge of the behavior and properties of relevant materials and instruments, manufacture’s specification, data provided in calibration reports and uncertainties assigned to reference data taken from handbooks. Broadly speaking, the uncertainty is either obtained from an outdoor source or obtained from an assumed distribution, such as the normal distribution, rectangular or triangular distributions indicated in table below.

Uncertainty Distributions	Normal	Rectangular	Triangular	U-Shape
Multi-plying Factor ^(a)	1/k ^(b)	1/√3	1/√6	1/√2

(a) standard uncertainty is determined as the product of the multiplying factor and the estimated range of variations in the measured quantity

(b) κ is the coverage factor

Table 16.1. Standard Uncertainty for Assumed Distribution

The combined standard uncertainty of the measurement result represents the estimated standard deviation of the result. It is obtained by combining the individual standard uncertainties of both Type A and Type B evaluation using the usual “root-sum-squares” (RSS) methods of combining standard deviations by taking the positive square root of the estimated variances.

Expanded uncertainty is a measure of uncertainty that defines an interval about the measurement result within which the measured value is confidently believed to lie. It is obtained by multiplying the combined standard uncertainty by a coverage factor. Typically, the coverage factor ranges from 2 to 3. Using a coverage factor allows the true value of a measured quantity to be specified with a defined probability within the specified uncertainty range. For purpose of this document, a coverage factor two is used, which corresponds to confidence interval of about 95 %. The DASY uncertainty Budget is shown in the following tables.

Error Description	Uncertainty Value (±%)	Probability	Divisor	(Ci) 1g	(Ci) 10g	Standard Uncertainty (1g) (±%)	Standard Uncertainty (10g) (±%)
Measurement System							
Probe Calibration	6.0	N	1	1	1	6.0	6.0
Axial Isotropy	4.7	R	1.732	0.7	0.7	1.9	1.9
Hemispherical Isotropy	9.6	R	1.732	0.7	0.7	3.9	3.9
Boundary Effects	1.0	R	1.732	1	1	0.6	0.6
Linearity	4.7	R	1.732	1	1	2.7	2.7
System Detection Limits	1.0	R	1.732	1	1	0.6	0.6
Modulation Response	3.2	R	1.732	1	1	1.8	1.8
Readout Electronics	0.3	N	1	1	1	0.3	0.3
Response Time	0.0	R	1.732	1	1	0.0	0.0
Integration Time	2.6	R	1.732	1	1	1.5	1.5
RF Ambient Noise	3.0	R	1.732	1	1	1.7	1.7
RF Ambient Reflections	3.0	R	1.732	1	1	1.7	1.7
Probe Positioner	0.4	R	1.732	1	1	0.2	0.2
Probe Positioning	2.9	R	1.732	1	1	1.7	1.7
Max. SAR Eval.	2.0	R	1.732	1	1	1.2	1.2
Test Sample Related							
Device Positioning	3.0	N	1	1	1	3.0	3.0
Device Holder	3.6	N	1	1	1	3.6	3.6
Power Drift	5.0	R	1.732	1	1	2.9	2.9
Power Scaling	0.0	R	1.732	1	1	0.0	0.0
Phantom and Setup							
Phantom Uncertainty	6.1	R	1.732	1	1	3.5	3.5
SAR correction	0.0	R	1.732	1	0.84	0.0	0.0
Liquid Conductivity Repeatability	0.2	N	1	0.78	0.71	0.1	0.1
Liquid Conductivity (target)	5.0	R	1.732	0.78	0.71	2.3	2.0
Liquid Conductivity (mea.)	2.5	R	1.732	0.78	0.71	1.1	1.0
Temp. unc. - Conductivity	3.4	R	1.732	0.78	0.71	1.5	1.4
Liquid Permittivity Repeatability	0.15	N	1	0.23	0.26	0.0	0.0
Liquid Permittivity (target)	5.0	R	1.732	0.23	0.26	0.7	0.8
Liquid Permittivity (mea.)	2.5	R	1.732	0.23	0.26	0.3	0.4
Temp. unc. - Permittivity	0.83	R	1.732	0.23	0.26	0.1	0.1
Combined Std. Uncertainty						11.4%	11.4%
Coverage Factor for 95 %						K=2	K=2
Expanded STD Uncertainty						22.9%	22.7%

Table 16.2. Uncertainty Budget for frequency range 300 MHz to 3 GHz



17. References

- [1] FCC 47 CFR Part 2 “Frequency Allocations and Radio Treaty Matters; General Rules and Regulations”
- [2] ANSI/IEEE Std. C95.1-1992, “IEEE Standard for Safety Levels with Respect to Human Exposure to Radio Frequency Electromagnetic Fields, 3 kHz to 300 GHz”, September 1992
- [3] IEEE Std. 1528-2013, “IEEE Recommended Practice for Determining the Peak Spatial-Average Specific Absorption Rate (SAR) in the Human Head from Wireless Communications Devices: Measurement Techniques”, Sep 2013
- [4] SPEAG DASY System Handbook
- [5] FCC KDB 248227 D01 v02r02, “SAR Guidance for IEEE 802.11 (WiFi) Transmitters”, Oct 2015.
- [6] FCC KDB 447498 D01 v06, “Mobile and Portable Device RF Exposure Procedures and Equipment Authorization Policies”, Oct 2015
- [7] FCC KDB 648474 D04 v01r03, “SAR Evaluation Considerations for Wireless Handsets”, Oct 2015.
- [8] FCC KDB 941225 D01 v03r01, “3G SAR MEAUREMENT PROCEDURES”, Oct 2015
- [9] FCC KDB 941225 D05 v02r04, “SAR Evaluation Considerations for LTE Devices”, Oct 2015
- [10] FCC KDB 941225 D06 v02r01, "SAR Evaluation Procedures for Portable Devices with Wireless Router Capabilities", Oct 2015.
- [11] FCC KDB 865664 D01 v01r04, "SAR Measurement Requirements for 100 MHz to 6 GHz", Aug 2015.
- [12] FCC KDB 865664 D02 v01r02, “RF Exposure Compliance Reporting and Documentation Considerations” Oct 2015.



Appendix A. Plots of System Performance Check

The plots are shown as follows.

System Check_Head_750MHz_151005

DUT: D750V3-SN:1065

Communication System: UID 0, CW; Frequency: 750 MHz;Duty Cycle: 1:1
Medium: HSL_750_151005 Medium parameters used: $f = 750$ MHz; $\sigma = 0.89$ S/m; $\epsilon_r = 40.918$; $\rho = 1000$ kg/m³

Ambient Temperature: 23.3 °C ; Liquid Temperature: 22.8 °C

DASY5 Configuration:

- Probe: EX3DV4 - SN3958; ConvF(10.33, 10.33, 10.33); Calibrated: 2015.07.23;
- Sensor-Surface: 2mm (Mechanical Surface Detection)
- Electronics: DAE4 Sn1386; Calibrated: 2015.02.19
- Phantom: SAM1; Type: QD000P40CD; Serial: TP:1670
- Measurement SW: DASY52, Version 52.8 (8);SEMCAD X Version 14.6.10 (7331)

Pin=250mW/Area Scan (61x61x1): Interpolated grid: dx=15mm, dy=15mm

Maximum value of SAR (interpolated) = 2.36 W/kg

Pin=250mW/Zoom Scan (5x5x7)/Cube 0: Measurement grid: dx=8mm, dy=8mm, dz=5mm

Reference Value = 52.51 V/m; Power Drift = -0.01 dB

Peak SAR (extrapolated) = 2.76 W/kg

SAR(1 g) = 1.89 W/kg; SAR(10 g) = 1.26 W/kg

Maximum value of SAR (measured) = 2.36 W/kg

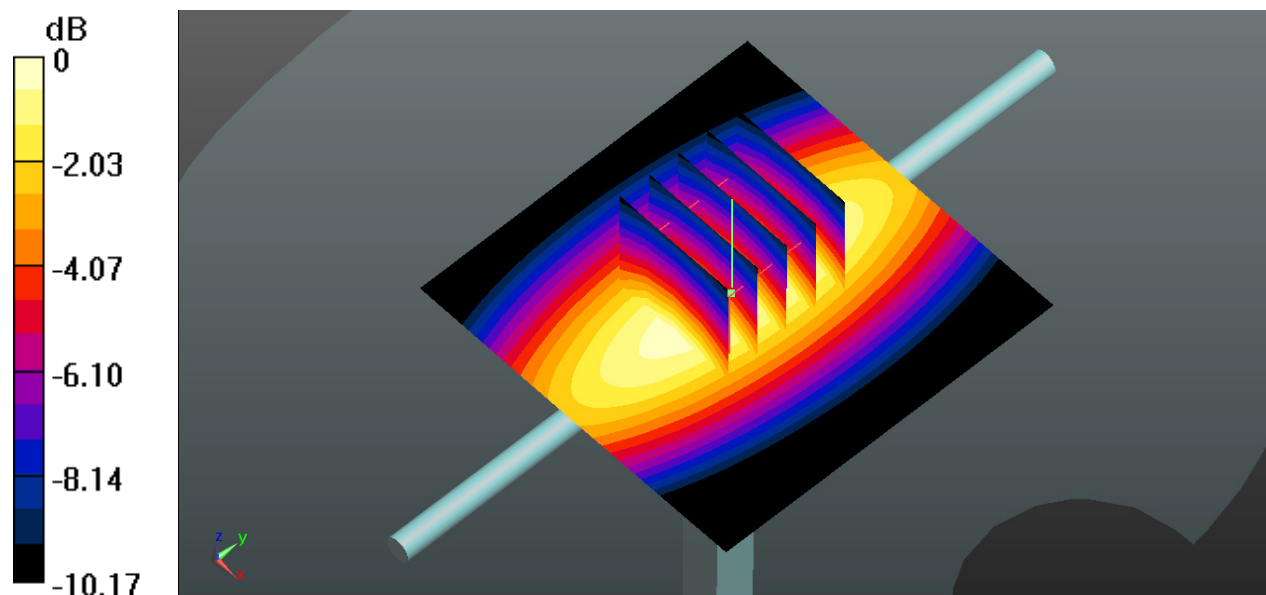

0 dB = 2.36 W/kg

System Check_Head_835MHz_151005

DUT: D835V2-SN:4d091

Communication System: UID 0, CW; Frequency: 835 MHz;Duty Cycle: 1:1
Medium: HSL_835_151005 Medium parameters used: $f = 835$ MHz; $\sigma = 0.91$ S/m; $\epsilon_r = 42.91$; $\rho = 1000$ kg/m³

Ambient Temperature: 23.3 °C ; **Liquid Temperature:** 22.6 °C

DASY5 Configuration:

- Probe: EX3DV4 - SN3958; ConvF(9.96, 9.96, 9.96); Calibrated: 2015.07.23;
- Sensor-Surface: 2mm (Mechanical Surface Detection)
- Electronics: DAE4 Sn1386; Calibrated: 2015.02.19
- Phantom: SAM1; Type: QD000P40CD; Serial: TP:1670
- Measurement SW: DASY52, Version 52.8 (8);SEMCAD X Version 14.6.10 (7331)

Pin=250mW/Area Scan (61x61x1): Interpolated grid: dx=15mm, dy=15mm

Maximum value of SAR (interpolated) = 2.97 W/kg

Pin=250mW/Zoom Scan (5x5x7)/Cube 0: Measurement grid: dx=8mm, dy=8mm, dz=5mm

Reference Value = 57.11 V/m; Power Drift = 0.09 dB

Peak SAR (extrapolated) = 3.45 W/kg

SAR(1 g) = 2.36 W/kg; SAR(10 g) = 1.55 W/kg

Maximum value of SAR (measured) = 3.01 W/kg

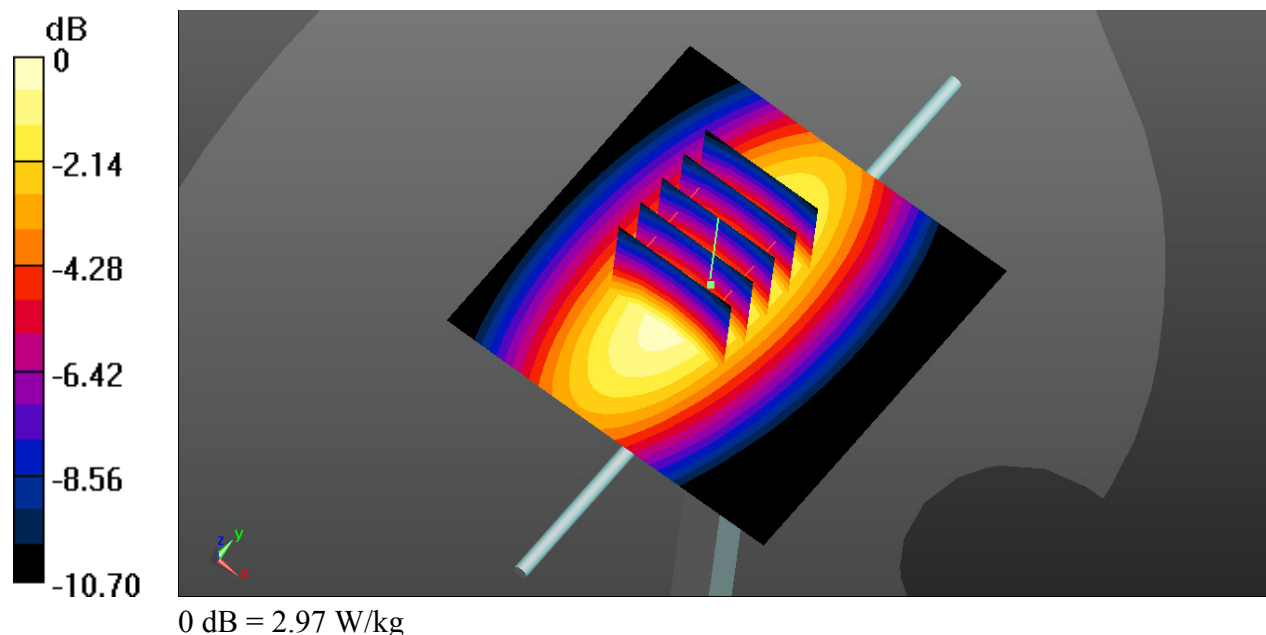

System Check_Head_1750MHz_151007

DUT: D1750V2-SN:1069

Communication System: UID 0, CW; Frequency: 1750 MHz; Duty Cycle: 1:1
Medium: HSL_1800_151007 Medium parameters used: $f = 1750$ MHz; $\sigma = 1.392$ S/m; $\epsilon_r = 40.573$;
 $\rho = 1000$ kg/m³

Ambient Temperature: 23.2 °C ; Liquid Temperature: 22.8 °C

DASY5 Configuration:

- Probe: EX3DV4 - SN3958; ConvF(8.52, 8.52, 8.52); Calibrated: 2015.07.23;
- Sensor-Surface: 2mm (Mechanical Surface Detection)
- Electronics: DAE4 Sn1386; Calibrated: 2015.02.19
- Phantom: SAM1; Type: QD000P40CD; Serial: TP:1670
- Measurement SW: DASY52, Version 52.8 (8); SEMCAD X Version 14.6.10 (7331)

Pin=250mW/Area Scan (61x61x1): Interpolated grid: dx=15mm, dy=15mm

Maximum value of SAR (interpolated) = 13.4 W/kg

Pin=250mW/Zoom Scan (5x5x7)/Cube 0: Measurement grid: dx=8mm, dy=8mm, dz=5mm

Reference Value = 98.66 V/m; Power Drift = -0.02 dB

Peak SAR (extrapolated) = 16.7 W/kg

SAR(1 g) = 9.54 W/kg; SAR(10 g) = 5.16 W/kg

Maximum value of SAR (measured) = 13.4 W/kg

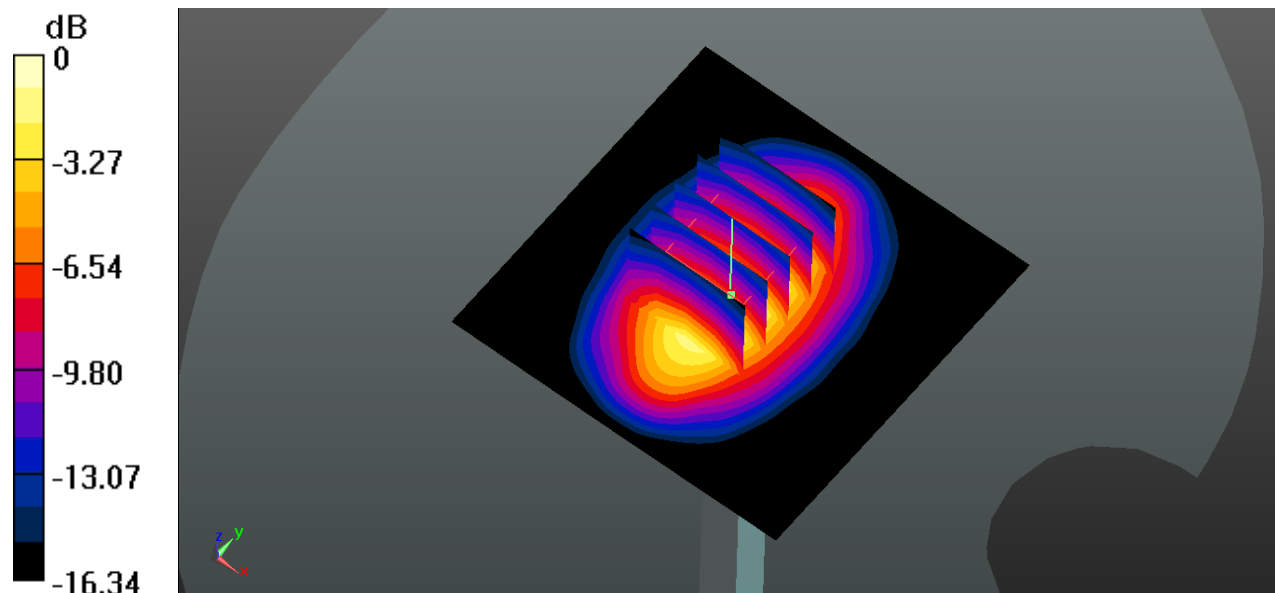

0 dB = 13.4 W/kg

System Check_Head_1900MHz_151007

DUT: D1900V2-SN:5d118

Communication System: UID 0, CW; Frequency: 1900 MHz;Duty Cycle: 1:1
Medium: HSL_1900_151007 Medium parameters used: $f = 1900$ MHz; $\sigma = 1.452$ S/m; $\epsilon_r = 39.039$;
 $\rho = 1000$ kg/m³

Ambient Temperature: 23.2 °C ; Liquid Temperature: 22.7 °C

DASY5 Configuration:

- Probe: EX3DV4 - SN3958; ConvF(8.22, 8.22, 8.22); Calibrated: 2015.07.23;
- Sensor-Surface: 2mm (Mechanical Surface Detection)
- Electronics: DAE4 Sn1386; Calibrated: 2015.02.19
- Phantom: SAM1; Type: QD000P40CD; Serial: TP:1670
- Measurement SW: DASY52, Version 52.8 (8);SEMCAD X Version 14.6.10 (7331)

Pin=250mW/Area Scan (61x61x1): Interpolated grid: dx=15mm, dy=15mm

Maximum value of SAR (interpolated) = 15.3 W/kg

Pin=250mW/Zoom Scan (5x5x7)/Cube 0: Measurement grid: dx=8mm, dy=8mm, dz=5mm

Reference Value = 101.6 V/m; Power Drift = 0.02 dB

Peak SAR (extrapolated) = 19.1 W/kg

SAR(1 g) = 10.5 W/kg; SAR(10 g) = 5.48 W/kg

Maximum value of SAR (measured) = 14.8 W/kg

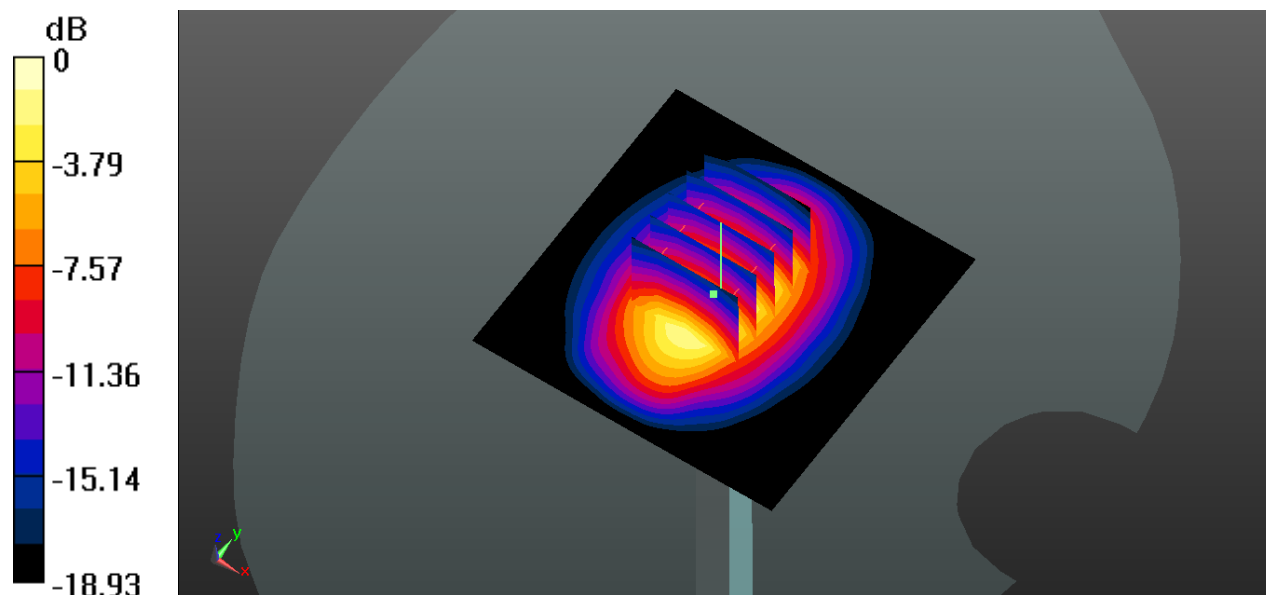

0 dB = 15.3 W/kg

System Check_Head_2450MHz_151009

DUT: D2450V2-SN:926

Communication System: UID 0, CW; Frequency: 2450 MHz;Duty Cycle: 1:1
Medium: HSL_2450_151009 Medium parameters used: $f = 2450$ MHz; $\sigma = 1.729$ S/m; $\epsilon_r = 37.305$;
 $\rho = 1000$ kg/m³

Ambient Temperature: 23.6 °C ; Liquid Temperature: 22.9 °C

DASY5 Configuration:

- Probe: EX3DV4 - SN3958; ConvF(7.58, 7.58, 7.58); Calibrated: 2015.07.23;
- Sensor-Surface: 2mm (Mechanical Surface Detection)
- Electronics: DAE4 Sn1386; Calibrated: 2015.02.19
- Phantom: SAM1; Type: QD000P40CD; Serial: TP:1670
- Measurement SW: DASY52, Version 52.8 (8);SEMCAD X Version 14.6.10 (7331)

Pin=250mW/Area Scan (81x81x1): Interpolated grid: dx=12mm, dy=12mm

Maximum value of SAR (interpolated) = 19.2 W/kg

Pin=250mW/Zoom Scan (7x7x7)/Cube 0: Measurement grid: dx=5mm, dy=5mm, dz=5mm

Reference Value = 92.02 V/m; Power Drift = -0.02 dB

Peak SAR (extrapolated) = 26.3 W/kg

SAR(1 g) = 12.8 W/kg; SAR(10 g) = 5.95 W/kg

Maximum value of SAR (measured) = 19.5 W/kg

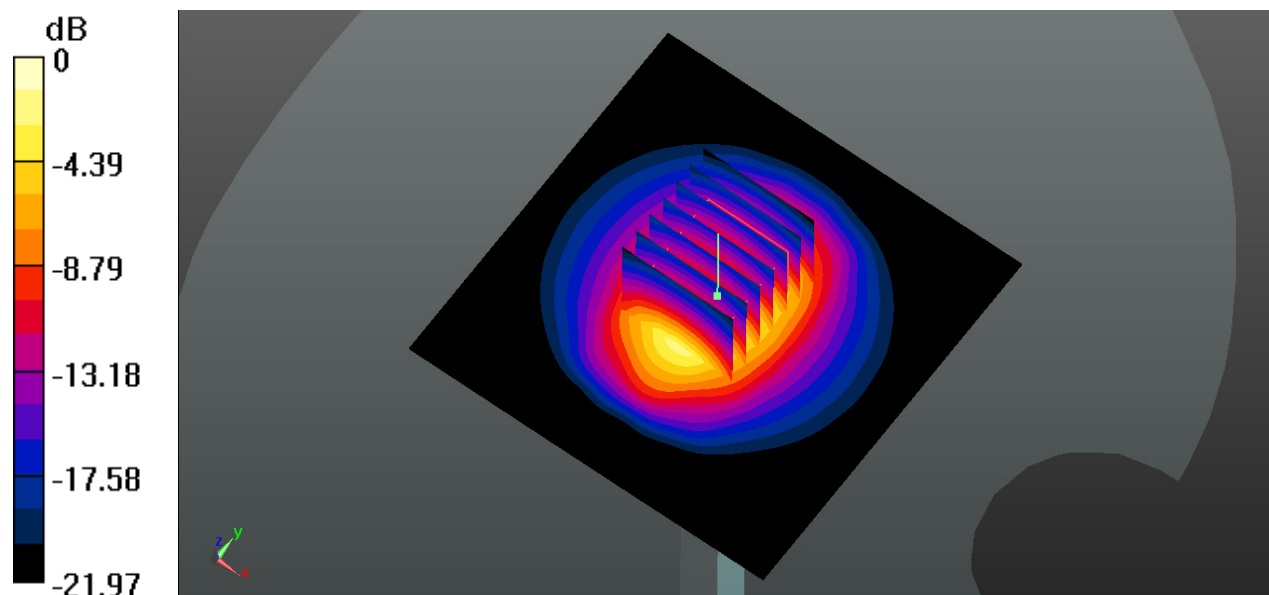

0 dB = 19.2 W/kg

System Check_Head_2450MHz_151028

DUT: Dipole 2450 MHz

Communication System: UID 0, CW; Frequency: 2450 MHz;Duty Cycle: 1:1
Medium: HSL_2450_151028 Medium parameters used: $f = 2450$ MHz; $\sigma = 1.752$ S/m; $\epsilon_r = 39.797$;
 $\rho = 1000$ kg/m³

Ambient Temperature: 23.2 °C ; **Liquid Temperature:** 22.9 °C

DASY5 Configuration:

- Probe: EX3DV4 - SN3958; ConvF(7.58, 7.58, 7.58); Calibrated: 2015.07.23;
- Sensor-Surface: 2mm (Mechanical Surface Detection)
- Electronics: DAE4 Sn1386; Calibrated: 2015.02.19
- Phantom: SAM1; Type: QD000P40CD; Serial: TP:1670
- Measurement SW: DASY52, Version 52.8 (8);SEMCAD X Version 14.6.10 (7331)

Pin=250mW/Area Scan (81x81x1): Interpolated grid: dx=12mm, dy=12mm

Maximum value of SAR (interpolated) = 19.5 W/kg

Pin=250mW/Zoom Scan (7x7x7)/Cube 0: Measurement grid: dx=5mm, dy=5mm, dz=5mm

Reference Value = 92.02 V/m; Power Drift = -0.02 dB

Peak SAR (extrapolated) = 26.6 W/kg

SAR(1 g) = 13 W/kg; SAR(10 g) = 6.03 W/kg

Maximum value of SAR (measured) = 19.8 W/kg

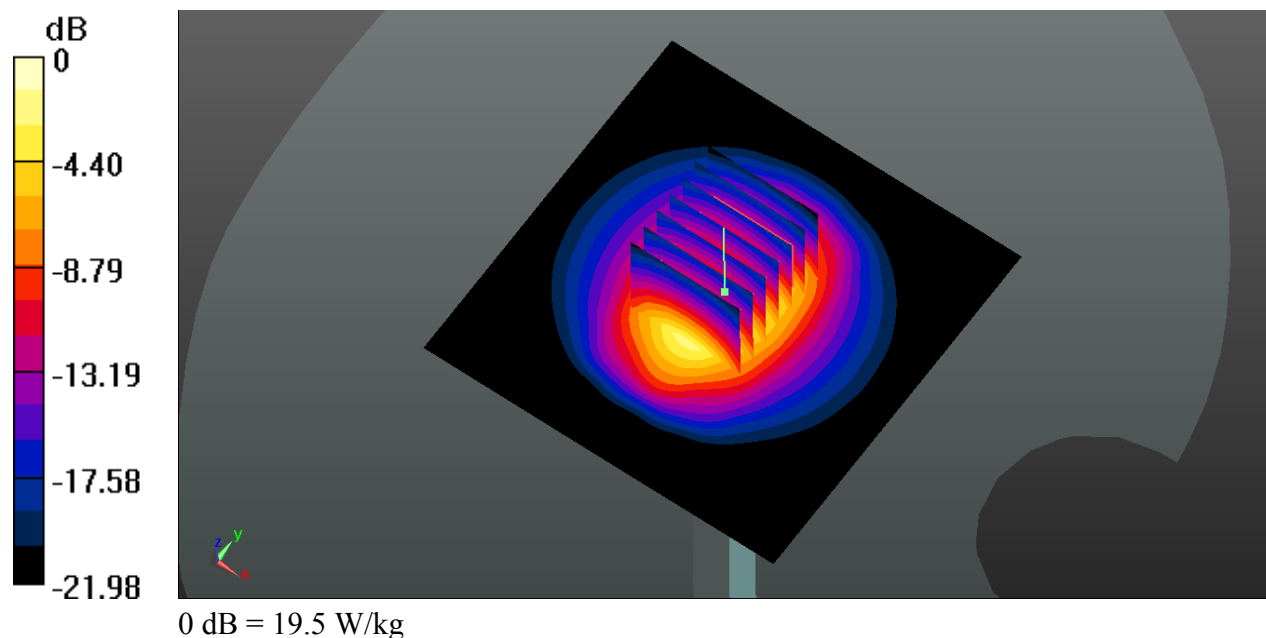

System Check_Head_2600MHz_151010

DUT: D2600V2-SN:1061

Communication System: UID 0, CW; Frequency: 2600 MHz;Duty Cycle: 1:1
Medium: HSL_2600_151010 Medium parameters used: $f = 2600$ MHz; $\sigma = 2.055$ S/m; $\epsilon_r = 38.316$;
 $\rho = 1000$ kg/m³

Ambient Temperature: 23.3 °C ; Liquid Temperature: 22.7 °C

DASY5 Configuration:

- Probe: EX3DV4 - SN3958; ConvF(7.46, 7.46, 7.46); Calibrated: 2015.07.23;
- Sensor-Surface: 2mm (Mechanical Surface Detection)
- Electronics: DAE4 Sn1386; Calibrated: 2015.02.19
- Phantom: SAM1; Type: QD000P40CD; Serial: TP:1670
- Measurement SW: DASY52, Version 52.8 (8);SEMCAD X Version 14.6.10 (7331)

Pin=250mW/Area Scan (61x61x1): Interpolated grid: dx=12mm, dy=12mm

Maximum value of SAR (interpolated) = 21.9 W/kg

Pin=250mW/Zoom Scan (7x7x7)/Cube 0: Measurement grid: dx=5mm, dy=5mm, dz=5mm

Reference Value = 101.13 V/m; Power Drift = -0.03 dB

Peak SAR (extrapolated) = 30.3 W/kg

SAR(1 g) = 13.5 W/kg; SAR(10 g) = 6.13 W/kg

Maximum value of SAR (measured) = 20.7 W/kg

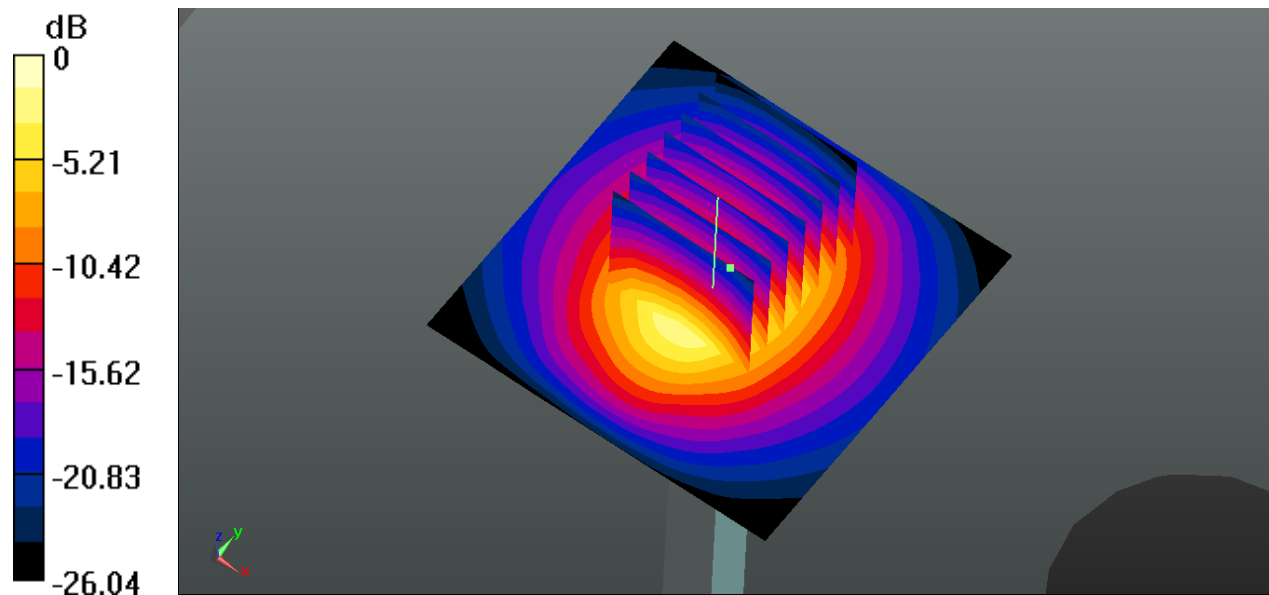

0 dB = 21.9 W/kg

System Check_Body_750MHz_150929

DUT: D750V3-SN:1065

Communication System: UID 0, CW; Frequency: 750 MHz;Duty Cycle: 1:1
Medium: MSL_750_150929 Medium parameters used: $f = 750$ MHz; $\sigma = 0.97$ S/m; $\epsilon_r = 54.642$; $\rho = 1000$ kg/m³

Ambient Temperature: 23.2 °C ; Liquid Temperature: 22.6 °C

DASY5 Configuration:

- Probe: EX3DV4 - SN3958; ConvF(10.05, 10.05, 10.05); Calibrated: 2015.07.23;
- Sensor-Surface: 2mm (Mechanical Surface Detection)
- Electronics: DAE4 Sn1386; Calibrated: 2015.02.19
- Phantom: SAM1; Type: QD000P40CD; Serial: TP:1670
- Measurement SW: DASY52, Version 52.8 (8);SEMCAD X Version 14.6.10 (7331)

Pin=250mW/Area Scan (61x61x1): Interpolated grid: dx=15mm, dy=15mm

Maximum value of SAR (interpolated) = 2.88 W/kg

Pin=250mW/Zoom Scan (5x5x7)/Cube 0: Measurement grid: dx=8mm, dy=8mm, dz=5mm

Reference Value = 50.45 V/m; Power Drift = 0.03 dB

Peak SAR (extrapolated) = 3.35 W/kg

SAR(1 g) = 2.32 W/kg; SAR(10 g) = 1.53 W/kg

Maximum value of SAR (measured) = 2.97 W/kg

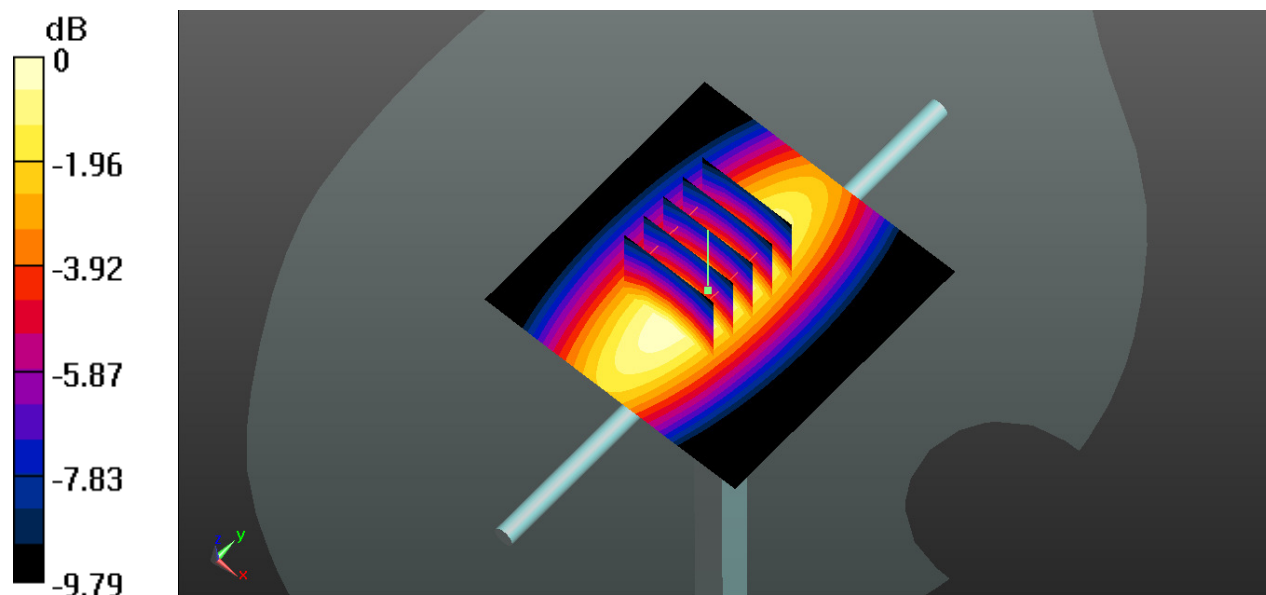

0 dB = 2.88 W/kg

System Check_Body_835MHz_150928

DUT: D835V2-SN: 4d091

Communication System: UID 0, CW; Frequency: 835 MHz;Duty Cycle: 1:1
Medium: MSL_835_150928 Medium parameters used: $f = 835$ MHz; $\sigma = 0.961$ S/m; $\epsilon_r = 55.83$; $\rho = 1000$ kg/m³

Ambient Temperature: 23.3 °C ; Liquid Temperature: 22.7 °C

DASY5 Configuration:

- Probe: EX3DV4 - SN3958; ConvF(9.99, 9.99, 9.99); Calibrated: 2015.07.23;
- Sensor-Surface: 2mm (Mechanical Surface Detection)
- Electronics: DAE4 Sn1386; Calibrated: 2015.02.19
- Phantom: SAM1; Type: QD000P40CD; Serial: TP:1670
- Measurement SW: DASY52, Version 52.8 (8);SEMCAD X Version 14.6.10 (7331)

Pin=250mW/Area Scan (61x61x1): Interpolated grid: dx=15mm, dy=15mm

Maximum value of SAR (interpolated) = 2.68 W/kg

Pin=250mW/Zoom Scan (5x5x7)/Cube 0: Measurement grid: dx=8mm, dy=8mm, dz=5mm

Reference Value = 52.67 V/m; Power Drift = -0.01 dB

Peak SAR (extrapolated) = 3.58 W/kg

SAR(1 g) = 2.49 W/kg; SAR(10 g) = 1.67 W/kg

Maximum value of SAR (measured) = 2.68 W/kg

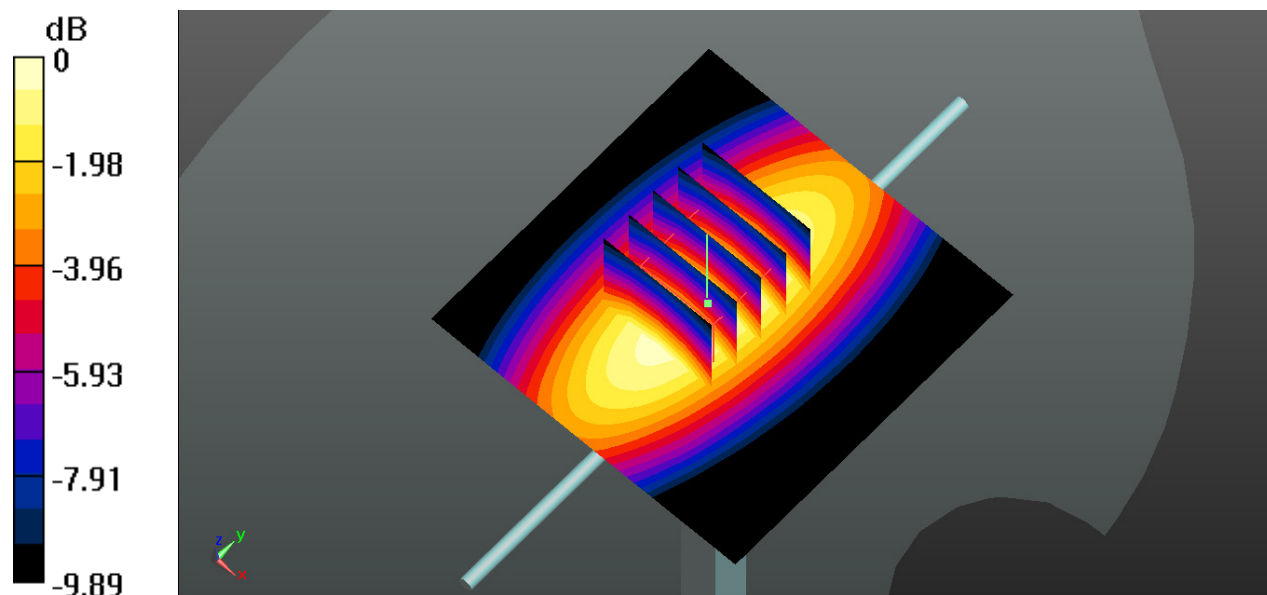

0 dB = 2.68 W/kg

System Check_Body_835MHz_150929

DUT: D835V2-SN: 4d091

Communication System: UID 0, CW; Frequency: 835 MHz;Duty Cycle: 1:1
Medium: MSL_835_150929 Medium parameters used: $f = 835 \text{ MHz}$; $\sigma = 0.998 \text{ S/m}$; $\epsilon_r = 54.379$; $\rho = 1000 \text{ kg/m}^3$

Ambient Temperature: 23.2 °C ; Liquid Temperature: 22.7 °C

DASY5 Configuration:

- Probe: EX3DV4 - SN3958; ConvF(9.99, 9.99, 9.99); Calibrated: 2015.07.23;
- Sensor-Surface: 2mm (Mechanical Surface Detection)
- Electronics: DAE4 Sn1386; Calibrated: 2015.02.19
- Phantom: SAM1; Type: QD000P40CD; Serial: TP:1670
- Measurement SW: DASY52, Version 52.8 (8);SEMCAD X Version 14.6.10 (7331)

Pin=250mW/Area Scan (61x61x1): Interpolated grid: $dx=15\text{mm}$, $dy=15\text{mm}$

Maximum value of SAR (interpolated) = 2.42 W/kg

Pin=250mW/Zoom Scan (5x5x7)/Cube 0: Measurement grid: $dx=8\text{mm}$, $dy=8\text{mm}$, $dz=5\text{mm}$

Reference Value = 49.85 V/m; Power Drift = 0.02 dB

Peak SAR (extrapolated) = 3.31 W/kg

SAR(1 g) = 2.25 W/kg; SAR(10 g) = 1.49 W/kg

Maximum value of SAR (measured) = 2.41 W/kg

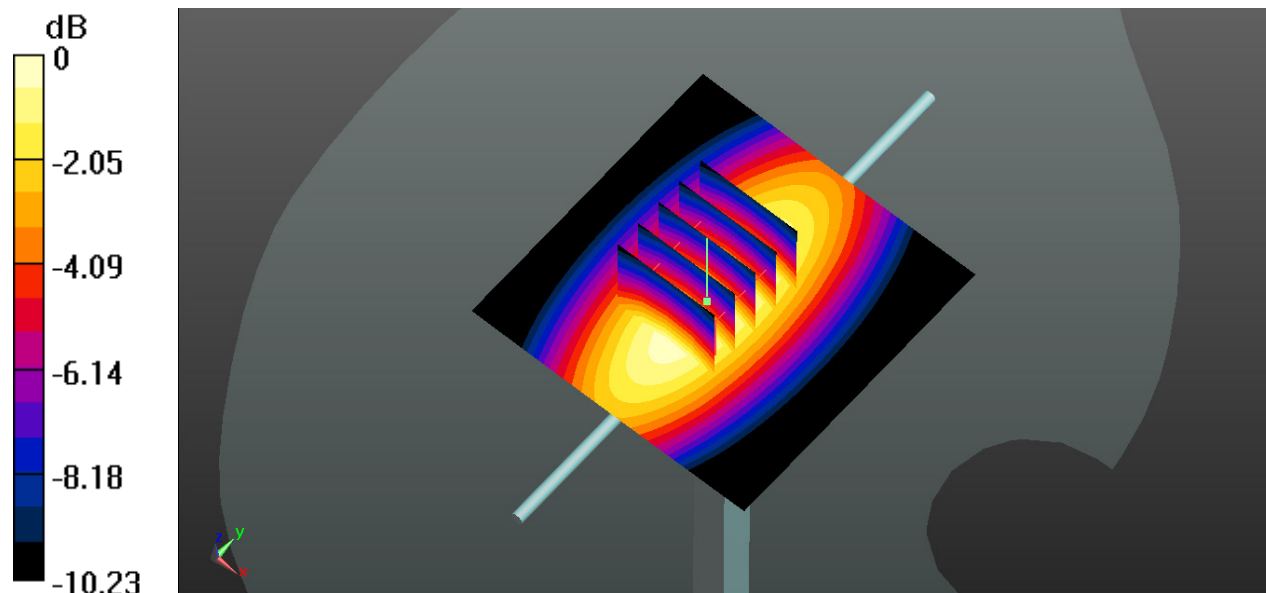

0 dB = 2.13 W/kg

System Check_Body_1750MHz_150929

DUT: D1750V2-SN: 1069

Communication System: UID 0, CW; Frequency: 1750 MHz; Duty Cycle: 1:1
Medium: MSL_1800_150929 Medium parameters used: $f = 1750$ MHz; $\sigma = 1.514$ S/m; $\epsilon_r = 53.575$;
 $\rho = 1000$ kg/m³

Ambient Temperature: 23.4 °C ; Liquid Temperature: 22.9 °C

DASY5 Configuration:

- Probe: EX3DV4 - SN3958; ConvF(8.2, 8.2, 8.2); Calibrated: 2015.07.23;
- Sensor-Surface: 2mm (Mechanical Surface Detection)
- Electronics: DAE4 Sn1386; Calibrated: 2015.02.19
- Phantom: SAM1; Type: QD000P40CD; Serial: TP:1670
- Measurement SW: DASY52, Version 52.8 (8); SEMCAD X Version 14.6.10 (7331)

Pin=250mW/Area Scan (61x61x1): Interpolated grid: dx=15mm, dy=15mm

Maximum value of SAR (interpolated) = 12.8 W/kg

Pin=250mW/Zoom Scan (5x5x7)/Cube 0: Measurement grid: dx=8mm, dy=8mm, dz=5mm

Reference Value = 93.48 V/m; Power Drift = -0.05 dB

Peak SAR (extrapolated) = 15.7 W/kg

SAR(1 g) = 9.06 W/kg; SAR(10 g) = 4.86 W/kg

Maximum value of SAR (measured) = 12.6 W/kg

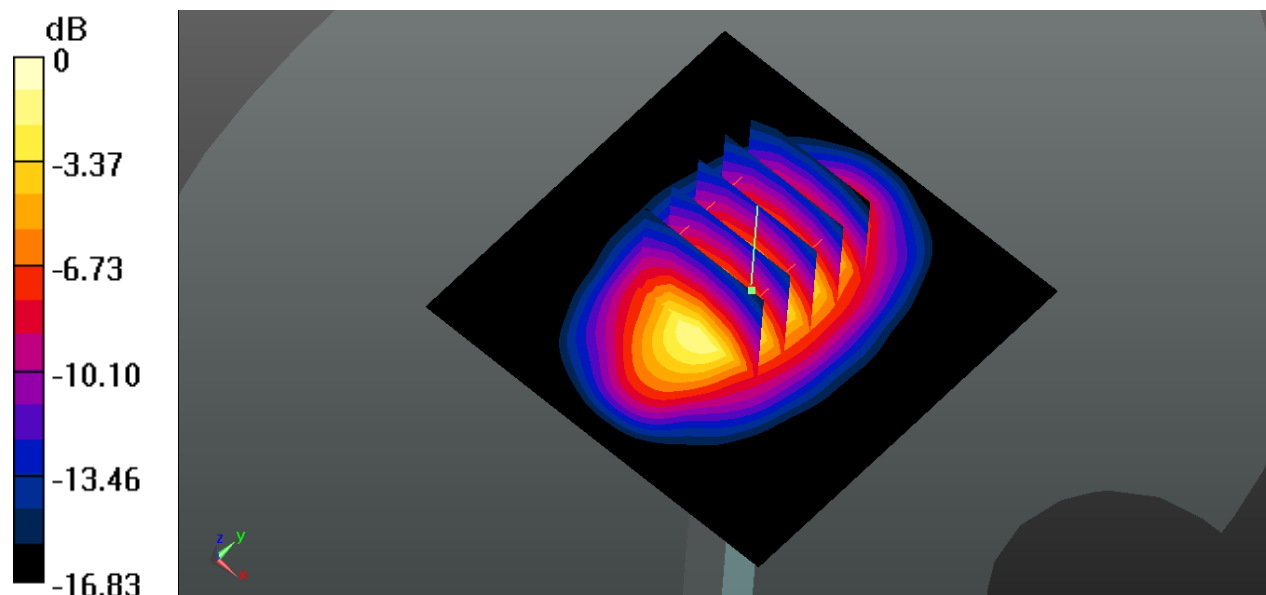

0 dB = 12.8 W/kg

System Check_Body_1750MHz_150930

DUT: D1750V2-SN: 1069

Communication System: UID 0, CW; Frequency: 1750 MHz; Duty Cycle: 1:1
Medium: MSL_1800_150930 Medium parameters used: $f = 1750$ MHz; $\sigma = 1.522$ S/m; $\epsilon_r = 52.519$;
 $\rho = 1000$ kg/m³

Ambient Temperature: 23.5 °C ; Liquid Temperature: 22.8 °C

DASY5 Configuration:

- Probe: EX3DV4 - SN3958; ConvF(8.2, 8.2, 8.2); Calibrated: 2015.07.23;
- Sensor-Surface: 2mm (Mechanical Surface Detection)
- Electronics: DAE4 Sn1386; Calibrated: 2015.02.19
- Phantom: SAM1; Type: QD000P40CD; Serial: TP:1670
- Measurement SW: DASY52, Version 52.8 (8); SEMCAD X Version 14.6.10 (7331)

Pin=250mW/Area Scan (61x61x1): Interpolated grid: dx=15mm, dy=15mm

Maximum value of SAR (interpolated) = 12.6 W/kg

Pin=250mW/Zoom Scan (5x5x7)/Cube 0: Measurement grid: dx=8mm, dy=8mm, dz=5mm

Reference Value = 90.53 V/m; Power Drift = 0.06 dB

Peak SAR (extrapolated) = 15.6 W/kg

SAR(1 g) = 9.04 W/kg; SAR(10 g) = 4.87 W/kg

Maximum value of SAR (measured) = 12.4 W/kg

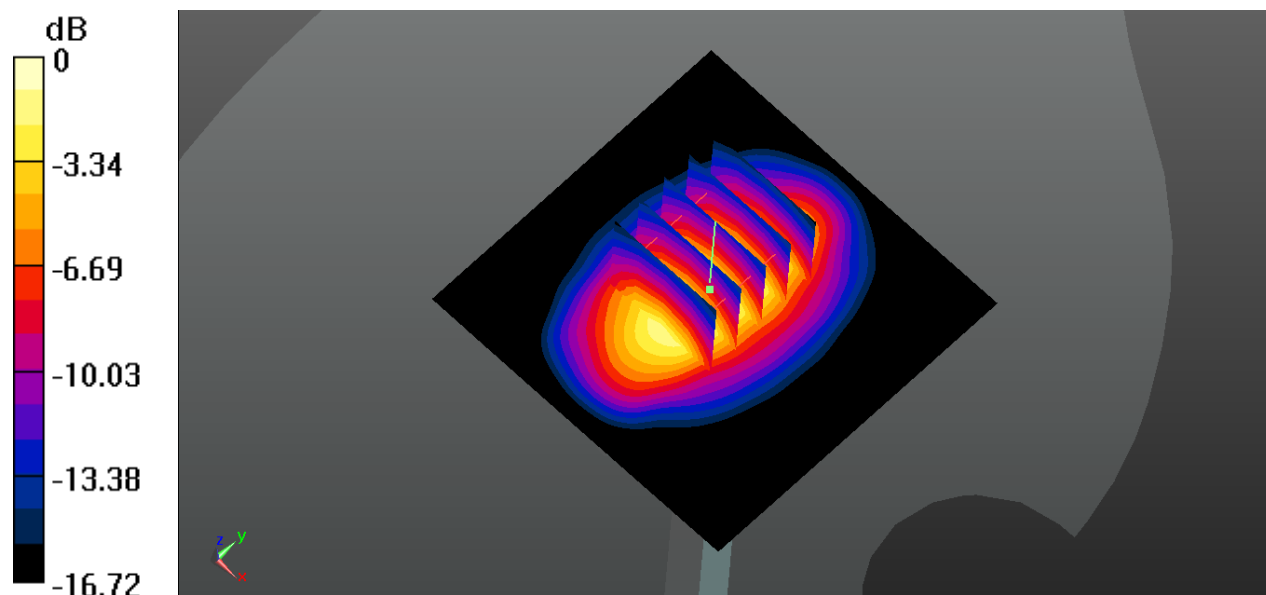

0 dB = 12.6 W/kg

System Check_Body_1900MHz_150929

DUT: D1900V2-SN:5d118

Communication System: UID 0, CW; Frequency: 1900 MHz; Duty Cycle: 1:1
Medium: MSL_1900_150929 Medium parameters used: $f = 1900$ MHz; $\sigma = 1.551$ S/m; $\epsilon_r = 54.273$;
 $\rho = 1000$ kg/m³

Ambient Temperature: 23.4 °C ; Liquid Temperature: 22.8 °C

DASY5 Configuration:

- Probe: EX3DV4 - SN3958; ConvF(7.87, 7.87, 7.87); Calibrated: 2015.07.23;
- Sensor-Surface: 2mm (Mechanical Surface Detection)
- Electronics: DAE4 Sn1386; Calibrated: 2015.02.19
- Phantom: SAM1; Type: QD000P40CD; Serial: TP:1670
- Measurement SW: DASY52, Version 52.8 (8); SEMCAD X Version 14.6.10 (7331)

Pin=250mW/Area Scan (61x61x1): Interpolated grid: dx=15mm, dy=15mm

Maximum value of SAR (interpolated) = 14.0 W/kg

Pin=250mW/Zoom Scan (5x5x7)/Cube 0: Measurement grid: dx=8mm, dy=8mm, dz=5mm

Reference Value = 83.10 V/m; Power Drift = 0.01 dB

Peak SAR (extrapolated) = 17.6 W/kg

SAR(1 g) = 9.83 W/kg; SAR(10 g) = 5.11 W/kg

Maximum value of SAR (measured) = 13.7 W/kg

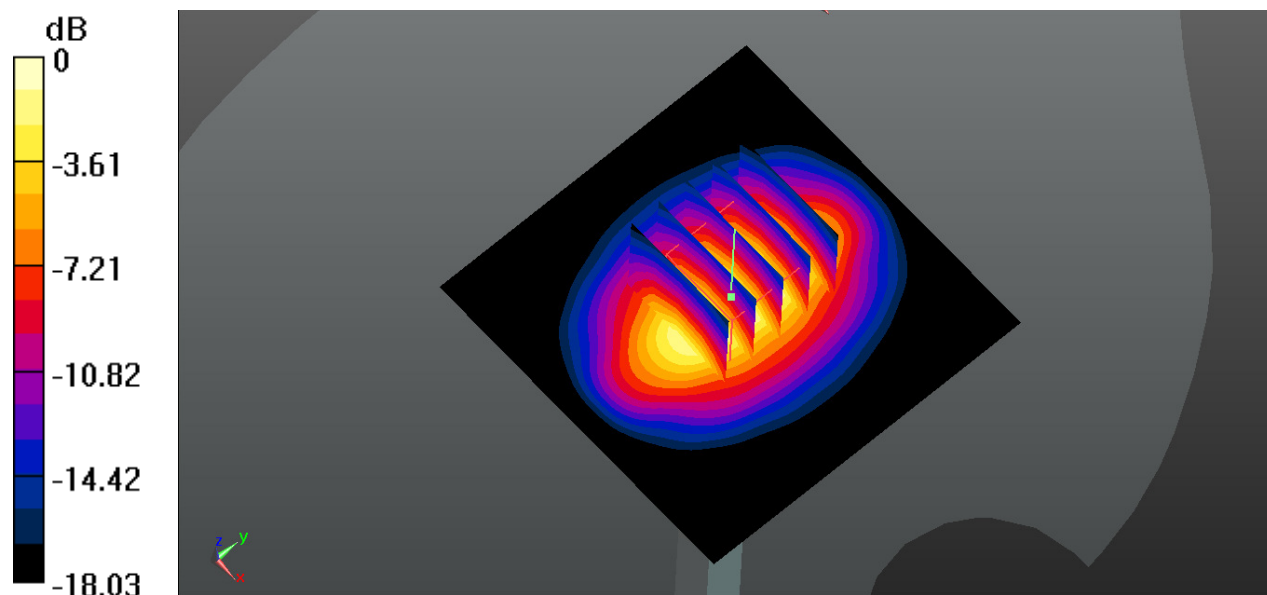

0 dB = 14.0 W/kg

System Check_Body_1900MHz_150930

DUT: D1900V2-SN:5d118

Communication System: UID 0, CW; Frequency: 1900 MHz;Duty Cycle: 1:1
Medium: MSL_1900_150930 Medium parameters used: $f = 1900$ MHz; $\sigma = 1.584$ S/m; $\epsilon_r = 54.212$;
 $\rho = 1000$ kg/m³

Ambient Temperature: 23.5 °C ; Liquid Temperature: 22.7 °C

DASY5 Configuration:

- Probe: EX3DV4 - SN3958; ConvF(7.87, 7.87, 7.87); Calibrated: 2015.07.23;
- Sensor-Surface: 2mm (Mechanical Surface Detection)
- Electronics: DAE4 Sn1386; Calibrated: 2015.02.19
- Phantom: SAM1; Type: QD000P40CD; Serial: TP:1670
- Measurement SW: DASY52, Version 52.8 (8);SEMCAD X Version 14.6.10 (7331)

Pin=250mW/Area Scan (61x61x1): Interpolated grid: dx=15mm, dy=15mm

Maximum value of SAR (interpolated) = 14.5 W/kg

Pin=250mW/Zoom Scan (5x5x7)/Cube 0: Measurement grid: dx=8mm, dy=8mm, dz=5mm

Reference Value = 84.77 V/m; Power Drift = -0.01 dB

Peak SAR (extrapolated) = 18.3 W/kg

SAR(1 g) = 10.1 W/kg; SAR(10 g) = 5.21 W/kg

Maximum value of SAR (measured) = 14.4 W/kg

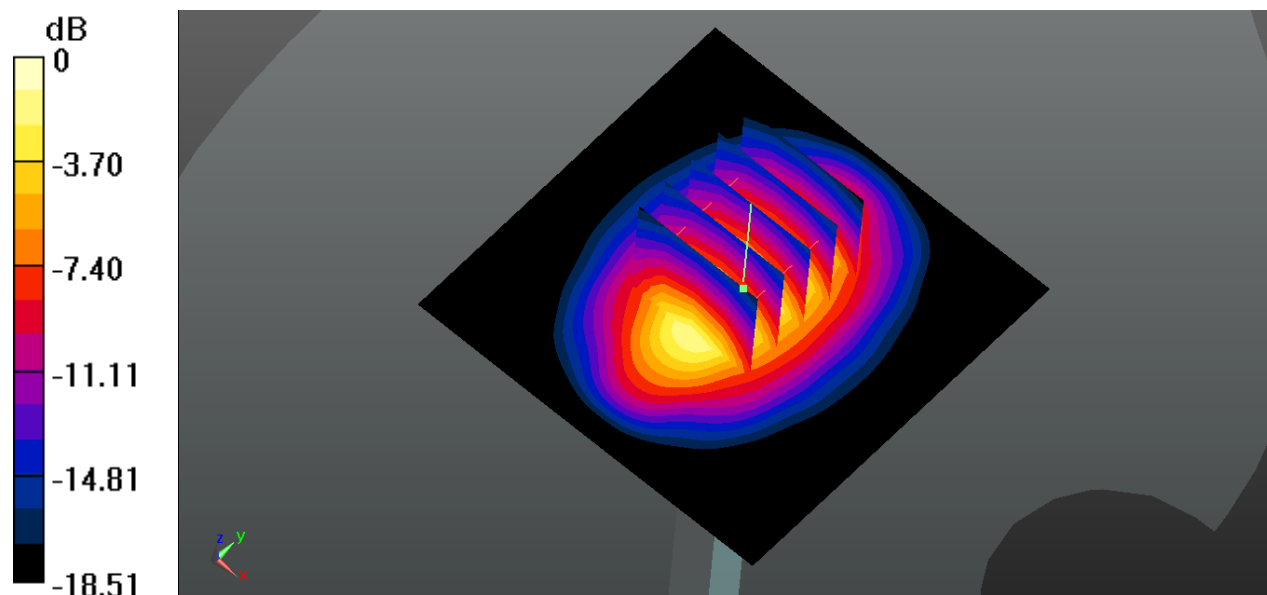

0 dB = 14.5 W/kg

System Check_Body_2450MHz_151009

DUT: D2450V2-SN:926

Communication System: UID 0, CW; Frequency: 2450 MHz;Duty Cycle: 1:1
Medium: MSL_2450_151009 Medium parameters used: $f = 2450$ MHz; $\sigma = 2.033$ S/m; $\epsilon_r = 50.608$;
 $\rho = 1000$ kg/m³

Ambient Temperature: 23.3 °C ; Liquid Temperature: 22.6 °C

DASY5 Configuration:

- Probe: EX3DV4 - SN3958; ConvF(7.55, 7.55, 7.55); Calibrated: 2015.02.26;
- Sensor-Surface: 2mm (Mechanical Surface Detection)
- Electronics: DAE4 Sn1386; Calibrated: 2015.02.19
- Phantom: SAM1; Type: QD000P40CD; Serial: TP:1670
- Measurement SW: DASY52, Version 52.8 (8);SEMCAD X Version 14.6.10 (7331)

Pin=250mW/Area Scan (81x81x1): Interpolated grid: dx=12mm, dy=12mm

Maximum value of SAR (interpolated) = 19.2 W/kg

Pin=250mW/Zoom Scan (7x7x7)/Cube 0: Measurement grid: dx=5mm, dy=5mm, dz=5mm

Reference Value = 75.66 V/m; Power Drift = 0.02 dB

Peak SAR (extrapolated) = 24.3 W/kg

SAR(1 g) = 12.3 W/kg; SAR(10 g) = 5.82 W/kg

Maximum value of SAR (measured) = 18.2 W/kg

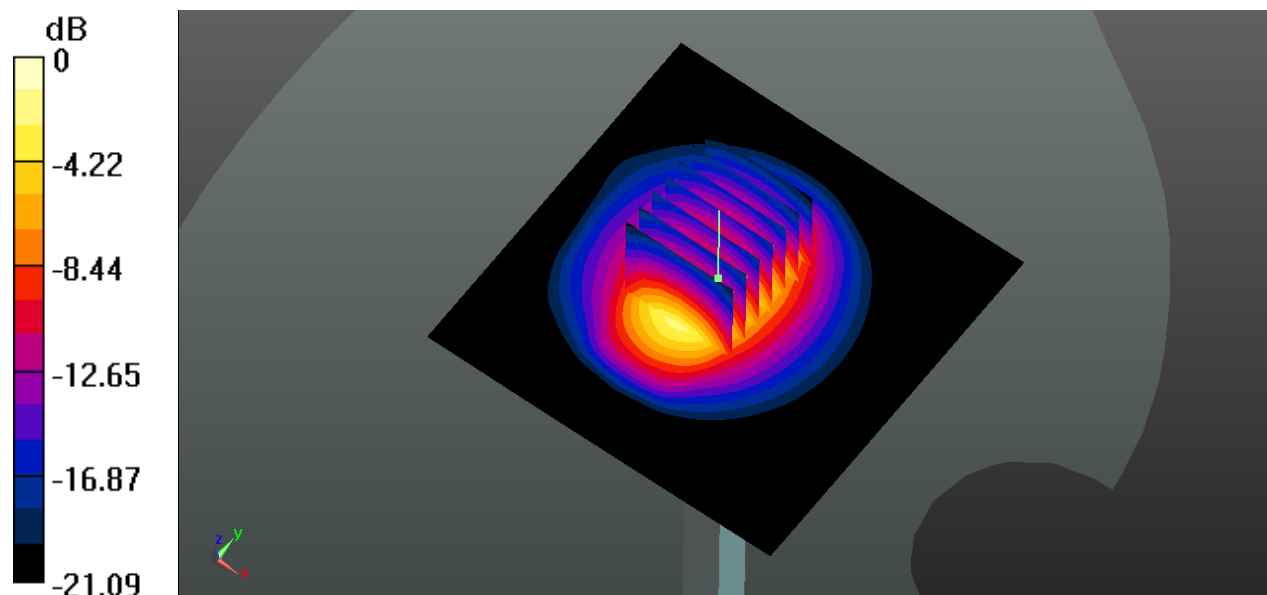

0 dB = 19.2 W/kg

System Check_Body_2600MHz_151009

DUT: D2600V2-SN:1061

Communication System: UID 0, CW; Frequency: 2600 MHz;Duty Cycle: 1:1
Medium: MSL_2600_151009 Medium parameters used: $f = 2600$ MHz; $\sigma = 2.217$ S/m; $\epsilon_r = 50.697$;
 $\rho = 1000$ kg/m³

Ambient Temperature: 23.4 °C ; Liquid Temperature: 22.8 °C

DASY5 Configuration:

- Probe: EX3DV4 - SN3958; ConvF(7.41, 7.41, 7.41); Calibrated: 2015.07.23;
- Sensor-Surface: 2mm (Mechanical Surface Detection)
- Electronics: DAE4 Sn1386; Calibrated: 2015.02.19
- Phantom: SAM1; Type: QD000P40CD; Serial: TP:1670
- Measurement SW: DASY52, Version 52.8 (8);SEMCAD X Version 14.6.10 (7331)

Pin=250mW/Area Scan (61x71x1): Interpolated grid: dx=12mm, dy=12mm

Maximum value of SAR (interpolated) = 22.2 W/kg

Pin=250mW/Zoom Scan (7x7x7)/Cube 0: Measurement grid: dx=5mm, dy=5mm, dz=5mm

Reference Value = 97.17 V/m; Power Drift = 0.08 dB

Peak SAR (extrapolated) = 28.9 W/kg

SAR(1 g) = 13.3 W/kg; SAR(10 g) = 5.81 W/kg

Maximum value of SAR (measured) = 21.0 W/kg

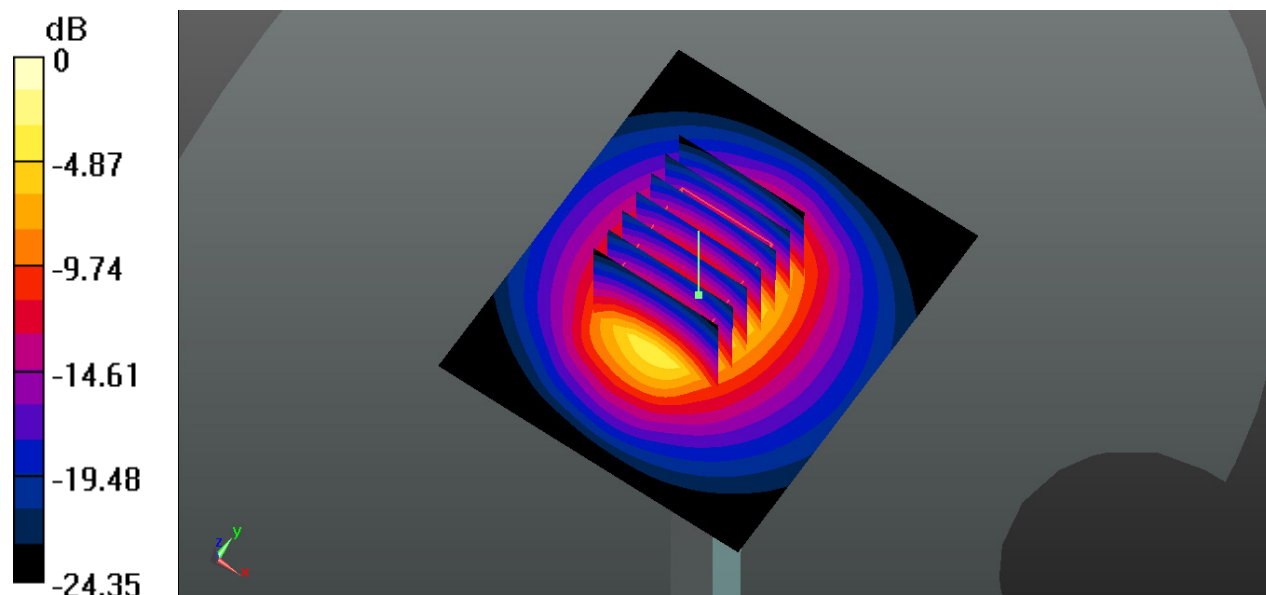

0 dB = 22.2 W/kg



Appendix B. Plots of High SAR Measurement

The plots are shown as follows.

#12_Bluetooth_DH5_Left Cheek_Ch0

Communication System: UID 0, Bluetooth (0); Frequency: 2402 MHz;Duty Cycle: 1:1.2
Medium: HSL_2450_151028 Medium parameters used: $f = 2402$ MHz; $\sigma = 1.701$ S/m; $\epsilon_r = 39.957$;
 $\rho = 1000$ kg/m³

Ambient Temperature: 23.2 °C ; **Liquid Temperature:** 22.9 °C

DASY5 Configuration:

- Probe: EX3DV4 - SN3958; ConvF(7.58, 7.58, 7.58); Calibrated: 2015.07.23;
- Sensor-Surface: 2mm (Mechanical Surface Detection)
- Electronics: DAE4 Sn1386; Calibrated: 2015.02.19
- Phantom: SAM1; Type: QD000P40CD; Serial: TP:1670
- Measurement SW: DASY52, Version 52.8 (8);SEMCAD X Version 14.6.10 (7331)

Ch0/Area Scan (81x141x1): Interpolated grid: dx=12mm, dy=12mm

Maximum value of SAR (interpolated) = 0.122 W/kg

Ch0/Zoom Scan (7x7x7)/Cube 0: Measurement grid: dx=5mm, dy=5mm, dz=5mm

Reference Value = 0.7620 V/m; Power Drift = -0.09 dB

Peak SAR (extrapolated) = 0.205 W/kg

SAR(1 g) = 0.062 W/kg; SAR(10 g) = 0.025 W/kg

Maximum value of SAR (measured) = 0.127 W/kg

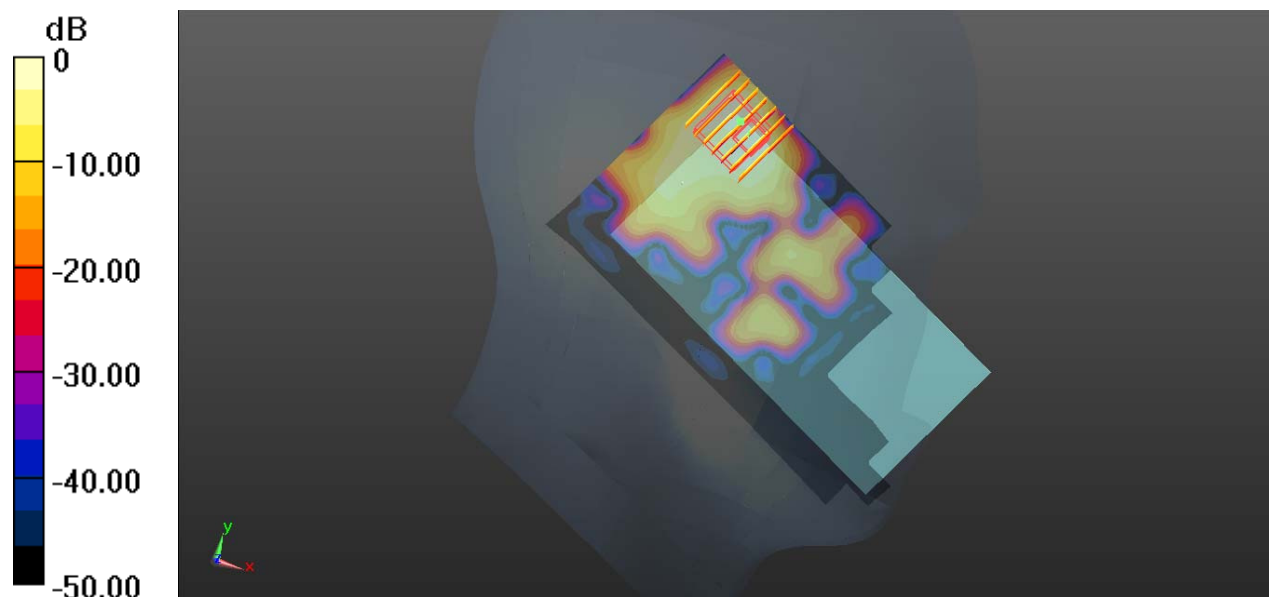

#20_LTE Band 4_20M_QPSK_1RB_49Offset_Bottom Side_10mm_Ch20175

Communication System: UID 0, LTE (0); Frequency: 1732.5 MHz;Duty Cycle: 1:1
Medium: MSL_1800_150930 Medium parameters used: $f = 1732.5$ MHz; $\sigma = 1.502$ S/m; $\epsilon_r = 52.553$; $\rho = 1000$ kg/m³

Ambient Temperature: 23.5 °C ; **Liquid Temperature:** 22.8 °C

DASY5 Configuration:

- Probe: EX3DV4 - SN3958; ConvF(8.2, 8.2, 8.2); Calibrated: 2015.07.23;
- Sensor-Surface: 2mm (Mechanical Surface Detection)
- Electronics: DAE4 Sn1386; Calibrated: 2015.02.19
- Phantom: SAM1; Type: QD000P40CD; Serial: TP:1670
- Measurement SW: DASY52, Version 52.8 (8);SEMCAD X Version 14.6.10 (7331)

Ch20175/Area Scan (41x71x1): Interpolated grid: dx=15mm, dy=15mm

Maximum value of SAR (interpolated) = 1.02 W/kg

Ch20175/Zoom Scan (5x5x7)/Cube 0: Measurement grid: dx=8mm, dy=8mm, dz=5mm

Reference Value = 3.458 V/m; Power Drift = 0.13 dB

Peak SAR (extrapolated) = 1.18 W/kg

SAR(1 g) = 0.713 W/kg; SAR(10 g) = 0.384 W/kg

Maximum value of SAR (measured) = 0.975 W/kg

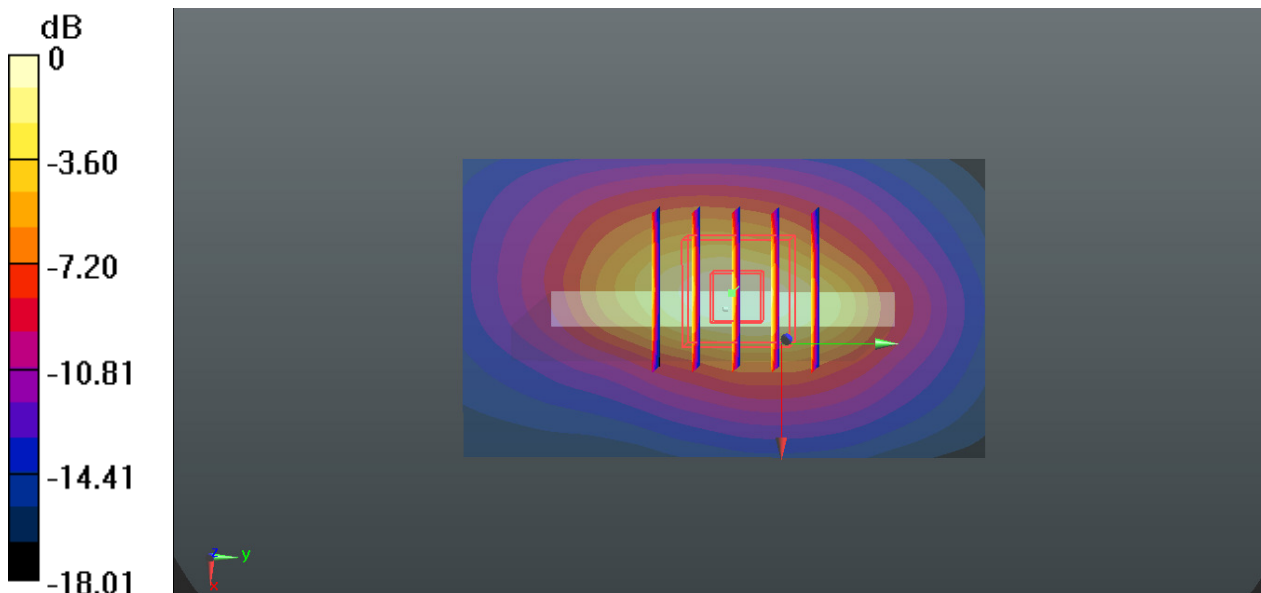

0 dB = 1.02 W/kg

#27_LTE Band 4_20M_QPSK_1RB_49Offset_Back_10mm_Ch20175

Communication System: UID 0, LTE (0); Frequency: 1732.5 MHz;Duty Cycle: 1:1
Medium: MSL_1800_150930 Medium parameters used: $f = 1732.5$ MHz; $\sigma = 1.502$ S/m; $\epsilon_r = 52.553$; $\rho = 1000$ kg/m³

Ambient Temperature: 23.5 °C ; **Liquid Temperature:** 22.8 °C

DASY5 Configuration:

- Probe: EX3DV4 - SN3958; ConvF(8.2, 8.2, 8.2); Calibrated: 2015.07.23;
- Sensor-Surface: 2mm (Mechanical Surface Detection)
- Electronics: DAE4 Sn1386; Calibrated: 2015.02.19
- Phantom: SAM1; Type: QD000P40CD; Serial: TP:1670
- Measurement SW: DASY52, Version 52.8 (8);SEMCAD X Version 14.6.10 (7331)

Ch20175/Area Scan (71x121x1): Interpolated grid: dx=15mm, dy=15mm

Maximum value of SAR (interpolated) = 0.626 W/kg

Ch20175/Zoom Scan (5x5x7)/Cube 0: Measurement grid: dx=8mm, dy=8mm, dz=5mm

Reference Value = 2.613 V/m; Power Drift = 0.06 dB

Peak SAR (extrapolated) = 0.883 W/kg

SAR(1 g) = 0.545 W/kg; SAR(10 g) = 0.305 W/kg

Maximum value of SAR (measured) = 0.726 W/kg

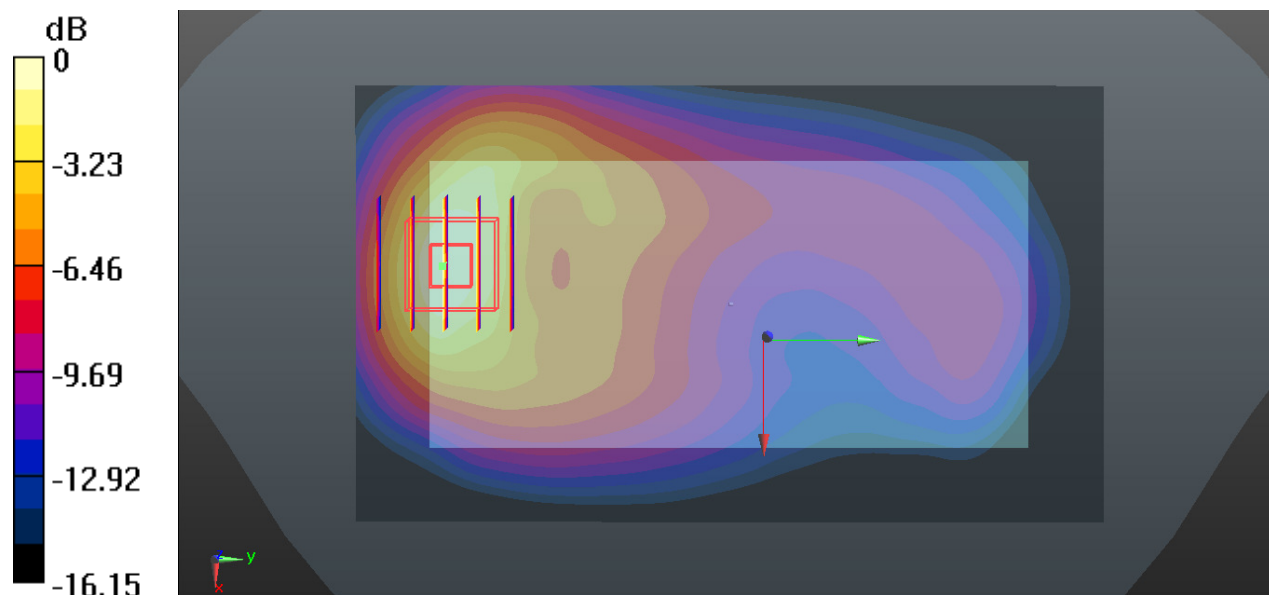

0 dB = 0.626 W/kg

#28_LTE Band 2_20M_QPSK_1RB_49Offset_Back_10mm_Ch19100

Communication System: UID 0, LTE (0); Frequency: 1900 MHz;Duty Cycle: 1:1
Medium: MSL_1900_150930 Medium parameters used: $f = 1900$ MHz; $\sigma = 1.584$ S/m; $\epsilon_r = 54.212$;
 $\rho = 1000$ kg/m³

Ambient Temperature: 23.5 °C ; **Liquid Temperature:** 22.7 °C

DASY5 Configuration:

- Probe: EX3DV4 - SN3958; ConvF(7.87, 7.87, 7.87); Calibrated: 2015.07.23;
- Sensor-Surface: 2mm (Mechanical Surface Detection)
- Electronics: DAE4 Sn1386; Calibrated: 2015.02.19
- Phantom: SAM1; Type: QD000P40CD; Serial: TP:1670
- Measurement SW: DASY52, Version 52.8 (8);SEMCAD X Version 14.6.10 (7331)

Ch19100/Area Scan (71x121x1): Interpolated grid: dx=15mm, dy=15mm

Maximum value of SAR (interpolated) = 1.01 W/kg

Ch19100/Zoom Scan (5x5x7)/Cube 0: Measurement grid: dx=8mm, dy=8mm, dz=5mm

Reference Value = 1.827 V/m; Power Drift = 0.08 dB

Peak SAR (extrapolated) = 1.33 W/kg

SAR(1 g) = 0.781 W/kg; SAR(10 g) = 0.422 W/kg

Maximum value of SAR (measured) = 1.08 W/kg

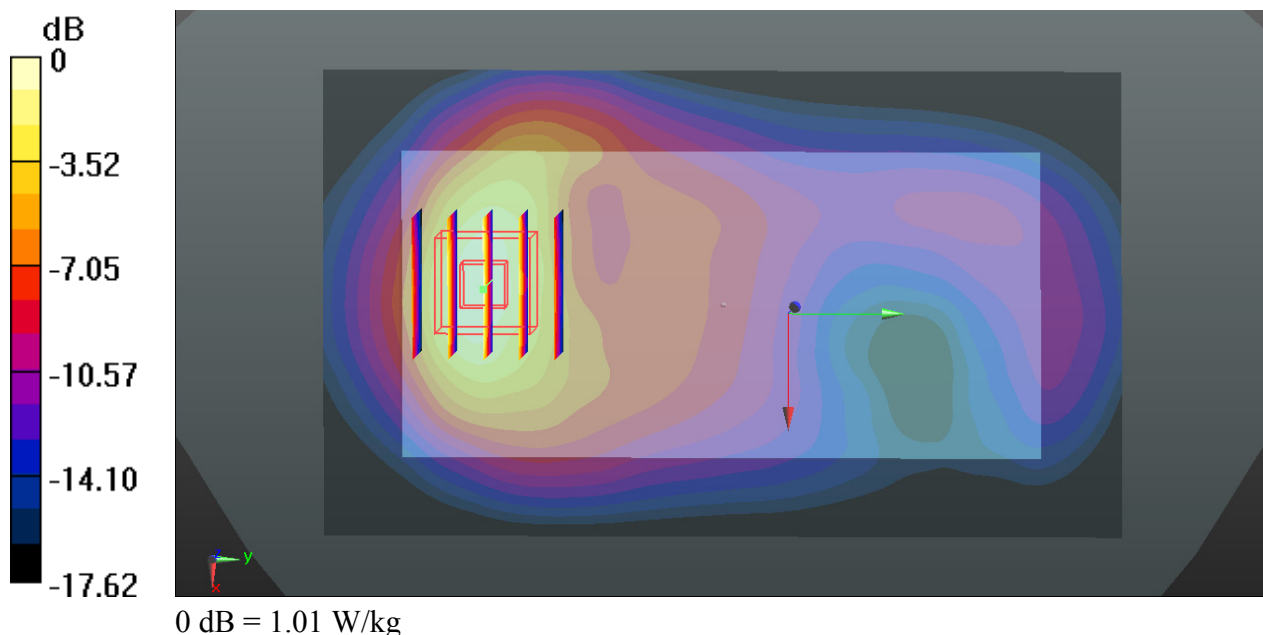

#29_LTE Band 7_20M_QPSK_1RB_49Offset_Back_10mm_Ch21100

Communication System: UID 0, LTE (0); Frequency: 2535 MHz;Duty Cycle: 1:1
Medium: MSL_2600_151009 Medium parameters used: $f = 2535$ MHz; $\sigma = 2.134$ S/m; $\epsilon_r = 51.246$;
 $\rho = 1000$ kg/m³

Ambient Temperature: 23.4 °C ; **Liquid Temperature:** 22.8 °C

DASY5 Configuration:

- Probe: EX3DV4 - SN3958; ConvF(7.41, 7.41, 7.41); Calibrated: 2015.07.23;
- Sensor-Surface: 2mm (Mechanical Surface Detection)
- Electronics: DAE4 Sn1386; Calibrated: 2015.02.19
- Phantom: SAM1; Type: QD000P40CD; Serial: TP:1670
- Measurement SW: DASY52, Version 52.8 (8);SEMCAD X Version 14.6.10 (7331)

Ch21100/Area Scan (81x141x1): Interpolated grid: dx=12mm, dy=12mm

Maximum value of SAR (interpolated) = 0.363 W/kg

Ch21100/Zoom Scan (7x7x7)/Cube 0: Measurement grid: dx=5mm, dy=5mm, dz=5mm

Reference Value = 0.8830 V/m; Power Drift = -0.05 dB

Peak SAR (extrapolated) = 0.513 W/kg

SAR(1 g) = 0.273 W/kg; SAR(10 g) = 0.143 W/kg

Maximum value of SAR (measured) = 0.389 W/kg

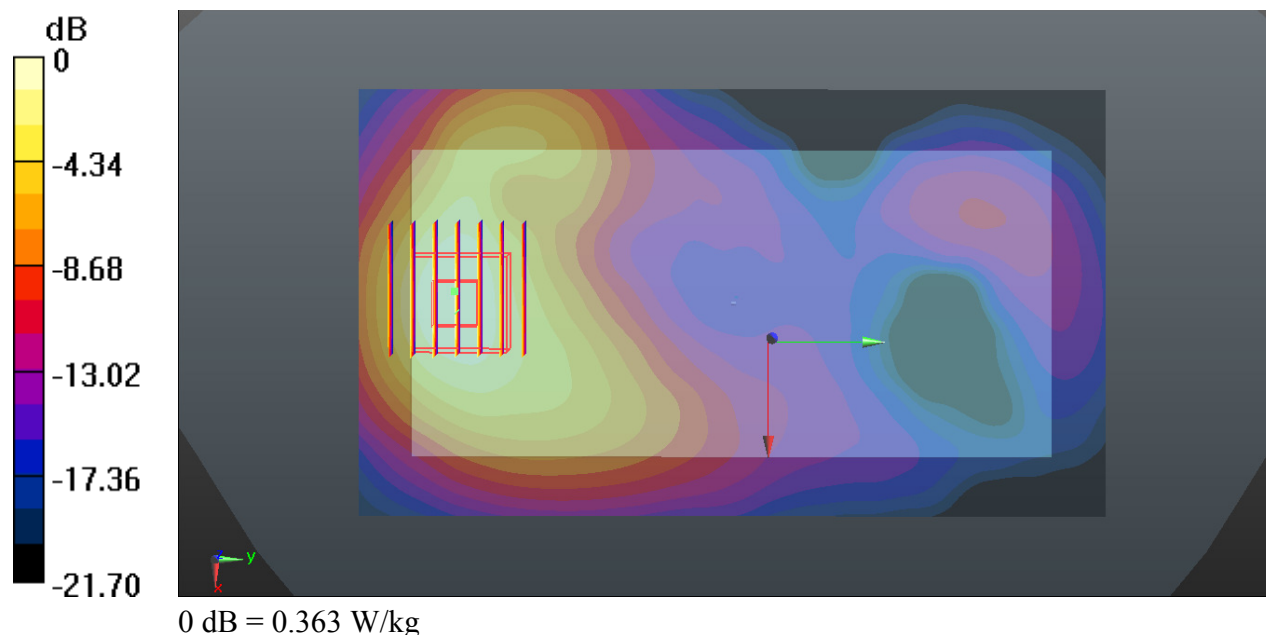

#30_WLAN2.4GHz_802.11b 1Mbps_Front_10mm_Ch11

Communication System: UID 0, WIFI (0); Frequency: 2462 MHz;Duty Cycle: 1:1.027
Medium: MSL_2450_151009 Medium parameters used: $f = 2462$ MHz; $\sigma = 2.052$ S/m; $\epsilon_r = 50.551$;
 $\rho = 1000$ kg/m³

Ambient Temperature: 23.3 °C ; **Liquid Temperature:** 22.6 °C

DASY5 Configuration:

- Probe: EX3DV4 - SN3958; ConvF(7.55, 7.55, 7.55); Calibrated: 2015.02.26;
- Sensor-Surface: 2mm (Mechanical Surface Detection)
- Electronics: DAE4 Sn1386; Calibrated: 2015.02.19
- Phantom: SAM1; Type: QD000P40CD; Serial: TP:1670
- Measurement SW: DASY52, Version 52.8 (8);SEMCAD X Version 14.6.10 (7331)

Ch11/Area Scan (81x151x1): Interpolated grid: dx=12mm, dy=12mm

Maximum value of SAR (interpolated) = 0.0984 W/kg

Ch11/Zoom Scan (7x7x7)/Cube 0: Measurement grid: dx=5mm, dy=5mm, dz=5mm

Reference Value = 0.6640 V/m; Power Drift = 0.05 dB

Peak SAR (extrapolated) = 0.134 W/kg

SAR(1 g) = 0.060 W/kg; SAR(10 g) = 0.029 W/kg

Maximum value of SAR (measured) = 0.0957 W/kg

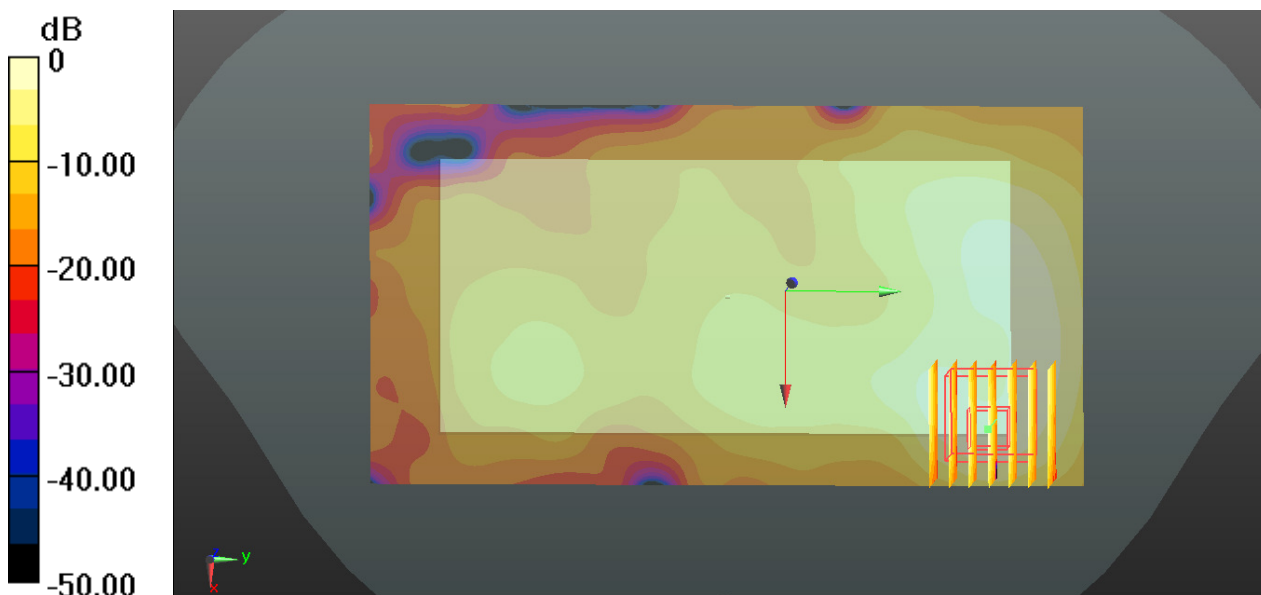

0 dB = 0.0984 W/kg

#31_Bluetooth_DH5_Back_10mm_Ch0

Communication System: UID 0, Bluetooth (0); Frequency: 2402 MHz;Duty Cycle: 1:1.2
Medium: MSL_2450_151009 Medium parameters used: $f = 2402$ MHz; $\sigma = 1.972$ S/m; $\epsilon_r = 50.957$;
 $\rho = 1000$ kg/m³

Ambient Temperature: 23.3 °C ; **Liquid Temperature:** 22.6 °C

DASY5 Configuration:

- Probe: EX3DV4 - SN3958; ConvF(7.55, 7.55, 7.55); Calibrated: 2015.02.26;
- Sensor-Surface: 2mm (Mechanical Surface Detection)
- Electronics: DAE4 Sn1386; Calibrated: 2015.02.19
- Phantom: SAM1; Type: QD000P40CD; Serial: TP:1670
- Measurement SW: DASY52, Version 52.8 (8);SEMCAD X Version 14.6.10 (7331)

Ch0/Area Scan (81x151x1): Interpolated grid: dx=12mm, dy=12mm

Maximum value of SAR (interpolated) = 0.0171 W/kg

Ch0/Zoom Scan (7x7x7)/Cube 0: Measurement grid: dx=5mm, dy=5mm, dz=5mm

Reference Value = 0.4190 V/m; Power Drift = 0.05 dB

Peak SAR (extrapolated) = 0.0520 W/kg

SAR(1 g) = 0.012 W/kg; SAR(10 g) = 0.00509 W/kg

Maximum value of SAR (measured) = 0.0190 W/kg

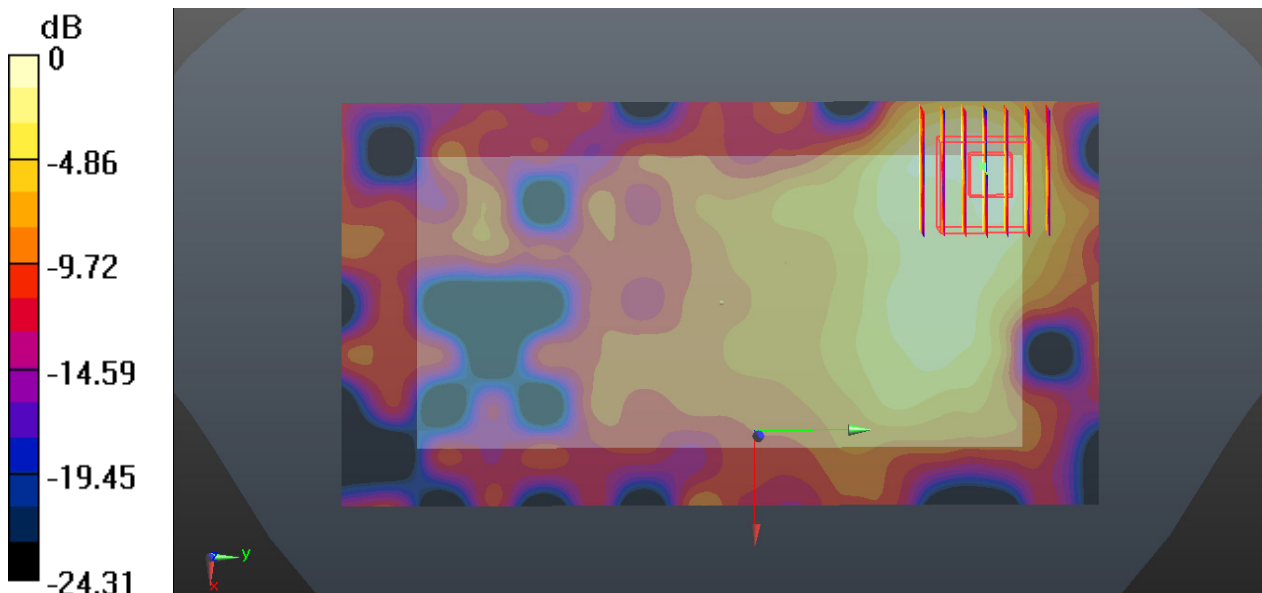

0 dB = 0.0171 W/kg