



Standard Alarm system (Outside Siren)



Standard Alarm system (Inside Siren)



GB.....Manual
IT.....Manuale
DE.....Bedienungsanleitung
NO.....Manual
SE.....Manual
DK.....Manual

(GB)

Thank you for choosing the Yale Standard Alarm System. This simple to install system has been design with the user in mind, just follow these simple steps:

- A) Read the manual carefully to have a good understanding of the required steps.
- B) Make a good plan, work out the best places to locate the devices (up to a total of 20 devices can be paired into the system, devices in the Alarm kit are pre-paired).
- C) Test the devices in these locations before fitting to make sure you have good wireless performance.
- D) After activation, the tamper protection will be switched off for 3h to give you a comfortable installation. Tamper can be switched off for additional 3h intervals if needed or for battery change.

(IT)

Grazie per aver scelto l'impianto di allarme wireless Yale Standard Alarm. Questo impianto, semplice da installare, è stato progettato con l'attenzione rivolta all'utente. Attenersi solo a tre semplici procedure:

- A) leggere attentamente il manuale in modo da comprendere correttamente le fasi da eseguire.
- B) preparare un piano adeguato di montaggio e individuare i punti migliori nei quali posizionare i dispositivi (è possibile associare fino ad un massimo di 20 dispositivi pre-associati).
- C) testare i dispositivi in questa posizione prima dell'installazione per accertarsi di avere una buona prestazione wireless.
- D) Dopo l'attivazione, la protezione anti-effrazione verrà disattivata per 3 ore in modo da permettere una comoda installazione. Se necessario o per la sostituzione delle batterie, la protezione anti-effrazione potrà essere disattivata per altre 3 ore.

(DE)

Vielen Dank, dass Sie sich für ein wireless Yale Standard Alarmsystem entschieden haben. Dieses einfach zu installierende System wurde für den Kunden entwickelt. Folgen Sie einfach den wenigen Schritten:

- A) Lesen Sie die Bedienungsanleitung sorgfältig, um die einzelnen Schritte einfach nachzuvollziehen.
- B) Erstellen Sie sich einen Plan, um zu sehen, wo die Geräte am besten angebracht werden können (Bis zu 20 weitere Geräte können angebunden werden. Die Geräte im Set sind bereits verbunden).
- C) Testen Sie die Geräte in dem angedachten Bereich, bevor Sie diese fest anbringen, um eine einwandfreie kabellose Funktion zu gewährleisten.
- D) Nach der Aktivierung, ist der Sabotagealarm 3 Stunden deaktiviert, so das Sie die Geräte installieren können. Falls notwendig oder bei einem Batteriewechsel kann dies um weitere 3 Stunden verlängert werden.

(NO) (SE) (DK)**(NO)**

Takk for at du valgte et Yale Standard alarmsystem. Denne installasjonsmanualen er utformet for å forenkle monteringen mest mulig. Det anbefales derfor at du følger den foreslåtte rekkefølgen på monteringen.

A) Les grundig gjennom manualen.

B) Legg en god plan for plassering av sensorer. (Komponentene i denne pakken er alle ferdigprogrammerte til systemet og klare til montering. Systemet kan imidlertid utvides med opp til 20 ekstra komponenter.)

C) Test den trådløse forbindelsen på alle stedene du har tenkt å plassere komponenter, før endelig montering.

D) For å forenkle installasjonen vil sabotasjefunksjonen være deaktivert i 3 timer etter første oppstart av alarmsentralen. Ved behov kan sabotasjealarmen når som helst deaktiveres i 3-timers intervaller. Dette kan for eksempel være nyttig ved batteriskifte av sabotasjesikrede komponenter.

(SE)

Tack för att du valt Yale Standard larmsystem. Detta system är enkelt att installera och har konstruerats med användaren i åtanke, bara följ dessa enkla steg:

A) Läs manualen för att få en god överblick över stegen.

B) Gör upp en plan hur du vill placera sensorerna. (Upp till totalt 20 sensorer kan paras in till systemet. Sensorer i kittet är redan in-parade)

C) Testa trådlösa förbindelsen till sensorerna på tilltänkta platserna innan de monteras fast.

D) Efter aktivering av Larmet (ON på Sirenen), så kommer Manipuleringslarm vara urkopplat i 3h för smidig installation. Detta kan stängas av för ytterligare 3h perioder om det skulle behövas, eller för batteri byte.

(DK)

Tak for dit valg af Yale Standard Alarm System. Både system og manual er udformet på en måde, som sigter på at forenkle montering og dagligt brug. Det anbefales at følge den angivne monterings-rækkefølge:

A) Læs manualen grundigt igennem.

B) Forbered en god plan for placering af sensorer. (Komponenter i denne pakkeløsning er alle leveret programmeret til systemet og klar til montage. Systemet kan udvides, op til max 20 komponenter.)

C) Test trådløs forbindelse for ønsket placering af de enkelte komponenter før fastgørelse.

D) For at lette montering vil destruktions alarm, efter aktivering af sirenen, være deaktiveret i en periode af 3 timer. Perioden kan forlænges yderligere med 3 timer ved at slå destruktions alarm fra. Samme procedure ved batteriskift.

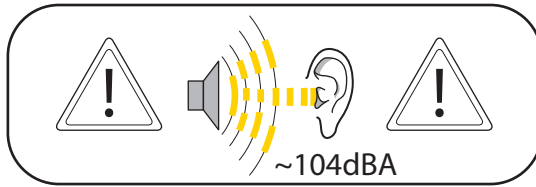

(GB) In the box - (IT) Nella confezione - (DE) Inhalt -
(NO) Innhold i esken - (SE) Uppackning - (DK) Udpakning.

(05-06)



(GB) How does it work - (IT) Come funziona - (DE) Wie es funktioniert -
(NO) Hvordan virker det - (SE) Hur fungerar det - (DK) Hvordan virker det.

(07)



(GB) Plan your system - (IT) Programmazione dell'impianto -
(DE) Planen Sie Ihr System - (NO) Planlegg ditt anlegg -
(SE) Planera ditt system - (DK) Planlæg dit system.

(08-09)



(GB) Installation - (IT) Installazione - (DE) Installation -
(NO) Installasjon - (SE) Installation - (DK) Installation.

(10-15)



(GB) Using the system - (IT) Utilizzo dell'impianto - (DE) Systemeinstellungen -
(NO) Bruk av anlegget - (SE) Använda systemet - (DK) Indstilling af system.

(16-18)



(GB) Changing batteries - (IT) Sostituzione batterie - (DE) Batteriewechsel -
(NO) Batteribytte - (SE) Byta batterier - (DK) Batteriskift.

(19/22)



(GB) Accessories - (IT) Accessori - (DE) Zubehör -
(NO) Ekstrautstyr - (SE) Tillbehör - (DK) Ekstrautstyr.

(20)



(GB) Pairing a new device - (IT) Abbinamento nuovo dispositivo -
(DE) Verbinden neuer Geräte - (NO) Tilkobling av ekstrautstyr -
(SE) Para in nya tillbehör - (DK) Tilslut ekstrautstyr.

(21)



(GB) Resetting components - (IT) Ripristino componenti -
(DE) Zurücksetzen der Komponenten - (NO) Nullstilling av komponenter -
(SE) Nollställa komponenter - (DK) Nulstilling af komponenter.

(23-24)



(GB) Trouble shooting - (IT) Localizzazione e risoluzione dei guasti -
(DE) Problembehandlung - (NO) Feilsøking - (SE) Felsökning - (DK) Fejlfinding.

(25)



(GB) Technical specifications - (IT) Caratteristiche tecniche - (DE) Technische Spezifikationen (26)
(NO) Tekniske spesifikasjoner - (SE) Teknisk specifikation - (DK) Tekniske specifikationer



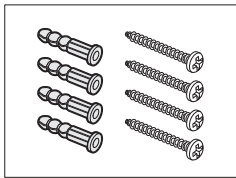
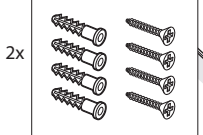
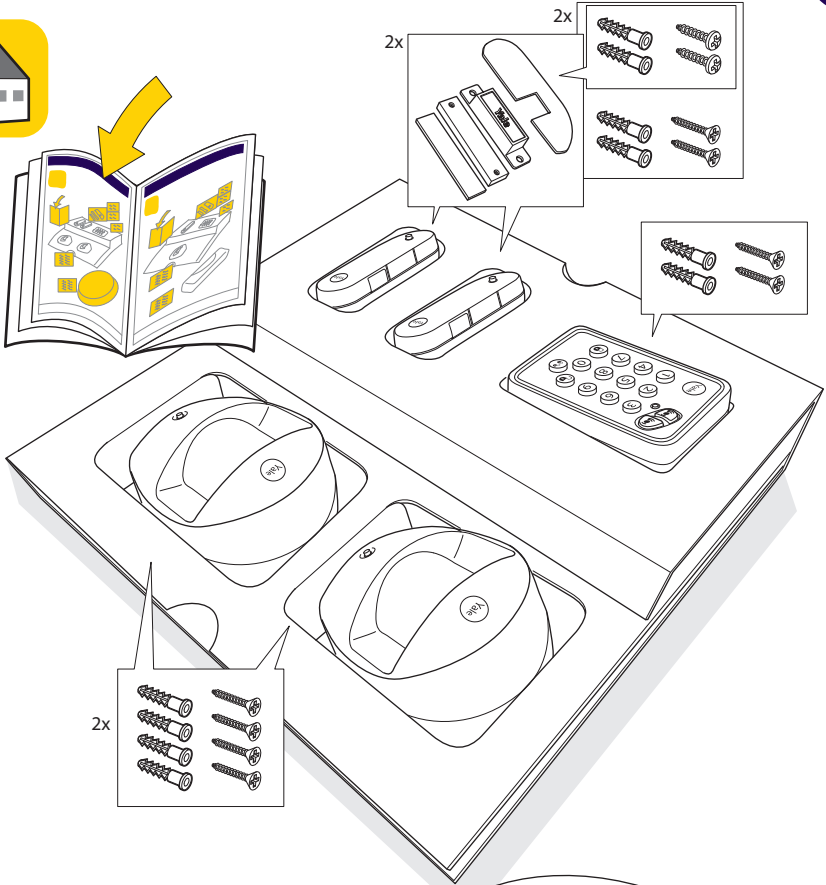

Default PIN code (0000) (1)

(1) (IT) Codice PIN predefinito - (DE) Werkscode - (NO) Forhåndsinnstilt PIN-kode - (SE) Standard PIN kod - (DK) Standard PIN kode



(GB) In the box - (IT) Nella confezione - (DE) Inhalt - (NO) Innhold i esken -
(SE) I förpackningen - (DK) Udpakning.

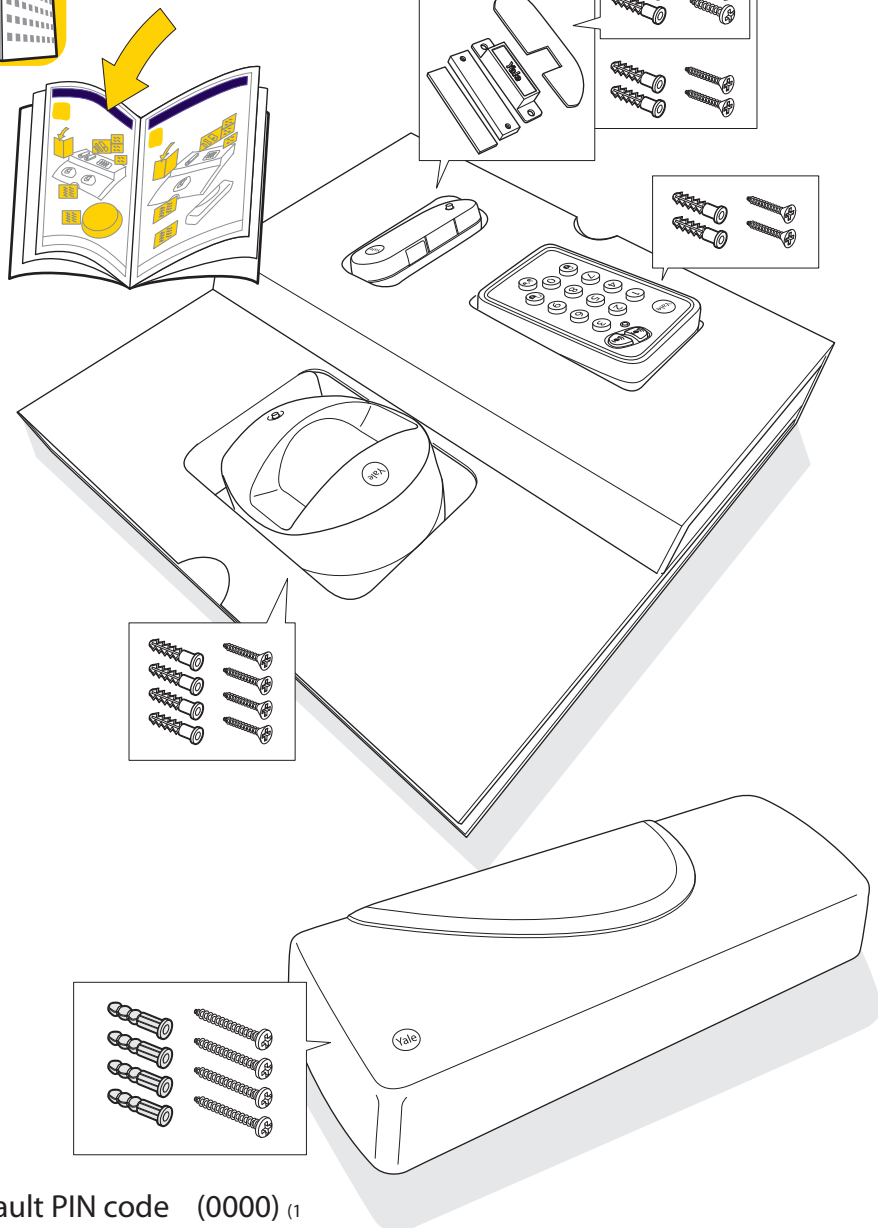

Default PIN code (0000) ⁽¹⁾

(1) (IT) Codice PIN predefinito - (DE) Werkscode - (NO) Forhåndsinnstilt PIN-kode -
(SE) Standard PIN kod - (DK) Standard PIN kode



Door/window contact (1)

Radio 868MHz FM

Movement detector PIR (2)

Radio 868MHz FM

See accessories for Pet PIR (p.19) (3)

Tamper detector (4)

Radio 868MHz FM

(1) (IT) Contatto porta/finestra - (DE) Tür-/Fensterkontakt - (NO) Dør- og vinduskontakt - (SE) Dörr/Fönster kontakt - (DK) Dør/vindue kontakt
 (2) (IT) Rilevatore movimenti - (DE) Bewegungsmelder - (NO) Bevegelsessensor - (SE) Rörelse-sensor - (DK) Bevægelses-sensor
 (3) (IT) Vedere accessori per PIR Pet (p.19) - (DE) Siehe Zubehör für Tierfreundlicher Bewegungsmelder (s.19) - (NO) Se tilbehør for husdyrssensor (s.19) - (SE) Se tillbehör, husdjurs rörelse-sensor (s.19) - (DK) Se tilbehør, husdyrs-bevægelses-sensor (s.19)
 (4) (IT) Rilevatore effrazione - (DE) Alarmleuchte - (NO) Sabotasjesalarm - (SE) Manipulerings-alarm - (DK) Destruktions-alarm



(GB) Plan your system - (IT) Prepara un piano di montaggio del tuo impianto -
 (DE) Planen Sie Ihr System - (NO) Planlegg ditt anlegg - (SE) Planlägg ditt system -
 (DK) Planlæg dit system.



Siren outside (1)

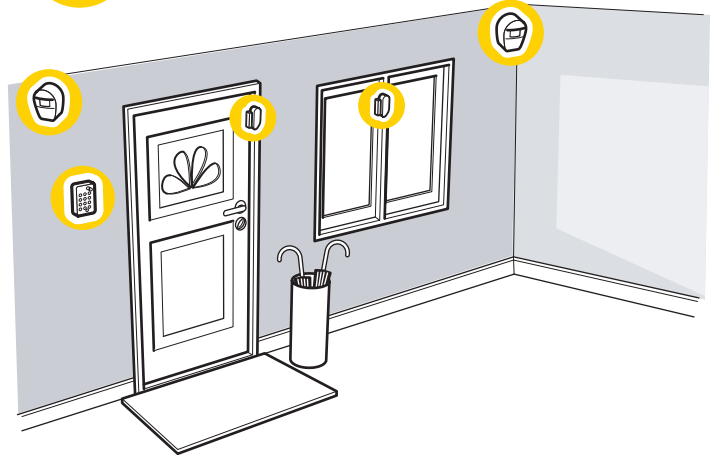

Siren inside (2)

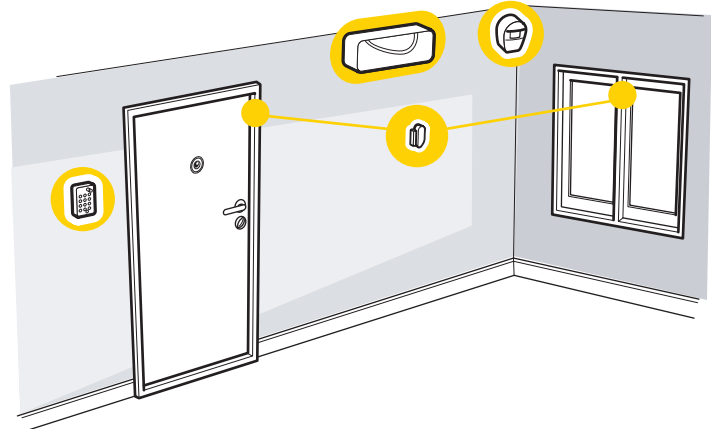

(1 (IT) Sirena esterna - (DE) Sirene draußen - (NO) Utvendig sirene - (SE) Utvändig siren -
 (DK) Udevendig sirene.

(2 (IT) Sirena interna - (DE) Sirene innen - (NO) Innvendig sirene - (SE) Invändig siren -
 (DK) Indvendig sirene



1

Start Installation with Siren (1)

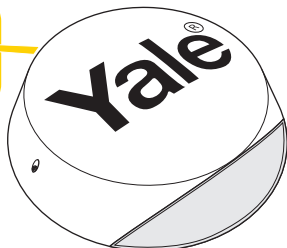

2

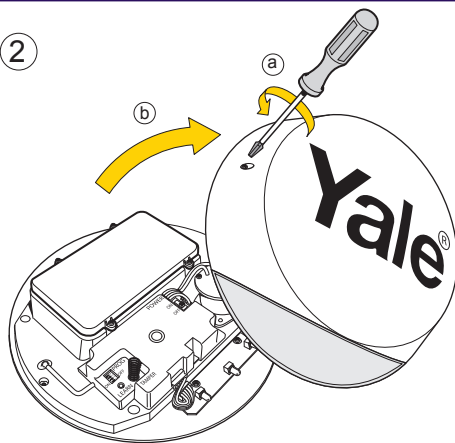

3

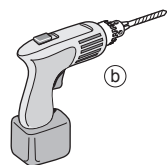

Ø 5mm

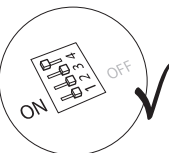
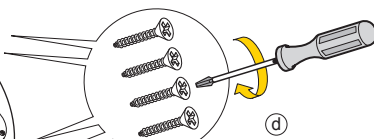
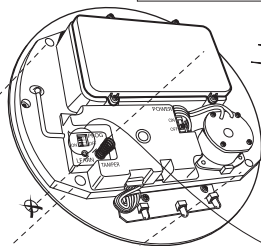
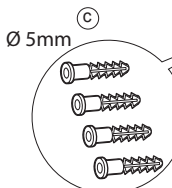

4

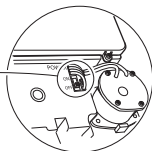
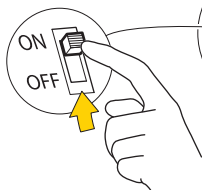

Tamper
alarm
OFF (2)



5

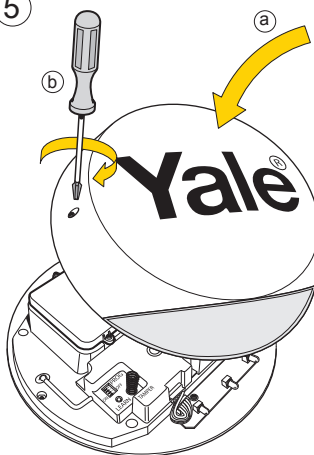

6



(1 (IT) Avvia l'installazione con sirena - (DE) Anfang: Installation der Sirene - (NO) Installer sirenen først - (SE) Installera sirenen först - (DK) Installer sirenen først.

(2 (IT) Allarme effrazione disattivato (OFF) - (DE) Sabotagealarm aus - (NO) Sabotasjesalarm deaktivert - (SE) Manipulerings-alarmet fränslaget - (DK) Destruktions-alarm slået fra.

(3 (IT) 3 ore - (DE) 3 Stunden - (NO) 3 timer - (SE) 3 timmar - (DK) 3 Timer.



Start Installation with Siren (1)

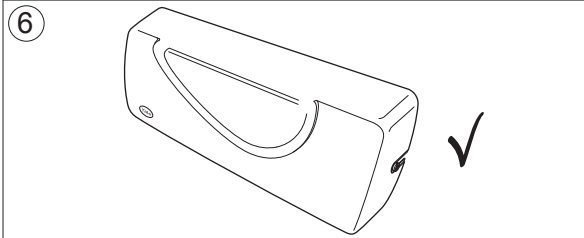
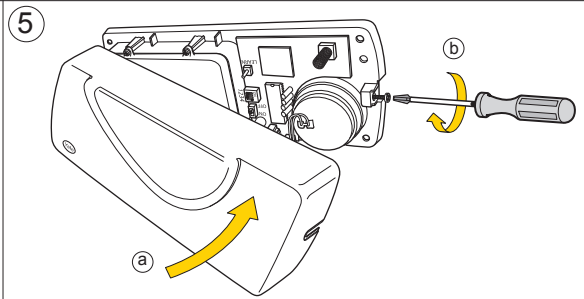
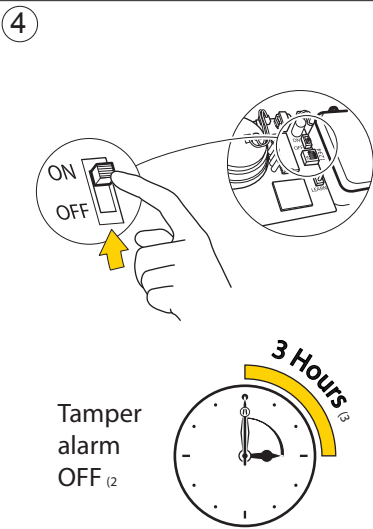
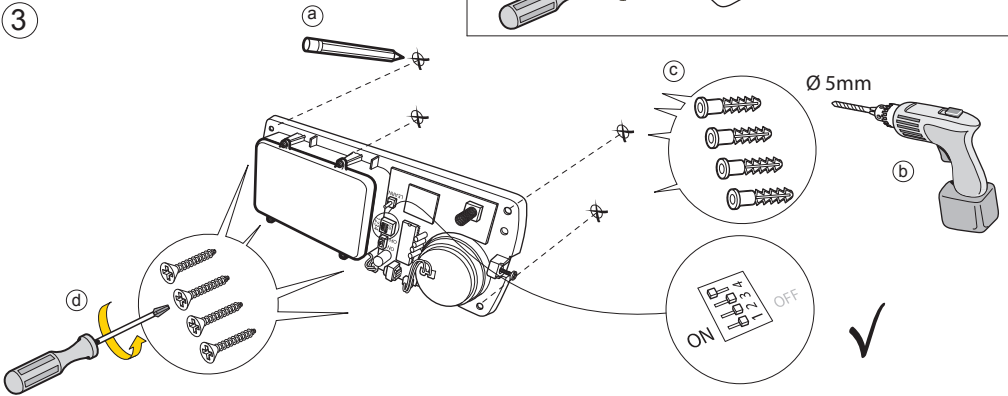
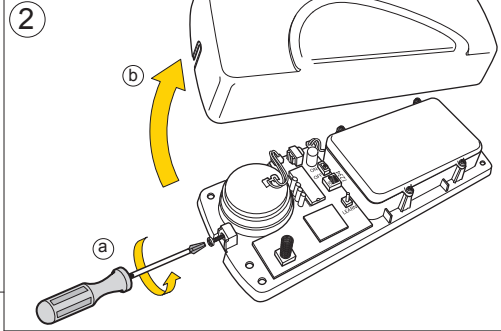
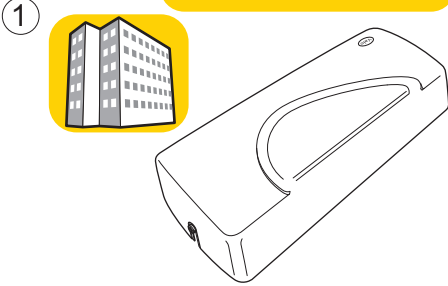

- (1 (IT) Avvia l'installazione con sirena - (DE) Anfang: Installation der Sirene - (NO) Installer sirenen først - (SE) Installera sirenen först - (DK) Installer sirenen først.
- (2 (IT) Allarme effrazione disattivato (OFF) - (DE) Sabotagealarm aus - (NO) Sabotasjesalarm deaktivert - (SE) Manipulerings-alarmet frånslaget - (DK) Destruktions-alarm slået fra.
- (3 (IT) 3 ore - (DE) 3 Stunden - (NO) 3 timer - (SE) 3 timmar - (DK) 3 Timer.



Remove battery strips (1)

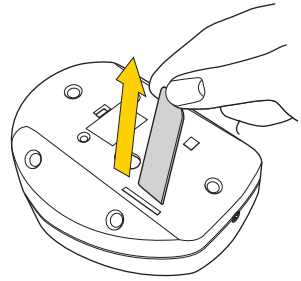
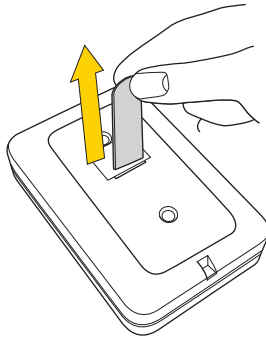
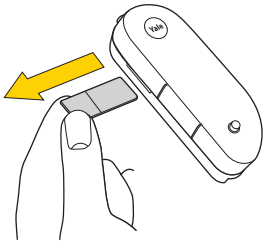

Test your planned location of components (2)

~30 m

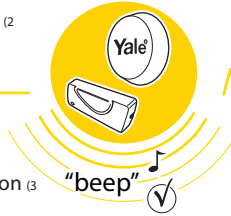

Press button to test connection (3)

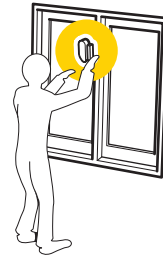
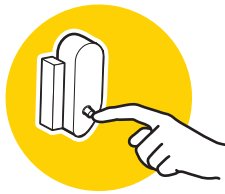

Test location for stable radio performance (4)

(1 (IT) Rimuovi strisce batteria - (DE) Entfernen der Batteriefolie - (NO) Fjern papirstripen på batteriet - (SE) Ta bort batterisparfilken - (DK) Fjern batteri-strimmel

(2 (IT) Esegui un test della posizione programmata dei componenti - (DE) Testen Sie Ihren gewählten Standort - (NO) Test plasseringen av komponenten - (SE) Testa tilltänkta placeringen av sensorerna - (DK) Test komponent placering

(3 (IT) Premi il pulsante per eseguire un test della connessione - (DE) Drücken Sie den Knopf um die Verbindung zu Testen - (NO) Trykk på knappen for å teste forbindelse - (SE) Tryk knapp for test av förbindelse - (DK) Tryk knapp for test af forbindelse.

(4 (IT) Esegui un test della posizione per una prestazione radio stabile - (DE) Testen Sie den Standort für eine stabile Übertragung - (NO) Test plassering i forhold til stabilitet av de trådløse signalene - (SE) Testa radiolåmken för sensorerna - (DK) Test radio-kontakt for komponenter

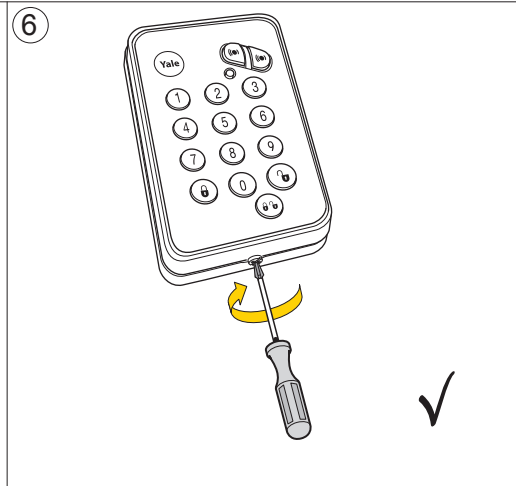
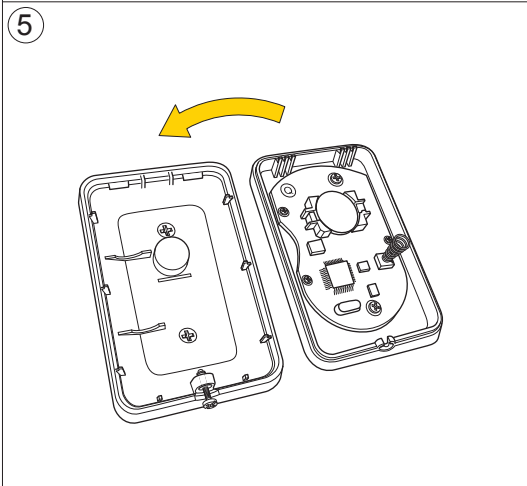
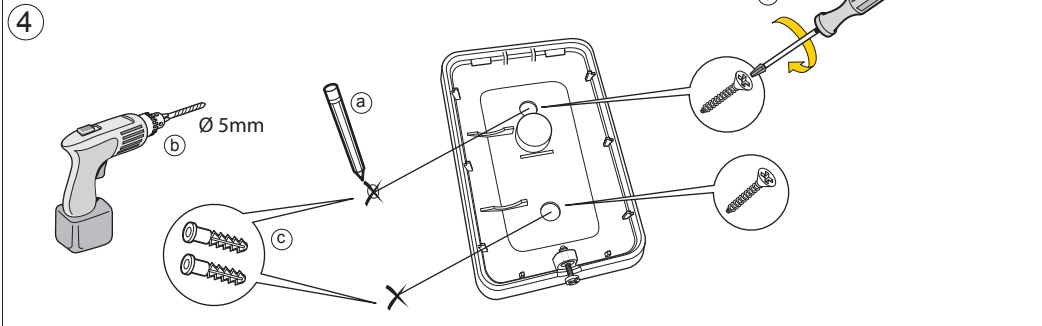
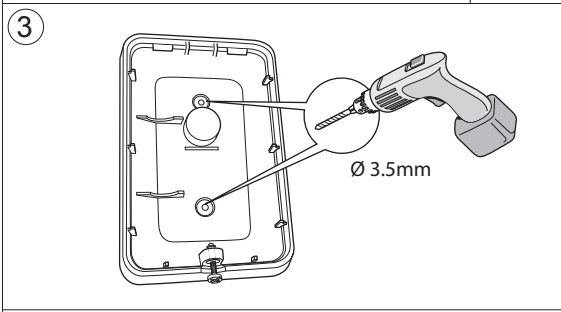
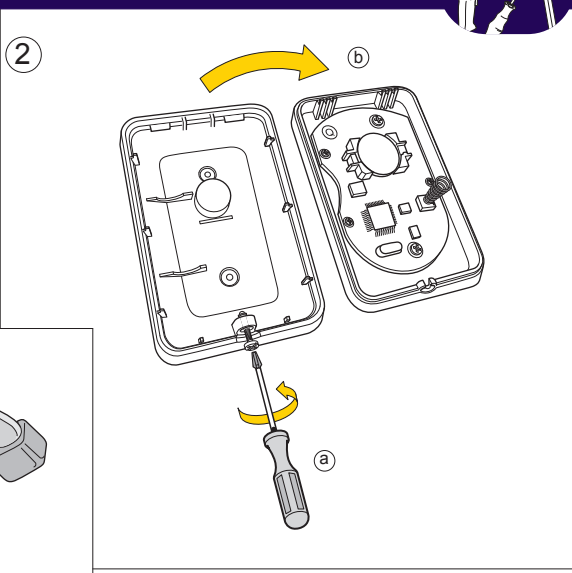

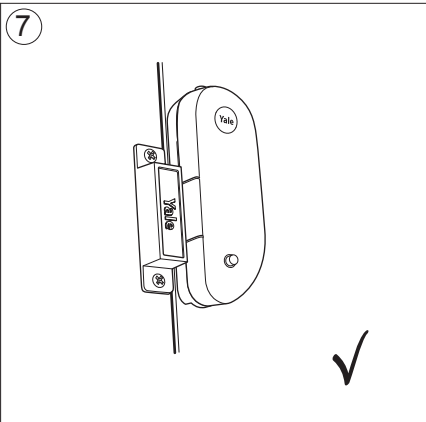
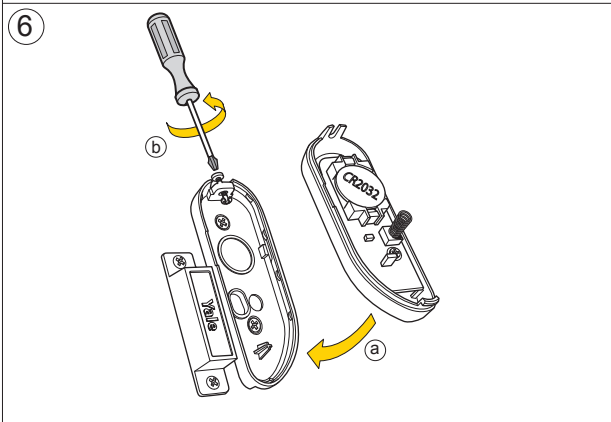
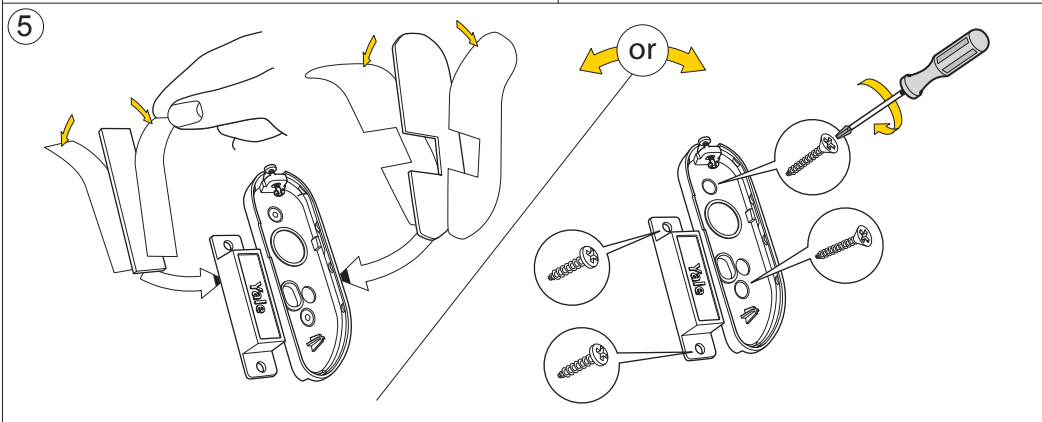
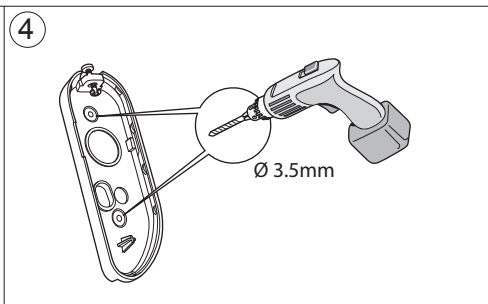
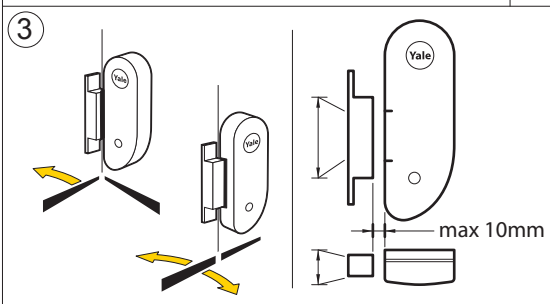
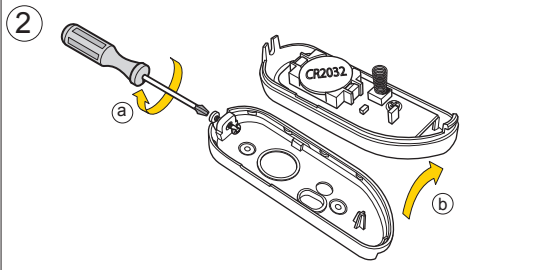
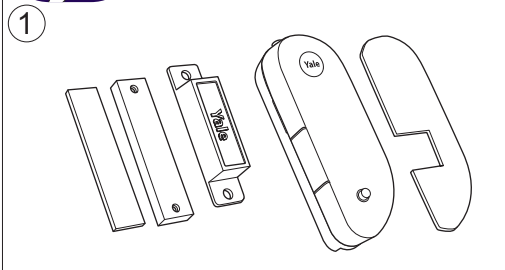

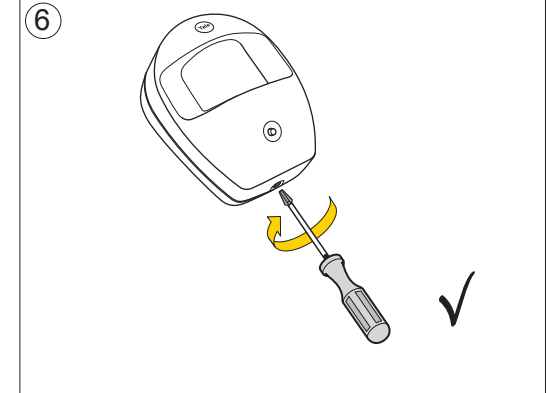
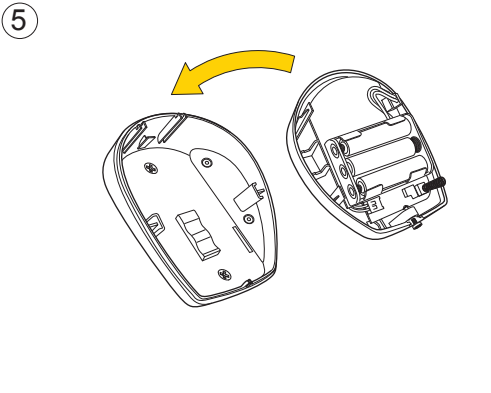
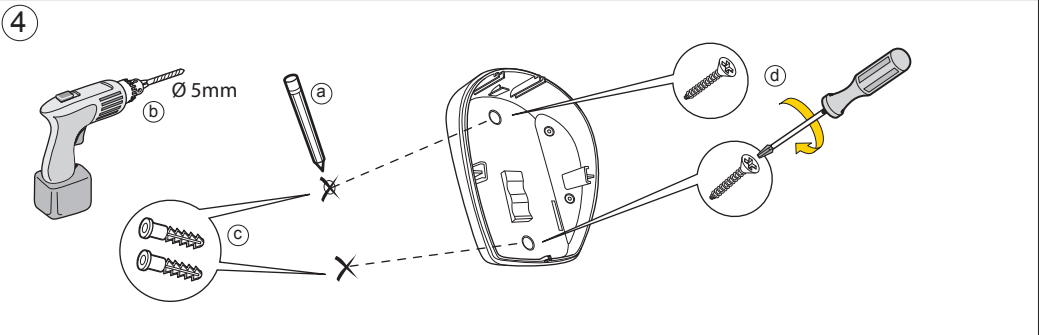
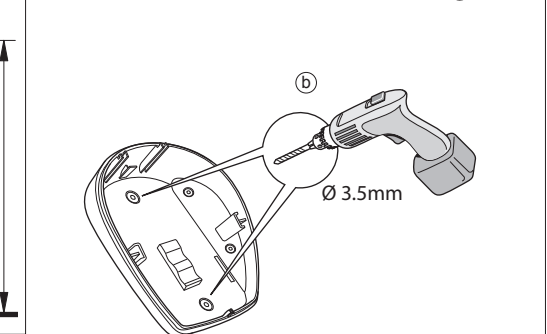
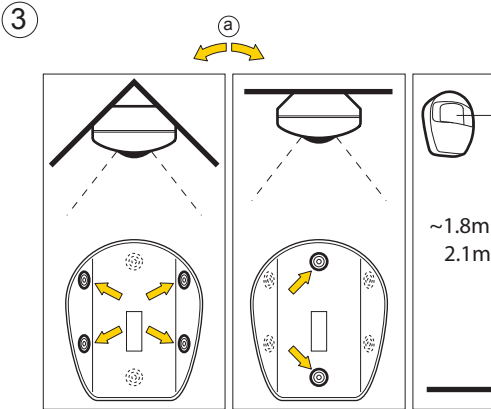
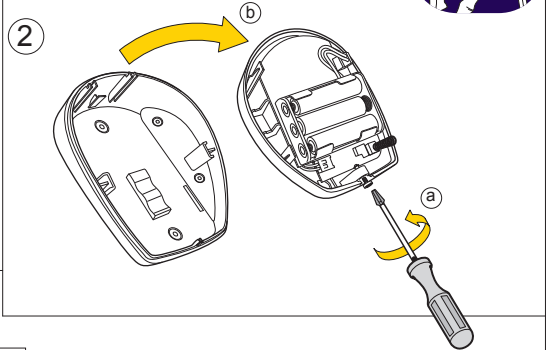
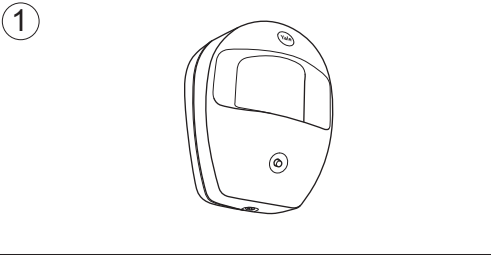



Changing PIN code (1)

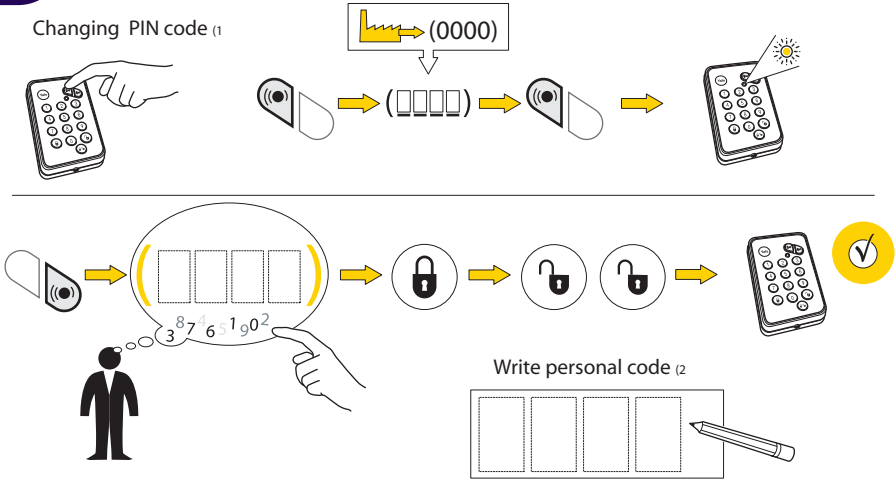

Leaving home / Turn alarm ON (3)



Coming home / Turn alarm OFF (4)

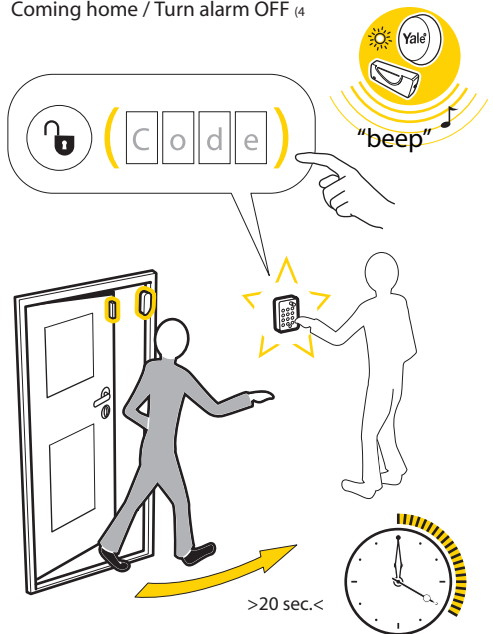

(1 (IT) Utilizzo dell'impianto - (DE) Nutzung des Systems - (NO) Bruk av anlegget - (SE) Använda systemet - (DK) Indstilling af system.

(2 (IT) Modifica codice PIN - (DE) PIN Code ändern - (NO) Endre PIN-kode - (SE) Ändra PIN kod - (DK) Ændre PIN kode.

(3 (IT) Immetti codice personale - (DE) Geben Sie Ihren persönlichen Code ein - (NO) Tast inn personlig kode - (SE) Tryck in personlig kod - (DK) Tast personlig kode.

(4 (IT) All'uscita da casa/Attiva l'allarme (ON) - (DE) Beim Verlassen: Schalten Sie den Alarm ein - (NO) Når du går ut / Aktiver alarmen - (SE) Går hemifrån / Aktivera larmet - (DK) Forlad hjemmet / aktiver alarm.

(5 (IT) Al rientro a casa/Disattiva l'allarme (OFF) - (DE) Nach Hause kommen: Schalten Sie den Alarm aus - (NO) Når du kommer hjem / Deaktiverer alarmen - (SE) Kommer hem / stäng av larmet - (DK) Kommer hjem / deaktiver alarm.



Alarm goes off (1)

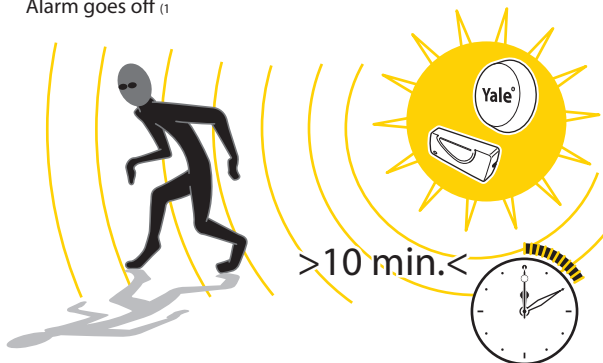

Turn alarm OFF (2)

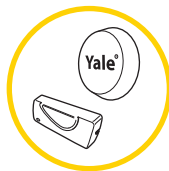
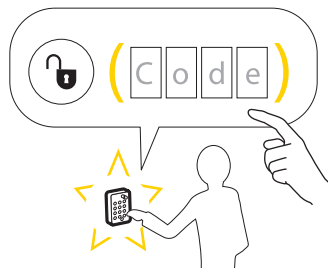

Coming home.
Alarm has been triggered
while not at home (3)

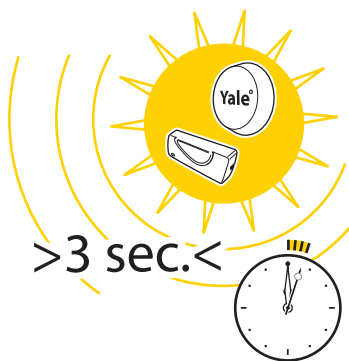

(1 (IT) Attivazione dell'allarme - (DE) Alarm geht aus - (NO) Alarm utløses - (SE) Alarmet aktiveras - (DK) Alarm går i gang.

(2 (IT) Disattiva allarme (OFF) - (DE) Alarm ausschalten - (NO) Skru alarmen av - (SE) Stäng av larmet - (DK) Sluk alarm.

(3 (IT) Rientro a casa È scattato l'allarme mentre non si era in casa. -

(DE) Nach Hause kommen. Alarm wurde ausgelöst, während Sie nicht zu Hause waren. -

(NO) Når du kommer hjem. Alarmen har vært utløst når du har vært borte. -

(SE) Kommer hem. Alarmet har varit aktiverat. - (DK) Kommer hjem. Allarm har været aktiveret.

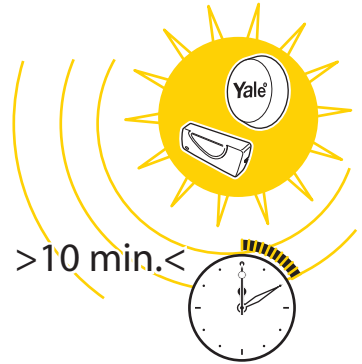
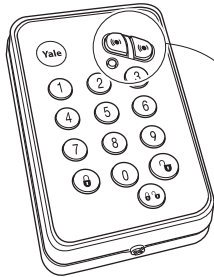

>3sec.<

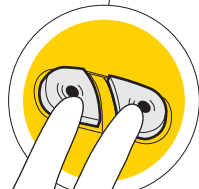

Panic button (1)

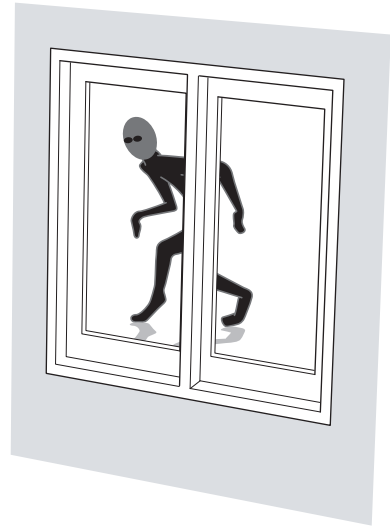

Turn alarm OFF (2)

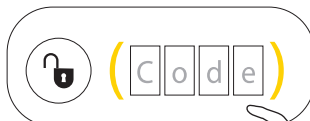

(1) (IT) Pulsante antipanico - (DE) Panikknopf - (NO) Panikknapp - (SE) Panik knapp - (DK) Panik-knap.
(2) (IT) Disattiva allarme (OFF) - (DE) Alarm ausschalten - (NO) Skru av alarmen - (SE) Stänga av larmet - (DK) Sluk alarm.



Low battery

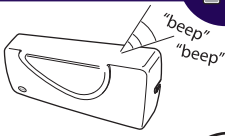

Code



2

"Tamper alarm OFF" (1)

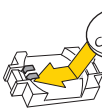
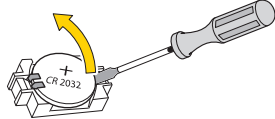
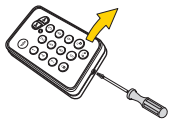

CR2032

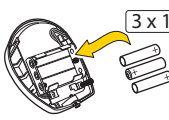
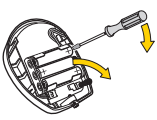
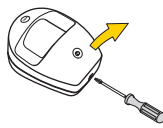

3 x 1.5v AAA

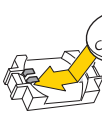
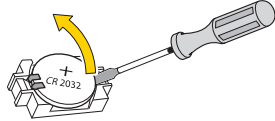
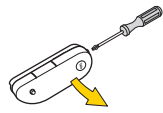
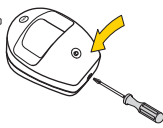

CR2032

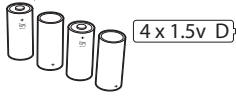
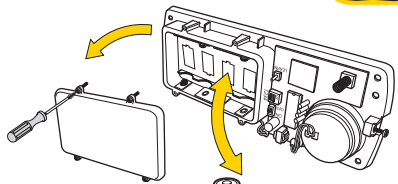
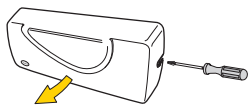
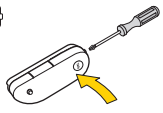

4 x 1.5v D

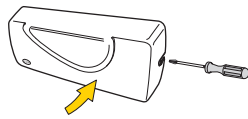

4 x 1.5v D

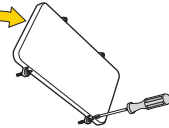
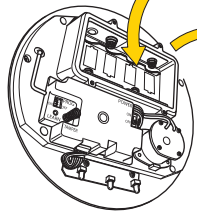

3

b b

"Tamper alarm ON" (2)

(1 (IT) Allarme effrazione disattivato (OFF) - (DE) Sabotagealarm aus - (NO) Sabotasjesalarm deaktivert - (SE) Manipulationslarmet OFF - (DK) Destruktions-alarm slået fra.
(2 (IT) Allarme effrazione attivato (ON) - (DE) Sabotagealarm an - (NO) Sabotasjesalarm aktivert - (SE) Manipulationslarmet ON - (DK) Destruktions-alarm slået til.



Keyfob (1)



Leaving home (2)



Coming home (3)



Radio 868MHz FM

Smoke alarm (4)

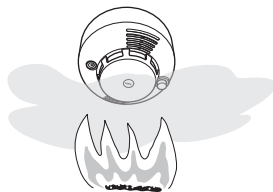
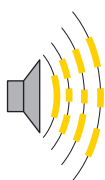
Tested to EN54
Radio 868MHz FM

Panic button (5)



Radio 868MHz FM

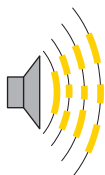

>3sec.<



Pet PIR (6)

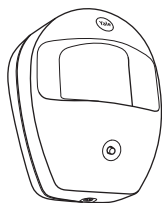

Radio 868MHz FM

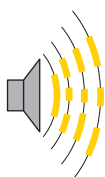
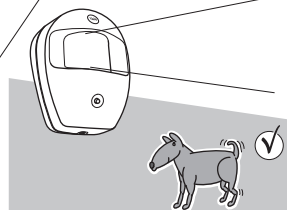
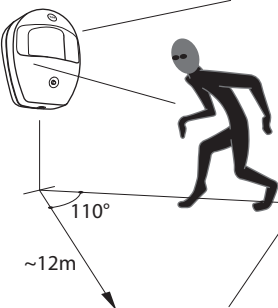
2,1m
1,8m

(1) (IT) Telecomando - (DE) Fernbedienung - (NO) Fjernkontroll - (SE) Nyckelrings fjärr - (DK) Fjernbetjening.

(2) (IT) All'uscita da casa/Attiva l'allarme (ON) - (DE) Beim Verlassen/ Alarm anschalten - (NO) Når du går ut / Aktiver alarmen - (SE) Går hemifrån / Aktivera larmet - (DK) Forlad hjemmet / aktiver alarm.

(3) (IT) Al rientro a casa/Disattiva l'allarme (OFF) - (DE) Nach Hause kommen/ Alarm ausschalten - (NO) Når du kommer hjem / Deaktiver alarmen - (SE) Kommer hem / stäng av larmet - (DK) Kommer hjem / deaktiver alarm.

(4) (IT) Sensore fumo - (DE) Rauchmelder - (NO) Røykvarsler - (SE) Röklarm - (DK) Røg alarm.

(5) (IT) Pulsante antipanico - (DE) Panikknopf - (NO) Panikknapp - (SE) Panik knapp - (DK) Panik-knap.

(6) (IT) PIR animale domestico - (DE) Tierfreundlicher Bewegungsmelder - (NO) Husdyrssensor - (SE) Husdjurs rörelsedetektor - (DK) Husdyrs PIR.



Adding new devices (1)

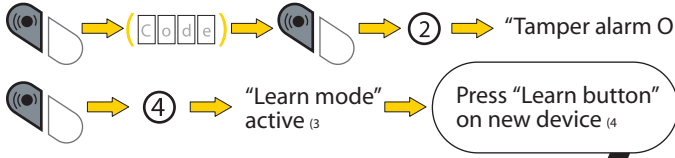

Smoke alarm (5)

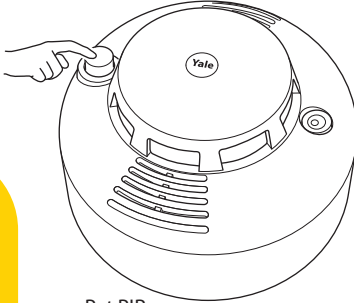

Panic button (6)

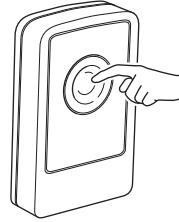

Keyfob (7)

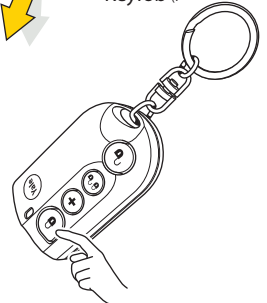

Pet PIR (8)

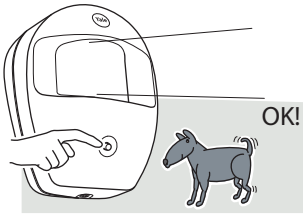

Standard door/window contact (9)

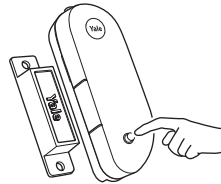

Standard PIR (10)

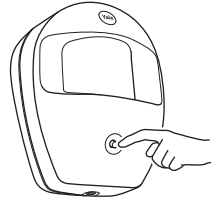

beep

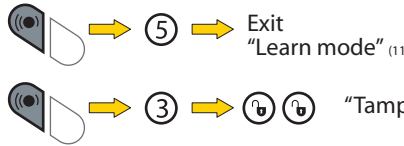
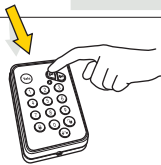

(1 (IT) Aggiunta di un nuovo dispositivo all'impianto - (DE) Hinzufügen neuer Geräte - (NO) Legg til nye komponenter til anlegget - (SE) Lägg till nytt tillbehör till systemet - (DK) Tilføj udstyr til system

(2 (IT) Allarme effrazione disattivato (OFF) - (DE) Sabotagealarm aus - (NO) Sabotasjesalarm deaktivert - (SE) Manipulationslarmet OFF - (DK) Destruktions-alarm slået fra

(3 (IT) Modalità apprendimento attiva - (DE) Lernmodus aktiv - (NO) "LEARN"-modus for programmering av ny komponent aktivert - (SE) Parnings läge aktiverat - (DK) Ny komponent indlæring aktiveret

(4 (IT) Premi il pulsante "Learn" sul nuovo dispositivo - (DE) Drücken Sie "Lern" Knopf auf dem Gerät - (NO) Trykk på "LEARN"-knappen på komponenten - (SE) Tryck inlärningsknappen på tillbehöret - (DK) Tryk på "LEARN" knap på komponent

(5 (IT) Sensore fumo - (DE) Rauchmelder - (NO) Røykvarsler - (SE) Röklarm - (DK) Røg alarm

(6 (IT) Pulsante antipanico - (DE) Panikknopf - (NO) Panikknapp - (SE) Panik knapp - (DK) Panik-knapp

(7 (IT) Portachiavi - (DE) Fernbedienung - (NO) Fjernkontroll - (SE) Nyckelrings fjärr - (DK) Nøglerings-fjernbetjening

(8 (IT) PIR pet - (DE) Tierfreundlicher Bewegungsmelder - (NO) Husdyrssensor - (SE) Husdjurs rörelsedetektor - (DK) Husdyrs PIR

(9 (IT) Contatto porte/finestre standard - (DE) Standart Tür/ Fenster Schalter - (NO) Standard dør- og vinduskontakt - (SE) Dörr / Fönster kontakt - (DK) Standard dør/vindue-kontakt

(10 (IT) PIR standard - (DE) Standard Bewegungsmelder - (NO) Standard bevegelsessensor - (SE) Standard rörelsedetektor - (DK) Standard PIR

(11 (IT) Esci dalla "Modalità apprendimento" - (DE) "Lern Modus" beenden - (NO) Avslutt "LEARN"-modus - (SE) Gå ur parnings läget - (DK) Indlæring slået fra

(12 (IT) Allarme effrazione attivato (ON) - (DE) Sabotagealarm anschalten - (NO) Sabotasjesalarm aktivert - (SE) Manipulationslarmet ON - (DK) Destruktions-alarm slået til



Low battery

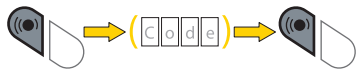
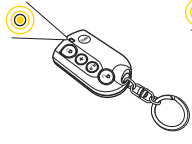
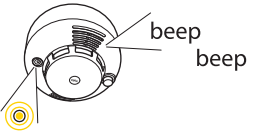

"Tamper alarm OFF" (1)

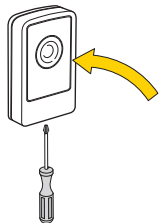
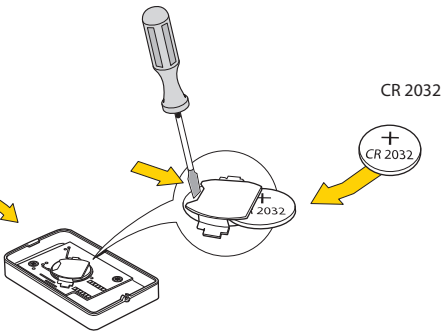
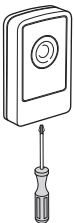
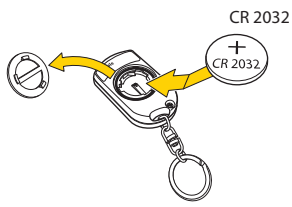
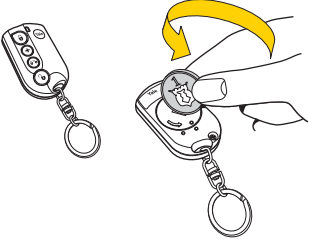
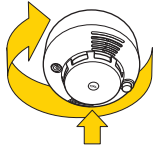
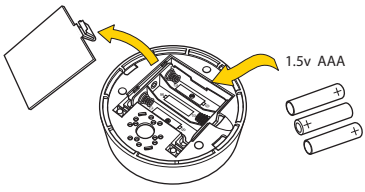
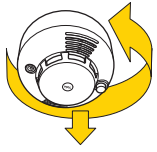

"Tamper alarm ON" (2)

(1 (IT) Allarme effrazione disattivato (OFF) - (DE) Sabotagealarm ausschalten - (NO) Sabotasjesalarm deaktivert - (DWE) Manipulationslarmet OFF - (DK) Destruktions-alarm slæet fra.
(2 (IT) Allarme effrazione attivato (ON) - (DE) Sabotagealarm einschalten - (NO) Sabotasjesalarm aktivert - (SE) Manipulationslarmet ON - (DK) Destruktions-alarm slæet til.

(GB) Resetting components - (IT) Ripristino componenti - (DE) Zurücksetzen der Geräte -
 (NO) Nullstilling av komponenter - (SE) Nollställning av komponenter -
 (DK) Nulstilling af komponenter

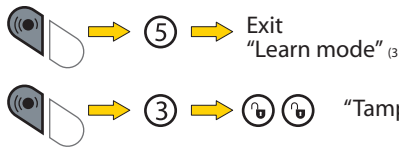
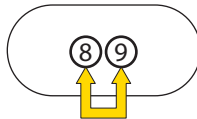
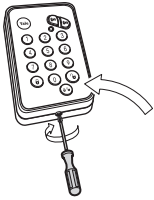
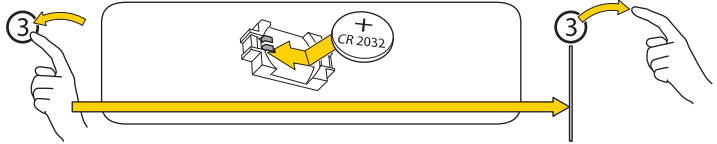
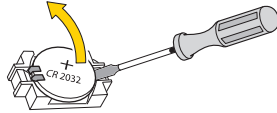
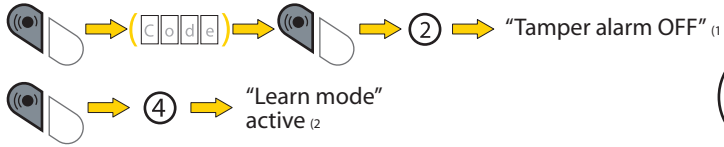

Code has been reset to factory default. (0000)
 See page (16) for setting up personal code (5)



(1) (IT) Allarme effrazione disattivato (OFF) - (DE) Sabotagealarm ausschalten - (NO) Sabotasjesalarm deaktivert - (SE) Manipulationslarmet OFF - (DK) Destruktions-alarm slået fra.

(2) (IT) Modalità apprendimento attiva - (DE) Lern Modus aktivieren - (NO) "LEARN"-modus aktivert - (SE) Parnings läge aktiverat - (DK) Ny komponent indlæring aktiveret.

(3) (IT) Allarme effrazione disattivato (OFF) - (DE) Sabotagealarm ausschalten - (NO) Sabotasjesalarm deaktivert - (SE) Manipulationslarmet OFF - (DK) Destruktions-alarm slået fra.

(4) (IT) Allarme effrazione attivato (ON) - (DE) Sabotagealarm einschalten - (NO) Sabotasjesalarm aktivert - (SE) Manipulationslarmet ON - (DK) Destruktions-alarm slået til.

(5) (IT) Il codice è stato ripristinato all'impostazione predefinita di fabbrica Vedi il pagina (16) per l'impostazione del codice personale - (DE) Code ist auf die Werkseinstellungen zurückgesetzt. Für persönliche Codeeinstellung siehe Seite (16). - (NO) Kode er tilbakestillt til fabrikkinnstilling. Se eget side (16) for programmering av personlig kode. - (SE) Kod har blivit satt till fabriks inställning (0000) Se sida (16) för sätta personlig kod. - (DK) Kode sat til standard (0000) Se side (16), for indstilling af personlig kode.



(GB) Resetting components - (IT) Ripristino componenti - (DE) Zurücksetzen der Geräte -
 (NO) Nullstilling av komponenter - (SE) Nollställning av komponenter -
 (DK) Nulstilling af komponenter.

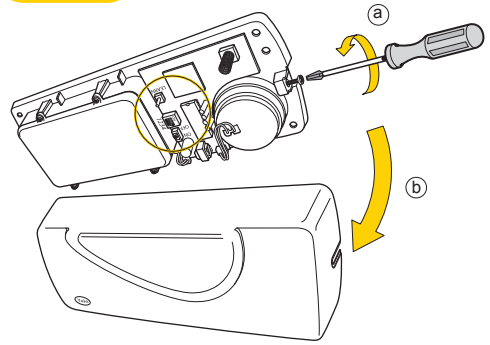
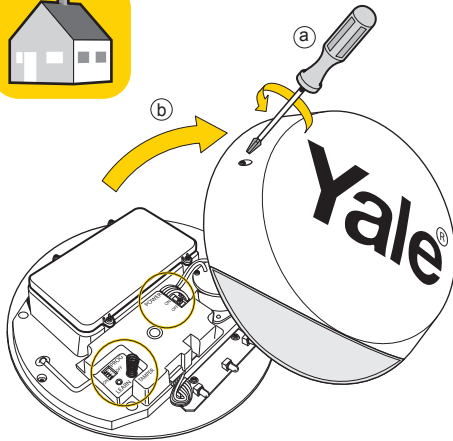
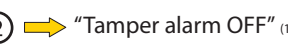

①

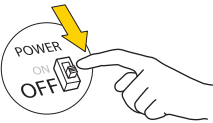

②



③



④



⑤

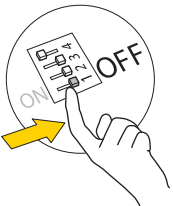

(GB) SIREN has been reset. ALL devices have to be LEARNED again.
 See page (21) for adding components.

(IT) La SIRENA è stata reimpostata. Tutti i dispositivi devono essere nuovamente INDIVIDUATI. Vedi il pagina (21) per l'aggiunta di componenti.

(DE) Die Sirene wurde zurückgesetzt. Alle Geräte müssen neu angelernt werden.
 Siehe Seite (21) Hinzufügen von Geräten.

(NO) SIRENEN er nullstilt / ALLE komponenter må settes opp på nytt.
 Se eget side (21) for tilkobling av tilleggskomponenter.

(SE) Sirenen har blivit nollställd / Alla komponenter måste paras in igen.
 Se sida (21)

(DK) SIRENEN er nulstillet / ALLE komponenter skal indlæres igen.
 Se side (21) for tilkobling af komponenter.

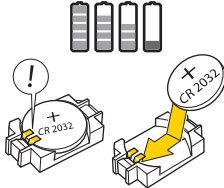

	<p>(GB) Turn tamper alarm OFF before removing covers. See chap. (6) (IT) Disattiva allarme effrazione (OFF) prima di rimuovere i coperchi. Vedi cap. (6) (DE) Schalten Sie den Sabotagealarm aus, bevor Sie die Abdeckung abnehmen. Siehe Kap. 6 (NO) Deaktiver sabotasjesalarmen før deksler fjernes (ref. kapittel 6). (SE) Slå av manipulationslarmet innan kåpan monteras av. Se kapitel 6 (DK) Slå destruktions-alarm fra, før dæksler afmonteres.</p>
<p>(GB) Alarm test (IT) Test allarme (DE) Alarmtest (NO) Alarm test (SE) Alarm test (DK) Alarm test</p>	<p>(GB) Arm system and interrupt sensors, one at a time. (IT) Aziona l'impianto di allarme e interrompi i sensori uno alla volta. (DE) Schalten Sie das System scharf und unterbrechen Sie den Sensor gleichzeitig. (NO) Aktiver Innbruddsalarmen og aktiver en komponent om gangen. (SE) Slå på alarmet och aktivera varje sensor en efter en. (DK) "Slå destruktions-alarm til og aktiver en komponent ad gangen."</p>
<p>(GB) Alarm not responding (IT) Allarme non risponde (DE) Alarm reagiert nicht (NO) Alarm svarer ikke (SE) Larm svarar inte (DK) Alarm reagerer ikke</p>	<p>(GB) Check batteries (IT) Controlla batterie (DE) Prüfen der Batterien (NO) Sjekk batterier (SE) Kontrollera batterierna (DK) Kontroller batterier</p> 
<p>(GB) Alarm "beeps" 5 times when armed. (IT) Allarme "suona" 5 volte quando attivato. (DE) Alarm "piept" 5-mal wenn sie aktiviert ist. (NO) Alarm "piper" 5 ganger når den aktiveres. (SE) Larm "pip" 5 gånger när den aktiveras. (DK) Alarm "bipper" 5 gange når den aktiveres.</p>	<p>(GB) Tamper alarm has been Interrupted. Check loose covers or wall attachment. Siren low battery. (IT) L'allarme effrazione è stato interrotto. Controlla agganci parete o coperchi lenti. Batteria Siren basso. (DE) Der Sabotagealarm wurde unterbrochen. Prüfen Sie die Abdeckungen. Siren Batterie schwach. (NO) Sabotasjesalarmen har vært utløst. Sjekk om dekslene eller veggfestene er løse. Siren har lavt batteri. (SE) Manipulationslarmet har varit aktiverat. Kolla lösa kåpor eller väggfästen. Siren låg batterinivå. (DK) Destruktions-alarm har været aktiveret. Kontroller vægmontage og dæksler. Sirene lavt batteriniveau.</p>
<p>(GB) Forgotten PIN code (IT) Codice PIN dimenticato (DE) PIN-Code vergessen (NO) Glemmt PIN-kode (SE) Glömt PIN-kod (DK) Glemmt PIN-kode</p>	<p>(GB) Reset keypad. See page. (23) (IT) Reimposta tastierino numerico Vedi pagina (23) (DE) Tastatur zurücksetzen. Siehe Seite (23) (NO) Nullstill tastaturet eller fjernkontrollen (ref. side 23) (SE) Nollställ manöverpanel, se sida (23) (DK) Nulstil tastatur/keypad. Se side (23)</p>
<p>(GB) False alarm (IT) Falso allarme (DE) Fehlalarm (NO) Falsk alarm (SE) Falskt alarm (DK) Falsk alarm</p>	<p>(GB) PIR pointing at moving or heated object, like pets, sun spots or woodburners. (IT) PIR rivolto verso oggetto in movimento o aree calde come animali domestici, aree riscaldate dai raggi solari o camini. (DE) Bewegungsmelder zeigt auf bewegte oder heiße Objekte, wie Tiere oder Sonnenstrahlen. (NO) Bevegelsessensor er rettet mot objekter i bevegelse, varme objekter, husdyr, soloppvarmede vegger/objekter, varmeovner, etc. (SE) Rörelsedeckaren pekar mot objekt som rör sig eller är uppvärmt, som husdjur, solvärm område eller spis. (DK) PIR reagerer på bevægelse, varmt objekt, husdyr, solopvarmet område, ovn.</p>



ASSA ABLOY Ltd.
School Street, Willenhall
West Midlands
England, WV13 3PW

EC Declaration of Conformity

We: **ASSA ABLOY Ltd**
School Street, Willenhall
West Midlands
England, WV13 3PW

Declare under our sole responsibility that the following product(s):

Yale Model:	SR-PIR	EF-PIR
	SR-PETPIR	EF-PETPIR
	SR-DC	EF-DC
	SR-KF	EF-KF
	SR-KP	EF-KP
	SR-PB	EF-PB
	SR-SD	EF-SD
	SR-BX	EF-BX
	SR-PC	EF-SKINT
	SR-PVC	EF-PANEL
	SR-PS	EF-IPBOX
	SR-RS	EF-INTBOX
	SR-SR	EF-Easy Fit Alarm Kits
	SR-EIR	
	SR-SR	
	SR-W5	
	SR-CO	
	SR-HUB	
	SR-HUL	
	SR-HSL	
	SR-MZ8	
	SR- Smart Home Alarm kits	
	SR- Standard Alarm kits	
	SR-Smartphone Alarm kits	

Is (are) in conformity with the following relevant harmonized standards:

EN 300-220-1 / v 2.4.1 (2012)
EN 300-220-2 / v 2.4.1 (2012)
EN 301-489-1 / v 1.9.2 (2012)
EN 301-489-3 / v 1.6.1 (2012)
EN 60950-1 / 2006 + A11: 2009 + A1: 2010 + A12: 2011 + A2: 2013

Following the provisions of Council Directive 1999/5/EC on radio equipment and telecommunications terminal equipment and the mutual recognition of their conformity.

Name: **Nigel Fisher** Position: **Director**

Signature:  Date: 03/03/2016

On behalf of ASSA ABLOY Ltd.

(GB) Environment - (IT) Ambiente - (DE) Umgebung - (NO) Miljø - (SE) Miljö - (DK) Miljø.

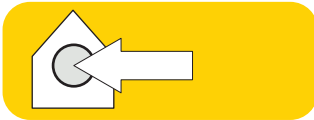

All devices

Housings ABS/polycarbonate



-10°C to 40°C



70%

(IT) Involucro di TUTTI i dispositivi ABS/polycarbonato
(DE) Alle Geräte , Gehäuse ABS Polycarbonat
(NO) ALLE komponenter. Deksel av ABS/polykarbonat
(SE) Alla komponenter Plasthölje ABS/Polycarbonat
(DK) Alle komponenter ABS/polycarbonat

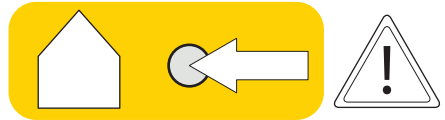

Outdoor Siren



-20°C to 50°C



95%

(IT) Sirena esterna
(DE) Außensirene
(NO) Utendørs sirene
(SE) Utomhus siren
(DK) Udendørs sirene.

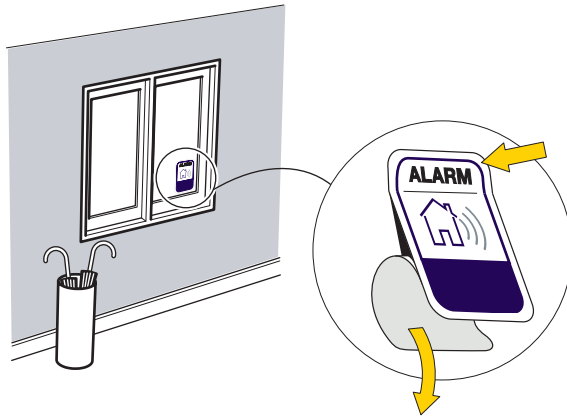

RoHS

THE YALE BRAND, with its unparalleled global reach and range of products, reassures more people in more countries than any other consumer locking solution.

THE ASSA ABLOY GROUP is the world's leading manufacturer and supplier of locking solutions, dedicated to satisfying end-user needs for security, safety and convenience.

An ASSAABLOY Group brand

ASSA ABLOY

Standard-Alarm-MI-V12