

# 3216 Chip antenna

For Bluetooth / WLAN Applications

P/N: RANT3216F245M02

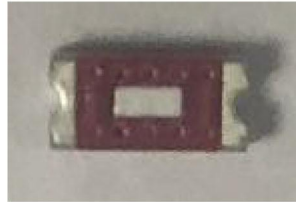

|   | Dimension (mm) |
|---|----------------|
| L | 3.23 ± 0.20    |
| W | 1.66 ± 0.20    |
| T | 1.23 ± 0.20    |

## Part Number Information

RANT    3216    F    245    M    02  
 A            B            C            D            E            F

|          |                          |                                      |
|----------|--------------------------|--------------------------------------|
| <b>A</b> | <b>Product Series</b>    | <b>Antenna</b>                       |
| <b>B</b> | <b>Dimension L x W</b>   | <b>3.2X1.6mm (+-0.2mm)</b>           |
| <b>C</b> | <b>Material</b>          | <b>High K material</b>               |
| <b>D</b> | <b>Working Frequency</b> | <b>2.4 ~ 2.5GHz</b>                  |
| <b>E</b> | <b>Feeding mode</b>      | <b>Monopole &amp; Single Feeding</b> |
| <b>F</b> | <b>Antenna type</b>      | <b>Type=02</b>                       |

## 1. Electrical Specification

| Specification                 |                    |      |
|-------------------------------|--------------------|------|
| Part Number                   | RANT3216F245M02    |      |
| Central Frequency             | 2450               | MHz  |
| Bandwidth                     | 100 (Min.)         | MHz  |
| Return Loss                   | -6.5 (Max)         | dB   |
| Peak Gain                     | 3                  | dBi  |
| Impedance                     | 50                 | Ohm  |
| Operating Temperature         | -40 ~ +85          | °C   |
| Maximum Power                 | 4                  | W    |
| Resistance to Soldering Heats | 10 ( @ 260°C)      | sec. |
| Polarization                  | Linear             |      |
| Azimuth Beamwidth             | Omni-directional   |      |
| Termination                   | Cu / Sn (Leadless) |      |

## 2. Recommended PCB Pattern

### Evaluation Board Dimension

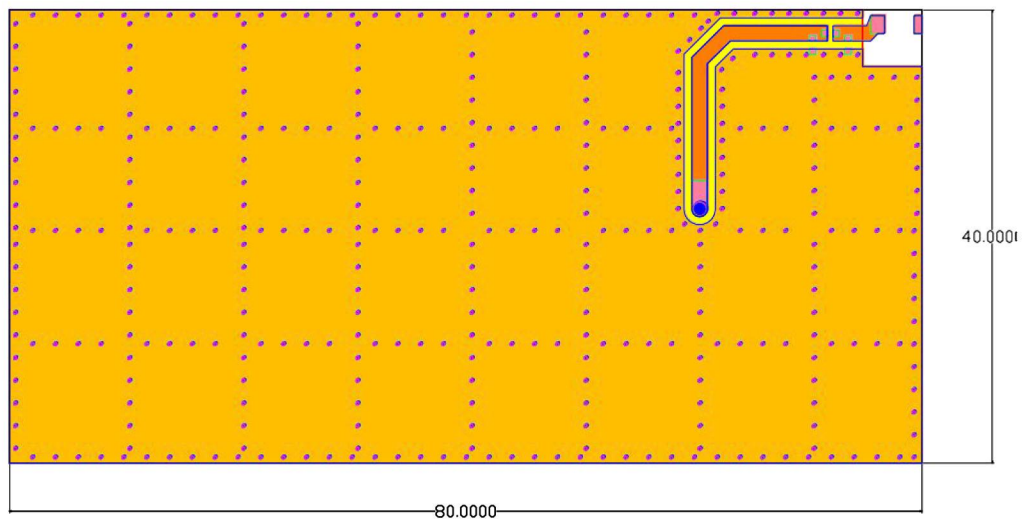

Unit : mm



### Suggested Matching Circuit

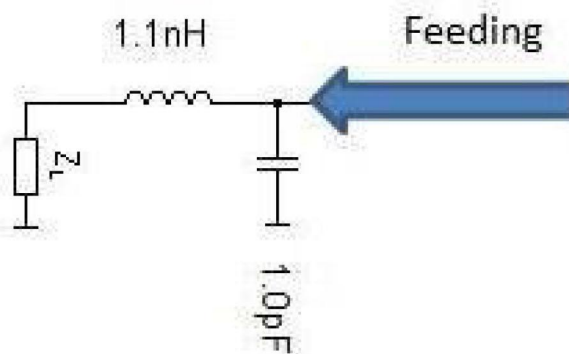

Layout Dimensions in Clearance area(Size=5.2\*5.0mm)

50 ohm transmission Line

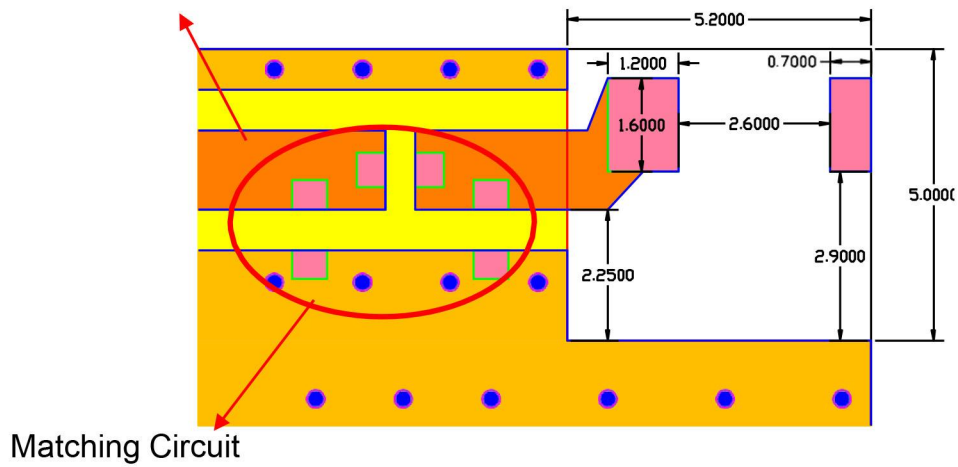

FootPrint (Unit : mm)

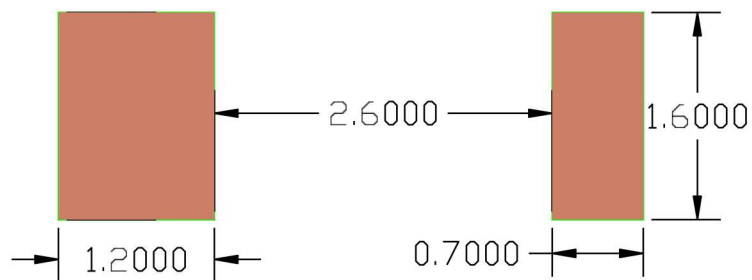

## 3. Measurement Results

### Return Loss

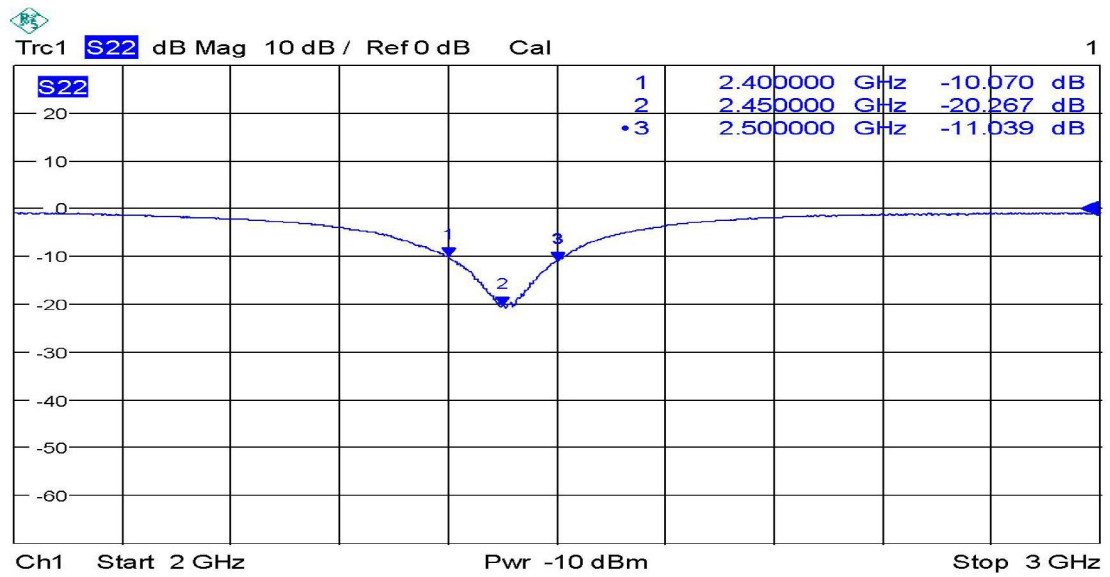

## Radiation Pattern

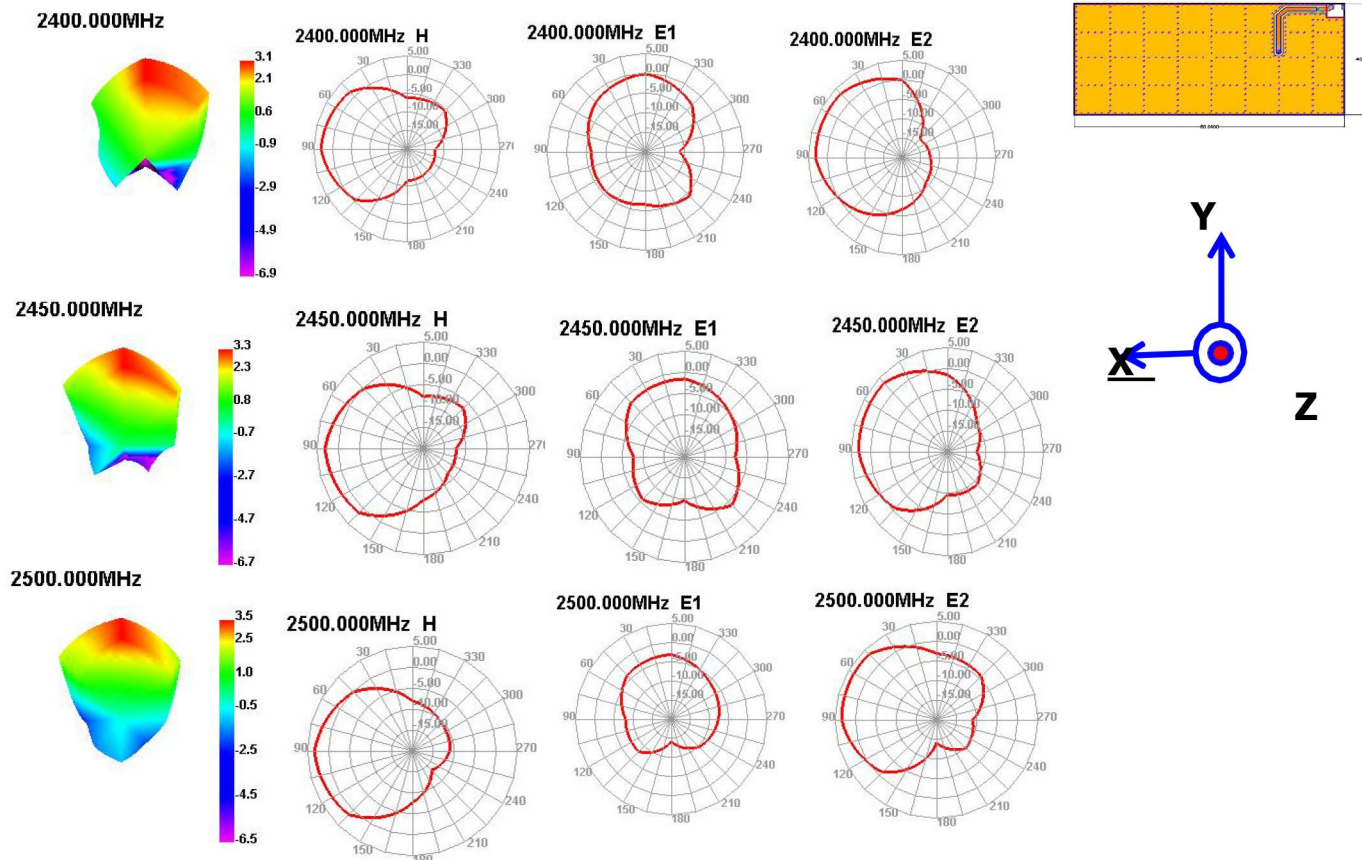

|         | Efficiency | Peak Gain |
|---------|------------|-----------|
| 2400MHz | 55.21 %    | 1.45 dBi  |
| 2450MHz | 66.45 %    | 2.71 dBi  |
| 2500MHz | 57.53 %    | 1.98 dBi  |

RAIN International Technology Co., Ltd

TEL:13530576606

Address:709, Building F, Yuxing Science and Technology Industrial Park,

Nanchang Third Industrial Zone, Nanchang Community, Xixiang Street, Bao 'an District, Shenzhen.



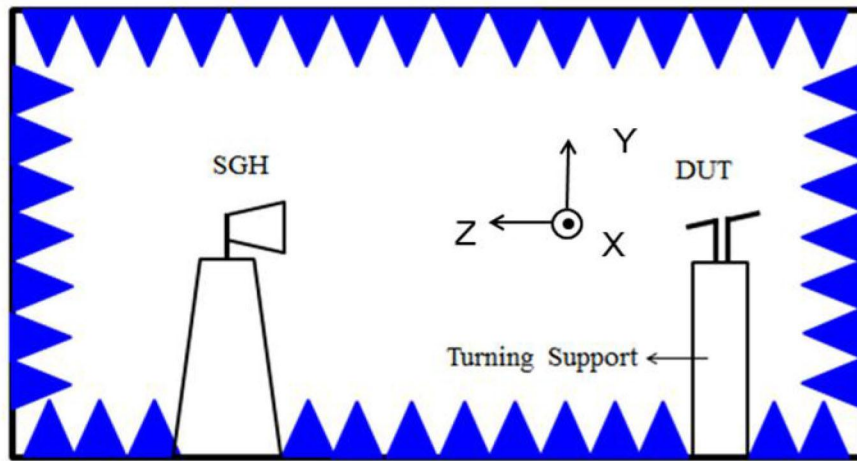

## 4. Reliability and Test Conditions

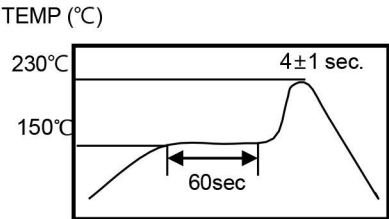
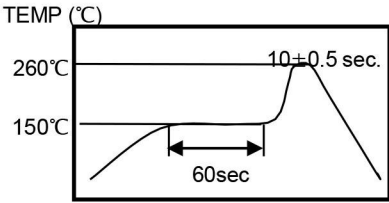
| ITEM                           | REQUIREMENTS   | TEST CONDITION  |
|--------------------------------|--|---|
| Solderability                  | 1. Wetting shall exceed 90% coverage<br>2. No visible mechanical damage<br><br>  | Pre-heating temperature:150°C/60sec.<br>Solder temperature:230±5°C<br>Duration:4±1sec.<br>Solder:Sn-Ag3.0-Cu0.5<br>Flux for lead free: rosin  |
| Solder heat Resistance         | 1. No visible mechanical damage<br>2. Central Freq. change :within ± 6%<br><br> | Pre-heating temperature:150°C/60sec.<br>Solder temperature:260±5°C<br>Duration:10±0.5sec.<br>Solder:Sn-Ag3.0-Cu0.5<br>Flux for lead free: rosin   |
| Component Adhesion (Push test) | 1. No visible mechanical damage  | The device should be reflow soldered(230±5°C for 10sec.) to a tinned copper substrate A dynamometer force gauge should be applied the side of the component. The device must with-ST-F 0.5 Kg without failure of the termination attached to component. |
| Component Adhesion (Pull test) | 1. No visible mechanical damage  | Insert 10cm wire into the remaining open eye bend ,the ends of even wire lengths upward and wind together. Terminal shall not be remarkably damaged.  |

## 2.4GHz 3216 Chip Antenna: 3216F245M02



| Thermal shock                  | 1. No visible mechanical damage<br>2. Central Freq. change :within +6%<br><table border="1"> <thead> <tr> <th>Phase</th> <th>Temperature(°C)</th> <th>Time(min)</th> </tr> </thead> <tbody> <tr> <td>1</td> <td>+85±5°C</td> <td>30±3</td> </tr> <tr> <td>2</td> <td>Room Temperature</td> <td>Within 3sec</td> </tr> <tr> <td>3</td> <td>-40±2°C</td> <td>30±3</td> </tr> <tr> <td>4</td> <td>Room Temperature</td> <td>Within 3sec</td> </tr> </tbody> </table> | Phase  | Temperature(°C) | Time(min) | 1 | +85±5°C | 30±3 | 2 | Room Temperature | Within 3sec | 3 | -40±2°C | 30±3 | 4 | Room Temperature | Within 3sec | +85°C=>30±3min<br>-40°C=>30±3min<br>Test cycle:10 cycles<br>The chip shall be stabilized at normal condition for 2~3 hours before measuring. |
|--------------------------------|---|--|-----------------|-----------|---|---------|------|---|------------------|-------------|---|---------|------|---|------------------|-------------|--|
| Phase                          | Temperature(°C)   | Time(min)  |                 |           |   |         |      |   |                  |             |   |         |      |   |                  |             |  |
| 1                              | +85±5°C   | 30±3   |                 |           |   |         |      |   |                  |             |   |         |      |   |                  |             |  |
| 2                              | Room Temperature  | Within 3sec  |                 |           |   |         |      |   |                  |             |   |         |      |   |                  |             |  |
| 3                              | -40±2°C   | 30±3   |                 |           |   |         |      |   |                  |             |   |         |      |   |                  |             |  |
| 4                              | Room Temperature  | Within 3sec  |                 |           |   |         |      |   |                  |             |   |         |      |   |                  |             |  |
| Resistance to High Temperature | 1. No visible mechanical damage<br>2. Central Freq. change :within ±6%<br>3. No disconnection or short circuit.   | Temperature: 85±5°C<br>Duration: 1000±12hrs<br>The chip shall be stabilized at normal condition for 2~3 hours before measuring.                            |                 |           |   |         |      |   |                  |             |   |         |      |   |                  |             |  |
| Resistance to Low Temperature  | 1. No visible mechanical damage<br>2. Central Freq. change :within ±6%<br>3. No disconnection or short circuit.   | Temperature:-40±5°C<br>Duration: 1000±12hrs<br>The chip shall be stabilized at normal condition for 2~3 hours before measuring.                            |                 |           |   |         |      |   |                  |             |   |         |      |   |                  |             |  |
| Humidity                       | 1. No visible mechanical damage<br>2. Central Freq. change :within ±6%<br>3. No disconnection or short circuit.   | Temperature: 40±2°C<br>Humidity: 90% to 95% RH<br>Duration: 1000±12hrs<br>The chip shall be stabilized at normal condition for 2~3 hours before measuring. |                 |           |   |         |      |   |                  |             |   |         |      |   |                  |             |  |

## 5. Soldering and Mounting

Mildly activated rosin fluxes are preferred. The minimum amount of solder can lead to damage from the stresses caused by the difference in coefficients of expansion between solder, chip and substrate. The terminations are suitable for all wave and re-flow soldering systems. If hand soldering cannot be avoided, the preferred technique is the utilization of hot air soldering tools.

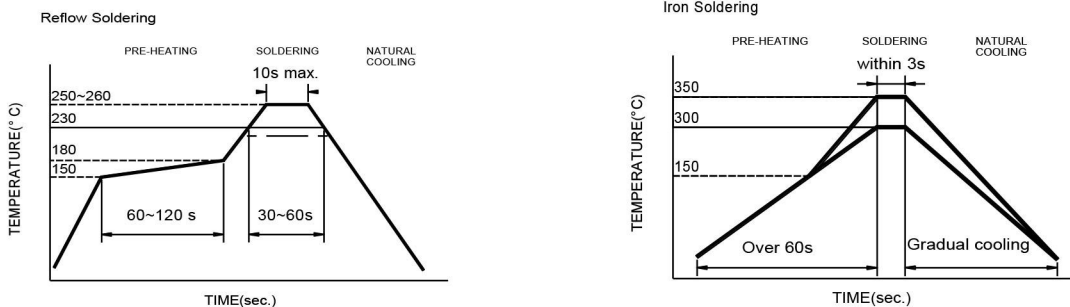

Recommended temperature profiles for re-flow soldering in Figure 1. Products attachment with a soldering iron is discouraged due to the inherent process control imitations. In the event that a soldering iron must be employed the following precautions are recommended.

RAIN International Technology Co., Ltd      TEL:13530576606  
 Address: 709, Building F, Yuxing Science and Technology Industrial Park,  
 Nanchang Third Industrial Zone, Nanchang Community, Xixiang Street, Bao 'an District, Shenzhen.



# 2.4GHz 3216 Chip Antenna: 3216F245M02



- Preheat circuit and products to 150°C
- Never contact the ceramic with the iron tip
- Use a 20 watt soldering iron with tip diameter of 1.0mm
- 280°C tip temperature (max)
- 1.0mm tip diameter (max)
- Limit soldering time to 3 sec.

## 6. Packaging Information

### ◆ Tape Specification:

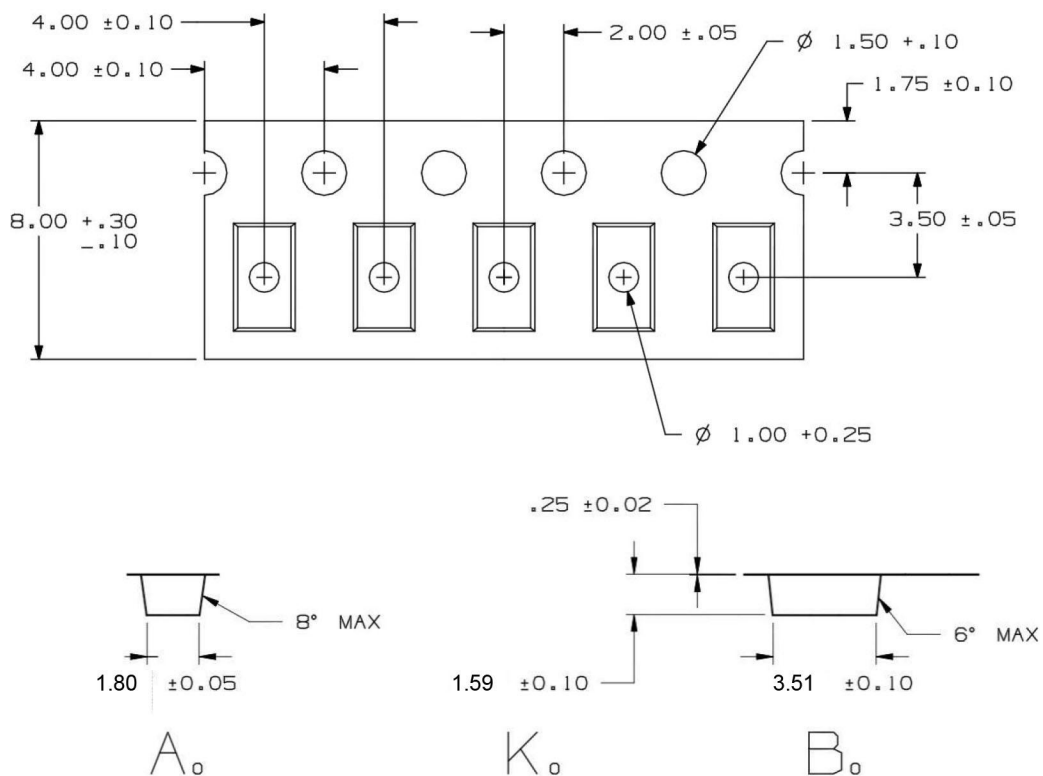

### Reel Specification: (7", $\Phi$ 180 mm)

RAIN International Technology Co., Ltd

TEL:13530576606

Address:709, Building F, Yuxing Science and Technology Industrial Park,

Nanchang Third Industrial Zone, Nanchang Community, Xixiang Street, Bao 'an District, Shenzhen.

## 2.4GHz 3216 Chip Antenna: 3216F245M02

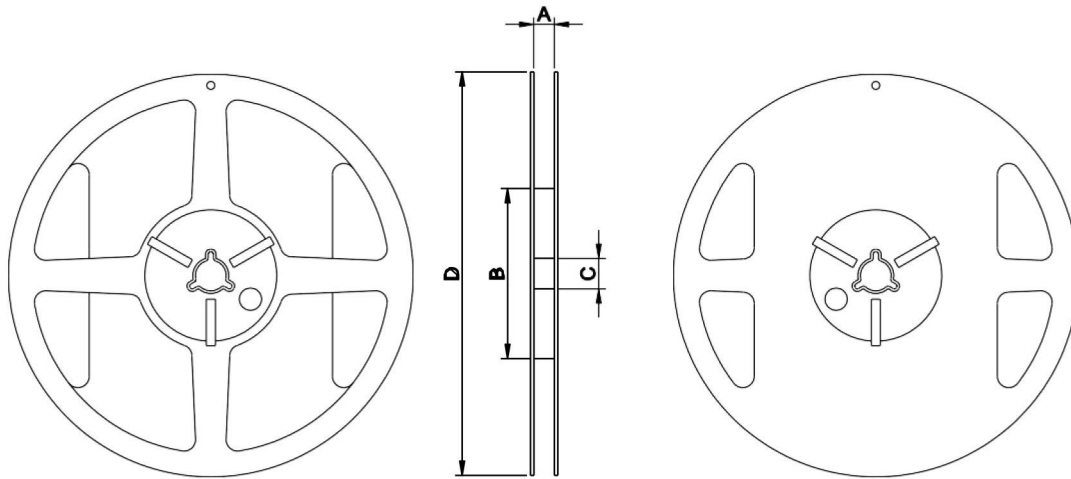

7" x 8 mm

| Tape Width(mm) | A(mm)   | B(mm) | C(mm)    | D(mm) | Chip/Reel(pcs) |
|----------------|---------|-------|----------|-------|----------------|
| 8              | 9.0±0.5 | 60±2  | 13.5±0.5 | 178±2 | 3000           |

## 7.Storage and Transportation Information

### Storage Conditions

To maintain the solderability of terminal electrodes:

1. Temperature and humidity conditions: -10~ 40°C and 30~70% RH.
2. Recommended products should be used within 6 months from the time of delivery.
3. The packaging material should be kept where no chlorine or sulfur exists in the air.

### Transportation Conditions

1. Products should be handled with care to avoid damage or contamination from perspiration and skin oils.
2. The use of tweezers or vacuum pick up is strongly recommended for individual components.
3. Bulk handling should ensure that abrasion and mechanical shock are minimized.