

FCC SAR Test Report

APPLICANT : TCL Communication Ltd.
EQUIPMENT : Tablet PC
BRAND NAME : alcatel
MODEL NAME : 9015B
MARKETING NAME : Alcatel POP™ 7 LTE
FCC ID : 2ACCJB066
STANDARD : FCC 47 CFR Part 2 (2.1093)
ANSI/IEEE C95.1-1992
IEEE 1528-2013

We, SPORTON INTERNATIONAL (SHENZHEN) INC., would like to declare that the tested sample has been evaluated in accordance with the procedures and had been in compliance with the applicable technical standards.

The test results in this report apply exclusively to the tested model / sample. Without written approval of SPORTON INTERNATIONAL (SHENZHEN) INC., the test report shall not be reproduced except in full.



Prepared by: Mark Qu / Manager



Approved by: Jones Tsai / Manager



SPORTON INTERNATIONAL (SHENZHEN) INC.
1F & 2F, Building A, Morning Business Center, No. 4003 ShiGu Rd., Xili Town,
Nanshan District, Shenzhen, Guangdong, P. R. China



Table of Contents

1. Statement of Compliance 4

2. Administration Data 5

3. Guidance Standard 5

4. Equipment Under Test (EUT) Information 6

 4.1 General Information 6

 4.2 Specification of Accessory 7

 4.3 General LTE SAR Test and Reporting Considerations 8

5. Proximity Sensor Triggering Test 10

6. RF Exposure Limits 15

 6.1 Uncontrolled Environment 15

 6.2 Controlled Environment 15

7. Specific Absorption Rate (SAR) 16

 7.1 Introduction 16

 7.2 SAR Definition 16

8. System Description and Setup 17

 8.1 E-Field Probe 18

 8.2 Data Acquisition Electronics (DAE) 18

 8.3 Phantom 18

 8.4 Device Holder 19

9. Measurement Procedures 20

 9.1 Spatial Peak SAR Evaluation 20

 9.2 Power Reference Measurement 21

 9.3 Area Scan 21

 9.4 Zoom Scan 22

 9.5 Volume Scan Procedures 22

 9.6 Power Drift Monitoring 22

10. Test Equipment List 23

11. System Verification 24

 11.1 Tissue Verification 24

 11.2 System Performance Check Results 25

12. RF Exposure Positions 26

 12.1 SAR Testing for Tablet 26

13. Conducted RF Output Power (Unit: dBm) 27

14. Antenna Location 64

15. SAR Test Results 67

 15.1 Body SAR 69

 15.2 Repeated SAR Measurement 77

16. Simultaneous Transmission Analysis 78

 16.1 Body Exposure Conditions 79

 16.2 SPLSR Evaluation and Analysis 91

17. Uncertainty Assessment 100

18. References 103

Appendix A. Plots of System Performance Check

Appendix B. Plots of High SAR Measurement

Appendix C. DASY Calibration Certificate

Appendix D. Test Setup Photos



Revision History

REPORT NO.	VERSION	DESCRIPTION	ISSUED DATE
FA670507	Rev. 01	Initial issue of report	Aug. 16, 2016



1. Statement of Compliance

The maximum results of Specific Absorption Rate (SAR) found during testing for TCL Communication Ltd., Tablet PC, 9015B, are as follows.

Table with 5 columns: Equipment Class, Frequency Band, Highest SAR Summary (Body, 1g SAR (W/kg)), Highest Simultaneous Transmission 1g SAR (W/kg), and Date of Testing. Rows include GSM, WCDMA, LTE, WLAN, and Bluetooth categories.

Note:

- 1. The SAR value list above are all rounded to two decimal digits.
2. a. According to section 16.1, the maximum simultaneous SAR for WWAN+NII is 2.04 W/kg.
b. Per KDB 447498 D01, when the sum of SAR is larger than the limit, SAR test exclusion is determined by the SAR to peak location separation ratio.

This device is in compliance with Specific Absorption Rate (SAR) for general population/uncontrolled exposure limits (1.6 W/kg) specified in FCC 47 CFR part 2 (2.1093) and ANSI/IEEE C95.1-1992, and had been tested in accordance with the measurement methods and procedures specified in IEEE 1528-2013 and FCC KDB publications



2. Administration Data

Testing Laboratory	
Test Site	SPORTON INTERNATIONAL (SHENZHEN) INC.
Test Site Location	1F & 2F, Building A, Morning Business Center, No. 4003 ShiGu Rd., Xili Town, Nanshan District, Shenzhen, Guangdong, P. R. China TEL: +86-755-8637-9589 FAX: +86-755-8637-9595

Applicant	
Company Name	TCL Communication Ltd.
Address	5F, C-Tower, No. 232, Liang Jing Road, ZhangJiang High-Tech Park, Pudong Area, Shanghai, 201203, P. R. China

Manufacturer	
Company Name	TCL Communication Ltd.
Address	5F, C-Tower, No. 232, Liang Jing Road, ZhangJiang High-Tech Park, Pudong Area, Shanghai, 201203, P. R. China

3. Guidance Standard

The Specific Absorption Rate (SAR) testing specification, method, and procedure for this device is in accordance with the following standards:

- FCC 47 CFR Part 2 (2.1093)
- ANSI/IEEE C95.1-1992
- IEEE 1528-2013
- FCC KDB 865664 D01 SAR Measurement 100 MHz to 6 GHz v01r04
- FCC KDB 865664 D02 SAR Reporting v01r02
- FCC KDB 447498 D01 General RF Exposure Guidance v06
- FCC KDB 248227 D01 802.11 Wi-Fi SAR v02r02
- FCC KDB 616217 D04 SAR for laptop and tablets v01r02
- FCC KDB 941225 D01 3G SAR Procedures v03r01
- FCC KDB 941225 D05 SAR for LTE Devices v02r05



4. Equipment Under Test (EUT) Information

4.1 General Information

Product Feature & Specification	
Equipment Name	Tablet PC
Brand Name	alcatel
Model Name	9015B
Marketing Name	Alcatel POP™ 7 LTE
FCC ID	2ACCJB066
IMEI Code	014732000100042
Wireless Technology and Frequency Range	GSM850: 824.2 MHz ~ 848.8 MHz GSM1900: 1850.2 MHz ~ 1909.8 MHz WCDMA Band II: 1852.4 MHz ~ 1907.6 MHz WCDMA Band IV: 1712.4 MHz ~ 1752.6 MHz WCDMA Band V: 826.4 MHz ~ 846.6 MHz LTE Band 2: 1850 MHz ~ 1910 MHz LTE Band 4: 1710 MHz ~ 1755 MHz LTE Band 5: 824 MHz ~ 849 MHz LTE Band 7: 2500 MHz ~ 2570 MHz LTE Band 12: 699 MHz ~ 716 MHz LTE Band 17: 704 MHz ~ 716 MHz WLAN 2.4GHz Band: 2412 MHz ~ 2462 MHz WLAN 5.2GHz Band: 5180 MHz ~ 5240 MHz WLAN 5.3GHz Band: 5260 MHz ~ 5320 MHz WLAN 5.8GHz Band: 5745 MHz ~ 5805 MHz Bluetooth: 2402 MHz ~ 2480 MHz
Mode	<ul style="list-style-type: none"> · GPRS/EGPRS · RMC 12.2Kbps · HSDPA · HSUPA · DC-HSDPA · HSPA+ (16QAM uplink is not supported) · LTE · WLAN 2.4GHz 802.11b/g/n HT20 · 802.11a/n HT20/HT40 · Bluetooth v3.0+EDR, Bluetooth v4.1 LE
HW Version	Pixi4-7 4G TMO_MAIN_V03
SW Version	5RA2
EUT Stage	Production Unit
Remark: 1. 802.11n-HT40 is not supported in 2.4GHz WLAN. 2. This device supports GRPS/EGPRS mode up to multi-slot class33. 3. This device has no voice function. 4. The device implanted P-sensor function, when worked near the body, power reduction will be active immediately for all WWAN bands.	



4.2 Specification of Accessory

Specification of Accessory				
AC Adapter	Brand Name	ALCATEL onetouch	Model Name	UC13US
	Power Rating	I/P: 100 - 240Vac 400mA, O/P:5.0V 2A		
	P/N	CBA0059AG0C2		
Battery	Brand Name	ALCATEL onetouch	Model Name	TLp032B2
	Power Rating	3.7Vdc, 3240mAh		
USB Cable	Brand Name	N/A	Model Name	N/A
	Signal Line Type	0.8meter, shielded cable, without ferrite core		
	P/N	N/A		



4.3 General LTE SAR Test and Reporting Considerations

Summarized necessary items addressed in KDB 941225 D05 v02r05																																							
FCC ID	2ACCJB066																																						
Equipment Name	Tablet PC																																						
Operating Frequency Range of each LTE transmission band	LTE Band 02: 1850 MHz ~ 1910 MHz LTE Band 04: 1710 MHz ~ 1755 MHz LTE Band 05: 824 MHz ~ 849 MHz LTE Band 07: 2500 MHz ~ 2570 MHz LTE Band 12: 699 MHz ~ 716 MHz LTE Band 17: 704 MHz ~ 716 MHz																																						
Channel Bandwidth	LTE Band 02:1.4MHz, 3MHz, 5MHz, 10MHz, 15MHz, 20MHz LTE Band 04:1.4MHz, 3MHz, 5MHz, 10MHz, 15MHz, 20MHz LTE Band 05:1.4MHz, 3MHz, 5MHz, 10MHz LTE Band 07: 5MHz, 10MHz, 15MHz, 20MHz LTE Band 12:1.4MHz, 3MHz, 5MHz, 10MHz LTE Band 17: 5MHz, 10MHz																																						
uplink modulations used	QPSK, and 16QAM																																						
LTE Voice / Data requirements	Data only																																						
LTE MPR permanently built-in by design	<p style="text-align: center;">Table 6.2.3-1: Maximum Power Reduction (MPR) for Power Class 3</p> <table border="1"> <thead> <tr> <th rowspan="2">Modulation</th> <th colspan="6">Channel bandwidth / Transmission bandwidth (RB)</th> <th rowspan="2">MPR (dB)</th> </tr> <tr> <th>1.4 MHz</th> <th>3.0 MHz</th> <th>5 MHz</th> <th>10 MHz</th> <th>15 MHz</th> <th>20 MHz</th> </tr> </thead> <tbody> <tr> <td>QPSK</td> <td>> 5</td> <td>> 4</td> <td>> 8</td> <td>> 12</td> <td>> 16</td> <td>> 18</td> <td>≤ 1</td> </tr> <tr> <td>16 QAM</td> <td>≤ 5</td> <td>≤ 4</td> <td>≤ 8</td> <td>≤ 12</td> <td>≤ 16</td> <td>≤ 18</td> <td>≤ 1</td> </tr> <tr> <td>16 QAM</td> <td>> 5</td> <td>> 4</td> <td>> 8</td> <td>> 12</td> <td>> 16</td> <td>> 18</td> <td>≤ 2</td> </tr> </tbody> </table>	Modulation	Channel bandwidth / Transmission bandwidth (RB)						MPR (dB)	1.4 MHz	3.0 MHz	5 MHz	10 MHz	15 MHz	20 MHz	QPSK	> 5	> 4	> 8	> 12	> 16	> 18	≤ 1	16 QAM	≤ 5	≤ 4	≤ 8	≤ 12	≤ 16	≤ 18	≤ 1	16 QAM	> 5	> 4	> 8	> 12	> 16	> 18	≤ 2
Modulation	Channel bandwidth / Transmission bandwidth (RB)						MPR (dB)																																
	1.4 MHz	3.0 MHz	5 MHz	10 MHz	15 MHz	20 MHz																																	
QPSK	> 5	> 4	> 8	> 12	> 16	> 18	≤ 1																																
16 QAM	≤ 5	≤ 4	≤ 8	≤ 12	≤ 16	≤ 18	≤ 1																																
16 QAM	> 5	> 4	> 8	> 12	> 16	> 18	≤ 2																																
LTE A-MPR	In the base station simulator configuration, Network Setting value is set to NS_01 to disable A-MPR during SAR testing and the LTE SAR tests was transmitting on all TTI frames (Maximum TTI)																																						
Spectrum plots for RB configuration	A properly configured base station simulator was used for the SAR and power measurement; therefore, spectrum plots for each RB allocation and offset configuration are not included in the SAR report.																																						
Power reduction applied to satisfy SAR compliance	Yes, Proximity Sensor.																																						
LTE Release	R10,Cat 4																																						
CA Support	No																																						



Transmission (H, M, L) channel numbers and frequencies in each LTE band												
LTE Band 2												
	Bandwidth 1.4 MHz		Bandwidth 3 MHz		Bandwidth 5 MHz		Bandwidth 10 MHz		Bandwidth 15 MHz		Bandwidth 20 MHz	
	Ch. #	Freq. (MHz)	Ch. #	Freq. (MHz)	Ch. #	Freq. (MHz)	Ch. #	Freq. (MHz)	Ch. #	Freq. (MHz)	Ch. #	Freq. (MHz)
L	18607	1850.7	18615	1851.5	18625	1852.5	18650	1855	18675	1857.5	18700	1860
M	18900	1880	18900	1880	18900	1880	18900	1880	18900	1880	18900	1880
H	19193	1909.3	19185	1908.5	19175	1907.5	19150	1905	19125	1902.5	19100	1900
LTE Band 4												
	Bandwidth 1.4 MHz		Bandwidth 3 MHz		Bandwidth 5 MHz		Bandwidth 10 MHz		Bandwidth 15 MHz		Bandwidth 20 MHz	
	Ch. #	Freq. (MHz)	Ch. #	Freq. (MHz)	Ch. #	Freq. (MHz)	Ch. #	Freq. (MHz)	Ch. #	Freq. (MHz)	Ch. #	Freq. (MHz)
L	19957	1710.7	19965	1711.5	19975	1712.5	20000	1715	20025	1717.5	20050	1720
M	20175	1732.5	20175	1732.5	20175	1732.5	20175	1732.5	20175	1732.5	20175	1732.5
H	20393	1754.3	20385	1753.5	20375	1752.5	20350	1750	20325	1747.5	20300	1745
LTE Band 5												
	Bandwidth 1.4 MHz		Bandwidth 3 MHz		Bandwidth 5 MHz		Bandwidth 10 MHz					
	Ch. #	Freq. (MHz)	Ch. #	Freq. (MHz)	Ch. #	Freq. (MHz)	Ch. #	Freq. (MHz)	Ch. #	Freq. (MHz)	Ch. #	Freq. (MHz)
L	20407	824.7	20415	825.5	20425	826.5	20450	829				
M	20525	836.5	20525	836.5	20525	836.5	20525	836.5				
H	20643	848.3	20635	847.5	20625	846.5	20600	844				
LTE Band 7												
	Bandwidth 5 MHz		Bandwidth 10 MHz		Bandwidth 15 MHz		Bandwidth 20 MHz					
	Ch. #	Freq. (MHz)	Ch. #	Freq. (MHz)	Ch. #	Freq. (MHz)	Ch. #	Freq. (MHz)	Ch. #	Freq. (MHz)	Ch. #	Freq. (MHz)
L	20775	2502.5	20800	2505	20825	2507.5	20850	2510				
M	21100	2535	21100	2535	21100	2535	21100	2535				
H	21425	2567.5	21400	2565	21375	2562.5	21350	2560				
LTE Band 12												
	Bandwidth 1.4 MHz		Bandwidth 3 MHz		Bandwidth 5 MHz		Bandwidth 10 MHz					
	Ch. #	Freq. (MHz)	Ch. #	Freq. (MHz)	Ch. #	Freq. (MHz)	Ch. #	Freq. (MHz)	Ch. #	Freq. (MHz)	Ch. #	Freq. (MHz)
L	23017	699.7	23025	700.5	23035	701.5	23060	704				
M	23095	707.5	23095	707.5	23095	707.5	23095	707.5				
H	23173	715.3	23165	714.5	23155	713.5	23130	711				
LTE Band 17												
	Bandwidth 5 MHz				Bandwidth 10 MHz							
	Channel #		Freq.(MHz)		Channel #		Freq. (MHz)		Channel #		Freq. (MHz)	
L	23755		706.5		23780		709					
M	23790		710		23790		710					
H	23825		713.5		23800		711					

5. Proximity Sensor Triggering Test

<Proximity Sensor Triggering Distance (KDB 616217 D04 section 6.2)>:

Proximity sensor triggering distance testing was performed according to the procedures outlined in KDB 616217 D04 section 6.2, and EUT moving further away from the flat phantom and EUT moving toward the flat phantom were both assessed. The details are illustrated in the exhibit “P-Sensor operational description”, and the shortest triggering distances were reported and used for SAR assessment.

In the preliminary triggering distance testing, the tissue-equivalent medium for different frequency bands were used for verification; no other frequency bands tissue-equivalent medium was found to result in shortest triggering distance than that for 1900MHz, and the tissue-equivalent medium for 1900MHz was used for formal proximity sensor triggering testing.

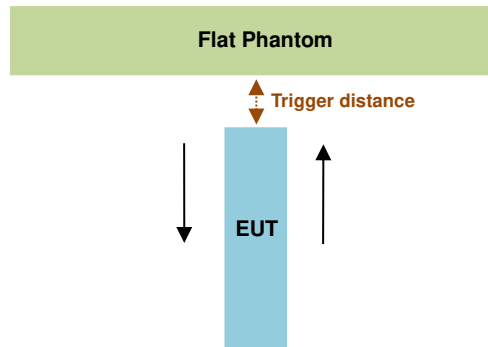

Proximity Sensor Trigger Distance (mm)			
Position	Bottom Face	Edge 1	Edge 2
Minimum	12	8	7

<Proximity Sensor Triggering Coverage (KDB 616217 D04 section 6.3)>:

If a sensor is spatially offset from the antenna(s), it is necessary to verify sensor triggering for conditions where the antenna is next to the user but the sensor is laterally further away to ensure sensor coverage is sufficient for reducing the power to maintain compliance. For p-sensor coverage testing, the device is moved and “along the direction of maximum antenna and sensor offset”.

Illustrated in the internal photo exhibit, although the sensor is spatially offset, there is no trigger condition where the antenna is next to the user but the sensor is laterally further away, therefore proximity sensor coverage testing is not required.

This procedure is not required because antenna and sensor are collocated and the peak SAR location is overlapping with the sensor.

<Tablet Tilt angle influences to proximity sensor triggering (KDB 616217 D04 section 6.4)>:

The influence of table tilt angles to proximity sensor triggering was determined by positioning each tablet edge that contains a transmitting antenna, perpendicular to the flat phantom, at 8 mm(Edge 1) and 7 mm(Edge 2) separation. Rotating the tablet around the edge next to the phantom in $\leq 10^\circ$ increments until the tablet is $\pm 45^\circ$ from the vertical position at 0° , and the maximum output power remains in the reduced mode.

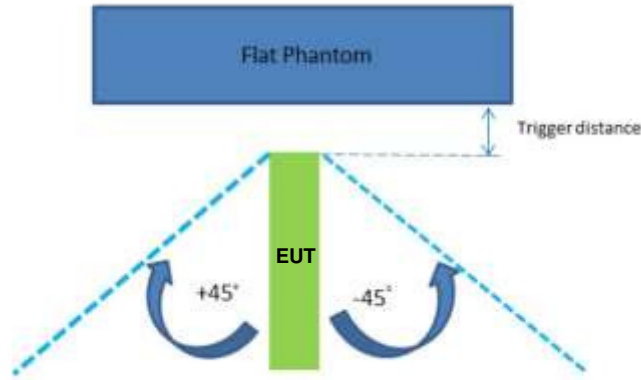

The Sensor Trigger Distance (mm)		
Position	Edge 1	Edge 2
Minimum	8	7

Proximity sensor power reduction

Exposure Position / wireless mode	Bottom Face ⁽¹⁾	Edge 1 ⁽¹⁾	Edge 2 ⁽¹⁾	Edge 3	Edge 4
GSM850 GPRS (GMSK 1 Tx slot) - CS1	8.0 dB	8.0 dB	8.0 dB	0 dB	0 dB
GSM850 GPRS (GMSK 2 Tx slot) - CS1	8.0 dB	8.0 dB	8.0 dB	0 dB	0 dB
GSM850 GPRS (GMSK 3 Tx slot) - CS1	7.5 dB	7.5 dB	7.5 dB	0 dB	0 dB
GSM850 GPRS (GMSK 4 Tx slot) - CS1	7.5 dB	7.5 dB	7.5 dB	0 dB	0 dB
GSM850 EDGE (8PSK 1 Tx slot) - MCS5	7.5 dB	7.5 dB	7.5 dB	0 dB	0 dB
GSM850 EDGE (8PSK 2 Tx slot) - MCS5	8.0 dB	8.0 dB	8.0 dB	0 dB	0 dB
GSM850 EDGE (8PSK 3 Tx slot) - MCS5	8.0 dB	8.0 dB	8.0 dB	0 dB	0 dB
GSM850 EDGE (8PSK 4 Tx slot) - MCS5	7.5 dB	7.5 dB	7.5 dB	0 dB	0 dB
GSM1900 GPRS (GMSK 1 Tx slot) - CS1	9.0 dB	9.0 dB	9.0 dB	0 dB	0 dB
GSM1900 GPRS (GMSK 2 Tx slot) - CS1	10.0 dB	10.0 dB	10.0 dB	0 dB	0 dB
GSM1900 GPRS (GMSK 3 Tx slot) - CS1	9.5 dB	9.5 dB	9.5 dB	0 dB	0 dB
GSM1900 GPRS (GMSK 4 Tx slot) - CS1	9.5 dB	9.5 dB	9.5 dB	0 dB	0 dB
GSM1900 EDGE (8PSK 1 Tx slot) - MCS5	9.5 dB	9.5 dB	9.5 dB	0 dB	0 dB
GSM1900 EDGE (8PSK 2 Tx slot) - MCS5	10.0 dB	10.0 dB	10.0 dB	0 dB	0 dB
GSM1900 EDGE (8PSK 3 Tx slot) - MCS5	9.5 dB	9.5 dB	9.5 dB	0 dB	0 dB
GSM1900 EDGE (8PSK 4 Tx slot) - MCS5	9.0 dB	9.0 dB	9.0 dB	0 dB	0 dB
WCDMA Band V	8.0 dB	8.0 dB	8.0 dB	0 dB	0 dB
WCDMA Band II	9.5 dB	9.5 dB	9.5 dB	0 dB	0 dB
WCDMA Band IV	10.0 dB	10.0 dB	10.0 dB	0 dB	0 dB
LTE Band 2	10.0 dB	10.0 dB	10.0 dB	0 dB	0 dB
LTE Band 4	10.5 dB	10.5 dB	10.5 dB	0 dB	0 dB
LTE Band 5	10.5 dB	10.5 dB	10.5 dB	0 dB	0 dB
LTE Band 7	8.5 dB	8.5 dB	8.5 dB	0 dB	0 dB
LTE Band 12	8.5 dB	8.5 dB	8.5 dB	0 dB	0 dB
LTE Band 17	8.5 dB	8.5 dB	8.5 dB	0 dB	0 dB

Remark:

1. ⁽¹⁾: Reduced maximum limit applied by activation of proximity sensor.
2. Power reduction is not applicable for WLAN and Bluetooth.
3. Tests were performed in accordance with KDB 616217 D04 section 6.1, 6.2, 6.3, 6.4 and 6.5.
4. For verification of compliance of power reduction scheme, additional SAR testing with EUT transmitting at full RF power at a conservative trigger distance was performed:
 - Bottom Face: 9 mm
 - Edge1: 6 mm
 - Edge 2: 5 mm



Power Measurement during Sensor Trigger distance testing

Band/Mode	Ch #	Measured power reduction (dBm)		Reduction Levels (dB)
		w/o power back-off	w/ power back-off	
GSM850 GPRS (GMSK 2 Tx slot)	189	30.93	23.22	7.71
GSM1900 GPRS (GMSK 2 Tx slot)	661	28.19	18.13	10.06
WCDMA Band V (RMC 12.2Kbps)	4182	23.26	15.38	7.88
WCDMA Band IV (RMC 12.2Kbps)	1413	23.16	13.50	9.66
WCDMA Band II (RMC 12.2Kbps)	9400	23.40	13.91	9.49
LTE Band 2 20MHz 1RB 0offset	18900	23.13	13.28	9.85
LTE Band 4 20MHz 1RB 0offset	20175	22.98	12.95	10.03
LTE Band 5 10MHz 1RB 25offset	20525	22.90	13.19	9.71
LTE Band 7 20MHz 1RB 0offset	21100	21.91	13.93	7.98
LTE Band 12 20MHz 1RB 25offset	23095	22.86	14.94	7.92
LTE Band 17 20MHz 1RB 25offset	23790	23.08	15.08	8.00

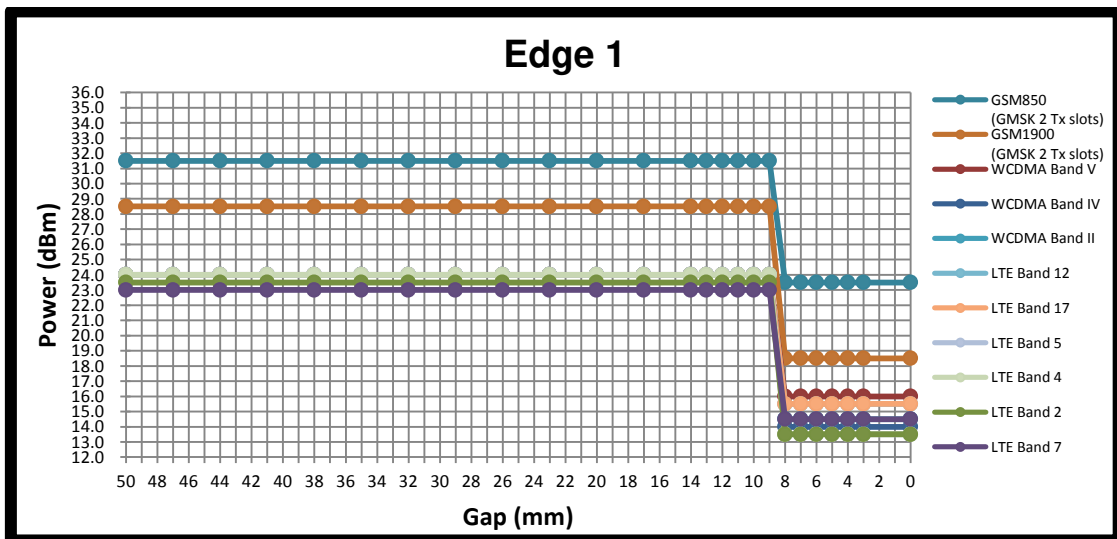
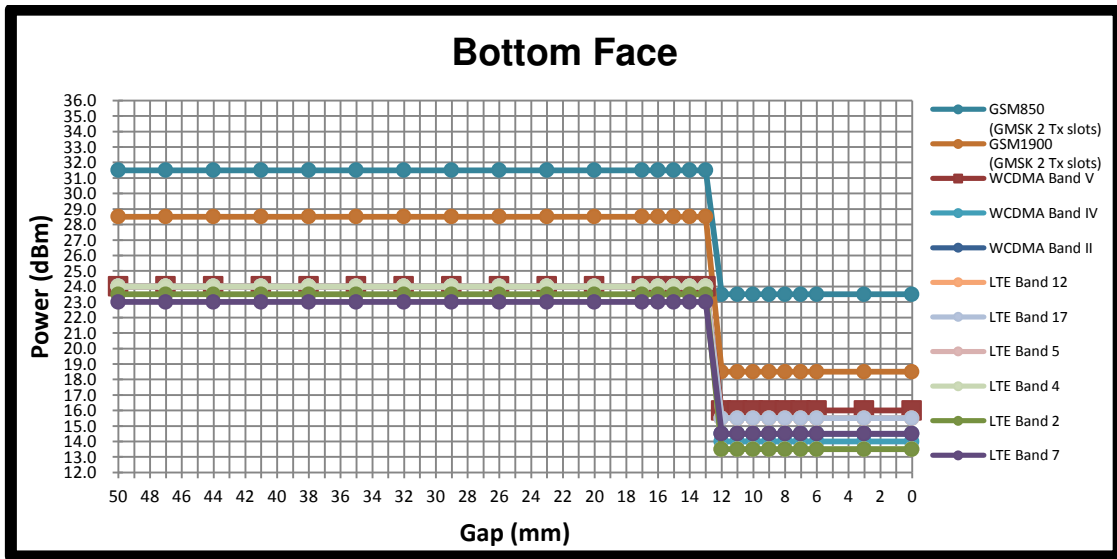

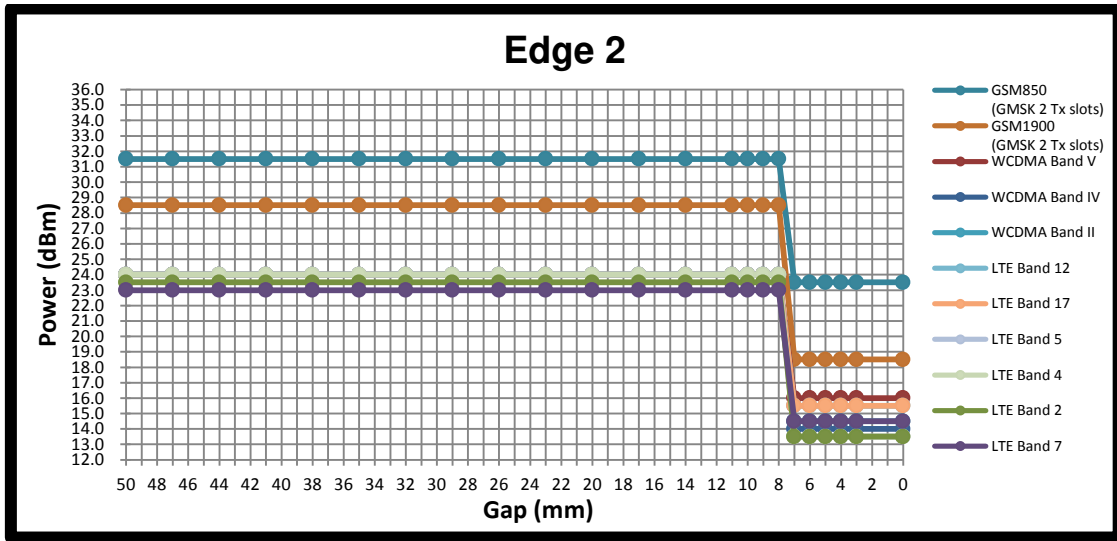

6. RF Exposure Limits

6.1 Uncontrolled Environment

Uncontrolled Environments are defined as locations where there is the exposure of individuals who have no knowledge or control of their exposure. The general population/uncontrolled exposure limits are applicable to situations in which the general public may be exposed or in which persons who are exposed as a consequence of their employment may not be made fully aware of the potential for exposure or cannot exercise control over their exposure. Members of the general public would come under this category when exposure is not employment-related; for example, in the case of a wireless transmitter that exposes persons in its vicinity.

6.2 Controlled Environment

Controlled Environments are defined as locations where there is exposure that may be incurred by persons who are aware of the potential for exposure, (i.e. as a result of employment or occupation). In general, occupational/controlled exposure limits are applicable to situations in which persons are exposed as a consequence of their employment, who have been made fully aware of the potential for exposure and can exercise control over their exposure. The exposure category is also applicable when the exposure is of a transient nature due to incidental passage through a location where the exposure levels may be higher than the general population/uncontrolled limits, but the exposed person is fully aware of the potential for exposure and can exercise control over his or her exposure by leaving the area or by some other appropriate means.

Limits for Occupational/Controlled Exposure (W/kg)

Whole-Body	Partial-Body	Hands, Wrists, Feet and Ankles
0.4	8.0	20.0

Limits for General Population/Uncontrolled Exposure (W/kg)

Whole-Body	Partial-Body	Hands, Wrists, Feet and Ankles
0.08	1.6	4.0

Whole-Body SAR is averaged over the entire body, partial-body SAR is averaged over any 1gram of tissue defined as a tissue volume in the shape of a cube. SAR for hands, wrists, feet and ankles is averaged over any 10 grams of tissue defined as a tissue volume in the shape of a cube.

7. Specific Absorption Rate (SAR)

7.1 Introduction

SAR is related to the rate at which energy is absorbed per unit mass in an object exposed to a radio field. The SAR distribution in a biological body is complicated and is usually carried out by experimental techniques or numerical modeling. The standard recommends limits for two tiers of groups, occupational/controlled and general population/uncontrolled, based on a person's awareness and ability to exercise control over his or her exposure. In general, occupational/controlled exposure limits are higher than the limits for general population/uncontrolled.

7.2 SAR Definition

The SAR definition is the time derivative (rate) of the incremental energy (dW) absorbed by (dissipated in) an incremental mass (dm) contained in a volume element (dv) of a given density (ρ). The equation description is as below:

$$SAR = \frac{d}{dt} \left(\frac{dW}{dm} \right) = \frac{d}{dt} \left(\frac{dW}{\rho dv} \right)$$

SAR is expressed in units of Watts per kilogram (W/kg)

$$SAR = \frac{\sigma |E|^2}{\rho}$$

Where: σ is the conductivity of the tissue, ρ is the mass density of the tissue and E is the RMS electrical field strength.

8. System Description and Setup

The DASY system used for performing compliance tests consists of the following items:

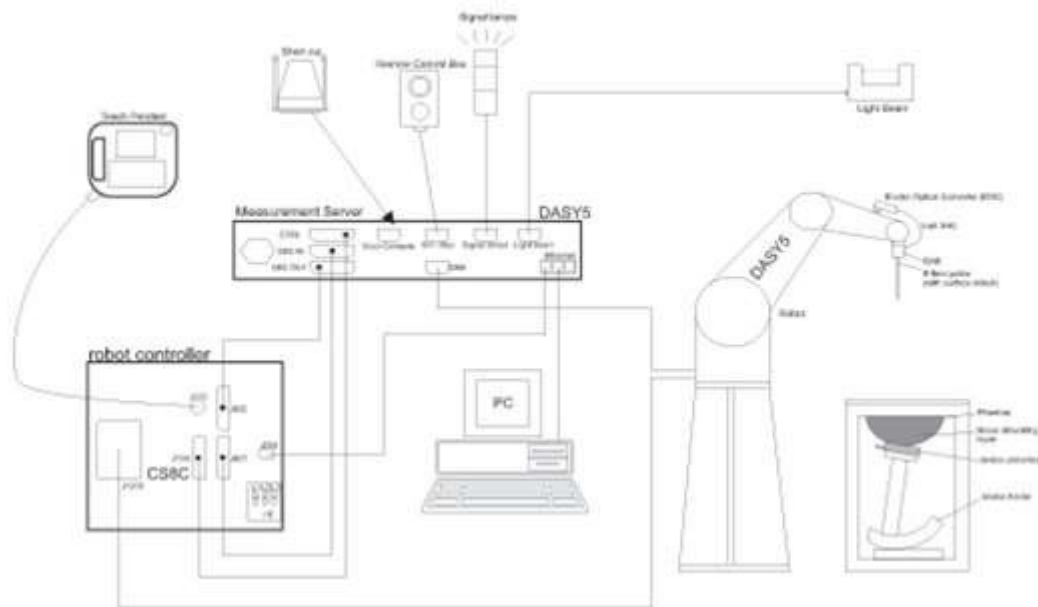

- A standard high precision 6-axis robot with controller, teach pendant and software. An arm extension for accommodating the data acquisition electronics (DAE).
- An isotropic Field probe optimized and calibrated for the targeted measurement.
- A data acquisition electronics (DAE) which performs the signal amplification, signal multiplexing, AD-conversion, offset measurements, mechanical surface detection, collision detection, etc. The unit is battery powered with standard or rechargeable batteries. The signal is optically transmitted to the EOC.
- The Electro-optical converter (EOC) performs the conversion from optical to electrical signals for the digital communication to the DAE. To use optical surface detection, a special version of the EOC is required. The EOC signal is transmitted to the measurement server.
- The function of the measurement server is to perform the time critical tasks such as signal filtering, control of the robot operation and fast movement interrupts.
- The Light Beam used is for probe alignment. This improves the (absolute) accuracy of the probe positioning.
- A computer running WinXP or Win7 and the DASY5 software.
- Remote control and teach pendant as well as additional circuitry for robot safety such as warning lamps, etc.
- The phantom, the device holder and other accessories according to the targeted measurement.

8.1 E-Field Probe

The SAR measurement is conducted with the dosimetric probe (manufactured by SPEAG).The probe is specially designed and calibrated for use in liquid with high permittivity. The dosimetric probe has special calibration in liquid at different frequency. This probe has a built in optical surface detection system to prevent from collision with phantom.

<EX3DV4 Probe>

Construction	Symmetric design with triangular core Built-in shielding against static charges PEEK enclosure material (resistant to organic solvents, e.g., DGBE)
Frequency	10 MHz – >6 GHz Linearity: ±0.2 dB (30 MHz – 6 GHz)
Directivity	±0.3 dB in TSL (rotation around probe axis) ±0.5 dB in TSL (rotation normal to probe axis)
Dynamic Range	10 µW/g – >100 mW/g Linearity: ±0.2 dB (noise: typically <1 µW/g)
Dimensions	Overall length: 337 mm (tip: 20 mm) Tip diameter: 2.5 mm (body: 12 mm) Typical distance from probe tip to dipole centers: 1 mm



8.2 Data Acquisition Electronics (DAE)

The data acquisition electronics (DAE) consists of a highly sensitive electrometer-grade preamplifier with auto-zeroing, a channel and gain-switching multiplexer, a fast 16 bit AD-converter and a command decoder and control logic unit. Transmission to the measurement server is accomplished through an optical downlink for data and status information as well as an optical uplink for commands and the clock.

The input impedance of the DAE is 200 MOhm; the inputs are symmetrical and floating. Common mode rejection is above 80 dB.



Fig 5.1 Photo of DAE

8.3 Phantom

<ELI Phantom>

Shell Thickness	2 ± 0.2 mm (sagging: <1%)
Filling Volume	Approx. 30 liters
Dimensions	Major ellipse axis: 600 mm Minor axis: 400 mm



8.4 Device Holder

<Mounting Device for Hand-Held Transmitter>

In combination with the Twin SAM V5.0/V5.0c or ELI phantoms, the Mounting Device for Hand-Held Transmitters enables rotation of the mounted transmitter device to specified spherical coordinates. At the heads, the rotation axis is at the ear opening. Transmitter devices can be easily and accurately positioned according to IEC 62209-1, IEEE 1528, FCC, or other specifications. The device holder can be locked for positioning at different phantom sections (left head, right head, flat). And upgrade kit to Mounting Device to enable easy mounting of wider devices like big smart-phones, e-books, small tablets, etc. It holds devices with width up to 140 mm.



Mounting Device for Hand-Held Transmitters



Mounting Device Adaptor for Wide-Phones

<Mounting Device for Laptops and other Body-Worn Transmitters>

The extension is lightweight and made of POM, acrylic glass and foam. It fits easily on the upper part of the mounting device in place of the phone positioned. The extension is fully compatible with the SAM Twin and ELI phantoms.



Mounting Device for Laptops

9. Measurement Procedures

The measurement procedures are as follows:

<Conducted power measurement>

- (a) For WWAN power measurement, use base station simulator to configure EUT WWAN transmission in conducted connection with RF cable, at maximum power in each supported wireless interface and frequency band.
- (b) Read the WWAN RF power level from the base station simulator.
- (c) For WLAN/BT power measurement, use engineering software to configure EUT WLAN/BT continuously transmission, at maximum RF power in each supported wireless interface and frequency band
- (d) Connect EUT RF port through RF cable to the power meter, and measure WLAN/BT output power

<SAR measurement>

- (a) Use base station simulator to configure EUT WWAN transmission in radiated connection, and engineering software to configure EUT WLAN/BT continuously transmission, at maximum RF power, in the highest power channel.
- (b) Place the EUT in the positions as Appendix D demonstrates.
- (c) Set scan area, grid size and other setting on the DASY software.
- (d) Measure SAR results for the highest power channel on each testing position.
- (e) Find out the largest SAR result on these testing positions of each band
- (f) Measure SAR results for other channels in worst SAR testing position if the reported SAR of highest power channel is larger than 0.8 W/kg

According to the test standard, the recommended procedure for assessing the peak spatial-average SAR value consists of the following steps:

- (a) Power reference measurement
- (b) Area scan
- (c) Zoom scan
- (d) Power drift measurement

9.1 Spatial Peak SAR Evaluation

The procedure for spatial peak SAR evaluation has been implemented according to the test standard. It can be conducted for 1g and 10g, as well as for user-specific masses. The DASY software includes all numerical procedures necessary to evaluate the spatial peak SAR value.

The base for the evaluation is a "cube" measurement. The measured volume must include the 1g and 10g cubes with the highest averaged SAR values. For that purpose, the center of the measured volume is aligned to the interpolated peak SAR value of a previously performed area scan.

The entire evaluation of the spatial peak values is performed within the post-processing engine (SEMCAD). The system always gives the maximum values for the 1g and 10g cubes. The algorithm to find the cube with highest averaged SAR is divided into the following stages:

- (a) Extraction of the measured data (grid and values) from the Zoom Scan
- (b) Calculation of the SAR value at every measurement point based on all stored data (A/D values and measurement parameters)
- (c) Generation of a high-resolution mesh within the measured volume
- (d) Interpolation of all measured values from the measurement grid to the high-resolution grid
- (e) Extrapolation of the entire 3-D field distribution to the phantom surface over the distance from sensor to surface
- (f) Calculation of the averaged SAR within masses of 1g and 10g

9.2 Power Reference Measurement

The Power Reference Measurement and Power Drift Measurements are for monitoring the power drift of the device under test in the batch process. The minimum distance of probe sensors to surface determines the closest measurement point to phantom surface. This distance cannot be smaller than the distance of sensor calibration points to probe tip as defined in the probe properties.

9.3 Area Scan

The area scan is used as a fast scan in two dimensions to find the area of high field values, before doing a fine measurement around the hot spot. The sophisticated interpolation routines implemented in DASY software can find the maximum found in the scanned area, within a range of the global maximum. The range (in dB0) is specified in the standards for compliance testing. For example, a 2 dB range is required in IEEE standard 1528 and IEC 62209 standards, whereby 3 dB is a requirement when compliance is assessed in accordance with the ARIB standard (Japan), if only one zoom scan follows the area scan, then only the absolute maximum will be taken as reference. For cases where multiple maximums are detected, the number of zoom scans has to be increased accordingly.

Area scan parameters extracted from FCC KDB 865664 D01v01r04 SAR measurement 100 MHz to 6 GHz.

	≤ 3 GHz	> 3 GHz
Maximum distance from closest measurement point (geometric center of probe sensors) to phantom surface	5 ± 1 mm	$\frac{1}{2} \cdot \delta \cdot \ln(2) \pm 0.5$ mm
Maximum probe angle from probe axis to phantom surface normal at the measurement location	30° ± 1°	20° ± 1°
Maximum area scan spatial resolution: Δx_{Area} , Δy_{Area}	≤ 2 GHz: ≤ 15 mm 2 – 3 GHz: ≤ 12 mm	3 – 4 GHz: ≤ 12 mm 4 – 6 GHz: ≤ 10 mm
	When the x or y dimension of the test device, in the measurement plane orientation, is smaller than the above, the measurement resolution must be ≤ the corresponding x or y dimension of the test device with at least one measurement point on the test device.	

9.4 Zoom Scan

Zoom scans are used assess the peak spatial SAR values within a cubic averaging volume containing 1 gram and 10 gram of simulated tissue. The zoom scan measures points (refer to table below) within a cube shoes base faces are centered on the maxima found in a preceding area scan job within the same procedure. When the measurement is done, the zoom scan evaluates the averaged SAR for 1 gram and 10 gram and displays these values next to the job's label.

Zoom scan parameters extracted from FCC KDB 865664 D01v01r04 SAR measurement 100 MHz to 6 GHz.

		≤ 3 GHz	> 3 GHz	
Maximum zoom scan spatial resolution: $\Delta x_{Zoom}, \Delta y_{Zoom}$		≤ 2 GHz: ≤ 8 mm 2 – 3 GHz: ≤ 5 mm*	3 – 4 GHz: ≤ 5 mm* 4 – 6 GHz: ≤ 4 mm*	
Maximum zoom scan spatial resolution, normal to phantom surface	uniform grid: $\Delta z_{Zoom}(n)$	≤ 5 mm	3 – 4 GHz: ≤ 4 mm 4 – 5 GHz: ≤ 3 mm 5 – 6 GHz: ≤ 2 mm	
	graded grid	$\Delta z_{Zoom}(1)$: between 1 st two points closest to phantom surface	≤ 4 mm	3 – 4 GHz: ≤ 3 mm 4 – 5 GHz: ≤ 2.5 mm 5 – 6 GHz: ≤ 2 mm
		$\Delta z_{Zoom}(n>1)$: between subsequent points	$\leq 1.5 \cdot \Delta z_{Zoom}(n-1)$	
Minimum zoom scan volume	x, y, z	≥ 30 mm	3 – 4 GHz: ≥ 28 mm 4 – 5 GHz: ≥ 25 mm 5 – 6 GHz: ≥ 22 mm	
<p>Note: δ is the penetration depth of a plane-wave at normal incidence to the tissue medium; see draft standard IEEE P1528-2011 for details.</p> <p>* When zoom scan is required and the <i>reported</i> SAR from the <i>area scan based 1-g SAR estimation</i> procedures of KDB 447498 is ≤ 1.4 W/kg, ≤ 8 mm, ≤ 7 mm and ≤ 5 mm zoom scan resolution may be applied, respectively, for 2 GHz to 3 GHz, 3 GHz to 4 GHz and 4 GHz to 6 GHz.</p>				

9.5 Volume Scan Procedures

The volume scan is used for assess overlapping SAR distributions for antennas transmitting in different frequency bands. It is equivalent to an oversized zoom scan used in standalone measurements. The measurement volume will be used to enclose all the simultaneous transmitting antennas. For antennas transmitting simultaneously in different frequency bands, the volume scan is measured separately in each frequency band. In order to sum correctly to compute the 1g aggregate SAR, the EUT remain in the same test position for all measurements and all volume scan use the same spatial resolution and grid spacing. When all volume scan were completed, the software, SEMCAD postprocessor can combine and subsequently superpose these measurement data to calculating the multiband SAR.

9.6 Power Drift Monitoring

All SAR testing is under the EUT install full charged battery and transmit maximum output power. In DASy measurement software, the power reference measurement and power drift measurement procedures are used for monitoring the power drift of EUT during SAR test. Both these procedures measure the field at a specified reference position before and after the SAR testing. The software will calculate the field difference in dB. If the power drifts more than 5%, the SAR will be retested.



10. Test Equipment List

Manufacturer	Name of Equipment	Type/Model	Serial Number	Calibration	
				Last Cal.	Due Date
SPEAG	750MHz System Validation Kit	D750V3	1099	Nov. 24, 2015	Nov. 23, 2016
SPEAG	835MHz System Validation Kit	D835V2	4d162	Nov. 24, 2015	Nov. 23, 2016
SPEAG	1750MHz System Validation Kit	D1750V2	1137	May 18, 2016	May 17, 2017
SPEAG	1900MHz System Validation Kit	D1900V2	5d182	Nov. 23, 2015	Nov. 22, 2016
SPEAG	2450MHz System Validation Kit	D2450V2	924	Feb. 24, 2016	Feb. 23, 2017
SPEAG	2600MHz System Validation Kit	D2600V2	1070	Nov. 25, 2015	Nov. 24, 2016
SPEAG	5000MHz System Validation Kit	D5GHzV2	1113	Nov. 26, 2015	Nov. 25, 2016
SPEAG	Data Acquisition Electronics	DAE4	917	Dec. 14, 2015	Dec. 13, 2016
SPEAG	Data Acquisition Electronics	DAE4	1338	Nov. 23, 2015	Nov. 22, 2016
SPEAG	Dosimetric E-Field Probe	EX3DV4	3819	Nov. 27, 2015	Nov. 26, 2016
SPEAG	Dosimetric E-Field Probe	EX3DV4	3911	Oct. 01, 2015	Sep. 30, 2016
SPEAG	ELI4 Phantom	QD OVA 002 AA	TP-1149	NCR	NCR
SPEAG	ELI4 Phantom	ELI5.0	1225	NCR	NCR
SPEAG	Phone Positioner	N/A	N/A	NCR	NCR
Anritsu	Radio communication analyzer	MT8820C	6201300653	Aug. 25, 2015	Aug. 24, 2016
Agilent	Wireless Communication Test Set	E5515C	MY50267224	Jul. 16, 2016	Jul. 15, 2017
Agilent	Network Analyzer	E5071C	MY46523671	Dec. 31, 2015	Dec. 30, 2016
Speag	Dielectric Assessment KIT	DAK-3.5	1071	Nov. 24, 2015	Nov. 23, 2016
Agilent	Signal Generator	N5181A	MY50145381	Jan. 12, 2016	Jan. 11, 2017
Anritsu	Power Sensor	MA2411B	1306099	Jan. 12, 2016	Jan. 11, 2017
Anritsu	Power Meter	ML2495A	1349001	Jan. 12, 2016	Jan. 11, 2017
Anritsu	Power Sensor	MA2411B	1207253	Jan. 12, 2016	Jan. 11, 2017
Anritsu	Power Meter	ML2495A	1218010	Jan. 12, 2016	Jan. 11, 2017
R&S	Spectrum Analyzer	FSP7	101634	Jul. 16, 2016	Jul. 15, 2017
PASTERNAK	Dual Directional Coupler	PE2214-10	N/A	Note1	
ARRA	Power Divider	A3200-2	NA	Note1	
Agilent	Dual Directional Coupler	778D	50422	Note1	
mini-circuits	Amplifier	ZVE-3W-83+	162601250	Note1	
AR	Amplifier	5S1G4	333096	Note1	
Woken	Attenuation1	WK0602-XX	N/A	Note1	
PE	Attenuation2	PE7005-10	N/A	Note1	
PE	Attenuation3	PE7005-3	N/A	Note1	

General Note:

1. Prior to system verification and validation, the path loss from the signal generator to the system check source and the power meter, which includes the amplifier, cable, attenuator and directional coupler, was measured by the network analyzer. The reading of the power meter was offset by the path loss difference between the path to the power meter and the path to the system check source to monitor the actual power level fed to the system check source.



11. System Verification

11.1 Tissue Verification

The following tissue formulations are provided for reference only as some of the parameters have not been thoroughly verified. The composition of ingredients may be modified accordingly to achieve the desired target tissue parameters required for routine SAR evaluation.

Frequency (MHz)	Water (%)	Sugar (%)	Cellulose (%)	Salt (%)	Preventol (%)	DGBE (%)	Conductivity (σ)	Permittivity (ϵ_r)
For Body								
750	51.7	47.2	0	0.9	0.1	0	0.96	55.5
835	50.8	48.2	0	0.9	0.1	0	0.97	55.2
1750	70.2	0	0	0.4	0	29.4	1.49	53.4
1800, 1900, 2000	70.2	0	0	0.4	0	29.4	1.52	53.3
2450	68.6	0	0	0	0	31.4	1.95	52.7
2600	68.1	0	0	0.1	0	31.8	2.16	52.5

Simulating Liquid for 5GHz, Manufactured by SPEAG

Ingredients	(% by weight)
Water	64~78%
Mineral oil	11~18%
Emulsifiers	9~15%
Additives and Salt	2~3%

<Tissue Dielectric Parameter Check Results>

Frequency (MHz)	Tissue Type	Liquid Temp. (°C)	Conductivity (σ)	Permittivity (ϵ_r)	Conductivity Target (σ)	Permittivity Target (ϵ_r)	Delta (σ) (%)	Delta (ϵ_r) (%)	Limit (%)	Date
750	Body	22.5	0.970	54.633	0.96	55.50	1.04	-1.56	±5	2016/7/21
835	Body	22.6	0.967	55.899	0.97	55.20	-0.31	1.27	±5	2016/7/21
835	Body	22.7	0.976	54.388	0.97	55.20	0.62	-1.47	±5	2016/7/22
1750	Body	22.8	1.522	52.519	1.49	53.40	2.15	-1.65	±5	2016/7/23
1750	Body	22.5	1.517	55.044	1.49	53.40	1.81	3.08	±5	2016/7/25
1900	Body	22.7	1.542	54.484	1.52	53.30	1.45	2.22	±5	2016/7/23
1900	Body	22.6	1.579	54.206	1.52	53.30	3.88	1.70	±5	2016/7/25
2450	Body	22.9	1.992	52.302	1.95	52.70	2.15	-0.76	±5	2016/8/3
2600	Body	22.9	2.209	51.123	2.16	52.50	2.27	-2.62	±5	2016/7/27
5250	Body	22.8	5.370	48.944	5.36	48.95	0.19	-0.01	±5	2016/8/6
5750	Body	22.6	6.025	48.112	5.94	48.28	1.43	-0.35	±5	2016/8/6

11.2 System Performance Check Results

Comparing to the original SAR value provided by SPEAG, the verification data should be within its specification of 10 %. Below table shows the target SAR and measured SAR after normalized to 1W input power. The table below indicates the system performance check can meet the variation criterion and the plots can be referred to Appendix A of this report.

Date	Frequency (MHz)	Tissue Type	Input Power (mW)	Dipole S/N	Probe S/N	DAE S/N	Measured 1g SAR (W/kg)	Targeted 1g SAR (W/kg)	Normalized 1g SAR (W/kg)	Deviation (%)
2016/7/21	750	Body	250	1099	3819	1338	2.15	8.82	8.6	-2.49
2016/7/21	835	Body	250	4d162	3819	1338	2.36	9.51	9.44	-0.74
2016/7/22	835	Body	250	4d162	3819	1338	2.25	9.51	9	-5.36
2016/7/23	1750	Body	250	1137	3819	1338	9.97	37.40	39.88	6.63
2016/7/25	1750	Body	250	1137	3911	917	9.87	37.40	39.48	5.56
2016/7/23	1900	Body	250	5d182	3819	1338	10.90	40.60	43.6	7.39
2016/7/25	1900	Body	250	5d182	3911	917	10.32	40.60	41.28	1.67
2016/8/3	2450	Body	250	924	3911	917	13.70	51.40	54.8	6.61
2016/7/27	2600	Body	250	1070	3911	917	14.60	54.20	58.4	7.75
2016/8/6	5250	Body	100	1113	3819	1338	7.72	76.50	77.2	0.92
2016/8/6	5750	Body	100	1113	3819	1338	8.19	76.60	81.9	6.92

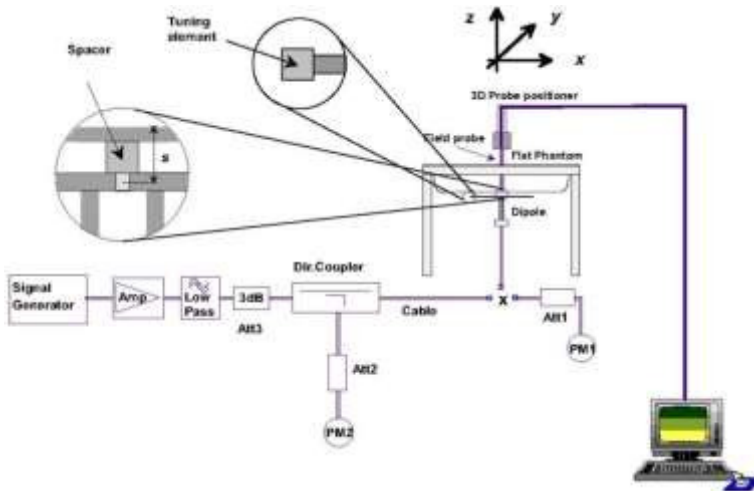

Fig 8.3.1 System Performance Check Setup



Fig 8.3.2 Setup Photo



12. RF Exposure Positions

12.1 SAR Testing for Tablet

This device can be used also in full sized tablet exposure conditions, due to its size. Per FCC KDB 616217, the back surface and edges of the tablet should be tested for SAR compliance with the tablet touching the phantom. The SAR exclusion threshold in KDB 447498 D01v06 can be applied to determine SAR test exclusion for adjacent edge configurations. The closest distance from the antenna to an adjacent tablet edge is used to determine if SAR testing is required for the adjacent edges, with the adjacent edge positioned against the phantom and the edge containing the antenna positioned perpendicular to the phantom.

This EUT was tested in five different positions. They are bottom-face of tablet PC, Edge1, Edge2, Edge3 and Edge4. EUT has proximity sensor function, it would be on bottom-face, Edge1 and Edge2, the distance is 9mm for bottom-face, 6mm for Edge1 and 5mm for Edge2, EUT transmitting reduced power was performed. Additionally the surface of EUT is touching with phantom 0 cm for Edge3 and Edge 4 with full power.



13. Conducted RF Output Power (Unit: dBm)

<GSM Conducted Power>

- Per KDB 447498 D01v06, the maximum output power channel is used for SAR testing and for further SAR test reduction.
- Per KDB 941225 D01v03r01, for SAR test reduction for GPRS and EDGE modes is determined by the frame-average power including tune-up tolerance, for modes with the same specified maximum output power and tolerance, the higher number time-slot configuration should be tested, therefore, the GPRS 2Tx slots modes was selected when EUT operating without power back-off and with power back-off, according to the highest frame-average power.

Maximum Average RF Power (Proximity Sensor Inactive)

GSM850 Tx Channel	Burst Average Power (dBm)			Tune-up Limit (dBm)	Frame-Average Power (dBm)			Tune-up Limit (dBm)
	128	189	251		128	189	251	
Frequency (MHz)	824.2	836.4	848.8		824.2	836.4	848.8	
GPRS 1 Tx slot	33.25	32.93	33.26	33.50	24.25	23.93	24.26	24.50
GPRS 2 Tx slots	30.87	30.93	30.94	31.50	24.87	24.93	24.94	25.50
GPRS 3 Tx slots	28.48	28.57	28.74	29.00	24.22	24.31	24.48	24.74
GPRS 4 Tx slots	27.01	27.12	27.30	27.50	24.01	24.12	24.30	24.50
EDGE 1 Tx slot	26.71	26.67	26.74	27.00	17.71	17.67	17.74	18.00
EDGE 2 Tx slots	26.07	26.06	26.08	26.50	20.07	20.06	20.08	20.50
EDGE 3 Tx slots	24.97	24.97	24.98	25.50	20.71	20.71	20.72	21.24
EDGE 4 Tx slots	23.73	23.77	23.76	24.00	20.73	20.77	20.76	21.00

Remark: The frame-averaged power is linearly scaled the maximum burst averaged power over 8 time slots.

The calculated method are shown as below:

- Frame-averaged power = Maximum burst averaged power (1 Tx Slot) - 9 dB
- Frame-averaged power = Maximum burst averaged power (2 Tx Slots) - 6 dB
- Frame-averaged power = Maximum burst averaged power (3 Tx Slots) - 4.26 dB
- Frame-averaged power = Maximum burst averaged power (4 Tx Slots) - 3 dB

GSM1900 Tx Channel	Burst Average Power (dBm)			Tune-up Limit (dBm)	Frame-Average Power (dBm)			Tune-up Limit (dBm)
	512	661	810		512	661	810	
Frequency (MHz)	1850.2	1880	1909.8		1850.2	1880	1909.8	
GPRS 1 Tx slot	28.85	29.10	29.08	29.50	19.85	20.10	20.08	20.50
GPRS 2 Tx slots	28.09	28.19	28.17	28.50	22.09	22.19	22.17	22.50
GPRS 3 Tx slots	25.65	25.69	25.65	26.00	21.39	21.43	21.39	21.74
GPRS 4 Tx slots	24.03	24.17	24.11	24.50	21.03	21.17	21.11	21.50
EDGE 1 Tx slot	25.75	25.74	25.78	26.00	16.75	16.74	16.78	17.00
EDGE 2 Tx slots	25.12	25.14	25.19	25.50	19.12	19.14	19.19	19.50
EDGE 3 Tx slots	23.96	23.97	24.03	24.50	19.70	19.71	19.77	20.24
EDGE 4 Tx slots	22.73	22.81	22.87	23.00	19.73	19.81	19.87	20.00

Remark: The frame-averaged power is linearly scaled the maximum burst averaged power over 8 time slots.

The calculated method are shown as below:

- Frame-averaged power = Maximum burst averaged power (1 Tx Slot) - 9 dB
- Frame-averaged power = Maximum burst averaged power (2 Tx Slots) - 6 dB
- Frame-averaged power = Maximum burst averaged power (3 Tx Slots) - 4.26 dB
- Frame-averaged power = Maximum burst averaged power (4 Tx Slots) - 3 dB



Reduced Average RF Power (Proximity Sensor active)

GSM850 TX Channel	Burst Average Power (dBm)			Tune-up Limit (dBm)	Frame-Average Power (dBm)			Tune-up Limit (dBm)
	128	189	251		128	189	251	
Frequency (MHz)	824.2	836.4	848.8		824.2	836.4	848.8	
GPRS 1 Tx slot	25.10	25.15	25.19	25.50	16.10	16.15	16.19	16.50
GPRS 2 Tx slots	23.13	23.22	23.23	23.50	17.13	17.22	17.23	17.50
GPRS 3 Tx slots	20.80	20.91	21.01	21.50	16.54	16.65	16.75	17.24
GPRS 4 Tx slots	18.25	19.37	19.50	20.00	15.25	16.37	16.50	17.00
EDGE 1 Tx slot	19.04	19.11	19.21	19.50	10.04	10.11	10.21	10.50
EDGE 2 Tx slots	18.01	18.11	18.13	18.50	12.01	12.11	12.13	12.50
EDGE 3 Tx slots	17.03	17.14	17.17	17.50	12.77	12.88	12.91	13.24
EDGE 4 Tx slots	16.02	16.17	16.21	16.50	13.02	13.17	13.21	13.50

Remark: The frame-averaged power is linearly scaled the maximum burst averaged power over 8 time slots.

The calculated method are shown as below:

- Frame-averaged power = Maximum burst averaged power (1 Tx Slot) - 9 dB
- Frame-averaged power = Maximum burst averaged power (2 Tx Slots) - 6 dB
- Frame-averaged power = Maximum burst averaged power (3 Tx Slots) - 4.26 dB
- Frame-averaged power = Maximum burst averaged power (4 Tx Slots) - 3 dB

GSM1900 TX Channel	Burst Average Power (dBm)			Tune-up Limit (dBm)	Frame-Average Power (dBm)			Tune-up Limit (dBm)
	512	661	810		512	661	810	
Frequency (MHz)	1850.2	1880	1909.8		1850.2	1880	1909.8	
GPRS 1 Tx slot	20.00	20.14	20.12	20.50	11.00	11.14	11.12	11.50
GPRS 2 Tx slots	17.88	18.13	18.10	18.50	11.88	12.13	12.10	12.50
GPRS 3 Tx slots	15.87	16.09	16.06	16.50	11.61	11.83	11.80	12.24
GPRS 4 Tx slots	14.55	14.66	14.65	15.00	11.55	11.66	11.65	12.00
EDGE 1 Tx slot	16.18	16.26	16.34	16.50	7.18	7.26	7.34	7.50
EDGE 2 Tx slots	15.20	15.37	15.43	15.50	9.20	9.37	9.43	9.50
EDGE 3 Tx slots	14.35	14.43	14.55	15.00	10.09	10.17	10.29	10.74
EDGE 4 Tx slots	13.57	13.61	13.76	14.00	10.57	10.61	10.76	11.00

Remark: The frame-averaged power is linearly scaled the maximum burst averaged power over 8 time slots.

The calculated method are shown as below:

- Frame-averaged power = Maximum burst averaged power (1 Tx Slot) - 9 dB
- Frame-averaged power = Maximum burst averaged power (2 Tx Slots) - 6 dB
- Frame-averaged power = Maximum burst averaged power (3 Tx Slots) - 4.26 dB
- Frame-averaged power = Maximum burst averaged power (4 Tx Slots) - 3 dB



<WCDMA Conducted Power>

1. The following tests were conducted according to the test requirements outlines in 3GPP TS 34.121 specification.
2. The procedures in KDB 941225 D01v03r01 are applied for 3GPP Rel. 6 HSPA to configure the device in the required sub-test mode(s) to determine SAR test exclusion.
3. For DC-HSDPA, the device was configured according to the H-Set 12, Fixed Reference Channel (FRC) configuration in Table C.8.1.12 of 3GPP TS 34.121-1, with the primary and the secondary serving HS-DSCH Cell enabled during the power measurement.

A summary of these settings are illustrated below:

HSDPA Setup Configuration:

- a. The EUT was connected to Base Station Agilent E5515C referred to the Setup Configuration.
- b. The RF path losses were compensated into the measurements.
- c. A call was established between EUT and Base Station with following setting:
 - i. Set Gain Factors (β_c and β_d) and parameters were set according to each
 - ii. Specific sub-test in the following table, C10.1.4, quoted from the TS 34.121
 - iii. Set RMC 12.2Kbps + HSDPA mode.
 - iv. Set Cell Power = -86 dBm
 - v. Set HS-DSCH Configuration Type to FRC (H-set 1, QPSK)
 - vi. Select HSDPA Uplink Parameters
 - vii. Set Delta ACK, Delta NACK and Delta CQI = 8
 - viii. Set Ack-Nack Repetition Factor to 3
 - ix. Set CQI Feedback Cycle (k) to 4 ms
 - x. Set CQI Repetition Factor to 2
 - xi. Power Ctrl Mode = All Up bits
- d. The transmitted maximum output power was recorded.

Table C.10.1.4: β values for transmitter characteristics tests with HS-DPCCH

Sub-test	β_c	β_d	β_d (SF)	β_c/β_d	β_{HS} (Note 1, Note 2)	CM (dB) (Note 3)	MPR (dB) (Note 3)
1	2/15	15/15	64	2/15	4/15	0.0	0.0
2	12/15 (Note 4)	15/15 (Note 4)	64	12/15 (Note 4)	24/15	1.0	0.0
3	15/15	8/15	64	15/8	30/15	1.5	0.5
4	15/15	4/15	64	15/4	30/15	1.5	0.5

Note 1: $\Delta_{ACK}, \Delta_{NACK}$ and $\Delta_{CQI} = 30/15$ with $\beta_{HS} = 30/15 * \beta_c$.

Note 2: For the HS-DPCCH power mask requirement test in clause 5.2C, 5.7A, and the Error Vector Magnitude (EVM) with HS-DPCCH test in clause 5.13.1A, and HSDPA EVM with phase discontinuity in clause 5.13.1AA, Δ_{ACK} and $\Delta_{NACK} = 30/15$ with $\beta_{HS} = 30/15 * \beta_c$, and $\Delta_{CQI} = 24/15$ with $\beta_{HS} = 24/15 * \beta_c$.

Note 3: CM = 1 for $\beta_c/\beta_d = 12/15, \beta_{HS}/\beta_c = 24/15$. For all other combinations of DPCCH, DPDCCH and HS-DPCCH the MPR is based on the relative CM difference. This is applicable for only UEs that support HSDPA in release 6 and later releases.

Note 4: For subtest 2 the β_c/β_d ratio of 12/15 for the TFC during the measurement period (TF1, TF0) is achieved by setting the signalled gain factors for the reference TFC (TF1, TF1) to $\beta_c = 11/15$ and $\beta_d = 15/15$.

Setup Configuration

HSUPA Setup Configuration:

- a. The EUT was connected to Base Station Agilent E5515C referred to the Setup Configuration.
- b. The RF path losses were compensated into the measurements.
- c. A call was established between EUT and Base Station with following setting * :
 - i. Call Configs = 5.2B, 5.9B, 5.10B, and 5.13.2B with QPSK
 - ii. Set the Gain Factors (β_c and β_d) and parameters (AG Index) were set according to each specific sub-test in the following table, C11.1.3, quoted from the TS 34.121
 - iii. Set Cell Power = -86 dBm
 - iv. Set Channel Type = 12.2k + HSPA
 - v. Set UE Target Power
 - vi. Power Ctrl Mode= Alternating bits
 - vii. Set and observe the E-TFCl
 - viii. Confirm that E-TFCl is equal to the target E-TFCl of 75 for sub-test 1, and other subtest's E-TFCl
- d. The transmitted maximum output power was recorded.

Table C.11.1.3: β values for transmitter characteristics tests with HS-DPCCH and E-DCH

Sub-test	β_c	β_d	β_d (SF)	β_c/β_d	β_{HS} (Note 1)	β_{ec}	β_{ed} (Note 5) (Note 6)	β_{ed} (SF)	β_{ed} (Codes)	CM (dB) (Note 2)	MPR (dB) (Note 2)	AG Index (Note 6)	E-TFCl
1	11/15 (Note 3)	15/15 (Note 3)	64	11/15 (Note 3)	22/15	209/25	1309/225	4	1	1.0	0.0	20	75
2	6/15	15/15	64	6/15	12/15	12/15	94/75	4	1	3.0	2.0	12	67
3	15/15	9/15	64	15/9	30/15	30/15	$\beta_{ed1}: 47/15$ $\beta_{ed2}: 47/15$	4	2	2.0	1.0	15	92
4	2/15	15/15	64	2/15	4/15	2/15	56/75	4	1	3.0	2.0	17	71
5	15/15 (Note 4)	15/15 (Note 4)	64	15/15 (Note 4)	30/15	24/15	134/15	4	1	1.0	0.0	21	81

Note 1: $\Delta_{ACK}, \Delta_{NACK}$ and $\Delta_{CGI} = 30/15$ with $\beta_{HS} = 30/15 * \beta_c$.

Note 2: CM = 1 for $\beta_c/\beta_d = 12/15$, $\beta_{HS}/\beta_c = 24/15$. For all other combinations of DPDCH, DPCCH, HS-DPCCH, E-DPDCH and E-DPCCH the MPR is based on the relative CM difference.

Note 3: For subtest 1 the β_c/β_d ratio of 11/15 for the TFC during the measurement period (TF1, TF0) is achieved by setting the signalled gain factors for the reference TFC (TF1, TF1) to $\beta_c = 10/15$ and $\beta_d = 15/15$.

Note 4: For subtest 5 the β_c/β_d ratio of 15/15 for the TFC during the measurement period (TF1, TF0) is achieved by setting the signalled gain factors for the reference TFC (TF1, TF1) to $\beta_c = 14/15$ and $\beta_d = 15/15$.

Note 5: In case of testing by UE using E-DPDCH Physical Layer category 1, Sub-test 3 is omitted according to TS25.306 Table 5.1g.

Note 6: β_{ed} can not be set directly, it is set by Absolute Grant Value.

Setup Configuration

DC-HSDPA 3GPP release 8 Setup Configuration:

- a. The EUT was connected to Base Station Agilent E5515C referred to the Setup Configuration below
- b. The RF path losses were compensated into the measurements.
- c. A call was established between EUT and Base Station with following setting:
 - i. Set RMC 12.2Kbps + HSDPA mode.
 - ii. Set Cell Power = -25 dBm
 - iii. Set HS-DSCH Configuration Type to FRC (H-set 12, QPSK)
 - iv. Select HSDPA Uplink Parameters
 - v. Set Gain Factors (β_c and β_d) and parameters were set according to each Specific sub-test in the following table, C10.1.4, quoted from the TS 34.121
 - a). Subtest 1: $\beta_c/\beta_d=2/15$
 - b). Subtest 2: $\beta_c/\beta_d=12/15$
 - c). Subtest 3: $\beta_c/\beta_d=15/8$
 - d). Subtest 4: $\beta_c/\beta_d=15/4$
 - vi. Set Delta ACK, Delta NACK and Delta CQI = 8
 - vii. Set Ack-Nack Repetition Factor to 3
 - viii. Set CQI Feedback Cycle (k) to 4 ms
 - ix. Set CQI Repetition Factor to 2
 - x. Power Ctrl Mode = All Up bits
- d. The transmitted maximum output power was recorded.

The following tests were conducted according to the test requirements outlines in 3GPP TS 34.121 specification. A summary of these settings are illustrated below:

C.8.1.12 Fixed Reference Channel Definition H-Set 12

Table C.8.1.12: Fixed Reference Channel H-Set 12

Parameter	Unit	Value
Nominal Avg. Inf. Bit Rate	kbps	60
Inter-TTI Distance	TTI's	1
Number of HARQ Processes	Processes	6
Information Bit Payload (N_{inf})	Bits	120
Number Code Blocks	Blocks	1
Binary Channel Bits Per TTI	Bits	960
Total Available SML's in UE	SML's	19200
Number of SML's per HARQ Proc.	SML's	3200
Coding Rate		0.15
Number of Physical Channel Codes	Codes	1
Modulation		QPSK

Note 1: The RMC is intended to be used for DC-HSDPA mode and both cells shall transmit with identical parameters as listed in the table.

Note 2: Maximum number of transmission is limited to 1, i.e., retransmission is not allowed. The redundancy and constellation version 0 shall be used.

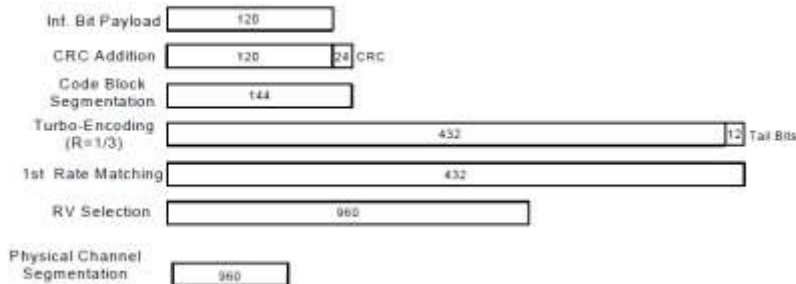

Figure C.8.19: Coding rate for Fixed reference Channel H-Set 12 (QPSK)

Setup Configuration



<WCDMA Conducted Power>

General Note:

- Per KDB 941225 D01v03r01, for SAR testing is measured using a 12.2 kbps RMC with TPC bits configured to all "1's".
- Per KDB 941225 D01v03r01, RMC 12.2kbps setting is used to evaluate SAR. If the maximum output power and tune-up tolerance specified for production units in HSDPA / HSUPA / DC-HSDPA is $\leq \frac{1}{4}$ dB higher than RMC 12.2Kbps or when the highest reported SAR of the RMC12.2Kbps is scaled by the ratio of specified maximum output power and tune-up tolerance of HSDPA / HSUPA / DC-HSDPA to RMC12.2Kbps and the adjusted SAR is ≤ 1.2 W/kg, SAR measurement is not required for HSDPA / HSUPA / DC-HSDPA.

Maximum Average RF Power (Proximity Sensor Inactive)

Band		WCDMA Band II			Tune-up Limit (dBm)	WCDMA Band IV			Tune-up Limit (dBm)	WCDMA Band V			Tune-up Limit (dBm)
Tx Channel		9262	9400	9538		1312	1413	1513		4132	4182	4233	
Rx Channel		9662	9800	9938		1537	1638	1738		4357	4407	4458	
Frequency (MHz)		1852.4	1880	1907.6		1712.4	1732.6	1752.6		826.4	836.4	846.6	
3GPP Rel 99	RMC 12.2Kbps	23.32	23.40	23.47	24.00	23.12	23.16	23.23	24.00	23.28	23.26	23.42	24.00
3GPP Rel 6	HSDPA Subtest-1	22.08	22.09	22.12	22.50	21.94	22.07	22.03	22.50	22.06	22.08	22.15	22.50
3GPP Rel 6	HSDPA Subtest-2	22.19	22.15	22.21	22.50	22.01	22.06	22.16	22.50	22.28	22.19	22.28	22.50
3GPP Rel 6	HSDPA Subtest-3	21.69	21.76	21.74	22.00	21.53	21.62	21.70	22.00	21.79	21.69	21.78	22.00
3GPP Rel 6	HSDPA Subtest-4	21.70	21.66	21.74	22.00	21.53	21.61	21.69	22.00	21.70	21.69	21.78	22.00
3GPP Rel 8	DC-HSDPA Subtest-1	22.05	22.11	22.15	22.50	21.85	21.91	21.94	22.50	22.14	22.10	22.20	22.50
3GPP Rel 8	DC-HSDPA Subtest-2	22.13	22.10	22.17	22.50	21.92	21.97	22.07	22.50	22.23	22.14	22.23	22.50
3GPP Rel 8	DC-HSDPA Subtest-3	21.58	21.73	21.70	22.00	21.40	21.50	21.54	22.00	21.71	21.61	21.70	22.00
3GPP Rel 8	DC-HSDPA Subtest-4	21.60	21.62	21.64	22.00	21.44	21.53	21.60	22.00	21.65	21.64	21.73	22.00
3GPP Rel 6	HSUPA Subtest-1	21.68	22.07	22.29	22.50	21.98	21.78	21.53	22.50	21.51	21.70	22.11	22.50
3GPP Rel 6	HSUPA Subtest-2	20.65	21.07	20.55	21.50	20.61	21.00	21.20	21.50	21.04	21.03	21.23	21.50
3GPP Rel 6	HSUPA Subtest-3	21.01	21.09	20.45	21.50	21.02	20.64	21.12	21.50	21.15	20.92	20.86	21.50
3GPP Rel 6	HSUPA Subtest-4	21.37	21.25	21.45	21.50	20.92	21.19	21.33	21.50	21.13	21.21	21.56	22.00
3GPP Rel 6	HSUPA Subtest-5	22.20	22.20	22.20	22.50	21.90	22.00	22.10	22.50	22.10	22.00	22.30	22.50

Reduced Average RF Power (Proximity Sensor active)

Band		WCDMA Band II			Tune-up Limit (dBm)	WCDMA Band IV			Tune-up Limit (dBm)	WCDMA Band V			Tune-up Limit (dBm)
Tx Channel		9262	9400	9538		1312	1413	1513		4132	4182	4233	
Rx Channel		9662	9800	9938		1537	1638	1738		4357	4407	4458	
Frequency (MHz)		1852.4	1880	1907.6		1712.4	1732.6	1752.6		826.4	836.4	846.6	
3GPP Rel 99	RMC 12.2Kbps	13.70	13.91	13.92	14.50	13.47	13.50	13.71	14.00	15.60	15.38	15.72	16.00
3GPP Rel 6	HSDPA Subtest-1	12.42	12.64	12.44	13.00	12.29	12.30	12.69	13.00	14.25	14.19	14.48	14.50
3GPP Rel 6	HSDPA Subtest-2	12.45	12.61	12.42	13.00	12.25	12.26	12.64	13.00	14.24	14.18	14.47	14.50
3GPP Rel 6	HSDPA Subtest-3	11.94	12.11	11.91	12.50	11.74	11.75	12.14	12.50	13.73	13.66	13.96	14.00
3GPP Rel 6	HSDPA Subtest-4	11.94	12.10	11.91	12.50	11.72	11.74	12.13	12.50	13.73	13.66	13.95	14.00
3GPP Rel 8	DC-HSDPA Subtest-1	12.36	12.52	12.38	13.00	12.22	12.23	12.62	13.00	14.16	14.10	14.39	14.50
3GPP Rel 8	DC-HSDPA Subtest-2	12.37	12.55	12.36	13.00	12.18	12.19	12.57	13.00	14.13	14.09	14.38	14.50
3GPP Rel 8	DC-HSDPA Subtest-3	11.88	12.05	11.85	12.50	11.67	11.68	12.07	12.50	13.64	13.57	13.85	14.00
3GPP Rel 8	DC-HSDPA Subtest-4	11.85	12.03	11.81	12.50	11.65	11.62	12.03	12.50	13.62	13.53	13.82	14.00
3GPP Rel 6	HSUPA Subtest-1	11.78	12.31	12.32	12.50	12.25	12.05	12.00	12.50	13.75	13.81	13.88	14.00
3GPP Rel 6	HSUPA Subtest-2	11.76	12.01	11.78	12.50	11.32	11.52	11.63	12.00	13.33	13.38	13.45	13.50
3GPP Rel 6	HSUPA Subtest-3	11.56	11.78	11.43	12.00	11.57	11.41	11.58	12.00	13.38	13.31	13.32	13.50
3GPP Rel 6	HSUPA Subtest-4	11.79	11.68	11.88	12.00	11.61	11.83	11.85	12.00	13.40	13.42	13.52	14.00
3GPP Rel 6	HSUPA Subtest-5	12.20	12.20	12.20	12.50	12.00	12.10	12.00	12.50	14.00	14.10	14.20	14.50

**<LTE Conducted Power>****General Note:**

1. Anritsu MT8820C base station simulator was used to setup the connection with EUT; the frequency band, channel bandwidth, RB allocation configuration, modulation type are set in the base station simulator to configure EUT transmitting at maximum power and at different configurations which are requested to be reported to FCC, for conducted power measurement and SAR testing.
2. Per KDB 941225 D05v02r05, when a properly configured base station simulator is used for the SAR and power measurements, spectrum plots for each RB allocation and offset configuration is not required.
3. Per KDB 941225 D05v02r05, start with the largest channel bandwidth and measure SAR for QPSK with 1 RB allocation, using the RB offset and required test channel combination with the highest maximum output power for RB offsets at the upper edge, middle and lower edge of each required test channel.
4. Per KDB 941225 D05v02r05, 50% RB allocation for QPSK SAR testing follows 1RB QPSK allocation procedure.
5. Per KDB 941225 D05v02r05, For QPSK with 100% RB allocation, SAR is not required when the highest maximum output power for 100 % RB allocation is less than the highest maximum output power in 50% and 1 RB allocations and the highest reported SAR for 1 RB and 50% RB allocation are ≤ 0.8 W/kg. Otherwise, SAR is measured for the highest output power channel; and if the reported SAR is > 1.45 W/kg, the remaining required test channels must also be tested.
6. Per KDB 941225 D05v02r05, 16QAM output power for each RB allocation configuration is $>$ not $\frac{1}{2}$ dB higher than the same configuration in QPSK and the reported SAR for the QPSK configuration is ≤ 1.45 W/kg; Per KDB 941225 D05v02r05, 16QAM SAR testing is not required.
7. Per KDB 941225 D05v02r05, smaller bandwidth output power for each RB allocation configuration is $>$ not $\frac{1}{2}$ dB higher than the same configuration in the largest supported bandwidth, and the reported SAR for the largest supported bandwidth is ≤ 1.45 W/kg; Per KDB 941225 D05v02r05, smaller bandwidth SAR testing is not required.
8. For LTE B12 / B5 / B4 the maximum bandwidth does not support three non-overlapping channels, per KDB 941225 D05v02r05, when a device supports overlapping channel assignment in a channel bandwidth configuration, the middle channel of the group of overlapping channels should be selected for testing.
9. LTE band 17 SAR test was covered by Band 12; according to April 2015 TCB workshop, SAR test for overlapping LTE bands can be reduced if
 - a. the maximum output power, including tolerance, for the smaller band is \leq the larger band to qualify for the SAR test exclusion
 - b. the channel bandwidth and other operating parameters for the smaller band are fully supported by the larger band



Maximum Average RF Power (Proximity Sensor Inactive)

<LTE Band 2>

BW [MHz]	Modulation	RB Size	RB Offset	Power Low Ch. / Freq.	Power Middle Ch. / Freq.	Power High Ch. / Freq.	Tune-up limit (dBm)	MPR (dB)
Channel				18700	18900	19100		
Frequency (MHz)				1860	1880	1900		
20	QPSK	1	0	23.12	23.13	23.09	23.50	0
20	QPSK	1	49	23.04	23.03	22.84		
20	QPSK	1	99	22.56	22.55	22.50		
20	QPSK	50	0	22.05	21.98	21.93	22.50	1
20	QPSK	50	24	22.04	21.93	21.95		
20	QPSK	50	50	22.06	22.07	21.96		
20	QPSK	100	0	22.05	22.06	21.98	22.50	1
20	16QAM	1	0	22.48	21.85	22.32		
20	16QAM	1	49	22.28	22.10	22.08		
20	16QAM	1	99	21.95	22.04	21.70	21.50	2
20	16QAM	50	0	21.04	21.13	20.98		
20	16QAM	50	24	20.85	20.97	21.03		
20	16QAM	50	50	20.93	20.92	21.05	21.50	2
20	16QAM	100	0	20.98	21.06	21.06		
Channel				18675	18900	19125		
Frequency (MHz)				1857.5	1880	1902.5		
15	QPSK	1	0	23.05	22.89	22.98	23.50	0
15	QPSK	1	37	22.85	23.04	22.83		
15	QPSK	1	74	22.70	22.97	22.55		
15	QPSK	36	0	21.99	21.97	21.95	22.50	1
15	QPSK	36	20	21.89	21.95	21.96		
15	QPSK	36	39	22.03	22.04	21.93		
15	QPSK	75	0	21.91	21.95	21.93	22.50	1
15	16QAM	1	0	22.42	22.00	22.41		
15	16QAM	1	37	21.62	22.36	22.37		
15	16QAM	1	74	21.79	22.11	22.13	21.50	2
15	16QAM	36	0	20.89	21.04	20.96		
15	16QAM	36	20	20.91	21.02	20.96		
15	16QAM	36	39	21.08	21.03	20.91	21.50	2
15	16QAM	75	0	20.98	20.90	20.94		



Channel				18650	18900	19150	Tune-up limit (dBm)	MPR (dB)
Frequency (MHz)				1855	1880	1905		
10	QPSK	1	0	23.06	22.90	23.02	23.50	0
10	QPSK	1	25	22.82	22.88	22.92		
10	QPSK	1	49	22.90	23.00	22.85		
10	QPSK	25	0	22.00	21.97	21.92	22.50	1
10	QPSK	25	12	21.89	21.95	21.96		
10	QPSK	25	25	21.88	21.92	21.93		
10	QPSK	50	0	21.89	21.85	21.98		
10	16QAM	1	0	22.15	21.44	22.21	22.50	1
10	16QAM	1	25	22.07	21.53	22.17		
10	16QAM	1	49	22.09	22.05	22.08		
10	16QAM	25	0	20.97	21.06	20.98	21.50	2
10	16QAM	25	12	20.99	20.98	21.01		
10	16QAM	25	25	20.87	20.99	20.83		
10	16QAM	50	0	20.92	20.83	20.94		
Channel				18625	18900	19175	Tune-up limit (dBm)	MPR (dB)
Frequency (MHz)				1852.5	1880	1907.5		
5	QPSK	1	0	23.07	23.03	22.91	23.50	0
5	QPSK	1	12	23.03	23.00	22.97		
5	QPSK	1	24	22.79	22.88	22.62		
5	QPSK	12	0	22.08	21.98	21.88	22.50	1
5	QPSK	12	7	21.97	21.83	21.88		
5	QPSK	12	13	21.89	21.95	21.81		
5	QPSK	25	0	21.87	21.90	21.90		
5	16QAM	1	0	22.43	22.18	22.41	22.50	1
5	16QAM	1	12	22.40	21.98	22.16		
5	16QAM	1	24	22.40	22.20	22.13		
5	16QAM	12	0	20.93	20.91	20.73	21.50	2
5	16QAM	12	7	20.82	20.79	20.80		
5	16QAM	12	13	20.92	21.01	20.76		
5	16QAM	25	0	20.95	20.94	20.96		



Channel				18615	18900	19185	Tune-up limit (dBm)	MPR (dB)
Frequency (MHz)				1851.5	1880	1908.5		
3	QPSK	1	0	23.00	22.87	22.76	23.50	0
3	QPSK	1	8	22.72	22.63	22.56		
3	QPSK	1	14	22.76	22.95	22.99		
3	QPSK	8	0	22.10	21.91	21.92	22.50	1
3	QPSK	8	4	21.96	21.86	21.95		
3	QPSK	8	7	21.96	21.92	22.10		
3	QPSK	15	0	21.95	21.84	21.98		
3	16QAM	1	0	22.33	22.29	22.22	22.50	1
3	16QAM	1	8	22.17	22.39	22.04		
3	16QAM	1	14	22.12	22.48	21.69		
3	16QAM	8	0	21.12	20.79	20.67	21.50	2
3	16QAM	8	4	20.98	20.95	20.68		
3	16QAM	8	7	21.12	20.79	20.88		
3	16QAM	15	0	20.60	20.64	20.72		
Channel				18607	18900	19193	Tune-up limit (dBm)	MPR (dB)
Frequency (MHz)				1850.7	1880	1909.3		
1.4	QPSK	1	0	23.04	22.87	23.00	23.50	0
1.4	QPSK	1	3	22.97	22.78	22.81		
1.4	QPSK	1	5	22.92	22.76	22.62		
1.4	QPSK	3	0	23.01	22.83	22.88		
1.4	QPSK	3	1	23.01	22.75	22.84		
1.4	QPSK	3	3	23.02	22.84	23.04	22.50	1
1.4	QPSK	6	0	22.01	21.97	21.87		
1.4	16QAM	1	0	22.49	22.12	21.95	22.50	1
1.4	16QAM	1	3	22.41	21.92	21.96		
1.4	16QAM	1	5	22.34	21.75	21.64		
1.4	16QAM	3	0	22.32	21.77	21.79		
1.4	16QAM	3	1	22.34	22.16	22.45		
1.4	16QAM	3	3	22.31	22.31	21.65	21.50	2
1.4	16QAM	6	0	20.94	20.84	20.57		



<LTE Band 4>

BW [MHz]	Modulation	RB Size	RB Offset	Power Low Ch. / Freq.	Power Middle Ch. / Freq.	Power High Ch. / Freq.	Tune-up limit (dBm)	MPR (dB)
Channel				20050	20175	20300		
Frequency (MHz)				1720	1732.5	1745		
20	QPSK	1	0	23.07	22.98	23.08	24.00	0
20	QPSK	1	49	22.85	22.92	22.85		
20	QPSK	1	99	22.38	22.78	22.77		
20	QPSK	50	0	22.03	21.95	22.05	23.00	1
20	QPSK	50	24	21.82	21.82	21.86		
20	QPSK	50	50	21.63	21.84	21.74		
20	QPSK	100	0	21.71	21.73	21.89	23.00	1
20	16QAM	1	0	22.32	21.81	22.16		
20	16QAM	1	49	22.29	22.05	22.17		
20	16QAM	1	99	21.67	21.94	22.21	22.00	2
20	16QAM	50	0	20.93	20.82	20.97		
20	16QAM	50	24	20.75	20.79	20.76		
20	16QAM	50	50	20.68	20.79	20.77	22.00	2
20	16QAM	100	0	20.87	20.67	20.96		
Channel				20025	20175	20325		
Frequency (MHz)				1717.5	1732.5	1747.5		
15	QPSK	1	0	23.02	22.89	23.00	24.00	0
15	QPSK	1	37	22.65	22.72	22.84		
15	QPSK	1	74	22.68	22.62	22.96		
15	QPSK	36	0	21.87	21.74	21.88	23.00	1
15	QPSK	36	20	21.79	21.78	21.84		
15	QPSK	36	39	21.72	21.84	21.76		
15	QPSK	75	0	21.70	21.73	22.00	23.00	1
15	16QAM	1	0	22.07	22.43	22.21		
15	16QAM	1	37	21.88	21.83	22.13		
15	16QAM	1	74	22.00	21.87	22.04	22.00	2
15	16QAM	36	0	20.77	20.68	20.87		
15	16QAM	36	20	20.69	20.74	20.84		
15	16QAM	36	39	20.55	20.76	20.82	22.00	2
15	16QAM	75	0	20.75	20.77	20.87		



Channel				20000	20175	20350	Tune-up limit (dBm)	MPR (dB)
Frequency (MHz)				1715	1732.5	1750		
10	QPSK	1	0	22.70	22.65	22.99	24.00	0
10	QPSK	1	25	22.64	22.82	22.89		
10	QPSK	1	49	22.81	22.52	22.82		
10	QPSK	25	0	21.80	21.70	21.94	23.00	1
10	QPSK	25	12	21.78	21.72	21.93		
10	QPSK	25	25	21.74	21.80	21.83		
10	QPSK	50	0	21.71	21.70	21.88	23.00	1
10	16QAM	1	0	21.87	21.87	22.08		
10	16QAM	1	25	21.93	22.30	22.19		
10	16QAM	1	49	21.64	21.74	22.33	22.00	2
10	16QAM	25	0	20.72	20.78	20.93		
10	16QAM	25	12	20.71	20.81	20.97		
10	16QAM	25	25	20.61	20.79	20.95	22.00	2
10	16QAM	50	0	20.74	20.67	20.89		
10	16QAM	50	0	20.74	20.67	20.89		
Channel				19975	20175	20375	Tune-up limit (dBm)	MPR (dB)
Frequency (MHz)				1712.5	1732.5	1752.5		
5	QPSK	1	0	23.03	22.85	22.93	24.00	0
5	QPSK	1	12	22.94	22.78	23.02		
5	QPSK	1	24	22.78	22.85	22.92		
5	QPSK	12	0	21.80	21.73	21.84	23.00	1
5	QPSK	12	7	21.67	21.76	21.82		
5	QPSK	12	13	21.80	21.79	21.93		
5	QPSK	25	0	21.73	21.74	21.93	23.00	1
5	16QAM	1	0	22.32	21.85	22.42		
5	16QAM	1	12	22.14	21.54	22.21		
5	16QAM	1	24	21.90	21.65	21.94	22.00	2
5	16QAM	12	0	20.78	20.66	21.16		
5	16QAM	12	7	20.63	20.60	21.12		
5	16QAM	12	13	20.72	20.89	21.21	22.00	2
5	16QAM	25	0	20.83	20.73	20.86		



Channel				19965	20175	20385	Tune-up limit (dBm)	MPR (dB)
Frequency (MHz)				1711.5	1732.5	1753.5		
3	QPSK	1	0	22.72	22.67	23.03	24.00	0
3	QPSK	1	8	22.77	22.69	22.93		
3	QPSK	1	14	22.71	22.88	23.04		
3	QPSK	8	0	21.78	21.74	21.87	23.00	1
3	QPSK	8	4	21.82	21.84	21.97		
3	QPSK	8	7	21.72	21.87	21.99		
3	QPSK	15	0	21.79	21.76	21.89		
3	16QAM	1	0	21.92	21.94	22.04	23.00	1
3	16QAM	1	8	22.24	21.96	22.18		
3	16QAM	1	14	21.85	22.44	22.06		
3	16QAM	8	0	20.92	20.70	21.09	22.00	2
3	16QAM	8	4	20.98	20.93	21.08		
3	16QAM	8	7	20.97	20.94	21.00		
3	16QAM	15	0	20.91	20.92	21.02		
Channel				19957	20175	20393	Tune-up limit (dBm)	MPR (dB)
Frequency (MHz)				1710.7	1732.5	1754.3		
1.4	QPSK	1	0	22.62	22.65	22.98	24.00	0
1.4	QPSK	1	3	22.86	22.81	22.99		
1.4	QPSK	1	5	22.81	22.79	22.75		
1.4	QPSK	3	0	22.76	22.75	22.92		
1.4	QPSK	3	1	22.89	22.95	23.07		
1.4	QPSK	3	3	22.76	22.66	22.73	23.00	1
1.4	QPSK	6	0	21.72	21.68	21.91		
1.4	16QAM	1	0	22.00	22.33	22.16	23.00	1
1.4	16QAM	1	3	22.02	22.25	22.01		
1.4	16QAM	1	5	22.04	22.24	21.97		
1.4	16QAM	3	0	21.93	21.77	22.05		
1.4	16QAM	3	1	22.06	22.02	22.17		
1.4	16QAM	3	3	22.02	21.86	22.14		
1.4	16QAM	6	0	20.60	20.61	20.64	22.00	2



<LTE Band 5>

BW [MHz]	Modulation	RB Size	RB Offset	Power Low Ch. / Freq.	Power Middle Ch. / Freq.	Power High Ch. / Freq.	Tune-up limit (dBm)	MPR (dB)
Channel				20450	20525	20600		
Frequency (MHz)				829	836.5	844		
10	QPSK	1	0	22.91	22.70	22.69	24.00	0
10	QPSK	1	25	23.04	22.90	22.89		
10	QPSK	1	49	22.65	22.71	22.81		
10	QPSK	25	0	22.04	21.92	21.89	23.00	1
10	QPSK	25	12	22.00	21.75	21.88		
10	QPSK	25	25	21.90	21.77	21.86		
10	QPSK	50	0	21.88	21.76	21.86	23.00	1
10	16QAM	1	0	22.12	22.24	21.82		
10	16QAM	1	25	22.25	22.04	22.32		
10	16QAM	1	49	21.70	22.07	21.75	22.00	2
10	16QAM	25	0	20.90	20.82	20.93		
10	16QAM	25	12	20.95	20.91	20.84		
10	16QAM	25	25	20.99	20.73	20.94	22.00	2
10	16QAM	50	0	20.90	20.74	20.88		
Channel				20425	20525	20625		
Frequency (MHz)				826.5	836.5	846.5		
5	QPSK	1	0	22.82	22.90	22.88	24.00	0
5	QPSK	1	12	22.93	22.77	22.96		
5	QPSK	1	24	22.91	22.70	22.97		
5	QPSK	12	0	21.88	21.98	21.90	23.00	1
5	QPSK	12	7	21.81	21.77	21.89		
5	QPSK	12	13	21.87	21.80	21.83		
5	QPSK	25	0	21.80	21.90	21.99	23.00	1
5	16QAM	1	0	21.72	22.18	22.45		
5	16QAM	1	12	21.69	22.14	22.43		
5	16QAM	1	24	22.09	22.17	22.35	22.00	2
5	16QAM	12	0	21.02	21.14	21.08		
5	16QAM	12	7	21.08	20.83	21.08		
5	16QAM	12	13	20.60	20.87	21.15	22.00	2
5	16QAM	25	0	20.93	20.73	20.93		



Channel				20415	20525	20635	Tune-up limit (dBm)	MPR (dB)
Frequency (MHz)				825.5	836.5	847.5		
3	QPSK	1	0	22.90	22.68	22.79	24.00	0
3	QPSK	1	8	22.80	22.54	22.62		
3	QPSK	1	14	22.80	22.56	22.67		
3	QPSK	8	0	21.89	21.77	21.97	23.00	1
3	QPSK	8	4	21.85	21.74	21.86		
3	QPSK	8	7	21.81	21.78	21.90		
3	QPSK	15	0	21.89	21.69	21.90	23.00	1
3	16QAM	1	0	21.94	22.49	22.17		
3	16QAM	1	8	21.80	22.23	21.89		
3	16QAM	1	14	21.89	22.38	22.10	22.00	2
3	16QAM	8	0	20.91	20.92	20.81		
3	16QAM	8	4	20.97	20.78	20.62		
3	16QAM	8	7	20.94	20.84	20.97	22.00	2
3	16QAM	15	0	20.82	20.82	21.00		
Channel				20407	20525	20643	Tune-up limit (dBm)	MPR (dB)
Frequency (MHz)				824.7	836.5	848.3		
1.4	QPSK	1	0	22.74	22.79	22.86	24.00	0
1.4	QPSK	1	3	22.82	22.46	22.68		
1.4	QPSK	1	5	22.64	22.52	22.59		
1.4	QPSK	3	0	22.89	22.60	22.91		
1.4	QPSK	3	1	22.83	22.60	22.85		
1.4	QPSK	3	3	22.88	22.62	22.86	23.00	1
1.4	QPSK	6	0	21.95	21.75	22.05		
1.4	16QAM	1	0	22.46	22.36	22.21	23.00	1
1.4	16QAM	1	3	22.25	22.06	21.80		
1.4	16QAM	1	5	22.01	21.91	22.45		
1.4	16QAM	3	0	21.82	21.79	22.09		
1.4	16QAM	3	1	21.93	21.68	21.98		
1.4	16QAM	3	3	21.95	21.34	21.88	22.00	2
1.4	16QAM	6	0	20.76	20.40	20.75		



<LTE Band 7>

BW [MHz]	Modulation	RB Size	RB Offset	Measured Power			Tune-up limit (dBm)	MPR (dB)
				Channel	20850	21100		
Frequency (MHz)				2510	2535	2560		
20	QPSK	1	0	21.87	21.91	21.88	23.00	0
20	QPSK	1	49	21.76	21.90	21.47		
20	QPSK	1	99	21.38	21.83	21.72		
20	QPSK	50	0	20.66	20.80	20.77	22.00	1
20	QPSK	50	24	20.52	20.74	20.65		
20	QPSK	50	50	20.62	20.74	20.68		
20	QPSK	100	0	20.54	20.78	20.71		
20	16QAM	1	0	20.84	20.94	21.08	22.00	1
20	16QAM	1	49	20.62	20.86	20.53		
20	16QAM	1	99	20.69	20.89	20.47		
20	16QAM	50	0	19.60	19.62	19.65	21.00	2
20	16QAM	50	24	19.38	19.79	19.53		
20	16QAM	50	50	19.50	19.80	19.51		
20	16QAM	100	0	19.57	19.76	19.69		
Channel				20825	21100	21375	Tune-up limit (dBm)	MPR (dB)
Frequency (MHz)				2507.5	2535	2562.5		
15	QPSK	1	0	21.43	21.59	21.66	23.00	0
15	QPSK	1	37	21.71	21.65	21.57		
15	QPSK	1	74	21.52	21.74	21.49		
15	QPSK	36	0	20.50	20.64	20.66	22.00	1
15	QPSK	36	20	20.51	20.76	20.61		
15	QPSK	36	39	20.44	20.82	20.60		
15	QPSK	75	0	20.59	20.73	20.71		
15	16QAM	1	0	20.80	20.97	21.30	22.00	1
15	16QAM	1	37	20.75	20.98	20.87		
15	16QAM	1	74	21.09	20.92	20.50		
15	16QAM	36	0	19.54	19.71	19.73	21.00	2
15	16QAM	36	20	19.54	19.74	19.63		
15	16QAM	36	39	19.48	19.79	19.67		
15	16QAM	75	0	19.52	19.69	19.67		



Channel				20800	21100	21400	Tune-up limit (dBm)	MPR (dB)
Frequency (MHz)				2505	2535	2565		
10	QPSK	1	0	21.47	21.52	21.62	23.00	0
10	QPSK	1	25	21.65	21.88	21.64		
10	QPSK	1	49	21.46	21.84	21.56		
10	QPSK	25	0	20.46	20.74	20.75	22.00	1
10	QPSK	25	12	20.47	20.78	20.72		
10	QPSK	25	25	20.52	20.79	20.64		
10	QPSK	50	0	20.46	20.80	20.69	22.00	1
10	16QAM	1	0	20.67	20.87	21.00		
10	16QAM	1	25	20.70	20.99	21.09		
10	16QAM	1	49	20.56	20.98	20.99	21.00	2
10	16QAM	25	0	19.39	19.88	19.83		
10	16QAM	25	12	19.43	19.94	19.82		
10	16QAM	25	25	19.67	19.91	19.72	21.00	2
10	16QAM	50	0	19.40	19.77	19.65		
Channel				20775	21100	21425	Tune-up limit (dBm)	MPR (dB)
Frequency (MHz)				2502.5	2535	2567.5		
5	QPSK	1	0	21.30	21.61	21.65	23.00	0
5	QPSK	1	12	21.53	21.81	21.72		
5	QPSK	1	24	21.36	21.79	21.62		
5	QPSK	12	0	20.42	20.62	20.58	22.00	1
5	QPSK	12	7	20.48	20.72	20.64		
5	QPSK	12	13	20.45	20.78	20.68		
5	QPSK	25	0	20.35	20.69	20.63	22.00	1
5	16QAM	1	0	20.58	21.24	20.97		
5	16QAM	1	12	20.63	20.99	20.89		
5	16QAM	1	24	20.67	20.91	20.79	21.00	2
5	16QAM	12	0	19.27	19.60	19.64		
5	16QAM	12	7	19.31	19.67	19.62		
5	16QAM	12	13	19.38	19.68	19.71	21.00	2
5	16QAM	25	0	19.38	19.69	19.67		



<LTE Band 12>

BW [MHz]	Modulation	RB Size	RB Offset	Power Low Ch. / Freq.	Power Middle Ch. / Freq.	Power High Ch. / Freq.	Tune-up limit (dBm)	MPR (dB)
Channel				23060	23095	23130		
Frequency (MHz)				704	707.5	711		
10	QPSK	1	0	22.54	22.62	22.71	24.00	0
10	QPSK	1	25	22.85	22.86	22.82		
10	QPSK	1	49	22.79	22.68	22.71		
10	QPSK	25	0	21.96	21.98	21.94	23.00	1
10	QPSK	25	12	21.74	21.74	21.90		
10	QPSK	25	25	21.68	21.73	21.85		
10	QPSK	50	0	21.79	21.82	21.80	23.00	1
10	16QAM	1	0	21.98	22.17	22.13		
10	16QAM	1	25	22.44	22.00	21.83		
10	16QAM	1	49	22.23	21.40	21.71	22.00	2
10	16QAM	25	0	20.95	20.73	20.94		
10	16QAM	25	12	21.01	20.81	20.90		
10	16QAM	25	25	20.98	20.80	21.07	22.00	2
10	16QAM	50	0	20.75	20.87	21.00		
Channel				23035	23095	23155		
Frequency (MHz)				701.5	707.5	713.5		
5	QPSK	1	0	22.39	22.66	22.54	24.00	0
5	QPSK	1	12	22.78	22.81	22.78		
5	QPSK	1	24	22.77	22.63	22.68		
5	QPSK	12	0	21.51	21.73	21.68	23.00	1
5	QPSK	12	7	21.72	21.82	21.73		
5	QPSK	12	13	21.74	21.83	21.73		
5	QPSK	25	0	21.67	21.76	21.79	23.00	1
5	16QAM	1	0	21.83	22.09	21.90		
5	16QAM	1	12	21.82	21.87	21.55		
5	16QAM	1	24	22.11	21.79	21.52	22.00	2
5	16QAM	12	0	20.36	20.70	20.73		
5	16QAM	12	7	20.65	20.66	20.77		
5	16QAM	12	13	20.69	20.57	20.61	22.00	2
5	16QAM	25	0	20.69	20.86	20.65		



Channel				23025	23095	23165	Tune-up limit (dBm)	MPR (dB)
Frequency (MHz)				700.5	707.5	714.5		
3	QPSK	1	0	22.60	22.65	22.54	24.00	0
3	QPSK	1	8	22.63	22.56	22.47		
3	QPSK	1	14	22.67	22.67	22.58		
3	QPSK	8	0	21.65	21.80	21.73	23.00	1
3	QPSK	8	4	21.80	21.75	21.75		
3	QPSK	8	7	21.80	21.82	21.72		
3	QPSK	15	0	21.77	21.77	21.67		
3	16QAM	1	0	21.92	21.97	22.30	23.00	1
3	16QAM	1	8	21.84	21.95	22.15		
3	16QAM	1	14	21.83	21.94	22.19		
3	16QAM	8	0	20.49	20.65	20.63	22.00	2
3	16QAM	8	4	20.68	20.82	20.57		
3	16QAM	8	7	20.63	20.57	20.47		
3	16QAM	15	0	20.59	20.50	20.64		
Channel				23017	23095	23173	Tune-up limit (dBm)	MPR (dB)
Frequency (MHz)				699.7	707.5	715.3		
1.4	QPSK	1	0	22.44	22.63	22.61	24.00	0
1.4	QPSK	1	3	22.40	22.60	22.54		
1.4	QPSK	1	5	22.47	22.57	22.65		
1.4	QPSK	3	0	22.62	22.63	22.62		
1.4	QPSK	3	1	22.67	22.60	22.64		
1.4	QPSK	3	3	22.61	22.66	22.76		
1.4	QPSK	6	0	21.69	21.80	21.70	23.00	1
1.4	16QAM	1	0	21.97	22.32	21.82	23.00	1
1.4	16QAM	1	3	21.85	22.15	21.73		
1.4	16QAM	1	5	21.15	21.68	21.48		
1.4	16QAM	3	0	21.77	21.60	21.41		
1.4	16QAM	3	1	21.83	22.05	21.88		
1.4	16QAM	3	3	21.89	21.43	21.86		
1.4	16QAM	6	0	20.40	20.85	20.28	22.00	2



<LTE Band 17>

BW [MHz]	Modulation	RB Size	RB Offset	Power Low Ch. / Freq.	Power Middle Ch. / Freq.	Power High Ch. / Freq.	Tune-up limit (dBm)	MPR (dB)
Channel				23780	23790	23800		
Frequency (MHz)				709	710	711		
10	QPSK	1	0	22.94	22.79	22.65		
10	QPSK	1	25	23.00	23.08	22.85	24.00	0
10	QPSK	1	49	22.83	22.77	22.83	23.00	1
10	QPSK	25	0	21.90	21.93	21.88		
10	QPSK	25	12	21.84	21.83	21.81		
10	QPSK	25	25	21.83	21.77	21.76	23.00	1
10	QPSK	50	0	21.91	21.80	21.89		
10	16QAM	1	0	21.42	21.66	22.15		
10	16QAM	1	25	21.64	22.14	22.25	23.00	1
10	16QAM	1	49	21.58	21.70	21.69	22.00	2
10	16QAM	25	0	20.83	20.75	20.73		
10	16QAM	25	12	20.82	20.75	20.78		
10	16QAM	25	25	20.80	20.68	20.72	22.00	2
10	16QAM	50	0	20.82	20.76	20.89		
Channel				23755	23790	23825		
Frequency (MHz)				706.5	710	713.5	Tune-up limit (dBm)	MPR (dB)
5	QPSK	1	0	22.80	22.93	22.89	24.00	0
5	QPSK	1	12	22.72	22.77	22.78		
5	QPSK	1	24	22.81	22.85	22.74		
5	QPSK	12	0	21.86	21.74	21.76	23.00	1
5	QPSK	12	7	21.88	21.69	21.71		
5	QPSK	12	13	21.80	21.74	21.78		
5	QPSK	25	0	21.83	21.73	21.79	23.00	1
5	16QAM	1	0	22.46	22.06	22.05		
5	16QAM	1	12	22.28	22.07	21.92		
5	16QAM	1	24	22.39	22.03	22.05	22.00	2
5	16QAM	12	0	20.85	20.78	20.74		
5	16QAM	12	7	20.79	20.74	20.64		
5	16QAM	12	13	20.77	20.84	20.70	22.00	2
5	16QAM	25	0	20.90	20.84	20.80		



Reduced Average RF Power (Proximity Sensor active)

<LTE Band 2>

BW [MHz]	Modulation	RB Size	RB Offset	Power Low Ch. / Freq.	Power Middle Ch. / Freq.	Power High Ch. / Freq.	Tune-up limit (dBm)	MPR (dB)
Channel				18700	18900	19100		
Frequency (MHz)				1860	1880	1900		
20	QPSK	1	0	13.04	13.28	12.38	13.50	0
20	QPSK	1	49	13.00	12.82	12.15		
20	QPSK	1	99	12.83	12.56	12.34		
20	QPSK	50	0	12.54	12.60	11.99	13.50	0
20	QPSK	50	24	12.95	13.02	12.26		
20	QPSK	50	50	12.96	13.17	12.54		
20	QPSK	100	0	12.11	12.65	12.28	13.50	0
20	16QAM	1	0	13.01	13.06	12.36		
20	16QAM	1	49	12.27	13.06	12.39		
20	16QAM	1	99	11.85	12.82	12.67	13.50	0
20	16QAM	50	0	12.36	12.59	12.06		
20	16QAM	50	24	13.00	13.04	12.24		
20	16QAM	50	50	12.98	13.18	12.55	13.50	0
20	16QAM	100	0	12.93	12.65	12.27		
Channel				18675	18900	19125		
Frequency (MHz)				1857.5	1880	1902.5		
15	QPSK	1	0	13.25	12.34	12.30	13.50	0
15	QPSK	1	37	12.12	12.71	12.46		
15	QPSK	1	74	13.06	13.26	12.88		
15	QPSK	36	0	12.82	12.92	12.29	13.50	0
15	QPSK	36	20	12.22	13.05	12.56		
15	QPSK	36	39	13.08	13.24	12.84		
15	QPSK	75	0	12.34	12.84	12.55	13.50	0
15	16QAM	1	0	13.00	12.75	12.47		
15	16QAM	1	37	12.50	13.19	12.61		
15	16QAM	1	74	12.98	13.23	13.03	13.50	0
15	16QAM	36	0	12.82	12.92	12.24		
15	16QAM	36	20	12.22	13.04	12.49		
15	16QAM	36	39	13.01	13.19	12.78	13.50	0
15	16QAM	75	0	12.33	12.92	12.52		



Channel				18650	18900	19150	Tune-up limit (dBm)	MPR (dB)
Frequency (MHz)				1855	1880	1905		
10	QPSK	1	0	12.81	12.28	11.85	13.50	0
10	QPSK	1	25	12.50	12.85	12.81		
10	QPSK	1	49	12.92	12.95	12.33		
10	QPSK	25	0	12.83	12.90	12.31	13.50	0
10	QPSK	25	12	12.62	12.98	12.60		
10	QPSK	25	25	12.13	13.04	12.68		
10	QPSK	50	0	12.55	12.85	12.41	13.50	0
10	16QAM	1	0	13.27	12.82	12.52		
10	16QAM	1	25	12.97	13.25	12.81		
10	16QAM	1	49	13.08	13.26	12.40	13.50	0
10	16QAM	25	0	12.79	12.90	12.24		
10	16QAM	25	12	12.58	12.95	12.48		
10	16QAM	25	25	12.13	13.03	12.65	13.50	0
10	16QAM	50	0	12.50	12.85	12.42		
Channel				18625	18900	19175		
Frequency (MHz)				1852.5	1880	1907.5		
5	QPSK	1	0	13.23	13.25	13.07	13.50	0
5	QPSK	1	12	12.96	12.75	12.84		
5	QPSK	1	24	12.97	13.23	12.88		
5	QPSK	12	0	13.25	13.17	12.88	13.50	0
5	QPSK	12	7	13.08	12.89	12.90		
5	QPSK	12	13	13.01	13.17	12.89		
5	QPSK	25	0	13.19	13.08	12.93	13.50	0
5	16QAM	1	0	13.27	13.27	13.14		
5	16QAM	1	12	13.20	13.26	12.91		
5	16QAM	1	24	13.22	13.25	12.93	13.50	0
5	16QAM	12	0	13.25	13.26	12.91		
5	16QAM	12	7	13.00	12.98	12.87		
5	16QAM	12	13	12.94	13.25	12.86	13.50	0
5	16QAM	25	0	13.05	13.08	12.85		



Channel				18615	18900	19185	Tune-up limit (dBm)	MPR (dB)
Frequency (MHz)				1851.5	1880	1908.5		
3	QPSK	1	0	13.22	13.12	12.92	13.50	0
3	QPSK	1	8	13.23	12.83	12.87		
3	QPSK	1	14	13.03	13.20	12.58		
3	QPSK	8	0	13.25	13.04	12.85	13.50	0
3	QPSK	8	4	13.24	12.98	12.80		
3	QPSK	8	7	13.15	13.00	12.72		
3	QPSK	15	0	13.26	13.04	12.80		
3	16QAM	1	0	13.21	13.25	13.24	13.50	0
3	16QAM	1	8	13.26	13.25	13.20		
3	16QAM	1	14	13.24	13.27	13.02		
3	16QAM	8	0	13.20	13.15	12.90	13.50	0
3	16QAM	8	4	13.16	13.10	12.88		
3	16QAM	8	7	13.07	13.13	12.79		
3	16QAM	15	0	13.07	13.01	12.80		
Channel				18607	18900	19193	Tune-up limit (dBm)	MPR (dB)
Frequency (MHz)				1850.7	1880	1909.3		
1.4	QPSK	1	0	13.23	12.79	12.64	13.50	0
1.4	QPSK	1	3	13.20	12.79	12.70		
1.4	QPSK	1	5	13.18	12.74	12.53		
1.4	QPSK	3	0	13.19	12.86	12.74		
1.4	QPSK	3	1	13.19	12.89	12.74		
1.4	QPSK	3	3	13.18	12.85	12.60		
1.4	QPSK	6	0	13.24	12.85	12.72	13.50	0
1.4	16QAM	1	0	13.20	12.91	12.80	13.50	0
1.4	16QAM	1	3	13.18	12.91	12.70		
1.4	16QAM	1	5	13.20	12.80	12.51		
1.4	16QAM	3	0	13.15	12.94	12.59		
1.4	16QAM	3	1	13.21	12.96	12.57		
1.4	16QAM	3	3	13.19	12.88	12.41		
1.4	16QAM	6	0	13.25	12.92	12.66	13.50	0



<LTE Band 4>

BW [MHz]	Modulation	RB Size	RB Offset	Power Low Ch. / Freq.	Power Middle Ch. / Freq.	Power High Ch. / Freq.	Tune-up limit (dBm)	MPR (dB)
Channel				20050	20175	20300		
Frequency (MHz)				1720	1732.5	1745		
20	QPSK	1	0	13.01	12.95	13.33	13.50	0
20	QPSK	1	49	13.00	12.94	13.23		
20	QPSK	1	99	12.52	12.85	12.98		
20	QPSK	50	0	13.08	13.02	13.30	13.50	0
20	QPSK	50	24	13.03	12.97	13.25		
20	QPSK	50	50	12.87	13.00	13.06		
20	QPSK	100	0	12.97	12.80	13.22	13.50	0
20	16QAM	1	0	13.00	13.04	13.22		
20	16QAM	1	49	12.97	13.00	13.23		
20	16QAM	1	99	12.43	12.98	13.28	13.50	0
20	16QAM	50	0	13.16	12.88	13.23		
20	16QAM	50	24	13.11	12.93	13.27		
20	16QAM	50	50	12.88	13.05	13.08	13.50	0
20	16QAM	100	0	13.01	12.78	13.24		
Channel				20025	20175	20325		
Frequency (MHz)				1717.5	1732.5	1747.5		
15	QPSK	1	0	13.14	13.19	13.24	13.50	0
15	QPSK	1	37	12.86	12.95	13.11		
15	QPSK	1	74	12.91	13.18	13.32		
15	QPSK	36	0	13.08	13.00	13.26	13.50	0
15	QPSK	36	20	13.00	13.04	13.19		
15	QPSK	36	39	12.95	13.18	13.12		
15	QPSK	75	0	13.02	12.97	13.27	13.50	0
15	16QAM	1	0	13.18	13.30	13.22		
15	16QAM	1	37	13.02	13.09	13.30		
15	16QAM	1	74	13.07	13.27	13.28	13.50	0
15	16QAM	36	0	13.16	12.96	13.31		
15	16QAM	36	20	13.08	13.01	13.23		
15	16QAM	36	39	13.04	13.11	13.15	13.50	0
15	16QAM	75	0	13.06	12.99	13.32		



Channel				20000	20175	20350	Tune-up limit (dBm)	MPR (dB)
Frequency (MHz)				1715	1732.5	1750		
10	QPSK	1	0	12.66	12.60	12.95	13.50	0
10	QPSK	1	25	12.96	12.93	13.22		
10	QPSK	1	49	12.45	12.69	13.04		
10	QPSK	25	0	12.96	12.79	13.09	13.50	0
10	QPSK	25	12	13.01	13.01	13.17		
10	QPSK	25	25	12.80	13.11	13.05		
10	QPSK	50	0	12.91	12.90	13.12	13.50	0
10	16QAM	1	0	12.84	12.93	13.24		
10	16QAM	1	25	13.03	13.29	13.28		
10	16QAM	1	49	12.61	13.14	13.26	13.50	0
10	16QAM	25	0	12.96	12.75	13.12		
10	16QAM	25	12	13.03	12.97	13.14		
10	16QAM	25	25	12.82	13.03	13.06	13.50	0
10	16QAM	50	0	12.90	12.88	13.16		
Channel				19975	20175	20375	Tune-up limit (dBm)	MPR (dB)
Frequency (MHz)				1712.5	1732.5	1752.5		
5	QPSK	1	0	13.09	13.15	13.24	13.50	0
5	QPSK	1	12	12.73	12.88	13.09		
5	QPSK	1	24	13.02	13.31	13.22		
5	QPSK	12	0	13.02	12.94	13.27	13.50	0
5	QPSK	12	7	12.91	12.97	13.24		
5	QPSK	12	13	13.04	13.15	13.25		
5	QPSK	25	0	12.98	13.05	13.25	13.50	0
5	16QAM	1	0	13.29	13.31	13.25		
5	16QAM	1	12	13.13	13.28	13.27		
5	16QAM	1	24	13.32	13.18	13.29	13.50	0
5	16QAM	12	0	13.03	12.95	13.25		
5	16QAM	12	7	12.93	12.90	13.24		
5	16QAM	12	13	13.04	13.19	13.24	13.50	0
5	16QAM	25	0	13.11	13.08	13.30		



Channel				19965	20175	20385	Tune-up limit (dBm)	MPR (dB)
Frequency (MHz)				1711.5	1732.5	1753.5		
3	QPSK	1	0	13.11	12.77	13.13	13.50	0
3	QPSK	1	8	12.95	12.78	13.23		
3	QPSK	1	14	12.88	13.00	13.29		
3	QPSK	8	0	12.85	12.85	13.21	13.50	0
3	QPSK	8	4	12.84	12.86	13.18		
3	QPSK	8	7	12.88	12.89	13.19		
3	QPSK	15	0	12.86	12.88	13.20	13.50	0
3	16QAM	1	0	12.98	13.06	13.25		
3	16QAM	1	8	13.04	13.02	13.27		
3	16QAM	1	14	13.02	13.18	13.29	13.50	0
3	16QAM	8	0	12.98	12.81	13.25		
3	16QAM	8	4	12.98	13.01	13.23		
3	16QAM	8	7	12.85	12.95	13.23	13.50	0
3	16QAM	15	0	12.90	12.98	13.26		
Channel				19957	20175	20393	Tune-up limit (dBm)	MPR (dB)
Frequency (MHz)				1710.7	1732.5	1754.3		
1.4	QPSK	1	0	12.89	12.74	13.02	13.50	0
1.4	QPSK	1	3	12.79	12.82	13.18		
1.4	QPSK	1	5	12.72	12.80	13.15		
1.4	QPSK	3	0	12.81	12.81	13.06		
1.4	QPSK	3	1	12.86	12.85	13.20		
1.4	QPSK	3	3	12.69	12.84	13.18	13.50	0
1.4	QPSK	6	0	12.81	12.82	13.14		
1.4	16QAM	1	0	13.15	12.95	13.31	13.50	0
1.4	16QAM	1	3	13.31	13.00	13.32		
1.4	16QAM	1	5	13.27	12.95	13.29		
1.4	16QAM	3	0	12.82	12.86	13.15		
1.4	16QAM	3	1	12.95	12.91	13.29		
1.4	16QAM	3	3	12.76	12.92	13.24	13.50	0
1.4	16QAM	6	0	12.91	13.02	13.24		



<LTE Band 5>

BW [MHz]	Modulation	RB Size	RB Offset	Power Low Ch. / Freq.	Power Middle Ch. / Freq.	Power High Ch. / Freq.	Tune-up limit (dBm)	MPR (dB)
Channel				20450	20525	20600		
Frequency (MHz)				829	836.5	844		
10	QPSK	1	0	13.10	13.15	12.55	13.50	0
10	QPSK	1	25	13.23	13.19	12.75		
10	QPSK	1	49	12.26	11.79	12.21		
10	QPSK	25	0	13.15	13.12	12.85	13.50	0
10	QPSK	25	12	13.05	12.84	12.84		
10	QPSK	25	25	12.88	12.47	12.74		
10	QPSK	50	0	12.96	12.73	12.72		
10	16QAM	1	0	13.14	13.20	13.18	13.50	0
10	16QAM	1	25	13.17	13.11	13.15		
10	16QAM	1	49	12.25	12.32	12.93		
10	16QAM	25	0	13.20	13.03	12.97	13.50	0
10	16QAM	25	12	13.16	12.79	13.00		
10	16QAM	25	25	12.87	12.41	12.89		
10	16QAM	50	0	13.10	12.64	12.87		
Channel				20425	20525	20625	Tune-up limit (dBm)	MPR (dB)
Frequency (MHz)				826.5	836.5	846.5		
5	QPSK	1	0	13.19	13.18	13.17	13.50	0
5	QPSK	1	12	12.98	12.85	13.11		
5	QPSK	1	24	13.19	12.93	13.21		
5	QPSK	12	0	13.18	13.21	13.20	13.50	0
5	QPSK	12	7	13.17	12.97	13.19		
5	QPSK	12	13	13.10	12.87	13.17		
5	QPSK	25	0	13.19	13.08	13.18		
5	16QAM	1	0	13.13	13.15	13.14	13.50	0
5	16QAM	1	12	13.18	12.75	13.16		
5	16QAM	1	24	13.19	12.82	13.16		
5	16QAM	12	0	13.16	13.20	13.19	13.50	0
5	16QAM	12	7	13.15	12.96	13.20		
5	16QAM	12	13	13.18	12.94	13.17		
5	16QAM	25	0	13.18	13.00	13.20		



Channel				20415	20525	20635	Tune-up limit (dBm)	MPR (dB)
Frequency (MHz)				825.5	836.5	847.5		
3	QPSK	1	0	13.18	13.04	13.19	13.50	0
3	QPSK	1	8	13.06	12.86	13.15		
3	QPSK	1	14	13.03	12.80	13.06		
3	QPSK	8	0	13.16	13.06	13.15	13.50	0
3	QPSK	8	4	13.10	12.92	13.15		
3	QPSK	8	7	13.05	12.85	13.09		
3	QPSK	15	0	13.14	12.96	13.18		
3	16QAM	1	0	13.21	13.22	13.09	13.50	0
3	16QAM	1	8	13.02	12.86	13.11		
3	16QAM	1	14	13.02	13.00	13.14		
3	16QAM	8	0	13.18	13.04	13.22	13.50	0
3	16QAM	8	4	13.21	12.87	13.17		
3	16QAM	8	7	13.18	12.81	13.14		
3	16QAM	15	0	13.19	12.96	13.21		
Channel				20407	20525	20643	Tune-up limit (dBm)	MPR (dB)
Frequency (MHz)				824.7	836.5	848.3		
1.4	QPSK	1	0	13.05	12.85	13.03	13.50	0
1.4	QPSK	1	3	12.93	12.77	13.10		
1.4	QPSK	1	5	12.91	12.68	12.94		
1.4	QPSK	3	0	13.04	12.77	13.15		
1.4	QPSK	3	1	13.06	12.78	13.17		
1.4	QPSK	3	3	13.00	12.69	13.12	13.50	0
1.4	QPSK	6	0	13.06	12.76	13.11		
1.4	16QAM	1	0	13.02	13.08	13.21	13.50	0
1.4	16QAM	1	3	13.11	12.88	13.22		
1.4	16QAM	1	5	12.83	12.76	13.17		
1.4	16QAM	3	0	13.15	12.73	13.20		
1.4	16QAM	3	1	12.95	12.74	13.16		
1.4	16QAM	3	3	13.07	12.84	13.16		
1.4	16QAM	6	0	13.07	12.94	13.14	13.50	0



<LTE Band 7>

BW [MHz]	Modulation	RB Size	RB Offset	Measured Power			Tune-up limit (dBm)	MPR (dB)
				Channel	20850	21100		
Frequency (MHz)				2510	2535	2560		
20	QPSK	1	0	13.75	13.93	13.80	14.50	0
20	QPSK	1	49	13.70	13.71	13.45		
20	QPSK	1	99	13.37	13.61	13.47		
20	QPSK	50	0	13.59	13.73	13.70	14.50	0
20	QPSK	50	24	13.39	13.64	13.54		
20	QPSK	50	50	13.47	13.62	13.51		
20	QPSK	100	0	13.44	13.67	13.60		
20	16QAM	1	0	13.81	13.80	13.71	14.50	0
20	16QAM	1	49	13.82	13.70	13.43		
20	16QAM	1	99	13.61	13.81	13.76		
20	16QAM	50	0	13.58	13.56	13.71	14.50	0
20	16QAM	50	24	13.49	13.62	13.54		
20	16QAM	50	50	13.40	13.63	13.39		
20	16QAM	100	0	13.51	13.68	13.45		
Channel				20825	21100	21375	Tune-up limit (dBm)	MPR (dB)
Frequency (MHz)				2507.5	2535	2562.5		
15	QPSK	1	0	13.51	13.68	13.64	14.50	0
15	QPSK	1	37	13.80	13.60	13.56		
15	QPSK	1	74	13.46	13.57	13.48		
15	QPSK	36	0	13.48	13.57	13.63	14.50	0
15	QPSK	36	20	13.30	13.62	13.51		
15	QPSK	36	39	13.33	13.64	13.54		
15	QPSK	75	0	13.40	13.66	13.53		
15	16QAM	1	0	13.41	13.87	13.85	14.50	0
15	16QAM	1	37	13.60	13.81	13.72		
15	16QAM	1	74	13.62	13.82	13.71		
15	16QAM	36	0	13.50	13.69	13.51	14.50	0
15	16QAM	36	20	13.41	13.63	13.48		
15	16QAM	36	39	13.43	13.62	13.59		
15	16QAM	75	0	13.32	13.66	13.50		



Channel				20800	21100	21400	Tune-up limit (dBm)	MPR (dB)
Frequency (MHz)				2505	2535	2565		
10	QPSK	1	0	13.50	13.50	13.46	14.50	0
10	QPSK	1	25	13.53	13.67	13.53		
10	QPSK	1	49	13.41	13.63	13.29		
10	QPSK	25	0	13.48	13.60	13.60	14.50	0
10	QPSK	25	12	13.39	13.66	13.58		
10	QPSK	25	25	13.32	13.62	13.48		
10	QPSK	50	0	13.45	13.55	13.54	14.50	0
10	16QAM	1	0	13.66	13.58	13.34		
10	16QAM	1	25	13.69	13.90	13.51		
10	16QAM	1	49	13.54	13.89	13.27	14.50	0
10	16QAM	25	0	13.48	13.69	13.69		
10	16QAM	25	12	13.55	13.78	13.66		
10	16QAM	25	25	13.51	13.82	13.56	14.50	0
10	16QAM	50	0	13.39	13.57	13.61		
Channel				20775	21100	21425		
Frequency (MHz)				2502.5	2535	2567.5		
5	QPSK	1	0	13.35	13.43	13.49	14.50	0
5	QPSK	1	12	13.39	13.73	13.59		
5	QPSK	1	24	13.35	13.52	13.59		
5	QPSK	12	0	13.30	13.54	13.44	14.50	0
5	QPSK	12	7	13.34	13.57	13.46		
5	QPSK	12	13	13.31	13.53	13.53		
5	QPSK	25	0	13.39	13.45	13.46	14.50	0
5	16QAM	1	0	13.64	13.76	13.69		
5	16QAM	1	12	13.58	13.79	13.71		
5	16QAM	1	24	13.63	13.89	13.71	14.50	0
5	16QAM	12	0	13.32	13.49	13.44		
5	16QAM	12	7	13.42	13.50	13.45		
5	16QAM	12	13	13.56	13.52	13.50	14.50	0
5	16QAM	25	0	13.37	13.66	13.45		



<LTE Band 12>

BW [MHz]	Modulation	RB Size	RB Offset	Power Low Ch. / Freq.	Power Middle Ch. / Freq.	Power High Ch. / Freq.	Tune-up limit (dBm)	MPR (dB)
Channel				23060	23095	23130		
Frequency (MHz)				704	707.5	711		
10	QPSK	1	0	14.66	14.84	14.75	15.50	0
10	QPSK	1	25	14.79	14.94	14.76		
10	QPSK	1	49	14.56	14.40	14.50		
10	QPSK	25	0	14.74	14.80	14.73	15.50	0
10	QPSK	25	12	14.72	14.72	14.65		
10	QPSK	25	25	14.70	14.63	14.69		
10	QPSK	50	0	14.69	14.62	14.72	15.50	0
10	16QAM	1	0	14.22	14.72	14.70		
10	16QAM	1	25	14.75	14.71	14.69		
10	16QAM	1	49	14.57	14.71	14.71	15.50	0
10	16QAM	25	0	14.46	14.47	14.71		
10	16QAM	25	12	14.75	14.75	14.51		
10	16QAM	25	25	14.73	14.51	14.56	15.50	0
10	16QAM	50	0	14.65	14.52	14.61		
Channel				23035	23095	23155		
Frequency (MHz)				701.5	707.5	713.5		
5	QPSK	1	0	14.53	14.68	14.70	15.50	0
5	QPSK	1	12	14.63	14.65	14.66		
5	QPSK	1	24	14.74	14.50	14.46		
5	QPSK	12	0	14.58	14.72	14.59	15.50	0
5	QPSK	12	7	14.69	14.69	14.70		
5	QPSK	12	13	14.71	14.67	14.57		
5	QPSK	25	0	14.63	14.74	14.69	15.50	0
5	16QAM	1	0	14.69	14.70	14.50		
5	16QAM	1	12	14.65	14.70	14.68		
5	16QAM	1	24	14.66	14.77	14.66	15.50	0
5	16QAM	12	0	14.61	14.70	14.68		
5	16QAM	12	7	14.72	14.76	14.68		
5	16QAM	12	13	14.64	14.71	14.64	15.50	0
5	16QAM	25	0	14.39	14.59	14.71		



Channel				23025	23095	23165	Tune-up limit (dBm)	MPR (dB)
Frequency (MHz)				700.5	707.5	714.5		
3	QPSK	1	0	14.49	14.70	14.71	15.50	0
3	QPSK	1	8	14.43	14.62	14.57		
3	QPSK	1	14	14.50	14.68	14.49		
3	QPSK	8	0	14.74	14.74	14.70	15.50	0
3	QPSK	8	4	14.77	14.76	14.75		
3	QPSK	8	7	14.77	14.73	14.64		
3	QPSK	15	0	14.76	14.70	14.68	15.50	0
3	16QAM	1	0	14.76	14.74	14.69		
3	16QAM	1	8	14.77	14.75	14.69		
3	16QAM	1	14	14.61	14.59	14.68	15.50	0
3	16QAM	8	0	14.59	14.78	14.54		
3	16QAM	8	4	14.74	14.77	14.59		
3	16QAM	8	7	14.72	14.78	14.50	15.50	0
3	16QAM	15	0	14.51	14.69	14.59		
Channel				23017	23095	23173	Tune-up limit (dBm)	MPR (dB)
Frequency (MHz)				699.7	707.5	715.3		
1.4	QPSK	1	0	14.70	14.72	14.69	15.50	0
1.4	QPSK	1	3	14.76	14.54	14.64		
1.4	QPSK	1	5	14.61	14.61	14.63		
1.4	QPSK	3	0	14.54	14.75	14.55		
1.4	QPSK	3	1	14.72	14.77	14.66		
1.4	QPSK	3	3	14.65	14.71	14.63	15.50	0
1.4	QPSK	6	0	14.72	14.71	14.66		
1.4	16QAM	1	0	14.70	14.75	14.76	15.50	0
1.4	16QAM	1	3	14.77	14.78	14.73		
1.4	16QAM	1	5	14.72	14.72	14.55		
1.4	16QAM	3	0	14.39	14.66	14.62		
1.4	16QAM	3	1	14.41	14.77	14.18		
1.4	16QAM	3	3	14.22	14.72	14.73	15.50	0
1.4	16QAM	6	0	14.26	14.71	14.22		



<LTE Band 17>

BW [MHz]	Modulation	RB Size	RB Offset	Power Low Ch. / Freq.	Power Middle Ch. / Freq.	Power High Ch. / Freq.	Tune-up limit (dBm)	MPR (dB)
Channel				23780	23790	23800	15.50	0
Frequency (MHz)				709	710	711		
10	QPSK	1	0	14.75	14.73	14.69		
10	QPSK	1	25	15.04	15.08	14.84	15.50	0
10	QPSK	1	49	14.65	14.61	14.74		
10	QPSK	25	0	14.91	14.92	14.85		
10	QPSK	25	12	14.89	14.90	14.83	15.50	0
10	QPSK	25	25	14.73	14.69	14.69		
10	QPSK	50	0	14.82	14.86	14.83		
10	16QAM	1	0	14.68	14.84	14.85	15.50	0
10	16QAM	1	25	14.86	14.90	14.80		
10	16QAM	1	49	14.91	14.86	14.85		
10	16QAM	25	0	14.67	14.77	14.83	15.50	0
10	16QAM	25	12	14.74	14.83	14.73		
10	16QAM	25	25	14.79	14.77	14.66		
10	16QAM	50	0	14.71	14.82	14.68	15.50	0
Channel				23755	23790	23825		
Frequency (MHz)				706.5	710	713.5		
5	QPSK	1	0	14.90	14.86	14.89	15.50	0
5	QPSK	1	12	14.91	14.80	14.78		
5	QPSK	1	24	14.79	14.84	14.79		
5	QPSK	12	0	14.85	14.85	14.70	15.50	0
5	QPSK	12	7	14.74	14.77	14.71		
5	QPSK	12	13	14.79	14.83	14.80		
5	QPSK	25	0	14.72	14.83	14.80	15.50	0
5	16QAM	1	0	15.05	15.00	14.87		
5	16QAM	1	12	15.02	14.86	14.99		
5	16QAM	1	24	14.82	15.01	14.89	15.50	0
5	16QAM	12	0	14.90	14.94	14.80		
5	16QAM	12	7	14.90	14.88	14.71		
5	16QAM	12	13	14.85	14.88	14.79	15.50	0
5	16QAM	25	0	14.91	14.92	15.07		

<WLAN Conducted Power>**General Note:**

1. Per KDB 248227 D01v02r02, SAR test reduction is determined according to 802.11 transmission mode configurations and certain exposure conditions with multiple test positions. In the 2.4 GHz band, separate SAR procedures are applied to DSSS and OFDM configurations to simplify DSSS test requirements. For OFDM, in both 2.4 and 5 GHz bands, an initial test configuration must be determined for each standalone and aggregated frequency band, according to the transmission mode configuration with the highest maximum output power specified for production units to perform SAR measurements. If the same highest maximum output power applies to different combinations of channel bandwidths, modulations and data rates, additional procedures are applied to determine which test configurations require SAR measurement. When applicable, an initial test position may be applied to reduce the number of SAR measurements required for next to the ear, UMPC mini-tablet or hotspot mode configurations with multiple test positions.
2. For 2.4 GHz 802.11b DSSS, either the initial test position procedure for multiple exposure test positions or the DSSS procedure for fixed exposure position is applied; these are mutually exclusive. For 2.4 GHz and 5 GHz OFDM configurations, the initial test configuration is applied to measure SAR using either the initial test position procedure for multiple exposure test position configurations or the initial test configuration procedures for fixed exposure test conditions. Based on the reported SAR of the measured configurations and maximum output power of the transmission mode configurations that are not included in the initial test configuration, the subsequent test configuration and initial test position procedures are applied to determine if SAR measurements are required for the remaining OFDM transmission configurations. In general, the number of test channels that require SAR measurement is minimized based on maximum output power measured for the test sample(s).
3. For OFDM transmission configurations in the 2.4 GHz and 5 GHz bands, When the same maximum power is specified for multiple transmission modes in a frequency band, the largest channel bandwidth, lowest order modulation, lowest data rate and lowest order 802.11a/g/n/ac mode is used for SAR measurement, on the highest measured output power channel for each frequency band.
4. DSSS and OFDM configurations are considered separately according to the required SAR procedures. SAR is measured in the initial test position using the 802.11 transmission mode configuration required by the DSSS procedure or initial test configuration and subsequent test configuration(s) according to the OFDM procedures.18 The initial test position procedure is described in the following:
 - a. When the reported SAR of the initial test position is ≤ 0.4 W/kg, further SAR measurement is not required for the other test positions in that exposure configuration and 802.11 transmission mode combinations within the frequency band or aggregated band.
 - b. When the reported SAR of the test position is > 0.4 W/kg, SAR is repeated for the 802.11 transmission mode configuration tested in the initial test position to measure the subsequent next closet/smallest test separation distance and maximum coupling test position on the highest maximum output power channel, until the report SAR is ≤ 0.8 W/kg or all required test position are tested.
 - c. For all positions/configurations, when the reported SAR is > 0.8 W/kg, SAR is measured for these test positions/configurations on the subsequent next highest measured output power channel(s) until the reported SAR is ≤ 1.2 W/kg or all required channels are tested.



<2.4GHz WLAN>

	Mode	Channel	Frequency (MHz)	Data Rate	Average power (dBm)	Tune-Up Limit	Duty Cycle %
2.4GHz WLAN	802.11b	CH 1	2412	1Mbps	14.27	15.00	97.94
		CH 6	2437		13.57	14.00	
		CH 11	2462		13.20	14.00	
	802.11g	CH 1	2412	6Mbps	12.26	12.50	87.44
		CH 6	2437		13.62	14.00	
		CH 11	2462		12.44	13.00	
	802.11n-HT20	CH 1	2412	MCS0	11.56	12.00	86.27
		CH 6	2437		12.71	13.00	
		CH 11	2462		11.66	12.00	

<5GHz WLAN>

	Mode	Channel	Frequency (MHz)	Data Rate	Average power (dBm)	Tune-Up Limit	Duty Cycle %
5.2GHz WLAN	802.11a	CH 36	5180	6Mbps	14.43	15.00	87.44
		CH 40	5200		14.97	15.50	
		CH 44	5220		14.84	15.50	
		CH 48	5240		14.97	15.50	
	802.11n-HT20	CH 36	5180	MCS0	13.85	14.00	86.70
		CH 40	5200		14.93	15.20	
		CH 44	5220		15.15	15.20	
		CH 48	5240		15.04	15.20	
	802.11n-HT40	CH 38	5190	MCS0	10.39	11.00	76.12
		CH 46	5230		14.39	14.50	



5.3GHz WLAN	Mode	Channel	Frequency (MHz)	Data Rate	Average power (dBm)	Tune-Up Limit	Duty Cycle %
	802.11a	CH 52	5260	6Mbps	14.66	15.00	87.44
		CH 56	5280		14.07	14.50	
		CH 60	5300		14.28	14.50	
		CH 64	5320		13.26	13.50	
	802.11n-HT20	CH 52	5260	MCS0	14.74	15.00	86.70
		CH 56	5280		14.05	14.50	
		CH 60	5300		14.41	14.50	
		CH 64	5320		13.40	14.00	
	802.11n-HT40	CH 54	5270	MCS0	13.67	14.00	76.12
CH 62		5310	8.89		9.50		

5.8GHz WLAN	Mode	Channel	Frequency (MHz)	Data Rate	Average power (dBm)	Tune-Up Limit	Duty Cycle %
	802.11a	CH 149	5745	6Mbps	12.59	13.00	87.44
		CH 157	5785		12.52	13.00	
		CH 161	5805		13.19	13.50	
	802.11n-HT20	CH 149	5745	MCS0	12.64	13.00	86.70
		CH 157	5785		12.59	13.00	
		CH 161	5805		13.26	13.50	
	802.11n-HT40	CH 151	5755	MCS0	10.81	11.50	76.12
		CH 159	5795		12.20	12.50	



<2.4GHz Bluetooth>

General Note:

For 2.4GHz Bluetooth SAR testing was selected 1Mbps, due to its highest average power.

Mode	Channel	Frequency (MHz)	Average power (dBm)		
			1Mbps	2Mbps	3Mbps
v3.0 with EDR	CH 00	2402	10.24	8.15	8.17
	CH 39	2441	9.92	7.83	7.81
	CH 78	2480	9.31	7.25	7.25
Tune-up Limit			10.50	8.50	8.50

Mode	Channel	Frequency (MHz)	Average power (dBm)
			GFSK
v4.1 with LE	CH 00	2402	1.76
	CH 19	2440	1.44
	CH 39	2480	0.90
Tune-up Limit			2.00

14. Antenna Location

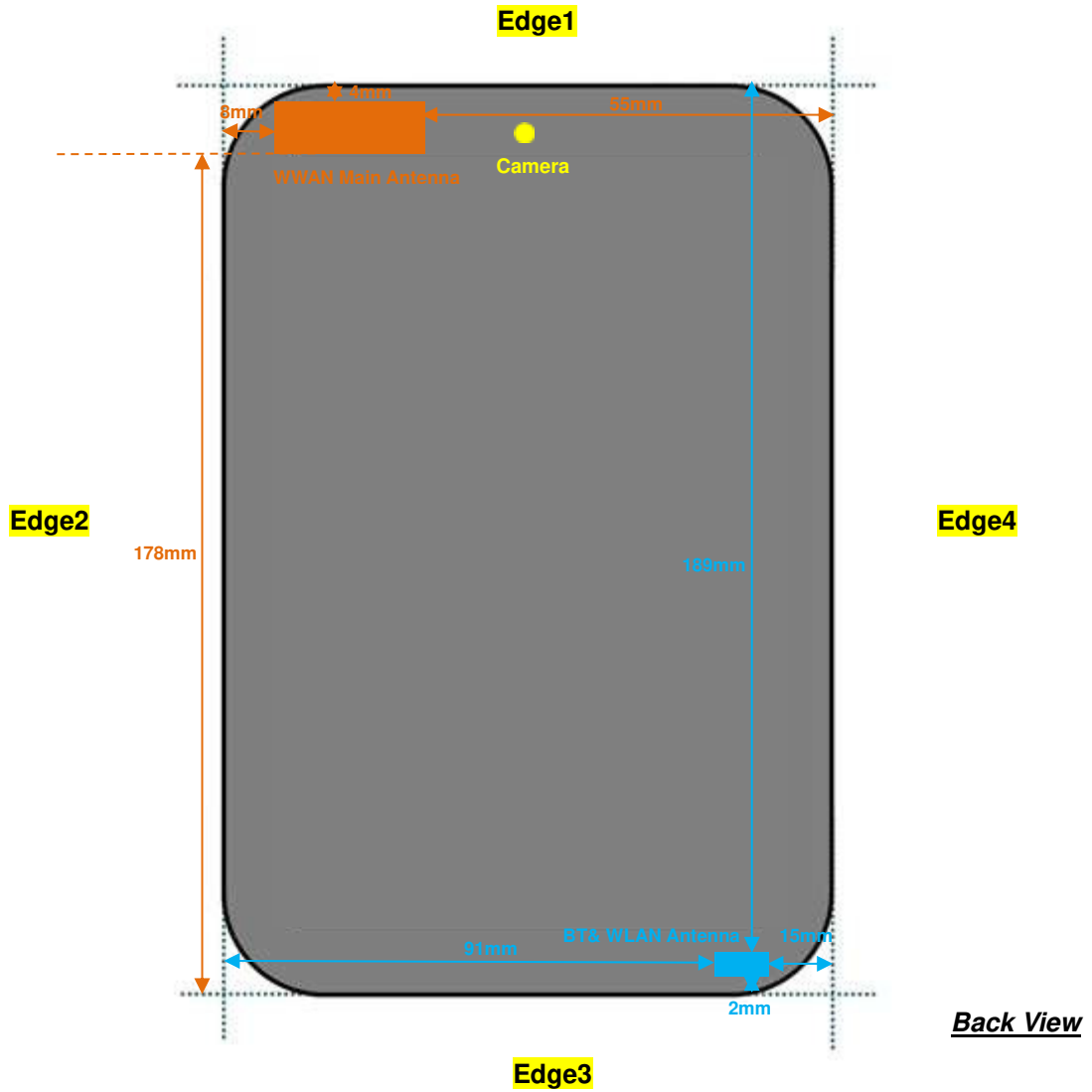

Diagonal Dimension: 214mm



General Note:

- The below table, when the distance is < 50 mm exclusion threshold is "Ratio", when the distance is > 50 mm exclusion threshold is "mW"
- Maximum power is the source-based time-average power and represents the maximum RF output power among production units
- Per KDB 447498 D01v06, for larger devices, the test separation distance of adjacent edge configuration is determined by the closest separation between the antenna and the user.
- Per KDB 447498 D01v06, standalone SAR test exclusion threshold is applied; If the test separation distance is < 5mm, 5mm is used to determine SAR exclusion threshold.
- Per KDB 447498 D01v06, the 1-g and 10-g SAR test exclusion thresholds for 100 MHz to 6 GHz at *test separation distances* ≤ 50 mm are determined by:
 - $[(\text{max. power of channel, including tune-up tolerance, mW}) / (\text{min. test separation distance, mm})] \cdot [\sqrt{f(\text{GHz})}] \leq 3.0$ for 1-g SAR and ≤ 7.5 for 10-g extremity SAR
 - f(GHz) is the RF channel transmit frequency in GHz
 - Power and distance are rounded to the nearest mW and mm before calculation
 - The result is rounded to one decimal place for comparison
- Per KDB 447498 D01v06, at 100 MHz to 6 GHz and for *test separation distances* > 50 mm, the SAR test exclusion threshold is determined according to the following
 - [Threshold at 50 mm in step 1) + (test separation distance - 50 mm) · (f(MHz)/150)] mW, at 100 MHz to 1500 MHz
 - [Threshold at 50 mm in step 1) + (test separation distance - 50 mm) · 10] mW at > 1500 MHz and ≤ 6 GHz

Exposure Position	Wireless Interface	GPRS 850 2Tx slots	GPRS 1900 2Tx slots	WCDMA Band V	WCDMA Band IV	WCDMA Band II	LTE Band 5	LTE Band 4	LTE Band 2	LTE Band 12	LTE Band 7
	Calculated Frequency	848MHz	1909MHz	846MHz	1750MHz	1907MHz	848MHz	1754MHz	1909MHz	750MHz	2570MHz
	Maximum power (dBm)	25.5	22.5	24.0	24.0	24.0	24.0	24.0	23.5	24.0	23
	Maximum Rated power(mW)	355.0	178.0	251.0	251.0	251.0	251.0	251.0	224.0	251.0	200.0
Bottom Face	Separation distance(mm)	0									
	exclusion threshold	65.4	49.2	46.2	66.4	69.3	46.2	66.5	61.9	42.5	64.1
	Testing required?	Yes	Yes	Yes	Yes	Yes	Yes	Yes	Yes	Yes	Yes
Edge 1	Separation distance(mm)	4									
	exclusion threshold	65.4	49.2	46.2	66.4	69.3	46.2	66.5	61.9	42.5	64.1
	Testing required?	Yes	Yes	Yes	Yes	Yes	Yes	Yes	Yes	Yes	Yes
Edge 2	Separation distance(mm)	8									
	exclusion threshold	40.9	30.7	28.9	41.5	43.3	28.9	41.6	38.7	26.6	40.1
	Testing required?	Yes	Yes	Yes	Yes	Yes	Yes	Yes	Yes	Yes	Yes
Edge 3	Separation distance(mm)	178									
	exclusion threshold	887.0	1389.0	885.0	1393.0	1389.0	887.0	1393.0	1389.0	788.0	1374.0
	Testing required?	No	No	No	No	No	No	No	No	No	No
Edge 4	Separation distance(mm)	55									
	exclusion threshold	191.0	159.0	191.0	163.0	159.0	191.0	163.0	159.0	201.0	144.0
	Testing required?	Yes	Yes	Yes	Yes	Yes	Yes	Yes	Yes	Yes	Yes



Exposure Position	Wireless Interface	BT	2.4GHz WLAN	5GHz WLAN
	Calculated Frequency	2480MHz	2462MHz	5805MHz
	Maximum power (dBm)	10.5	15	15.5
	Maximum rated power(mW)	11.0	32.0	35.0
Bottom Face	Separation distance(mm)	0		
	exclusion threshold	3.5	10.0	16.9
	Testing required?	Yes	Yes	Yes
Edge 1	Separation distance(mm)	189		
	exclusion threshold	1485.0	1486.0	1452.0
	Testing required?	No	No	No
Edge 2	Separation distance(mm)	91		
	exclusion threshold	505.0	506.0	472.0
	Testing required?	No	No	No
Edge 3	Separation distance(mm)	2		
	exclusion threshold	3.5	10.0	16.9
	Testing required?	Yes	Yes	Yes
Edge 4	Separation distance(mm)	15		
	exclusion threshold	1.2	3.4	5.6
	Testing required?	No	Yes	Yes

15. SAR Test Results

General Note:

- Per KDB 447498 D01v06, the reported SAR is the measured SAR value adjusted for maximum tune-up tolerance.
 - Tune-up scaling Factor = tune-up limit power (mW) / EUT RF power (mW), where tune-up limit is the maximum rated power among all production units.
 - For SAR testing of WLAN signal with non-100% duty cycle, the measured SAR is scaled-up by the duty cycle scaling factor which is equal to "1/(duty cycle)"
 - For WWAN/Bluetooth: Reported SAR(W/kg)= Measured SAR(W/kg)*Tune-up Scaling Factor
 - For WLAN: Reported SAR(W/kg)= Measured SAR(W/kg)* Duty Cycle scaling factor * Tune-up scaling factor
- Per KDB 447498 D01v06, for each exposure position, testing of other required channels within the operating mode of a frequency band is not required when the *reported* 1-g or 10-g SAR for the mid-band or highest output power channel is:
 - ≤ 0.8 W/kg or 2.0 W/kg, for 1-g or 10-g respectively, when the transmission band is ≤ 100 MHz
 - ≤ 0.6 W/kg or 1.5 W/kg, for 1-g or 10-g respectively, when the transmission band is between 100 MHz and 200 MHz
 - ≤ 0.4 W/kg or 1.0 W/kg, for 1-g or 10-g respectively, when the transmission band is ≥ 200 MHz
- Per KDB 865664 D01v01r04, for each frequency band, repeated SAR measurement is required only when the measured SAR is ≥0.8W/kg.

Tablet Note:

- For the exposure positions that proximity sensor power reduction is applied for SAR compliance, additional SAR testing with EUT transmitting full power in normal mode was performed; 9mm for bottom face, 6mm for edge1 and 5mm for edge2.
- Considering the curvature transition from bottom face to the edge, SAR testing at the curvature was performed. The SAR test setup is included in test setup photo exhibit.
- For SAR testing of the curved region of the device, the device was placed directly against the phantom at the point where the distance between the antenna and device exterior is a minimum.

GSM Note:

- Per KDB 447498 D01v06, the maximum output power channel is used for SAR testing and for further SAR test reduction.
- Per KDB 941225 D01v03r01, for SAR test reduction for GPRS and EDGE modes is determined by the frame-average power including tune-up tolerance, for modes with the same specified maximum output power and tolerance, the higher number time-slot configuration should be tested, therefore, the GPRS 2Tx slots modes was selected when EUT operating without power back-off and with power back-off, according to the highest frame-average power.

UMTS Note:

- Per KDB 941225 D01v03r01, for SAR testing is measured using a 12.2 kbps RMC with TPC bits configured to all "1's".
- Per KDB 941225 D01v03r01, RMC 12.2kbps setting is used to evaluate SAR. If the maximum output power and tune-up tolerance specified for production units in HSDPA / HSUPA / DC-HSDPA is ≤ ¼ dB higher than RMC 12.2Kbps or when the highest reported SAR of the RMC12.2Kbps is scaled by the ratio of specified maximum output power and tune-up tolerance of HSDPA / HSUPA / DC-HSDPA to RMC12.2Kbps and the adjusted SAR is ≤ 1.2 W/kg, SAR measurement is not required for HSDPA / HSUPA / DC-HSDPA.

**LTE Note:**

1. Per KDB 941225 D05v02r05, start with the largest channel bandwidth and measure SAR for QPSK with 1 RB allocation, using the RB offset and required test channel combination with the highest maximum output power for RB offsets at the upper edge, middle and lower edge of each required test channel.
2. Per KDB 941225 D05v02r05, 50% RB allocation for QPSK SAR testing follows 1RB QPSK allocation procedure.
3. Per KDB 941225 D05v02r05, For QPSK with 100% RB allocation, SAR is not required when the highest maximum output power for 100 % RB allocation is less than the highest maximum output power in 50% and 1 RB allocations and the highest reported SAR for 1 RB and 50% RB allocation are ≤ 0.8 W/kg. Otherwise, SAR is measured for the highest output power channel; and if the reported SAR is > 1.45 W/kg, the remaining required test channels must also be tested.
4. Per KDB 941225 D05v02r05, 16QAM output power for each RB allocation configuration is $>$ not $\frac{1}{2}$ dB higher than the same configuration in QPSK and the reported SAR for the QPSK configuration is ≤ 1.45 W/kg; Per KDB 941225 D05v02r05, 16QAM SAR testing is not required.
5. Per KDB 941225 D05v02r05, Smaller bandwidth output power for each RB allocation configuration is $>$ not $\frac{1}{2}$ dB higher than the same configuration in the largest supported bandwidth, and the reported SAR for the largest supported bandwidth is ≤ 1.45 W/kg; Per KDB 941225 D05v02r05, smaller bandwidth SAR testing is not required.
6. For LTE B12 / B5 / B4 the maximum bandwidth does not support three non-overlapping channels, per KDB 941225 D05v02r05, when a device supports overlapping channel assignment in a channel bandwidth configuration, the middle channel of the group of overlapping channels should be selected for testing.
7. LTE band 17 SAR test was covered by Band 12; according to April 2015 TCB workshop, SAR test for overlapping LTE bands can be reduced if
 - c. the maximum output power, including tolerance, for the smaller band is \leq the larger band to qualify for the SAR test exclusion
 - d. the channel bandwidth and other operating parameters for the smaller band are fully supported by the larger band

WLAN Note:

1. Per KDB 248227 D01v02r02, for 2.4GHz 802.11g/n SAR testing is not required when the highest reported SAR for DSSS is adjusted by the ratio of OFDM to DSSS specified maximum output power and the adjusted SAR is ≤ 1.2 W/kg.
2. When the reported SAR of the test position is > 0.4 W/kg, SAR is repeated for the 802.11 transmission mode configuration tested in the initial test position to measure the subsequent next closest/smallest test separation distance and maximum coupling test position on the highest maximum output power channel, until the report SAR is ≤ 0.8 W/kg or all required test position are tested.
3. For all positions / configurations, when the reported SAR is > 0.8 W/kg, SAR is measured for these test positions / configurations on the subsequent next highest measured output power channel(s) until the reported SAR is ≤ 1.2 W/kg or all required channels are tested.
4. During SAR testing the WLAN transmission was verified using a spectrum analyzer.
5. For simultaneous transmission analysis for exposure position of bottom face 9mm, WLAN/Bluetooth SAR tested at 9mm separation are used for conservative SAR summation.



15.1 Body SAR

<GSM SAR>

Plot No.	Band	Mode	Test Position	Gap (mm)	Power Back-off	Ch.	Freq. (MHz)	Average Power (dBm)	Tune-Up Limit (dBm)	Tune-up Scaling Factor	Power Drift (dB)	Measured 1g SAR (W/kg)	Reported 1g SAR (W/kg)
	GSM850	GPRS(2 Tx slots)	Bottom Face	0	On	251	848.8	23.23	23.5	1.064	0.02	0.601	0.640
	GSM850	GPRS(2 Tx slots)	Edge 1	0	On	251	848.8	23.23	23.5	1.064	0.04	0.267	0.284
	GSM850	GPRS(2 Tx slots)	Edge 2	0	On	251	848.8	23.23	23.5	1.064	0.01	0.170	0.181
	GSM850	GPRS(2 Tx slots)	Curved Surface of Edge 1	0	On	251	848.8	23.23	23.5	1.064	0.04	0.374	0.398
	GSM850	GPRS(2 Tx slots)	Bottom Face	9	Off	251	848.8	30.94	31.5	1.138	0.05	0.961	1.093
	GSM850	GPRS(2 Tx slots)	Bottom Face	9	Off	128	824.2	30.87	31.5	1.156	0.03	0.837	0.968
#01	GSM850	GPRS(2 Tx slots)	Bottom Face	9	Off	189	836.4	30.93	31.5	1.140	0.02	0.967	1.103
	GSM850	GPRS(2 Tx slots)	Edge 1	6	Off	251	848.8	30.94	31.5	1.138	0.12	0.721	0.820
	GSM850	GPRS(2 Tx slots)	Edge 1	6	Off	128	824.2	30.87	31.5	1.156	0.14	0.786	0.909
	GSM850	GPRS(2 Tx slots)	Edge 1	6	Off	189	836.4	30.93	31.5	1.140	0.15	0.757	0.863
	GSM850	GPRS(2 Tx slots)	Edge 2	5	Off	251	848.8	30.94	31.5	1.138	0.05	0.454	0.516
	GSM850	GPRS(2 Tx slots)	Edge 3	0	Off	251	848.8	30.94	31.5	1.138	-0.12	0.077	0.088
	GSM850	GPRS(2 Tx slots)	Edge 4	0	Off	251	848.8	30.94	31.5	1.138	0.03	0.234	0.266
	GSM1900	GPRS(2 Tx slots)	Bottom Face	0	On	661	1880	18.13	18.5	1.089	0.07	0.374	0.407
	GSM1900	GPRS(2 Tx slots)	Edge 1	0	On	661	1880	18.13	18.5	1.089	-0.05	0.202	0.220
	GSM1900	GPRS(2 Tx slots)	Edge 2	0	On	661	1880	18.13	18.5	1.089	0.02	0.043	0.047
	GSM1900	GPRS(2 Tx slots)	Curved Surface of Edge 1	0	On	661	1880	18.13	18.5	1.089	0.1	0.210	0.229
	GSM1900	GPRS(2 Tx slots)	Bottom Face	9	Off	661	1880	28.19	28.5	1.074	0.05	0.544	0.584
#02	GSM1900	GPRS(2 Tx slots)	Bottom Face	9	Off	512	1850.2	28.09	28.5	1.099	-0.01	0.590	0.648
	GSM1900	GPRS(2 Tx slots)	Bottom Face	9	Off	810	1909.8	28.17	28.5	1.079	0.01	0.546	0.589
	GSM1900	GPRS(2 Tx slots)	Edge 1	6	Off	661	1880	28.19	28.5	1.074	0.03	0.526	0.565
	GSM1900	GPRS(2 Tx slots)	Edge 2	5	Off	661	1880	28.19	28.5	1.074	0.05	0.215	0.231
	GSM1900	GPRS(2 Tx slots)	Edge 4	0	Off	661	1880	28.19	28.5	1.074	0.08	0.245	0.263



<WCDMA SAR>

Plot No.	Band	Mode	Test Position	Gap (mm)	Power Back-off	Ch.	Freq. (MHz)	Average Power (dBm)	Tune-Up Limit (dBm)	Tune-up Scaling Factor	Power Drift (dB)	Measured 1g SAR (W/kg)	Reported 1g SAR (W/kg)
	WCDMA Band V	RMC 12.2Kbps	Bottom Face	0	On	4233	846.6	15.72	16	1.067	0.07	0.423	0.451
	WCDMA Band V	RMC 12.2Kbps	Edge 1	0	On	4233	846.6	15.72	16	1.067	0.08	0.185	0.197
	WCDMA Band V	RMC 12.2Kbps	Edge 2	0	On	4233	846.6	15.72	16	1.067	0.04	0.117	0.125
	WCDMA Band V	RMC 12.2Kbps	Curved Surface of Edge 1	0	On	4233	846.6	15.72	16	1.067	0.09	0.219	0.234
	WCDMA Band V	RMC 12.2Kbps	Bottom Face	9	Off	4233	846.6	23.42	24	1.143	0.06	0.600	0.686
#03	WCDMA Band V	RMC 12.2Kbps	Bottom Face	9	Off	4132	826.4	23.28	24	1.180	0.07	0.650	0.767
	WCDMA Band V	RMC 12.2Kbps	Bottom Face	9	Off	4182	836.4	23.26	24	1.186	0.16	0.592	0.702
	WCDMA Band V	RMC 12.2Kbps	Edge 1	6	Off	4233	846.6	23.42	24	1.143	0.01	0.484	0.553
	WCDMA Band V	RMC 12.2Kbps	Edge 2	5	Off	4233	846.6	23.42	24	1.143	0.06	0.315	0.360
	WCDMA Band V	RMC 12.2Kbps	Edge 3	0	Off	4233	846.6	23.42	24	1.143	-0.08	0.051	0.058
	WCDMA Band V	RMC 12.2Kbps	Edge 4	0	Off	4233	846.6	23.42	24	1.143	0.02	0.165	0.189
	WCDMA Band IV	RMC 12.2Kbps	Bottom Face	0	On	1513	1752.6	13.71	14	1.069	0.05	0.667	0.713
	WCDMA Band IV	RMC 12.2Kbps	Edge 1	0	On	1513	1752.6	13.71	14	1.069	-0.15	0.195	0.208
	WCDMA Band IV	RMC 12.2Kbps	Edge 2	0	On	1513	1752.6	13.71	14	1.069	0.02	0.097	0.104
	WCDMA Band IV	RMC 12.2Kbps	Curved Surface of Edge 1	0	On	1513	1752.6	13.71	14	1.069	0.03	0.244	0.261
#04	WCDMA Band IV	RMC 12.2Kbps	Bottom Face	9	Off	1513	1752.6	23.23	24	1.194	0.06	0.918	1.096
	WCDMA Band IV	RMC 12.2Kbps	Bottom Face	9	Off	1312	1712.4	23.12	24	1.225	0.04	0.814	0.997
	WCDMA Band IV	RMC 12.2Kbps	Bottom Face	9	Off	1413	1732.6	23.16	24	1.213	0.02	0.857	1.040
	WCDMA Band IV	RMC 12.2Kbps	Edge 1	6	Off	1513	1752.6	23.23	24	1.194	0.06	0.616	0.735
	WCDMA Band IV	RMC 12.2Kbps	Edge 2	5	Off	1513	1752.6	23.23	24	1.194	0.05	0.413	0.493
	WCDMA Band IV	RMC 12.2Kbps	Edge 4	0	Off	1513	1752.6	23.23	24	1.194	0.07	0.430	0.513
	WCDMA Band II	RMC 12.2Kbps	Bottom Face	0	On	9538	1907.6	13.92	14.5	1.143	0.08	0.580	0.663
	WCDMA Band II	RMC 12.2Kbps	Edge 1	0	On	9538	1907.6	13.92	14.5	1.143	0.13	0.307	0.351
	WCDMA Band II	RMC 12.2Kbps	Edge 2	0	On	9538	1907.6	13.92	14.5	1.143	0.01	0.060	0.069
	WCDMA Band II	RMC 12.2Kbps	Curved Surface of Edge 1	0	On	9538	1907.6	13.92	14.5	1.143	0.02	0.339	0.387
	WCDMA Band II	RMC 12.2Kbps	Bottom Face	9	Off	9538	1907.6	23.47	24	1.130	0.01	0.682	0.771
	WCDMA Band II	RMC 12.2Kbps	Bottom Face	9	Off	9262	1852.4	23.32	24	1.169	0.02	0.793	0.927
#05	WCDMA Band II	RMC 12.2Kbps	Bottom Face	9	Off	9400	1880	23.4	24	1.148	0.12	0.825	0.947
	WCDMA Band II	RMC 12.2Kbps	Edge 1	6	Off	9538	1907.6	23.47	24	1.130	-0.01	0.668	0.755
	WCDMA Band II	RMC 12.2Kbps	Edge 2	5	Off	9538	1907.6	23.47	24	1.130	0.03	0.257	0.290
	WCDMA Band II	RMC 12.2Kbps	Edge 4	0	Off	9538	1907.6	23.47	24	1.130	0.08	0.299	0.338



Plot No.	Band	BW (MHz)	Mode	RB Size	RB offset	Test Position	Gap (mm)	Power Back-off	Ch.	Freq. (MHz)	Average Power (dBm)	Tune-Up Limit (dBm)	Tune-up Scaling Factor	Power Drift (dB)	Measured 1g SAR (W/kg)	Reported 1g SAR (W/kg)
	LTE Band 12	10M	QPSK	1	25	Bottom Face	0	On	23095	707.5	14.94	15.5	1.138	0.02	0.291	0.331
	LTE Band 12	10M	QPSK	25	0	Bottom Face	0	On	23095	707.5	14.8	15.5	1.175	0.09	0.285	0.335
	LTE Band 12	10M	QPSK	1	25	Edge 1	0	On	23095	707.5	14.94	15.5	1.138	0.01	0.180	0.205
	LTE Band 12	10M	QPSK	25	0	Edge 1	0	On	23095	707.5	14.8	15.5	1.175	-0.01	0.179	0.210
	LTE Band 12	10M	QPSK	1	25	Edge 2	0	On	23095	707.5	14.94	15.5	1.138	-0.09	0.071	0.081
	LTE Band 12	10M	QPSK	25	0	Edge 2	0	On	23095	707.5	14.8	15.5	1.175	-0.03	0.065	0.076
	LTE Band 12	10M	QPSK	1	25	Curved Surface of Edge 1	0	On	23095	707.5	14.94	15.5	1.138	0.09	0.143	0.163
	LTE Band 12	10M	QPSK	25	0	Curved Surface of Edge 1	0	On	23095	707.5	14.8	15.5	1.175	0.06	0.148	0.174
#06	LTE Band 12	10M	QPSK	1	25	Bottom Face	9	Off	23095	707.5	22.86	24	1.300	0.08	0.466	0.606
	LTE Band 12	10M	QPSK	25	0	Bottom Face	9	Off	23095	707.5	21.98	23	1.265	0.03	0.373	0.472
	LTE Band 12	10M	QPSK	1	25	Edge 1	6	Off	23095	707.5	22.86	24	1.300	0.08	0.222	0.289
	LTE Band 12	10M	QPSK	25	0	Edge 1	6	Off	23095	707.5	21.98	23	1.265	0.14	0.172	0.218
	LTE Band 12	10M	QPSK	1	25	Edge 2	5	Off	23095	707.5	22.86	24	1.300	0.05	0.223	0.290
	LTE Band 12	10M	QPSK	25	0	Edge 2	5	Off	23095	707.5	21.98	23	1.265	0.11	0.184	0.233
	LTE Band 12	10M	QPSK	1	25	Edge 3	0	Off	23095	707.5	22.86	24	1.300	-0.12	0.082	0.107
	LTE Band 12	10M	QPSK	25	0	Edge 3	0	Off	23095	707.5	21.98	23	1.265	0.02	0.073	0.092
	LTE Band 12	10M	QPSK	1	25	Edge 4	0	Off	23095	707.5	22.86	24	1.300	0.1	0.196	0.255
	LTE Band 12	10M	QPSK	25	0	Edge 4	0	Off	23095	707.5	21.98	23	1.265	0.04	0.150	0.190
	LTE Band 5	10M	QPSK	1	25	Bottom Face	0	On	20525	836.5	13.19	13.5	1.074	0.06	0.177	0.190
	LTE Band 5	10M	QPSK	25	0	Bottom Face	0	On	20525	836.5	13.12	13.5	1.091	0.04	0.206	0.225
	LTE Band 5	10M	QPSK	1	25	Edge 1	0	On	20525	836.5	13.19	13.5	1.074	-0.08	0.090	0.097
	LTE Band 5	10M	QPSK	25	0	Edge 1	0	On	20525	836.5	13.12	13.5	1.091	-0.08	0.093	0.102
	LTE Band 5	10M	QPSK	1	25	Edge 2	0	On	20525	836.5	13.19	13.5	1.074	-0.08	0.050	0.054
	LTE Band 5	10M	QPSK	25	0	Edge 2	0	On	20525	836.5	13.12	13.5	1.091	0.08	0.066	0.072
	LTE Band 5	10M	QPSK	1	25	Curved Surface of Edge 1	0	On	20525	836.5	13.19	13.5	1.074	0.04	0.120	0.129
	LTE Band 5	10M	QPSK	25	0	Curved Surface of Edge 1	0	On	20525	836.5	13.12	13.5	1.091	0.02	0.130	0.142
#07	LTE Band 5	10M	QPSK	1	25	Bottom Face	9	Off	20525	836.5	22.9	24	1.288	0.09	0.618	0.796
	LTE Band 5	10M	QPSK	25	0	Bottom Face	9	Off	20525	836.5	21.92	23	1.282	0.19	0.527	0.676
	LTE Band 5	10M	QPSK	1	25	Edge 1	6	Off	20525	836.5	22.9	24	1.288	0.14	0.425	0.548
	LTE Band 5	10M	QPSK	25	0	Edge 1	6	Off	20525	836.5	21.92	23	1.282	0.14	0.360	0.462
	LTE Band 5	10M	QPSK	1	25	Edge 2	5	Off	20525	836.5	22.9	24	1.288	0.04	0.264	0.340
	LTE Band 5	10M	QPSK	25	0	Edge 2	5	Off	20525	836.5	21.92	23	1.282	0.02	0.220	0.282
	LTE Band 5	10M	QPSK	1	25	Edge 3	0	Off	20525	836.5	22.9	24	1.288	0.06	0.038	0.049
	LTE Band 5	10M	QPSK	25	0	Edge 3	0	Off	20525	836.5	21.92	23	1.282	0.07	0.031	0.040
	LTE Band 5	10M	QPSK	1	25	Edge 4	0	Off	20525	836.5	22.9	24	1.288	0.09	0.184	0.237
	LTE Band 5	10M	QPSK	25	0	Edge 4	0	Off	20525	836.5	21.92	23	1.282	-0.04	0.155	0.199



Plot No.	Band	BW (MHz)	Mode	RB Size	RB offset	Test Position	Gap (mm)	Power Back-off	Ch.	Freq. (MHz)	Average Power (dBm)	Tune-Up Limit (dBm)	Tune-up Scaling Factor	Power Drift (dB)	Measured 1g SAR (W/kg)	Reported 1g SAR (W/kg)
	LTE Band 4	20M	QPSK	1	0	Bottom Face	0	On	20175	1732.5	12.95	13.5	1.135	0.02	0.451	0.512
	LTE Band 4	20M	QPSK	50	0	Bottom Face	0	On	20175	1732.5	13.02	13.5	1.117	0.09	0.488	0.545
	LTE Band 4	20M	QPSK	1	0	Edge 1	0	On	20175	1732.5	12.95	13.5	1.135	-0.08	0.123	0.140
	LTE Band 4	20M	QPSK	50	0	Edge 1	0	On	20175	1732.5	13.02	13.5	1.117	-0.06	0.136	0.152
	LTE Band 4	20M	QPSK	1	0	Edge 2	0	On	20175	1732.5	12.95	13.5	1.135	0.03	0.064	0.073
	LTE Band 4	20M	QPSK	50	0	Edge 2	0	On	20175	1732.5	13.02	13.5	1.117	-0.02	0.073	0.082
	LTE Band 4	20M	QPSK	1	0	Curved Surface of Edge 1	0	On	20175	1732.5	12.95	13.5	1.135	0.07	0.187	0.212
	LTE Band 4	20M	QPSK	50	0	Curved Surface of Edge 1	0	On	20175	1732.5	13.02	13.5	1.117	0.05	0.197	0.220
#08	LTE Band 4	20M	QPSK	1	0	Bottom Face	9	Off	20175	1732.5	22.98	24	1.265	0.04	0.940	1.189
	LTE Band 4	20M	QPSK	50	0	Bottom Face	9	Off	20175	1732.5	21.95	23	1.274	0.05	0.725	0.923
	LTE Band 4	20M	QPSK	100	0	Bottom Face	9	Off	20175	1732.5	21.73	23	1.340	0.05	0.751	1.006
	LTE Band 4	20M	QPSK	1	0	Edge 1	6	Off	20175	1732.5	22.98	24	1.265	0.02	0.558	0.706
	LTE Band 4	20M	QPSK	50	0	Edge 1	6	Off	20175	1732.5	21.95	23	1.274	-0.05	0.457	0.582
	LTE Band 4	20M	QPSK	1	0	Edge 2	5	Off	20175	1732.5	22.98	24	1.265	0.07	0.374	0.473
	LTE Band 4	20M	QPSK	50	0	Edge 2	5	Off	20175	1732.5	21.95	23	1.274	0.03	0.292	0.372
	LTE Band 4	20M	QPSK	1	0	Edge 4	0	Off	20175	1732.5	22.98	24	1.265	0.11	0.287	0.363
	LTE Band 4	20M	QPSK	50	0	Edge 4	0	Off	20175	1732.5	21.95	23	1.274	-0.03	0.229	0.292
	LTE Band 2	20M	QPSK	1	0	Bottom Face	0	On	18900	1880	13.28	13.5	1.052	0.03	0.470	0.494
	LTE Band 2	20M	QPSK	50	50	Bottom Face	0	On	18900	1880	13.17	13.5	1.079	0.05	0.512	0.552
	LTE Band 2	20M	QPSK	1	0	Edge 1	0	On	18900	1880	13.28	13.5	1.052	0.07	0.186	0.196
	LTE Band 2	20M	QPSK	50	50	Edge 1	0	On	18900	1880	13.17	13.5	1.079	-0.12	0.277	0.299
	LTE Band 2	20M	QPSK	1	0	Edge 2	0	On	18900	1880	13.28	13.5	1.052	0.05	0.040	0.042
	LTE Band 2	20M	QPSK	50	50	Edge 2	0	On	18900	1880	13.17	13.5	1.079	0.06	0.064	0.069
	LTE Band 2	20M	QPSK	1	0	Curved Surface of Edge 1	0	On	18900	1880	13.28	13.5	1.052	0.02	0.225	0.237
	LTE Band 2	20M	QPSK	50	50	Curved Surface of Edge 1	0	On	18900	1880	13.17	13.5	1.079	0.07	0.343	0.370
	LTE Band 2	20M	QPSK	1	0	Bottom Face	9	Off	18900	1880	23.13	23.5	1.089	0.14	0.845	0.920
#09	LTE Band 2	20M	QPSK	1	0	Bottom Face	9	Off	18700	1860	23.12	23.5	1.091	0.03	0.919	1.003
	LTE Band 2	20M	QPSK	1	0	Bottom Face	9	Off	19100	1900	23.09	23.5	1.099	0.08	0.826	0.908
	LTE Band 2	20M	QPSK	50	50	Bottom Face	9	Off	18900	1880	22.07	22.5	1.104	0.01	0.690	0.762
	LTE Band 2	20M	QPSK	100	0	Bottom Face	9	Off	18900	1880	22.06	22.5	1.107	0.08	0.680	0.753
	LTE Band 2	20M	QPSK	1	0	Edge 1	6	Off	18900	1880	23.13	23.5	1.089	0.09	0.803	0.874
	LTE Band 2	20M	QPSK	1	0	Edge 1	6	Off	18700	1860	23.12	23.5	1.091	0.13	0.827	0.903
	LTE Band 2	20M	QPSK	1	0	Edge 1	6	Off	19100	1900	23.09	23.5	1.099	-0.05	0.783	0.861
	LTE Band 2	20M	QPSK	50	50	Edge 1	6	Off	18900	1880	22.07	22.5	1.104	0.04	0.632	0.698
	LTE Band 2	20M	QPSK	100	0	Edge 1	6	Off	18900	1880	22.06	22.5	1.107	-0.02	0.617	0.683
	LTE Band 2	20M	QPSK	1	0	Edge 2	5	Off	18900	1880	23.13	23.5	1.089	0.04	0.329	0.358
	LTE Band 2	20M	QPSK	50	50	Edge 2	5	Off	18900	1880	22.07	22.5	1.104	0.06	0.277	0.306
	LTE Band 2	20M	QPSK	1	0	Edge 4	0	Off	18900	1880	23.13	23.5	1.089	-0.07	0.210	0.229
	LTE Band 2	20M	QPSK	50	50	Edge 4	0	Off	18900	1880	22.07	22.5	1.104	-0.01	0.154	0.170



Plot No.	Band	BW (MHz)	Mode	RB Size	RB offset	Test Position	Gap (mm)	Power Back-off	Ch.	Freq. (MHz)	Average Power (dBm)	Tune-Up Limit (dBm)	Tune-up Scaling Factor	Power Drift (dB)	Measured 1g SAR (W/kg)	Reported 1g SAR (W/kg)
	LTE Band 7	20M	QPSK	1	0	Bottom Face	0	On	21100	2535	13.93	14.5	1.140	0.00	0.427	0.487
	LTE Band 7	20M	QPSK	50	0	Bottom Face	0	On	21100	2535	13.73	14.5	1.194	0.03	0.420	0.501
	LTE Band 7	20M	QPSK	1	0	Edge 1	0	On	21100	2535	13.93	14.5	1.140	0.07	0.545	0.621
	LTE Band 7	20M	QPSK	50	0	Edge 1	0	On	21100	2535	13.73	14.5	1.194	0.01	0.535	0.639
	LTE Band 7	20M	QPSK	1	0	Edge 2	0	On	21100	2535	13.93	14.5	1.140	0.00	0.030	0.034
	LTE Band 7	20M	QPSK	50	0	Edge 2	0	On	21100	2535	13.73	14.5	1.194	0.02	0.031	0.037
	LTE Band 7	20M	QPSK	1	0	Curved Surface of Edge 1	0	On	21100	2535	13.93	14.5	1.140	0.01	0.556	0.634
	LTE Band 7	20M	QPSK	50	0	Curved Surface of Edge 1	0	On	21100	2535	13.73	14.5	1.194	0.05	0.544	0.650
	LTE Band 7	20M	QPSK	1	0	Bottom Face	9	Off	21100	2535	21.91	23	1.285	0.07	0.694	0.892
	LTE Band 7	20M	QPSK	1	0	Bottom Face	9	Off	20850	2510	21.87	23	1.297	-0.08	0.722	0.937
	LTE Band 7	20M	QPSK	1	0	Bottom Face	9	Off	21350	2560	21.88	23	1.294	-0.06	0.809	1.047
	LTE Band 7	20M	QPSK	50	0	Bottom Face	9	Off	21100	2535	20.8	22	1.318	0.07	0.534	0.704
	LTE Band 7	20M	QPSK	100	0	Bottom Face	9	Off	21100	2535	20.78	22	1.324	0.09	0.470	0.622
	LTE Band 7	20M	QPSK	1	0	Edge 1	6	Off	21100	2535	21.91	23	1.285	0.01	1.030	1.324
	LTE Band 7	20M	QPSK	1	0	Edge 1	6	Off	20850	2510	21.87	23	1.297	-0.01	0.945	1.226
#10	LTE Band 7	20M	QPSK	1	0	Edge 1	6	Off	21350	2560	21.88	23	1.294	0.04	1.050	1.359
	LTE Band 7	20M	QPSK	50	0	Edge 1	6	Off	21100	2535	20.8	22	1.318	0.19	0.789	1.040
	LTE Band 7	20M	QPSK	50	0	Edge 1	6	Off	20850	2510	20.66	22	1.361	-0.12	0.731	0.995
	LTE Band 7	20M	QPSK	50	0	Edge 1	6	Off	21350	2560	20.77	22	1.327	0.07	0.803	1.066
	LTE Band 7	20M	QPSK	100	0	Edge 1	6	Off	21100	2535	20.78	22	1.324	0.07	0.780	1.033
	LTE Band 7	20M	QPSK	1	0	Edge 2	5	Off	21100	2535	21.91	23	1.285	0.01	0.166	0.213
	LTE Band 7	20M	QPSK	50	0	Edge 2	5	Off	21100	2535	20.8	22	1.318	0.02	0.127	0.167
	LTE Band 7	20M	QPSK	1	0	Edge 4	0	Off	21100	2535	21.91	23	1.285	-0.06	0.034	0.044
	LTE Band 7	20M	QPSK	50	0	Edge 4	0	Off	21100	2535	20.8	22	1.318	0.02	0.023	0.030



<WLAN DTS SAR>

Plot No.	Band	Mode	Test Position	Gap (mm)	Ch.	Freq. (MHz)	Average Power (dBm)	Tune-Up Limit (dBm)	Tune-up Scaling Factor	Duty Cycle %	Duty Cycle Scaling Factor	Power Drift (dB)	Measured 1g SAR (W/kg)	Reported 1g SAR (W/kg)
	WLAN2.4GHz	802.11b 1Mbps	Bottom Face	0	1	2412	14.27	15	1.183	97.94	1.021	0.05	0.654	0.790
#11	WLAN2.4GHz	802.11b 1Mbps	Bottom Face	0	6	2437	13.57	14	1.104	97.94	1.021	0.02	1.110	1.251
	WLAN2.4GHz	802.11b 1Mbps	Bottom Face	0	11	2462	13.20	14	1.202	97.94	1.021	0.03	0.988	1.213
	WLAN2.4GHz	802.11b 1Mbps	Bottom Face	9	1	2412	14.27	15	1.183	97.94	1.021	0.01	0.099	0.120
	WLAN2.4GHz	802.11b 1Mbps	Edge 3	0	1	2412	14.27	15	1.183	97.94	1.021	0.05	0.413	0.499
	WLAN2.4GHz	802.11b 1Mbps	Edge 4	0	1	2412	14.27	15	1.183	97.94	1.021	0.02	0.142	0.172
	WLAN2.4GHz	802.11b 1Mbps	Curved Surface of Edge 3	0	1	2412	14.27	15	1.183	97.94	1.021	0.04	0.511	0.617



<WLAN NII SAR>

Plot No.	Band	Mode	Test Position	Gap (mm)	Ch.	Freq. (MHz)	Average Power (dBm)	Tune-Up Limit (dBm)	Tune-up Scaling Factor	Duty Cycle %	Duty Cycle Scaling Factor	Power Drift (dB)	Measured 1g SAR (W/kg)	Reported 1g SAR (W/kg)
	WLAN5.2GHz	802.11a 6Mbps	Bottom Face	0	40	5200	14.97	15.5	1.130	87.44	1.144	0.02	0.792	1.024
#12	WLAN5.2GHz	802.11a 6Mbps	Bottom Face	0	48	5240	14.97	15.5	1.130	87.44	1.144	0.03	0.990	1.280
	WLAN5.2GHz	802.11a 6Mbps	Bottom Face	0	44	5220	14.84	15.5	1.163	87.44	1.144	0.01	0.854	1.137
	WLAN5.2GHz	802.11a 6Mbps	Bottom Face	0	36	5180	14.43	15	1.140	87.44	1.144	-0.08	0.806	1.051
	WLAN5.2GHz	802.11a 6Mbps	Bottom Face	9	40	5200	14.97	15.5	1.130	87.44	1.144	0.13	0.178	0.230
	WLAN5.2GHz	802.11a 6Mbps	Edge 3	0	40	5200	14.97	15.5	1.130	87.44	1.144	0.05	0.886	1.145
	WLAN5.2GHz	802.11a 6Mbps	Edge 3	0	48	5240	14.97	15.5	1.130	87.44	1.144	0.04	0.930	1.202
	WLAN5.2GHz	802.11a 6Mbps	Edge 3	0	44	5220	14.84	15.5	1.163	87.44	1.144	-0.02	0.919	1.223
	WLAN5.2GHz	802.11a 6Mbps	Edge 3	0	36	5180	14.43	15	1.140	87.44	1.144	-0.15	0.851	1.109
	WLAN5.2GHz	802.11a 6Mbps	Edge 4	0	40	5200	14.97	15.5	1.130	87.44	1.144	0.05	0.389	0.503
	WLAN5.2GHz	802.11a 6Mbps	Curved Surface of Edge 3	0	40	5200	14.97	15.5	1.130	87.44	1.144	0.14	0.965	1.247
	WLAN5.2GHz	802.11a 6Mbps	Curved Surface of Edge 3	0	48	5240	14.97	15.5	1.130	87.44	1.144	0.06	0.813	1.051
	WLAN5.3GHz	802.11a 6Mbps	Bottom Face	0	52	5260	14.66	15	1.081	87.44	1.144	0.08	1.020	1.261
	WLAN5.3GHz	802.11a 6Mbps	Bottom Face	0	60	5300	14.28	14.5	1.051	87.44	1.144	-0.16	1.050	1.263
#13	WLAN5.3GHz	802.11a 6Mbps	Bottom Face	0	56	5280	14.07	14.5	1.104	87.44	1.144	0.05	1.050	1.326
	WLAN5.3GHz	802.11a 6Mbps	Bottom Face	0	64	5320	13.26	13.5	1.056	87.44	1.144	0.03	0.955	1.154
	WLAN5.3GHz	802.11a 6Mbps	Bottom Face	9	52	5260	14.66	15	1.081	87.44	1.144	-0.03	0.218	0.270
	WLAN5.3GHz	802.11a 6Mbps	Edge 3	0	52	5260	14.66	15	1.081	87.44	1.144	-0.04	1.010	1.249
	WLAN5.3GHz	802.11a 6Mbps	Edge 3	0	60	5300	14.28	14.5	1.051	87.44	1.144	0.15	0.925	1.112
	WLAN5.3GHz	802.11a 6Mbps	Edge 4	0	52	5260	14.66	15	1.081	87.44	1.144	-0.08	0.492	0.608
	WLAN5.3GHz	802.11a 6Mbps	Curved Surface of Edge 3	0	52	5260	14.66	15	1.081	87.44	1.144	-0.14	1.060	1.311
	WLAN5.3GHz	802.11a 6Mbps	Curved Surface of Edge 3	0	60	5300	14.28	14.5	1.051	87.44	1.144	0.08	0.956	1.150
	WLAN5.8GHz	802.11a 6Mbps	Bottom Face	0	161	5805	13.19	13.5	1.073	87.44	1.144	0.16	0.832	1.022
	WLAN5.8GHz	802.11a 6Mbps	Bottom Face	0	149	5745	12.59	13	1.098	87.44	1.144	0.06	0.791	0.994
	WLAN5.8GHz	802.11a 6Mbps	Bottom Face	0	157	5785	12.52	13	1.116	87.44	1.144	0.05	0.760	0.970
	WLAN5.8GHz	802.11a 6Mbps	Bottom Face	9	161	5805	13.19	13.5	1.073	87.44	1.144	-0.08	0.152	0.187
#14	WLAN5.8GHz	802.11a 6Mbps	Edge 3	0	161	5805	13.19	13.5	1.073	87.44	1.144	-0.03	1.100	1.351
	WLAN5.8GHz	802.11a 6Mbps	Edge 3	0	149	5745	12.59	13	1.098	87.44	1.144	-0.07	1.050	1.319
	WLAN5.8GHz	802.11a 6Mbps	Edge 3	0	157	5785	12.52	13	1.116	87.44	1.144	0.01	0.974	1.244
	WLAN5.8GHz	802.11a 6Mbps	Edge 4	0	161	5805	13.19	13.5	1.073	87.44	1.144	-0.06	0.151	0.185
	WLAN5.8GHz	802.11a 6Mbps	Curved Surface of Edge 3	0	161	5805	13.19	13.5	1.073	87.44	1.144	0.04	0.931	1.143
	WLAN5.8GHz	802.11a 6Mbps	Curved Surface of Edge 3	0	149	5745	12.59	13	1.098	87.44	1.144	0.02	0.920	1.156
	WLAN5.8GHz	802.11a 6Mbps	Curved Surface of Edge 3	0	157	5785	12.52	13	1.116	87.44	1.144	0.07	0.922	1.177



<Bluetooth SAR>

Plot No.	Band	Mode	Test Position	Gap (mm)	Ch.	Freq. (MHz)	Average Power (dBm)	Tune-Up Limit (dBm)	Tune-up Scaling Factor	Duty Cycle %	Duty Cycle Scaling Factor	Power Drift (dB)	Measured 1g SAR (W/kg)	Reported 1g SAR (W/kg)
	Bluetooth	1Mbps	Bottom Face	0	0	2402	10.24	10.5	1.062	-	1.000	0.01	0.362	0.384
	Bluetooth	1Mbps	Bottom Face	0	39	2441	9.92	10.5	1.143	-	1.000	0.06	0.359	0.410
#15	Bluetooth	1Mbps	Bottom Face	0	78	2480	9.31	10.5	1.315	-	1.000	0.05	0.315	0.414
	Bluetooth	1Mbps	Bottom Face	9	0	2402	10.24	10.5	1.062	-	1.000	0.07	0.053	0.056
	Bluetooth	1Mbps	Edge 3	0	0	2402	10.24	10.5	1.062	-	1.000	0.04	0.211	0.224
	Bluetooth	1Mbps	Curved Surface of Edge 3	0	0	2402	10.24	10.5	1.062	-	1.000	0.11	0.288	0.306



15.2 Repeated SAR Measurement

No.	Band	BW (MHz)	Mode	RB Size	RB offset	Test Position	Gap (mm)	Power Back-off	Ch.	Freq. (MHz)	Average Power (dBm)	Tune-Up Limit (dBm)	Tune-up Scaling Factor	Duty Cycle %	Duty Cycle Scaling Factor	Power Drift (dB)	Measured 1g SAR (W/kg)	Ratio	Reported 1g SAR (W/kg)
1st	GSM850		GPRS (2 Tx slots)			Bottom Face	9	Off	189	836.4	30.93	31.5	1.140	-	-	0.02	0.967	1	1.103
2nd	GSM850		GPRS (2 Tx slots)			Bottom Face	9	Off	189	836.4	30.93	31.5	1.140	-	-	0.01	0.960	1.007	1.095
1st	LTE Band 4	20M	QPSK	1	0	Bottom Face	9	Off	20175	1732.5	22.98	24	1.265	-	-	0.04	0.940	1	1.189
2nd	LTE Band 4	20M	QPSK	1	0	Bottom Face	9	Off	20175	1732.5	22.98	24	1.265	-	-	0.04	0.876	1.073	1.108
1st	LTE Band 2	20M	QPSK	1	0	Bottom Face	9	Off	18700	1860	23.12	23.5	1.091	-	-	0.03	0.919	1	1.003
2nd	LTE Band 2	20M	QPSK	1	0	Bottom Face	9	Off	18700	1860	23.12	23.5	1.091	-	-	0.01	0.864	1.064	0.943
1st	LTE Band 7	20M	QPSK	1	0	Edge 1	6	Off	21350	2560	21.88	23	1.294	-	-	0.04	1.050	1	1.359
2nd	LTE Band 7	20M	QPSK	1	0	Edge 1	6	Off	21350	2560	21.88	23	1.294	-	-	0.17	1.030	1.019	1.333
1st	WLAN2.4GHz	-	802.11b 1Mbps	-	-	Bottom Face	0	-	6	2437	13.57	14	1.104	97.94	1.021	0.02	1.110	1	1.251
2nd	WLAN2.4GHz	-	802.11b 1Mbps	-	-	Bottom Face	0	-	6	2437	13.57	14	1.104	97.94	1.021	0.08	1.070	1.037	1.206
1st	WLAN5.2GHz	-	802.11a 6Mbps	-	-	Bottom Face	0	-	48	5240	14.97	15.5	1.130	87.44	1.144	0.03	0.990	1	1.280
2nd	WLAN5.2GHz	-	802.11a 6Mbps	-	-	Bottom Face	0	-	48	5240	14.97	15.5	1.130	87.44	1.144	0.02	0.970	1.021	1.254
1st	WLAN5.3GHz	-	802.11a 6Mbps	-	-	Curved Surface of Edge 3	0	-	52	5260	14.66	15	1.081	87.44	1.144	-0.14	1.060	1	1.311
2nd	WLAN5.3GHz	-	802.11a 6Mbps	-	-	Curved Surface of Edge 3	0	-	52	5260	14.66	15	1.081	87.44	1.144	-0.07	1.050	1.010	1.298
1st	WLAN5.8GHz	-	802.11a 6Mbps	-	-	Edge 3	0	-	161	5805	13.19	13.5	1.073	87.44	1.144	-0.03	1.100	1	1.351
2nd	WLAN5.8GHz	-	802.11a 6Mbps	-	-	Edge 3	0	-	161	5805	13.19	13.5	1.073	87.44	1.144	-0.06	1.070	1.028	1.314

General Note:

1. Per KDB 865664 D01v01r04, for each frequency band, repeated SAR measurement is required only when the measured SAR is $\geq 0.8W/kg$.
2. Per KDB 865664 D01v01r04, if the ratio among the repeated measurement is ≤ 1.2 and the measured SAR $< 1.45W/kg$, only one repeated measurement is required.
3. The ratio is the difference in percentage between original and repeated *measured SAR*.
4. All measurement SAR result is scaled-up to account for tune-up tolerance and is compliant.

16. Simultaneous Transmission Analysis

NO.	Simultaneous Transmission Configurations	Tablet
		Body
1.	GPRS/EDGE + WLAN2.4GHz	Yes
2.	WCDMA + WLAN2.4GHz	Yes
3.	LTE + WLAN2.4GHz	Yes
4.	GPRS/EDGE + Bluetooth	Yes
5.	WCDMA+ Bluetooth	Yes
6.	LTE + Bluetooth	Yes
7.	GPRS/EDGE + WLAN5GHz	Yes
8.	WCDMA + WLAN5GHz	Yes
9.	LTE + WLAN5GHz	Yes

General Note:

1. EUT will choose either WLAN 2.4GHz or WLAN 5GHz according to the network signal condition; therefore, 2.4GHz WLAN and 5GHz WLAN will not operate simultaneously at any moment.
2. EUT will choose each GSM, WCDMA and LTE according to the network signal condition; therefore, they will not operate simultaneously at any moment.
3. WLAN and Bluetooth share the same antenna, and cannot transmit simultaneously.
4. For WLAN SAR chose the worse SAR of all 5G Band at the same position for co-located with WWAN analysis.
5. The reported SAR summation is calculated based on the same configuration and test position.
6. Per KDB 447498 D01v06, simultaneous transmission SAR is compliant if,
 - i) Scalar SAR summation < 1.6W/kg.
 - ii) $SPLSR = (SAR1 + SAR2)^{1.5} / (\text{min. separation distance, mm})$, and the peak separation distance is determined from the square root of $[(x1-x2)^2 + (y1-y2)^2 + (z1-z2)^2]$, where (x1, y1, z1) and (x2, y2, z2) are the coordinates of the extrapolated peak SAR locations in the zoom scan.
 - iii) If $SPLSR \leq 0.04$, simultaneously transmission SAR measurement is not necessary.
 - iv) Simultaneously transmission SAR measurement, and the reported multi-band SAR < 1.6W/kg.
 - v) The SPLSR calculated results please refer to section 16.2.



16.1 Body Exposure Conditions

<WWAN PCB + WLAN 2.4GHZ DTS>

WWAN Band		Exposure Position	1	2	1+2 Summed 1g SAR (W/kg)	SPLSR	Case No
			WWAN	2.4GHz WLAN			
			1g SAR (W/kg)	1g SAR (W/kg)			
GSM	GSM850	Bottom Face at 9mm	1.103	0.120	1.22		
		Edge 1 at 6mm	0.909		0.91		
		Edge 2 at 5mm	0.516		0.52		
		Bottom Face at 0mm	0.640	1.251	1.89	0.01	#1
		Edge 1 at 0mm	0.284		0.28		
		Edge 2 at 0mm	0.181		0.18		
		Edge 3 at 0mm	0.088	0.499	0.59		
		Edge 4 at 0mm	0.266	0.172	0.44		
		Curved Surface of Edge 1 at 0mm	0.398		0.40		
		Curved Surface of Edge 3 at 0mm		0.617	0.62		
	GSM1900	Bottom Face at 9mm	0.648	0.120	0.77		
		Edge 1 at 6mm	0.565		0.57		
		Edge 2 at 5mm	0.231		0.23		
		Bottom Face at 0mm	0.407	1.251	1.66	0.01	#2
		Edge 1 at 0mm	0.220		0.22		
		Edge 2 at 0mm	0.047		0.05		
		Edge 3 at 0mm		0.499	0.50		
		Edge 4 at 0mm	0.263	0.172	0.44		
		Curved Surface of Edge 1 at 0mm	0.229		0.23		
		Curved Surface of Edge 3 at 0mm		0.617	0.62		



WWAN Band		Exposure Position	1	2	1+2 Summed 1g SAR (W/kg)	SPLSR	Case No
			WWAN 1g SAR (W/kg)	2.4GHz WLAN 1g SAR (W/kg)			
WCDMA	WCDMA Band II	Bottom Face at 9mm	0.947	0.120	1.07		
		Edge 1 at 6mm	0.755		0.76		
		Edge 2 at 5mm	0.290		0.29		
		Bottom Face at 0mm	0.663	1.251	1.91	0.01	#3
		Edge 1 at 0mm	0.351		0.35		
		Edge 2 at 0mm	0.069		0.07		
		Edge 3 at 0mm		0.499	0.50		
		Edge 4 at 0mm	0.338	0.172	0.51		
		Curved Surface of Edge 1 at 0mm	0.387		0.39		
		Curved Surface of Edge 3 at 0mm		0.617	0.62		
	WCDMA Band IV	Bottom Face at 9mm	1.096	0.120	1.22		
		Edge 1 at 6mm	0.735		0.74		
		Edge 2 at 5mm	0.493		0.49		
		Bottom Face at 0mm	0.713	1.251	1.96	0.01	#4
		Edge 1 at 0mm	0.208		0.21		
		Edge 2 at 0mm	0.104		0.10		
		Edge 3 at 0mm		0.499	0.50		
		Edge 4 at 0mm	0.513	0.172	0.69		
		Curved Surface of Edge 1 at 0mm	0.261		0.26		
		Curved Surface of Edge 3 at 0mm		0.617	0.62		
	WCDMA Band V	Bottom Face at 9mm	0.767	0.120	0.89		
		Edge 1 at 6mm	0.553		0.55		
		Edge 2 at 5mm	0.360		0.36		
		Bottom Face at 0mm	0.451	1.251	1.70	0.01	#5
		Edge 1 at 0mm	0.197		0.20		
		Edge 2 at 0mm	0.125		0.13		
		Edge 3 at 0mm	0.058	0.499	0.56		
Edge 4 at 0mm		0.189	0.172	0.36			
Curved Surface of Edge 1 at 0mm		0.234		0.23			
Curved Surface of Edge 3 at 0mm			0.617	0.62			



WWAN Band		Exposure Position	1	2	1+2 Summed 1g SAR (W/kg)	SPLSR	Case No
			WWAN 1g SAR (W/kg)	2.4GHz WLAN 1g SAR (W/kg)			
LTE	LTE Band 2	Bottom Face at 9mm	1.003	0.120	1.12		
		Edge 1 at 6mm	0.903		0.90		
		Edge 2 at 5mm	0.358		0.36		
		Bottom Face at 0mm	0.552	1.251	1.80	0.01	#6
		Edge 1 at 0mm	0.299		0.30		
		Edge 2 at 0mm	0.069		0.07		
		Edge 3 at 0mm		0.499	0.50		
		Edge 4 at 0mm	0.229	0.172	0.40		
		Curved Surface of Edge 1 at 0mm	0.370		0.37		
		Curved Surface of Edge 3 at 0mm		0.617	0.62		
	LTE Band 4	Bottom Face at 9mm	1.189	0.120	1.31		
		Edge 1 at 6mm	0.706		0.71		
		Edge 2 at 5mm	0.473		0.47		
		Bottom Face at 0mm	0.545	1.251	1.80	0.01	#7
		Edge 1 at 0mm	0.152		0.15		
		Edge 2 at 0mm	0.082		0.08		
		Edge 3 at 0mm		0.499	0.50		
		Edge 4 at 0mm	0.363	0.172	0.54		
		Curved Surface of Edge 1 at 0mm	0.220		0.22		
		Curved Surface of Edge 3 at 0mm		0.617	0.62		
	LTE Band 5	Bottom Face at 9mm	0.796	0.120	0.92		
		Edge 1 at 6mm	0.548		0.55		
		Edge 2 at 5mm	0.340		0.34		
		Bottom Face at 0mm	0.225	1.251	1.48		
		Edge 1 at 0mm	0.102		0.10		
		Edge 2 at 0mm	0.072		0.07		
		Edge 3 at 0mm	0.049	0.499	0.55		
		Edge 4 at 0mm	0.237	0.172	0.41		
		Curved Surface of Edge 1 at 0mm	0.142		0.14		
		Curved Surface of Edge 3 at 0mm		0.617	0.62		



WWAN Band		Exposure Position	1	2	1+2 Summed 1g SAR (W/kg)	SPLSR	Case No
			WWAN 1g SAR (W/kg)	2.4GHz WLAN 1g SAR (W/kg)			
LTE	LTE Band 7	Bottom Face at 9mm	1.047	0.120	1.17		
		Edge 1 at 6mm	1.359		1.36		
		Edge 2 at 5mm	0.213		0.21		
		Bottom Face at 0mm	0.501	1.251	1.75	0.01	#8
		Edge 1 at 0mm	0.639		0.64		
		Edge 2 at 0mm	0.037		0.04		
		Edge 3 at 0mm		0.499	0.50		
		Edge 4 at 0mm	0.044	0.172	0.22		
		Curved Surface of Edge 1 at 0mm	0.650		0.65		
		Curved Surface of Edge 3 at 0mm		0.617	0.62		
	LTE Band 12	Bottom Face at 9mm	0.606	0.120	0.73		
		Edge 1 at 6mm	0.289		0.29		
		Edge 2 at 5mm	0.290		0.29		
		Bottom Face at 0mm	0.335	1.251	1.59		
		Edge 1 at 0mm	0.210		0.21		
		Edge 2 at 0mm	0.081		0.08		
		Edge 3 at 0mm	0.107	0.499	0.61		
		Edge 4 at 0mm	0.255	0.172	0.43		
		Curved Surface of Edge 1 at 0mm	0.174		0.17		
		Curved Surface of Edge 3 at 0mm		0.617	0.62		



<WWAN PCB + WLAN 5GHz NII>

WWAN Band		Exposure Position	1	3	1+3 Summed 1g SAR (W/kg)	SPLSR	Case No
			WWAN	5GHz WLAN			
			1g SAR (W/kg)	1g SAR (W/kg)			
GSM	GSM850	Bottom Face at 9mm	1.103	0.270	1.37		
		Edge 1 at 6mm	0.909		0.91		
		Edge 2 at 5mm	0.516		0.52		
		Bottom Face at 0mm	0.640	1.326	1.97	0.01	#9
		Edge 1 at 0mm	0.284		0.28		
		Edge 2 at 0mm	0.181		0.18		
		Edge 3 at 0mm	0.088	1.351	1.44		
		Edge 4 at 0mm	0.266	0.608	0.87		
		Curved Surface of Edge 1 at 0mm	0.398		0.40		
		Curved Surface of Edge 3 at 0mm		1.311	1.31		
	GSM1900	Bottom Face at 9mm	0.648	0.270	0.92		
		Edge 1 at 6mm	0.565		0.57		
		Edge 2 at 5mm	0.231		0.23		
		Bottom Face at 0mm	0.407	1.326	1.73	0.01	#10
		Edge 1 at 0mm	0.220		0.22		
		Edge 2 at 0mm	0.047		0.05		
		Edge 3 at 0mm		1.351	1.35		
		Edge 4 at 0mm	0.263	0.608	0.87		
		Curved Surface of Edge 1 at 0mm	0.229		0.23		
		Curved Surface of Edge 3 at 0mm		1.311	1.31		



WWAN Band		Exposure Position	1	3	1+3 Summed 1g SAR (W/kg)	SPLSR	Case No
			WWAN 1g SAR (W/kg)	5GHz WLAN 1g SAR (W/kg)			
WCDMA	WCDMA Band II	Bottom Face at 9mm	0.947	0.270	1.22		
		Edge 1 at 6mm	0.755		0.76		
		Edge 2 at 5mm	0.290		0.29		
		Bottom Face at 0mm	0.663	1.326	1.99	0.01	#11
		Edge 1 at 0mm	0.351		0.35		
		Edge 2 at 0mm	0.069		0.07		
		Edge 3 at 0mm		1.351	1.35		
		Edge 4 at 0mm	0.338	0.608	0.95		
		Curved Surface of Edge 1 at 0mm	0.387		0.39		
		Curved Surface of Edge 3 at 0mm		1.311	1.31		
	WCDMA Band IV	Bottom Face at 9mm	1.096	0.270	1.37		
		Edge 1 at 6mm	0.735		0.74		
		Edge 2 at 5mm	0.493		0.49		
		Bottom Face at 0mm	0.713	1.326	2.04	0.02	#12
		Edge 1 at 0mm	0.208		0.21		
		Edge 2 at 0mm	0.104		0.10		
		Edge 3 at 0mm		1.351	1.35		
		Edge 4 at 0mm	0.513	0.608	1.12		
		Curved Surface of Edge 1 at 0mm	0.261		0.26		
		Curved Surface of Edge 3 at 0mm		1.311	1.31		
	WCDMA Band V	Bottom Face at 9mm	0.767	0.270	1.04		
		Edge 1 at 6mm	0.553		0.55		
		Edge 2 at 5mm	0.360		0.36		
		Bottom Face at 0mm	0.451	1.326	1.78	0.01	#13
		Edge 1 at 0mm	0.197		0.20		
		Edge 2 at 0mm	0.125		0.13		
		Edge 3 at 0mm	0.058	1.351	1.41		
Edge 4 at 0mm		0.189	0.608	0.80			
Curved Surface of Edge 1 at 0mm		0.234		0.23			
Curved Surface of Edge 3 at 0mm			1.311	1.31			



WWAN Band		Exposure Position	1	3	1+3 Summed 1g SAR (W/kg)	SPLSR	Case No
			WWAN 1g SAR (W/kg)	5GHz WLAN 1g SAR (W/kg)			
LTE	LTE Band 2	Bottom Face at 9mm	1.003	0.270	1.27		
		Edge 1 at 6mm	0.903		0.90		
		Edge 2 at 5mm	0.358		0.36		
		Bottom Face at 0mm	0.552	1.326	1.88	0.01	#14
		Edge 1 at 0mm	0.299		0.30		
		Edge 2 at 0mm	0.069		0.07		
		Edge 3 at 0mm		1.351	1.35		
		Edge 4 at 0mm	0.229	0.608	0.84		
		Curved Surface of Edge 1 at 0mm	0.370		0.37		
		Curved Surface of Edge 3 at 0mm		1.311	1.31		
	LTE Band 4	Bottom Face at 9mm	1.189	0.270	1.46		
		Edge 1 at 6mm	0.706		0.71		
		Edge 2 at 5mm	0.473		0.47		
		Bottom Face at 0mm	0.545	1.326	1.87	0.01	#15
		Edge 1 at 0mm	0.152		0.15		
		Edge 2 at 0mm	0.082		0.08		
		Edge 3 at 0mm		1.351	1.35		
		Edge 4 at 0mm	0.363	0.608	0.97		
		Curved Surface of Edge 1 at 0mm	0.220		0.22		
		Curved Surface of Edge 3 at 0mm		1.311	1.31		
	LTE Band 5	Bottom Face at 9mm	0.796	0.270	1.07		
		Edge 1 at 6mm	0.548		0.55		
		Edge 2 at 5mm	0.340		0.34		
		Bottom Face at 0mm	0.225	1.326	1.55		
		Edge 1 at 0mm	0.102		0.10		
		Edge 2 at 0mm	0.072		0.07		
		Edge 3 at 0mm	0.049	1.351	1.40		
		Edge 4 at 0mm	0.237	0.608	0.85		
		Curved Surface of Edge 1 at 0mm	0.142		0.14		
		Curved Surface of Edge 3 at 0mm		1.311	1.31		



WWAN Band		Exposure Position	1	3	1+3 Summed 1g SAR (W/kg)	SPLSR	Case No
			WWAN	5GHz WLAN			
			1g SAR (W/kg)	1g SAR (W/kg)			
LTE	LTE Band 7	Bottom Face at 9mm	1.047	0.270	1.32		
		Edge 1 at 6mm	1.359		1.36		
		Edge 2 at 5mm	0.213		0.21		
		Bottom Face at 0mm	0.501	1.326	1.83	0.01	#16
		Edge 1 at 0mm	0.639		0.64		
		Edge 2 at 0mm	0.037		0.04		
		Edge 3 at 0mm		1.351	1.35		
		Edge 4 at 0mm	0.044	0.608	0.65		
		Curved Surface of Edge 1 at 0mm	0.650		0.65		
		Curved Surface of Edge 3 at 0mm		1.311	1.31		
	LTE Band 12	Bottom Face at 9mm	0.606	0.270	0.88		
		Edge 1 at 6mm	0.289		0.29		
		Edge 2 at 5mm	0.290		0.29		
		Bottom Face at 0mm	0.335	1.326	1.66	0.01	#17
		Edge 1 at 0mm	0.210		0.21		
		Edge 2 at 0mm	0.081		0.08		
		Edge 3 at 0mm	0.107	1.351	1.46		
		Edge 4 at 0mm	0.255	0.608	0.86		
		Curved Surface of Edge 1 at 0mm	0.174		0.17		
		Curved Surface of Edge 3 at 0mm		1.311	1.31		

<WWAN PCB + Bluetooth DSS>

WWAN Band		Exposure Position	1	4	1+4 Summed 1g SAR (W/kg)	SPLSR	Case No
			WWAN	Bluetooth			
			1g SAR (W/kg)	1g SAR (W/kg)			
GSM	GSM850	Bottom Face at 9mm	1.103	0.056	1.16		
		Edge 1 at 6mm	0.909		0.91		
		Edge 2 at 5mm	0.516		0.52		
		Bottom Face at 0mm	0.640	0.414	1.05		
		Edge 1 at 0mm	0.284		0.28		
		Edge 2 at 0mm	0.181		0.18		
		Edge 3 at 0mm	0.088	0.224	0.31		
		Edge 4 at 0mm	0.266		0.27		
		Curved Surface of Edge 1 at 0mm	0.398		0.40		
	Curved Surface of Edge 3 at 0mm		0.306	0.31			
	GSM1900	Bottom Face at 9mm	0.648	0.056	0.70		
		Edge 1 at 6mm	0.565		0.57		
		Edge 2 at 5mm	0.231		0.23		
		Bottom Face at 0mm	0.407	0.414	0.82		
		Edge 1 at 0mm	0.220		0.22		
		Edge 2 at 0mm	0.047		0.05		
		Edge 3 at 0mm		0.224	0.22		
		Edge 4 at 0mm	0.263		0.26		
		Curved Surface of Edge 1 at 0mm	0.229		0.23		
Curved Surface of Edge 3 at 0mm			0.306	0.31			



WWAN Band	Exposure Position	1	4	1+4 Summed 1g SAR (W/kg)	SPLSR	Case No	
		WWAN	Bluetooth				
		1g SAR (W/kg)	1g SAR (W/kg)				
WCDMA	WCDMA Band II	Bottom Face at 9mm	0.947	0.056	1.00		
		Edge 1 at 6mm	0.755		0.76		
		Edge 2 at 5mm	0.290		0.29		
		Bottom Face at 0mm	0.663	0.414	1.08		
		Edge 1 at 0mm	0.351		0.35		
		Edge 2 at 0mm	0.069		0.07		
		Edge 3 at 0mm		0.224	0.22		
		Edge 4 at 0mm	0.338		0.34		
		Curved Surface of Edge 1 at 0mm	0.387		0.39		
		Curved Surface of Edge 3 at 0mm		0.306	0.31		
	WCDMA Band IV	Bottom Face at 9mm	1.096	0.056	1.15		
		Edge 1 at 6mm	0.735		0.74		
		Edge 2 at 5mm	0.493		0.49		
		Bottom Face at 0mm	0.713	0.414	1.13		
		Edge 1 at 0mm	0.208		0.21		
		Edge 2 at 0mm	0.104		0.10		
		Edge 3 at 0mm		0.224	0.22		
		Edge 4 at 0mm	0.513		0.51		
		Curved Surface of Edge 1 at 0mm	0.261		0.26		
		Curved Surface of Edge 3 at 0mm		0.306	0.31		
	WCDMA Band V	Bottom Face at 9mm	0.767	0.056	0.82		
		Edge 1 at 6mm	0.553		0.55		
		Edge 2 at 5mm	0.360		0.36		
		Bottom Face at 0mm	0.451	0.414	0.87		
		Edge 1 at 0mm	0.197		0.20		
		Edge 2 at 0mm	0.125		0.13		
		Edge 3 at 0mm	0.058	0.224	0.28		
		Edge 4 at 0mm	0.189		0.19		
		Curved Surface of Edge 1 at 0mm	0.234		0.23		
		Curved Surface of Edge 3 at 0mm		0.306	0.31		



WWAN Band		Exposure Position	1	4	1+4 Summed 1g SAR (W/kg)	SPLSR	Case No
			WWAN 1g SAR (W/kg)	Bluetooth 1g SAR (W/kg)			
LTE	LTE Band 2	Bottom Face at 9mm	1.003	0.056	1.06		
		Edge 1 at 6mm	0.903		0.90		
		Edge 2 at 5mm	0.358		0.36		
		Bottom Face at 0mm	0.552	0.414	0.97		
		Edge 1 at 0mm	0.299		0.30		
		Edge 2 at 0mm	0.069		0.07		
		Edge 3 at 0mm		0.224	0.22		
		Edge 4 at 0mm	0.229		0.23		
		Curved Surface of Edge 1 at 0mm	0.370		0.37		
		Curved Surface of Edge 3 at 0mm		0.306	0.31		
	LTE Band 4	Bottom Face at 9mm	1.189	0.056	1.25		
		Edge 1 at 6mm	0.706		0.71		
		Edge 2 at 5mm	0.473		0.47		
		Bottom Face at 0mm	0.545	0.414	0.96		
		Edge 1 at 0mm	0.152		0.15		
		Edge 2 at 0mm	0.082		0.08		
		Edge 3 at 0mm		0.224	0.22		
		Edge 4 at 0mm	0.363		0.36		
		Curved Surface of Edge 1 at 0mm	0.220		0.22		
		Curved Surface of Edge 3 at 0mm		0.306	0.31		
	LTE Band 5	Bottom Face at 9mm	0.796	0.056	0.85		
		Edge 1 at 6mm	0.548		0.55		
		Edge 2 at 5mm	0.340		0.34		
		Bottom Face at 0mm	0.225	0.414	0.64		
		Edge 1 at 0mm	0.102		0.10		
		Edge 2 at 0mm	0.072		0.07		
		Edge 3 at 0mm	0.049	0.224	0.27		
Edge 4 at 0mm		0.237		0.24			
Curved Surface of Edge 1 at 0mm		0.142		0.14			
Curved Surface of Edge 3 at 0mm			0.306	0.31			



WWAN Band	Exposure Position	1	4	1+4 Summed 1g SAR (W/kg)	SPLSR	Case No	
		WWAN	Bluetooth				
		1g SAR (W/kg)	1g SAR (W/kg)				
LTE	LTE Band 7	Bottom Face at 9mm	1.047	0.056	1.10		
		Edge 1 at 6mm	1.359		1.36		
		Edge 2 at 5mm	0.213		0.21		
		Bottom Face at 0mm	0.501	0.414	0.92		
		Edge 1 at 0mm	0.639		0.64		
		Edge 2 at 0mm	0.037		0.04		
		Edge 3 at 0mm		0.224	0.22		
		Edge 4 at 0mm	0.044		0.04		
		Curved Surface of Edge 1 at 0mm	0.650		0.65		
	Curved Surface of Edge 3 at 0mm		0.306	0.31			
	LTE Band 12	Bottom Face at 9mm	0.606	0.056	0.66		
		Edge 1 at 6mm	0.289		0.29		
		Edge 2 at 5mm	0.290		0.29		
		Bottom Face at 0mm	0.335	0.414	0.75		
		Edge 1 at 0mm	0.210		0.21		
		Edge 2 at 0mm	0.081		0.08		
		Edge 3 at 0mm	0.107	0.224	0.33		
		Edge 4 at 0mm	0.255		0.26		
		Curved Surface of Edge 1 at 0mm	0.174		0.17		
Curved Surface of Edge 3 at 0mm			0.306	0.31			

16.2 SPLSR Evaluation and Analysis

General Note:

$SPLSR = (SAR_1 + SAR_2)^{1.5} / (\text{min. separation distance, mm})$. If $SPLSR \leq 0.04$, simultaneously transmission SAR measurement is not necessary

Case No #1	Band	SAR (W/kg)	Gap (cm)	SAR peak location (m)			3D distance (mm)	Pair SAR sum (W/kg)	SPLSR	Simultaneous SAR
				X	Y	Z				
Bottom Face	GSM850	0.640	0	-0.028	0.085	-0.183	185.3	1.89	0.01	Not required
	WLAN2.4GHz	1.251	0	0.0334	-0.0898	-0.182				

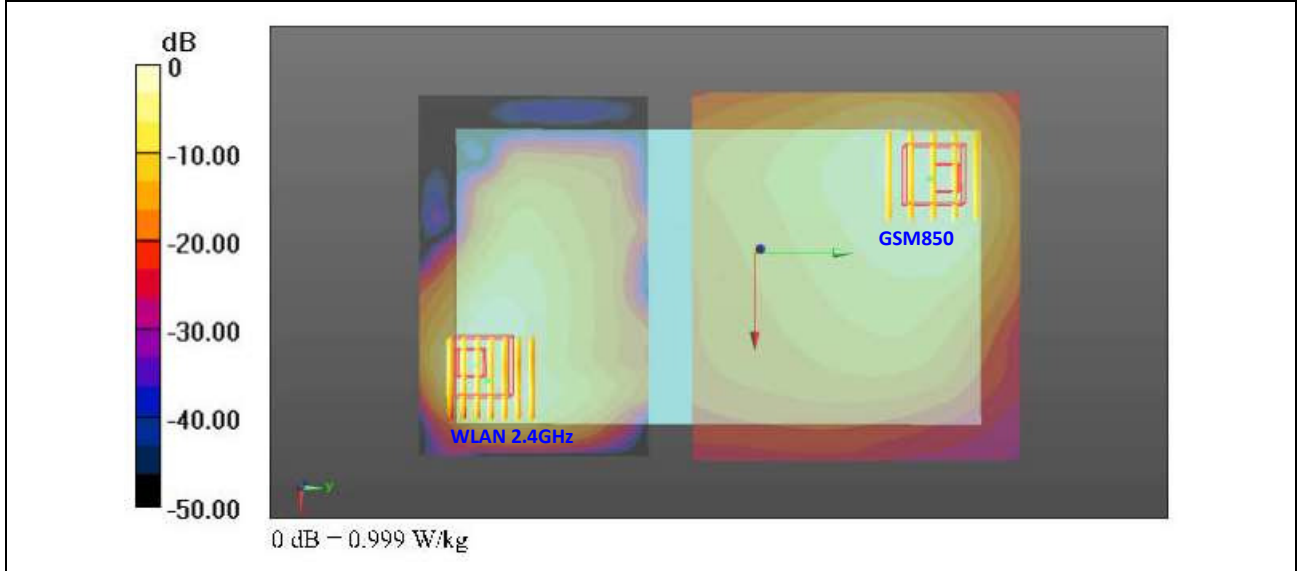

Case No #2	Band	SAR (W/kg)	Gap (cm)	SAR peak location (m)			3D distance (mm)	Pair SAR sum (W/kg)	SPLSR	Simultaneous SAR
				X	Y	Z				
Bottom Face	GSM1900	0.407	0	-0.039	0.085	-0.181	189.2	1.66	0.01	Not required
	WLAN2.4GHz	1.251	0	0.0334	-0.0898	-0.182				

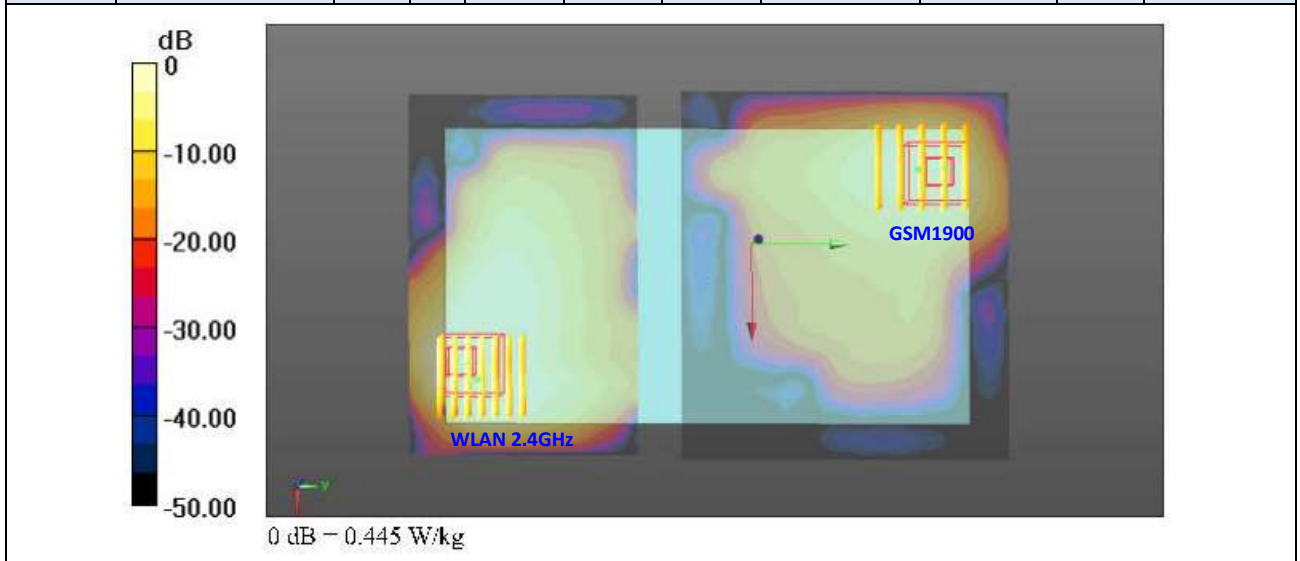

Case No #3 Position	Band	SAR (W/kg)	Gap (cm)	SAR peak location (m)			3D distance (mm)	Pair SAR sum (W/kg)	SPLSR	Simultaneous SAR
				X	Y	Z				
Bottom Face	WCDMA Band II	0.663	0	-0.036	0.086	-0.182	189.0	1.91	0.01	Not required
	WLAN2.4GHz	1.251	0	0.0334	-0.0898	-0.182				

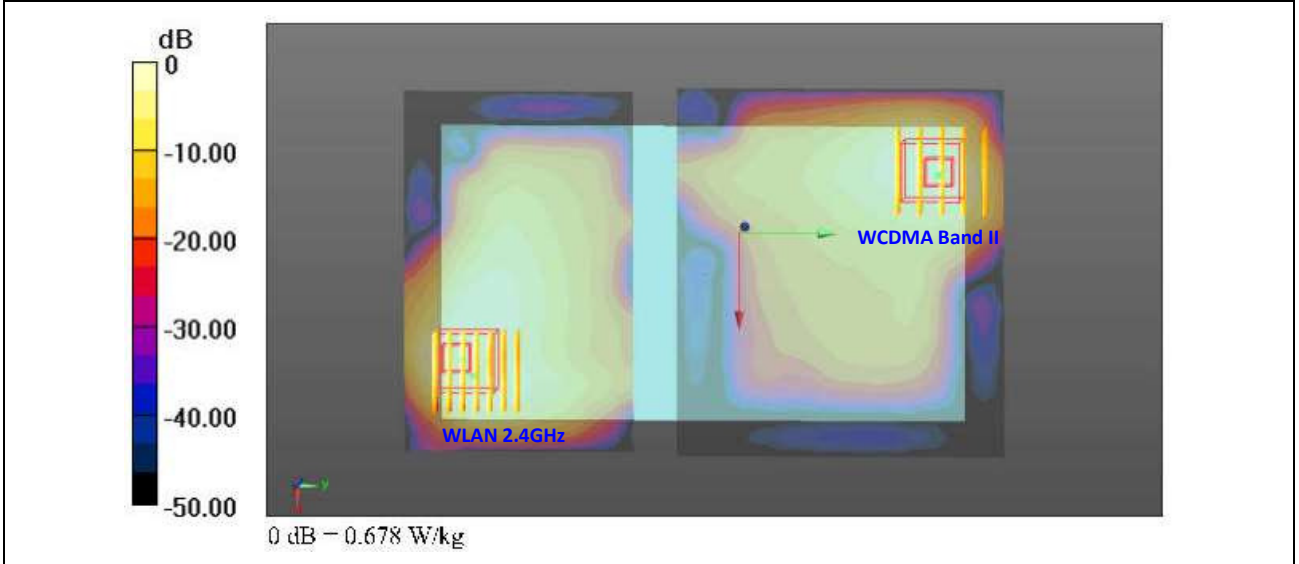

Case No #4 Position	Band	SAR (W/kg)	Gap (cm)	SAR peak location (m)			3D distance (mm)	Pair SAR sum (W/kg)	SPLSR	Simultaneous SAR
				X	Y	Z				
Bottom Face	WCDMA Band IV	0.713	0	-0.036	0.085	-0.182	188.1	1.96	0.01	Not required
	WLAN2.4GHz	1.251	0	0.0334	-0.0898	-0.182				

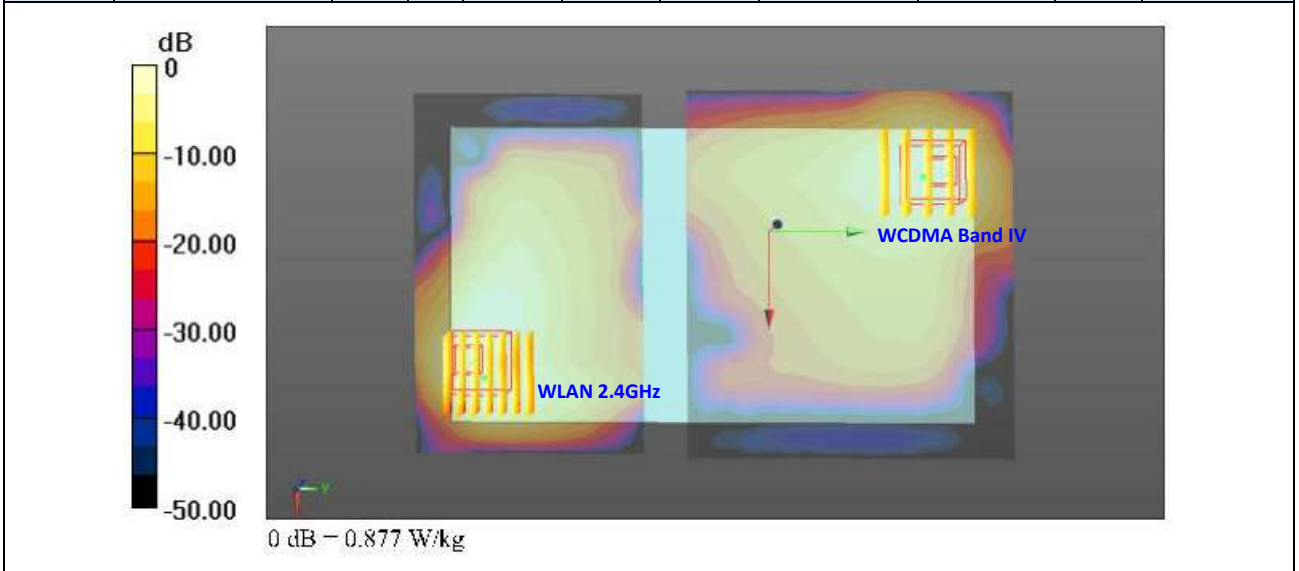

Case No #5 Position	Band	SAR (W/kg)	Gap (cm)	SAR peak location (m)			3D distance (mm)	Pair SAR sum (W/kg)	SPLSR	Simultaneous SAR
				X	Y	Z				
Bottom Face	WCDMA Band V	0.451	0	-0.028	0.085	-0.183	185.3	1.70	0.01	Not required
	WLAN2.4GHz	1.251	0	0.0334	-0.0898	-0.182				

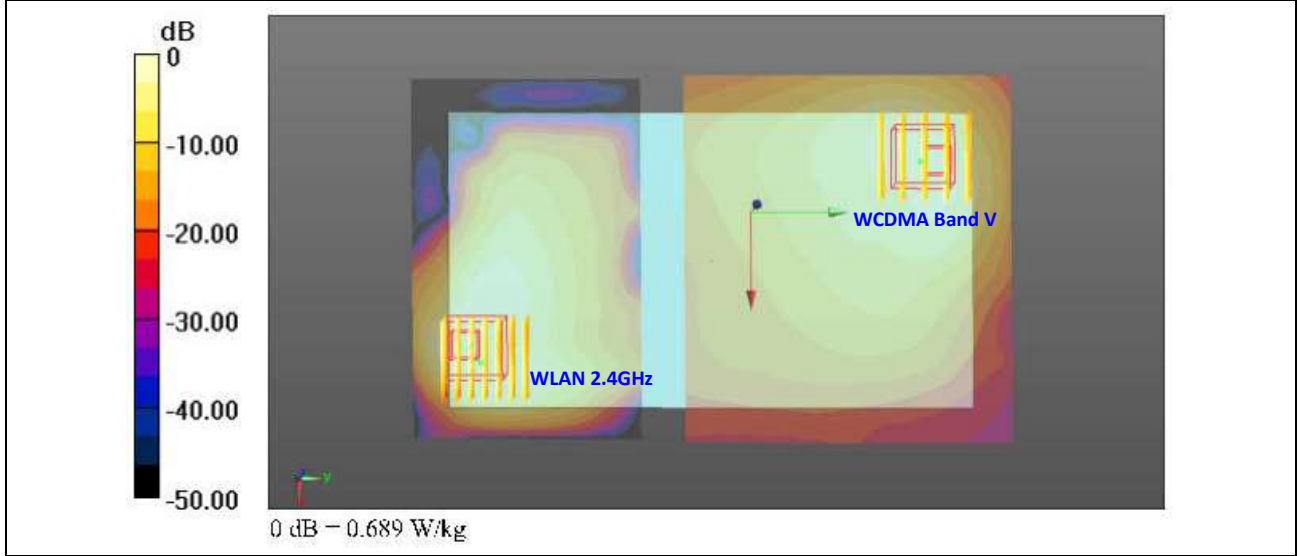

Case No #6 Position	Band	SAR (W/kg)	Gap (cm)	SAR peak location (m)			3D distance (mm)	Pair SAR sum (W/kg)	SPLSR	Simultaneous SAR
				X	Y	Z				
Bottom Face	LTE Band 2	0.552	0	-0.0345	0.0905	-0.181	192.7	1.80	0.01	Not required
	WLAN2.4GHz	1.251	0	0.0334	-0.0898	-0.182				

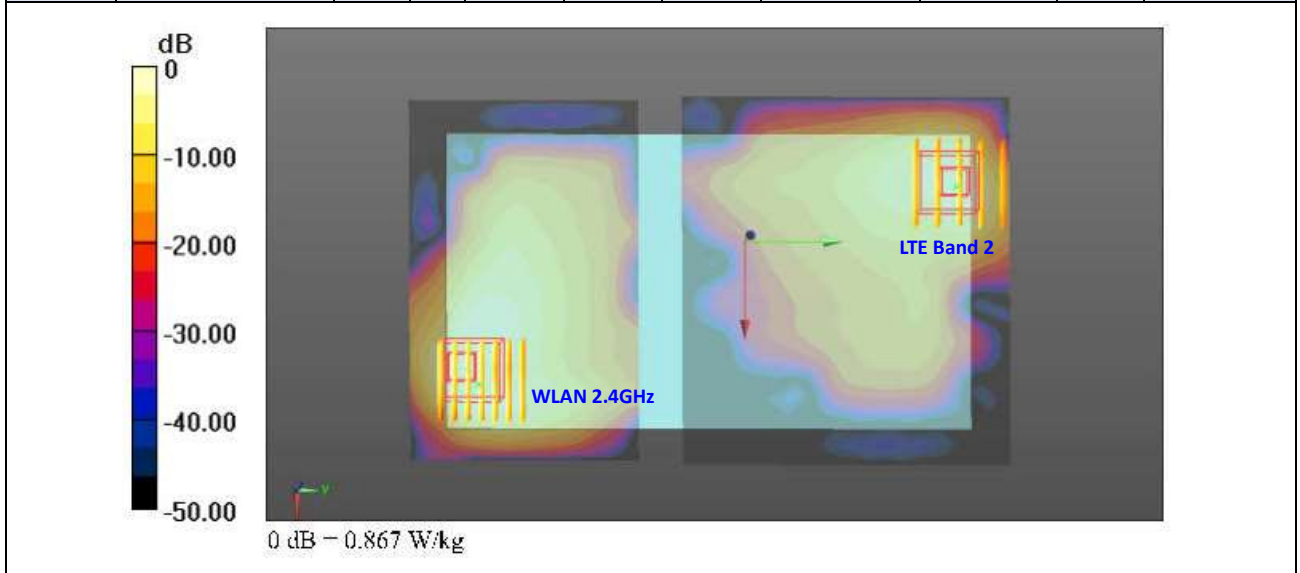

Case No #7	Band	SAR (W/kg)	Gap (cm)	SAR peak location (m)			3D distance (mm)	Pair SAR sum (W/kg)	SPLSR	Simultaneous SAR
				X	Y	Z				
Bottom Face	LTE Band 4	0.545	0	-0.036	0.089	-0.181	191.8	1.80	0.01	Not required
	WLAN2.4GHz	1.251	0	0.0334	-0.0898	-0.182				

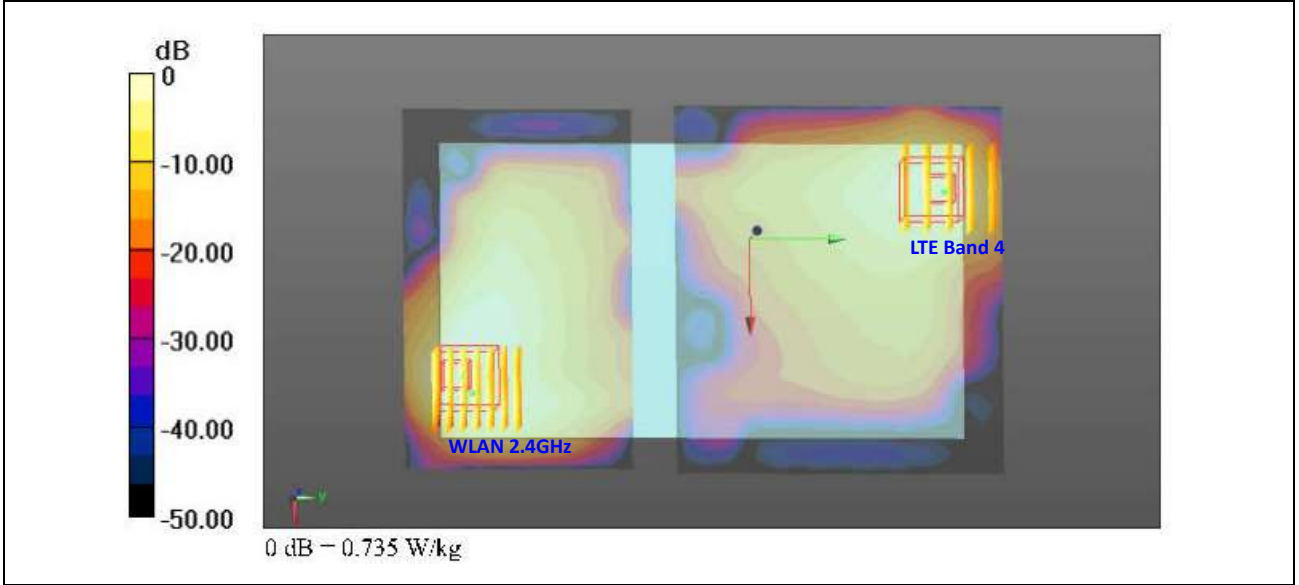

Case No #8	Band	SAR (W/kg)	Gap (cm)	SAR peak location (m)			3D distance (mm)	Pair SAR sum (W/kg)	SPLSR	Simultaneous SAR
				X	Y	Z				
Bottom Face	LTE Band 7	0.501	0	-0.03	0.0882	-0.183	189.0	1.75	0.01	Not required
	WLAN2.4GHz	1.251	0	0.0334	-0.0898	-0.182				

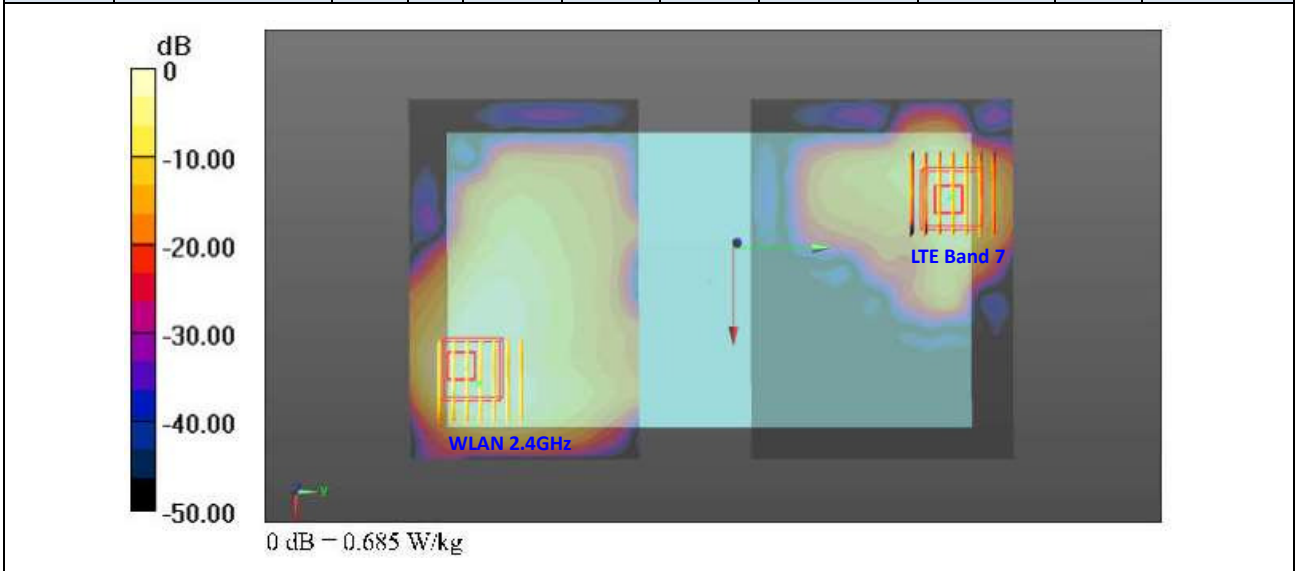

Case No #9	Band	SAR (W/kg)	Gap (cm)	SAR peak location (m)			3D distance (mm)	Pair SAR sum (W/kg)	SPLSR	Simultaneous SAR
				X	Y	Z				
Bottom Face	GSM850	0.640	0	-0.028	0.085	-0.183	183.8	1.97	0.01	Not required
	WLAN5GHz	1.326	0	0.034	-0.088	-0.181				

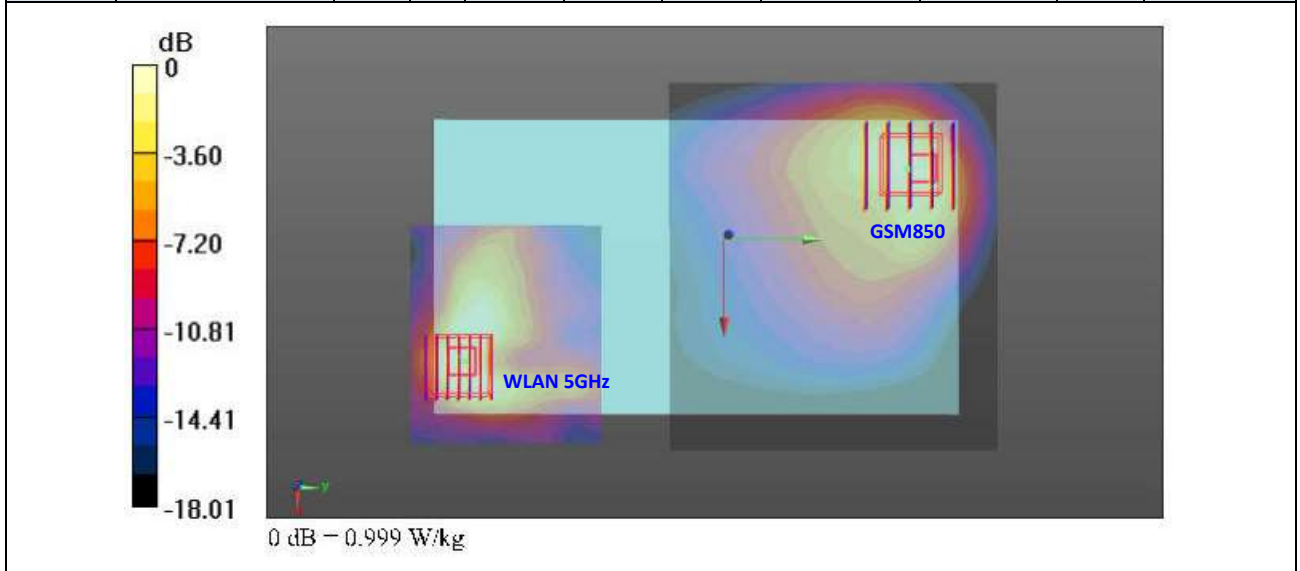

Case No #10	Band	SAR (W/kg)	Gap (cm)	SAR peak location (m)			3D distance (mm)	Pair SAR sum (W/kg)	SPLSR	Simultaneous SAR
				X	Y	Z				
Bottom Face	GSM1900	0.407	0	-0.039	0.085	-0.181	187.8	1.73	0.01	Not required
	WLAN5GHz	1.326	0	0.034	-0.088	-0.181				

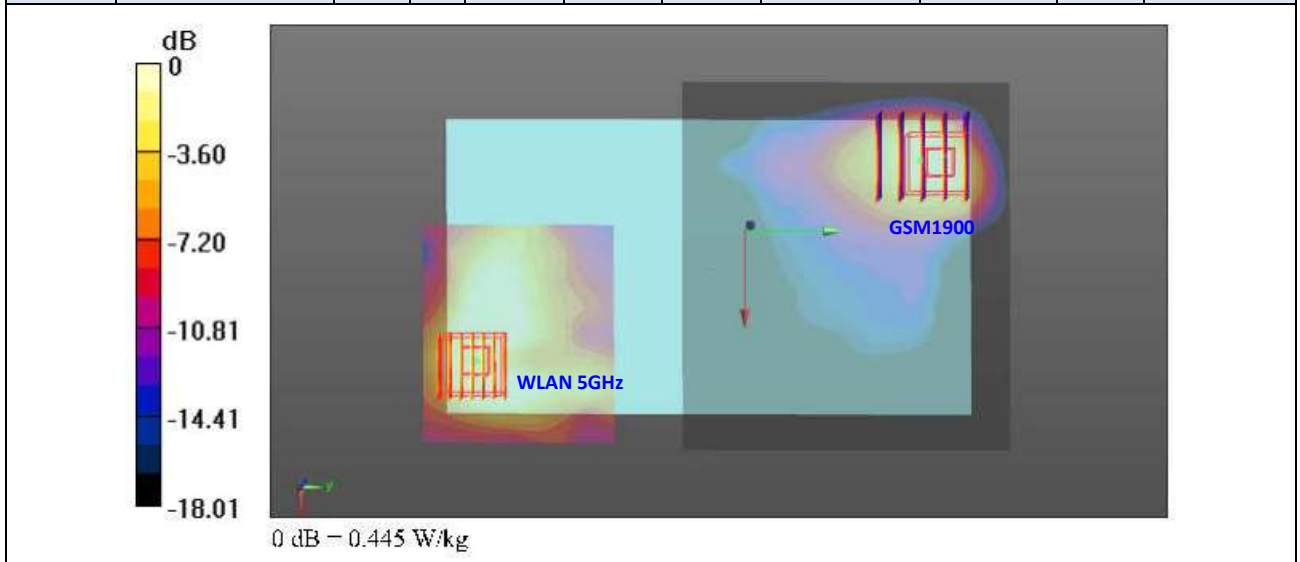

Case No #11	Band	SAR (W/kg)	Gap (cm)	SAR peak location (m)			3D distance (mm)	Pair SAR sum (W/kg)	SPLSR	Simultaneous SAR
				X	Y	Z				
Bottom Face	WCDMA Band II	0.663	0	-0.036	0.086	-0.182	187.6	1.99	0.01	Not required
	WLAN5GHz	1.326	0	0.034	-0.088	-0.181				

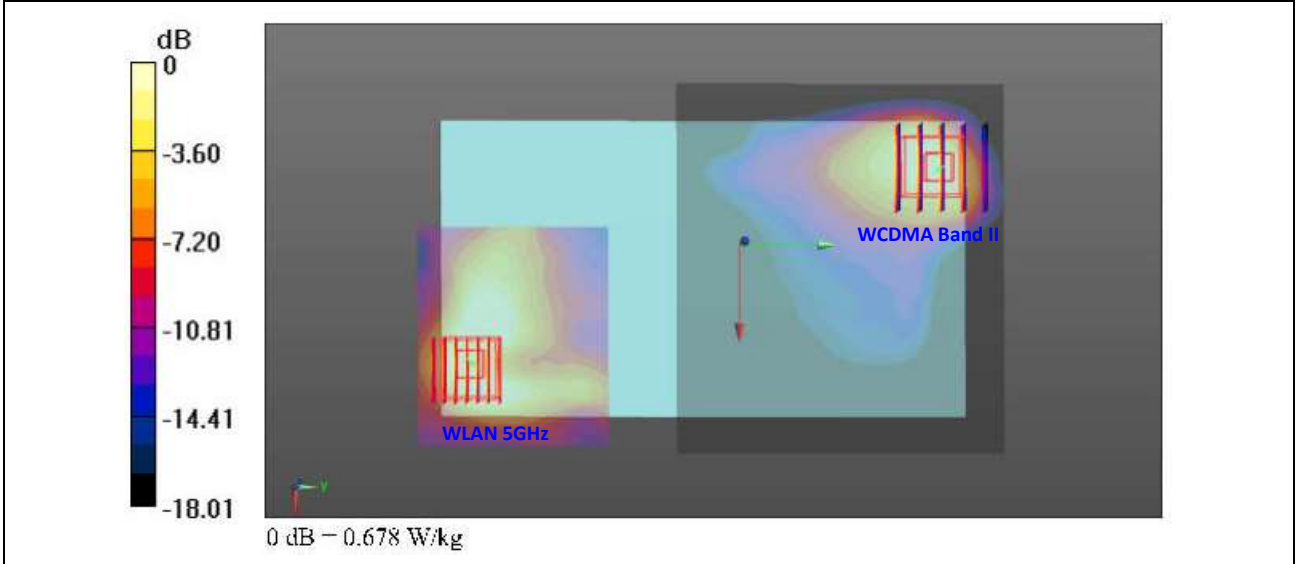

Case No #12	Band	SAR (W/kg)	Gap (cm)	SAR peak location (m)			3D distance (mm)	Pair SAR sum (W/kg)	SPLSR	Simultaneous SAR
				X	Y	Z				
Bottom Face	WCDMA Band IV	0.713	0	-0.036	0.085	-0.182	186.6	2.04	0.02	Not required
	WLAN5GHz	1.326	0	0.034	-0.088	-0.181				

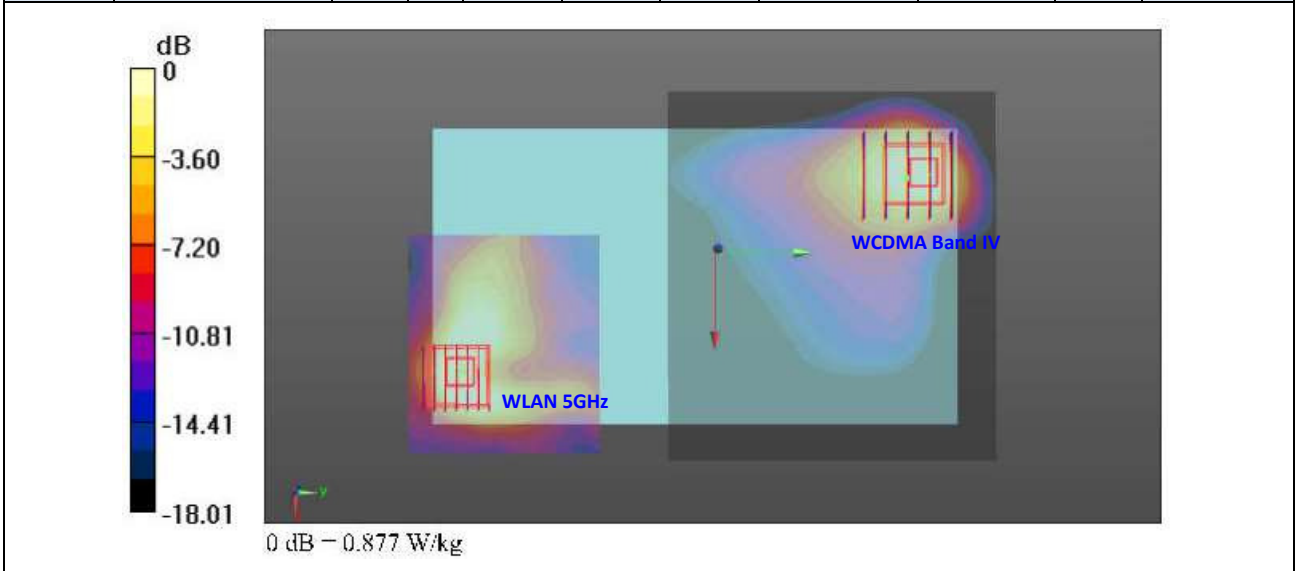

Case No #13 Position	Band	SAR (W/kg)	Gap (cm)	SAR peak location (m)			3D distance (mm)	Pair SAR sum (W/kg)	SPLSR	Simultaneous SAR
				X	Y	Z				
Bottom Face	WCDMA Band V	0.451	0	-0.028	0.085	-0.183	183.8	1.78	0.01	Not required
	WLAN5GHz	1.326	0	0.034	-0.088	-0.181				

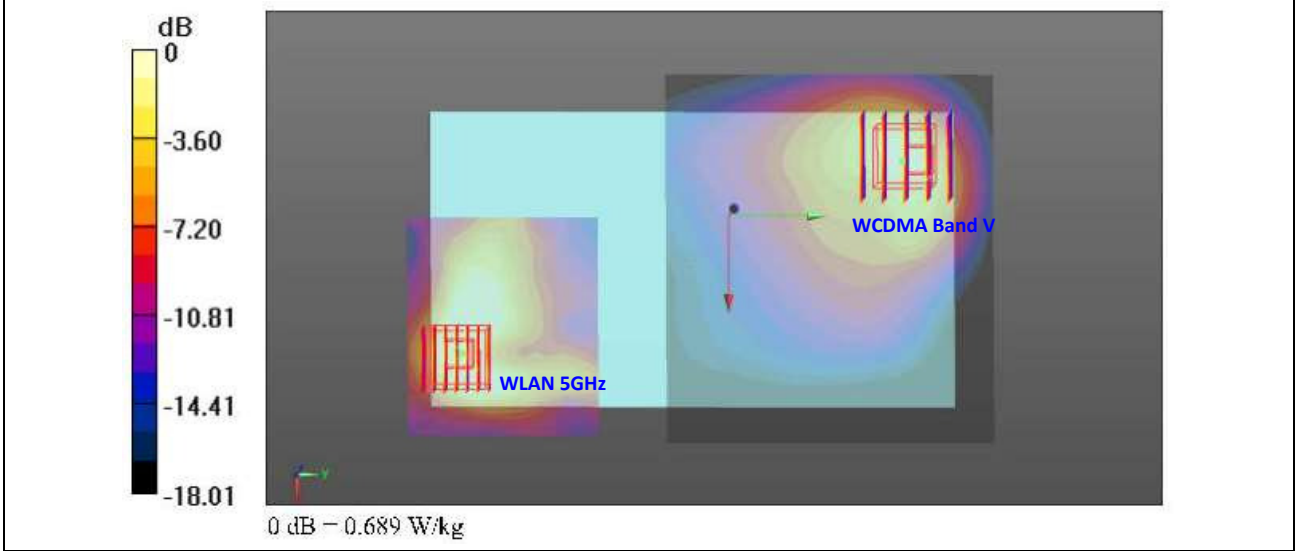

Case No #14 Position	Band	SAR (W/kg)	Gap (cm)	SAR peak location (m)			3D distance (mm)	Pair SAR sum (W/kg)	SPLSR	Simultaneous SAR
				X	Y	Z				
Bottom Face	LTE Band 2	0.552	0	-0.0345	0.0905	-0.181	191.2	1.88	0.01	Not required
	WLAN5GHz	1.326	0	0.034	-0.088	-0.181				

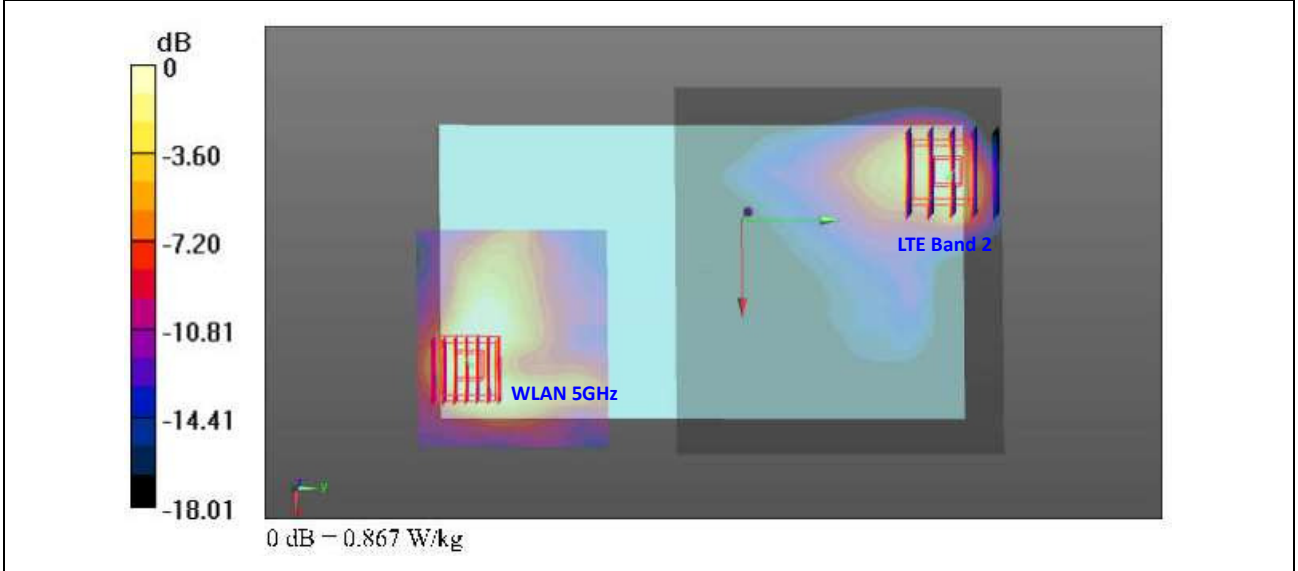

Case No #15	Band	SAR (W/kg)	Gap (cm)	SAR peak location (m)			3D distance (mm)	Pair SAR sum (W/kg)	SPLSR	Simultaneous SAR
				X	Y	Z				
Bottom Face	LTE Band 4	0.545	0	-0.036	0.089	-0.181	190.3	1.87	0.01	Not required
	WLAN5GHz	1.326	0	0.034	-0.088	-0.181				

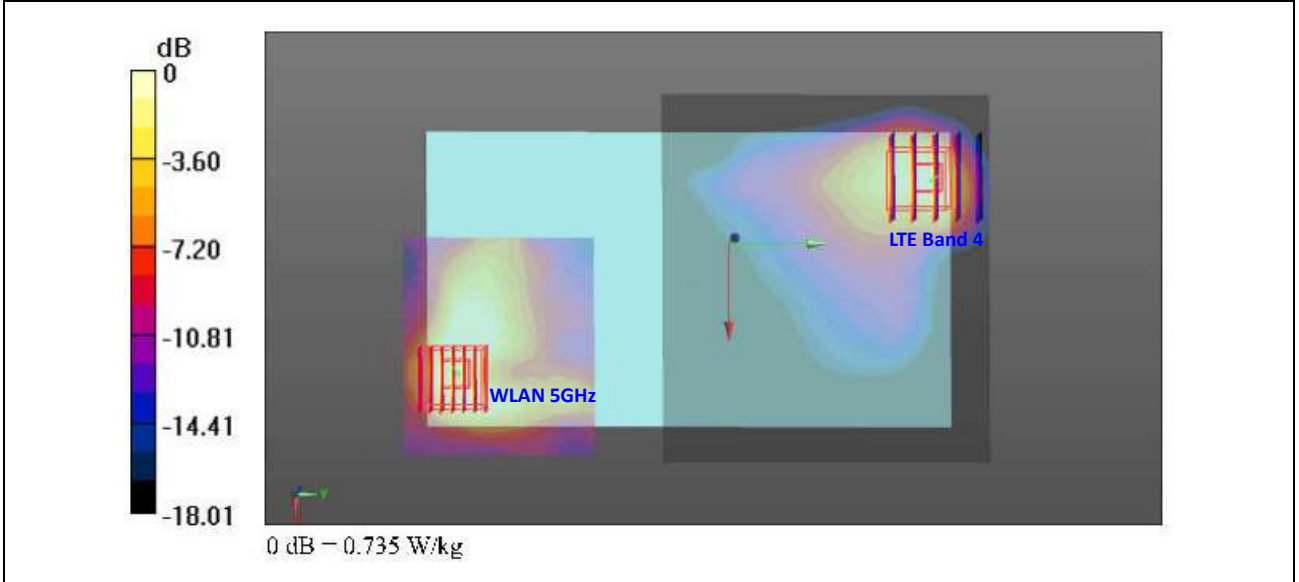

Case No #16	Band	SAR (W/kg)	Gap (cm)	SAR peak location (m)			3D distance (mm)	Pair SAR sum (W/kg)	SPLSR	Simultaneous SAR
				X	Y	Z				
Bottom Face	LTE Band 7	0.501	0	-0.03	0.0882	-0.183	187.5	1.83	0.01	Not required
	WLAN5GHz	1.326	0	0.034	-0.088	-0.181				



Case No #17 Position	Band	SAR (W/kg)	Gap (cm)	SAR peak location (m)			3D distance (mm)	Pair SAR sum (W/kg)	SPLSR	Simultaneous SAR
				X	Y	Z				
Bottom Face	LTE Band 12	0.335	0	-0.044	0.074	-0.183	179.8	1.66	0.01	Not required
	WLAN5GHz	1.326	0	0.034	-0.088	-0.181				

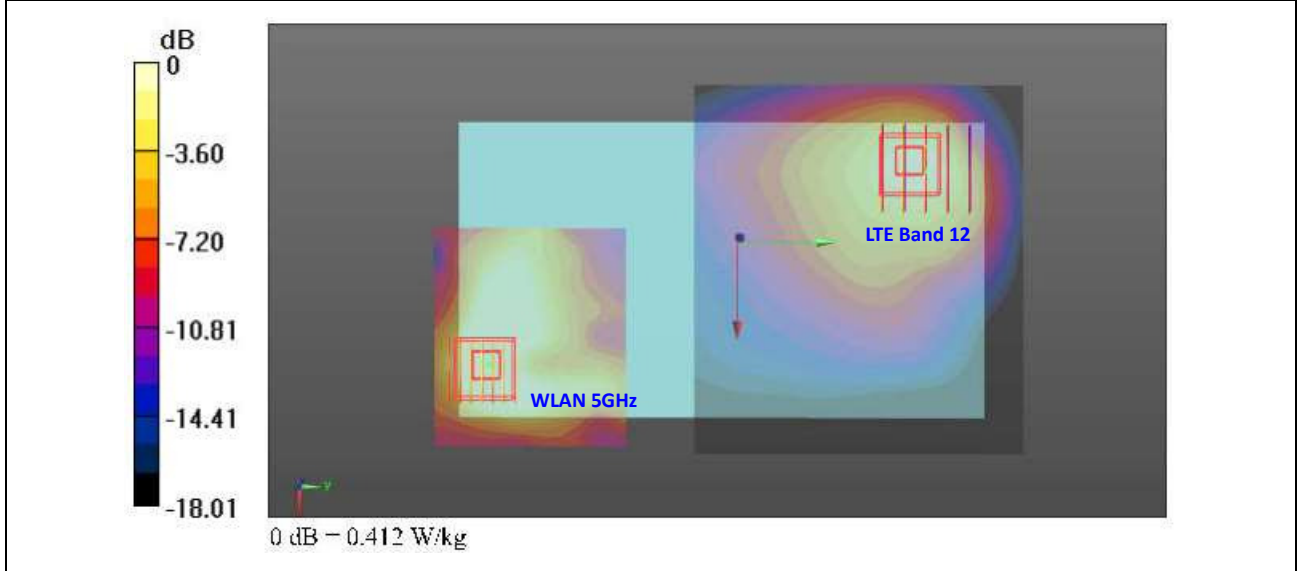

Test Engineer : Luke Lu

17. Uncertainty Assessment

The component of uncertainty may generally be categorized according to the methods used to evaluate them. The evaluation of uncertainty by the statistical analysis of a series of observations is termed a Type A evaluation of uncertainty. The evaluation of uncertainty by means other than the statistical analysis of a series of observation is termed a Type B evaluation of uncertainty. Each component of uncertainty, however evaluated, is represented by an estimated standard deviation, termed standard uncertainty, which is determined by the positive square root of the estimated variance.

A Type A evaluation of standard uncertainty may be based on any valid statistical method for treating data. This includes calculating the standard deviation of the mean of a series of independent observations; using the method of least squares to fit a curve to the data in order to estimate the parameter of the curve and their standard deviations; or carrying out an analysis of variance in order to identify and quantify random effects in certain kinds of measurement.

A type B evaluation of standard uncertainty is typically based on scientific judgment using all of the relevant information available. These may include previous measurement data, experience, and knowledge of the behavior and properties of relevant materials and instruments, manufacture’s specification, data provided in calibration reports and uncertainties assigned to reference data taken from handbooks. Broadly speaking, the uncertainty is either obtained from an outdoor source or obtained from an assumed distribution, such as the normal distribution, rectangular or triangular distributions indicated in table below.

Uncertainty Distributions	Normal	Rectangular	Triangular	U-Shape
Multi-plying Factor ^(a)	1/k ^(b)	1/√3	1/√6	1/√2

(a) standard uncertainty is determined as the product of the multiplying factor and the estimated range of variations in the measured quantity

(b) κ is the coverage factor

Table 17.1. Standard Uncertainty for Assumed Distribution

The combined standard uncertainty of the measurement result represents the estimated standard deviation of the result. It is obtained by combining the individual standard uncertainties of both Type A and Type B evaluation using the usual “root-sum-squares” (RSS) methods of combining standard deviations by taking the positive square root of the estimated variances.

Expanded uncertainty is a measure of uncertainty that defines an interval about the measurement result within which the measured value is confidently believed to lie. It is obtained by multiplying the combined standard uncertainty by a coverage factor. Typically, the coverage factor ranges from 2 to 3. Using a coverage factor allows the true value of a measured quantity to be specified with a defined probability within the specified uncertainty range. For purpose of this document, a coverage factor two is used, which corresponds to confidence interval of about 95 %. The DASY uncertainty Budget is shown in the following tables.



Error Description	Uncertainty Value (±%)	Probability	Divisor	(Ci) 1g	(Ci) 10g	Standard Uncertainty (1g) (±%)	Standard Uncertainty (10g) (±%)
Measurement System							
Probe Calibration	6.0	N	1	1	1	6.0	6.0
Axial Isotropy	4.7	R	1.732	0.7	0.7	1.9	1.9
Hemispherical Isotropy	9.6	R	1.732	0.7	0.7	3.9	3.9
Boundary Effects	1.0	R	1.732	1	1	0.6	0.6
Linearity	4.7	R	1.732	1	1	2.7	2.7
System Detection Limits	1.0	R	1.732	1	1	0.6	0.6
Modulation Response	3.2	R	1.732	1	1	1.8	1.8
Readout Electronics	0.3	N	1	1	1	0.3	0.3
Response Time	0.0	R	1.732	1	1	0.0	0.0
Integration Time	2.6	R	1.732	1	1	1.5	1.5
RF Ambient Noise	3.0	R	1.732	1	1	1.7	1.7
RF Ambient Reflections	3.0	R	1.732	1	1	1.7	1.7
Probe Positioner	0.4	R	1.732	1	1	0.2	0.2
Probe Positioning	2.9	R	1.732	1	1	1.7	1.7
Max. SAR Eval.	2.0	R	1.732	1	1	1.2	1.2
Test Sample Related							
Device Positioning	3.0	N	1	1	1	3.0	3.0
Device Holder	3.6	N	1	1	1	3.6	3.6
Power Drift	5.0	R	1.732	1	1	2.9	2.9
Power Scaling	0.0	R	1.732	1	1	0.0	0.0
Phantom and Setup							
Phantom Uncertainty	6.1	R	1.732	1	1	3.5	3.5
SAR correction	0.0	R	1.732	1	0.84	0.0	0.0
Liquid Conductivity Repeatability	0.2	N	1	0.78	0.71	0.1	0.1
Liquid Conductivity (target)	5.0	R	1.732	0.78	0.71	2.3	2.0
Liquid Conductivity (mea.)	2.5	R	1.732	0.78	0.71	1.1	1.0
Temp. unc. - Conductivity	3.4	R	1.732	0.78	0.71	1.5	1.4
Liquid Permittivity Repeatability	0.15	N	1	0.23	0.26	0.0	0.0
Liquid Permittivity (target)	5.0	R	1.732	0.23	0.26	0.7	0.8
Liquid Permittivity (mea.)	2.5	R	1.732	0.23	0.26	0.3	0.4
Temp. unc. - Permittivity	0.83	R	1.732	0.23	0.26	0.1	0.1
Combined Std. Uncertainty						11.4%	11.4%
Coverage Factor for 95 %						K=2	K=2
Expanded STD Uncertainty						22.9%	22.7%

Table 17.2. Uncertainty Budget for frequency range 300 MHz to 3 GHz



Error Description	Uncertainty Value (±%)	Probability	Divisor	(Ci) 1g	(Ci) 10g	Standard Uncertainty (1g) (±%)	Standard Uncertainty (10g) (±%)
Measurement System							
Probe Calibration	7.0	N	1	1	1	7.0	7.0
Axial Isotropy	4.7	R	1.732	0.7	0.7	1.9	1.9
Hemispherical Isotropy	9.6	R	1.732	0.7	0.7	3.9	3.9
Boundary Effects	2.0	R	1.732	1	1	1.2	1.2
Linearity	4.7	R	1.732	1	1	2.7	2.7
System Detection Limits	1.0	R	1.732	1	1	0.6	0.6
Modulation Response	3.2	R	1.732	1	1	1.8	1.8
Readout Electronics	0.3	N	1	1	1	0.3	0.3
Response Time	0.0	R	1.732	1	1	0.0	0.0
Integration Time	2.6	R	1.732	1	1	1.5	1.5
RF Ambient Noise	3.0	R	1.732	1	1	1.7	1.7
RF Ambient Reflections	3.0	R	1.732	1	1	1.7	1.7
Probe Positioner	0.4	R	1.732	1	1	0.2	0.2
Probe Positioning	6.7	R	1.732	1	1	3.9	3.9
Max. SAR Eval.	4.0	R	1.732	1	1	2.3	2.3
Test Sample Related							
Device Positioning	3.0	N	1	1	1	3.0	3.0
Device Holder	3.6	N	1	1	1	3.6	3.6
Power Drift	5.0	R	1.732	1	1	2.9	2.9
Power Scaling	0.0	R	1.732	1	1	0.0	0.0
Phantom and Setup							
Phantom Uncertainty	6.6	R	1.732	1	1	3.8	3.8
SAR correction	0.0	R	1.732	1	0.84	0.0	0.0
Liquid Conductivity Repeatability	0.2	N	1	0.78	0.71	0.1	0.1
Liquid Conductivity (target)	5.0	R	1.732	0.78	0.71	2.3	2.0
Liquid Conductivity (mea.)	2.5	R	1.732	0.78	0.71	1.1	1.0
Temp. unc. - Conductivity	3.4	R	1.732	0.78	0.71	1.5	1.4
Liquid Permittivity Repeatability	0.15	N	1	0.23	0.26	0.0	0.0
Liquid Permittivity (target)	5.0	R	1.732	0.23	0.26	0.7	0.8
Liquid Permittivity (mea.)	2.5	R	1.732	0.23	0.26	0.3	0.4
Temp. unc. - Permittivity	0.83	R	1.732	0.23	0.26	0.1	0.1
Combined Std. Uncertainty						12.8%	12.7%
Coverage Factor for 95 %						K=2	K=2
Expanded STD Uncertainty						25.5%	25.4%

Table 17.3. Uncertainty Budget for frequency range 3 GHz to 6 GHz



18. References

- [1] FCC 47 CFR Part 2 “Frequency Allocations and Radio Treaty Matters; General Rules and Regulations”
- [2] ANSI/IEEE Std. C95.1-1992, “IEEE Standard for Safety Levels with Respect to Human Exposure to Radio Frequency Electromagnetic Fields, 3 kHz to 300 GHz”, September 1992
- [3] IEEE Std. 1528-2013, “IEEE Recommended Practice for Determining the Peak Spatial-Average Specific Absorption Rate (SAR) in the Human Head from Wireless Communications Devices: Measurement Techniques”, Sep 2013
- [4] SPEAG DASY System Handbook
- [5] FCC KDB 865664 D01 v01r04, "SAR Measurement Requirements for 100 MHz to 6 GHz", Aug 2015.
- [6] FCC KDB 865664 D02 v01r02, “RF Exposure Compliance Reporting and Documentation Considerations” Oct 2015.
- [7] FCC KDB 447498 D01 v06, “Mobile and Portable Device RF Exposure Procedures and Equipment Authorization Policies”, Oct 2015
- [8] FCC KDB 248227 D01 v02r02, “SAR Guidance for IEEE 802.11 (WiFi) Transmitters”, Oct 2015.
- [9] FCC KDB 616217 D04 v01r02, “SAR Evaluation Considerations for Laptop, Notebook, Netbook and Tablet Computers”, Oct 2015
- [10] FCC KDB 941225 D01 v03r01, “3G SAR MEAUREMENT PROCEDURES”, Oct 2015
- [11] FCC KDB 941225 D05 v02r05, “SAR Evaluation Considerations for LTE Devices”, Dec 2015



Appendix A. Plots of System Performance Check

The plots are shown as follows.

System Check_Body_750MHz_160721

DUT: D750V3 - SN: 1099

Communication System: UID 0, CW (0); Frequency: 750 MHz; Duty Cycle: 1:1

Medium: MSL_750_160721 Medium parameters used: $f = 750$ MHz; $\sigma = 0.97$ S/m; $\epsilon_r = 54.633$; $\rho = 1000$ kg/m³

Ambient Temperature : 23.4 °C; Liquid Temperature : 22.5 °C

DASY5 Configuration:

- Probe: EX3DV4 - SN3819; ConvF(9.69, 9.69, 9.69); Calibrated: 2015.11.27;
- Sensor-Surface: 2mm (Mechanical Surface Detection)
- Electronics: DAE4 Sn1338; Calibrated: 2015.11.23
- Phantom: ELI v5.0(Right); Type: QDOVA001BB; Serial: TP:1225
- Measurement SW: DASY52, Version 52.8 (8); SEMCAD X Version 14.6.10 (7331)

Pin=250mW/Area Scan (61x61x1): Interpolated grid: dx=15mm, dy=15mm

Maximum value of SAR (interpolated) = 2.67 W/kg

Pin=250mW/Zoom Scan (5x5x7)/Cube 0: Measurement grid: dx=8mm, dy=8mm, dz=5mm

Reference Value = 53.53 V/m; Power Drift = 0.01 dB

Peak SAR (extrapolated) = 3.10 W/kg

SAR(1 g) = 2.15 W/kg; SAR(10 g) = 1.45 W/kg

Maximum value of SAR (measured) = 2.68 W/kg

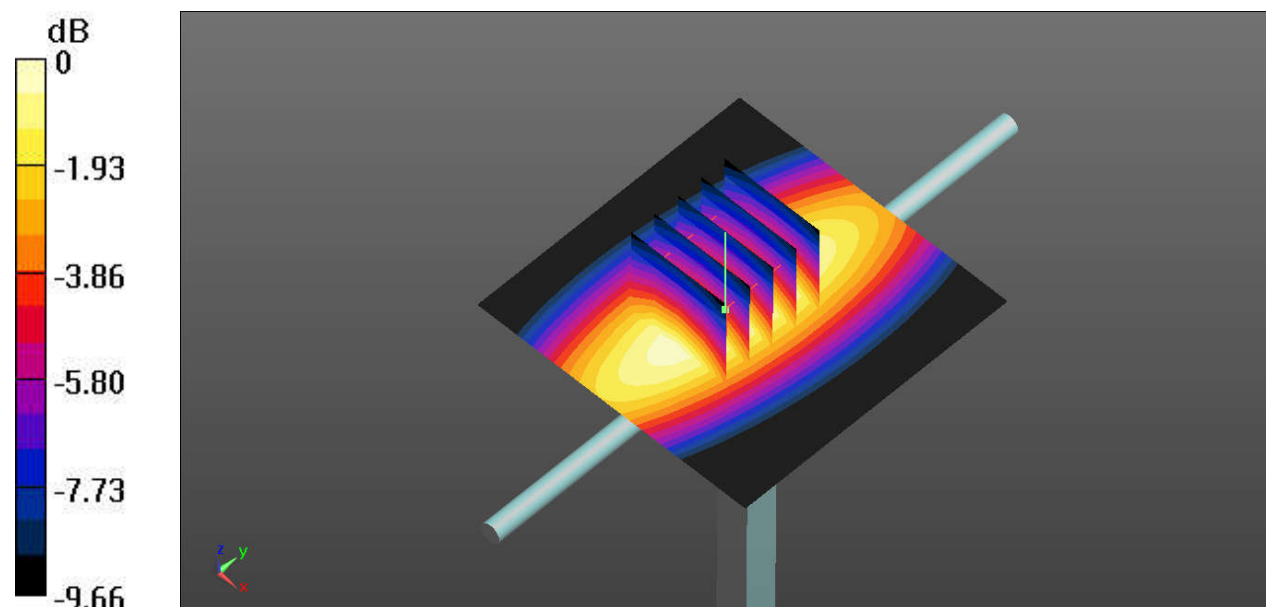

0 dB = 2.67 W/kg

System Check_Body_835MHz_160721

DUT: D835V2 - SN: 4d162

Communication System: UID 0, CW; Frequency: 835 MHz; Duty Cycle: 1:1
Medium: MSL_835_160721 Medium parameters used: $f = 835$ MHz; $\sigma = 0.967$ S/m; $\epsilon_r = 55.899$; $\rho = 1000$ kg/m³
Ambient Temperature : 23.4 °C; Liquid Temperature : 22.6 °C

DASY5 Configuration:

- Probe: EX3DV4 - SN3819; ConvF(9.47, 9.47, 9.47); Calibrated: 2015.11.27;
- Sensor-Surface: 2mm (Mechanical Surface Detection)
- Electronics: DAE4 Sn1338; Calibrated: 2015.11.23
- Phantom: ELI v5.0(Right); Type: QDOVA001BB; Serial: TP:1225
- Measurement SW: DASY52, Version 52.8 (8); SEMCAD X Version 14.6.10 (7331)

Pin=250mW/Area Scan (61x61x1): Interpolated grid: dx=15mm, dy=15mm
Maximum value of SAR (interpolated) = 2.96 W/kg

Pin=250mW/Zoom Scan (5x5x7)/Cube 0: Measurement grid: dx=8mm, dy=8mm, dz=5mm
Reference Value = 56.77 V/m; Power Drift = -0.03 dB
Peak SAR (extrapolated) = 3.41 W/kg
SAR(1 g) = 2.36 W/kg; SAR(10 g) = 1.56 W/kg
Maximum value of SAR (measured) = 2.95 W/kg

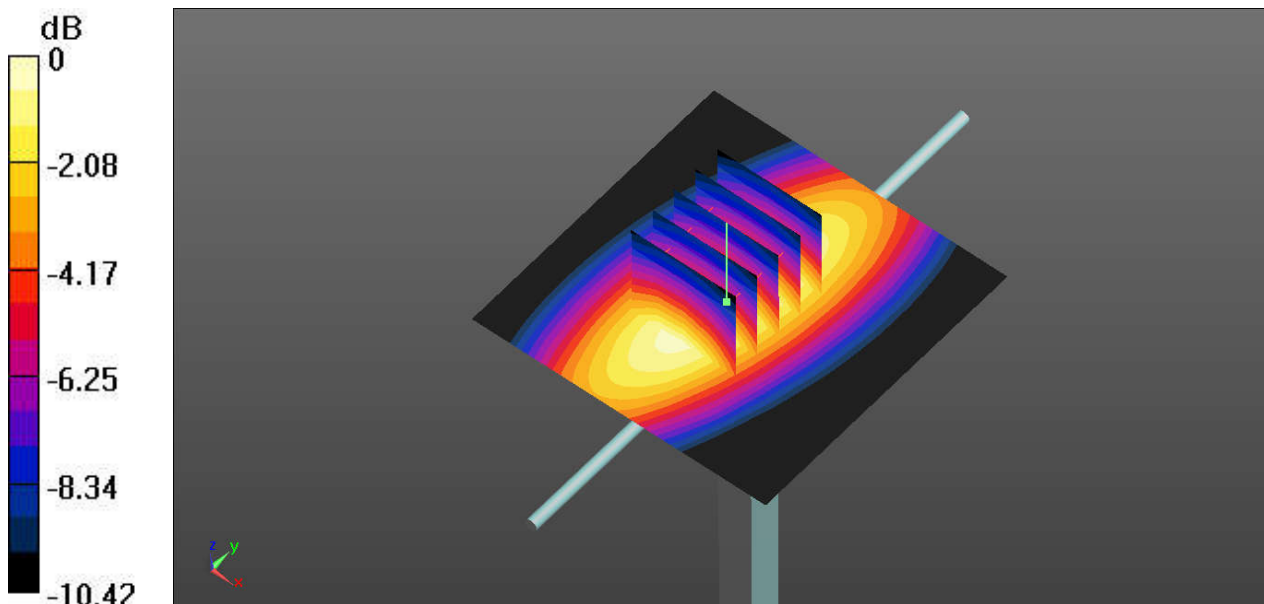

0 dB = 2.96 W/kg

System Check_Body_835MHz_160722

DUT: D835V2 - SN: 4d162

Communication System: UID 0, CW; Frequency: 835 MHz; Duty Cycle: 1:1
Medium: MSL_835_160722 Medium parameters used: $f = 835$ MHz; $\sigma = 0.976$ S/m; $\epsilon_r = 54.388$; $\rho = 1000$ kg/m³
Ambient Temperature : 23.3 °C; Liquid Temperature : 22.7 °C

DASY5 Configuration:

- Probe: EX3DV4 - SN3819; ConvF(9.47, 9.47, 9.47); Calibrated: 2015.11.27;
- Sensor-Surface: 2mm (Mechanical Surface Detection)
- Electronics: DAE4 Sn1338; Calibrated: 2015.11.23
- Phantom: ELI v5.0(Right); Type: QDOVA001BB; Serial: TP:1225
- Measurement SW: DASY52, Version 52.8 (8); SEMCAD X Version 14.6.10 (7331)

Pin=250mW/Area Scan (61x61x1): Interpolated grid: dx=15mm, dy=15mm
Maximum value of SAR (interpolated) = 2.78 W/kg

Pin=250mW/Zoom Scan (5x5x7)/Cube 0: Measurement grid: dx=8mm, dy=8mm, dz=5mm
Reference Value = 54.15 V/m; Power Drift = -0.10 dB
Peak SAR (extrapolated) = 3.25 W/kg
SAR(1 g) = 2.25 W/kg; SAR(10 g) = 1.47 W/kg
Maximum value of SAR (measured) = 2.79 W/kg

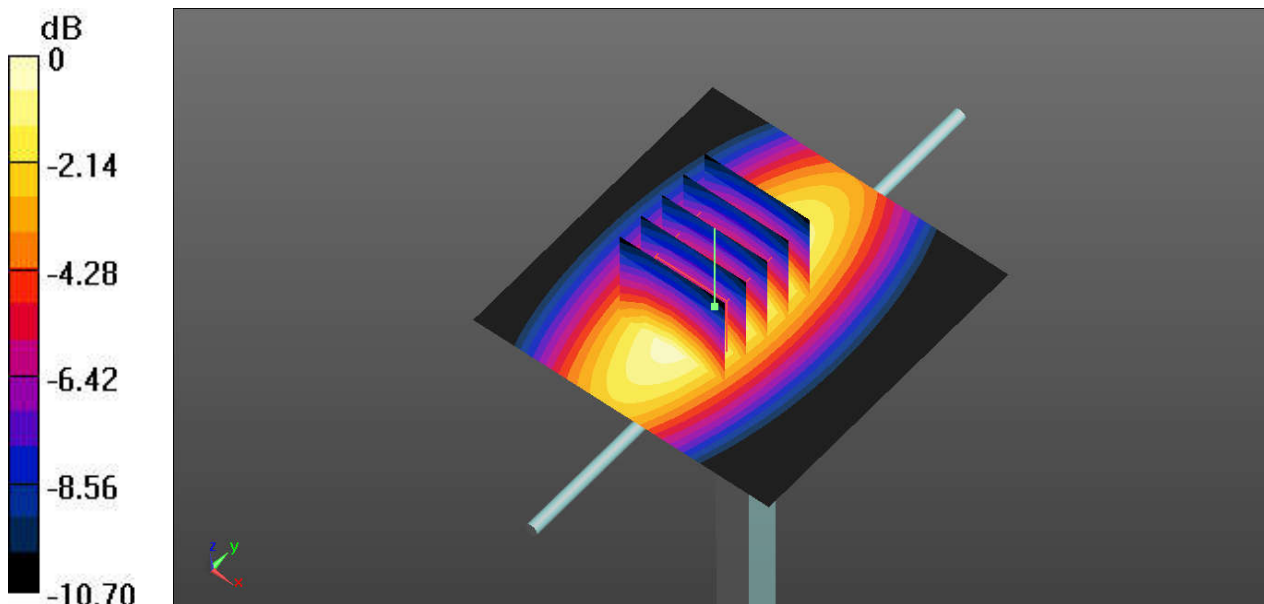

System Check_Body_1750MHz_160723

DUT: D1750V2 - SN: 1137

Communication System: UID 0, CW; Frequency: 1750 MHz; Duty Cycle: 1:1
Medium: MSL_1800_160723 Medium parameters used: $f = 1750$ MHz; $\sigma = 1.522$ S/m; $\epsilon_r = 52.519$;
 $\rho = 1000$ kg/m³
Ambient Temperature : 23.5 °C; Liquid Temperature : 22.8 °C

DASY5 Configuration:

- Probe: EX3DV4 - SN3819; ConvF(7.71, 7.71, 7.71); Calibrated: 2015.11.27;
- Sensor-Surface: 2mm (Mechanical Surface Detection)
- Electronics: DAE4 Sn1338; Calibrated: 2015.11.23
- Phantom: ELI v5.0(Right); Type: QDOVA001BB; Serial: TP:1225
- Measurement SW: DASY52, Version 52.8 (8); SEMCAD X Version 14.6.10 (7331)

Pin=250mW/Area Scan (61x61x1): Interpolated grid: dx=15mm, dy=15mm
Maximum value of SAR (interpolated) = 14.0 W/kg

Pin=250mW/Zoom Scan (5x5x7)/Cube 0: Measurement grid: dx=8mm, dy=8mm, dz=5mm
Reference Value = 95.57 V/m; Power Drift = 0.03 dB
Peak SAR (extrapolated) = 17.2 W/kg
SAR(1 g) = 9.97 W/kg; SAR(10 g) = 5.34 W/kg
Maximum value of SAR (measured) = 13.6 W/kg

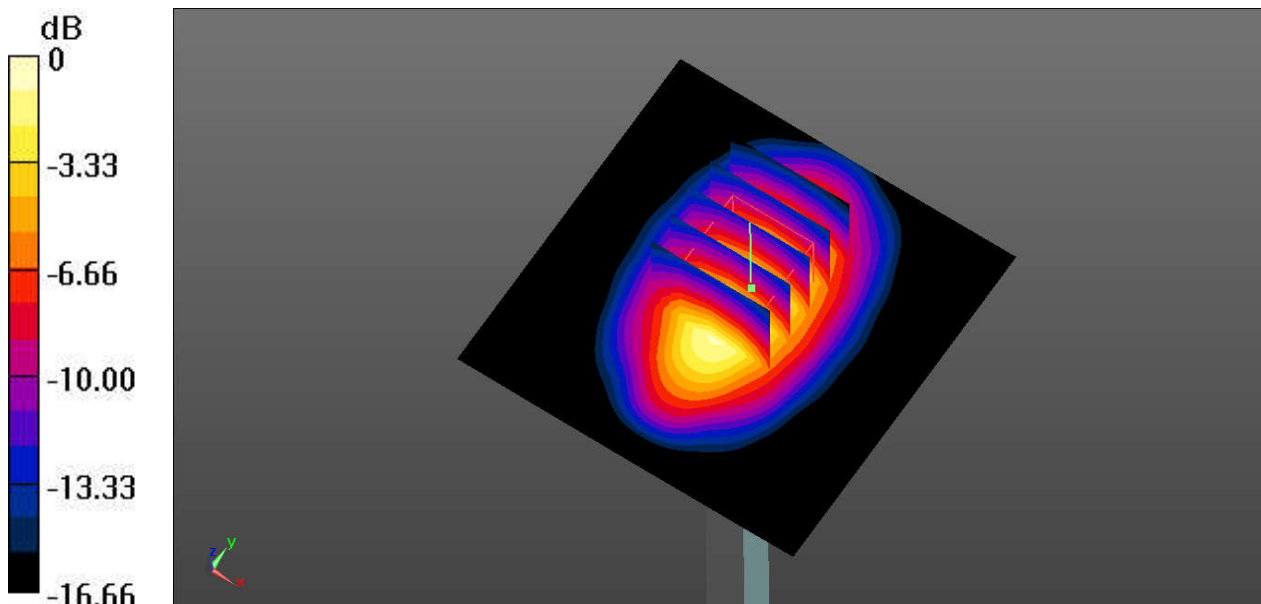

0 dB = 14.0 W/kg

System Check_Body_1750MHz_160725

DUT: D1750V2 - SN: 1137

Communication System: UID 0, CW; Frequency: 1750 MHz; Duty Cycle: 1:1
Medium: MSL_1800_160725 Medium parameters used: $f = 1750$ MHz; $\sigma = 1.517$ S/m; $\epsilon_r = 55.044$;
 $\rho = 1000$ kg/m³
Ambient Temperature : 23.2 °C; Liquid Temperature : 22.5 °C

DASY5 Configuration:

- Probe: EX3DV4 - SN3911; ConvF(8.01, 8.01, 8.01); Calibrated: 2015.10.01;
- Sensor-Surface: 2mm (Mechanical Surface Detection)
- Electronics: DAE4 Sn917; Calibrated: 2015.12.14
- Phantom: ELI v5.0(Right); Type: QDOVA001BB; Serial: TP:1225
- Measurement SW: DASY52, Version 52.8 (8); SEMCAD X Version 14.6.10 (7331)

Pin=250mW/Area Scan (61x61x1): Interpolated grid: dx=15mm, dy=15mm
Maximum value of SAR (interpolated) = 14.0 W/kg

Pin=250mW/Zoom Scan (5x5x7)/Cube 0: Measurement grid: dx=8mm, dy=8mm, dz=5mm
Reference Value = 96.56 V/m; Power Drift = 0.07 dB
Peak SAR (extrapolated) = 17.22 W/kg
SAR(1 g) = 9.87 W/kg; SAR(10 g) = 5.23 W/kg
Maximum value of SAR (measured) = 13.6 W/kg

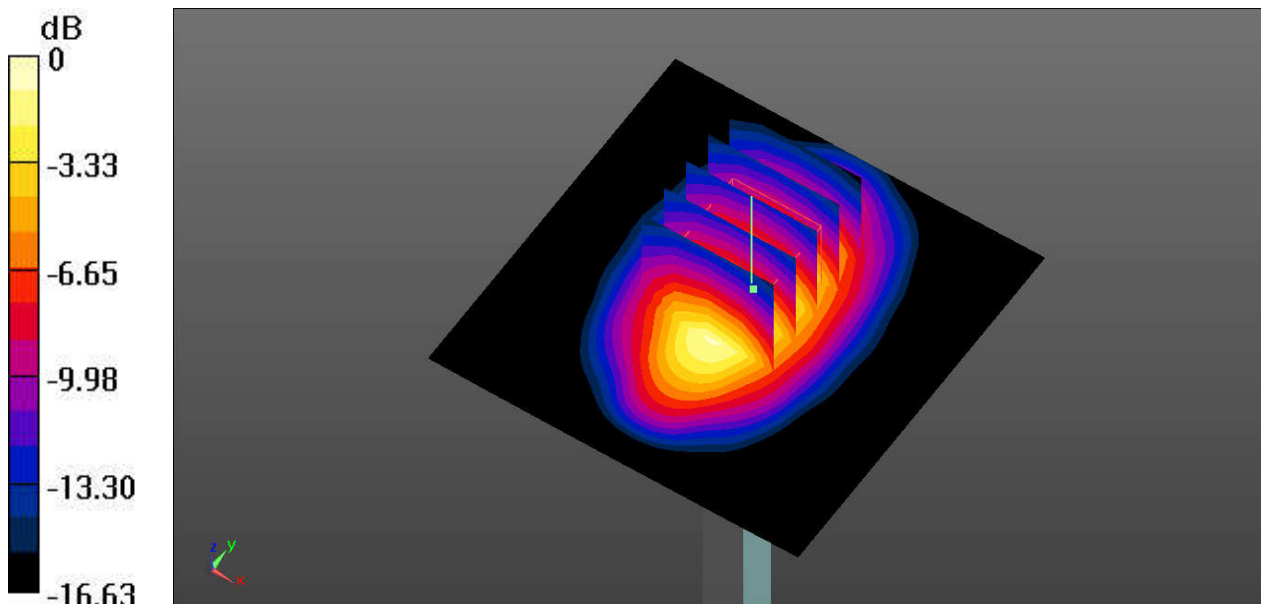

0 dB = 14.0 W/kg

System Check_Body_1900MHz_160723

DUT: D1900V2 - SN: 5d182

Communication System: UID 0, CW; Frequency: 1900 MHz; Duty Cycle: 1:1
Medium: MSL_1900_160723 Medium parameters used: $f = 1900$ MHz; $\sigma = 1.542$ S/m; $\epsilon_r = 54.484$;
 $\rho = 1000$ kg/m³
Ambient Temperature : 23.5 °C; Liquid Temperature : 22.7 °C

DASY5 Configuration:

- Probe: EX3DV4 - SN3819; ConvF(7.39, 7.39, 7.39); Calibrated: 2015.11.27;
- Sensor-Surface: 2mm (Mechanical Surface Detection)
- Electronics: DAE4 Sn1338; Calibrated: 2015.11.23
- Phantom: ELI v5.0(Right); Type: QDOVA001BB; Serial: TP:1225
- Measurement SW: DASY52, Version 52.8 (8); SEMCAD X Version 14.6.10 (7331)

Pin=250mW/Area Scan (61x61x1): Interpolated grid: dx=15mm, dy=15mm
Maximum value of SAR (interpolated) = 15.4 W/kg

Pin=250mW/Zoom Scan (5x5x7)/Cube 0: Measurement grid: dx=8mm, dy=8mm, dz=5mm
Reference Value = 88.47 V/m; Power Drift = 0.02 dB
Peak SAR (extrapolated) = 19.4 W/kg
SAR(1 g) = 10.9 W/kg; SAR(10 g) = 5.74 W/kg
Maximum value of SAR (measured) = 15.3 W/kg

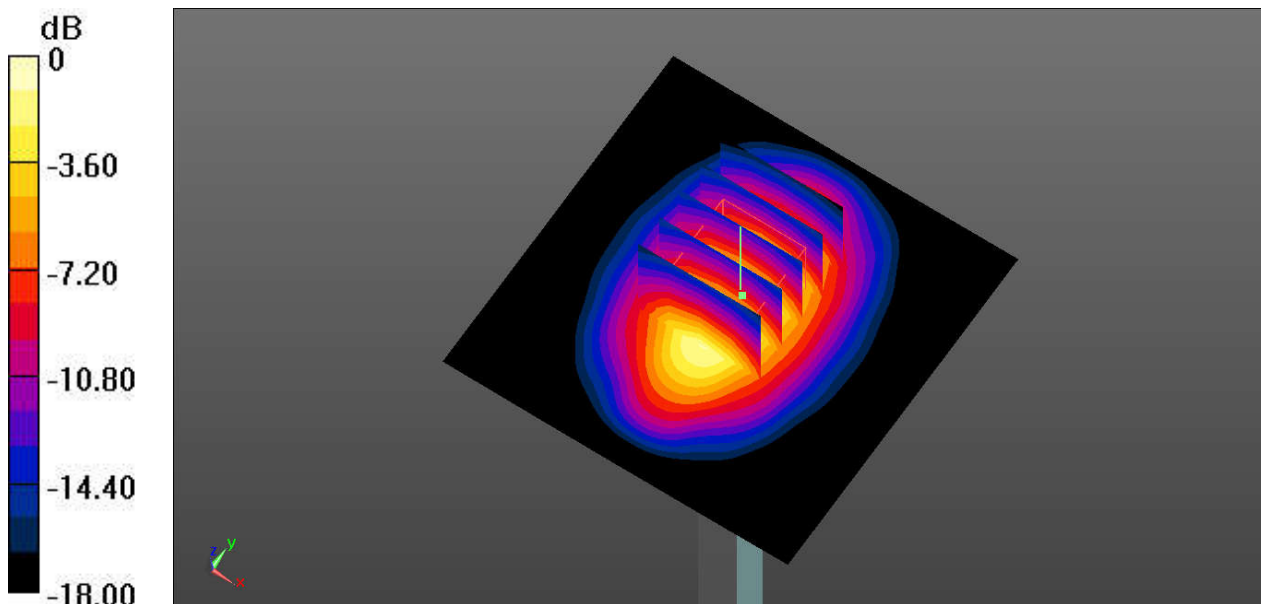

0 dB = 15.4 W/kg

System Check_Body_1900MHz_160725

DUT: D1900V2 - SN: 5d182

Communication System: UID 0, CW; Frequency: 1900 MHz; Duty Cycle: 1:1
Medium: MSL_1900_160725 Medium parameters used: $f = 1900$ MHz; $\sigma = 1.579$ S/m; $\epsilon_r = 54.206$;
 $\rho = 1000$ kg/m³
Ambient Temperature : 23.2 °C; Liquid Temperature : 22.6 °C

DASY5 Configuration:

- Probe: EX3DV4 - SN3911; ConvF(7.75, 7.75, 7.75); Calibrated: 2015.10.01;
- Sensor-Surface: 2mm (Mechanical Surface Detection)
- Electronics: DAE4 Sn917; Calibrated: 2015.12.14
- Phantom: ELI v5.0(Right); Type: QDOVA001BB; Serial: TP:1225
- Measurement SW: DASY52, Version 52.8 (8); SEMCAD X Version 14.6.10 (7331)

Pin=250mW/Area Scan (61x61x1): Interpolated grid: dx=15mm, dy=15mm
Maximum value of SAR (interpolated) = 15.1 W/kg

Pin=250mW/Zoom Scan (5x5x7)/Cube 0: Measurement grid: dx=8mm, dy=8mm, dz=5mm
Reference Value = 89.25 V/m; Power Drift = 0.03 dB
Peak SAR (extrapolated) = 19.29 W/kg
SAR(1 g) = 10.32 W/kg; SAR(10 g) = 5.38 W/kg
Maximum value of SAR (measured) = 15.1 W/kg

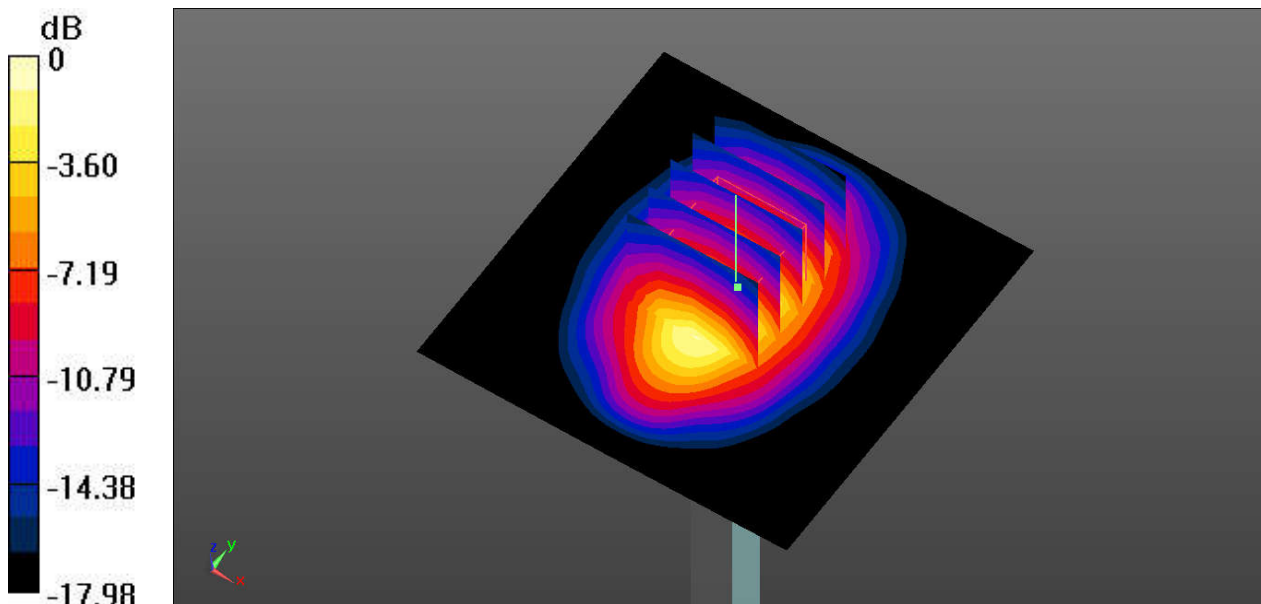

0 dB = 15.1 W/kg

System Check_Body_2450MHz_160803

DUT: D2450V2 - SN: 924

Communication System: UID 0, CW; Frequency: 2450 MHz; Duty Cycle: 1:1
Medium: MSL_2450_160803 Medium parameters used: $f = 2450$ MHz; $\sigma = 1.992$ S/m; $\epsilon_r = 52.302$;
 $\rho = 1000$ kg/m³
Ambient Temperature : 23.3 °C; Liquid Temperature : 22.9 °C

DASY5 Configuration:

- Probe: EX3DV4 - SN3911; ConvF(7.34, 7.34, 7.34); Calibrated: 2015.10.01;
- Sensor-Surface: 2mm (Mechanical Surface Detection)
- Electronics: DAE4 Sn917; Calibrated: 2015.12.14
- Phantom: ELI v5.0(Right); Type: QDOVA001BB; Serial: TP:1225
- Measurement SW: DASY52, Version 52.8 (8); SEMCAD X Version 14.6.10 (7331)

Pin=250mW/Area Scan (81x81x1): Interpolated grid: dx=12mm, dy=12mm
Maximum value of SAR (interpolated) = 20.4 W/kg

Pin=250mW/Zoom Scan (7x7x7)/Cube 0: Measurement grid: dx=5mm, dy=5mm, dz=5mm
Reference Value = 88.04 V/m; Power Drift = 0.07 dB
Peak SAR (extrapolated) = 27.1 W/kg
SAR(1 g) = 13.7 W/kg; SAR(10 g) = 6.4 W/kg
Maximum value of SAR (measured) = 20.6 W/kg

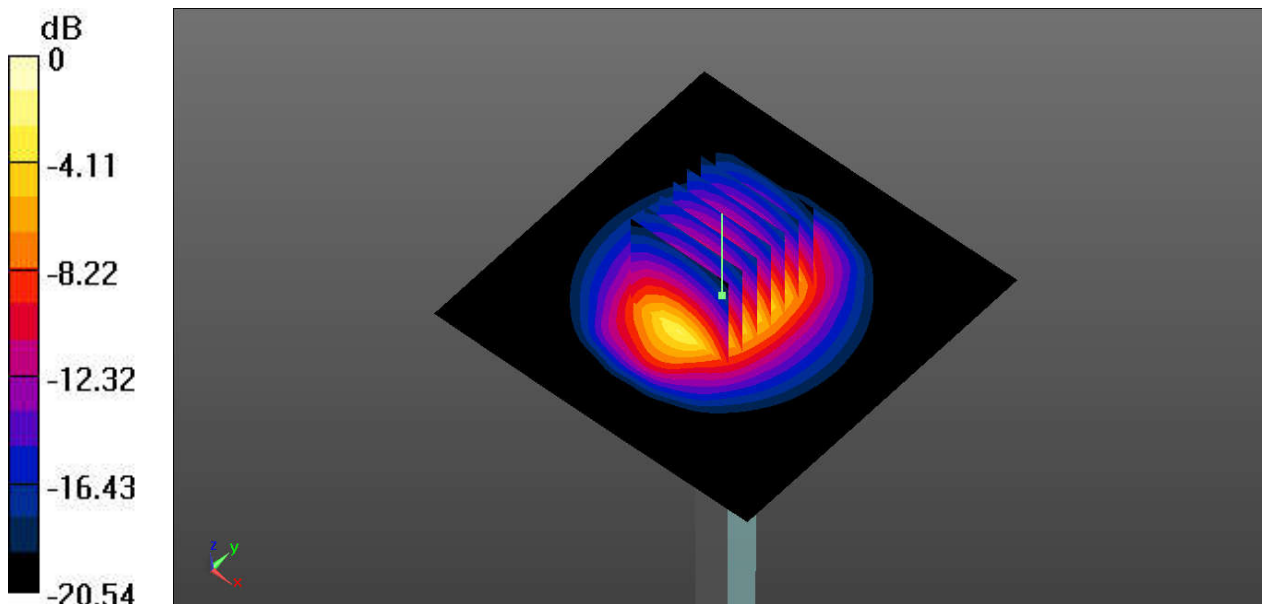

0 dB = 20.4 W/kg

System Check_Body_2600MHz_160727

DUT: D2600V2 - SN: 1070

Communication System: UID 0, CW; Frequency: 2600 MHz; Duty Cycle: 1:1
Medium: MSL_2600_160727 Medium parameters used: $f = 2600$ MHz; $\sigma = 2.209$ S/m; $\epsilon_r = 51.123$;
 $\rho = 1000$ kg/m³
Ambient Temperature : 23.5 °C; Liquid Temperature : 22.9 °C

DASY5 Configuration:

- Probe: EX3DV4 - SN3911; ConvF(7.14, 7.14, 7.14); Calibrated: 2015.10.01;
- Sensor-Surface: 2mm (Mechanical Surface Detection)
- Electronics: DAE4 Sn917; Calibrated: 2015.12.14
- Phantom: ELI v5.0(Right); Type: QDOVA001BB; Serial: TP:1225
- Measurement SW: DASY52, Version 52.8 (8); SEMCAD X Version 14.6.10 (7331)

Pin=250mW/Area Scan (71x71x1): Interpolated grid: dx=12mm, dy=12mm
Maximum value of SAR (interpolated) = 23.4 W/kg

Pin=250mW/Zoom Scan (7x7x7)/Cube 0: Measurement grid: dx=5mm, dy=5mm, dz=5mm
Reference Value = 102.1 V/m; Power Drift = 0.01 dB
Peak SAR (extrapolated) = 30.8 W/kg
SAR(1 g) = 14.6 W/kg; SAR(10 g) = 6.51 W/kg
Maximum value of SAR (measured) = 22.7 W/kg

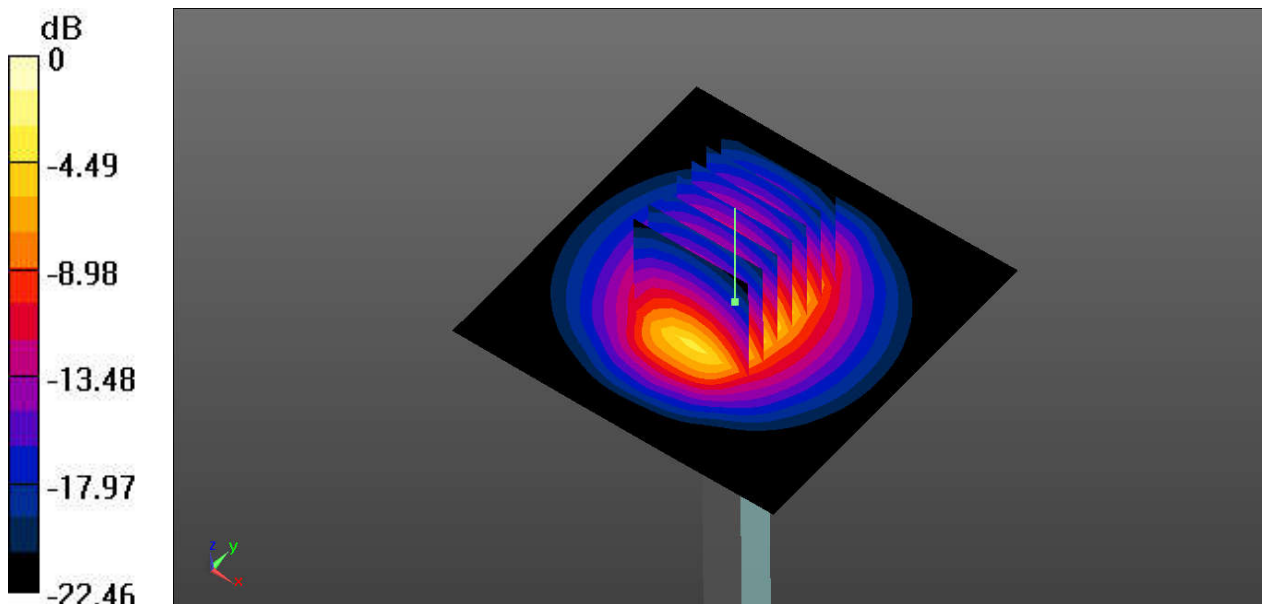

0 dB = 23.4 W/kg

System Check_Body_5250MHz_160806

DUT: D5GHzV2 - SN: 1113

Communication System: UID 0, CW (0); Frequency: 5250 MHz; Duty Cycle: 1:1

Medium: MSL_5250_160806 Medium parameters used: $f = 5250$ MHz; $\sigma = 5.37$ S/m; $\epsilon_r = 48.944$; $\rho = 1000$ kg/m³

Ambient Temperature : 23.4 °C; Liquid Temperature : 22.8 °C

DASY5 Configuration:

- Probe: EX3DV4 - SN3819; ConvF(4.2, 4.2, 4.2); Calibrated: 2015.11.27;
- Sensor-Surface: 1.4mm (Mechanical Surface Detection)
- Electronics: DAE4 Sn1338; Calibrated: 2015.11.23
- Phantom: SAM3; Type: QDOVA002AA; Serial: TP:1149
- Measurement SW: DASY52, Version 52.8 (8); SEMCAD X Version 14.6.10 (7331)

Pin=100mW/Area Scan (71x71x1): Interpolated grid: dx=10mm, dy=10mm

Maximum value of SAR (interpolated) = 17.9 W/kg

Pin=100mW/Zoom Scan (7x7x7)/Cube 0: Measurement grid: dx=4mm, dy=4mm, dz=1.4mm

Reference Value = 48.75 V/m; Power Drift = -0.01 dB

Peak SAR (extrapolated) = 30.3 W/kg

SAR(1 g) = 7.72 W/kg; SAR(10 g) = 2.11 W/kg

Maximum value of SAR (measured) = 18.7 W/kg

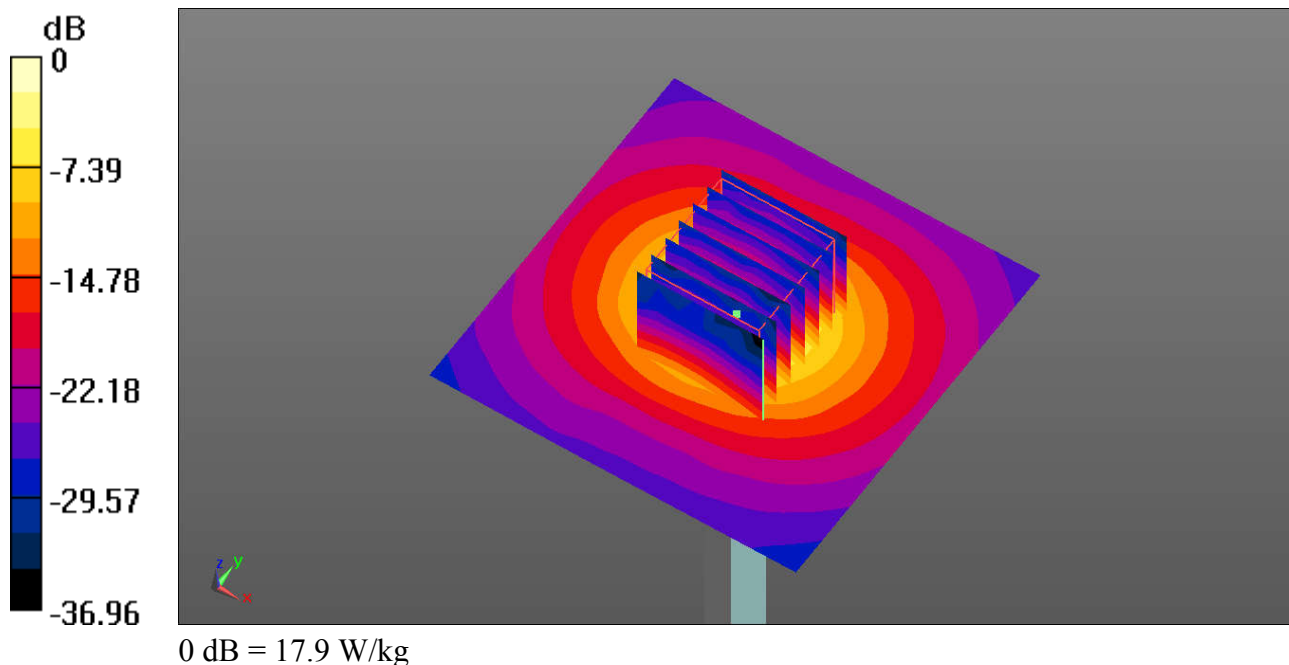

System Check_Body_5750MHz_160806

DUT: D5GHzV2 - SN: 1113

Communication System: UID 0, CW (0); Frequency: 5750 MHz; Duty Cycle: 1:1

Medium: MSL_5750_160806 Medium parameters used: $f = 5750$ MHz; $\sigma = 6.025$ S/m; $\epsilon_r = 48.112$; $\rho = 1000$ kg/m³

Ambient Temperature : 23.3 °C; Liquid Temperature : 22.6 °C

DASY5 Configuration:

- Probe: EX3DV4 - SN3819; ConvF(3.73, 3.73, 3.73); Calibrated: 2015.11.27;
- Sensor-Surface: 1.4mm (Mechanical Surface Detection)
- Electronics: DAE4 Sn1338; Calibrated: 2015.11.23
- Phantom: SAM3; Type: QDOVA002AA; Serial: TP:1149
- Measurement SW: DASY52, Version 52.8 (8); SEMCAD X Version 14.6.10 (7331)

Pin=100mW/Area Scan (71x71x1): Interpolated grid: dx=10mm, dy=10mm

Maximum value of SAR (interpolated) = 19.8 W/kg

Pin=100mW/Zoom Scan (7x7x7)/Cube 0: Measurement grid: dx=4mm, dy=4mm, dz=1.4mm

Reference Value = 46.33 V/m; Power Drift = 0.05 dB

Peak SAR (extrapolated) = 34.9 W/kg

SAR(1 g) = 8.19 W/kg; SAR(10 g) = 2.23 W/kg

Maximum value of SAR (measured) = 21.0 W/kg

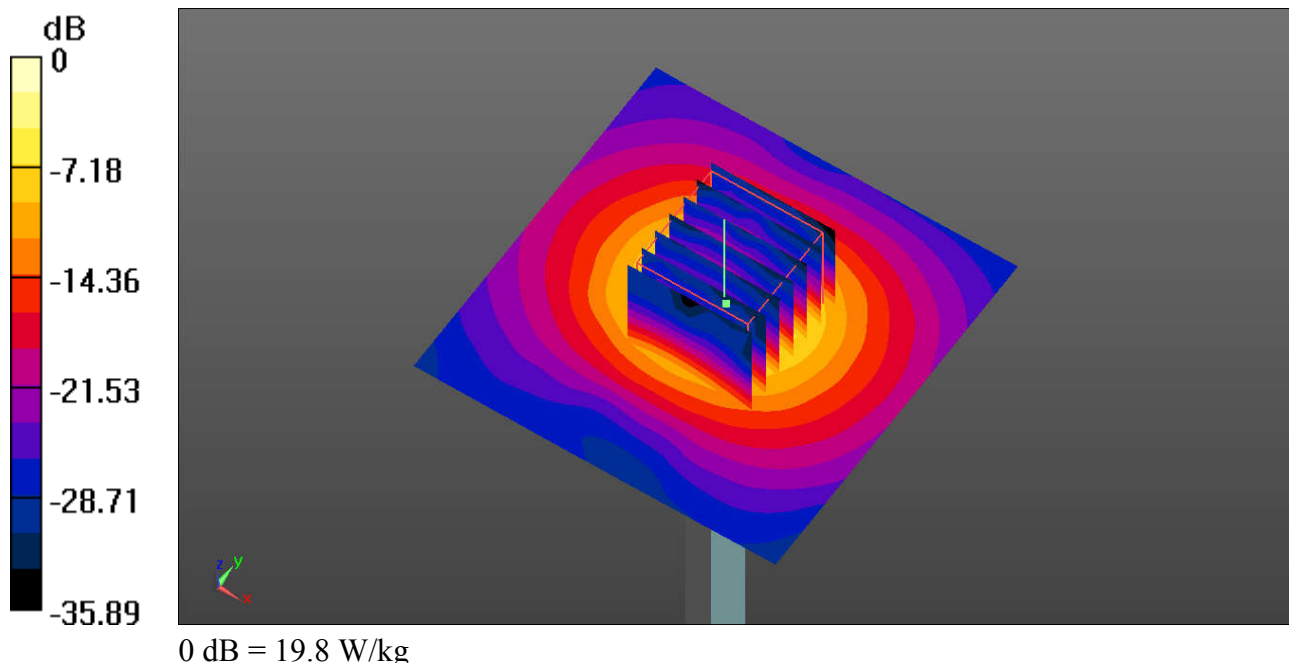



Appendix B. Plots of High SAR Measurement

The plots are shown as follows.

#01_GSM850_GPRS(2 Tx slots)_Bottom Face_9mm_Ch189_Sensor Off

Communication System: UID 0, GPRS/EDGE10 (0); Frequency: 836.4 MHz; Duty Cycle: 1:4.15
Medium: MSL_835_160722 Medium parameters used: $f = 836.4$ MHz; $\sigma = 0.978$ S/m; $\epsilon_r = 54.376$;
 $\rho = 1000$ kg/m³
Ambient Temperature : 23.3 °C; Liquid Temperature : 22.7 °C

DASY5 Configuration:

- Probe: EX3DV4 - SN3819; ConvF(9.47, 9.47, 9.47); Calibrated: 2015.11.27;
- Sensor-Surface: 2mm (Mechanical Surface Detection)
- Electronics: DAE4 Sn1338; Calibrated: 2015.11.23
- Phantom: ELI v5.0(Right); Type: QDOVA001BB; Serial: TP:1225
- Measurement SW: DASY52, Version 52.8 (8); SEMCAD X Version 14.6.10 (7331)

Ch189/Area Scan (91x81x1): Interpolated grid: dx=15mm, dy=15mm

Maximum value of SAR (interpolated) = 1.23 W/kg

Ch189/Zoom Scan (5x5x7)/Cube 0: Measurement grid: dx=8mm, dy=8mm, dz=5mm

Reference Value = 5.865 V/m; Power Drift = 0.02 dB

Peak SAR (extrapolated) = 1.51 W/kg

SAR(1 g) = 0.967 W/kg; SAR(10 g) = 0.623 W/kg

Maximum value of SAR (measured) = 1.24 W/kg

Ch189/Zoom Scan (5x5x7)/Cube 1: Measurement grid: dx=8mm, dy=8mm, dz=5mm

Reference Value = 5.865 V/m; Power Drift = 0.02 dB

Peak SAR (extrapolated) = 1.53 W/kg

SAR(1 g) = 0.927 W/kg; SAR(10 g) = 0.554 W/kg

Maximum value of SAR (measured) = 1.21 W/kg

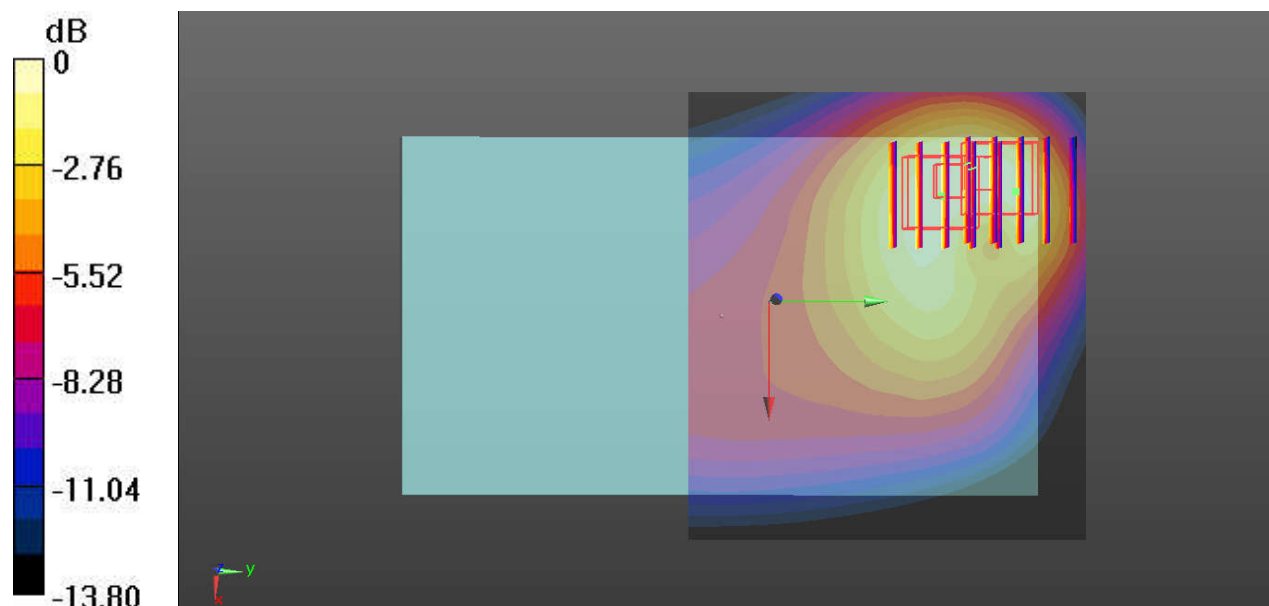

0 dB = 1.23 W/kg

#02_GSM1900_GPRS(2 Tx slots)_Bottom Face_9mm_Ch512_Sensor Off

Communication System: UID 0, GPRS/EDGE10 (0); Frequency: 1850.2 MHz; Duty Cycle: 1:4.15
Medium: MSL_1900_160725 Medium parameters used: $f = 1850.2$ MHz; $\sigma = 1.523$ S/m; $\epsilon_r = 54.384$; $\rho = 1000$ kg/m³
Ambient Temperature : 23.2 °C; Liquid Temperature : 22.6 °C

DASY5 Configuration:

- Probe: EX3DV4 - SN3911; ConvF(7.75, 7.75, 7.75); Calibrated: 2015.10.01;
- Sensor-Surface: 2mm (Mechanical Surface Detection)
- Electronics: DAE4 Sn917; Calibrated: 2015.12.14
- Phantom: ELI v5.0(Right); Type: QDOVA001BB; Serial: TP:1225
- Measurement SW: DASY52, Version 52.8 (8); SEMCAD X Version 14.6.10 (7331)

Ch512/Area Scan (91x81x1): Interpolated grid: dx=15mm, dy=15mm

Maximum value of SAR (interpolated) = 0.749 W/kg

Ch512/Zoom Scan (5x5x7)/Cube 0: Measurement grid: dx=8mm, dy=8mm, dz=5mm

Reference Value = 3.641 V/m; Power Drift = -0.01 dB

Peak SAR (extrapolated) = 0.973 W/kg

SAR(1 g) = 0.590 W/kg; SAR(10 g) = 0.343 W/kg

Maximum value of SAR (measured) = 0.788 W/kg

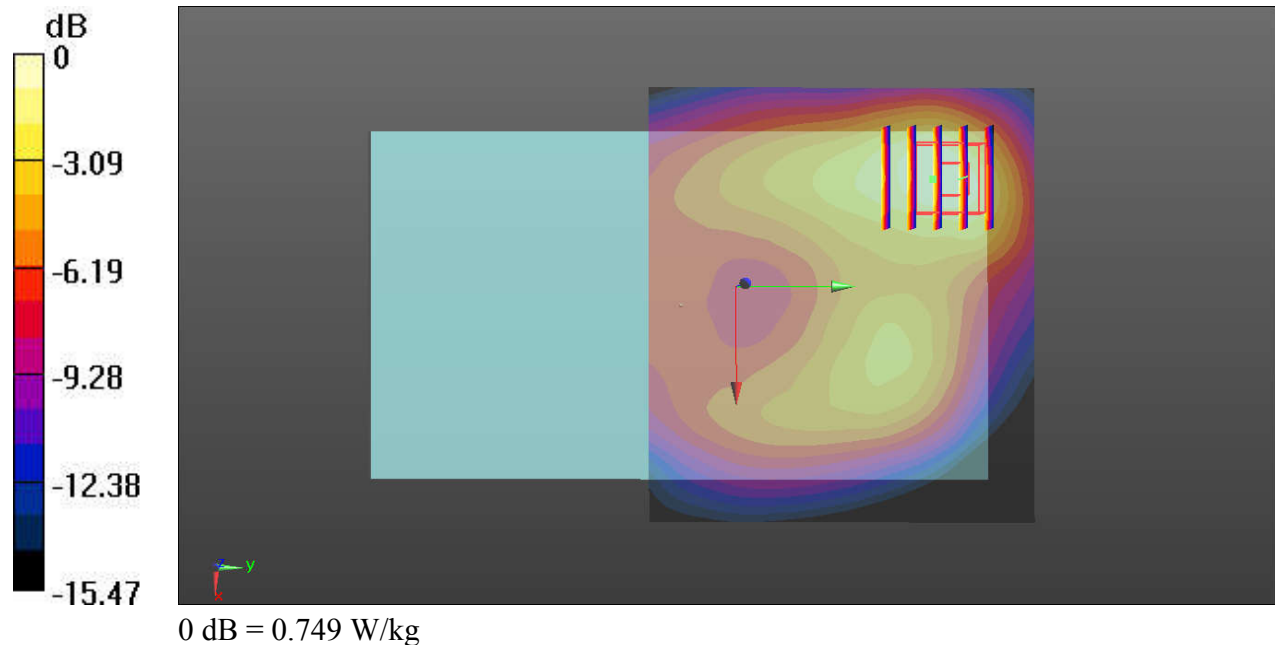

#03_WCDMA Band V_RMC 12.2Kbps_Bottom Face_9mm_Ch4132_Sensor Off

Communication System: UID 0, UMTS (0); Frequency: 826.4 MHz; Duty Cycle: 1:1
 Medium: MSL_835_160722 Medium parameters used: $f = 826.4$ MHz; $\sigma = 0.968$ S/m; $\epsilon_r = 54.448$;
 $\rho = 1000$ kg/m³
 Ambient Temperature : 23.3 °C; Liquid Temperature : 22.7 °C

DASY5 Configuration:

- Probe: EX3DV4 - SN3819; ConvF(9.47, 9.47, 9.47); Calibrated: 2015.11.27;
- Sensor-Surface: 2mm (Mechanical Surface Detection)
- Electronics: DAE4 Sn1338; Calibrated: 2015.11.23
- Phantom: ELI v5.0(Right); Type: QDOVA001BB; Serial: TP:1225
- Measurement SW: DASY52, Version 52.8 (8); SEMCAD X Version 14.6.10 (7331)

Ch4132/Area Scan (91x81x1): Interpolated grid: dx=15mm, dy=15mm
 Maximum value of SAR (interpolated) = 0.826 W/kg

Ch4132/Zoom Scan (5x5x7)/Cube 0: Measurement grid: dx=8mm, dy=8mm, dz=5mm
 Reference Value = 4.895 V/m; Power Drift = 0.07 dB
 Peak SAR (extrapolated) = 1.02 W/kg
SAR(1 g) = 0.650 W/kg; SAR(10 g) = 0.419 W/kg
 Maximum value of SAR (measured) = 0.826 W/kg

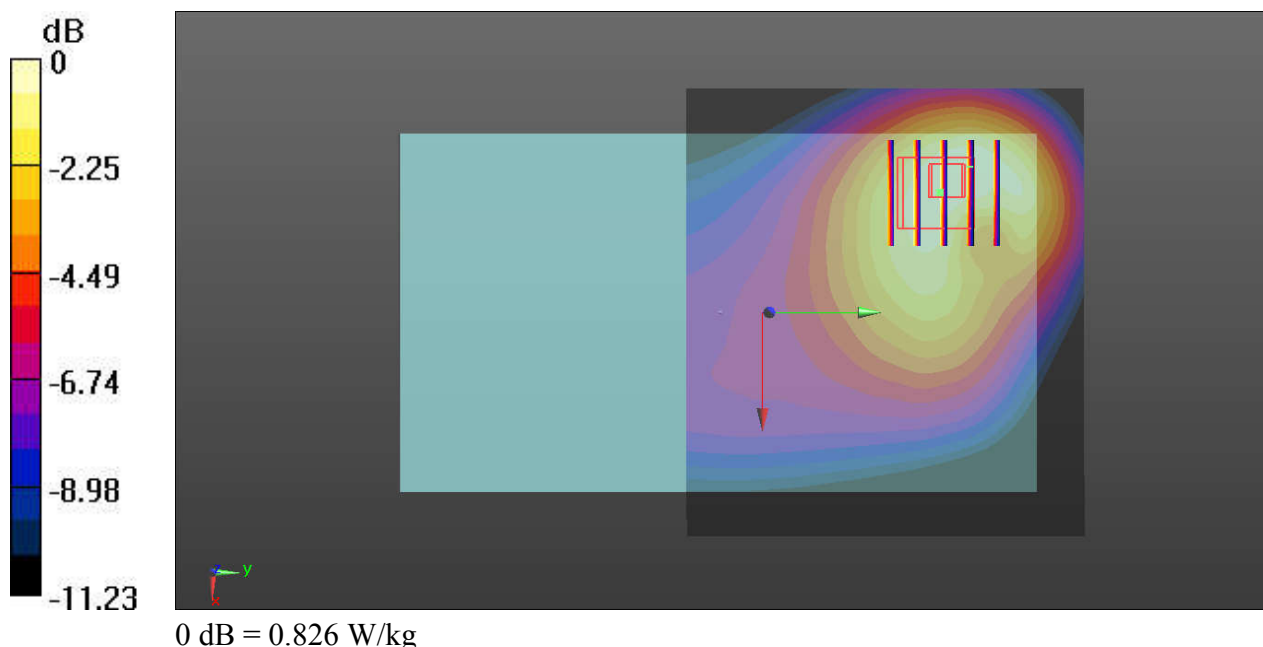

#04_WCDMA Band IV_RMC 12.2Kbps_Bottom Face_9mm_Ch1513_Sensor Off

Communication System: UID 0, UMTS (0); Frequency: 1752.6 MHz; Duty Cycle: 1:1
Medium: MSL_1800_160725 Medium parameters used: $f = 1752.6$ MHz; $\sigma = 1.52$ S/m; $\epsilon_r = 55.039$;
 $\rho = 1000$ kg/m³
Ambient Temperature : 23.2 °C; Liquid Temperature : 22.5 °C

DASY5 Configuration:

- Probe: EX3DV4 - SN3911; ConvF(8.01, 8.01, 8.01); Calibrated: 2015.10.01;
- Sensor-Surface: 2mm (Mechanical Surface Detection)
- Electronics: DAE4 Sn917; Calibrated: 2015.12.14
- Phantom: ELI v5.0(Right); Type: QDOVA001BB; Serial: TP:1225
- Measurement SW: DASY52, Version 52.8 (8); SEMCAD X Version 14.6.10 (7331)

Ch1513/Area Scan (91x81x1): Interpolated grid: dx=15mm, dy=15mm
Maximum value of SAR (interpolated) = 1.25 W/kg

Ch1513/Zoom Scan (5x5x7)/Cube 0: Measurement grid: dx=8mm, dy=8mm, dz=5mm
Reference Value = 4.148 V/m; Power Drift = 0.06 dB
Peak SAR (extrapolated) = 1.44 W/kg
SAR(1 g) = 0.918 W/kg; SAR(10 g) = 0.563 W/kg
Maximum value of SAR (measured) = 1.18 W/kg

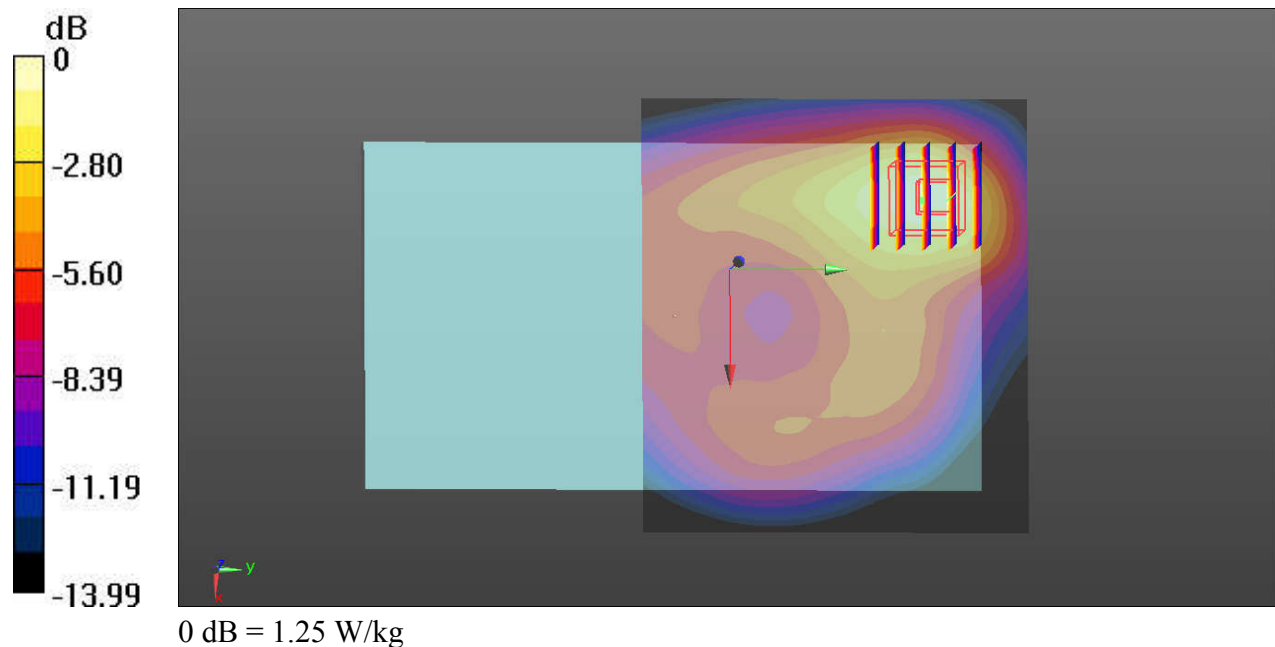

#05_WCDMA Band II_RMC 12.2Kbps_Bottom Face_9mm_Ch9400_Sensor Off

Communication System: UID 0, UMTS (0); Frequency: 1880 MHz; Duty Cycle: 1:1
Medium: MSL_1900_160725 Medium parameters used: $f = 1880$ MHz; $\sigma = 1.557$ S/m; $\epsilon_r = 54.279$;
 $\rho = 1000$ kg/m³
Ambient Temperature : 23.2 °C; Liquid Temperature : 22.6 °C

DASY5 Configuration:

- Probe: EX3DV4 - SN3911; ConvF(7.75, 7.75, 7.75); Calibrated: 2015.10.01;
- Sensor-Surface: 2mm (Mechanical Surface Detection)
- Electronics: DAE4 Sn917; Calibrated: 2015.12.14
- Phantom: ELI v5.0(Right); Type: QDOVA001BB; Serial: TP:1225
- Measurement SW: DASY52, Version 52.8 (8); SEMCAD X Version 14.6.10 (7331)

Ch9400/Area Scan (91x81x1): Interpolated grid: dx=15mm, dy=15mm
Maximum value of SAR (interpolated) = 1.12 W/kg

Ch9400/Zoom Scan (5x5x7)/Cube 0: Measurement grid: dx=8mm, dy=8mm, dz=5mm
Reference Value = 4.311 V/m; Power Drift = 0.12 dB
Peak SAR (extrapolated) = 1.37 W/kg
SAR(1 g) = 0.825 W/kg; SAR(10 g) = 0.471 W/kg
Maximum value of SAR (measured) = 1.07 W/kg

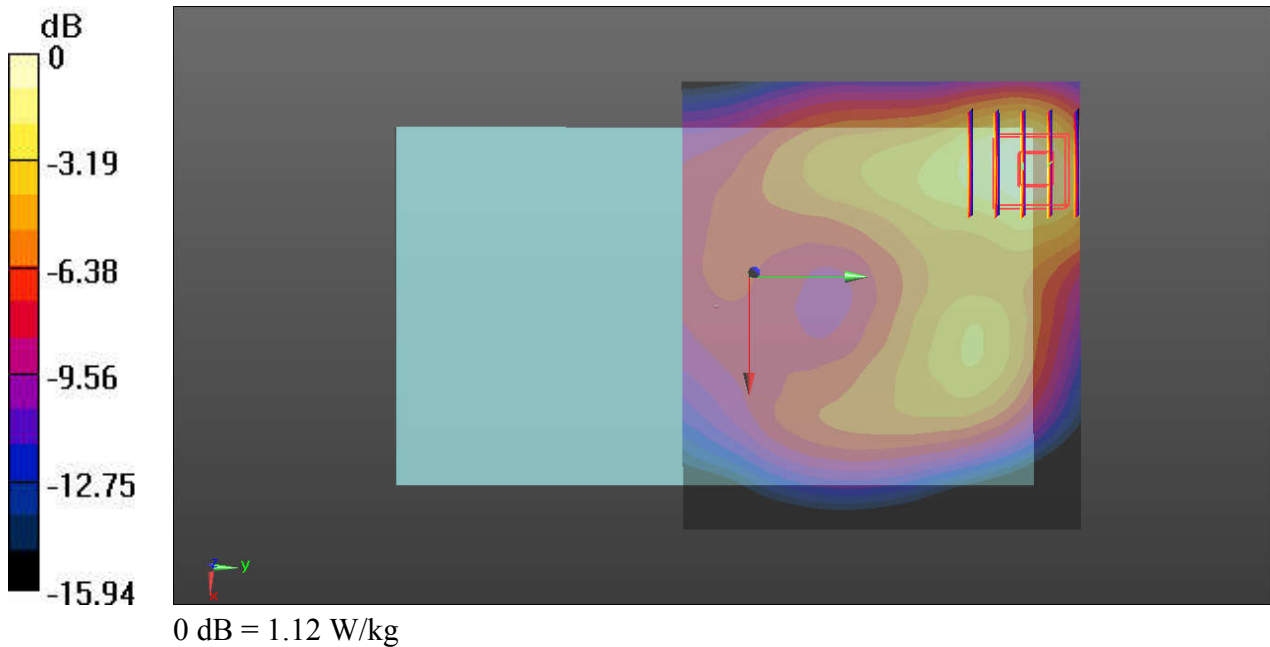

**#06_LTE Band 12_10M_QPSK_1RB_25Offset_Bottom
Face_9mm_Ch23095_Sensor Off**

Communication System: UID 0, LTE (0); Frequency: 707.5 MHz; Duty Cycle: 1:1
 Medium: MSL_750_160721 Medium parameters used: $f = 707.5$ MHz; $\sigma = 0.94$ S/m; $\epsilon_r = 55.583$; $\rho = 1000$ kg/m³
 Ambient Temperature : 23.4 °C; Liquid Temperature : 22.5 °C

DASY5 Configuration:

- Probe: EX3DV4 - SN3819; ConvF(9.69, 9.69, 9.69); Calibrated: 2015.11.27;
- Sensor-Surface: 2mm (Mechanical Surface Detection)
- Electronics: DAE4 Sn1338; Calibrated: 2015.11.23
- Phantom: ELI v5.0(Right); Type: QDOVA001BB; Serial: TP:1225
- Measurement SW: DASY52, Version 52.8 (8); SEMCAD X Version 14.6.10 (7331)

Ch23095/Area Scan (91x81x1): Interpolated grid: dx=15mm, dy=15mm
 Maximum value of SAR (interpolated) = 0.652 W/kg

Ch23095/Zoom Scan (5x5x7)/Cube 0: Measurement grid: dx=8mm, dy=8mm, dz=5mm
 Reference Value = 5.951 V/m; Power Drift = 0.08 dB
 Peak SAR (extrapolated) = 0.705 W/kg
SAR(1 g) = 0.466 W/kg; SAR(10 g) = 0.311 W/kg
 Maximum value of SAR (measured) = 0.591 W/kg

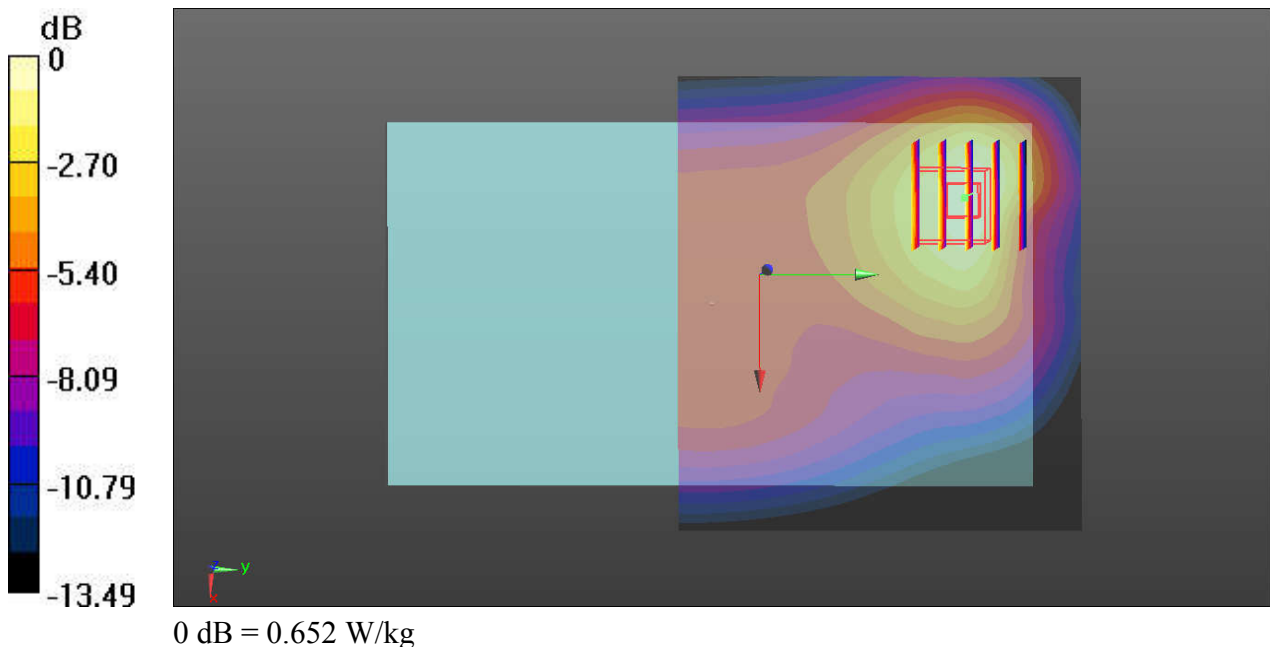

#07_LTE Band 5_10M_QPSK_1RB_25Offset_Bottom Face_9mm_Ch20525_Sensor Off

Communication System: UID 0, LTE (0); Frequency: 836.5 MHz; Duty Cycle: 1:1
Medium: MSL_835_160721 Medium parameters used: $f = 836.5$ MHz; $\sigma = 0.969$ S/m; $\epsilon_r = 55.885$;
 $\rho = 1000$ kg/m³
Ambient Temperature : 23.4 °C; Liquid Temperature : 22.6 °C

DASY5 Configuration:

- Probe: EX3DV4 - SN3819; ConvF(9.47, 9.47, 9.47); Calibrated: 2015.11.27;
- Sensor-Surface: 2mm (Mechanical Surface Detection)
- Electronics: DAE4 Sn1338; Calibrated: 2015.11.23
- Phantom: ELI v5.0(Right); Type: QDOVA001BB; Serial: TP:1225
- Measurement SW: DASY52, Version 52.8 (8); SEMCAD X Version 14.6.10 (7331)

Ch20525/Area Scan (91x81x1): Interpolated grid: dx=15mm, dy=15mm
Maximum value of SAR (interpolated) = 0.838 W/kg

Ch20525/Zoom Scan (5x5x7)/Cube 0: Measurement grid: dx=8mm, dy=8mm, dz=5mm
Reference Value = 4.223 V/m; Power Drift = 0.09 dB
Peak SAR (extrapolated) = 1.01 W/kg
SAR(1 g) = 0.618 W/kg; SAR(10 g) = 0.385 W/kg
Maximum value of SAR (measured) = 0.820 W/kg

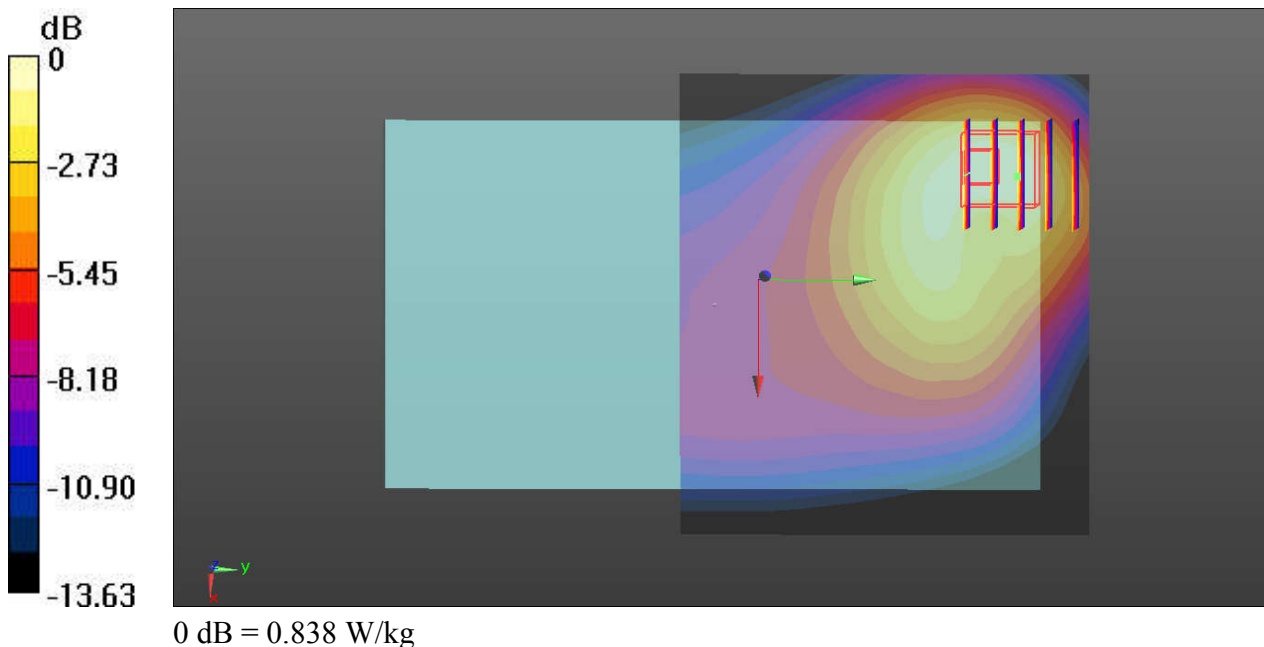

#08_LTE Band 4_20M_QPSK_1RB_0Offset_Bottom Face_9mm_Ch20175_Sensor Off

Communication System: UID 0, LTE (0); Frequency: 1732.5 MHz; Duty Cycle: 1:1
Medium: MSL_1800_160723 Medium parameters used: $f = 1732.5$ MHz; $\sigma = 1.502$ S/m; $\epsilon_r = 52.553$; $\rho = 1000$ kg/m³
Ambient Temperature : 23.5 °C; Liquid Temperature : 22.8 °C

DASY5 Configuration:

- Probe: EX3DV4 - SN3819; ConvF(7.71, 7.71, 7.71); Calibrated: 2015.11.27;
- Sensor-Surface: 2mm (Mechanical Surface Detection)
- Electronics: DAE4 Sn1338; Calibrated: 2015.11.23
- Phantom: ELI v5.0(Right); Type: QDOVA001BB; Serial: TP:1225
- Measurement SW: DASY52, Version 52.8 (8); SEMCAD X Version 14.6.10 (7331)

Ch20175/Area Scan (91x81x1): Interpolated grid: dx=15mm, dy=15mm
Maximum value of SAR (interpolated) = 1.19 W/kg

Ch20175/Zoom Scan (5x5x7)/Cube 0: Measurement grid: dx=8mm, dy=8mm, dz=5mm
Reference Value = 4.770 V/m; Power Drift = 0.04 dB
Peak SAR (extrapolated) = 1.42 W/kg
SAR(1 g) = 0.94 W/kg; SAR(10 g) = 0.561 W/kg
Maximum value of SAR (measured) = 1.14 W/kg

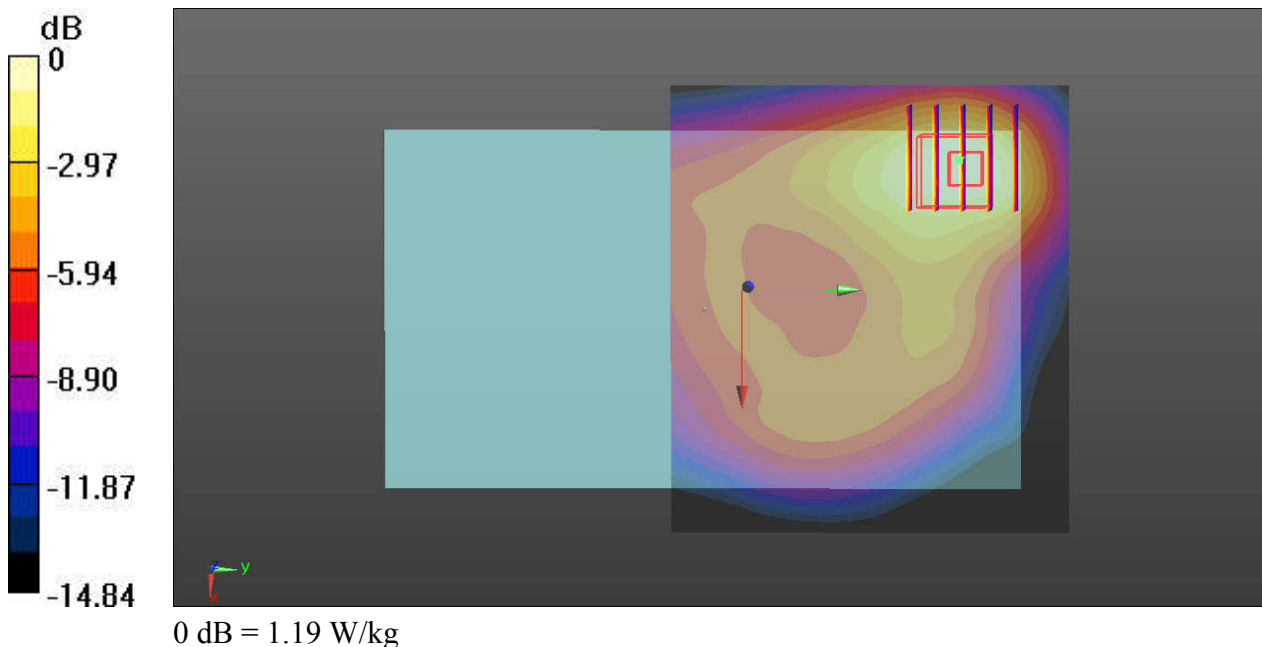

#09_LTE Band 2_20M_QPSK_1RB_0Offset_Bottom Face_9mm_Ch18700_Sensor Off

Communication System: UID 0, LTE (0); Frequency: 1860 MHz; Duty Cycle: 1:1
Medium: MSL_1900_160723 Medium parameters used: $f = 1860$ MHz; $\sigma = 1.492$ S/m; $\epsilon_r = 54.554$;
 $\rho = 1000$ kg/m³
Ambient Temperature : 23.5 °C; Liquid Temperature : 22.7 °C

DASY5 Configuration:

- Probe: EX3DV4 - SN3819; ConvF(7.39, 7.39, 7.39); Calibrated: 2015.11.27;
- Sensor-Surface: 2mm (Mechanical Surface Detection)
- Electronics: DAE4 Sn1338; Calibrated: 2015.11.23
- Phantom: ELI v5.0(Right); Type: QDOVA001BB; Serial: TP:1225
- Measurement SW: DASY52, Version 52.8 (8); SEMCAD X Version 14.6.10 (7331)

Ch18700/Area Scan (91x81x1): Interpolated grid: dx=15mm, dy=15mm
Maximum value of SAR (interpolated) = 1.16 W/kg

Ch18700/Zoom Scan (5x5x7)/Cube 0: Measurement grid: dx=8mm, dy=8mm, dz=5mm
Reference Value = 3.986 V/m; Power Drift = 0.03 dB
Peak SAR (extrapolated) = 1.55 W/kg
SAR(1 g) = 0.919 W/kg; SAR(10 g) = 0.524 W/kg
Maximum value of SAR (measured) = 1.22 W/kg

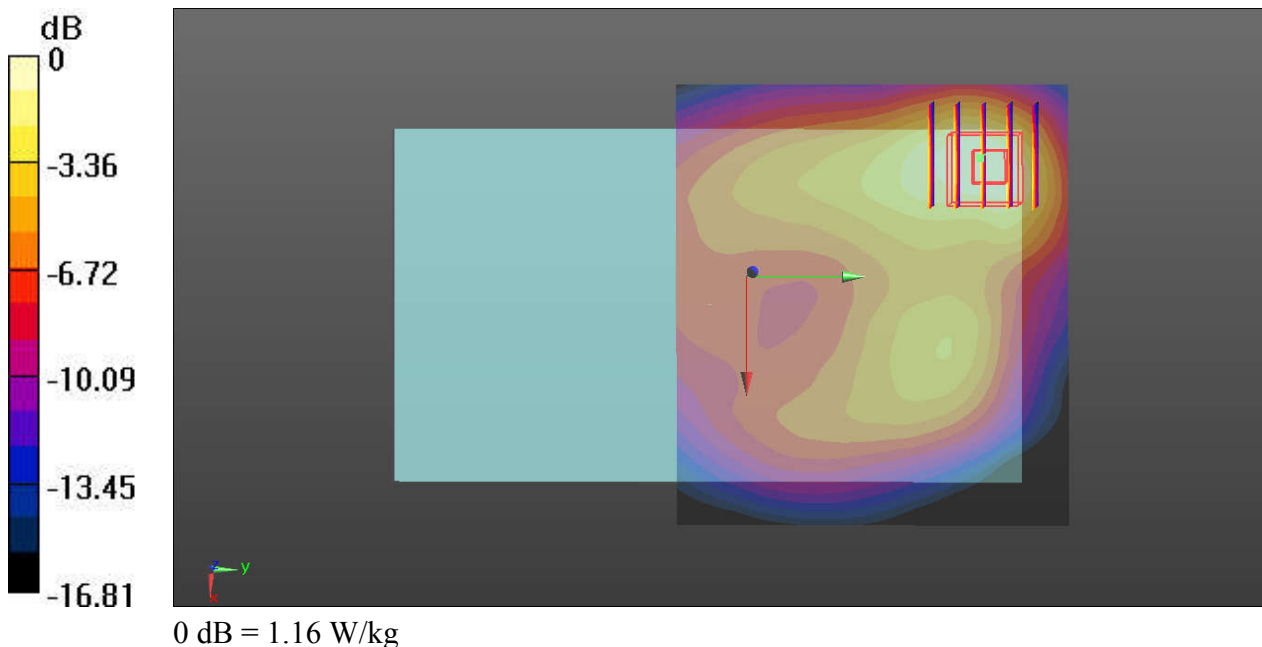

#10_LTE Band 7_20M_QPSK_1RB_0Offset_Edge 1_6mm_Ch21350_Sensor Off

Communication System: UID 0, LTE (0); Frequency: 2560 MHz;Duty Cycle: 1:1
Medium: MSL_2600_160727 Medium parameters used: $f = 2560$ MHz; $\sigma = 2.156$ S/m; $\epsilon_r = 51.082$;
 $\rho = 1000$ kg/m³
Ambient Temperature : 23.5 °C; Liquid Temperature : 22.9 °C

DASY5 Configuration:

- Probe: EX3DV4 - SN3911; ConvF(7.14, 7.14, 7.14); Calibrated: 2015.10.01;
- Sensor-Surface: 2mm (Mechanical Surface Detection)
- Electronics: DAE4 Sn917; Calibrated: 2015.12.14
- Phantom: ELI v5.0(Right); Type: QDOVA001BB; Serial: TP:1225
- Measurement SW: DASY52, Version 52.8 (8); SEMCAD X Version 14.6.10 (7331)

Ch21350/Area Scan (41x111x1): Interpolated grid: dx=12mm, dy=12mm
Maximum value of SAR (interpolated) = 1.55 W/kg

Ch21350/Zoom Scan (7x7x7)/Cube 0: Measurement grid: dx=5mm, dy=5mm, dz=5mm
Reference Value = 4.758 V/m; Power Drift = 0.04 dB
Peak SAR (extrapolated) = 2.09 W/kg
SAR(1 g) = 1.05 W/kg; SAR(10 g) = 0.490 W/kg
Maximum value of SAR (measured) = 1.57 W/kg

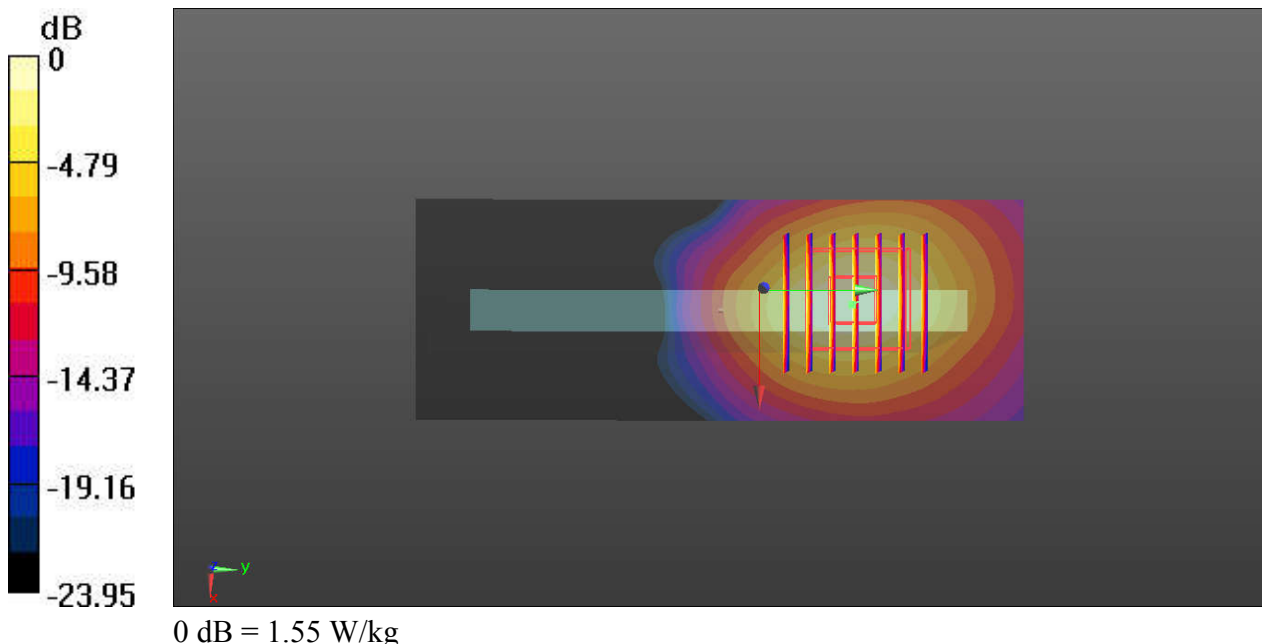

#11_WLAN2.4GHz_802.11b 1Mbps_Bottom Face_0mm_Ch6

Communication System: UID 0, WIFI (0); Frequency: 2437 MHz; Duty Cycle: 1:1.021
Medium: MSL_2450_160803 Medium parameters used: $f = 2437$ MHz; $\sigma = 1.974$ S/m; $\epsilon_r = 52.384$;
 $\rho = 1000$ kg/m³
Ambient Temperature : 23.3 °C; Liquid Temperature : 22.9 °C

DASY5 Configuration:

- Probe: EX3DV4 - SN3911; ConvF(7.34, 7.34, 7.34); Calibrated: 2015.10.01;
- Sensor-Surface: 2mm (Mechanical Surface Detection)
- Electronics: DAE4 Sn917; Calibrated: 2015.12.14
- Phantom: ELI v5.0(Right); Type: QDOVA001BB; Serial: TP:1225
- Measurement SW: DASY52, Version 52.8 (8); SEMCAD X Version 14.6.10 (7331)

Ch6/Area Scan (11x71x1): Interpolated grid: dx=12mm, dy=12mm
Maximum value of SAR (interpolated) = 1.85 W/kg

Ch6/Zoom Scan (7x7x7)/Cube 0: Measurement grid: dx=5mm, dy=5mm, dz=5mm
Reference Value = 0 V/m; Power Drift = 0.02 dB
Peak SAR (extrapolated) = 2.88 W/kg
SAR(1 g) = 1.110 W/kg; SAR(10 g) = 0.463 W/kg
Maximum value of SAR (measured) = 2.05 W/kg

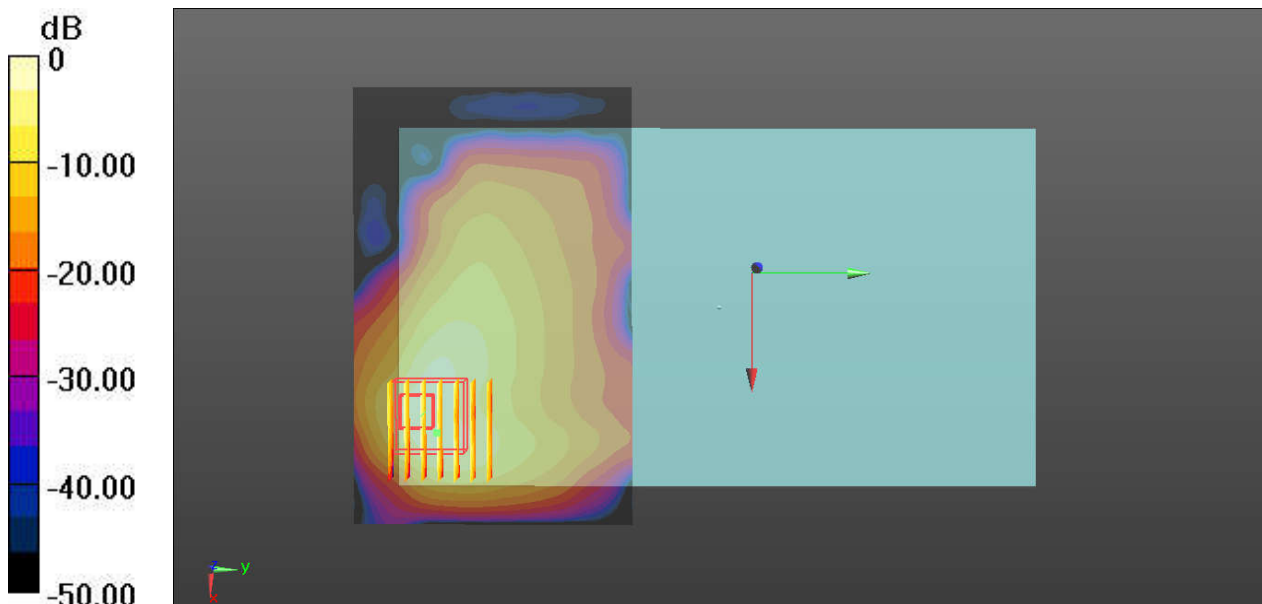

0 dB = 1.85 W/kg

#12_WLAN5.2GHz_802.11a 6Mbps_Bottom Face_0mm_Ch48

Communication System: UID 0, WIFI (0); Frequency: 5240 MHz; Duty Cycle: 1:1.144
 Medium: MSL_5250_160806 Medium parameters used: $f = 5240$ MHz; $\sigma = 5.349$ S/m; $\epsilon_r = 48.935$; $\rho = 1000$ kg/m³
 Ambient Temperature : 23.4 °C; Liquid Temperature : 22.8 °C

DASY5 Configuration:

- Probe: EX3DV4 - SN3819; ConvF(4.2, 4.2, 4.2); Calibrated: 2015.11.27;
- Sensor-Surface: 1.4mm (Mechanical Surface Detection)
- Electronics: DAE4 Sn1338; Calibrated: 2015.11.23
- Phantom: SAM3; Type: QDOVA002AA; Serial: TP:1149
- Measurement SW: DASY52, Version 52.8 (8); SEMCAD X Version 14.6.10 (7331)

Ch48/Area Scan (81x71x1): Interpolated grid: dx=10mm, dy=10mm

Maximum value of SAR (interpolated) = 2.60 W/kg

Ch48/Zoom Scan (7x7x7)/Cube 0: Measurement grid: dx=4mm, dy=4mm, dz=1.4mm

Reference Value = 3.238 V/m; Power Drift = 0.03 dB

Peak SAR (extrapolated) = 4.39 W/kg

SAR(1 g) = 0.990 W/kg; SAR(10 g) = 0.315 W/kg

Maximum value of SAR (measured) = 2.37 W/kg

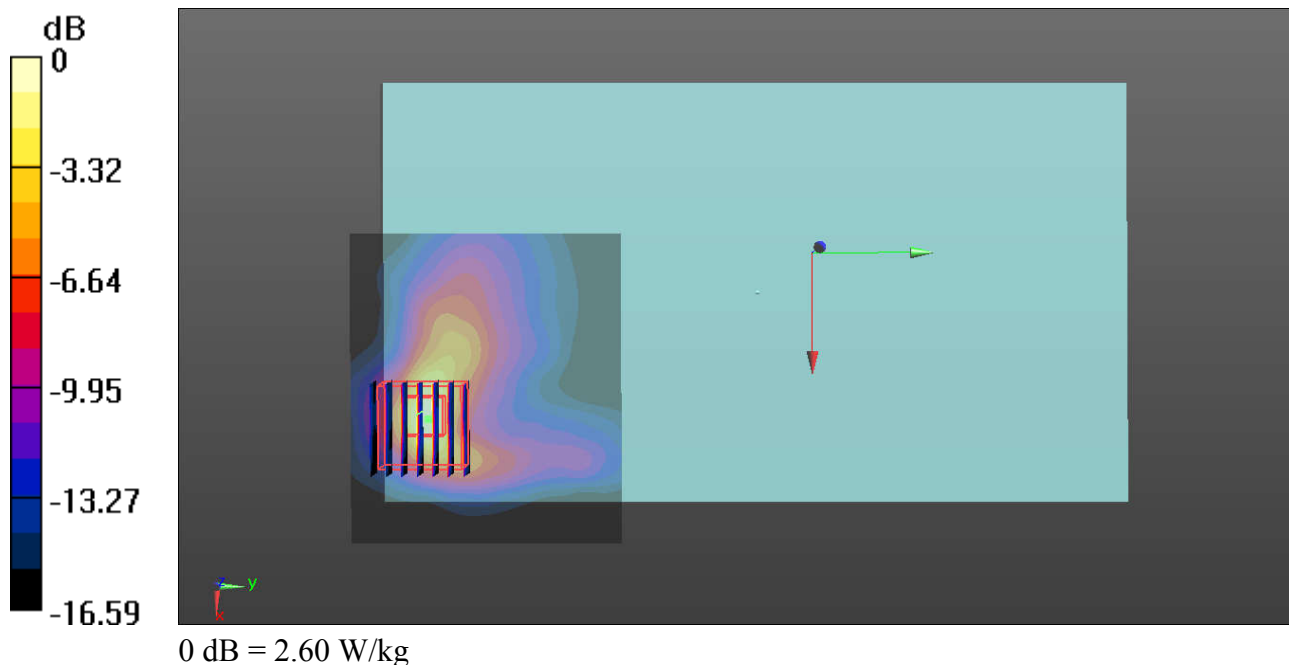

#13_WLAN5.3GHz_802.11a 6Mbps_Bottom Face_0mm_Ch56

Communication System: UID 0, WIFI (0); Frequency: 5280 MHz; Duty Cycle: 1:1.144
Medium: MSL_5250_160806 Medium parameters used: $f = 5280$ MHz; $\sigma = 5.4$ S/m; $\epsilon_r = 48.942$; $\rho = 1000$ kg/m³
Ambient Temperature : 23.4 °C; Liquid Temperature : 22.8 °C

DASY5 Configuration:

- Probe: EX3DV4 - SN3819; ConvF(4.2, 4.2, 4.2); Calibrated: 2015.11.27;
- Sensor-Surface: 1.4mm (Mechanical Surface Detection)
- Electronics: DAE4 Sn1338; Calibrated: 2015.11.23
- Phantom: SAM3; Type: QDOVA002AA; Serial: TP:1149
- Measurement SW: DASY52, Version 52.8 (8); SEMCAD X Version 14.6.10 (7331)

Ch56/Area Scan (81x71x1): Interpolated grid: dx=10mm, dy=10mm

Maximum value of SAR (interpolated) = 2.53 W/kg

Ch56/Zoom Scan (7x7x7)/Cube 0: Measurement grid: dx=4mm, dy=4mm, dz=1.4mm

Reference Value = 2.557 V/m; Power Drift = 0.05 dB

Peak SAR (extrapolated) = 4.71 W/kg

SAR(1 g) = 1.05 W/kg; SAR(10 g) = 0.340 W/kg

Maximum value of SAR (measured) = 2.55 W/kg

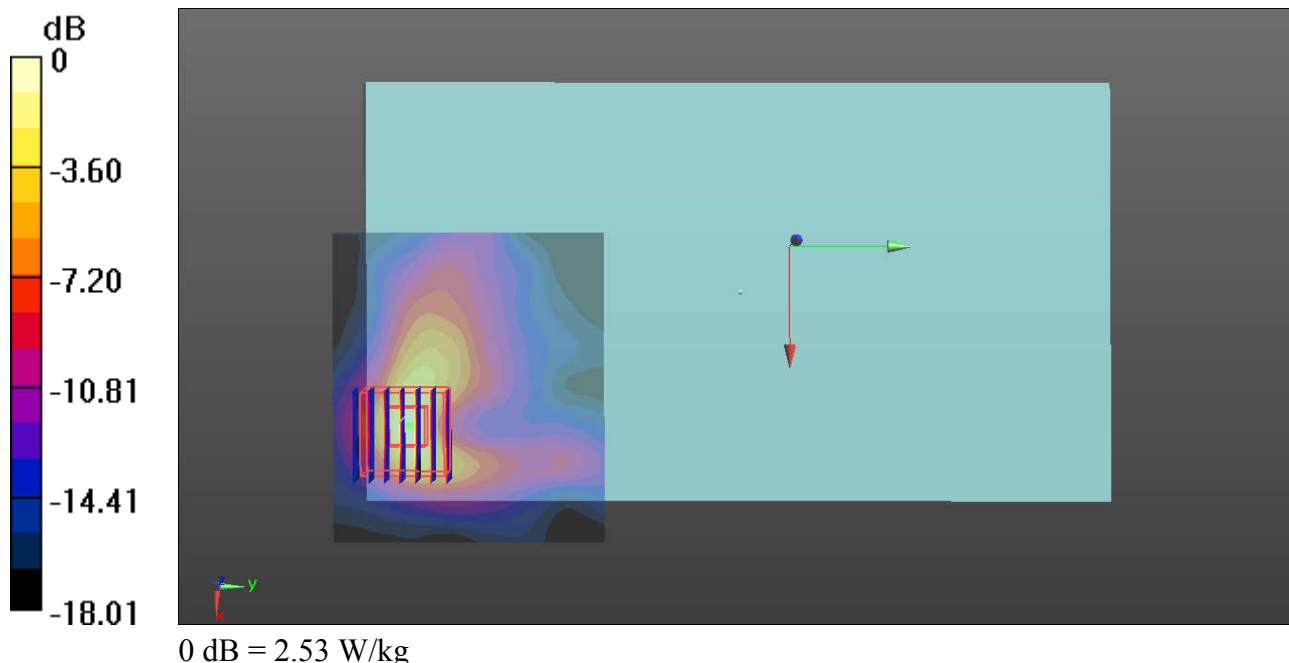

#14_WLAN5.8GHz_802.11a 6Mbps_Edge 3_0mm_Ch161

Communication System: UID 0, WIFI (0); Frequency: 5805 MHz; Duty Cycle: 1:1.144
Medium: MSL_5750_160806 Medium parameters used: $f = 5805$ MHz; $\sigma = 6.143$ S/m; $\epsilon_r = 47.773$; $\rho = 1000$ kg/m³
Ambient Temperature : 23.3 °C; Liquid Temperature : 22.6 °C

DASY5 Configuration:

- Probe: EX3DV4 - SN3819; ConvF(3.73, 3.73, 3.73); Calibrated: 2015.11.27;
- Sensor-Surface: 1.4mm (Mechanical Surface Detection)
- Electronics: DAE4 Sn1338; Calibrated: 2015.11.23
- Phantom: SAM3; Type: QDOVA002AA; Serial: TP:1149
- Measurement SW: DASY52, Version 52.8 (8); SEMCAD X Version 14.6.10 (7331)

Ch161/Area Scan (51x91x1): Interpolated grid: dx=10mm, dy=10mm
Maximum value of SAR (interpolated) = 2.78 W/kg

Ch161/Zoom Scan (7x7x7)/Cube 0: Measurement grid: dx=4mm, dy=4mm, dz=1.4mm
Reference Value = 2.973 V/m; Power Drift = -0.03 dB
Peak SAR (extrapolated) = 5.05 W/kg
SAR(1 g) = 1.1 W/kg; SAR(10 g) = 0.319 W/kg
Maximum value of SAR (measured) = 2.89 W/kg

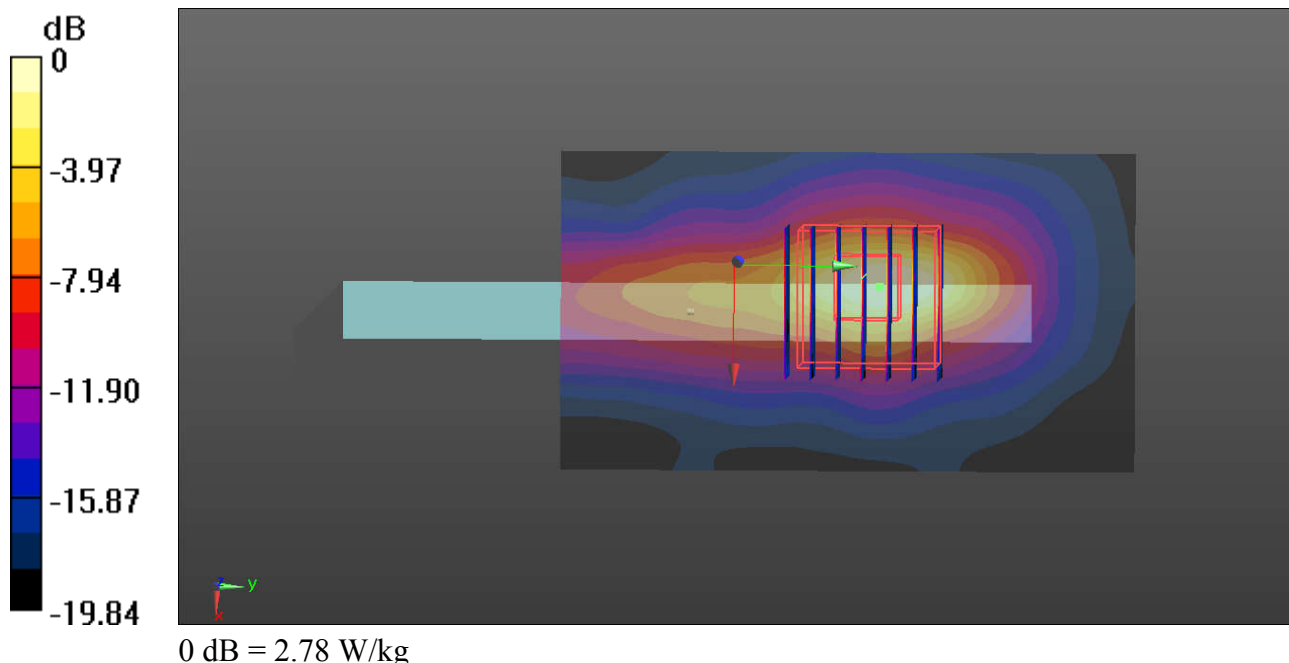

#15_Bluetooth_1Mbps_Bottom Face_0mm_Ch78

Communication System: UID 0, Bluetooth (0); Frequency: 2480 MHz; Duty Cycle: 1:1.2
Medium: MSL_2450_160803 Medium parameters used: $f = 2480$ MHz; $\sigma = 2.044$ S/m; $\epsilon_r = 52.15$; $\rho = 1000$ kg/m³
Ambient Temperature : 23.3 °C; Liquid Temperature : 22.9 °C

DASY5 Configuration:

- Probe: EX3DV4 - SN3911; ConvF(7.34, 7.34, 7.34); Calibrated: 2015.10.01;
- Sensor-Surface: 2mm (Mechanical Surface Detection)
- Electronics: DAE4 Sn917; Calibrated: 2015.12.14
- Phantom: ELI v5.0(Right); Type: QDOVA001BB; Serial: TP:1225
- Measurement SW: DASY52, Version 52.8 (8); SEMCAD X Version 14.6.10 (7331)

Ch78/Area Scan (111x71x1): Interpolated grid: dx=12mm, dy=12mm
Maximum value of SAR (interpolated) = 0.541 W/kg

Ch78/Zoom Scan (7x7x7)/Cube 0: Measurement grid: dx=5mm, dy=5mm, dz=5mm
Reference Value = 0 V/m; Power Drift = 0.05 dB
Peak SAR (extrapolated) = 0.830 W/kg
SAR(1 g) = 0.315 W/kg; SAR(10 g) = 0.126 W/kg
Maximum value of SAR (measured) = 0.559 W/kg

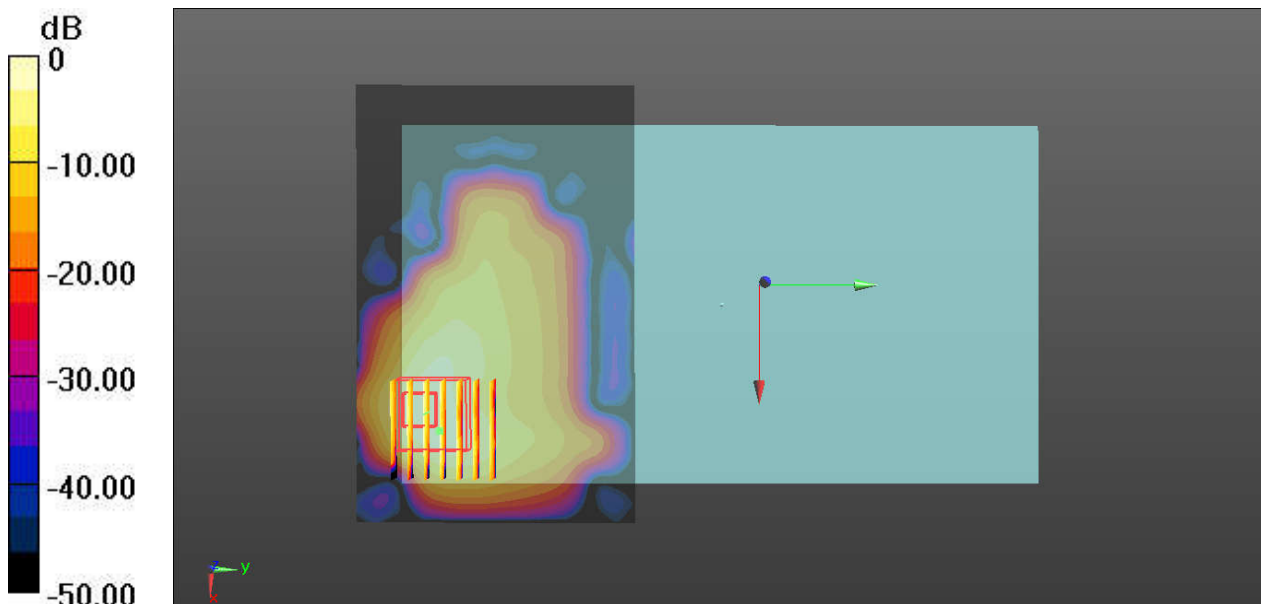

0 dB = 0.541 W/kg



Appendix C. DASYS Calibration Certificate

The DASYS calibration certificates are shown as follows.



Accredited by the Swiss Accreditation Service (SAS)
The Swiss Accreditation Service is one of the signatories to the EA
Multilateral Agreement for the recognition of calibration certificates

Accreditation No.: **SCS 0108**

Client **Sporton-SZ (Auden)**

Certificate No: **D750V3-1099_Nov15**

CALIBRATION CERTIFICATE

Object **D750V3 - SN: 1099**

Calibration procedure(s) **QA CAL-05.v9
Calibration procedure for dipole validation kits above 700 MHz**

Calibration date: **November 24, 2015**

This calibration certificate documents the traceability to national standards, which realize the physical units of measurements (SI).
The measurements and the uncertainties with confidence probability are given on the following pages and are part of the certificate.

All calibrations have been conducted in the closed laboratory facility: environment temperature (22 ± 3)°C and humidity < 70%.

Calibration Equipment used (M&TE critical for calibration)

Primary Standards	ID #	Cal Date (Certificate No.)	Scheduled Calibration
Power meter EPM-442A	GB37480704	07-Oct-15 (No. 217-02222)	Oct-16
Power sensor HP 8481A	US37292783	07-Oct-15 (No. 217-02222)	Oct-16
Power sensor HP 8481A	MY41092317	07-Oct-15 (No. 217-02223)	Oct-16
Reference 20 dB Attenuator	SN: 5058 (20k)	01-Apr-15 (No. 217-02131)	Mar-16
Type-N mismatch combination	SN: 5047.2 / 06327	01-Apr-15 (No. 217-02134)	Mar-16
Reference Probe EX3DV4	SN: 7349	30-Dec-14 (No. EX3-7349_Dec14)	Dec-15
DAE4	SN: 601	17-Aug-15 (No. DAE4-601_Aug15)	Aug-16
Secondary Standards	ID #	Check Date (in house)	Scheduled Check
RF generator R&S SMT-06	100972	15-Jun-15 (in house check Jun-15)	In house check: Jun-18
Network Analyzer HP 8753E	US37390585 S4206	18-Oct-01 (in house check Oct-15)	In house check: Oct-16

Calibrated by: **Name** Claudio Leubler **Function** Laboratory Technician

Signature

Approved by: **Name** Katja Pokovic **Function** Technical Manager

Issued: November 24, 2015

This calibration certificate shall not be reproduced except in full without written approval of the laboratory.