

Panasonic[®]

Operating Instructions Digital Wireless Stereo Headphones

Model No. **RP-HD610N**



Qualcomm[®]
aptX[™] HD



Google Assistant



Thank you for purchasing this product.

Please read these instructions carefully before using this product, and save this manual for future use.

Safety precautions

■ Unit

WARNING:

To reduce the risk of fire, electric shock or product damage,

- Do not expose this unit to rain, moisture, dripping or splashing.
- Do not place objects filled with liquids, such as vases, on this unit.
- Use the recommended accessories.
- Do not remove covers.
- Do not repair this unit by yourself. Refer servicing to qualified service personnel.

Avoid the use in the following conditions

- High or low extreme temperatures during use, storage or transportation.
 - Disposal of a battery into fire or a hot oven, or mechanically crushing or cutting of a battery, that can result in an explosion.
 - Extremely high temperature and/or extremely low air pressure that can result in an explosion or the leakage of flammable liquid or gas.
- Avoid using or placing this unit near sources of heat.
 - Do not listen with this unit at high volume in places where you need to hear sounds from the surrounding environment for safety, such as at railroad crossings, and construction sites.
 - Wide band characteristic voltage equal or larger than 75 mV.
 - Keep this unit away from something susceptible to the magnetism. Such devices as a clock may not operate correctly.
 - When using this unit in an airplane, heed the instructions given by the airline company. Some airlines may forbid your using the unit. For further details, contact the airline you will be flying with.

■ Allergies

- Discontinue use if you experience discomfort with the ear pads or any other parts that directly contact your skin.
- Continued use may cause rashes or other allergic reactions.

■ Precautions for listening with the Headphones

- Excessive sound pressure from earphones and headphones can cause hearing loss.
- Do not use your headphones at a high volume. Hearing experts advise against continuous extended play.
- If you experience a ringing in your ears, reduce volume or discontinue use.
- Do not use while operating a motorised vehicle. It may create a traffic hazard and is illegal in many areas.
- You should use extreme caution or temporarily discontinue use in potentially hazardous situations.

This unit may receive radio interference caused by mobile telephones during use. If such interference occurs, please increase separation between this unit and the mobile telephone.

Keep the airplane adaptor out of reach of children to prevent swallowing.

Use only the supplied USB charging cord when connecting to a computer.

This unit is intended for use in moderate and tropical climates.

About Bluetooth®

Panasonic bears no responsibility for data and/or information that is compromised during a wireless transmission.

■ Frequency band used

This unit uses the 2.4 GHz frequency band.

■ Certification of this unit

- This unit conforms to frequency restrictions and has received certification based on frequency laws. Thus, a wireless permit is not necessary.
- The actions below are punishable by law in some countries:
 - Taking apart/modifying this unit.
 - Removing specification indications.

■ Restrictions of use

- Wireless transmission and/or usage with all Bluetooth® equipped devices is not guaranteed.
- All devices must conform to standards set by Bluetooth SIG, Inc.
- Depending on the specifications and settings of a device, it can fail to connect or some operations can be different.
- This unit supports Bluetooth® security features. But depending on the operating environment and/or settings, this security may not be sufficient. Transmit data wirelessly to this unit with caution.
- This unit cannot transmit data to a Bluetooth® device.

■ Range of use

Use this unit at a maximum range of 10 m.

The range can decrease depending on the environment, obstacles or interference.

■ Interference from other devices

- This unit may not function properly and troubles such as noise and sound jumps may arise due to radio wave interference if this unit is located too close to other Bluetooth® devices or the devices that use the 2.4 GHz band.
- This unit may not function properly if radio waves from a nearby broadcasting station, etc. is too strong.

■ Intended usage

- This unit is for normal, general use only.
- Do not use this system near an equipment or in an environment that is sensitive to radio frequency interference (example: airports, hospitals, laboratories, etc).

Table of contents

Safety precautions	2
About Bluetooth®	3

Before use

Accessories	5
Maintenance.....	5
Part names.....	6

Preparation

Charging.....	7
Turning the power on/off	7
Connecting a Bluetooth® device.....	8
• Pairing (Registration) this unit with the Bluetooth® device for connection	8
• Connecting a paired Bluetooth® device	9

Operation

Listening to music	10
• Remote controlling.....	10
Making a phone call	11
Using noise cancelling	12
Using the Google Assistant.....	13
Using the app “Panasonic Audio Connect”	15
Useful functions.....	16
• Activating voice functions	16
• Guidance messages.....	16
• Using the ambient sound enhancer.....	17
• Making a multi-point connection	18
• Battery level notification.....	19
• Auto power off	19
• Using the detachable cord (supplied).....	19
• Resetting the unit	19

Other

Storage of the unit	20
Restoring to the factory settings.....	21
Copyright, etc.	21
Troubleshooting.....	22
• Sound and audio volume.....	22
• Bluetooth® device connection	22
• Phone Calls	22
• General.....	23
• Power supply and charging	23
• Google Assistant	23
• Guidance messages.....	23
Specifications	24
To remove the battery when disposing of this unit	25

Expressions used in this document

- Pages to be referred to are indicated as “→ ○○”.
- The product illustrations may differ from the actual product.

Accessories

Please check and identify the supplied accessories.

1 x USB charging cord

1 x Detachable cord

1 x Carrying case



1 x Airplane adaptor

Maintenance

Clean this unit with a dry and soft cloth.

- Do not use solvents including benzine, thinner, alcohol, kitchen detergent, a chemical wiper, etc. This might cause the exterior case to be deformed or the coating to come off.

Keeping the battery performance

- During the long period of disuse, full charge this unit once every 6 months to keep the battery performance.

Part names

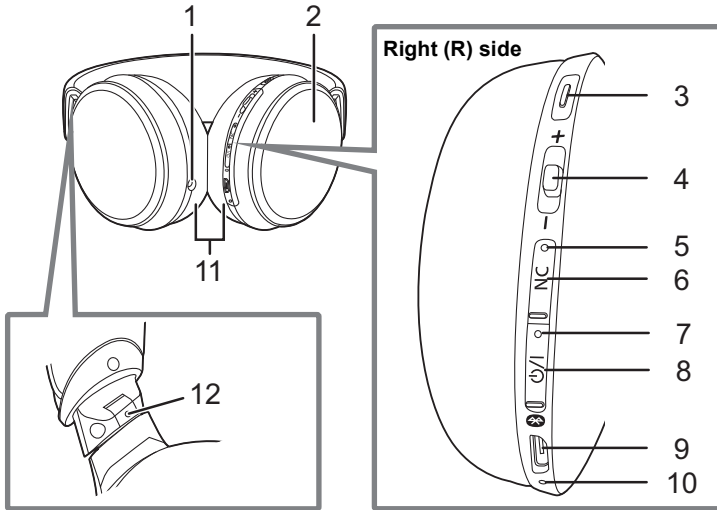

- 1 Audio input terminal
- 2 Ambient sound enhancer sensor panel
- 3 Action button
 - This allows you to operate the Google Assistant. (→ 13, "Using the Google Assistant")
- 4 Multiple functions button
 - You can perform a wide variety of operations by pressing this button or moving it toward the "+" or "-" side. (→ 10, "Remote controlling")
- 5 Noise cancelling LED^{*1}
- 6 [NC] (Noise cancelling) button (→ 12, "Using noise cancelling", → 17, "Using the ambient sound enhancer")
- 7 Power/pairing LED^{*2}
- 8 [⏻/⏻] button^{*3}
- 9 Charging terminal (DC IN)
 - Connect the USB charging cord (supplied) to this terminal when charging. (→ 7, "Charging")
- 10 Microphone
- 11 Ear pads
- 12 Raised dot indicating the left side

*1 Examples of lighting/blinking patterns

Lighting (green):	Noise cancelling is ON
-------------------	------------------------

*2 Examples of lighting/blinking patterns

Lighting (red):	Charging is in progress
Blinking alternately in blue and red:	Bluetooth® pairing (registration) standby
Blinking slowly (blue) ^{*4} :	Bluetooth® connection standby
Blinking twice about every 2 seconds (blue) ^{*4} :	A Bluetooth® pairing (registration) has been established or a call is in progress
Blinking (blue) ^{*4} :	A call is being received

*3 ⏻/⏻: Standby/ON

*4 The battery is low when it is blinking in red. (→ 19, "Battery level notification")

Charging

The rechargeable battery (installed in the unit) is not charged initially. Charge the battery before using the unit.

Connect this unit to a computer using the USB charging cord.

- A:** Power/pairing LED
 - B:** USB charging cord (supplied)
 - Check the direction of the terminals and plug in/out straight holding onto the plug. (It may result in malfunction by the deforming of the terminal if it is plugged in obliquely or in wrong direction.)
 - C:** Computer
 - Turn on the computer in advance.
- The power/pairing LED lights in red when charging is in progress. When charging is completed, the power/pairing LED will go out.
 - It takes approx. 4 hours to charge the battery from empty to full.

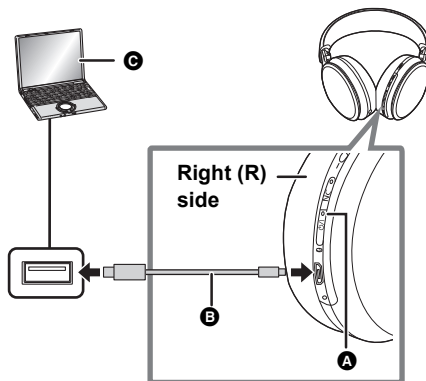

Note

- Charge in a room temperature between 10 °C and 35 °C. Outside of this temperature range, charging may stop and the power/pairing LED may go out.
- It is not possible to turn the power on or connect to Bluetooth® devices during charging.
- Do not use any other USB charging cords except the supplied one. Doing so may cause malfunction.
- Charging may not be performed or may stop if the computer is in or switched to standby or sleep mode.

Turning the power on/off

In the power-off state, press and hold [**⏻** / **⏸**] of this unit for approx. 3 seconds until the power/pairing LED (blue) blinks.

- A beep will sound, and the power/pairing LED (blue) will blink slowly.

■ To turn the power off

Press and hold [**⏻** / **⏸**] for approximately 3 seconds. An English guidance message will be heard, and the power will be turned off.

- It is possible to switch the language of the audio guidance. (→ 16, "Guidance messages")

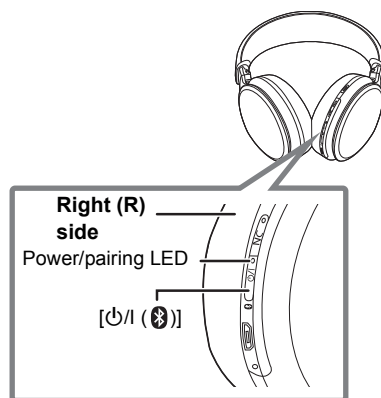

Note

- If the unit is not connected to a Bluetooth® device, an English guidance message will be heard and turn off the unit automatically approximately 5 minutes after you have stopped using it. (Except for when noise cancelling is turned ON.) (→ 19, "Auto power off")
- It is possible to switch the language of the audio guidance. (→ 16, "Guidance messages")

Connecting a Bluetooth® device

Preparation

- Place the Bluetooth® device within approx. 1 m from the unit.
- Check the device operation using its operation instructions as required.

Pairing (Registration) this unit with the Bluetooth® device for connection

When using the Google Assistant, refer to “Using the Google Assistant” (→ 13) before performing the following settings.

1 In the power-off state, press and hold [⏻/Ⓜ] of this unit until the power/pairing LED blinks.

When pairing a device for the first time: approx. 3 seconds

When pairing a second or subsequent devices: approx. 5 seconds

- The unit starts to search for the Bluetooth® device for connection, and the power/pairing LED will blink in blue and red alternately.

2 Turn on the power of the Bluetooth® device, and enable the Bluetooth® function.

3 Select “RP-HD610N” from the Bluetooth® device’s menu.

- A MAC address (an alphanumeric character string that is displayed by and unique to the device) may be displayed before “RP-HD610N” is displayed.
- If prompted for a passkey, input the passkey “0000 (four zeros)” of this unit.

e.g.

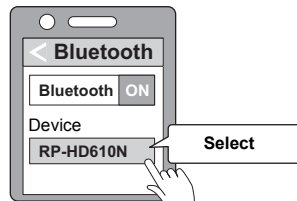

4 Check the connection with the Bluetooth® device on the unit.

- The power/pairing LED will blink in blue and red alternately until the connection with the device is completed. When the power/pairing LED (blue) blinks twice every approx. 2 seconds, pairing (registration) is completed. (Connection established)

Note

- If connection to a device is not established within approximately 5 minutes, the unit will be turned off. Perform pairing again. (Except for when noise cancelling is turned ON.)
- You can pair up to 8 Bluetooth® devices with this unit. If a 9th device is paired, the device with the oldest connection will be replaced. To use it, perform pairing again.

Connecting a paired Bluetooth® device

1 Turn on this unit.

- Press and hold [⏻/Ⓜ (🔊)] of this unit for approx. 3 seconds until the power/pairing LED (blue) blinks.
- A beep will sound, and the power/pairing LED (blue) will blink slowly.

2 Perform steps 2 and 3 of “Pairing (Registration) this unit with the Bluetooth® device for connection”. (→ 8)

- When the power/pairing LED (blue) blinks twice every approx. 2 seconds, pairing (registration) is completed. (Connection established)

Note

- This unit remembers the device lastly connected. Connection may be automatically established after step 1 (see above).
- If connection to a device is not established within approximately 5 minutes, the unit will be turned off. Turn on the unit again. (Except for when noise cancelling is turned ON.)

Listening to music

If the Bluetooth® compatible device supports the “A2DP” and “AVRCP” Bluetooth® profiles, music can be played back with remote control operations on the unit.

- A2DP (Advanced Audio Distribution Profile): Transmits audio to the unit.
- AVRCP (Audio/Video Remote Control Profile): Allows remote control of the device using the unit.

1 Connect the Bluetooth® device and the unit. (→ 8, “Connecting a Bluetooth® device”)

2 Select and play the music on the Bluetooth® device.

- The unit’s headphones will output the music or the audio of the video being played back.
- Operating time:
The maximum playback time is approximately 24 hours. (It may become shorter depending on the usage conditions.)

■ Attention

- The unit might leak sound depending on the volume level.
- When the volume is increased to near maximum level, music may sound distorted. Decrease the volume until the distortion is cleared.

Remote controlling

You can control the Bluetooth® device using the Multiple functions button on the unit.

- Depending on the Bluetooth® device or the app, even if you press the Multiple functions button on the unit, some functions may not respond or may operate differently from the descriptions below.

(Operation example of the Multiple functions button)

Right (R) side

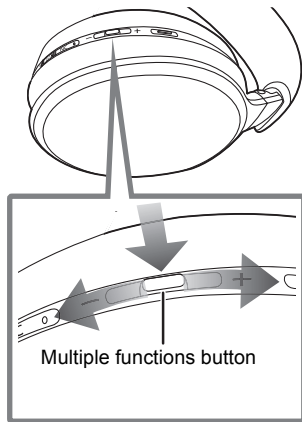

Function	Operation
Play / Pause	Press the Multiple functions button.
Increase the volume	Slide the Multiple functions button towards “+”. • Sliding and holding towards “+” allows you to continuously raise the volume.
Decrease the volume	Slide the Multiple functions button towards “-”. • Sliding and holding towards “-” allows you to continuously lower the volume.
Skip forward	Press the Multiple functions button twice quickly.
Skip backward	Press the Multiple functions button three times quickly.
Fast forward	Press the Multiple functions button twice quickly; hold the second press.
Fast rewind	Press the Multiple functions button three times quickly; hold the third press.

Note

- The volume can be adjusted in 31 levels (16 levels during calls). When the maximum or minimum volume is reached, a beep will sound.

Making a phone call

With Bluetooth® enabled phones (cell phones or smartphones) that support the “HSP” or “HFP” Bluetooth® profile, you can use the unit for phone calls.

- **HSP (Headset Profile):**

This profile can be used to receive monaural sounds and establish two-way communication using the microphone on the unit.

- **HFP (Hands-Free Profile):**

In addition to the HSP functions, this profile has the incoming and outgoing calls function.

(This unit does not have a function that allows you to make phone calls independently of a Bluetooth® enabled phone.)

1 Connect the Bluetooth® device and the unit. (→ 8, “Connecting a Bluetooth® device”)

2 Press the Multiple functions button on the unit and answer the incoming call.

Multiple functions
button

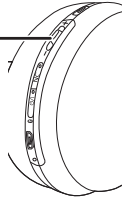

- During an incoming call, ringtone will sound from the unit and the power/pairing LED will blink.
- (HFP only) To reject the incoming call, press the Multiple functions button twice quickly.

3 Start talking.

- The power/pairing LED will repeatedly blink 2 times during a call.
- The volume can be adjusted during a phone call. For setting instructions, see page 10.

4 Press the Multiple functions button to end the phone call.

- A beep will sound.

Note

- There may be instances when hands free setting needs to be done on the Bluetooth® enabled phone.
- Depending on the Bluetooth® enabled phone, you may hear incoming and outgoing call ringtones of the phone from the unit.
- (HFP only) It may be difficult to hear phone conversations when the unit is used in locations with loud ambient noise or in outdoor or other locations exposed to powerful winds. In that case, change the calling location or switch the calling device to the Bluetooth® enabled phone to continue the call. (Press the Multiple functions button on the unit twice quickly to switch.)
- You can have the Bluetooth® enabled phone make phone calls by using the microphone of the unit and an app of the Bluetooth® enabled phone. (→ 16, “Activating voice functions”)

Using noise cancelling

While using the noise cancelling function, changes the volume and sound quality. The sound quality is set so that it is optimised for each level.

■ About noise cancelling level

You can select one of the following levels to suit your preference.

- The default level setting is “Noise cancelling High”.
 - Noise cancelling High
 - Noise cancelling Medium
 - Noise cancelling Low

1 Press [NC].

- Each press of [NC] switches between three levels and Off.
 - “Noise cancelling High” → “Noise cancelling Medium”
 - ↑
 - “Noise cancelling Off” ← “Noise cancelling Low”
 - ↓
- While using the noise cancelling function, the noise cancelling LED lights in green.



2 Adjust the volume of the playback device.

Note

- While using the noise cancelling function, a very small amount of noise which is generated from the circuit that reduces noise may be heard, but this is normal and not indicative of any trouble. (This very-low-level noise may be heard in quiet places or in the blank parts between tracks.)
- If [NC] is pressed for at least approx. 2 seconds, the audio guidance will announce the current level.
- It is possible to switch the language of the audio guidance. (→ 16, “Guidance messages”)

Using the Google Assistant

You can play back music or look for information by talking to this unit to operate a smartphone or tablet (Android™ 5.0+/iOS 9.3 or higher) equipped with the Google Assistant.

• Connect the smartphone or tablet to the Internet. This unit cannot be connected to the Internet directly.

■ Before the first use, the following settings are required.

• When using an iOS smartphone or tablet, install the Google Assistant app in advance.

1 Create a Bluetooth® connection.	Create a Bluetooth® connection between the smartphone or tablet and this unit. (→ 8, "Connecting a Bluetooth® device")
2 Complete the headphone setup.	Start up the Google Assistant on the smartphone or tablet, and then follow the instructions on the smartphone or tablet screen to complete the headphone setup.* • When using an iOS device, follow the on-screen instructions to perform initial setup, such as creating and logging into a Google account.

■ If you encounter trouble with the setup, try the following:

- Turn the unit off and on.
- Retry the Bluetooth® pairing (registration).
- Turn the smartphone or tablet off and on, and then start up the Google Assistant again.

* If a setting window about notifications is displayed, allow sending of notifications to receive them from the Google Assistant.
 If a setting window about microphone access is displayed, allow the access.

For more details about the Google Assistant, refer to the site below.
<https://support.google.com/headphones>



How to use the Google Assistant

- Before use, create a Bluetooth® connection with the smartphone or tablet.
- When using an iOS smartphone or tablet, start up the Google Assistant.

Use	Operation
Operating the Google Assistant by voice	Speak while pressing and holding the Action button. (Release your finger when you finish speaking.) Examples: “Play some pop music”, “Do I need an umbrella today?” • You are not required to say, “Ok Google”.
Checking notification contents	Press the Action button once.
Stopping the Google Assistant from making announcements	Press the Action button twice.
Responding to notifications by voice (if supported)	After receiving a notification, speak while pressing and holding the Action button. (Release your finger when you finish speaking.)

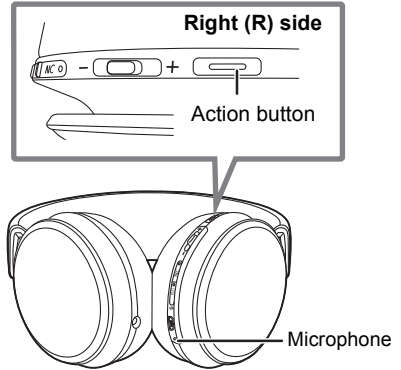

Note

- Always use the latest version of the Google Assistant.
- The Google Assistant function may not be available in some languages, countries or regions.
- Services offered through the service operator may be changed or terminated without notice at the discretion of their provider companies. Panasonic is not liable for any damages or losses resulting from changes to or termination of such services.

Using the app “Panasonic Audio Connect”

By creating a Bluetooth® connection with a smartphone or tablet installed with the “Panasonic Audio Connect” app (free of charge), you can enjoy a wide variety of features, such as the following:

- Software updates
You can add new functions, etc.
- Customization of various settings
Connection mode setting/Noise canceling setting/Auto power off setting/Guidance language setting, etc.
- Access to this document

Preparation

- Turn on the unit.

1 Download the “Panasonic Audio Connect” app (free of charge) to the smartphone or tablet.



Android:
Google Play



iOS:
App Store



2 Start up the “Panasonic Audio Connect” app.

- Follow the on-screen instructions to operate.

Note

- Always use the latest version of the “Panasonic Audio Connect” app.

Useful functions

Activating voice functions

You can use a button on this unit to activate Siri or other voice functions on your smartphone or similar device.

- 1 Connect the Bluetooth® device and the unit. (→ 8, “Connecting a Bluetooth® device”)**
- 2 Press and hold the Multiple functions button on this unit until the voice function is activated.**

Note

- For details about voice function commands, refer to the operating instructions for the Bluetooth® device.
- The voice function may not work depending on the smartphone, etc., specifications and the app version.

Guidance messages

The unit is equipped with an a function that provides an audio notification when you turn off the unit, connect a Bluetooth® device or change a setting, for example.

- This unit has messages for the following languages for the audio guidance.
English/German/French/Japanese
- The audio guidance function cannot be disabled.
- The audio guidance volume cannot be adjusted.

■ Switching the audio guidance language

Slide and hold the Multiple functions button towards “-” and at the same time press and hold [⏻/Ⓜ (Ⓜ)] for at least 5 seconds.

- The language is switched one at a time each time this operation is performed.

Using the ambient sound enhancer

This makes it easier to listen to sounds around you, such as announcements on trains, when you want to, without taking the unit off.

Place your hand over the ambient sound enhancer sensor panel (R side) so that its entire surface is covered.

- This makes it easier to listen to sounds around you.
- Noise cancelling will turn OFF temporarily and the volume of the playback sound will be lowered.

The noise cancelling level and the volume return to their original settings when your hand is removed.

■ To switch this function between enabled and disabled

Slide and hold the Multiple functions button towards “+” and at the same time press and hold [NC] for at least 5 seconds.

- When the status is changed to enabled, the power/pairing LED (blue) will light for approx. 2 seconds.

When the status is changed to disabled, the power/pairing LED (red) will light for approx. 2 seconds.

■ To set this function to always-on mode

Press [NC] button twice quickly.

- To deactivate always-on mode, press the [NC] button, or place your hand over the ambient sound enhancer sensor panel (R side) so that its entire surface is covered and then move the hand away.

Note

- The ambient sound enhancer works only while the unit is turned on.

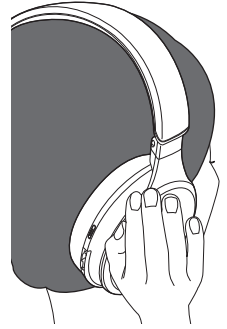

Making a multi-point connection

A Bluetooth® device for music playback and calls (first device) and a Bluetooth® device for calls (second device) can be connected simultaneously.

For example, even when listening to music on the first Bluetooth® device, you can answer calls received on the second Bluetooth® device by setting up the devices as follows.

For information about the connection and registration of Bluetooth® devices and the unit (→ 8, “Connecting a Bluetooth® device”)

- 1 Register the unit to both the first Bluetooth® device and the second Bluetooth® device.**
- 2 Connect the first Bluetooth® device, which will be used for music playback, and the unit.**
 - Be sure to connect the Bluetooth® device for music playback first.
- 3 Connect the second Bluetooth® device, which will be used for calls, and the unit.**

Note

- For more details, including more specific setup instructions, refer to the operating instructions for the Bluetooth® devices.
- Only one Bluetooth® device can be connected for music playback.
- When not playing back music on a device running an Android OS, etc., disable the “A2DP” setting.
- You can also connect a Bluetooth® device without call functions as the first device to use it for music playback.
- This unit cannot play back music on any Bluetooth® device connected as the second device.
- This unit memories the last-connected Bluetooth® device. It may connect automatically to reconnect. When reconnecting with the multi-point connection function, turn off the power or Bluetooth® of other Bluetooth® devices until the Bluetooth® device to be used for music playback is reconnected.
- When multi-point connection is being used, depending on the Bluetooth® device that is connected, you may be unable to use the Google Assistant.

Battery level notification

- When the unit is turned off, an English guidance message will be heard indicating the battery level.
- When the battery starts running low during use of the unit, the blinking power/pairing LED will turn from blue to red. A beep will sound every 1 minute.* When the battery runs out, an English guidance message will be heard and the power will turn off.
- * If you press [⏻/| (Ⓜ)] twice quickly, an English guidance message will be heard and you can check the battery level.
- It is possible to switch the language of the audio guidance. (→ 16, "Guidance messages")

Auto power off

If the unit is not connected to a Bluetooth® device, an English guidance message will be heard and turn off the unit automatically approximately 5 minutes after you have stopped using it.

- It is possible to switch the language of the audio guidance. (→ 16, "Guidance messages")
- Auto power off does not work when noise cancelling is turned ON.
- Auto power off does not work when the detachable cord (supplied) is connected.

Using the detachable cord (supplied)

While the unit is turned off, it can be used as normal headphones by connecting the detachable cord (supplied).

- Before connecting the detachable cord (supplied), lower the volume on the connected device.
- If you connect the detachable cord (supplied) during Bluetooth® connection, the Bluetooth® connection will be lost.
- The Multiple functions button does not work even while the unit is turned on.
- Noise may occur due to dirt on the plug. Clean the plug with a soft dry cloth if this occurs.
- Do not use any other detachable cords except the supplied one.

■ To connect to an airplane audio system

- 1 **Connect the unit and the detachable cord (supplied). (A)**
- 2 **Connect the input plug (B) of the detachable cord (supplied) to the airplane adaptor (supplied) (C).**
- 3 **Connect the airplane adaptor to the in-airplane audio system. (D)**

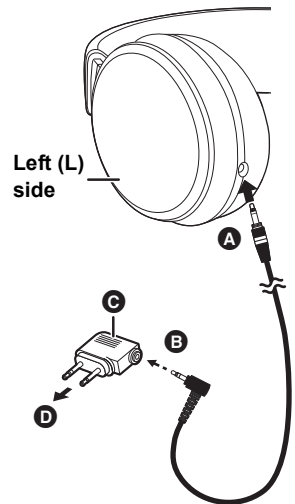

Note

- The airplane adaptor may not fit the jacks in some in-airplane audio systems.

Resetting the unit

This unit can be reset when all operations are rejected. To reset the unit, connect the unit to a computer using the USB charging cord. All the previous operations will be cancelled. (The pairing device information will not be deleted.)

Storage of the unit

Fold the unit as shown below when storing it in the carrying case (supplied).

• If the USB charging cord or the detachable cord (supplied) is connected, disconnect it from the unit.

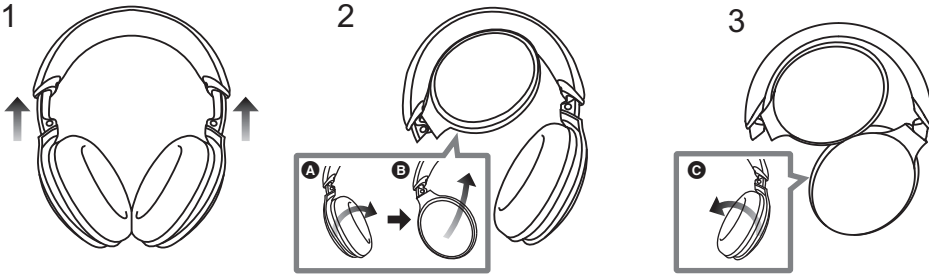

- 1** Store the sliders.
- 2** Rotate the housing on either side by approx. 90° (A) to fold it toward the headband side (B).
- 3** Rotate the other housing by approx. 90° (C).
- 4** Store the unit in the carrying case.

Restoring to the factory settings

When you want to delete all pairing device information, etc., you can restore the unit to the factory settings (original settings upon purchase). Charge the battery before restoring the unit.

- 1 While the unit is turned off, press and hold [⏻/Ⓜ (Ⓜ)] for at least 5 seconds until the power/pairing LED starts blinking alternately in blue and red.**
- 2 While the power/pairing LED is blinking alternately in blue and red, slide and hold the Multiple functions button towards “+” and at the same time press and hold [⏻/Ⓜ (Ⓜ)] for at least 5 seconds.**
 - The default settings will be restored after the power/pairing LED (blue) blinks fast and the unit turns off.

■ Attention

- When pairing a device again, delete the registering information (Device: “RP-HD610N”) from the Bluetooth® device’s menu, and register this unit with the Bluetooth® device again. (→ 8)

Copyright, etc.

The Bluetooth® word mark and logos are registered trademarks owned by Bluetooth SIG, Inc. and any use of such marks by Panasonic Corporation is under license.

Other trademarks and trade names are those of their respective owners.

Apple, the Apple logo and Siri are trademarks of Apple Inc., registered in the U.S. and other countries. App Store is a service mark of Apple Inc.

Google, Android, Google Play, and other related marks and logos are trademarks of Google LLC.

LDAC and LDAC logo are trademarks of Sony Corporation.

Qualcomm aptX is a product of Qualcomm Technologies, Inc. and/or its subsidiaries.

Qualcomm is a trademark of Qualcomm Incorporated, registered in the United States and other countries. aptX is a trademark of Qualcomm Technologies International, Ltd., registered in the United States and other countries.

Other system names and product names appearing in this document are in general the registered trademarks or trademarks of the respective developer companies.

Note that the ™ mark and ® mark do not appear in this document.

Certification information (a) can be found on the right side of the headphones. Remove the right ear pad to see it. (1) To attach the ear pad, align the four tabs (b, c), and push the ear pad in until a clicking sound is heard to lock it into place. (2)

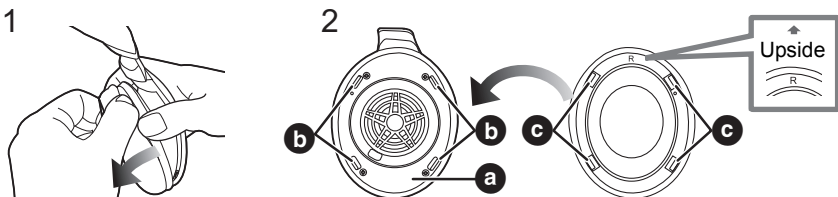

Troubleshooting

Before requesting service, make the following checks. If you are in doubt about some of the check points, or if the remedies indicated do not solve the problem, consult your dealer for instructions.

Sound and audio volume

No sound.

- Make sure that the unit and the Bluetooth® device are connected correctly. (→ 8)
- Check if music is playing on the Bluetooth® device.
- Make sure that the unit is turned on and the volume is not set too low.
- Pair and connect the Bluetooth® device and the unit again. (→ 8)
- Check if the Bluetooth® compatible device supports "A2DP" profile. For details on profiles, see "Listening to music" (→ 10). Also refer to the operating manual for the Bluetooth® compatible device.

Cannot adjust the volume.

- Is the ambient sound enhancer operating? Turn off the ambient sound enhancer. (→ 17)
- The Multiple functions button does not work when the detachable cord (supplied) is used.

Low volume.

- Is the ambient sound enhancer operating? Turn off the ambient sound enhancer. (→ 17)
- Increase the volume of the unit. (→ 10)
- Increase the volume on the Bluetooth® device.

Sound from the device is cut off. / Too much noise. / Sound quality is bad.

- Sound may be disrupted if signals are blocked. Do not fully cover this unit with the palm of your hand, etc.
- The device may be out of the 10 m communication range. Move the device closer to this unit.
- Remove any obstacle between this unit and the device.
- Switch off any wireless LAN device when not in use.
- If the unit and the Bluetooth® device are connected via LDAC™, the problem may be solved by changing the sound quality mode on the Bluetooth® device to give priority to connection. For details, refer to the operating instructions for the Bluetooth® device.

Bluetooth® device connection

The device cannot be connected.

- You can pair up to 8 Bluetooth® devices with this unit. If a 9th device is paired, the device with the oldest connection will be replaced.
- Delete the pairing information for this unit from the Bluetooth® device, then pair them again. (→ 8)

Phone Calls

You cannot hear the other person.

- Make sure that the unit and the Bluetooth® enabled phone are turned on.
- Check if the unit and the Bluetooth® enabled phone are connected. (→ 8)
- Check the audio settings of the Bluetooth® enabled phone. Switch the calling device to the unit if it is set to the Bluetooth® enabled phone. (→ 8)
- If the volume of the other person's voice is too low, increase the volume of both the unit and the Bluetooth® enabled phone.

Cannot make a phone call.

- Check if the Bluetooth® compatible device supports "HSP" or "HFP" profile. For details on profiles, see "Listening to music" (→ 10) and "Making a phone call" (→ 11). Also refer to the operating manual for the Bluetooth® enabled phone.

General

The unit does not respond.

- This unit can be reset when all operations are rejected. To reset the unit, connect the unit to a computer using the USB charging cord. (→ 19)
- The Multiple functions button does not work when the detachable cord (supplied) is used.

Power supply and charging

Cannot charge the unit. / The power/pairing LED does not light during charging. / Charging takes longer.

- Is the USB charging cord connected firmly to the USB terminal of the computer? (→ 7)
- Make sure to charge in a room temperature between 10 °C and 35 °C.
- Make sure the computer is turned on and is not on standby or sleep mode.
- Is the USB port you are currently using working properly? If your computer has other USB ports, unplug the connector from its current port and plug it into one of the other ports.
- If the measures mentioned above are not applicable, unplug the USB charging cord and plug it in again.
- It takes approx. 4 hours to charge the battery from empty to full.
- If the charge time and operating time become shortened, the battery may have run down. (Number of charging times of the installed battery: Approximately 300)
- The power/pairing LED lights in red when charging is in progress. When charging is completed, the power/pairing LED will go out.

The power does not turn on. / The power turns off.

- Is the unit being charged? The power cannot be turned ON during charging. (→ 7)
- The battery is low when the power/pairing LED is blinking in red. Charge the unit.
- Is auto power off active? (→ 19)

Google Assistant

Cannot use the Google Assistant.

- De-register this unit on the Bluetooth® device first, reconnect, and then complete the headphone setup. (→ 13)
- Is the smartphone or tablet connected to the Internet?

Guidance messages

The audio guidance language has changed.

- The audio guidance language can be switched. (→ 16)

Specifications

■ General

Power supply	DC 5 V, 0.5 A (Internal battery: 3.7 V (Li-polymer))
Operating time ^{*1}	Approx. 24 hours (Noise cancelling: ON, SBC)
Charging time ^{*2} (25 °C)	Approx. 4 hours
Charging temperature range	10 °C to 35 °C
Operating temperature range	0 °C to 40 °C
Operating humidity range	35 %RH to 80 %RH (no condensation)
Mass	Approx. 275 g (without cord)

*1 It may be shorter depending on the operating conditions.

*2 The time required to charge the battery from empty to full.

■ Bluetooth® section

Bluetooth® system specification	Ver. 4.2
Wireless equipment classification	Class 2 (2.5 mW)
Max RF power	4 dBm
Frequency band	2402 MHz to 2480 MHz
Supported profiles	A2DP, AVRCP, HSP, HFP
Supported codec	SBC, AAC, Qualcomm® aptX™, Qualcomm® aptX™ HD, LDAC
Operating distance	Up to 10 m

■ Headphone section

Impedance	38 Ω (Power off, with cord)
Frequency response	4 Hz to 40000 Hz (with cord)

■ Speaker section

Driver units	40 mm
Max input	1000 mW (IEC)

■ Terminal section

DC IN	DC 5 V, 500 mA
--------------	----------------

■ Microphone section

Type	Mono
-------------	------

■ Accessory section

USB charging cord	Approx. 0.5 m
Detachable cord	Approx. 1.2 m
Carrying case	
Airplane adaptor	

• Specifications are subject to change without notice.

To remove the battery when disposing of this unit

The following instructions are not intended for repairing purposes but for the disposal of this unit. This unit is not restorable once disassembled.
 • When disposing of this unit, take out the battery installed in this unit and recycle it.

- Disassemble after the battery runs out.
- Keep disassembled parts out of reach of children.

Regarding the handling of used batteries

- Insulate the terminals with adhesive tape or similar material.
- Do not disassemble.

■ Batteries

- Do not heat or expose to flame.
- Do not leave the battery(ies) in a car exposed to direct sunlight for a long period of time with doors and windows closed.
- Battery mishandling can cause electrolyte leakage which can damage items the leaked fluid comes into contact with. If electrolyte leaks from the battery, consult your dealer. Wash thoroughly with water if electrolyte comes in contact with any part of your body.
- When disposing of the batteries, please contact your local authorities or dealer and ask for the correct method of disposal.

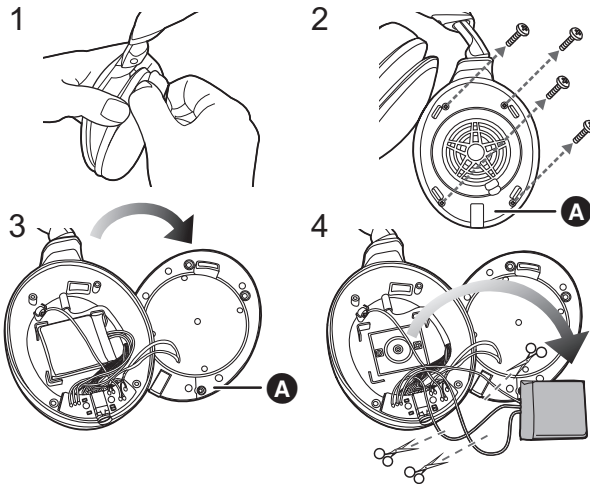

- 1 Remove the left ear pad.
- 2 Remove the 4 screws.
- 3 Remove the part **A** in step 2.
- 4 Remove the battery, and cut off the wires one by one with scissors.

Declaration of Conformity (DoC)

Hereby, "*Panasonic Corporation*" declares that this product is in compliance with the essential requirements and other relevant provisions of Directive 2014/53/EU.

Customers can download a copy of the original DoC to our RE products from our DoC server:

<http://www.ptc.panasonic.eu>

Contact to Authorised Representative:

Panasonic Marketing Europe GmbH,

Panasonic Testing Centre, Winsbergring 15, 22525 Hamburg, Germany

Type of wireless	Frequency band	Maximum power
Bluetooth®	2402 - 2480 MHz	4 dBm

Disposal of Old Equipment and Batteries**Only for European Union and countries with recycling systems**

These symbols on the products, packaging, and/or accompanying documents mean that used electrical and electronic products and batteries must not be mixed with general household waste. For proper treatment, recovery and recycling of old products and used batteries, please take them to applicable collection points in accordance with your national legislation.

By disposing of them correctly, you will help to save valuable resources and prevent any potential negative effects on human health and the environment.

For more information about collection and recycling, please contact your local municipality.

Penalties may be applicable for incorrect disposal of this waste, in accordance with national legislation.

**(Note for the battery symbol (bottom symbol)):**

This symbol might be used in combination with a chemical symbol. In this case it complies with the requirement set by the Directive for the chemical involved.

For the United Kingdom and Ireland customers

Sales and Support Information

Customer Communications Centre

- For customers within the UK: 0344 844 3899
- For customers within Ireland: 01 289 8333
- Monday–Friday 9:00 am–5:00 pm (Excluding public holidays).
- For further support on your product, please visit our website:
www.panasonic.co.uk

Direct Sales at Panasonic UK

- Order accessory and consumable items for your product with ease and confidence by phoning our Customer Communications Centre Monday–Friday 9:00 am–5:00 pm (Excluding public holidays).
- Or go on line through our Internet Accessory ordering application at www.pas-europe.com.
- Most major credit and debit cards accepted.
- All enquiries transactions and distribution facilities are provided directly by Panasonic UK.
- It couldn't be simpler!
- Also available through our Internet is direct shopping for a wide range of finished products. Take a browse on our website for further details.

Manufactured by: Panasonic Corporation
Kadoma, Osaka, Japan
Importer for Europe: Panasonic Marketing Europe GmbH
Panasonic Testing Centre
Winsbergring 15, 22525 Hamburg, Germany



Panasonic Corporation

<http://www.panasonic.com>

© Panasonic Corporation 2019

(En)

TQBM0397
F0519SK1099