



HP EliteBook Folio G1 Notebook PC

Maintenance and Service Guide

© Copyright 2016, 2017 HP Development Company, L.P.

AMD is a trademark of Advanced Micro Devices, Inc. Bluetooth is a trademark owned by its proprietor and used by HP Inc. under license. Intel, Celeron, and Pentium are trademarks of Intel Corporation in the U.S. and other countries. Microsoft and Windows are trademarks of the Microsoft group of companies.

The information contained herein is subject to change without notice. The only warranties for HP products and services are set forth in the express warranty statements accompanying such products and services. Nothing herein should be construed as constituting an additional warranty. HP shall not be liable for technical or editorial errors or omissions contained herein.

Third Edition: October 2017

Second Edition: November 2016

First Edition: March 2016

Document Part Number: 841756-003

Product notice

This user guide describes features that are common to most models. Some features may not be available on your computer.

Not all features are available in all editions of Windows. This computer may require upgraded and/or separately purchased hardware, drivers and/or software to take full advantage of Windows functionality. Go to <http://www.microsoft.com> for details.

Software terms

By installing, copying, downloading, or otherwise using any software product preinstalled on this computer, you agree to be bound by the terms of the HP End User License Agreement (EULA). If you do not accept these license terms, your sole remedy is to return the entire unused product (hardware and software) within 14 days for a full refund subject to the refund policy of your seller.

For any further information or to request a full refund of the price of the computer, please contact your seller.

This computer may require upgraded and/ or separately purchased hardware and/or a DVD drive to install the Windows 7 software and take full advantage of Windows 7 functionality. See <http://windows.microsoft.com/en-us/windows7/get-know-windows-7> for details.

Safety warning notice

 **WARNING!** To reduce the possibility of heat-related injuries or of overheating the device, do not place the device directly on your lap or obstruct the device air vents. Use the device only on a hard, flat surface. Do not allow another hard surface, such as an adjoining optional printer, or a soft surface, such as pillows or rugs or clothing, to block airflow. Also, do not allow the AC adapter to contact the skin or a soft surface, such as pillows or rugs or clothing, during operation. The device and the AC adapter comply with the user-accessible surface temperature limits defined by the International Standard for Safety of Information Technology Equipment (IEC 60950-1).

Table of contents

1 Product description	1
2 External component identification	4
Display	4
Top	5
TouchPad	5
Lights	6
Button	7
Action keys	8
Using the action keys	9
Left	10
Right	11
Bottom	12
Labels	13
3 Illustrated parts catalog	14
Computer major components	14
Mass storage devices	16
Miscellaneous parts	16
4 Removal and replacement procedures preliminary requirements	19
Tools required	19
Service considerations	19
Plastic parts	19
Cables and connectors	19
Drive handling	20
Grounding guidelines	20
Electrostatic discharge damage	20
Packaging and transporting guidelines	21
Workstation guidelines	21
5 Removal and replacement procedures for Authorized Service Provider parts	23
Component replacement procedures	23
Bottom cover	23
Battery	25
SSD drive	26

Speaker assembly	27
Audio board	28
TouchPad	29
System board	30
Display assembly	32
Keyboard	37
Thermal solution kit	39

6 Computer Setup (BIOS), TPM, and HP Sure Start in Windows 10 43

Using Computer Setup	43
Starting Computer Setup	43
Navigating and selecting in Computer Setup	43
Restoring factory settings in Computer Setup	44
Updating the BIOS	45
Determining the BIOS version	45
Downloading a BIOS update	45
Changing the boot order using the f9 prompt	46
TPM BIOS settings (select products only)	46
Using HP Sure Start (select products only)	47

7 Computer Setup (BIOS) and MultiBoot in Windows 7 48

Using Computer Setup	48
Starting Computer Setup	48
Navigating and selecting in Computer Setup	48
Restoring factory settings in Computer Setup	49
Updating the BIOS	50
Determining the BIOS version	50
Downloading a BIOS update	50
Using MultiBoot	51
About the boot device order	51
Choosing MultiBoot preferences	51
Setting a new boot order in Computer Setup	51
Dynamically choosing a boot device using the f9 prompt	52
Setting a MultiBoot Express prompt	52
Entering MultiBoot Express preferences	52

8 Using HP PC Hardware Diagnostics (UEFI) 54

Downloading HP PC Hardware Diagnostics (UEFI) to a USB device	54
---	----

9 Backup and recovery in Windows 10	56
Creating recovery media and backups	56
Creating HP Recovery media (select products only)	56
Using Windows tools	57
Restore and recovery	58
Recovering using HP Recovery Manager	58
What you need to know before you get started	58
Using the HP Recovery partition (select products only)	59
Using HP Recovery media to recover	59
Changing the computer boot order	60
Removing the HP Recovery partition (select products only)	60
10 Backup and recovery in Windows 7	61
Creating recovery media and backups	61
Guidelines	61
Creating recovery media with HP Recovery Disc Creator	61
Creating recovery media	62
Backing up your information	62
Performing a system recovery	63
Using the Windows recovery tools	63
Using f11 recovery tools (select models only)	64
Using Windows 7 operating system media	64
11 Specifications	66
Computer specifications	66
M.2 solid-state drive specifications	67
M.2 PCIe solid-state drive specifications	68
12 Statement of memory volatility	69
Nonvolatile memory usage	73
Questions and answers	75
Using HP Sure Start (select models only)	76
13 Power cord set requirements	77
Requirements for all countries	77
Requirements for specific countries and regions	77
14 Recycling	79
Index	80

1 Product description

Category	Description
Product Name	HP EliteBook Folio G1 Notebook PC
Processors	6th generation Intel® Core™ m processors: <ul style="list-style-type: none">• m7-6Y75• m5-6Y57• m5-6Y54• m3-6Y30
Chipset	Intel Premium PCH-LP; integrated with processor
Graphics	Intel HD Graphics 515
Panels	31.75-cm (12.5-in), eDP1.3, UltraSlim Full high-definition (FHD), AntiGlare (AG), UVWA (1920×1080), non-touch display, 300 nits Full high-definition (FHD), UVWA (1920×1080), non-touch display, 300 nits Full high-definition (FHD), UVWA (1920×1080), non-touch display, IR, 300 nits Full high-definition (FHD), UVWA (1920×1080), touch display, 300 nits Full high-definition (FHD), UVWA (1920×1080), touch display, IR, 300 nits Quad high-definition (UHD), UVWA (3840×2160), touch display, 400 nits Quad high-definition (UHD), UVWA (3840×2160), IR, touch display, 400 nits
Memory	On-board (soldered) memory; not user-upgradable LPDDR3, 1866 MHz, dual channel support Supports up to 8 GB of system RAM
Primary storage	Supports M.2 SSD SS 2280 Supports the following M.2 SSDs: <ul style="list-style-type: none">• 512-GB, SATA-3, TLC• 360-GB, SATA-3, TLC• 256-GB, MLC, PCIe• 256-GB, SATA-3, OPAL2, MLC• 256-GB, SATA-3, SED, OPAL2, TLC (not available for Special Edition models)• 240-GB, SATA-3, MLC• 128-GB, SATA-3, TLC
Audio and video	Two stereo speakers, Bang & Olufsen HD audio with DTS Studio Sound Integrated 720p webcam IR camera (supports IR facial recognition with Windows 10)

Category	Description
	Integrated dual-array microphone
Ethernet	Ethernet available from docking stations; no direct Ethernet support
Wireless	<p>WLAN</p> <p>Integrated wireless local area network (WLAN) options by way of M.2 wireless module</p> <p>Two WLAN antennas built into display assembly</p> <p>Bluetooth Disabled IOPT</p> <p>Support for the following WLAN format:</p> <ul style="list-style-type: none"> • Intel Dual Band Wireless-AC 8260 (8260D2W)
	<p>WPAN</p> <p>Bluetooth 4.2</p>
Input/output	<p>(2) USB-C ports (Guest Protocol - USB 3.1, DP, PD, Thunderbolt)</p> <p>Headphone/Microphone Combo</p>
Docking	HP ZBook 65/150/200 W Thunderbolt 3 Dock
Keyboard/pointing devices	<p>Keyboard</p> <p>Dura keys, backlit</p> <p>ClickPad</p> <p>Gestures enabled by default</p> <p>Taps enabled by default</p> <p>On/off LED</p>
Power requirements	<p>AC adapter</p> <p>45-W HP Smart AC adapter non-PFC USB-C</p> <p>Power cord</p> <p>Duck head power cord with 2-prong adapter (South Korea uses 3-pin duck head)</p> <p>Battery</p> <p>4-cell, 38-Whr, 5.0 Ahr long life polymer battery</p>
Security	<p>Trusted Platform Module (TPM) 2.0 (Infineon, soldered down)</p> <p>Drive encryption pre-boot (password)</p> <p>Power-on authentication (password)</p>
Operating system	<p>Preinstalled</p> <p>Windows 10 Home 64 Plus</p> <p>Windows 10 Home 64 Plus Single Language</p> <p>Windows 10 Home 64 Chinese Market – CPPP</p> <p>Windows 10 Home 64 Chinese Market – CPPP - Plus</p> <p>Windows 10 Pro 64</p> <p>Windows 10 Pro 64 Downgrade Windows 7 32-bit</p> <p>Windows 10 Pro 64 Downgrade Windows 7 32-bit Volume License</p>

Category	Description
	Windows 10 Pro 64 Downgrade Windows 7 32-bit StF MSNA - Plus Windows 10 Pro 64 Downgrade Windows 7 64-bit Windows 10 Pro 64 Downgrade Windows 7 64-bit Volume License Windows 10 Pro 64 Downgrade Windows 7 64-bit StF MSNA - Plus FreeDOS 2.0
	Restore media—DRDVD/SRDVD Windows 7 DRDVD Windows 10 DRUSB Windows 10
	Restore media—OSDVD Windows 7 Pro 32 Service Pack 1 Windows 7 Pro 64 Service Pack 1 Windows 10 Pro 64
	Certified Microsoft WHQL: Windows 10 64
	Web-only support Windows 10 Enterprise 64 Windows 10 Enterprise 64 LTSB 1507 Windows 8.1 Pro 64 Windows 8.1 Enterprise 64 Windows 7 Pro 64 Windows 7 Enterprise 64
Serviceability	End user replaceable parts: AC adapter

2 External component identification

Display



Component	Description
(1) WLAN antennas*	Send and receive wireless signals to communicate with wireless local area networks (WLANs).
(2) Internal microphones (2)	Record sound.
(3) Webcam infrared (IR) lights (2)	Improve the webcam picture quality in low-light conditions.
(4) Webcam and IR camera	Records video and captures photographs. Some models allow you to video conference and chat online using streaming video. To use the webcam in Windows 10: <ul style="list-style-type: none">▲ Type camera in the taskbar search box, and then select Camera. To use the webcam in Windows 7: <ul style="list-style-type: none">▲ Select Start > All Programs > Music, Photos and Videos.
(5) Webcam light	On: The webcam is in use.

*The antennas are not visible from the outside of the computer. For optimal transmission, keep the areas immediately around the antennas free from obstructions.

Component	Description
	For wireless regulatory notices, see the section of the <i>Regulatory, Safety, and Environmental Notices</i> that applies to your country or region.
	To access this guide in Windows 10:
1.	Type <code>support</code> in the taskbar search box, and then select the HP Support Assistant app.
	– or –
	Click the question mark icon in the taskbar.
2.	Select My PC , select the Specifications tab, and then select User Guides .
	To access this guide in Windows 7:
▲	Select Start > All Programs > HP Help and Support > HP Documentation .

Top



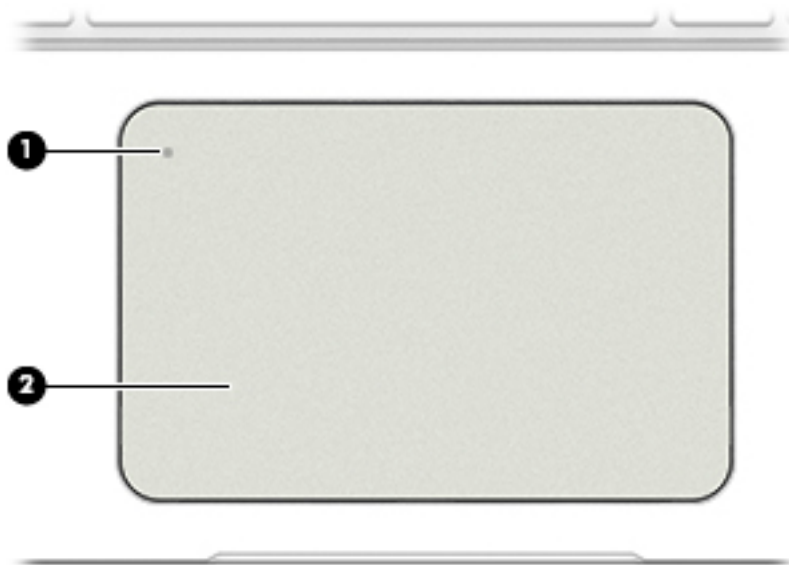



TouchPad

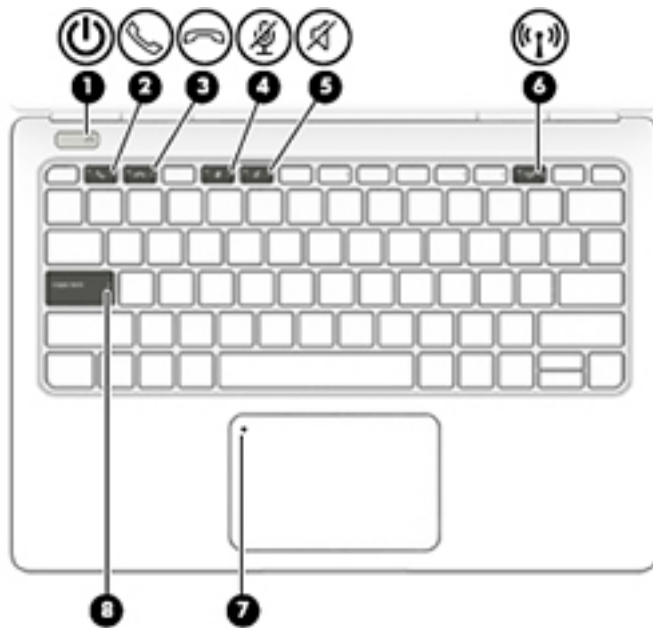

Component	Description
(1)	TouchPad on/off button
(2)	TouchPad zone

Lights



Component	Description
(1)  Power light	<ul style="list-style-type: none"> On: The computer is on. Blinking: The computer is in the Sleep state, a power-saving state. The computer shuts off power to the display and other unneeded components. Off: The computer is off or in Hibernation. Hibernation is a power-saving state that uses the least amount of power.
(2)  Call answer light	<ul style="list-style-type: none"> Blinking green: An incoming call is detected. Green: An incoming call is accepted.
(3)  Call decline/end light	<ul style="list-style-type: none"> Blinking red: An incoming call is detected. Red: An incoming call is declined or ended.
(4)  Microphone mute light	<ul style="list-style-type: none"> Amber: Microphone sound is off. Off: Microphone sound is on.
(5)  Mute light	<ul style="list-style-type: none"> Amber: Computer sound is off. Off: Computer sound is on.
(6)  Wireless light	<p>On: An integrated wireless device, such as a wireless local area network (WLAN) device and/or a Bluetooth® device, is on.</p> <p>NOTE: On some models, the wireless light is amber when all wireless devices are off.</p>
(7) TouchPad light	<ul style="list-style-type: none"> On: The TouchPad is off. Off: The TouchPad is on.
(8) Caps lock light	<p>On: Caps lock is on, which switches the key input to all capital letters.</p>

Button

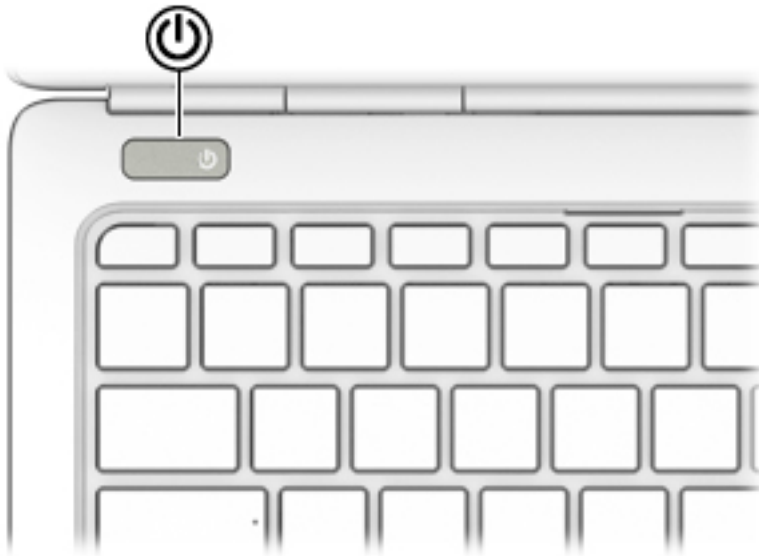

Component	Description
 Power button	<ul style="list-style-type: none">• When the computer is off, press the button to turn on the computer.• When the computer is on, press the button briefly to initiate Sleep.• When the computer is in the Sleep state, press the button briefly to exit Sleep.• When the computer is in Hibernation, press the button briefly to exit Hibernation. <p>CAUTION: Pressing and holding down the power button results in the loss of unsaved information.</p> <p>If the computer has stopped responding and shutdown procedures are ineffective, press and hold the power button for at least 5 seconds to turn off the computer.</p> <p>To learn more about your power settings in Windows 10, see your power options.</p> <ul style="list-style-type: none">▲ Type <code>power</code> in the taskbar search box, and then select Power and sleep settings. <p>– or –</p> <p>Right-click the Start button, and then select Power Options.</p> <p>To learn more about your power settings in Windows 7, see your power options.</p> <ul style="list-style-type: none">▲ Select Start > Control Panel > System and Security > Power Options.

Action keys

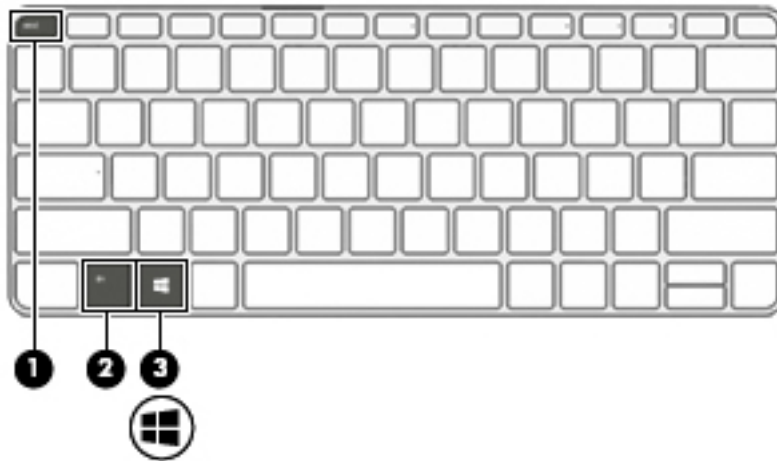













Component	Description
(1) <code>esc</code> key	Displays system information.
(2) <code>fn</code> key	Executes frequently used system functions when pressed in combination with another key.
(3)  Windows key	Opens the Start menu. NOTE: Pressing the Windows key again will close the Start menu.

Using the action keys

- An action key performs an assigned function.
- The icon on each action key illustrates the function for that key.

To use an action key:

- ▲ Press and hold the key.

Icon	Description
	Initiates a call or answers an incoming call.
	Declines an incoming call or ends the current call.
	Opens the calendar.
	Mutes the microphone.
	Mutes or restores speaker sound.
	Decreases speaker volume incrementally while you hold down the key.
	Increases speaker volume incrementally while you hold down the key.
	Switches the screen image among display devices connected to the system. For example, if a monitor is connected to the computer via the optional docking device, f4 (Windows 10) or f8 (Windows 7) alternates the screen image from computer display to monitor display to simultaneous display on both the computer and the monitor. Most external monitors receive video information on the computer using the external VGA video standard. The f4 (Windows 10) or f8 (Windows 7) action key can also alternate images among other devices that are receiving video information on the computer.
	Turns the keyboard backlight off or on. NOTE: To conserve battery power, turn off this feature.
	Decreases the screen brightness incrementally as long as you hold down the key.
	Increases the screen brightness incrementally as long as you hold down the key.
	Turns the wireless feature on or off. NOTE: A wireless network must be set up before a wireless connection is possible.

Left



Component	Description
 Audio-out (headphone)/Audio-in (microphone) combo jack	<p>Connects optional powered stereo speakers, headphones, earbuds, a headset, or a television audio cable. Also connects an optional headset microphone. This jack does not support optional standalone microphones.</p> <p>WARNING! To reduce the risk of personal injury, adjust the volume before putting on headphones, earbuds, or a headset. For additional safety information, refer to the <i>Regulatory, Safety, and Environmental Notices</i>.</p> <p>To access this guide in Windows 10:</p> <ol style="list-style-type: none">1. Type <code>support</code> in the taskbar search box, and then select the HP Support Assistant app. <p>– or –</p> <p>Click the question mark icon in the taskbar.</p> <ol style="list-style-type: none">2. Select My PC, select the Specifications tab, and then select User Guides. <p>To access this guide in Windows 7:</p> <ol style="list-style-type: none">▲ Select Start > All Programs > HP Help and Support > HP Documentation. <p>NOTE: When a device is connected to the jack, the computer speakers are disabled.</p> <p>NOTE: Be sure that the device cable has a 4-conductor connector that supports both audio-out (headphone) and audio-in (microphone).</p>

Right

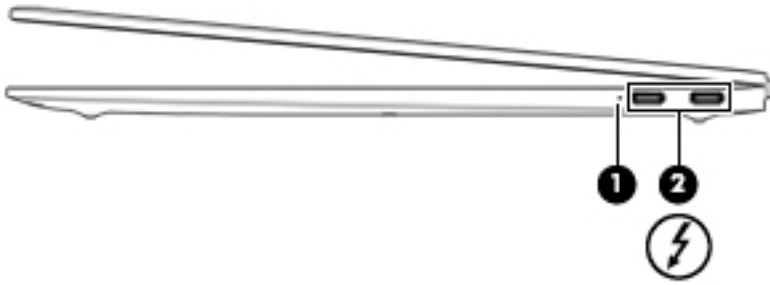

Component	Description
(1) Battery light	<p>When AC power is connected:</p> <ul style="list-style-type: none">• White: The battery charge is greater than 90 percent.• Amber: The battery charge is from 0 to 90 percent.• Off: The battery is not charging. <p>When AC power is disconnected (battery not charging):</p> <ul style="list-style-type: none">• Blinking amber: The battery has reached a low battery level. When the battery has reached a critical battery level, the battery light begins blinking rapidly.• Off: The battery is not charging.
(2)  USB Type-C power connector and Thunderbolt™ ports (2)	<p>Connect an AC adapter that has a USB Type-C connector, supplying power to the computer and, if needed, charging the computer battery.</p> <p>– or –</p> <p>Connect and charge a USB device that has a Type-C connector, such as a cell phone, camera, activity tracker, or smartwatch, and provide high-speed data transfer.</p> <p>– or –</p> <p>Connect a display device that has a USB Type-C connector, providing video or high-resolution display output.</p> <p>NOTE: Your computer may also support a Thunderbolt docking station.</p> <p>NOTE: Adapters (purchased separately) may be required.</p>

Bottom

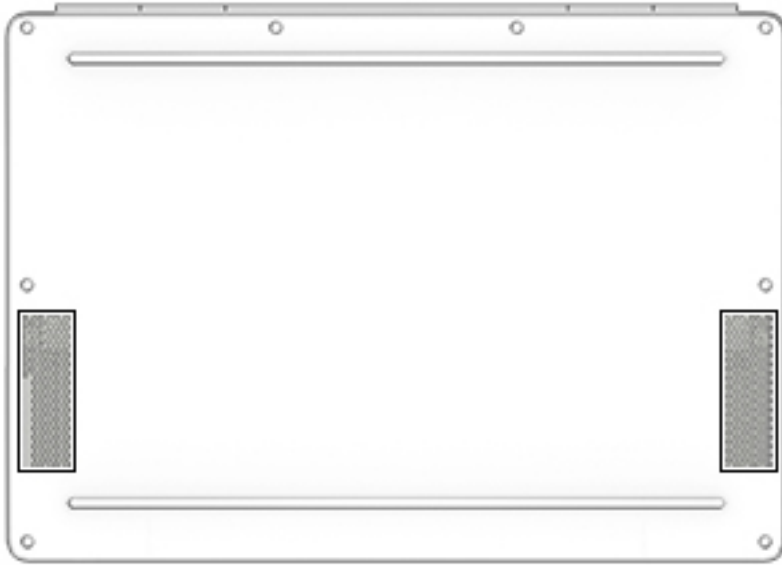

Component	Description
Speakers (2)	Produce sound.

Labels

The labels affixed to the computer provide information you may need when you troubleshoot system problems or travel internationally with the computer.

 **IMPORTANT:** Check the following locations for the labels described in this section: the bottom of the computer, inside the battery bay, under the service door, or on the back of the display.

- Service label—Provides important information to identify your computer. When contacting support, you will probably be asked for the serial number, and possibly for the product number or the model number. Locate these numbers before you contact support.

Your service label will resemble one of the examples shown below. Refer to the illustration that most closely matches the service label on your computer.



Component

- (1) Serial number
 - (2) Product number
 - (3) Warranty period
 - (4) Model number (select products only)
-

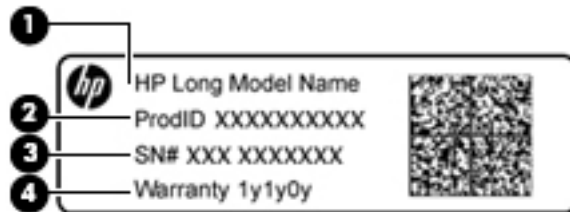

Component

- (1) Model name (select products only)
 - (2) Product number
 - (3) Serial number
 - (4) Warranty period
-

- Regulatory label(s)—Provide(s) regulatory information about the computer.
- Wireless certification label(s)—Provide(s) information about optional wireless devices and the approval markings for the countries or regions in which the devices have been approved for use.

3 Illustrated parts catalog

Computer major components

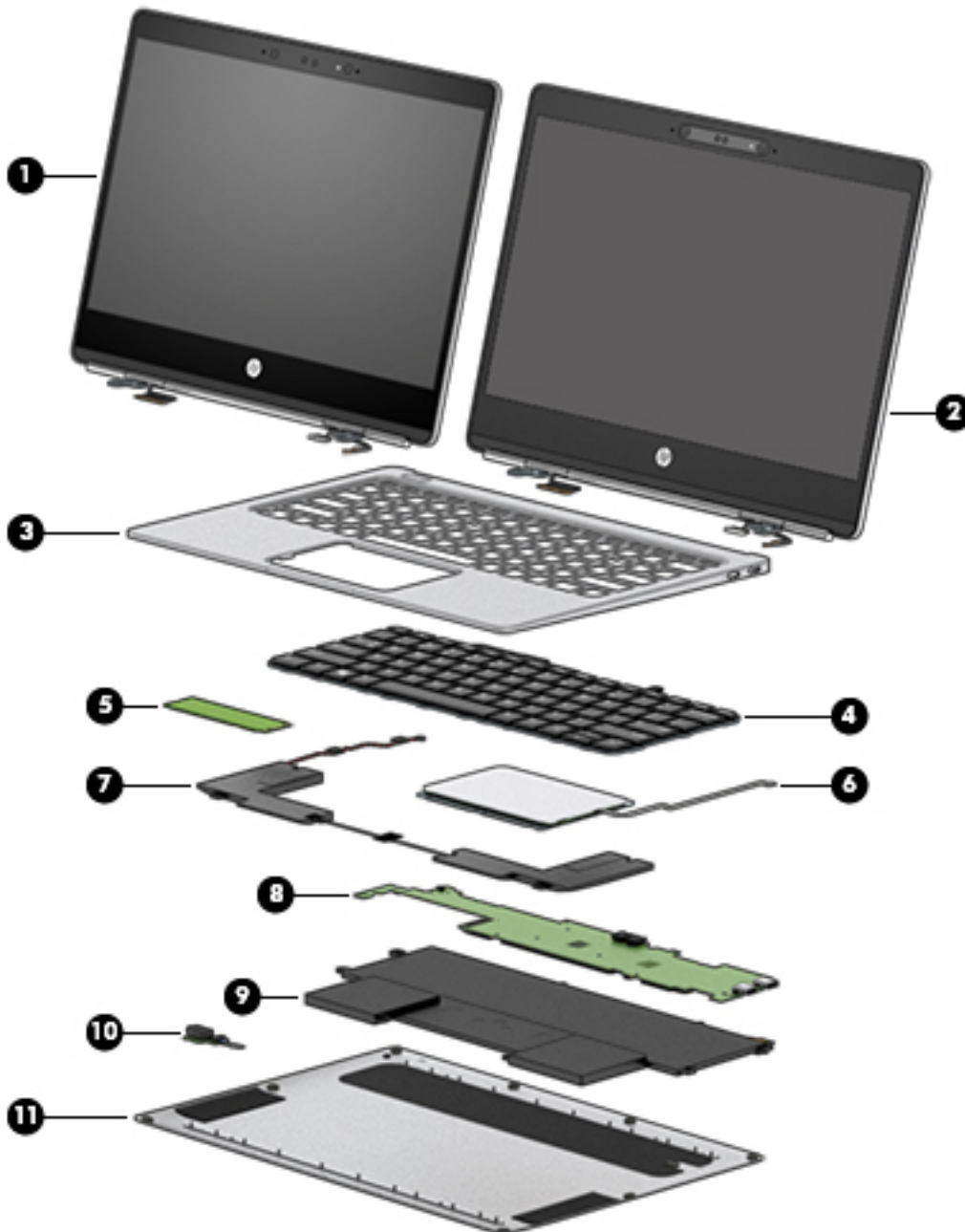

Item	Component	Spare part number
	Display assembly	
	NOTE: Displays are only spared as full hinge-ups. Individual components are not spared.	
(1)	Touch screen models	
	<ul style="list-style-type: none"> FHD, UWVA 	850916-001
	<ul style="list-style-type: none"> UHD, UWVA 	850917-001
	<ul style="list-style-type: none"> FHD with HDC-IR, ultraslim 	860207-001
	<ul style="list-style-type: none"> UHD with HDC-IR, ultraslim 	860208-001
(2)	Non-touch screen models	
	<ul style="list-style-type: none"> FHD, UWVA, ultraslim 	850918-001
	<ul style="list-style-type: none"> FHD, UWVA, ultraslim, lightweight 	855090-001
	NOTE: Lightweight models include a plastic bezel without edge-to-edge glass.	
	<ul style="list-style-type: none"> FHD, with HDC-IR, ultraslim 	860206-001
(3)	Top cover	
	Americas style keyboard lattice, for use in the following regions: NA, LA, EMEA, APJ	850912-001
	EMEA style keyboard lattice, for use in the following regions: NA, LA, EMEA	850913-001
	APJ style keyboard lattice, for use in the following region: APJ	850914-001
(4)	Keyboard (backlit; includes keyboard cable and backlight cable)	850915-xx1
	NOTE: For a detailed list of keyboard country codes, see Keyboard on page 37 .	
(5)	Solid-state drive	
	512-GB, TLC, M.2	855107-001
	360-GB, TLC, M.2	L11504-001
	256-GB, TLC, OPAL2, self-encrypting drive (SED), M.2	926790-001
	256-GB, PCIe	850920-001
	128-GB, TLC, M.2	855091-001
(6)	TouchPad (includes cable)	850907-001
(7)	Speakers (includes cable)	850906-001
(8)	System board (includes 8 GB of system RAM, processor and replacement thermal material)	
	All system boards use the following part numbers:	
	xxxxxx-001: Windows 7 or non-Windows operating systems	
	xxxxxx-601: Windows 10 operating system	
	Equipped with Intel Core m7-6Y75 processor	850910-xxx
	Equipped with Intel Core m5-6Y57 processor	850909-xxx
	Equipped with Intel Core m5-6Y54 processor	850908-xxx
	Equipped with Intel Core m3-6Y30 processor	866191-xxx

Item	Component	Spare part number
(9)	Battery (4-cell, 38-Wh, 1.89-Ah, Li ion)	828226-005
(10)	Audio board (includes cable)	850911-001
(11)	Bottom cover (includes feet)	
	Standard models	850905-001
	Lightweight models	857630-001
	NOTE: Lightweight models use a display with a plastic bezel without edge-to-edge glass.	
	Thermal solution kit (includes thermal plate, three graphite sheets, and three thermal pads; not illustrated)	910054-001
	For more information, see Thermal solution kit on page 39 .	

Mass storage devices

Description	Spare part number
Solid-state drive	
512-GB, TLC, M.2	855107-001
360-GB, TLC, M.2	L11504-001
256-GB, TLC, OPAL2, self-encrypting drive (SED), M.2	926790-001
256-GB, PCIe	850920-001
128-GB, TLC, M.2	855091-001

Miscellaneous parts

Component	Spare part number
AC adapter	
45-W Smart AC adapter, wall mount, USB-C	828769-001
65-W Smart AC adapter, 4.5 mm, EM (for use with docking station)	714657-001
65-W Smart AC adapter, 4.5 mm, S-3P (for use with docking station)	710412-001
Adapters	
USB-C to VGA	831751-001
USB-C to HDMI	831752-001
USB-C to DisplayPort	831753-001
USB-C to 3 mm and 4.5 mm connector	814813-001
USB-C to USB 3.0	814618-001
USB-C to RJ-45	855560-001
Power cord (3-pin, black, 1.83-m)	

Component	Spare part number
For use in Argentina	401300-001
For use in Australia	213356-001
For use in Brazil	438722-001
For use in Denmark	213353-010
For use in Europe (Austria, Belgium, Finland, France, Germany, the Netherlands, Norway and Sweden)	213350-001
For use in India	404827-001
For use in Israel	398063-001
For use in Italy	213352-001
For use in Japan	349756-001
For use in North America	213349-001
For use in the People's Republic of China	286497-001
For use in South Africa	361240-001
For use in South Korea	267836-001
For use in Switzerland	213354-001
For use in Taiwan	393313-001
For use in Thailand	285096-001
For use in the United Kingdom	213351-001
Power cord (3-pin, black, 0.5-m)	
For use in Argentina	401300-009
For use in Australia	213356-010
For use in Brazil	438722-006
For use in the Denmark	213353-010
For use in Europe (Austria, Belgium, Finland, France, Germany, the Netherlands, Norway and Sweden)	213350-011
For use in India	404827-005
For use in Israel	398063-005
For use in Italy	213352-010
For use in Japan	349756-004
For use in North America	213349-012
For use in the People's Republic of China	286497-010
For use in South Africa	361240-004
For use in Switzerland	213354-010
For use in Taiwan	393313-005
For use in Thailand	285096-009
For use in the United Kingdom	213351-010

Component	Spare part number
Power cord, duckhead, C5	
2 pin, for use in the United States	851378-001
3 pin, for use in South Korea	851377-001
Screw Kit	850919-001
HP ZBook Dock with Thunderbolt 3	849784-001
HP Elite USB-C Docking Station	844549-001
Cable for use with the HP Elite USB-C Docking Station	844550-001
Cable for use with HP ZBook Dock with Thunderbolt 3	855117-001
Mouse	
HP USB laser	674318-001
HP Slim Bluetooth	746920-001
HP Comfort Grip wireless mouse	691922-001
HP Ultrathin Bluetooth	811730-001
HP Business Backpack	718548-001
HP Business Slim Load Top case	718549-001

4 Removal and replacement procedures preliminary requirements

Tools required

You will need the following tools to complete the removal and replacement procedures:

- Flat-bladed screw driver
- Torx T5 screw driver
- Phillips P0 and P1 screw drivers
- Non-marking pry tool

Service considerations

The following sections include some of the considerations that you must keep in mind during disassembly and assembly procedures.

 **NOTE:** As you remove each subassembly from the computer, place the subassembly (and all accompanying screws) away from the work area to prevent damage.

Plastic parts

 **CAUTION:** Using excessive force during disassembly and reassembly can damage plastic parts. Use care when handling the plastic parts. Apply pressure only at the points designated in the maintenance instructions.

Cables and connectors

 **CAUTION:** When servicing the computer, be sure that cables are placed in their proper locations during the reassembly process. Improper cable placement can damage the computer.

Cables must be handled with extreme care to avoid damage. Apply only the tension required to unseat or seat the cables during removal and insertion. Handle cables by the connector whenever possible. In all cases, avoid bending, twisting, or tearing cables. Be sure that cables are routed in such a way that they cannot be caught or snagged by parts being removed or replaced. Handle flex cables with extreme care; these cables tear easily.

Drive handling

⚠ CAUTION: Drives are fragile components that must be handled with care. To prevent damage to the computer, damage to a drive, or loss of information, observe these precautions:

Before removing or inserting a hard drive, shut down the computer. If you are unsure whether the computer is off or in Hibernation, turn the computer on, and then shut it down through the operating system.

Before handling a drive, be sure that you are discharged of static electricity. While handling a drive, avoid touching the connector.

Before removing a diskette drive or optical drive, be sure that a diskette or disc is not in the drive and be sure that the optical drive tray is closed.

Handle drives on surfaces covered with at least one inch of shock-proof foam.

Avoid dropping drives from any height onto any surface.

After removing a hard drive, an optical drive, or a diskette drive, place it in a static-proof bag.

Avoid exposing an internal hard drive to products that have magnetic fields, such as monitors or speakers.

Avoid exposing a drive to temperature extremes or liquids.

If a drive must be mailed, place the drive in a bubble pack mailer or other suitable form of protective packaging and label the package "FRAGILE."

Grounding guidelines

Electrostatic discharge damage

Electronic components are sensitive to electrostatic discharge (ESD). Circuitry design and structure determine the degree of sensitivity. Networks built into many integrated circuits provide some protection, but in many cases, ESD contains enough power to alter device parameters or melt silicon junctions.

A discharge of static electricity from a finger or other conductor can destroy static-sensitive devices or microcircuitry. Even if the spark is neither felt nor heard, damage may have occurred.

An electronic device exposed to ESD may not be affected at all and can work perfectly throughout a normal cycle. Or the device may function normally for a while, then degrade in the internal layers, reducing its life expectancy.

⚠ CAUTION: To prevent damage to the computer when you are removing or installing internal components, observe these precautions:

Keep components in their electrostatic-safe containers until you are ready to install them.

Before touching an electronic component, discharge static electricity by using the guidelines described in this section.

Avoid touching pins, leads, and circuitry. Handle electronic components as little as possible.

If you remove a component, place it in an electrostatic-safe container.

The following table shows how humidity affects the electrostatic voltage levels generated by different activities.

⚠ CAUTION: A product can be degraded by as little as 700 V.

Typical electrostatic voltage levels			
Event	Relative humidity		
	10%	40%	55%
Walking across carpet	35,000 V	15,000 V	7,500 V
Walking across vinyl floor	12,000 V	5,000 V	3,000 V
Motions of bench worker	6,000 V	800 V	400 V
Removing DIPs from plastic tube	2,000 V	700 V	400 V
Removing DIPs from vinyl tray	11,500 V	4,000 V	2,000 V
Removing DIPs from Styrofoam	14,500 V	5,000 V	3,500 V
Removing bubble pack from PCB	26,500 V	20,000 V	7,000 V
Packing PCBs in foam-lined box	21,000 V	11,000 V	5,000 V

Packaging and transporting guidelines

Follow these grounding guidelines when packaging and transporting equipment:

- To avoid hand contact, transport products in static-safe tubes, bags, or boxes.
- Protect ESD-sensitive parts and assemblies with conductive or approved containers or packaging.
- Keep ESD-sensitive parts in their containers until the parts arrive at static-free workstations.
- Place items on a grounded surface before removing items from their containers.
- Always be properly grounded when touching a component or assembly.
- Store reusable ESD-sensitive parts from assemblies in protective packaging or nonconductive foam.
- Use transporters and conveyors made of antistatic belts and roller bushings. Be sure that mechanized equipment used for moving materials is wired to ground and that proper materials are selected to avoid static charging. When grounding is not possible, use an ionizer to dissipate electric charges.

Workstation guidelines

Follow these grounding workstation guidelines:

- Cover the workstation with approved static-shielding material.
- Use a wrist strap connected to a properly grounded work surface and use properly grounded tools and equipment.
- Use conductive field service tools, such as cutters, screw drivers, and vacuums.
- When fixtures must directly contact dissipative surfaces, use fixtures made only of static-safe materials.
- Keep the work area free of nonconductive materials, such as ordinary plastic assembly aids and Styrofoam.
- Handle ESD-sensitive components, parts, and assemblies by the case or PCM laminate. Handle these items only at static-free workstations.
- Avoid contact with pins, leads, or circuitry.
- Turn off power and input signals before inserting or removing connectors or test equipment.

Equipment guidelines

Grounding equipment must include either a wrist strap or a foot strap at a grounded workstation.

- When seated, wear a wrist strap connected to a grounded system. Wrist straps are flexible straps with a minimum of one megohm $\pm 10\%$ resistance in the ground cords. To provide proper ground, wear a strap snugly against the skin at all times. On grounded mats with banana-plug connectors, use alligator clips to connect a wrist strap.
- When standing, use foot straps and a grounded floor mat. Foot straps (heel, toe, or boot straps) can be used at standing workstations and are compatible with most types of shoes or boots. On conductive floors or dissipative floor mats, use foot straps on both feet with a minimum of one megohm resistance between the operator and ground. To be effective, the conductive must be worn in contact with the skin.

The following grounding equipment is recommended to prevent electrostatic damage:

- Antistatic tape
- Antistatic smocks, aprons, and sleeve protectors
- Conductive bins and other assembly or soldering aids
- Nonconductive foam
- Conductive tabletop workstations with ground cords of one megohm resistance
- Static-dissipative tables or floor mats with hard ties to the ground
- Field service kits
- Static awareness labels
- Material-handling packages
- Nonconductive plastic bags, tubes, or boxes
- Metal tote boxes
- Electrostatic voltage levels and protective materials

The following table lists the shielding protection provided by antistatic bags and floor mats.

Material	Use	Voltage protection level
Antistatic plastics	Bags	1,500 V
Carbon-loaded plastic	Floor mats	7,500 V
Metallized laminate	Floor mats	5,000 V

5 Removal and replacement procedures for Authorized Service Provider parts

 **CAUTION:** Components described in this chapter should only be accessed by an authorized service provider. Accessing these parts can damage the computer or void the warranty.

Component replacement procedures

 **NOTE:** Details about your computer, including model, serial number, product key, and length of warranty, are on the service tag at the bottom of your computer. See [Labels on page 13](#) for details.

This chapter provides removal and replacement procedures.

There are as many as 92 screws that must be removed, replaced, or loosened when servicing Authorized Service Provider only parts. Make special note of each screw size and location during removal and replacement.

Bottom cover

Description	Spare part number
Bottom cover (includes feet)	850905-001
Bottom cover, lightweight models (includes feet)	857630-001

NOTE: Lightweight models use a display with a plastic bezel without edge-to-edge glass.

Before removing the bottom cover, follow these steps:

1. Turn off the computer. If you are unsure whether the computer is off or in Hibernation, turn the computer on, and then shut it down through the operating system.
2. Disconnect the power from the computer by unplugging the power cord from the computer.
3. Disconnect all external devices from the computer.

Remove the bottom cover:

1. Remove the eight Torx T8M2.0×3.0 screws **(1)** that secure the bottom cover to the computer.

2. Remove the bottom cover from the computer (2).

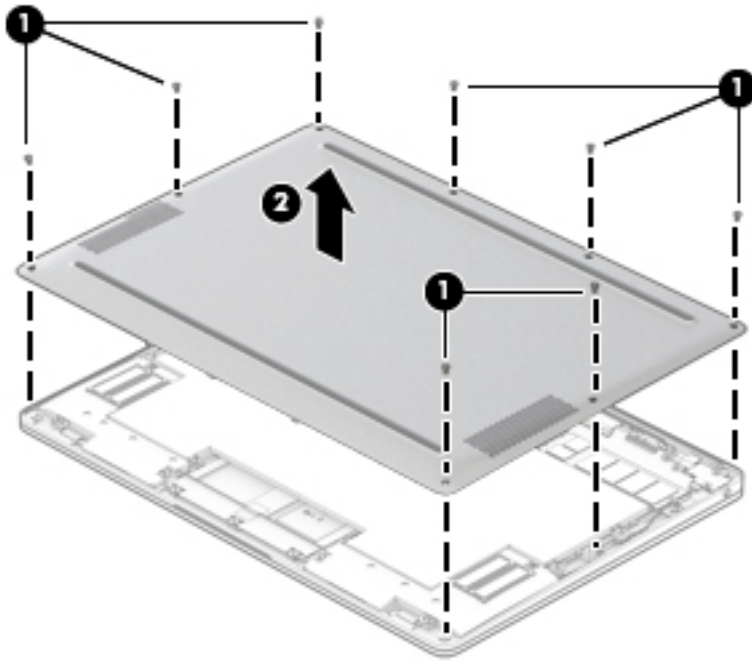

Reverse the removal procedures to install the bottom cover.

Battery

Description	Spare part number
4-cell, 38-Wh, 1.89-Ah, Li ion battery	828226-005

Before disassembling the computer, follow these steps:

1. Turn off the computer. If you are unsure whether the computer is off or in Hibernation, turn the computer on, and then shut it down through the operating system.
2. Disconnect the power from the computer by unplugging the power cord from the computer.
3. Disconnect all external devices from the computer.
4. Remove the bottom cover (see [Bottom cover on page 23](#)).

Remove the battery:

1. Disconnect the battery cable from the system board **(1)**.
2. Remove the two Phillips PM1.6×4.0 screws **(2)** that secure the battery to the computer.
3. Remove the six Phillips PM2.0×3.0 screws **(3)** that secure the battery to the computer.
4. Lift the battery out of the computer **(4)**.

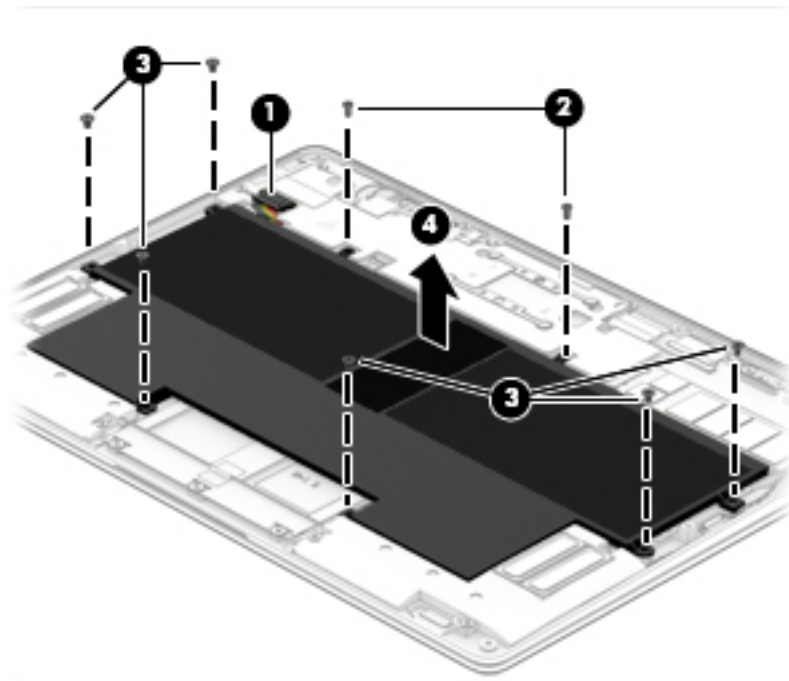

Reverse this procedure to install the battery drive.

SSD drive

Description	Spare part number
512-GB, TLC, M.2	855107-001
360-GB, TLC, M.2	L11504-001
256-GB, TLC, OPAL2, self-encrypting drive (SED), M.2	926790-001
256-GB, PCIe	850920-001
128-GB, TLC, M.2	855091-001

Before removing the solid-state drive, follow these steps:

1. Turn off the computer. If you are unsure whether the computer is off or in Hibernation, turn the computer on, and then shut it down through the operating system.
2. Disconnect the power from the computer by unplugging the power cord from the computer.
3. Disconnect all external devices from the computer.
4. Remove the bottom cover (see [Bottom cover on page 23](#)).
5. Disconnect the battery cable (see [Battery on page 25](#)).

Remove the SSD:

1. Remove the Phillips PM2.0×3.0 screw **(1)** that secures the drive to the system board.
2. Remove the drive **(2)** by pulling it away from the connector.

 **NOTE:** M.2 drives are designed with notches to prevent incorrect insertion.

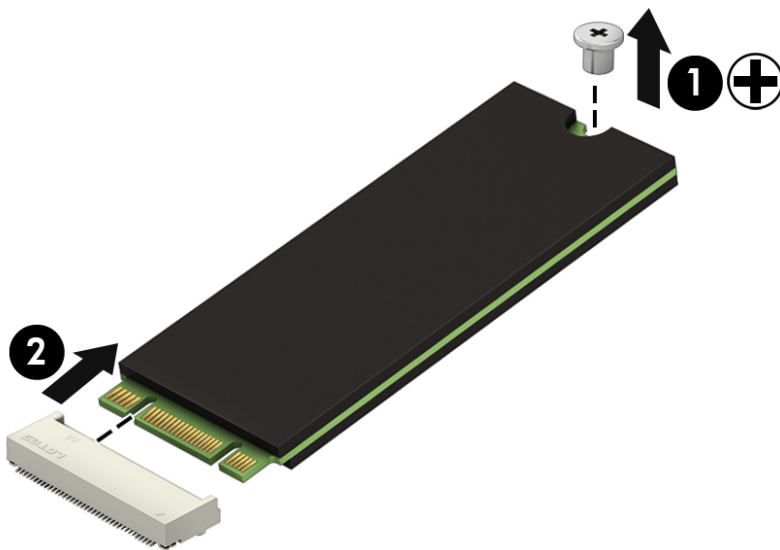

Reverse this procedure to install the SSD drive.

Speaker assembly

Description	Spare part number
Speaker assembly (includes cable)	850906-001

Before removing the speaker assembly, follow these steps:

1. Turn off the computer. If you are unsure whether the computer is off or in Hibernation, turn the computer on, and then shut it down through the operating system.
2. Disconnect the power from the computer by unplugging the power cord from the computer.
3. Disconnect all external devices from the computer.
4. Remove the bottom cover (see [Bottom cover on page 23](#)).
5. Disconnect the battery cable (see [Battery on page 25](#)).

Remove the speaker assembly:

1. Disconnect the speaker cable from the system board **(1)**.
2. Lift the tape that secures the cable to the computer **(2)**.
3. Remove the six Phillips PM2.0×3.0 screws **(3)** that secure the speakers to the computer.
4. Remove the speakers from the computer **(4)**.

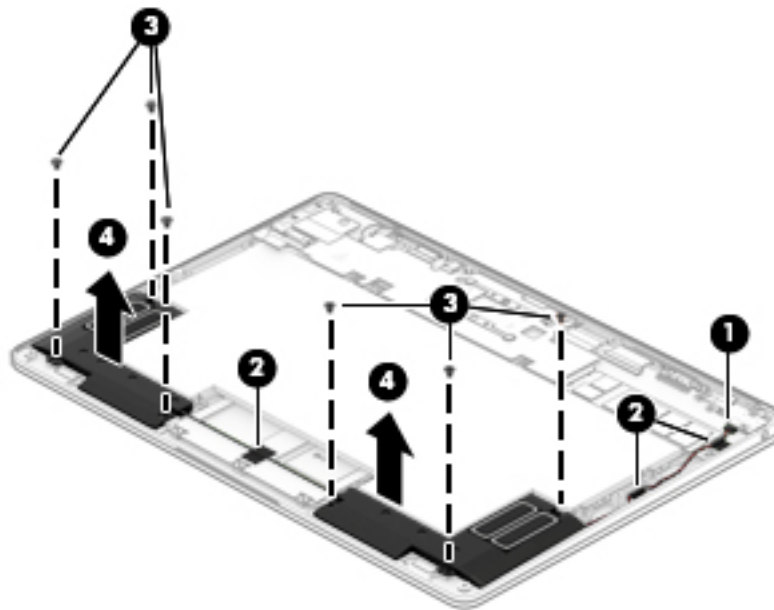

Reverse this procedure to install the speakers.

Audio board

Description	Spare part number
Audio board	850911-001

Before disassembling the computer, follow these steps:

1. Turn off the computer. If you are unsure whether the computer is off or in Hibernation, turn the computer on, and then shut it down through the operating system.
2. Disconnect the power from the computer by unplugging the power cord from the computer.
3. Disconnect all external devices from the computer.
4. Remove the bottom cover (see [Bottom cover on page 23](#)).
5. Disconnect the battery cable (see [Battery on page 25](#)).

Remove the audio board:

1. Disconnect the audio board cable from the system board **(1)**.
2. Remove the two Phillips PM2.0×3.0 screws **(2)** that secure the audio board to the computer.
3. Lift the audio board out of the computer **(3)**.

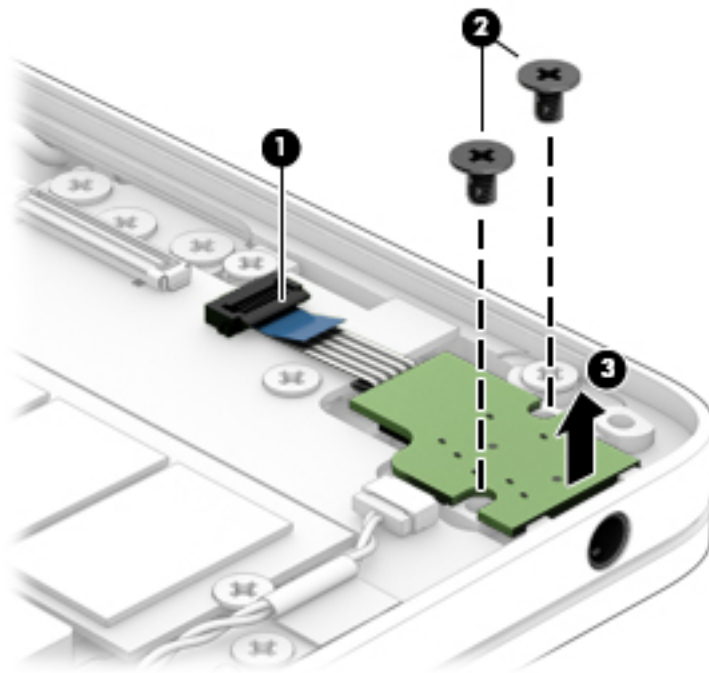

To replace the audio board, reverse the removal procedures.

TouchPad

Description	Spare part number
TouchPad (includes cable)	850907-001

Before removing the TouchPad, follow these steps:

1. Turn off the computer. If you are unsure whether the computer is off or in Hibernation, turn the computer on, and then shut it down through the operating system.
2. Disconnect the power from the computer by unplugging the power cord from the computer.
3. Disconnect all external devices from the computer.
4. Remove the bottom cover (see [Bottom cover on page 23](#)).
5. Remove the battery (see [Battery on page 25](#)).

Remove the TouchPad:

1. Disconnect the TouchPad cable **(1)** from the system board.
2. Lift the cable from the adhesive that secures it to the battery **(2)**.
3. Remove the adhesive from atop the TouchPad **(3)**.
4. Remove the six Phillips PM2.0×2.0 broadhead screws **(4)** that secure the TouchPad to the computer, and then remove the TouchPad from the computer **(5)**.

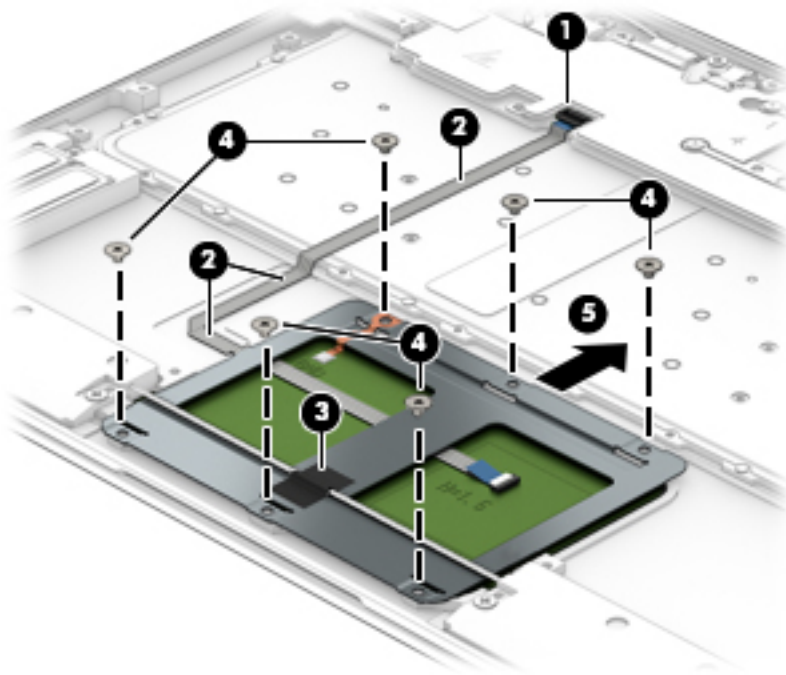

Reverse the removal procedures to install the TouchPad.

System board



NOTE: The system board spare part kit includes a processor, heat sink, 8 GB of system RAM, and replacement thermal material.

All system boards use the following part numbers:

xxxxxx-001: Windows 7 or non-Windows operating systems

xxxxxx-601: Windows 10 operating system

Description	Spare part number
Equipped with Intel Core m7-6Y75 processor	850910-xxx
Equipped with Intel Core m5-6Y57 processor	850909-xxx
Equipped with Intel Core m5-6Y54 processor	850908-xxx
Equipped with Intel Core m3-6Y30 processor	866191-xxx

Before removing the system board, follow these steps:

1. Turn off the computer. If you are unsure whether the computer is off or in Hibernation, turn the computer on, and then shut it down through the operating system.
2. Disconnect the power from the computer by unplugging the power cord from the computer.
3. Disconnect all external devices from the computer.
4. Remove the bottom cover (see [Bottom cover on page 23](#)).
5. Remove the battery (see [Battery on page 25](#)).
6. When replacing the system board, be sure that the following components are removed from the defective system board and installed on the replacement system board:
 - SSD drive module (see [SSD drive on page 26](#))

Remove the system board:

1. Disconnect the following cables:
 - (1): WLAN antennas
 - (2): Webcam cable
 - (3): Keyboard backlight cable
 - (4): TouchPad cable
 - (5): Display panel cable
 - (6): Keyboard cable (primary)
 - (7): Audio board cable
 - (8): Speaker cable

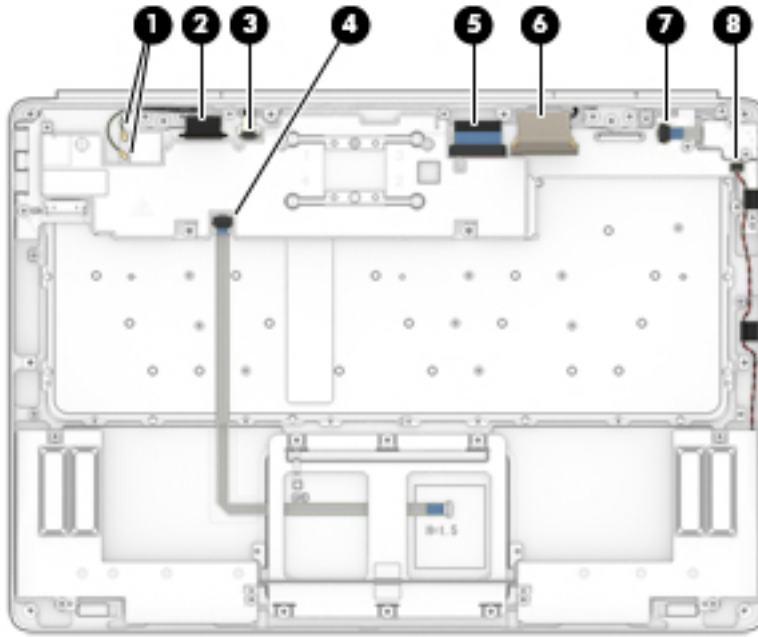

2. Remove the six Phillips PM2.0×3.0 screws **(1)** that secure the system board to the computer.
3. Lift the right side of the system board up at an angle **(2)**.
4. Pull the system board away from and out of the computer **(3)**, making sure the connectors on the side of the board are clear of the computer.

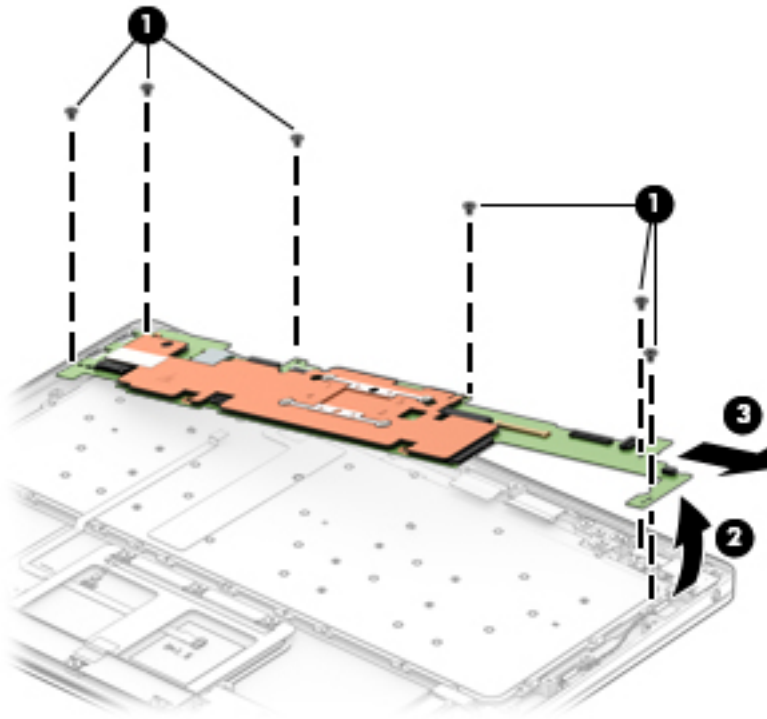

Reverse this procedure to install the system board.

Display assembly

Description	Spare part number
Display assembly, touch screen models:	
• FHD, UWVA	850916-001
• UHD, UWVA	850917-001
• FHD with HDC-IR, ultraslim	860207-001
• UHD with HDC-IR, ultraslim	860208-001
Display assembly, non-touch screen models:	
• FHD, UWVA, ultraslim	850918-001
• FHD, UWVA, ultraslim, lightweight	855090-001
NOTE: Lightweight models include a plastic bezel without edge-to-edge glass.	
• FHD, with HDC-IR, ultraslim	860206-001



NOTE: Displays are only spared as full hinge-ups. Individual components are not spared.

Before removing the display assembly, follow these steps:

1. Turn off the computer. If you are unsure whether the computer is off or in Hibernation, turn the computer on, and then shut it down through the operating system.
2. Disconnect the power from the computer by unplugging the power cord from the computer.
3. Disconnect all external devices from the computer.
4. Remove the bottom cover (see [Bottom cover on page 23](#)).
5. Remove the battery (see [Battery on page 25](#)).

Remove the display assembly:

1. Remove the eight Phillips PM2.0×2.0 screws **(1)** that secure the display to the computer.

2. Open the computer to position the hinges at an angle (2).

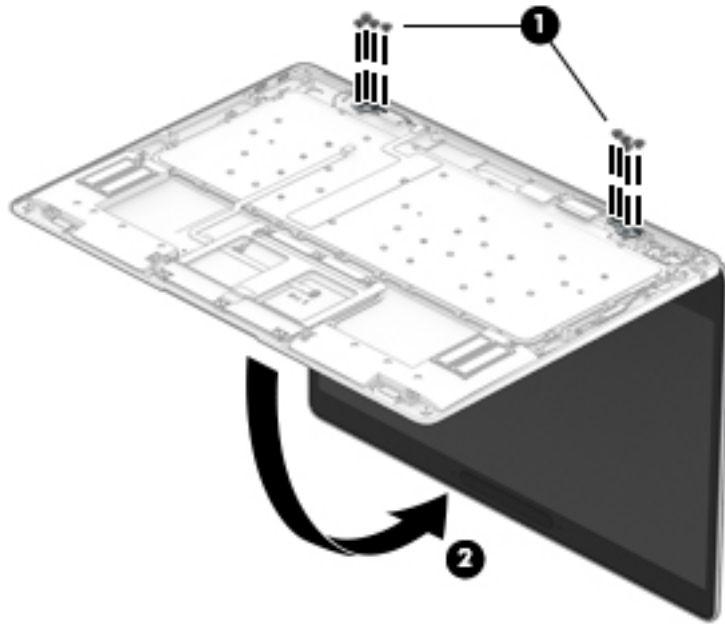

3. Pull the display cable out the gap near the left hinge.

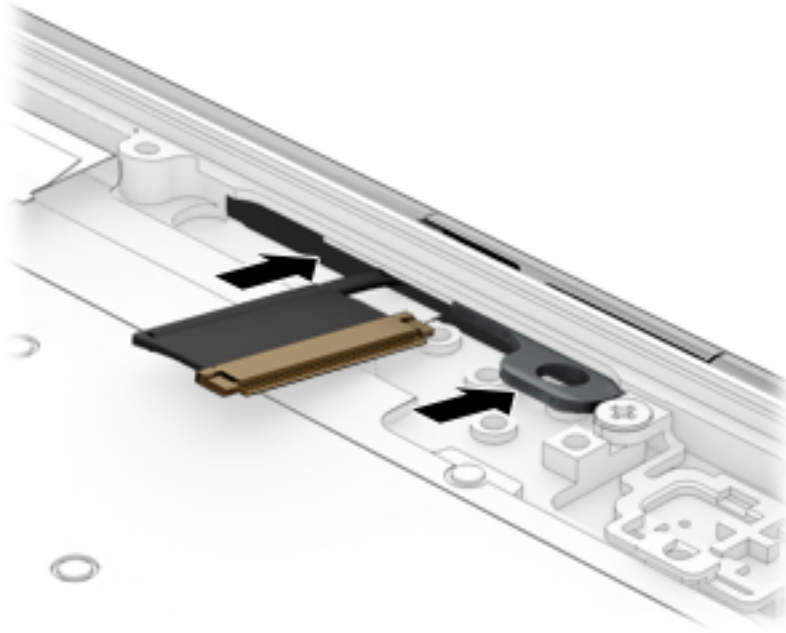

4. Pull the webcam/microphone cable and WLAN cables out the gap near the right hinge.

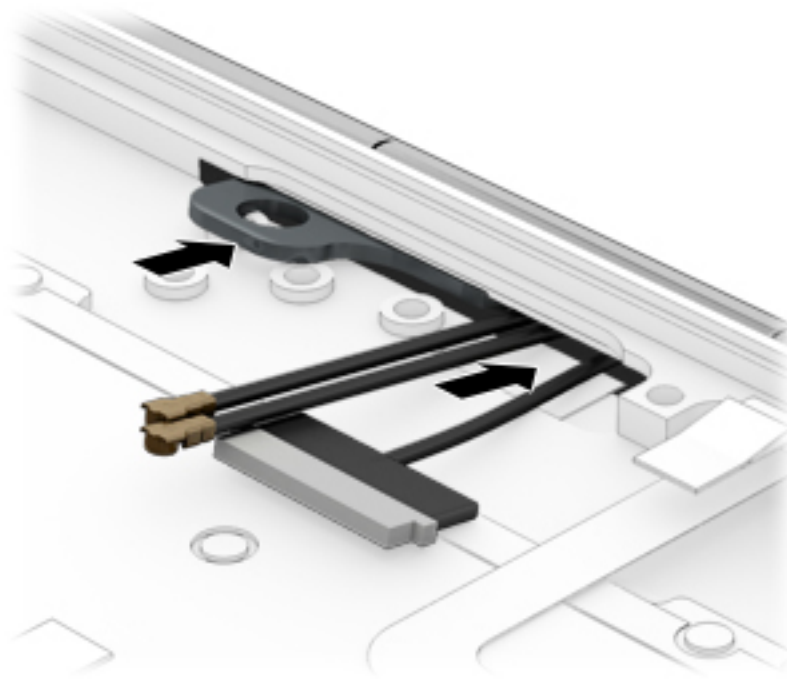

5. Separate the display from the computer.

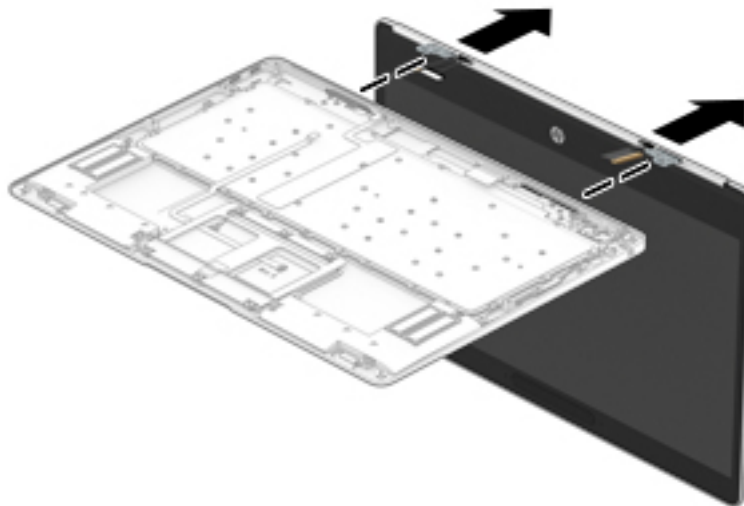

When installing a display assembly:

1. Insert the display hinges into the computer.

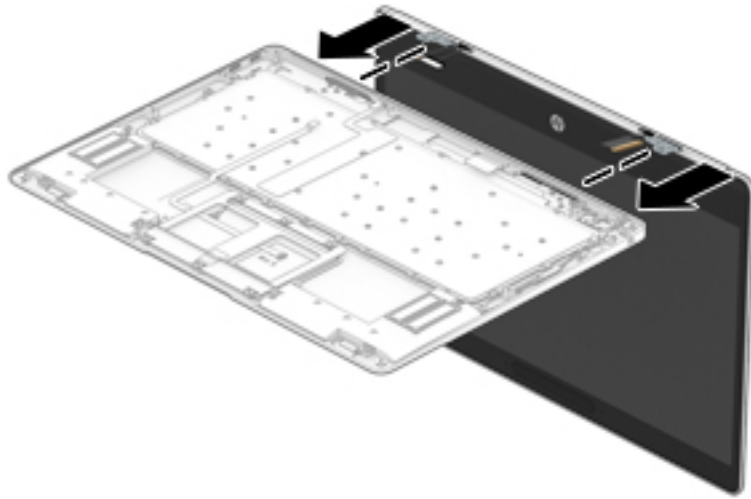

2. Thread the antennas, webcam cable, and display hinge through the hole near the right hinge.

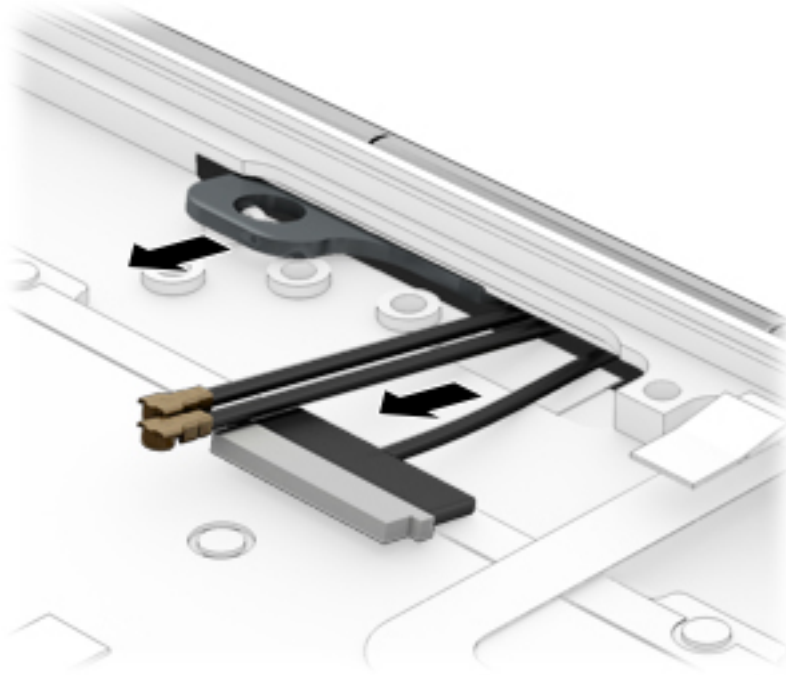

3. Thread the display cable and display hinge through the hole near the left hinge.

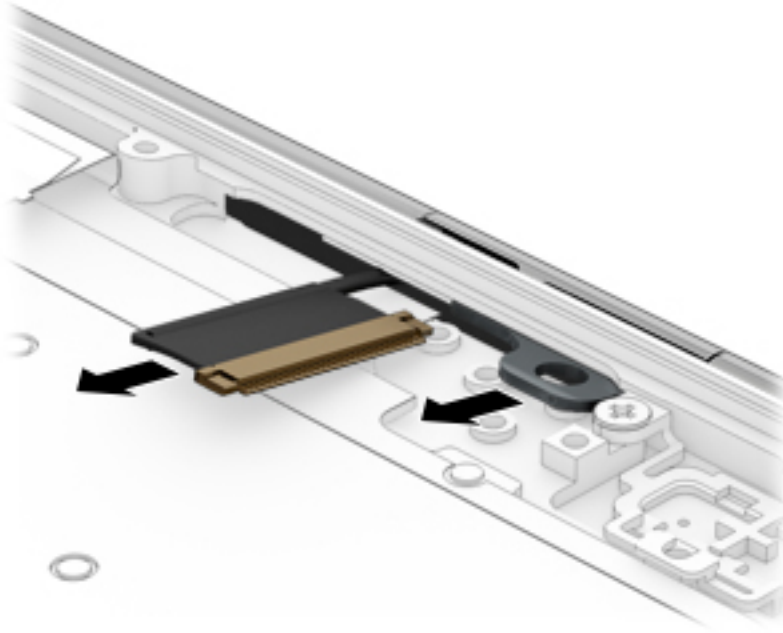

4. Rotate the computer (1), and then install the eight Phillips PM2.0×2.0 screws (2)

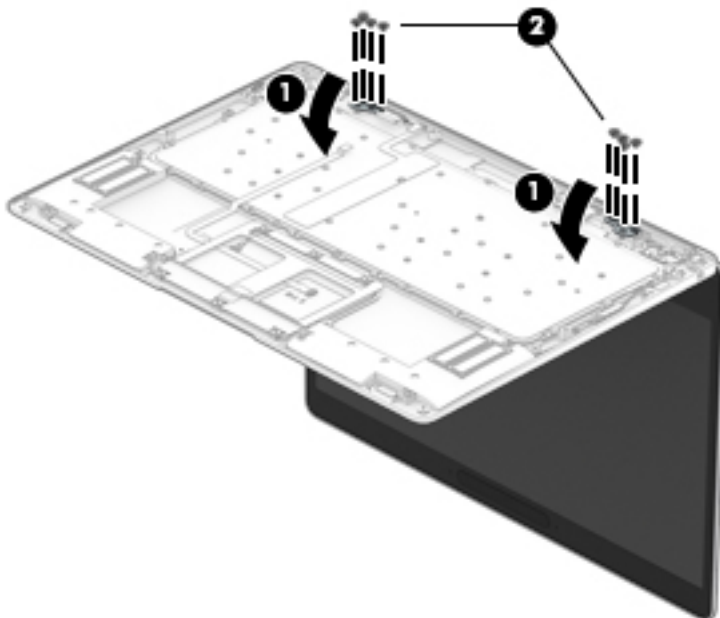

Keyboard

In this section, the first table provides the main spare part number for the keyboard. The second table provides the country codes.

Description	Spare part number
Keyboard (backlit; includes keyboard cable and backlight cable)	850915-xx1

For use in country or region	Spare part number	For use in country or region	Spare part number	For use in country or region	Spare part number
Belgium	-A41	Israel	-BB1	Slovenia	-BA1
Brazil	-201	Italy	-061	South Korea	-AD1
Bulgaria	-261	Japan	-291	Spain	-071
Canada	-DB1	Latin America	-161	Sweden and Finland	-B71
Czech Republic and Slovakia	-FL1	The Netherlands	-B31	Switzerland	-BG1
Denmark	-081	Northern Africa	-FP1	Taiwan	-AB1
France	-051	Norway	-091	Thailand	-281
Germany	-041	Portugal	-131	Turkey	-141
Greece	-151	Romania	-271	Turkey F	-541
Hungary	-211	Russia	-251	United Kingdom	-031
Iceland	-DD1	Saudi Arabia	-171	United States	-001
India	-D61				

Before removing the keyboard, follow these steps:

1. Turn off the computer. If you are unsure whether the computer is off or in Hibernation, turn the computer on, and then shut it down through the operating system.
2. Disconnect the power from the computer by unplugging the power cord from the computer.
3. Disconnect all external devices from the computer.
4. Remove the bottom cover (see [Bottom cover on page 23](#)).
5. Remove the battery (see [Battery on page 25](#)).
6. Remove the system board (see [System board on page 30](#)).

Remove the keyboard:

1. Remove the 48 Phillips PM1.0×1.0 screws that secure the keyboard to the computer.

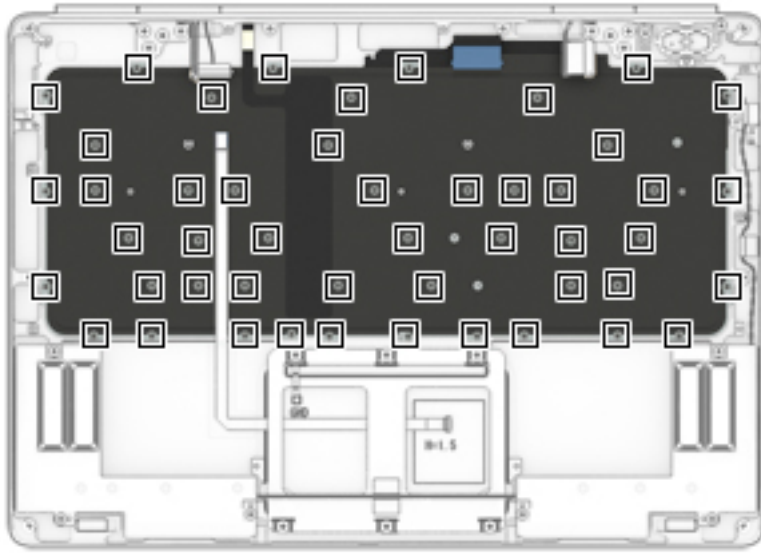

2. Lift the keyboard off the computer.

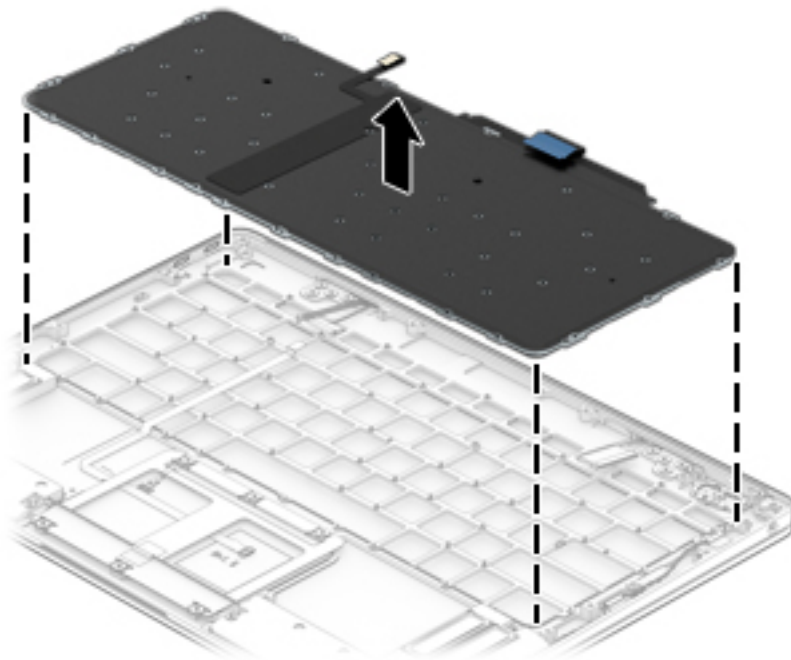

Reverse this procedure to install the keyboard.

Thermal solution kit

Install the thermal solution kit to address system overheating.

Description	Spare part number
Thermal solution kit (includes thermal plate, three graphite sheets, and three thermal pads)	910054-001

Before installing the thermal solution kit, follow these steps:

1. Turn off the computer. If you are unsure whether the computer is off or in Hibernation, turn the computer on, and then shut it down through the operating system.
2. Disconnect the power from the computer by unplugging the power cord from the computer.
3. Disconnect all external devices from the computer.
4. Remove the bottom cover (see [Bottom cover on page 23](#)).
5. Remove the system board (see [System board on page 30](#)).

Install the thermal solution kit:

1. Remove the thermal plate by removing the four Phillips M2.0×3.0 screws (1), and then lifting the thermal plate off the computer (2).

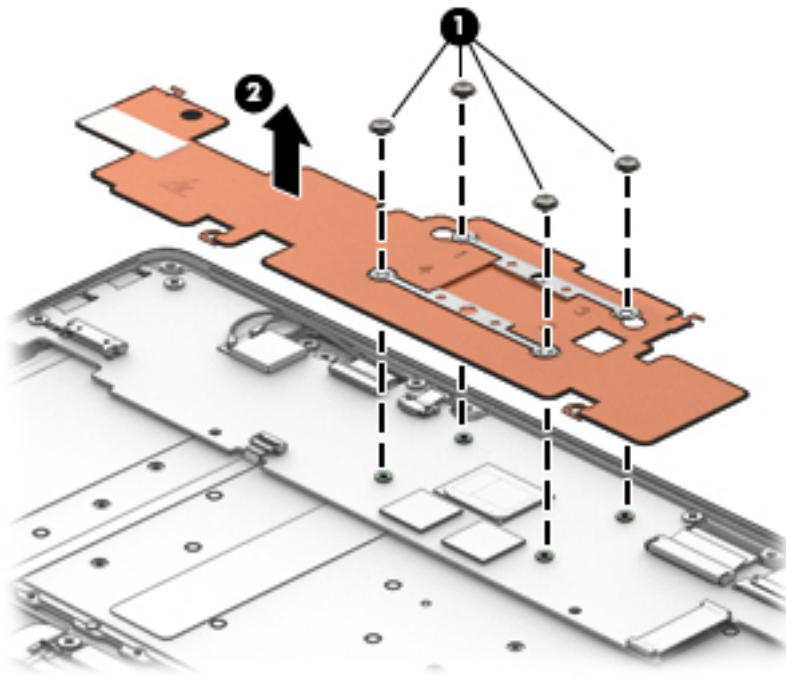

2. Add a graphite sheet (911282-001) to the keyboard and computer chassis.

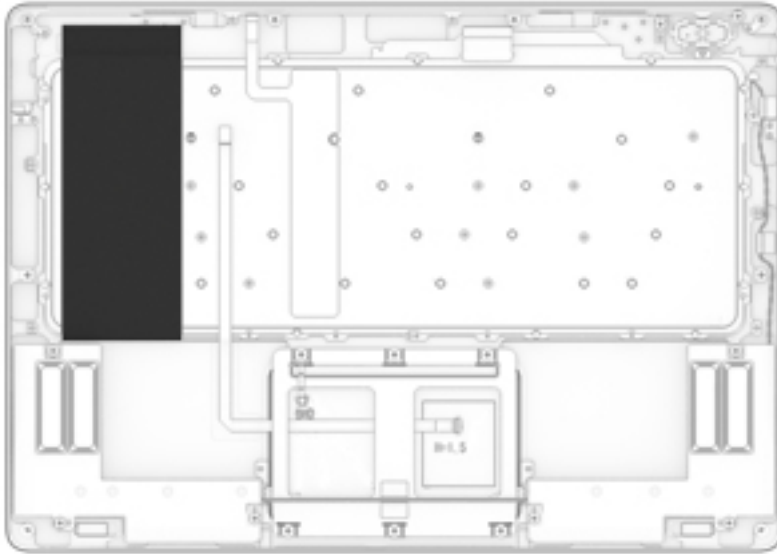

3. Install the new thermal plate (911283-001) **(1)**.
4. Install three thermal pads **(2)** (911286-001), **(3)** (911284-001), and **(4)** (911285-001), to the left of the thermal plate.

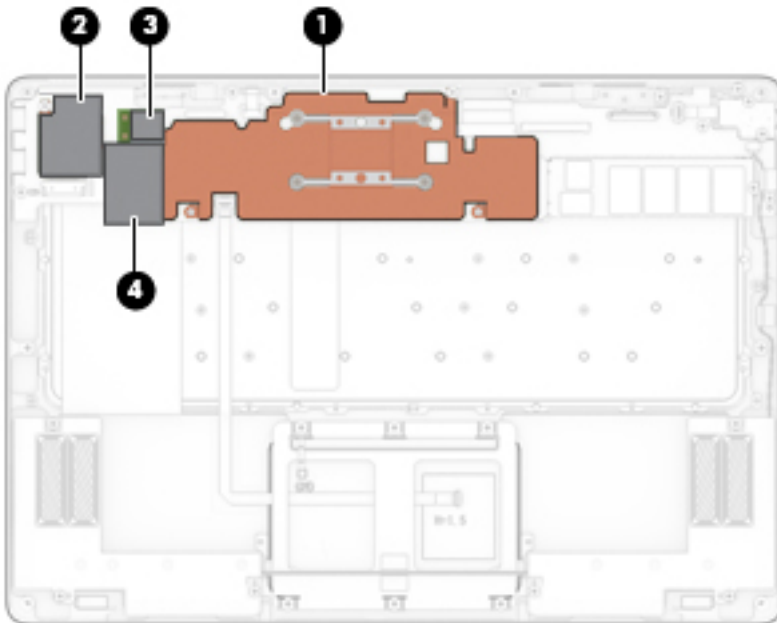

5. Position the bottom cover with the inside facing upward.

6. Add graphite sheets **(1)** (911287-001) and **(2)** (911288-001) on the inside of the bottom cover.

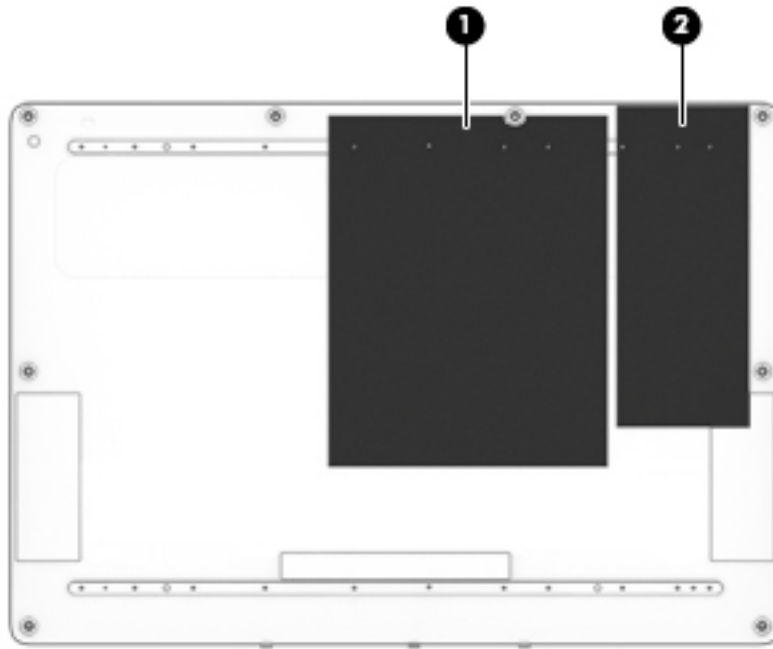

7. Position the battery upside down.
8. Replace the Mylar insulator **(1)** (911281-001) on the bottom of the battery.

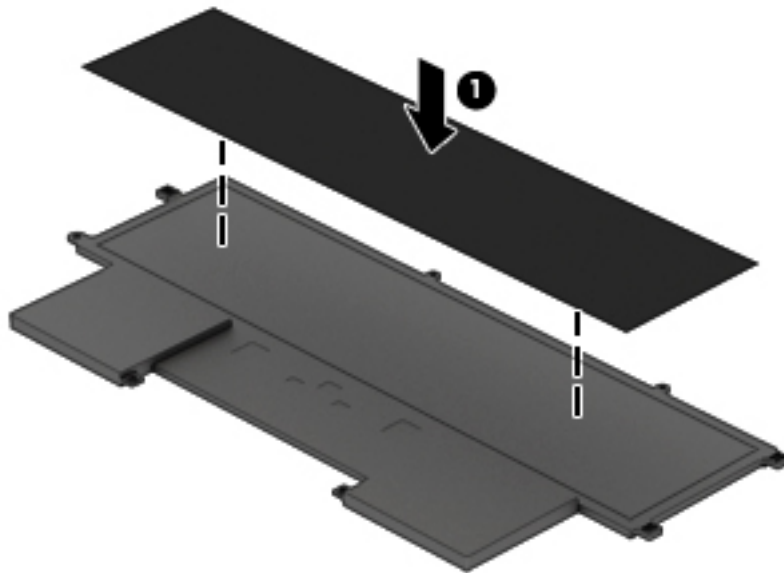

9. Position the battery upright.

10. Replace the Mylar insulator (911290-001) on the left side of the top of the battery (2), and replace the foam piece (911289-001) in the middle of the top of the battery (3).

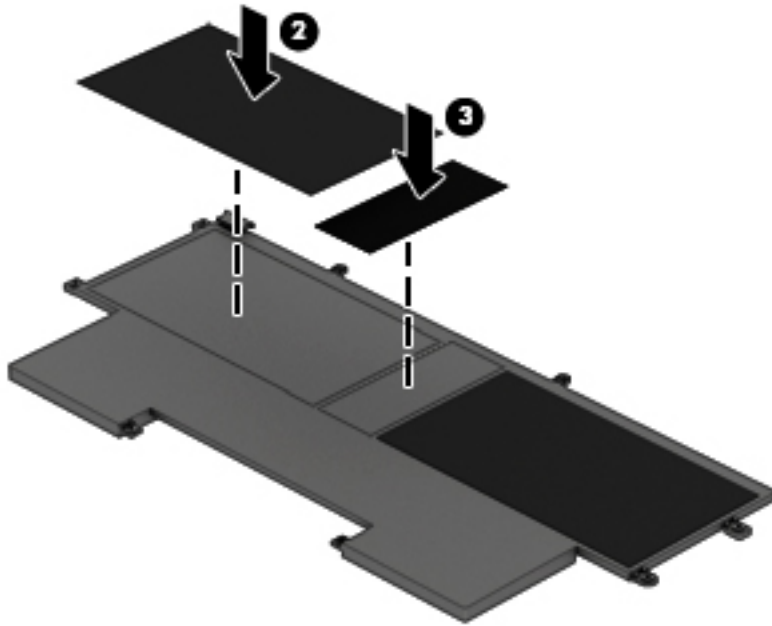

11. Reassemble the computer.

6 Computer Setup (BIOS), TPM, and HP Sure Start in Windows 10

Using Computer Setup

Computer Setup, or Basic Input/Output System (BIOS), controls communication between all the input and output devices on the system (such as disk drives, display, keyboard, mouse, and printer). Computer Setup includes settings for the types of devices installed, the startup sequence of the computer, and the amount of system and extended memory.

 **NOTE:** Use extreme care when making changes in Computer Setup. Errors can prevent the computer from operating properly.

Starting Computer Setup

 **NOTE:** An external keyboard or mouse connected to a USB port can be used with Computer Setup only if USB legacy support is enabled.

To start Computer Setup, follow these steps:

- ▲ Start Computer Setup.
 - Computers or tablets with keyboards:
 - ▲ Turn on or restart the computer, and when the HP logo appears, press **F10** to enter Computer Setup.
 - Tablets without keyboards:
 - ▲ Turn off the tablet. Press the power button in combination with the volume down button until the Startup menu is displayed, and then tap **F10** to enter Computer Setup.

Navigating and selecting in Computer Setup

- To select a menu or a menu item, use the **tab** key and the keyboard arrow keys and then press **enter**, or use a pointing device to select the item.

 **NOTE:** On tablets without keyboards, you can use your finger to make selections.

- To scroll up and down, select the up arrow or the down arrow in the upper-right corner of the screen, or use the up arrow key or the down arrow key on the keyboard.
- To close open dialog boxes and return to the main Computer Setup screen, press **esc**, and then follow the on-screen instructions.

To exit Computer Setup menus, choose one of the following methods:

- To exit Computer Setup menus without saving your changes:
Select the **Exit** icon in the lower-right corner of the screen, and then follow the on-screen instructions.
– or –
Select **Main**, select **Ignore Changes and Exit**, and then press [enter](#).
- To save your changes and exit Computer Setup menus:
Select the **Save** icon in the lower-right corner of the screen, and then follow the on-screen instructions.
– or –
Select **Main**, select **Save Changes and Exit**, and then press [enter](#).

Your changes go into effect when the computer restarts.

Restoring factory settings in Computer Setup

 **NOTE:** Restoring defaults will not change the hard drive mode.

To return all settings in Computer Setup to the values that were set at the factory, follow these steps:

1. Start Computer Setup. See [Starting Computer Setup on page 43](#).
2. Select **Main**, and then select **Apply Factory Defaults and Exit**.

 **NOTE:** On select products, the selections may display **Restore Defaults** instead of **Apply Factory Defaults and Exit**.

3. Follow the on-screen instructions.
4. To save your changes and exit, select the **Save** icon in the lower-right corner of the screen, and then follow the on-screen instructions.
– or –
Select **Main**, select **Save Changes and Exit**, and then press [enter](#).

Your changes go into effect when the computer restarts.

 **NOTE:** Your password settings and security settings are not changed when you restore the factory settings.

Updating the BIOS

Updated versions of the BIOS may be available on the HP website.

Most BIOS updates on the HP website are packaged in compressed files called *SoftPaqs*.

Some download packages contain a file named *Readme.txt*, which contains information regarding installing and troubleshooting the file.

Determining the BIOS version

To decide whether you need to update Computer Setup (BIOS), first determine the BIOS version on your computer.

BIOS version information (also known as *ROM date* and *System BIOS*) can be accessed by pressing **fn+esc** (if you are already in Windows) or by using Computer Setup.

1. Start Computer Setup. See [Starting Computer Setup on page 43](#).
2. Select **Main**, and then select **System Information**.
3. To exit Computer Setup without saving your changes, select the **Exit** icon in the lower-right corner of the screen, and then follow the on-screen instructions.

– or –

Select **Main**, select **Ignore Changes and Exit**, and then press **enter**.

To check for later BIOS versions, see [Downloading a BIOS update on page 45](#).

Downloading a BIOS update

 **CAUTION:** To reduce the risk of damage to the computer or an unsuccessful installation, download and install a BIOS update only when the computer is connected to reliable external power using the AC adapter. Do not download or install a BIOS update while the computer is running on battery power, docked in an optional docking device, or connected to an optional power source. During the download and installation, follow these instructions:

Do not disconnect power on the computer by unplugging the power cord from the AC outlet.

Do not shut down the computer or initiate Sleep.

Do not insert, remove, connect, or disconnect any device, cable, or cord.

1. Type `support` in the taskbar search box, and then select the HP Support Assistant app.
– or –
Select the question mark icon in the taskbar.
2. Select **Updates**, and then select **Check for updates and messages**.
3. Follow the on-screen instructions.
4. At the download area, follow these steps:
 - a. Identify the most recent BIOS update and compare it to the BIOS version currently installed on your computer. Make a note of the date, name, or other identifier. You may need this information to locate the update later, after it has been downloaded to your hard drive.
 - b. Follow the on-screen instructions to download your selection to the hard drive.

Make a note of the path to the location on your hard drive where the BIOS update is downloaded. You will need to access this path when you are ready to install the update.

 **NOTE:** If you connect your computer to a network, consult the network administrator before installing any software updates, especially system BIOS updates.

BIOS installation procedures vary. Follow any instructions that are revealed on the screen after the download is complete. If no instructions are revealed, follow these steps:

1. Type `file` in the taskbar search box, and then select **File Explorer**.
2. Select your hard drive designation. The hard drive designation is typically Local Disk (C:).
3. Using the hard drive path you recorded earlier, open the folder that contains the update.
4. Double-click the file that has an `.exe` extension (for example, `filename.exe`).
The BIOS installation begins.
5. Complete the installation by following the on-screen instructions.

 **NOTE:** After a message on the screen reports a successful installation, you can delete the downloaded file from your hard drive.

Changing the boot order using the f9 prompt

To dynamically choose a boot device for the current startup sequence, follow these steps:

1. Access the Boot Device Options menu:
 - Computers or tablets with keyboards:
 - ▲ Turn on or restart the computer, and when the HP logo appears, press **f9** to enter the Boot Device Options menu.
 - Tablets without keyboards:
 - ▲ Turn off the tablet. Press the power button in combination with the volume down button until the Startup menu is displayed, and then tap **F9** to enter the Boot Device Options menu.
2. Select a boot device, then press **enter**.

TPM BIOS settings (select products only)

 **IMPORTANT:** Before enabling Trusted Platform Module (TPM) functionality on this system, you must ensure that your intended use of TPM complies with relevant local laws, regulations and policies, and approvals or licenses must be obtained if applicable. For any compliance issues arising from your operation/usage of TPM which violates the above mentioned requirement, you shall bear all the liabilities wholly and solely. HP will not be responsible for any related liabilities.

TPM provides additional security for your computer. You can modify the TPM settings in Computer Setup (BIOS).

 **NOTE:** If you change the TPM setting to Hidden, TPM is not visible in the operating system.

To access TPM settings in Computer Setup:

1. Start Computer Setup. See [Starting Computer Setup on page 43](#).
2. Select **Security**, select **TPM Embedded Security**, and then follow the on-screen instructions.

Using HP Sure Start (select products only)

Select computer models are configured with HP Sure Start, a technology that continuously monitors the computer's BIOS for attacks or corruption. If the BIOS becomes corrupted or is attacked, HP Sure Start automatically restores the BIOS to its previously safe state, without user intervention.

HP Sure Start is configured and already enabled so that most users can use the HP Sure Start default configuration. The default configuration can be customized by advanced users.

To access the latest documentation on HP Sure Start, go to <http://www.hp.com/support>, and select your country. Select **Drivers & Downloads**, and then follow the on-screen instructions.

7 Computer Setup (BIOS) and MultiBoot in Windows 7

Using Computer Setup

Computer Setup, or Basic Input/Output System (BIOS), controls communication between all the input and output devices on the system (such as disk drives, display, keyboard, mouse, and printer). Computer Setup includes settings for the types of devices installed, the startup sequence of the computer, and the amount of system and extended memory.

 **NOTE:** Use extreme care when making changes in Computer Setup. Errors can prevent the computer from operating properly.

Starting Computer Setup

 **NOTE:** An external keyboard or mouse connected to a USB port can be used with Computer Setup only if USB legacy support is enabled.

To start Computer Setup, follow these steps:

1. Turn on or restart the computer, and then press **esc** while the “Press the ESC key for Startup Menu” message is displayed at the bottom of the screen.
2. Press **f10** to enter Computer Setup.

Navigating and selecting in Computer Setup

To navigate and select in Computer Setup, follow these steps:

1. Turn on or restart the computer, and then press **esc** while the “Press the ESC key for Startup Menu” message is displayed at the bottom of the screen.

 **NOTE:** You can use either a pointing device (TouchPad, pointing stick, or USB mouse) or the keyboard to navigate and make selections in Computer Setup.

2. Press **f10** to enter Computer Setup.
 - To select a menu or a menu item, use the **tab** key and the keyboard arrow keys and then press **enter**, or use a pointing device to click the item.
 - To scroll up and down, click the up arrow or the down arrow in the upper-right corner of the screen, or use the up arrow key or the down arrow key on the keyboard.
 - To close open dialog boxes and return to the main Computer Setup screen, press **esc**, and then follow the on-screen instructions.

To exit Computer Setup menus, choose one of the following methods:

- To exit Computer Setup menus without saving your changes:
Click the **Exit** icon in the lower-right corner of the screen, and then follow the on-screen instructions.

– or –

- Use the arrow keys to select **Main > Ignore Changes and Exit**, and then press [enter](#).
- To save your changes and exit Computer Setup menus:
Click the **Save** icon in the lower-right corner of the screen, and then follow the on-screen instructions.
– or –
Use the arrow keys to select **Main > Save Changes and Exit**, and then press [enter](#).
- Your changes go into effect when the computer restarts.

Restoring factory settings in Computer Setup

 **NOTE:** Restoring defaults will not change the hard drive mode.

To return all settings in Computer Setup to the values that were set at the factory, follow these steps:

1. Turn on or restart the computer, and then press [esc](#) while the “Press the ESC key for Startup Menu” message is displayed at the bottom of the screen.
2. Press [f10](#) to enter Computer Setup.
3. Use a pointing device or the arrow keys to select **Main > Restore Defaults**.
4. Follow the on-screen instructions.
5. To save your changes and exit, click the **Save** icon in the lower-right corner of the screen, and then follow the on-screen instructions.

– or –

Use the arrow keys to select **Main > Save Changes and Exit**, and then press [enter](#).

Your changes go into effect when the computer restarts.

 **NOTE:** Your password settings and security settings are not changed when you restore the factory settings.

Updating the BIOS

Updated versions of the BIOS may be available on the HP website.

Most BIOS updates on the HP website are packaged in compressed files called *SoftPaqs*.

Some download packages contain a file named *Readme.txt*, which contains information regarding installing and troubleshooting the file.

Determining the BIOS version

To determine whether available BIOS updates contain later BIOS versions than those currently installed on the computer, you need to know the version of the system BIOS currently installed.

BIOS version information (also known as *ROM date* and *System BIOS*) can be revealed by pressing **fn+esc** (if you are already in Windows) or by using Computer Setup.

1. Start Computer Setup.
2. Use a pointing device or the arrow keys to select **Main > System Information**.
3. To exit Computer Setup without saving your changes, click the **Exit** icon in the lower-right corner of the screen, and then follow the on-screen instructions.

– or –

Use the arrow keys to select **Main > Ignore Changes and Exit**, and then press **enter**.

Downloading a BIOS update

 **CAUTION:** To reduce the risk of damage to the computer or an unsuccessful installation, download and install a BIOS update only when the computer is connected to reliable external power using the AC adapter. Do not download or install a BIOS update while the computer is running on battery power, docked in an optional docking device, or connected to an optional power source. During the download and installation, follow these instructions:

Do not disconnect power on the computer by unplugging the power cord from the AC outlet.

Do not shut down the computer or initiate Sleep.

Do not insert, remove, connect, or disconnect any device, cable, or cord.

1. Access Help and Support by selecting **Start > Help and Support**.
2. Select **Updates and tune-ups**, and then select **Check for HP updates now**.
3. At the download area, follow these steps:
 - a. Identify the most recent BIOS update and compare it to the BIOS version currently installed on your computer. Make a note of the date, name, or other identifier. You may need this information to locate the update later, after it has been downloaded to your hard drive.
 - b. Follow the on-screen instructions to download your selection to the hard drive.

If the update is more recent than your BIOS, make a note of the path to the location on your hard drive where the BIOS update is downloaded. You will need to access this path when you are ready to install the update.

 **NOTE:** If you connect your computer to a network, consult the network administrator before installing any software updates, especially system BIOS updates.

BIOS installation procedures vary. Follow any instructions that are revealed on the screen after the download is complete. If no instructions are revealed, follow these steps:

1. Select **Start > Computer**.
2. Click your hard drive designation. The hard drive designation is typically Local Disk (C:).
3. Using the hard drive path you recorded earlier, open the folder on your hard drive that contains the update.
4. Double-click the file that has an .exe extension (for example, *filename.exe*).
The BIOS installation begins.
5. Complete the installation by following the on-screen instructions.

 **NOTE:** After a message on the screen reports a successful installation, you can delete the downloaded file from your hard drive.

Using MultiBoot

About the boot device order

As the computer starts, the system attempts to boot from enabled devices. The MultiBoot utility, which is enabled at the factory, controls the order in which the system selects a boot device. Boot devices can include optical drives, diskette drives, a network interface card (NIC), hard drives, and USB devices. Boot devices contain bootable media or files that the computer needs to start and operate properly.

 **NOTE:** Some boot devices must be enabled in Computer Setup before they can be included in the boot order.

You can change the order in which the computer searches for a boot device by changing the boot order in Computer Setup. You can also press **esc** while the “Press the ESC key for Startup Menu” message is displayed at the bottom of the screen, and then press **f9**. Pressing **f9** displays a menu that shows the current boot devices and allows you to select a boot device. Or, you can use MultiBoot Express to set the computer to prompt you for a boot location each time the computer turns on or restarts.

Choosing MultiBoot preferences

You can use MultiBoot in the following ways:

- To set a new boot order that the computer uses each time it is turned on, by changing the boot order in Computer Setup.
- To dynamically choose the boot device, by pressing **esc** while the “Press the ESC key for Startup Menu” message is displayed at the bottom of the screen, and then pressing **f9** to enter the Boot Device Options menu.
- To use MultiBoot Express to set variable boot orders. This feature prompts you for a boot device each time the computer is turned on or restarted.

Setting a new boot order in Computer Setup

To start Computer Setup and set a boot device order that the computer uses each time it is turned on or restarted, follow these steps:

1. Turn on or restart the computer, and then press **esc** while the “Press the ESC key for Startup Menu” message is displayed at the bottom of the screen.
2. Press **f10** to enter Computer Setup.
3. Use a pointing device or the arrow keys to select the **Legacy Boot Order** list, and then press **enter**.

4. To move the device up in the boot order, use a pointing device to click the up arrow, or press the **+** key.
– or –
To move the device down in the boot order, use a pointing device to click the down arrow, or press the **-** key.
5. To save your changes and exit Computer Setup, click the **Save** icon in the lower-left corner of the screen, and then follow the on-screen instructions.
– or –
Use the arrow keys to select **Main > Save Changes and Exit**, and then press **enter**.

Dynamically choosing a boot device using the f9 prompt

To dynamically choose a boot device for the current startup sequence, follow these steps:

1. Open the Select Boot Device menu by turning on or restarting the computer, and then pressing **esc** while the “Press the ESC key for Startup Menu” message is displayed at the bottom of the screen.
2. Press **f9**.
3. Use a pointing device or the arrow keys to select a boot device, then press **enter**.

Setting a MultiBoot Express prompt

To start Computer Setup and set the computer to display the MultiBoot startup location menu each time the computer is started or restarted, follow these steps:

1. Turn on or restart the computer, and then press **esc** while the “Press the ESC key for Startup Menu” message is displayed at the bottom of the screen.
2. Press **f10** to enter Computer Setup.
3. Use a pointing device or the arrow keys to select **System Configuration > Boot Options**, and then press **enter**.
4. In the **MultiBoot Express Popup Delay (Sec)** field, enter the length of time in seconds that you want the computer to display the startup location menu before it defaults to the current MultiBoot setting. (When 0 is selected, the Express Boot startup location menu is not displayed.)
5. To save your changes and exit Computer Setup, click the **Save** icon in the lower-left corner of the screen, and then follow the on-screen instructions.

– or –

Use the arrow keys to select **Main > Save Changes and Exit**, and then press **enter**.

Your changes go into effect when the computer restarts.

Entering MultiBoot Express preferences

When the Express Boot menu is displayed during startup, you have the following choices:

- To specify a boot device from the Express Boot menu, select your preference within the allotted time, and then press **enter**.
- To prevent the computer from defaulting to the current MultiBoot setting, press any key before the allotted time expires. The computer will not start until you select a boot device and press **enter**.
- To allow the computer to start according to the current MultiBoot settings, wait for the allotted time to expire.

8 Using HP PC Hardware Diagnostics (UEFI)

HP PC Hardware Diagnostics is a Unified Extensible Firmware Interface (UEFI) that allows you to run diagnostic tests to determine whether the computer hardware is functioning properly. The tool runs outside the operating system so that it can isolate hardware failures from issues that are caused by the operating system or other software components.

When HP PC Hardware Diagnostics (UEFI) detects a failure that requires hardware replacement, a 24-digit Failure ID code is generated. This ID code can then be provided to support to help determine how to correct the problem.

 **NOTE:** To start diagnostics on a convertible computer, your computer must be in notebook mode and you must use the keyboard attached.

To start HP PC Hardware Diagnostics (UEFI), follow these steps:

1. Turn on or restart the computer, and quickly press *esc*.
2. Press *f2*.

The BIOS searches three places for the diagnostic tools, in the following order:

- a. Connected USB drive

 **NOTE:** To download the HP PC Hardware Diagnostics (UEFI) tool to a USB drive, see [Downloading HP PC Hardware Diagnostics \(UEFI\) to a USB device on page 54](#).

- b. Hard drive
- c. BIOS

3. When the diagnostic tool opens, select the type of diagnostic test you want to run, and then follow the on-screen instructions.

 **NOTE:** If you need to stop a diagnostic test, press *esc*.

Downloading HP PC Hardware Diagnostics (UEFI) to a USB device

 **NOTE:** The HP PC Hardware Diagnostics (UEFI) download instructions are provided in English only, and you must use a Windows computer to download and create the HP UEFI support environment because only .exe files are offered.

There are two options to download HP PC Hardware Diagnostics to a USB device.

Download the latest UEFI version

1. Go to <http://www.hp.com/go/techcenter/pcdiags>. The HP PC Diagnostics home page is displayed.
2. In the HP PC Hardware Diagnostics section, select the **Download** link, and then select **Run**.

Download any version of UEFI for a specific product

1. Go to <http://www.hp.com/support>.
2. Select **Get software and drivers**.

3. Enter the product name or number.

– or –

Select **Identify now** to let HP automatically detect your product.

4. Select your computer, and then select your operating system.

5. In the **Diagnostic** section, follow the on-screen instructions to select and download the UEFI version you want.

9 Backup and recovery in Windows 10

This chapter provides information about the following processes. The information in the chapter is standard procedure for most products.

- Creating recovery media and backups
- Restoring and recovering your system

For additional information, refer to the HP support assistant app.

▲ Type `support` in the taskbar search box, and then select the **HP Support Assistant** app.

– or –

Click the question mark icon in the taskbar.

 **IMPORTANT:** If you will be performing recovery procedures on a tablet, the tablet battery must be at least 70% charged before you start the recovery process.

IMPORTANT: For a tablet with a detachable keyboard, connect the keyboard to the keyboard dock before beginning any recovery process.

Creating recovery media and backups

The following methods of creating recovery media and backups are available on select products only. Choose the available method according to your computer model.

- Use HP Recovery Manager to create HP Recovery media after you successfully set up the computer. This step creates a backup of the HP Recovery partition on the computer. The backup can be used to reinstall the original operating system in cases where the hard drive is corrupted or has been replaced. For information on creating recovery media, see [Creating HP Recovery media \(select products only\) on page 56](#). For information on the recovery options that are available using the recovery media, see [Using Windows tools on page 57](#).
- Use Windows tools to create system restore points and create backups of personal information.

For more information, see [Recovering using HP Recovery Manager on page 58](#).

 **NOTE:** If storage is 32 GB or less, Microsoft System Restore is disabled by default.

Creating HP Recovery media (select products only)

If possible, check for the presence of the Recovery partition and the Windows partition. From the **Start** menu, select **File Explorer**, and then select **This PC**.

- If your computer does not list the Windows partition and the Recovery partition, you can obtain recovery media for your system from support. See the *Worldwide Telephone Numbers* booklet included with the computer. You can also find contact information on the HP website. Go to <http://www.hp.com/support>, select your country or region, and follow the on-screen instructions.

You can use Windows tools to create system restore points and create backups of personal information, see [Using Windows tools on page 57](#).

- If your computer does list the Recovery partition and the Windows partition, you can use HP Recovery Manager to create recovery media after you successfully set up the computer. HP Recovery media can be used to perform system recovery if the hard drive becomes corrupted. System recovery reinstalls the original operating system and software programs that were installed at the factory and then configures the settings for the programs. HP Recovery media can also be used to customize the system or restore the factory image if you replace the hard drive.
 - Only one set of recovery media can be created. Handle these recovery tools carefully, and keep them in a safe place.
 - HP Recovery Manager examines the computer and determines the required storage capacity for the media that will be required.
 - To create recovery discs, your computer must have an optical drive with DVD writer capability, and you must use only high-quality blank DVD-R, DVD+R, DVD-R DL, or DVD+R DL discs. Do not use rewritable discs such as CD±RW, DVD±RW, double-layer DVD±RW, or BD-RE (rewritable Blu-ray) discs; they are not compatible with HP Recovery Manager software. Or, instead, you can use a high-quality blank USB flash drive.
 - If your computer does not include an integrated optical drive with DVD writer capability, but you would like to create DVD recovery media, you can use an external optical drive (purchased separately) to create recovery discs. If you use an external optical drive, it must be connected directly to a USB port on the computer; the drive cannot be connected to a USB port on an external device, such as a USB hub. If you cannot create DVD media yourself, you can obtain recovery discs for your computer from HP. See the *Worldwide Telephone Numbers* booklet included with the computer. You can also find contact information on the HP website. Go to <http://www.hp.com/support>, select your country or region, and follow the on-screen instructions.
 - Be sure that the computer is connected to AC power before you begin creating the recovery media.
 - The creation process can take an hour or more. Do not interrupt the creation process.
 - If necessary, you can exit the program before you have finished creating all of the recovery DVDs. HP Recovery Manager will finish burning the current DVD. The next time you start HP Recovery Manager, you will be prompted to continue.

To create HP Recovery media:

 **IMPORTANT:** For a tablet with a detachable keyboard, connect the keyboard to the keyboard dock before beginning these steps.

1. Type `recovery` in the taskbar search box, and then select **HP Recovery Manager**.
2. Select **Create recovery media**, and then follow the on-screen instructions.

If you ever need to recover the system, see [Recovering using HP Recovery Manager on page 58](#).

Using Windows tools

You can create recovery media, system restore points, and backups of personal information using Windows tools.

 **NOTE:** If storage is 32 GB or less, Microsoft System Restore is disabled by default.

For more information and steps, see the Get started app.

- ▲ Select the **Start** button, and then select the **Get started** app.

Restore and recovery

There are several options for recovering your system. Choose the method that best matches your situation and level of expertise:



IMPORTANT: Not all methods are available on all products.

- Windows offers several options for restoring from backup, refreshing the computer, and resetting the computer to its original state. For more information see the Get started app.
 - ▲ Select the **Start** button, and then select the **Get started** app.
- If you need to correct a problem with a preinstalled application or driver, use the Reinstall drivers and/or applications option (select products only) of HP Recovery Manager to reinstall the individual application or driver.
 - ▲ Type `recovery` in the taskbar search box, select **HP Recovery Manager**, select **Reinstall drivers and/or applications**, and then follow the on-screen instructions.
- If you want to recover the Windows partition to original factory content, you can choose the System Recovery option from the HP Recovery partition (select products only) or use the HP Recovery media. For more information, see [Recovering using HP Recovery Manager on page 58](#). If you have not already created recovery media, see [Creating HP Recovery media \(select products only\) on page 56](#).
- On select products, if you want to recover the computer's original factory partition and content, or if you have replaced the hard drive, you can use the Factory Reset option of HP Recovery media. For more information, see [Recovering using HP Recovery Manager on page 58](#).
- On select products, if you want to remove the recovery partition to reclaim hard drive space, HP Recovery Manager offers the Remove Recovery Partition option.

For more information, see [Removing the HP Recovery partition \(select products only\) on page 60](#).

Recovering using HP Recovery Manager

HP Recovery Manager software allows you to recover the computer to its original factory state by using the HP Recovery media that you either created or that you obtained from HP, or by using the HP Recovery partition (select products only). If you have not already created recovery media, see [Creating HP Recovery media \(select products only\) on page 56](#).

What you need to know before you get started

- HP Recovery Manager recovers only software that was installed at the factory. For software not provided with this computer, you must either download the software from the manufacturer's website or reinstall the software from the media provided by the manufacturer.



IMPORTANT: Recovery through HP Recovery Manager should be used as a final attempt to correct computer issues.

- HP Recovery media must be used if the computer hard drive fails. If you have not already created recovery media, see [Creating HP Recovery media \(select products only\) on page 56](#).
- To use the Factory Reset option (select products only), you must use HP Recovery media. If you have not already created recovery media, see [Creating HP Recovery media \(select products only\) on page 56](#).
- If your computer does not allow the creation of HP Recovery media or if the HP Recovery media does not work, you can obtain recovery media for your system from support. See the *Worldwide Telephone Numbers* booklet included with the computer. You can also find contact information from the HP

website. Go to <http://www.hp.com/support>, select your country or region, and follow the on-screen instructions.

 **IMPORTANT:** HP Recovery Manager does not automatically provide backups of your personal data. Before beginning recovery, back up any personal data you want to retain.

Using HP Recovery media, you can choose from one of the following recovery options:

 **NOTE:** Only the options available for your computer display when you start the recovery process.

- System Recovery—Reinstalls the original operating system, and then configures the settings for the programs that were installed at the factory.
- Factory Reset—Restores the computer to its original factory state by deleting all information from the hard drive and re-creating the partitions. Then it reinstalls the operating system and the software that was installed at the factory.

The HP Recovery partition (select products only) allows System Recovery only.

Using the HP Recovery partition (select products only)

The HP Recovery partition allows you to perform a system recovery without the need for recovery discs or a recovery USB flash drive. This type of recovery can be used only if the hard drive is still working.

To start HP Recovery Manager from the HP Recovery partition:

 **IMPORTANT:** For a tablet with a detachable keyboard, connect the keyboard to the keyboard dock before beginning these steps (select products only).

1. Type `recovery` in the taskbar search box, select **Recovery Manager**, and then select **HP Recovery Environment**.

- or -

For computers or tablets with keyboards attached, press **f11** while the computer boots, or press and hold **f11** as you press the power button.

For tablets without keyboards:

Turn on or restart the tablet, and then quickly hold down the volume down button; then select **f11**.

- or -

Turn on or restart the tablet, and then quickly hold down the Windows button; then select **f11**.

2. Select **Troubleshoot** from the boot options menu.
3. Select **Recovery Manager**, and then follow the on-screen instructions.

Using HP Recovery media to recover

You can use HP Recovery media to recover the original system. This method can be used if your system does not have an HP Recovery partition or if the hard drive is not working properly.

1. If possible, back up all personal files.
2. Insert the HP Recovery media, and then restart the computer.

 **NOTE:** If the computer does not automatically restart in HP Recovery Manager, change the computer boot order. See [Changing the computer boot order on page 60](#).

3. Follow the on-screen instructions.

Changing the computer boot order

If your computer does not restart in HP Recovery Manager, you can change the computer boot order, which is the order of devices listed in BIOS where the computer looks for startup information. You can change the selection to an optical drive or a USB flash drive.

To change the boot order:

 **IMPORTANT:** For a tablet with a detachable keyboard, connect the keyboard to the keyboard dock before beginning these steps.

1. Insert the HP Recovery media.

2. Access BIOS:

For computers or tablets with keyboards attached:

▲ Turn on or restart the computer or tablet, quickly press **esc**, and then press **f9** for boot options.

For tablets without keyboards:

▲ Turn on or restart the tablet, and then quickly hold down the volume down button; then select **f9**.

- or -

Turn on or restart the tablet, and then quickly hold down the Windows button; then select **f9**.

3. Select the optical drive or USB flash drive from which you want to boot.

4. Follow the on-screen instructions.

Removing the HP Recovery partition (select products only)

HP Recovery Manager software allows you to remove the HP Recovery partition to free up hard drive space.

 **IMPORTANT:** After you remove the HP Recovery partition, you will not be able to perform System Recovery or create HP recovery media from the HP Recovery partition. So before you remove the Recovery partition, create HP Recovery media; see [Creating HP Recovery media \(select products only\) on page 56](#).

 **NOTE:** The Remove Recovery Partition option is only available on products that support this function.

Follow these steps to remove the HP Recovery partition:

1. Type `recovery` in the taskbar search box, and then select **HP Recovery Manager**.

2. Select **Remove Recovery Partition**, and then follow the on-screen instructions.

10 Backup and recovery in Windows 7

Your computer includes HP and Windows tools to help you safeguard your information and retrieve it if you ever need to. These tools will help you return your computer to a proper working state, all with simple steps. This section provides information about the following processes:

- Creating recovery media and backups
- Restoring and recovering your system

Creating recovery media and backups

Recovery after a system failure is only as good as your most recent backup.

1. After you successfully set up the computer, create HP Recovery media. This step creates a Windows 7 operating system DVD and a *Driver Recovery* DVD. The Windows DVD can be used to reinstall the original operating system in cases where the hard drive is corrupted or has been replaced. The *Driver Recovery* DVD installs specific drivers and applications. See [Creating recovery media with HP Recovery Disc Creator on page 61](#).
2. Use Windows Backup and Recovery tools to perform the following:
 - Back up individual files and folders
 - Back up your entire hard drive (select models only)
 - Create system repair discs (select models only) with the installed optical drive (select models only) or an optional external optical drive
 - Create system restore points

 **NOTE:** This guide describes an overview of backing up, restoring, and recovering options. For more details about the tools provided, see Help and Support. To access Help and Support, select **Start > Help and Support**.

 **NOTE:** HP recommends that you print the recovery procedures and save them for later use, in case of system instability.

In case of system failure, you can use the backup files to restore the contents of your computer. See [Backing up your information on page 62](#).

Guidelines

- When creating recovery media or backing up to discs, use any of the following types of discs (purchased separately): DVD+R, DVD+R DL, DVD-R, DVD-R DL, or DVD±RW. The discs you use will depend on the type of optical drive you are using.
- Be sure that the computer is connected to AC power before you start the recovery media creation process or the backup process.

Creating recovery media with HP Recovery Disc Creator

HP Recovery Disc Creator is a software program that offers an alternative way to create recovery media. After you successfully set up the computer, you can create recovery media using HP Recovery Disc Creator. This recovery media allows you to reinstall your original operating system as well as select drivers and

applications if the hard drive becomes corrupted. HP Recovery Disc Creator can create two kinds of recovery DVDs:

- Windows 7 operating system DVD—Installs the operating system without additional drivers or applications.
- *Driver Recovery DVD*—Installs specific drivers and applications only, in the same way that the HP Software Setup utility installs drivers and applications.

Creating recovery media

 **NOTE:** The Windows 7 operating system DVD can be created only once. Thereafter, the option to create that media will not be available after you create a Windows DVD.

To create the Windows DVD:

1. Select **Start > All Programs > Productivity and Tools > HP Recovery Disc Creator**.
2. Select **Windows disk**.
3. From the drop-down menu, select the drive for burning the recovery media.
4. Click the **Create** button to start the burning process.

After the Windows 7 operating system DVD has been created, create the *Driver Recovery DVD*:

1. Select **Start > All Programs > Productivity and Tools > HP Recovery Disc Creator**.
2. Select **Driver disk**.
3. From the drop-down menu, select the drive for burning the recovery media.
4. Click the **Create** button to start the burning process.

Backing up your information

You should create system repair media and your initial backup immediately after initial system setup. As you add new software and data files, you should continue to back up your system on a regular basis to maintain a reasonably current backup. You should also create Windows system repair media (select models only) which can be used to start up (boot) the computer and repair the operating system in case of system instability or failure. Your initial and subsequent backups allow you to restore your data and settings if a failure occurs.

You can back up your information to an optional external hard drive, a network drive, or discs.

Note the following when backing up:

- Store personal files in the Documents library, and back it up regularly.
- Back up templates that are stored in their associated directories.
- Save customized settings that appear in a window, toolbar, or menu bar by taking a screen shot of your settings. The screen shot can be a time-saver if you have to reset your preferences.
- When backing up to discs, number each disc after removing it from the drive.

 **NOTE:** For detailed instructions on various backup and restore options, perform a search for these topics in Help and Support. To access Help and Support, select **Start > Help and Support**.

 **NOTE:** Windows includes the User Account Control feature to improve the security of your computer. You may be prompted for your permission or password for tasks such as installing software, running utilities, or changing Windows settings. Refer to Help and Support. To access Help and Support, select **Start > Help and Support**.

To create a backup using Windows Backup and Restore:

 **NOTE:** The backup process may take over an hour, depending on file size and the speed of the computer.

1. Select **Start > All Programs > Maintenance > Backup and Restore**.
2. Follow the on-screen instructions to set up your backup, create a system image (select models only), or create system repair media (select models only).

Performing a system recovery

In case of system failure or instability, the computer provides the following tools to recover your files:

- Windows recovery tools: You can use Windows Backup and Restore to recover information you have previously backed up. You can also use Windows Startup Repair to fix problems that might prevent Windows from starting correctly.
- **f11** recovery tools (select models only): You can use the **f11** recovery tools to recover your original hard drive image. The image includes the Windows operating system and software programs installed at the factory.

 **NOTE:** If you are unable to boot (start up) your computer and you cannot use the system repair media you previously created (select models only), you must purchase Windows 7 operating system media to reboot the computer and repair the operating system. For additional information, see [Using Windows 7 operating system media on page 64](#).

Using the Windows recovery tools

Using the Windows recovery tools, you can:

- Recover individual files
- Restore the computer to a previous system restore point
- Recover information using recovery tools

 **NOTE:** For detailed instructions on various recovery and restore options, perform a search for these topics in Help and Support. To access Help and Support, select **Start > Help and Support**.

 **NOTE:** Windows includes the User Account Control feature to improve the security of your computer. You may be prompted for your permission or password for tasks such as installing software, running utilities, or changing Windows settings. Refer to Help and Support. To access Help and Support, select **Start > Help and Support**.

To recover information you previously backed up:

1. Select **Start > All Programs > Maintenance > Backup and Restore**.
2. Follow the on-screen instructions to recover your system settings, your computer (select models only), or your files.

To recover your information using Startup Repair, follow these steps:

 **CAUTION:** Some Startup Repair options will completely erase and reformat the hard drive. All files you have created and any software installed on the computer are permanently removed. When reformatting is complete, the recovery process restores the operating system, as well as the drivers, software, and utilities from the backup used for recovery.

1. If possible, back up all personal files.
2. If possible, check for the presence of the Windows partition.
To check for the Windows partition, select **Start > Computer**.



NOTE: If the Windows partition is not listed, you must recover your operating system and programs using the Windows 7 operating system DVD and the *Driver Recovery* media. For additional information, see [Using Windows 7 operating system media on page 64](#).

3. If the Windows partition is listed, restart the computer, and then press **f8** before the Windows operating system loads.
4. Select **Startup Repair**.
5. Follow the on-screen instructions.



NOTE: For additional information on recovering information using the Windows tools, select **Start > Help and Support**.

Using f11 recovery tools (select models only)



CAUTION: Using **f11** completely erases hard drive contents and reformats the hard drive. All files that you have created and any software that you have installed on the computer are permanently removed. The **f11** recovery tool reinstalls the operating system and HP programs and drivers that were installed at the factory. Software not installed at the factory must be reinstalled.

To recover the original hard drive image using **f11**:

1. If possible, back up all personal files.
2. If possible, check for the presence of the HP Recovery partition: click **Start**, right-click **Computer**, click **Manage**, and then click **Disk Management**.



NOTE: If the HP Recovery partition is not listed, you must recover your operating system and programs using the Windows 7 operating system media and the *Driver Recovery* media. For additional information, see [Using Windows 7 operating system media on page 64](#).

3. If the HP Recovery partition is listed, restart the computer, and then press **esc** while the “Press the ESC key for Startup Menu” message is displayed at the bottom of the screen.
4. Press **f11** while the “Press <F11> for recovery” message is displayed on the screen.
5. Follow the on-screen instructions.

Using Windows 7 operating system media

If you cannot use the recovery media you previously created using the HP Recovery Disc Creator (select models only), you must purchase a Windows 7 operating system DVD to reboot the computer and repair the operating system.

To order a Windows 7 operating system DVD, go to the HP website. For U.S. support, go to <http://www.hp.com/support>. For worldwide support, go to http://welcome.hp.com/country/us/en/wwcontact_us.html. You can also order the DVD by calling support. For contact information, see the *Worldwide Telephone Numbers* booklet included with the computer.



CAUTION: Using a Windows 7 operating system DVD completely erases hard drive contents and reformats the hard drive. All files that you have created and any software that you have installed on the computer are permanently removed. When reformatting is complete, the recovery process helps you restore the operating system, as well as drivers, software, and utilities.

To initiate recovery using a Windows 7 operating system DVD:



NOTE: This process takes several minutes.

1. If possible, back up all personal files.
2. Restart the computer, and then insert the Windows 7 operating system DVD into the optical drive before the Windows operating system loads.
3. When prompted, press any keyboard key.
4. Follow the on-screen instructions.
5. Click **Next**.
6. Select **Repair your computer**.
7. Follow the on-screen instructions.

After the repair is completed:

1. Eject the Windows 7 operating system DVD and then insert the *Driver Recovery* DVD.
2. Install the Hardware Enabling Drivers first, and then install Recommended Applications.

11 Specifications

Computer specifications

	Metric	U.S.
Dimensions		
Width	292 mm	11.5 in
Depth	209 mm	8.23 in
Height (non-touch)	11.95 mm	0.47 in
Height (touch)	12.4 mm	0.49 in
Weight		
Non-touch	1.04 kg	2.29 lbs
Touch	1.09 kg	2.41 lbs
Input power		
Operating voltage and current	18.5 V dc @ 3.5 A - 65 W – or – 19.0 V dc @ 4.74 A - 90 W	
Temperature		
Operating	5°C to 35°C	41°F to 95°F
Nonoperating	-20°C to 60°C	-4°F to 140°F
Relative humidity (noncondensing)		
Operating	10% to 90%	
Nonoperating	5% to 95%	
Maximum altitude (unpressurized)		
Operating	-15 m to 3,048 m	-50 ft to 10,000 ft
Nonoperating	-15 m to 12,192 m	-50 ft to 40,000 ft
NOTE: Applicable product safety standards specify thermal limits for plastic surfaces. The device operates well within this range of temperatures.		

M.2 solid-state drive specifications

	128-GB*	240-GB*	256-GB*	512-GB*
Dimensions				
Height	1 mm	1 mm	1 mm	1 mm
Length	50.8 mm	50.8 mm	50.8 mm	50.8 mm
Width	28.9 mm	28.9 mm	28.9 mm	28.9 mm
Weight	< 10 g	< 10 g	< 10 g	< 10 g
Interface type	ATA-7	ATA-7	ATA-7	ATA-7
Transfer rate				
Sequential Read	Up to 520 MB/s	Up to 540 MB/s	Up to 540 MB/s	Up to 500 MB/s
Random Read	Up to 60K IOPs	Up to 41K IOPs	Up to 85K IOPs	Up to 84K IOPs
Sequential Write	Up to 160 MB/s	Up to 490 MB/s	Up to 280 MB/s	Up to 455 MB/s
Random Write	Up to 34K IOPs	Up to 80K IOPs	Up to 67K IOPs	Up to 59K IOPs
Ready time, Maximum (to not busy)	1.0 s	1.0 s	1.0 s	3.0 s
Access times				
Logical	0.1 ms	0.1 ms	0.1	0.1
Total logical sectors	250,069,680	468,862,128	500,118,192	1,000,215,216
Operating temperature				
Operating	0° to 70°C (32°F to 158°F)	0° to 70°C (32°F to 158°F)	0° to 70°C (32°F to 158°F)	0° to 70°C (32°F to 158°F)
Non-operating	-40° to 95°C (-40°F to 203°F)	-40° to 85°C (-40°F to 185°F)	-55° to 90°C (-67°F to 194°F)	-40° to 85°C (-40°F to 185°F)

*1 GB = 1 billion bytes when referring to hard drive storage capacity. Actual accessible capacity is less.

NOTE: Certain restrictions and exclusions apply. Contact technical support for details.

M.2 PCIe solid-state drive specifications

	256-GB*
Dimensions	
Height	1 mm
Length	50.8 mm
Width	28.9 mm
Weight	< 10 g
Interface type	
	ATA-7
Transfer rate	
Sequential Read	Up to 2150 MB/s
Random Read	Up to 300,000 IOPs
Sequential Write	Up to 1260 MB/s
Random Write	Up to 100,000 IOPs
Ready time, Maximum (to not busy)	
	1.0 s
Access times	
Logical	0.1
Total logical sectors	
	500,118,192
Operating temperature	
Operating	0° to 70°C (32°F to 158°F)
Non-operating	-40° to 80°C (-40°F to 176°F)
*1 GB = 1 billion bytes when referring to hard drive storage capacity. Actual accessible capacity is less.	
NOTE: Certain restrictions and exclusions apply. Contact technical support for details.	

12 Statement of memory volatility

The purpose of this chapter is to provide general information regarding nonvolatile memory in HP Business PCs. This chapter also provides general instructions for restoring nonvolatile memory that can contain personal data after the system has been powered off and the hard drive has been removed.

HP Business PC products that use Intel®-based or AMD®-based system boards contain volatile DDR memory. The amount of nonvolatile memory present in the system depends upon the system configuration. Intel-based and AMD-based system boards contain nonvolatile memory subcomponents as originally shipped from HP, assuming that no subsequent modifications have been made to the system and assuming that no applications, features, or functionality have been added to or installed on the system.

Following system shutdown and removal of all power sources from an HP Business PC system, personal data can remain on volatile system memory (DIMMs) for a finite period of time and will also remain in nonvolatile memory. Use the steps below to remove personal data from the PC, including the nonvolatile memory found in Intel-based and AMD-based system boards.

 **NOTE:** If your tablet has a keyboard base, connect to the keyboard base before beginning steps in this chapter.

Current BIOS steps

1. Follow steps (a) through (f) below to restore the nonvolatile memory that can contain personal data. Restoring or reprogramming nonvolatile memory that does not store personal data is neither necessary nor recommended.
 - a. Turn on or restart the computer, and then press **esc** while the "Press the ESC key for Startup Menu" message is displayed at the bottom of the screen.

 **IMPORTANT:** If the **Main** menu displays **Restore Defaults** instead of **Apply Factory Defaults and Exit**, go to [Legacy BIOS Steps on page 70](#).

 **NOTE:** If the system has a BIOS administrator password, enter the password at the prompt.
 - b. Select **Main**, select **Apply Factory Defaults and Exit**, and then select **Yes** to load defaults.
The computer will reboot.
 - c. During the reboot, press **esc** while the "Press the ESC key for Startup Menu" message is displayed at the bottom of the screen.

 **NOTE:** If the system has a BIOS administrator password, enter the password at the prompt.
 - d. Select the **Security** menu, select **Restore Security Settings to Factory Defaults**, and then select **Yes** to restore security level defaults.
The computer will reboot.
 - e. During the reboot, press **esc** while the "Press the ESC key for Startup Menu" message is displayed at the bottom of the screen.

 **NOTE:** If the system has a BIOS administrator password, enter the password at the prompt.
 - f. If an asset or ownership tag is set, select the **Security** menu and scroll down to the **Utilities** menu. Select **System IDs**, and then select **Asset Tracking Number**. Clear the tag, and then make the selection to return to the prior menu.

- g. If a DriveLock password is set, select the **Security** menu, and scroll down to **Hard Drive Utilities** under the **Utilities** menu. Select **Hard Drive Utilities**, select **DriveLock**, then uncheck the checkbox for **DriveLock password on restart**. Select **OK** to proceed.
- h. Select the **Main** menu, and then select **Reset BIOS Security to factory default**. Click **Yes** at the warning message.
The computer will reboot.
- i. During the reboot, press **esc** while the “Press the ESC key for Startup Menu” message is displayed at the bottom of the screen.



NOTE: If the system has a BIOS administrator password, enter the password at the prompt.

- j. Select the **Main** menu, select **Apply Factory Defaults and Exit**, select **Yes** to save changes and exit, and then select **Shutdown**.
 - k. Reboot the system. If the system has a Trusted Platform Module (TPM) and/or fingerprint reader, one or two prompts will appear—one to clear the TPM and the other to Reset Fingerprint Sensor; press or tap **F1** to accept or **F2** to reject.
 - l. Remove all power and system batteries for at least 24 hours.
2. Complete one of the following:
- Remove and retain the storage drive.
 - or –
 - Clear the drive contents by using a third party utility designed to erase data from an SSD.
 - or –
 - Clear the contents of the drive by using the following BIOS Setup Secure Erase command option steps:



IMPORTANT: If you clear data using Secure Erase, it cannot be recovered.

- a. Turn on or restart the computer, and then press **esc** while the “Press the ESC key for Startup Menu” message is displayed at the bottom of the screen.
- b. Select the **Security** menu and scroll down to the **Utilities** menu.
- c. Select **Hard Drive Tools**.
- d. Under **Utilities**, select **Secure Erase**, select the hard drive storing the data you want to clear, and then follow the on-screen instructions to continue.

Legacy BIOS Steps

Use the steps for older versions of BIOS.



NOTE: If you already completed the steps in [Current BIOS steps on page 69](#), skip this section.

1. Follow steps (a) through (i) below to restore the nonvolatile memory that can contain personal data. Restoring or reprogramming nonvolatile memory that does not store personal data is neither necessary nor recommended.



NOTE: If you have not already done so, access the BIOS menu.

- Turn on or restart the computer, and then press **esc** while the “Press the ESC key for Startup Menu” message is displayed at the bottom of the screen.

 **NOTE:** If the system has a BIOS administrator password, enter the password at the prompt.

- a. Select **Main**, select **Restore Defaults**, and then select **Yes** to load defaults.
 - b. Select the **Security** menu, select **Restore Security Level Defaults**, and then select **Yes** to restore security level defaults.
 - c. If an asset or ownership tag is set, select the **Security** menu and scroll down to the **Utilities** menu. Select **System IDs**, and then select **Asset Tracking Number**. Clear the tag, and then make the selection to return to the prior menu.
 - d. If a DriveLock password is set, select the **Security** menu, and scroll down to **Hard Drive Tools** under the **Utilities** menu. Select **Hard Drive Tools**, select **DriveLock**, then uncheck the checkbox for **DriveLock password on restart**. Select **OK** to proceed.
 - e. If an Automatic DriveLock password is set, select the **Security** menu, scroll down to **Hard Drive Tools** under the **Utilities** menu. Select **Hard Drive Tools**, scroll down to **Automatic DriveLock**, then select the desired hard drive and disable protection. At the automatic drive lock warning screen, select **Yes** to continue. Repeat this procedure if more than one hard drive has an Automatic DriveLock password.
 - f. Select the **Main** menu, and then select **Reset BIOS Security to factory default**. Click **Yes** at the warning message.
 - g. Select the **Main** menu, select **Save Changes and Exit**, select **Yes** to save changes and exit, and then select **Shutdown**.
 - h. Reboot the system. If the system has a Trusted Platform Module (TPM) and/or fingerprint reader, one or two prompts will appear—one to clear the TPM and the other to Reset Fingerprint Sensor; press or tap **F1** to accept or **F2** to reject.
 - i. Remove all power and system batteries for at least 24 hours.
2. Complete one of the following:
- Remove and retain the storage drive.
 - or –
 - Clear the drive contents by using a third party utility designed to erase data from an SSD.
 - or –
 - Clear the contents of the drive by using the following BIOS Setup Secure Erase command option steps:

 **IMPORTANT:** If you clear data using Secure Erase, it cannot be recovered.

- a. Turn on or restart the computer, and then press **esc** while the "Press the ESC key for Startup Menu" message is displayed at the bottom of the screen.
 - b. Select the **Security** menu and scroll down to the **Utilities** menu.
 - c. Select **Hard Drive Tools**.
 - d. Under **Utilities**, select **Secure Erase**, select the hard drive storing the data you want to clear, and then follow the on-screen instructions to continue.
- or –
- Clear the contents of the drive by using the following Disk Sanitizer command steps:

 **IMPORTANT:** If you clear data using Disk Sanitizer, it cannot be recovered.

 **NOTE:** The amount of time it takes for Disk Sanitizer to run can take several hours. Plug the computer into an AC outlet before starting.

- a. Turn on or restart the computer, and then press **esc** while the "Press the ESC key for Startup Menu" message is displayed at the bottom of the screen.
- b. Select the **Security** menu and scroll down to the **Utilities** menu.
- c. Select **Hard Drive Tools**.
- d. Under **Utilities**, select **Disk Sanitizer**, select the hard drive storing the data you want to clear, and then follow the on-screen instructions to continue.

Nonvolatile memory usage

Nonvolatile Memory Type	Amount (Size)	Does this memory store customer data?	Does this memory retain data when power is removed?	What is the purpose of this memory?	How is data input into this memory?	How is this memory write-protected?
HP Sure Start flash (select models only)	2 MBytes	No	Yes	Provides protected backup of critical System BIOS code, EC firmware, and critical PC configuration data for select platforms that support HP Sure Start. For more information, see Using HP Sure Start (select models only) on page 76.	Data cannot be written to this device via the host processor. The content is managed solely by the HP Sure Start Embedded Controller.	This memory is protected by the HP Sure Start Embedded Controller.
Real Time Clock (RTC) battery backed-up CMOS configuration memory	256 Bytes	No	Yes	Stores system date and time and noncritical data.	RTC battery backed-up CMOS is programmed using the Computer Setup (BIOS), or changing the Microsoft Windows date & time.	This memory is not write-protected.
Controller (NIC) EEPROM	64 KBytes (not customer accessible)	No	Yes	Stores NIC configuration and NIC firmware.	NIC EEPROM is programmed using a utility from the NIC vendor that can be run from DOS.	A utility is required to write data to this memory and is available from the NIC vendor. Writing data to this ROM in an inappropriate manner will render the NIC non-functional.
DIMM Serial Presence Detect (SPD) configuration data	256 Bytes per memory module, 128 Bytes programmable (not customer accessible)	No	Yes	Stores memory module information.	DIMM SPD is programmed by the memory vendor.	Data cannot be written to this memory when the module is installed in a PC. The specific write-protection method varies by memory vendor.
System BIOS	4 MBytes to 5 MBytes	Yes	Yes	Stores system BIOS code and PC configuration data.	System BIOS code is programmed at the factory. Code is updated when the system BIOS is updated. Configuration data and settings are input using the Computer Setup (BIOS) or a custom utility.	NOTE: Writing data to this ROM in an inappropriate manner can render the PC non-functional. A utility is required for writing data to this memory and is available on the HP website; go to http://www.hp.com/support . Select Find your product , and then follow

Nonvolatile Memory Type	Amount (Size)	Does this memory store customer data?	Does this memory retain data when power is removed?	What is the purpose of this memory?	How is data input into this memory?	How is this memory write-protected?
Intel Management Engine Firmware (present in only specific ZBook and EliteBook models. For more information, go to http://www.hp.com/support . Select Find your product , and then follow the on-screen instructions.)	1.5 MBytes or 5 MBytes	Yes	Yes	Stores Management Engine Code, Settings, Provisioning Data and iAMT third-party data store.	Management Engine Code is programmed at the factory. Code is updated via Intel secure firmware update utility. Unique Provisioning Data can be entered at the factory or by an administrator using the Management Engine (MEBx) setup utility. The third party data store contents can be populated by a remote management console or local applications that have been registered by an administrator to have access to the space.	the on-screen instructions. The Intel chipset is configured to enforce hardware protection to block all direct read/write access to this area. An Intel utility is required for updating the firmware. Only firmware updates digitally signed by Intel can be applied using this utility.
Bluetooth flash	2 Mbit	No	Yes	Stores Bluetooth configuration and firmware.	Bluetooth flash is programmed at the factory. Tools for writing data to this memory are not publicly available but can be obtained from the silicon vendor.	A utility is required for writing data to this memory and is made available through newer versions of the driver whenever the flash requires an upgrade.
802.11 WLAN EEPROM	4 Kbit to 8 Kbit	No	Yes	Stores configuration and calibration data.	802.11 WLAN EEPROM is programmed at the factory. Tools for writing data to this memory are not made public.	A utility is required for writing data to this memory and is typically not made available to the public unless a firmware upgrade is necessary to address a unique issue.
Web camera	64 Kbit	No	Yes	Stores webcam configuration and firmware.	Webcam memory is programmed using a utility from the device manufacturer that can be run from Windows.	A utility is required for writing data to this memory and is typically not made available to the public unless a firmware upgrade is necessary to address a unique issue.
Fingerprint reader	512 KByte flash	Yes	Yes	Stores fingerprint templates.	Fingerprint reader memory is programmed by user enrollment in HP ProtectTools Security Manager.	Only a digitally signed application can make the call to write to the flash.

Questions and answers

1. How can the BIOS settings be restored (returned to factory settings)?



IMPORTANT: Restore defaults does not securely erase any data on your hard drive. See question and answer 6 for steps to securely erase data.

Restore defaults does not reset the Custom Secure Boot keys. See question and answer 7 for information about resetting the keys.

- a. Turn on or restart the computer, and then press **esc** while the "Press the ESC key for Startup Menu" message is displayed at the bottom of the screen.
- b. Select **Main**, and then select **Restore defaults**.
- c. Follow the on-screen instructions.
- d. Select **Main**, select **Save Changes and Exit**, and then follow the on-screen instructions.

2. What is a UEFI BIOS, and how is it different from a legacy BIOS?

The Unified Extensible Firmware Interface (UEFI) BIOS is an industry-standard software interface between the platform firmware and an operating system (OS). It is a replacement for the older BIOS architecture, but supports much of the legacy BIOS functionality.

Like the legacy BIOS, the UEFI BIOS provides an interface to display the system information and configuration settings and to change the configuration of your computer before an OS is loaded. BIOS provides a secure run-time environment that supports a Graphic User Interface (GUI). In this environment, you can use either a pointing device (Touchscreen, TouchPad, pointing stick, or USB mouse) or the keyboard to navigate and make menu and configuration selections. The UEFI BIOS also contains basic system diagnostics.

The UEFI BIOS provides functionality beyond that of the legacy BIOS. In addition, the UEFI BIOS works to initialize the computer's hardware before loading and executing the OS; the run-time environment allows the loading and execution of software programs from storage devices to provide more functionality, such as advanced hardware diagnostics (with the ability to display more detailed system information) and advanced firmware management and recovery software.

HP has provided options in Computer Setup (BIOS) to allow you to run in legacy BIOS, if required by the operating system. Examples of this requirement would be if you upgrade or downgrade the OS.

3. Where does the UEFI BIOS reside?

The UEFI BIOS resides on a flash memory chip. A utility is required to write to the chip.

4. What kind of configuration data is stored on the DIMM Serial Presence Detect (SPD) memory module? How would this data be written?

The DIMM SPD memory contains information about the memory module, such as size, serial number, data width, speed/timing, voltage, and thermal information. This information is written by the module manufacturer and stored on an EEPROM. This EEPROM cannot be written to when the memory module is installed in a PC. Third-party tools do exist that can write to the EEPROM when the memory module is not installed in a PC. Various third-party tools are available to read SPD memory.

5. What is meant by "Restore the nonvolatile memory found in Intel-based system boards"?

This message relates to clearing the Real Time Clock (RTC) CMOS memory that contains PC configuration data.

6. How can the BIOS security be reset to factory defaults and data erased?

 **IMPORTANT:** Resetting will result in the loss of information.

These steps will not reset Custom Secure Boot Keys. See question and answer 7 for information about resetting the keys.

- a. Turn on or restart the computer, and then press **esc** while the "Press the ESC key for Startup Menu" message is displayed at the bottom of the screen.
- b. Select **Main**, and then select **Reset BIOS Security to Factory Default**.
- c. Follow the on-screen instructions.
- d. Select **Main**, select **Save Changes and Exit**, and then follow the on-screen instructions.

7. How can the Custom Secure Boot Keys be reset?

Secure Boot is a feature to ensure that only authenticated code can start on a platform. If you enabled Secure Boot and created Custom Secure Boot Keys, simply disabling Secure Boot will not clear the keys. You must also select to clear the Custom Secure Boot Keys. Use the same Secure Boot access procedure you used to create the Custom Secure Boot Keys, but make the selection to clear or delete all Secure Boot Keys.

- a. Turn on or restart the computer, and then press **esc** while the "Press the ESC key for Startup Menu" message is displayed at the bottom of the screen.
- b. Select the **Security** menu, select **Secure Boot Configuration**, and then follow the on-screen instructions.
- c. At the **Secure Boot Configuration** window, select **Secure Boot**, select **Clear Secure Boot Keys**, and then follow the on-screen instructions to continue.

Using HP Sure Start (select models only)

Select computer models are configured with HP Sure Start, a technology that continuously monitors your computer's BIOS for attacks or corruption. If the BIOS becomes corrupted or is attacked, HP Sure Start restores the BIOS to its previously safe state, without user intervention. Those select computer models ship with HP Sure Start configured and enabled. HP Sure Start is configured and already enabled so that most users can use the HP Sure Start default configuration. The default configuration can be customized by advanced users.

To access the latest documentation on HP Sure Start, go to <http://www.hp.com/support>. Select **Find your product**, and then follow the on-screen instructions.

13 Power cord set requirements

The wide-range input feature of the computer permits it to operate from any line voltage from 100 to 120 volts AC, or from 220 to 240 volts AC.

The 3-conductor power cord set included with the computer meets the requirements for use in the country or region where the equipment is purchased.

Power cord sets for use in other countries and regions must meet the requirements of the country or region where the computer is used.

Requirements for all countries

The following requirements are applicable to all countries and regions:

- The length of the power cord set must be at least **1.5 m** (5.0 ft) and no more than **2.0 m** (6.5 ft).
- All power cord sets must be approved by an acceptable accredited agency responsible for evaluation in the country or region where the power cord set will be used.
- The power cord sets must have a minimum current capacity of 10 amps and a nominal voltage rating of 125 or 250 V AC, as required by the power system of each country or region.
- The appliance coupler must meet the mechanical configuration of an EN 60 320/IEC 320 Standard Sheet C13 connector for mating with the appliance inlet on the back of the computer.

Requirements for specific countries and regions

Country/region	Accredited agency	Applicable note number
Australia	EANSW	1
Austria	OVE	1
Belgium	CEBC	1
Canada	CSA	2
Denmark	DEMKO	1
Finland	FIMKO	1
France	UTE	1
Germany	VDE	1
Italy	IMQ	1
Japan	METI	3
The Netherlands	KEMA	1
Norway	NEMKO	1
The People's Republic of China	COC	5
South Korea	EK	4

Country/region	Accredited agency	Applicable note number
Sweden	SEMKO	1
Switzerland	SEV	1
Taiwan	BSMI	4
The United Kingdom	BSI	1
The United States	UL	2

1. The flexible cord must be Type H05VV-F, 3-conductor, 1.0-mm² conductor size. Power cord set fittings (appliance coupler and wall plug) must bear the certification mark of the agency responsible for evaluation in the country or region where it will be used.
2. The flexible cord must be Type SPT-3 or equivalent, No. 18 AWG, 3-conductor. The wall plug must be a two-pole grounding type with a NEMA 5-15P (15 A, 125 V) or NEMA 6-15P (15 A, 250 V) configuration.
3. The appliance coupler, flexible cord, and wall plug must bear a “T” mark and registration number in accordance with the Japanese Dentori Law. The flexible cord must be Type VCT or VCTF, 3-conductor, 1.00-mm² conductor size. The wall plug must be a two-pole grounding type with a Japanese Industrial Standard C8303 (7 A, 125 V) configuration.
4. The flexible cord must be Type RVV, 3-conductor, 0.75-mm² conductor size. Power cord set fittings (appliance coupler and wall plug) must bear the certification mark of the agency responsible for evaluation in the country or region where it will be used.
5. The flexible cord must be Type VCTF, 3-conductor, 0.75-mm² conductor size. Power cord set fittings (appliance coupler and wall plug) must bear the certification mark of the agency responsible for evaluation in the country or region where it will be used.

14 Recycling

When a non-rechargeable or rechargeable battery has reached the end of its useful life, do not dispose of the battery in general household waste. Follow the local laws and regulations in your area for battery disposal.

HP encourages customers to recycle used electronic hardware, HP original print cartridges, and rechargeable batteries. For more information about recycling programs, see the HP Web site at <http://www.hp.com/recycle>.

Index

- A**
 - AC adapter, spare part numbers 16
 - action keys
 - answers an incoming call 9
 - declines an incoming call 9
 - ends the current call 9
 - initiates a call 9
 - microphone mute 9
 - opens the calendar 9
 - switching screen image 9
 - using 9
 - answers an incoming call, identifying 9
 - audio board
 - spare part number 16
 - audio, product description 1
 - audio-out (headphone)/audio-in (microphone) combo jack, identifying 10
- B**
 - Backup and Restore 63
 - backup tools 61
 - backups 56
 - creating 62
 - recovering 63
 - battery
 - removal 25, 28
 - spare part numbers 16, 25, 28
 - battery light 11
 - BIOS
 - determining version 45, 50
 - downloading an update 45, 50
 - updating 45, 50
 - Blu-ray R/RE DVD±RW SuperMulti DL Drive
 - precautions 20
 - Blu-ray ROM DVD±RW SuperMulti DL Drive
 - precautions 20
 - Bluetooth label 13
 - boot order
 - changing 60
 - bottom 13
- bottom cover
 - removal 23
 - spare part number 16
- buttons
 - power 7
- C**
 - cables, service considerations 19
 - call answer light 6
 - call decline/end light 6
 - caps lock light, identifying 6
 - chipset, product description 1
 - components
 - bottom 12
 - display 4
 - left side 10
 - right side 11
 - top 5
 - computer major components 14
 - Computer Setup
 - navigating and selecting 43, 48
 - restoring factory settings 44, 49
 - computer specifications 66
 - connector, power 11
 - connectors, service considerations 19
- D**
 - declines an incoming call, identifying 9
 - display assembly
 - removal 32
 - display image, switching 9
 - display panel
 - product description 1
 - docking
 - product description 2
 - docking station cable, spare part number 18
 - docking station, spare part number 18
 - Driver Recovery DVD,
 - creating 61
 - using for restore 64
 - drives, preventing damage 20
- DVD-ROM Drive
 - precautions 20
- DVD±RW Double-Layer with SuperMulti Drive
 - precautions 20
- E**
 - electrostatic discharge 20
 - ends the current call, identifying 9
 - equipment guidelines 22
 - esc key, identifying 8
 - Ethernet, product description 2
- F**
 - f11 recovery 64
 - fn key, identifying 8
- G**
 - graphics, product description 1
 - grounding guidelines 20
 - guidelines
 - equipment 22
 - grounding 20
 - packaging 21
 - transporting 21
 - workstation 21
- H**
 - hard drive
 - precautions 20
 - hard drive cover
 - spare part number 23
 - hard drive recovery 64
 - HP PC Hardware Diagnostics (UEFI) using 54
 - HP Recovery Disc Creator, using 61
 - HP Recovery Manager
 - correcting boot problems 60
 - starting 59
 - HP Recovery media
 - creating 56
 - recovery 59
 - HP Recovery partition
 - checking for presence 64
 - recovery 59

- removing 60
- using for recovery 64

HP Sure Start 76

I

- initiates a call, identifying 9
- integrated light, identifying 4
- integrated webcam infrared (IR) light, identifying 4
- internal microphones, identifying 4
- IR camera, identifying 4

J

- jacks
 - audio-out (headphone)/audio-in (microphone) combo 10

K

- keyboard
 - product description 2
 - removal 37
 - spare part numbers 15, 37

- keys
 - esc 8
 - fn 8
 - Windows key 8

L

- labels
 - Bluetooth 13
 - regulatory 13
 - serial number 13
 - service 13
 - wireless certification 13
 - WLAN 13

- legacy support, USB 43, 48

- lights
 - battery 11
 - call answer 6
 - call decline/end 6
 - caps lock 6
 - microphone mute 6
 - power 6
 - TouchPad 6
 - webcam 4
 - wireless 6

M

- M.2 solid-state drive
 - specifications 67, 68

- mass storage device
 - illustrated 16
 - precautions 20
 - spare part numbers 16

- memory
 - nonvolatile 69
 - volatile 69
- memory module
 - product description 1
- microphone
 - product description 1
- microphone mute key, identifying 9
- microphone mute light, identifying 6
- minimized image recovery 59
- minimized image, creating 58
- model name 1
- mouse, spare part numbers 18

N

- nonvolatile memory 69

O

- opens the calendar, identifying 9
- operating system, product description 2
- optical drive
 - precautions 20
- original system recovery 58

P

- packaging guidelines 21
- plastic parts, service considerations 19
- pointing device, product description 2
- ports
 - product description 2
 - USB Type-C Thunderbolt-enabled port and power connector 11
- power button, identifying 7
- power connector, identifying 11
- power cord
 - set requirements 77
 - spare part numbers 16, 17
- power delivery, identifying 11
- power lights 6
- power requirements, product description 2
- primary storage
 - product description 1

- processor
 - product description 1
- product description
 - audio 1
 - chipset 1
 - display panel 1
 - docking 2
 - Ethernet 2
 - graphics 1
 - keyboard 2
 - memory module 1
 - microphone 1
 - operating system 2
 - pointing device 2
 - ports 2
 - power requirements 2
 - primary storage 1
 - processors 1
 - product name 1
 - security 2
 - serviceability 3
 - video 1
 - wireless 2
- product name 1
- product name and number, computer 13

R

- recover
 - options 58
- recovery
 - discs 57, 59
 - HP Recovery Manager 58
 - media 59
 - starting 59
 - supported discs 57
 - system 58
 - USB flash drive 59
 - using HP Recovery media 57
- recovery media
 - creating 56
 - creating using HP Recovery Manager 57
- recovery media, creating 61
- recovery media, using for restore 64
- recovery partition 64
 - removing 60
- recovery tools 61
- recovery tools, Windows 63

- recovery, system 63
- regulatory information
 - regulatory label 13
 - wireless certification labels 13
- removal/replacement
 - procedures 23
- removing personal data from volatile system memory 69
- restoring the hard drive 64

- S**
- screen image, switching 9
- Screw Kit, spare part number 18
- security, product description 2
- serial number 13
- serial number, computer 13
- service considerations
 - cables 19
 - connectors 19
 - plastic parts 19
- service labels, locating 13
- serviceability, product description 3
- setup utility
 - navigating and selecting 43, 48
 - restoring factory settings 44, 49
- solid-state drive
 - precautions 20
 - spare part numbers 15, 16
- speaker assembly
 - removal 27
 - spare part number 15, 27
- speakers, identifying 12
- specifications
 - computer 66
 - M.2 solid-state drive 67, 68
- SSD drive
 - removal 26
 - spare part numbers 26
- Startup Repair, using 63
- supported discs, recovery 57
- Sure Start
 - using 47
- system board
 - removal 30
 - spare part numbers 15, 30
- system memory, removing personal data from volatile 69
- system recovery 58
- system restore point
 - creating 57
- system restore point, creating 56

- T**
- thermal solution kit
 - removal 39
 - spare part number 16, 39
- tools required 19
- top cover
 - spare part number 15
- TouchPad
 - removal 29
 - spare part number 15, 29
- TouchPad light, identifying 6
- TouchPad zone
 - identifying 5
- TPM settings 46
- transporting guidelines 21
- traveling with the computer 13

- U**
- USB legacy support 43, 48
- USB Type-C Thunderbolt-enabled port and power connector, identifying 11

- V**
- video, product description 1

- W**
- webcam and IR camera 4
- webcam infrared (IR) light, identifying 4
- webcam light, identifying 4
- webcam, identifying 4
- Windows
 - system restore point 56, 57
- Windows 7 operating system DVD
 - creating 61
 - using for restore 64
- Windows 7 operating system media
 - creating 61
 - using for restore 64
- Windows key, identifying 8
- Windows Startup Repair, using 63
- Windows tools
 - using 57
- wireless certification label 13
- wireless light 6
- wireless, product description 2
- WLAN antennas, identifying 4
- WLAN device 13
- WLAN label 13
- workstation guidelines 21