



# UNISEN™

## IMMERSIVE SOUND LED LCD HDTV with Integrated Sound Projector

### MODELS

## 154 Series

## 164 Series

## 265 Series

## BASIC OWNER'S GUIDE

This manual provides basic connection, setup, and operating instructions. Please visit our website at [www. Mitsubishi-tv.com](http://www.Mitsubishi-tv.com) to view or download a detailed owner's guide that fully describes the features of this TV. Follow the Support link to the Product Documents page.

- For questions:
  - Visit our website at [www.mitsubishi-tv.com](http://www.mitsubishi-tv.com).
  - E-mail us at [MDEAservice@mdea.com](mailto:MDEAservice@mdea.com).
  - Call Consumer Relations at 800-332-2119 for operational or connection assistance.
- For information on **System Reset**, please see the back cover.
- To order replacement or additional remote controls, visit our website at [www.mitsuparts.com](http://www.mitsuparts.com) or call 800-553-7278.
- **265 Series.** IR emitter cables for NetCommand home-theater control are available for purchase from Mitsubishi. Call 800-553-7278 and request either part number 242D483020 (two-ended cable) or part number 299P254020 (four-ended cable).





## CAUTION

RISK OF ELECTRIC SHOCK  
DO NOT OPEN



CAUTION: TO REDUCE THE RISK OF ELECTRIC SHOCK, DO NOT REMOVE COVER (OR BACK). NO USER SERVICEABLE PARTS INSIDE. REFER SERVICING TO QUALIFIED SERVICE PERSONNEL.



The lightning flash with arrowhead symbol within an equilateral triangle is intended to alert the user of the presence of uninsulated "dangerous voltage" within the product's enclosure that may be of sufficient magnitude to constitute a risk of electric shock to persons.



The exclamation point within an equilateral triangle is intended to alert the user to the presence of important operating and maintenance (servicing) instructions in the literature accompanying the product.

**WARNING:** This product shall be connected to a MAINS socket outlet with a protective earthing connection.

**MAINS DISCONNECTION:** The mains plug is used as the disconnect device. The mains plug shall remain readily operable.

**WARNING:** To reduce the risk of fire or electric shock, do not expose this apparatus to rain or moisture.

This apparatus shall not be exposed to dripping or splashing and no objects filled with liquids, such as vases, shall be placed on the apparatus.

**WARNING:** This product contains chemicals known to the State of California to cause cancer and/or birth defects or other reproductive harm.

**TV WEIGHT:** This TV is heavy. Exercise extreme care when lifting or moving it. Lift or move the TV with a minimum of two adults. To prevent damage to the TV, avoid jarring or moving it while it is turned on. Always power off your TV, unplug the power cord, and disconnect all cables before moving it.

**Note:** Features and specifications described in this owner's guide are subject to change without notice.

**Custom cabinet installation must allow for proper air circulation around the television.**

**NOTE TO CATV SYSTEM INSTALLER:** THIS REMINDER IS PROVIDED TO CALL THE CATV SYSTEM INSTALLER'S ATTENTION TO ARTICLE 820-40 OF THE NEC THAT PROVIDES GUIDELINES FOR THE PROPER GROUNDING AND, IN PARTICULAR, SPECIFIES THAT THE CABLE GROUND SHALL BE CONNECTED TO THE GROUNDING SYSTEM OF THE BUILDING, AS CLOSE TO THE POINT OF CABLE ENTRY AS PRACTICAL.

### Children and TV Viewing

The American Academy of Pediatrics discourages television viewing for children younger than two years of age.

**For assistance call 1(800) 332-2119**

## FCC Declaration of Conformity

Product: LCD Flat Panel HDTV  
Models: LT-55154  
LT-40164, LT-46164, LT-55164  
LT-46265, LT-55265  
Responsible Party: Mitsubishi Digital Electronics America, Inc.  
9351 Jeronimo Road  
Irvine, CA 92618-1904  
Telephone: (800) 332-2119

This device complies with Part 15 of the FCC Rules. Operation is subject to the following two conditions:

- (1) This device may not cause harmful interference, and
- (2) This device must accept any interference received, including interference that may cause undesired operation.

**Note:** This equipment has been tested and found to comply with the limits for a Class B digital device, pursuant to part 15 of the FCC Rules. These limits are designed to provide reasonable protection against harmful interference in a residential installation. This equipment generates, uses and can radiate radio frequency energy and, if not installed and used in accordance with the instructions, may cause harmful interference to radio communications. However, there is no guarantee that interference will not occur in a particular installation. If this equipment does cause harmful interference to radio or television reception, which can be determined by turning the equipment off and on, the user is encouraged to try to correct the interference by one or more of the following measures:

- Reorient or relocate the receiving antenna.
- Increase the separation between the equipment and the receiver.
- Connect the equipment into an outlet on a circuit different from that to which the receiver is connected.
- Consult the dealer or an experienced radio/TV technician for help.

**Changes or modifications not expressly approved by Mitsubishi could cause harmful interference and would void the user's authority to operate this equipment.**

### TV Software

Do not attempt to update the software of this TV with software or USB drives not provided by or authorized by Mitsubishi Digital Electronics America, Inc. Non-authorized software may damage the TV and will not be covered by the warranty.

# Contents

<b>Important Safety Instructions</b> . . . . .	4
<b>Stand Installation</b> . . . . .	5
<b>Wall-Mounting</b> . . . . .	6
<hr/>	
<b>1 Basic Setup and Operation</b>	
Before You Begin . . . . .	7
Remote Control . . . . .	8
Setting Up and Using TV Inputs . . . . .	9
Basic TV Operation . . . . .	11
<hr/>	
<b>2 TV Connections</b>	
Input and Output Jacks . . . . .	13
Cable Routing . . . . .	13
Connection Diagrams . . . . .	14
Connection Types and Audio/Video Quality . . . . .	16
<hr/>	
<b>3 TV Features</b>	
FAV (Favorites) . . . . .	17
ChannelView Channel Listings . . . . .	17
StreamTV™ Internet Media . . . . .	18
Wireless Audio Playback . . . . .	19
Camera Images and Music Files . . . . .	20
Sleep Timer . . . . .	21
Sound Projector . . . . .	22
<hr/>	
<b>4 TV Menus</b>	
Picture . . . . .	24
Sound . . . . .	25
Captions . . . . .	26
Setup . . . . .	27
Inputs . . . . .	28
Lock . . . . .	29
<hr/>	
<b>Appendices</b>	
Appendix A: Programming the Remote Control . . . . .	30
Appendix B: Troubleshooting . . . . .	31
<b>Trademark and License Information</b> . . . . .	33
<b>Mitsubishi TV Software</b> . . . . .	34
<b>Warranty</b> . . . . .	38
<b>Network Service Disclaimer</b> . . . . .	39

## Cleaning Recommendations

Normally, light dusting with a dry, non-scratching duster will keep your TV clean. If cleaning beyond this is needed, please use the following guidelines:

First, turn off the TV and unplug the power cord from the power outlet.

Occasionally clean dust build-up from the air-intake grilles on the back and sides of the TV. Clean using a vacuum cleaner with a brush attachment.

### Top and Sides of the TV

- Gently wipe down your TV with a soft, non-abrasive cloth such as cotton flannel, microfiber, or a clean cloth diaper, lightly moistened with water. Dry with a second dry, soft, non-abrasive cloth.



- For oily dirt, add a few drops of mild liquid detergent, such as dishwashing detergent, to the water used to moisten the cloth. Rinse with a second cloth moistened only with water. Dry with a third dry, soft, non-abrasive cloth.

### Screen

**IMPORTANT**  
**DO NOT apply any type of liquid to the surface of the TV screen.**

- **Use only a soft, dry cloth to clean the LCD screen. Do not use any liquids.**
- Wipe the screen gently with an up and down motion.
- Clean the entire screen evenly, not just sections of the screen.

### General Cleaning Precautions

- DO NOT allow liquid to enter the TV through the ventilation slots or any crevice.
- DO NOT use any strong or abrasive cleaners, as these can scratch the surfaces.
- DO NOT use any cleaners containing ammonia, bleach, alcohol, benzene, or thinners, as these can dull the surfaces.
- DO NOT spray liquids or cleaners directly on the TV's surfaces.
- DO NOT scrub or rub the TV harshly. Wipe it gently.

# Important Safety Instructions

Please read the following safeguards for your TV and retain for future reference. Always follow all warnings and instructions marked on the television.

- 1) Read these instructions.
- 2) Keep these instructions.
- 3) Heed all warnings.
- 4) Follow all instructions.
- 5) Do not use this apparatus near water.
- 6) Clean only with dry cloth.
- 7) Do not block any ventilation openings. Install in accordance with the manufacturer's instructions.
- 8) Do not install near any heat sources such as radiators, heat registers, stoves, or other apparatus (including amplifiers) that produce heat.
- 9) Do not defeat the safety purpose of the polarized or grounding-type plug. A polarized plug has two blades with one wider than the other. A grounding type plug has two blades and a third grounding prong. The wide blade or the third prong are provided for your safety. If the provided plug does not fit into your outlet, consult an electrician for replacement of the obsolete outlet.
- 10) Protect the power cord from being walked on or pinched particularly at plugs, convenience receptacles, and the point where they exit from the apparatus.
- 11) Only use attachments/accessories specified by the manufacturer.
- 12) Use only with the cart, stand, tripod, bracket, or table specified by the manufacturer, or sold with the apparatus. When a cart is used, use caution when moving the cart/apparatus combination to avoid injury from tip-over.
- 13) Unplug this apparatus during lightning storms or when unused for long periods of time.
- 14) Refer all servicing to qualified service personnel. Servicing is required when the apparatus has been damaged in any way, such as power-supply cord or plug is damaged, liquid has been spilled or objects have fallen into the apparatus, the apparatus has been exposed to rain or moisture, does not operate normally, or has been dropped.



EXAMPLE OF ANTENNA GROUNDING

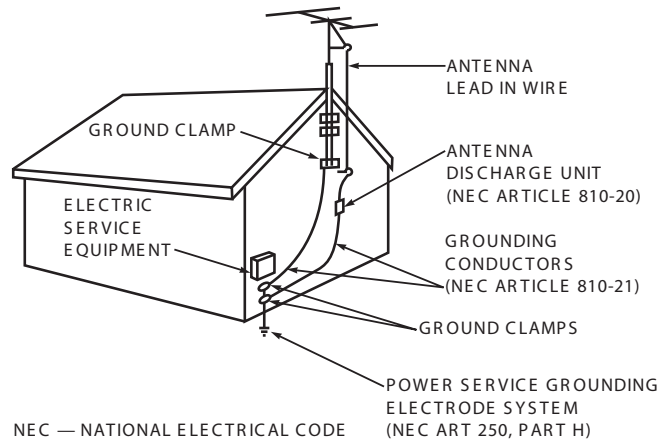

## Outdoor Antenna Grounding

If an outside antenna or cable system is connected to the TV, be sure the antenna or cable system is grounded so as to provide some protection against voltage surges and built-up static charges.

## Replacement Parts

When replacement parts are required, be sure the service technician has used replacement parts specified by the manufacturer or have the same characteristics as the original part. Unauthorized substitutions may result in fire, electric shock or other hazards.

## If Your TV Gets Damaged

Crystalline liquid may leak from the LCD panel and broken glass may be scattered.

**CAUTION: The crystalline liquid is toxic. Avoid contact with your skin, eyes, or mouth. DO NOT touch the broken glass or crystalline liquid. DO NOT get glass fragments or crystalline liquid into eyes or mouth. Should either contact your eyes or mouth, rinse the contacted area thoroughly with water and consult your doctor.**

## Disposal of Your TV

The LCD panel contains a small amount of crystalline liquid which is toxic and should not be touched.

**DO NOT dispose of the TV with general household waste.** For disposal or recycling information, contact your local authorities or the Electronic Industries Alliance at [www.eiae.org](http://www.eiae.org).

## Stand Installation

### CAUTION

- Using this TV with other than the authorized accessories may cause the TV to become unstable, which can cause damage to the product or possible injury.
- At least **TWO PEOPLE** are required to install the stand. Support the TV near the corners as shown. Failure to follow these recommendations may result in personal injury and damage to the product.

### Note

- **40- or 46-inch TV:** If planning to wall-mount the TV, there is no need to install the stand.
- **55-inch TV:** The TV comes from the factory with the stand pre-installed.

Required: Phillips Screwdriver 

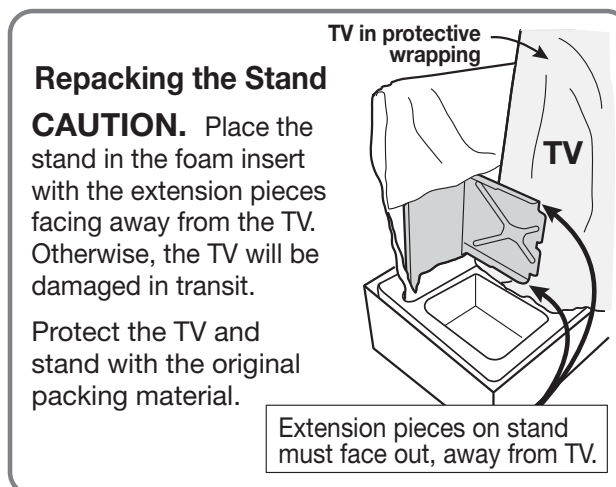
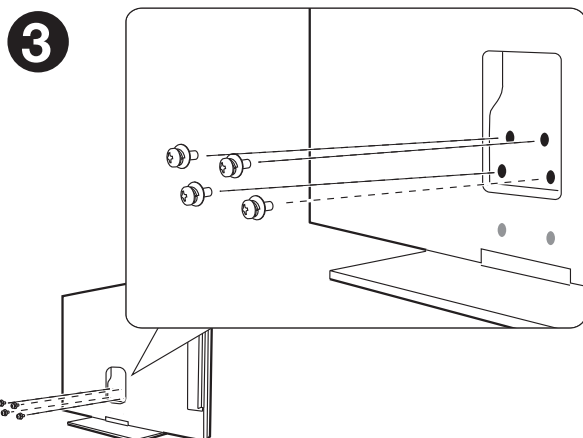
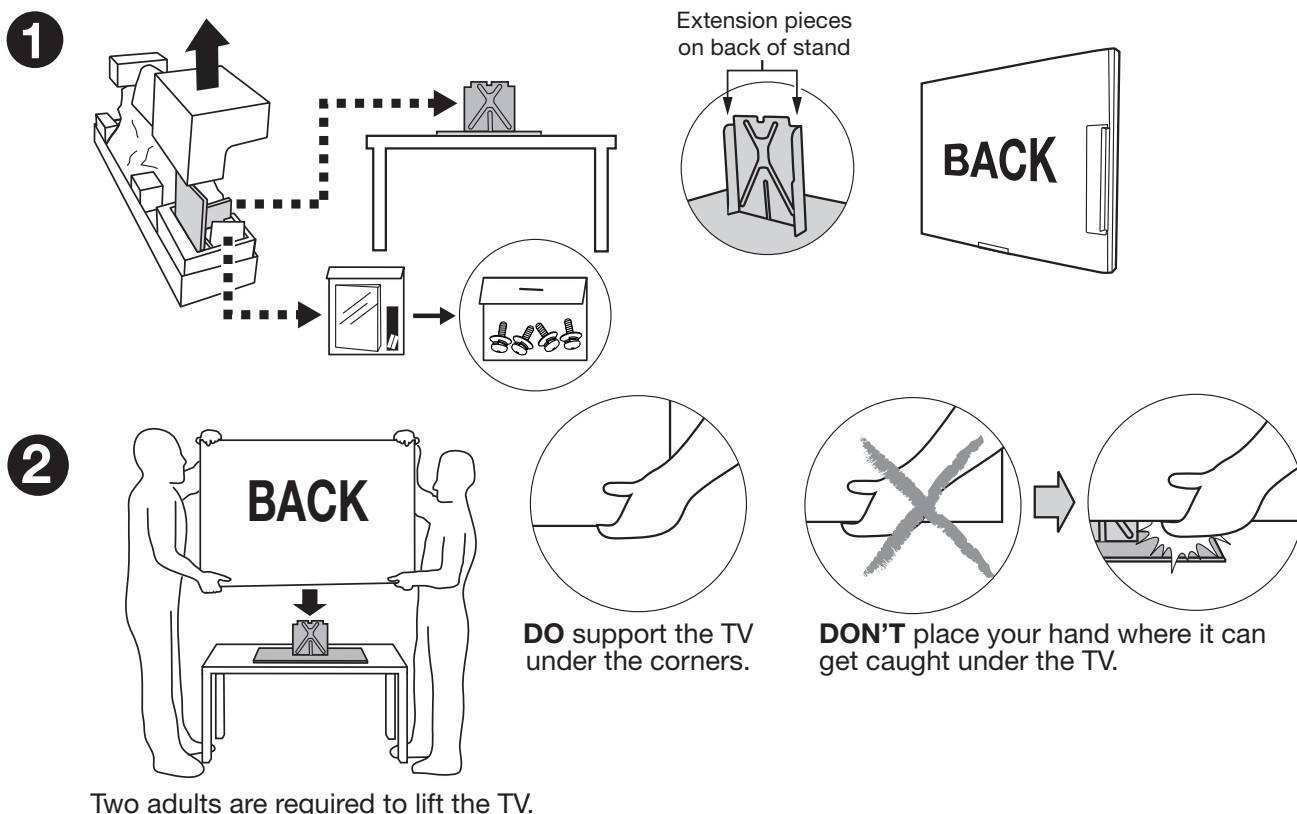

## Wall-Mounting

To order a wall-mount kit, please contact Peerless Industries, Inc. at (800) 473-3753 or visit [www.peerlessmounts.com](http://www.peerlessmounts.com). Order wall-mount kit model ST650.

To order a wall-mount kit from Mitsubishi Digital Electronics America, Inc., please visit [www.mitsuparts.com](http://www.mitsuparts.com) or call (800) 553-7278.

Complete installation instructions are included with the kit.

### Stand Removal Prior to Wall-Mounting

#### CAUTION

**At least TWO PEOPLE are needed to safely remove the stand. Have one person hold the TV while the other person removes the stand. Failure to follow these recommendations may result in personal injury and damage to the product.**

#### Note

- **55-inch TV:** Remove the factory-installed stand prior to wall-mounting.
- **40- or 46-inch TV:** If you installed the stand for table-top use, follow these instructions to remove it prior to wall-mounting the TV.

1. Disconnect the TV's AC power cord from the AC power outlet.
2. Spread the protective sheet that was wrapped around the TV on a flat, even surface, such as a sturdy table. The protective sheet will help prevent damage to the display.

**IMPORTANT: To avoid damaging the screen, make sure there are no foreign objects under or on top of the protective sheet.**

3. Position one person on each side of the TV (left and right sides). Have each person firmly grasp their side of the TV and gently place it face down on the protective sheet with the display stand hanging over the edge of the table. See the illustration to the right.
4. Use a magnetic philips screwdriver to remove the stand screws from the recessed holes (see illustration to right). **Note:** A regular screwdriver can be used with a separate magnetic pick-up tool.
5. While one person holds the TV with both hands, have the other person grasp the stand (see illustration to the right) and remove the stand by pulling it away from the TV in the direction of the large arrow shown in both illustrations.

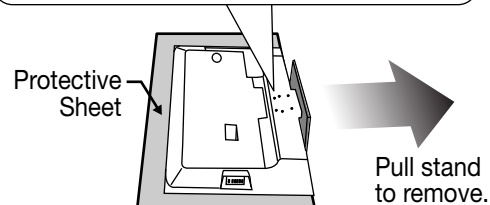
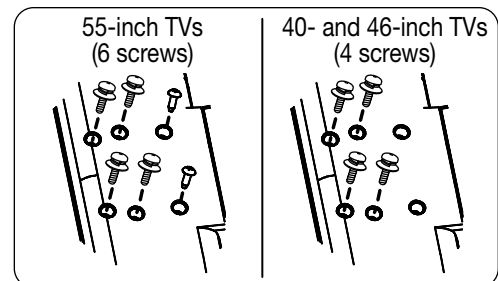
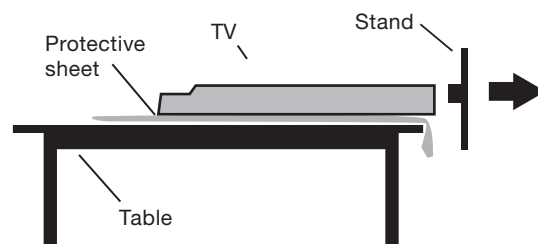

### Service and Customer Support

#### Service

If you are unable to correct a problem with your TV, consult Mitsubishi Consumer Relations at (800) 332-2119.

- DO NOT adjust any controls other than those described in this Owner's Guide.
- DO NOT remove the protective back cover of your TV.

#### Customer Support









- To order replacement or additional remote controls, visit our website at [www.mitsuparts.com](http://www.mitsuparts.com) or call (800) 553-7278.
- For questions:
  - Call Consumer Relations at 800-332-2119.
  - E-mail: [MDEAservice@mdea.com](mailto:MDEAservice@mdea.com)
  - Website: [www.mitsubishi-tv.com](http://www.mitsubishi-tv.com)

**For assistance call 1(800) 332-2119**

# 1 Basic Setup and Operation

## Package Contents

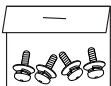
Please take a moment to review the following list of items to ensure that you have received everything.

<b>Remote Control</b>	
<b>Two AA Batteries</b>	
<b>Basic Owner's Guide</b>	
<b>Quick Setup Guide</b>	
<b>Product Registration Card</b>	
<b>Power Cord</b>	
<b>Cable Ties</b>	
<b>Stand Screws (40- and 46-inch TVs only)</b>	
<b>265 Series. Calibration Microphone</b>	

## Installing the Remote Control Batteries

1. Remove the remote control's back cover by gently pressing in the tab and lifting off the cover.
2. Load the batteries, making sure the polarities (+) and (-) are correct. For best results, insert the negative (-) end first.
3. Snap the cover back in place.

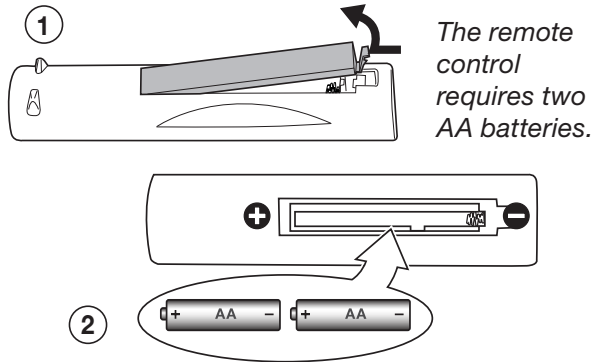

## Before You Begin

1. Review the important safety, installation, and operating information at the beginning of this book.
2. Choose a location for your TV.
  - See the stand-installation or wall-mounting requirements starting on page 5.
  - Allow at least four inches of space on all sides of the TV to help prevent overheating. Overheating may cause premature failure of the TV.
  - Avoid locations where light may reflect off the screen.
3. Install the batteries in the remote control.
4. Plug the TV into an AC power outlet.

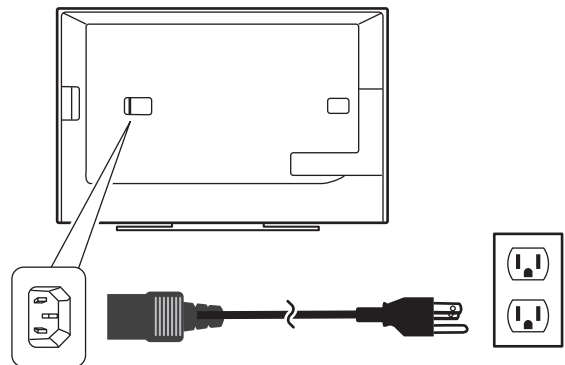

TV power connection

For assistance call 1(800) 332-2119

## Remote Control

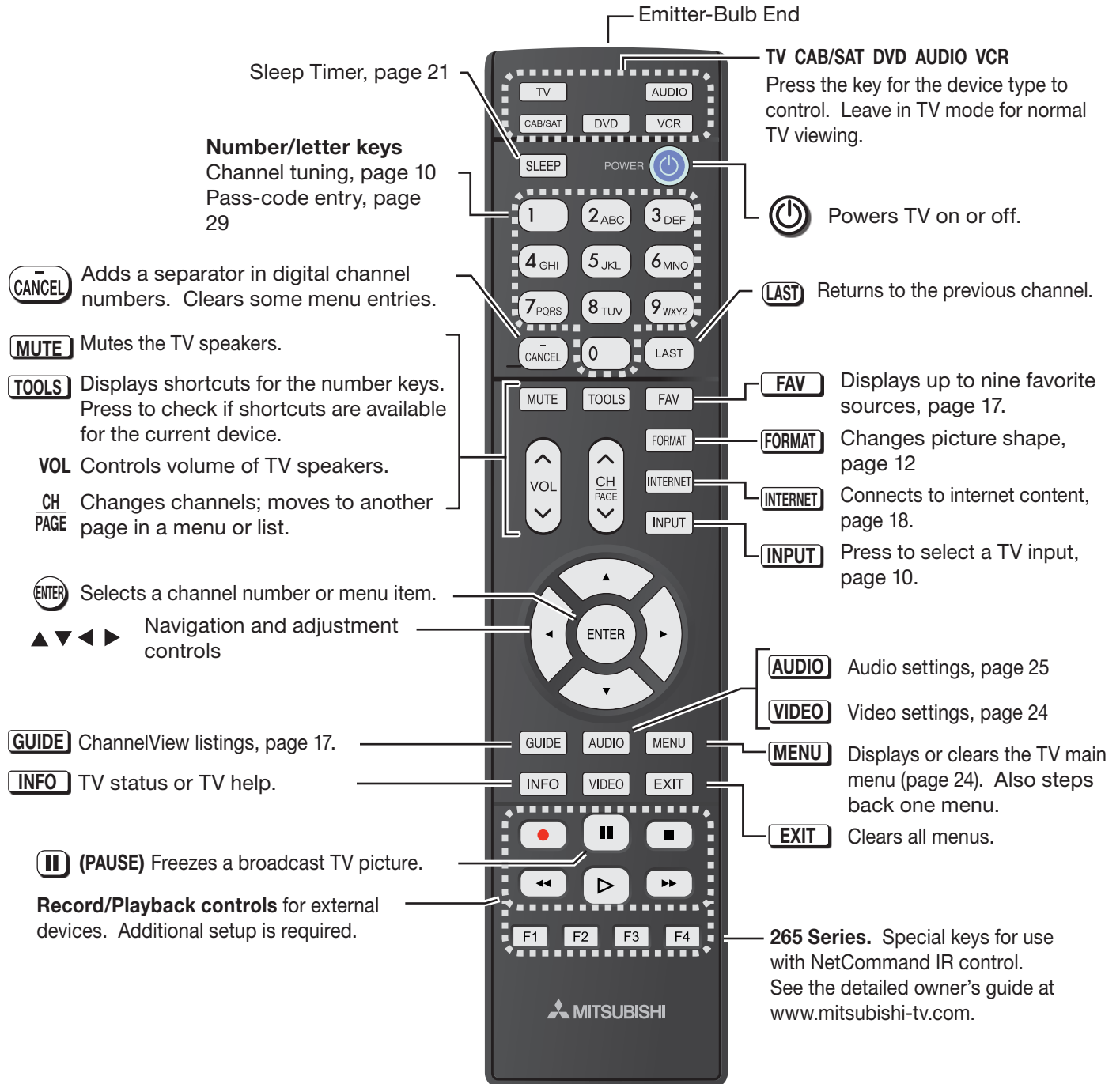

The TV's remote control can operate other audio/video devices using any of these methods:

- Program the remote control for the device.
- Set up HDMI Control for HDMI devices compatible with the TV.
- **265 Series.** Perform NetCommand setup of device keys.

See the detailed owner's guide at [www.mitsubishi-tv.com](http://www.mitsubishi-tv.com) for information.



## First-Time Power-On

1. Press the **TV** key to ensure that the remote control is in TV mode.

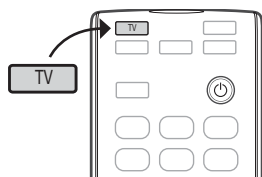

2. Aim the emitter (bulb) end of the remote control at the TV and press the **POWER** key. Wait for the **Welcome** screen.

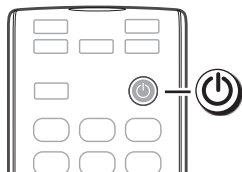

3. If you wish to change the menu language to **Español**, press **▼**.

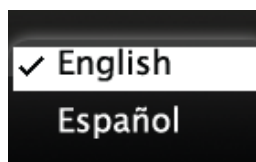

4. Press **▶** to move to the energy-mode selections. Select **Home**.



5. Press **▶** to highlight **EXIT**. Press **ENTER** to clear the menu.



### Welcome Screen Energy Options

- Mitsubishi recommends the **Home** setting, which uses power within ENERGY STAR® guidelines.
- The **Retail** setting looks best under bright lighting. In this mode, the TV uses power in excess of ENERGY STAR guidelines.

This table compares energy choices offered in the **Welcome** screen.

	Home	Retail
<b>Picture Mode</b>	<b>Bright</b>	<b>Brilliant</b>
<b>Backlight Level</b>	Reduced Brightness	Full Brightness

## Setting Up and Using TV Inputs

### Using the ANT (Antenna) Input

If using an antenna or direct cable service (no cable box), connect the incoming coaxial cable to the TV's **ANT** input. Refer to page 16.

**You must perform a channel scan to enable reception of digital channels. If you skip this step, the TV will receive only analog channels.** The channel scan will search for high-definition and standard-definition channels available in the local area.

### Memorizing Channels with Channel Scan

#### For the ANT input

#### To start channel memorization

1. Power on the TV.
2. Press **MENU** and open the **Setup > Channel** menu. First press **▼** to navigate to the Setup icon, then use **▶** to highlight the Channel icon.



Start channel memorization from the Setup > Channel menu.

3. Press **▼** to enter the menu.
4. Highlight **Ant Air** if connected to an over-the-air antenna. Highlight **Ant Cable** for service over direct cable (no cable box). Press **ENTER** to add a check.
5. For first-time setup, highlight **All channels**. To scan for channels not already in memory, highlight **New only**. Press **ENTER** to add a check.
6. Highlight **Scan** and press **ENTER**. Channel memorization may take up to 15 minutes to complete.

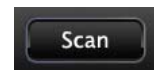
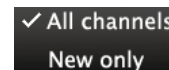

To stop channel memorization before completion, press **CANCEL**.

## Setting Up and Using TV Inputs, continued

### Setting Up Other Inputs

1. Power on the TV.
2. Power on the devices to ensure detection.
3. Connect one device to the TV, making note of the TV input jack.

The TV will display the **New Device Found** screen if the connection type is detectable.

4. Highlight the device type in the on-screen list and press **ENTER**. The name you select here will appear in the **Input Selection** menu.



Sample New Device Found screen.

5. Press **EXIT** to close the **New Device Found** screen.
6. Repeat steps 3 through 5 for each additional device you want to add.

### About Auto Input Sensing

This TV's Easy Connect™ Auto Input Sensing feature detects most input connections automatically. Some exceptions are:

- A connection on the **ANT** input
- TV audio outputs (analog and digital)
- An HDMI-equipped device that is powered off. Power on the device first to ensure detection.
- Ethernet

### Auto Input Sensing for Most Devices

When you first connect a device, the TV will:

- a. Detect the connected device and automatically switch to it.
- b. Prompt you to identify the device type.
- c. Repeat these steps for other newly detected devices.

### Selecting an Input to Watch

1. Press **INPUT**.

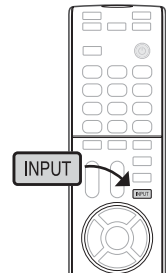

Sample Input Selection menu, antenna input selected

2. Press **◀ ▶** to highlight an input icon.
3. Press **ENTER** to switch to the input.

### Tuning to Channels on the Antenna Input

- Enter the channel number using the number keys on the remote control and press **ENTER**.
- For a two-part digital channel, such as 3-1, press 3 **CANCEL** 1.
- Press **CH ▲/▼** to change channels one channel at a time.
- Press and hold **CH ▲/▼** to speed through channels.
- Press **LAST** to return to the previous channel.
- Use the Fav (Favorites) feature to tune to up to nine favorite channels. See page 17.
- Press **GUIDE** to display ChannelView channel listings, highlight a channel number, and press **ENTER** to tune.

## Basic TV Operation

### Picture Settings

1. To get the best picture under different viewing conditions, set the Picture Mode first before changing other video settings. See page 24 for a description of the options.

- a. Press **VIDEO**.
- b. Press **▼** until the **Picture Mode** option displays.

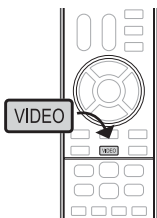

c. Press **▶** to make one of these selections:

Name	When to Use
<b>Brilliant</b>	Under bright light
<b>Game</b>	With gaming consoles (inputs named <b>Game</b> or <b>PC</b> only)
<b>Bright</b>	For most daytime viewing
<b>Natural</b>	For most nighttime viewing

2. Press **▼** to display the name of another adjustment.
3. Press **◀▶** to make the adjustment.
4. Wait a few seconds and the display will clear.

See also these menus:

Menu	Page
<b>Picture &gt; Picture Plus</b>	24
<b>265 Series. Picture &gt; Perfect</b>	25

### Audio Controls

#### Changing the Audio Output

To switch from the internal TV speakers to an external sound system:

1. Press **AUDIO**.
2. Press **▼** to display the **TV Speakers** option.
3. Press **◀▶** to change.



#### Changing Audio Settings (TV Speakers Only)

1. Press **AUDIO**.
2. Press **▼** to display the name of the adjustment you want. See page 25 for options.
3. Press **▶** to change.

#### Controlling Sound Volume

- Press **VOL ▲/▼** to adjust the sound level of the TV speakers.
- See the full owner's guide at [www.mitsubishi-tv.com](http://www.mitsubishi-tv.com) for methods of controlling A/V receiver volume.

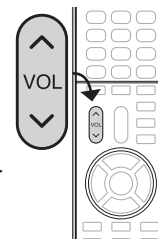

### POWER Indicator

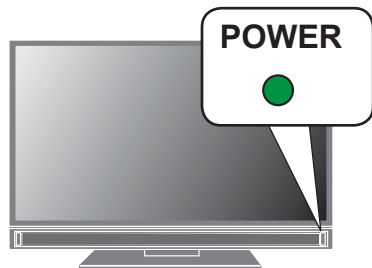

- Key**
- Off
  - Steady On
  - ◐ Slow Blinking
  - ⊙ Fast Blinking

LED Color	TV Condition
None ○	<b>TV is powered off.</b> Normal operation.
Green ●	<b>TV is powered on.</b> Normal operation.
Green ◐	<b>TV powered off, auto-on TV Timer is set.</b> Normal operation. TV can be turned on at any time.
Green ⊙	Software download in progress (applies only if home network is connected). TV cannot be powered on until complete. Do not unplug the TV during download.
Red/ Yellow ●	<p><b>TV may require service.</b></p> <ul style="list-style-type: none"> <li>• Hold power button on front panel for 10 seconds to reset TV.</li> <li>• If LED continues to flash red and yellow after reset, turn off the TV and unplug it from the AC power source. Wait one minute and then plug the set back in.</li> <li>• If LED continues to flash red and yellow, go to <a href="http://www.mitsubishi-tv.com">www.mitsubishi-tv.com</a> or call 1-800-332-2119 to receive Authorized Service Center information.</li> </ul> <p>You may be asked to count how many times the LED flashes each color to assist in troubleshooting.</p>

## Basic TV Operation, continued

### The FORMAT Key and Picture Shape

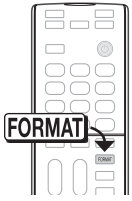

Repeatedly press the **FORMAT** key to cycle through displays available for the current program. The TV will remember the format you last used on each input.

#### Important

**Black bars at the edges of the screen are common in HD pictures. Black bars are not a defect of the TV.**

- Black bars are added by broadcasters to fill the 16:9 screen area while preserving the original aspect ratio of the picture.
- Your cable box or satellite receiver may also be altering the broadcast picture. If your receiver offers output in native format, try using it with Mitsubishi picture formats.

#### Sample Uses of the FORMAT Key

You can use the **FORMAT** key to reduce or eliminate black areas at the edges of the picture.



*Squarish 4:3 image is narrower than the 16:9 screen; unused areas at the sides are filled with black.*

Press  
**FORMAT**



*Wide Expand mode stretches the picture sideways to fill the screen.*

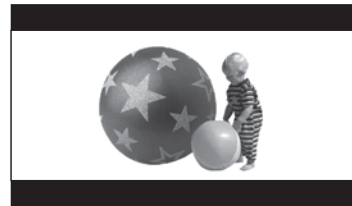

*Wide 2.35:1 anamorphic DVD image; unused areas at the top and bottom are filled with black (letterbox effect).*

Press  
**FORMAT**



*Zoom mode. The picture fills the screen. All four edges are cropped in this mode.*

### More TV Features

Features covered in this Basic Owner's Guide include:

Feature	Page
Parental controls ( <b>Lock</b> menu)	29
TV Clock. Set the TV Clock if you plan to use the TV Timer (page 27) or ChannelView (page 17).	27
Favorite sources	17
ChannelView channel listings	17
Changing input names in the <b>Input Selection</b> menu ( <b>Inputs</b> > <b>Name</b> menu)	28
Digital camera images and music files	20
Programming the Remote Control See the detailed owner's guide at <a href="http://www.mitsubishi-tv.com">www.mitsubishi-tv.com</a> for a complete code list.	30
Internet video streaming	18
<b>265 Series.</b> Listening to a wireless audio device with the TV speakers	19

See the detailed Owner's Guide at [www.mitsubishi-tv.com](http://www.mitsubishi-tv.com) for more on the features described here and to learn about other features, including:

- HDMI control (CEC) of other A/V devices
- Center and rear channel audio output
- Using an external subwoofer
- Using the TV with a computer
- **265 Series.** NetCommand IR control of other A/V devices. Use of NetCommand requires purchase of IR emitter cables from Mitsubishi.

# 2 TV Connections

## Input and Output Jacks

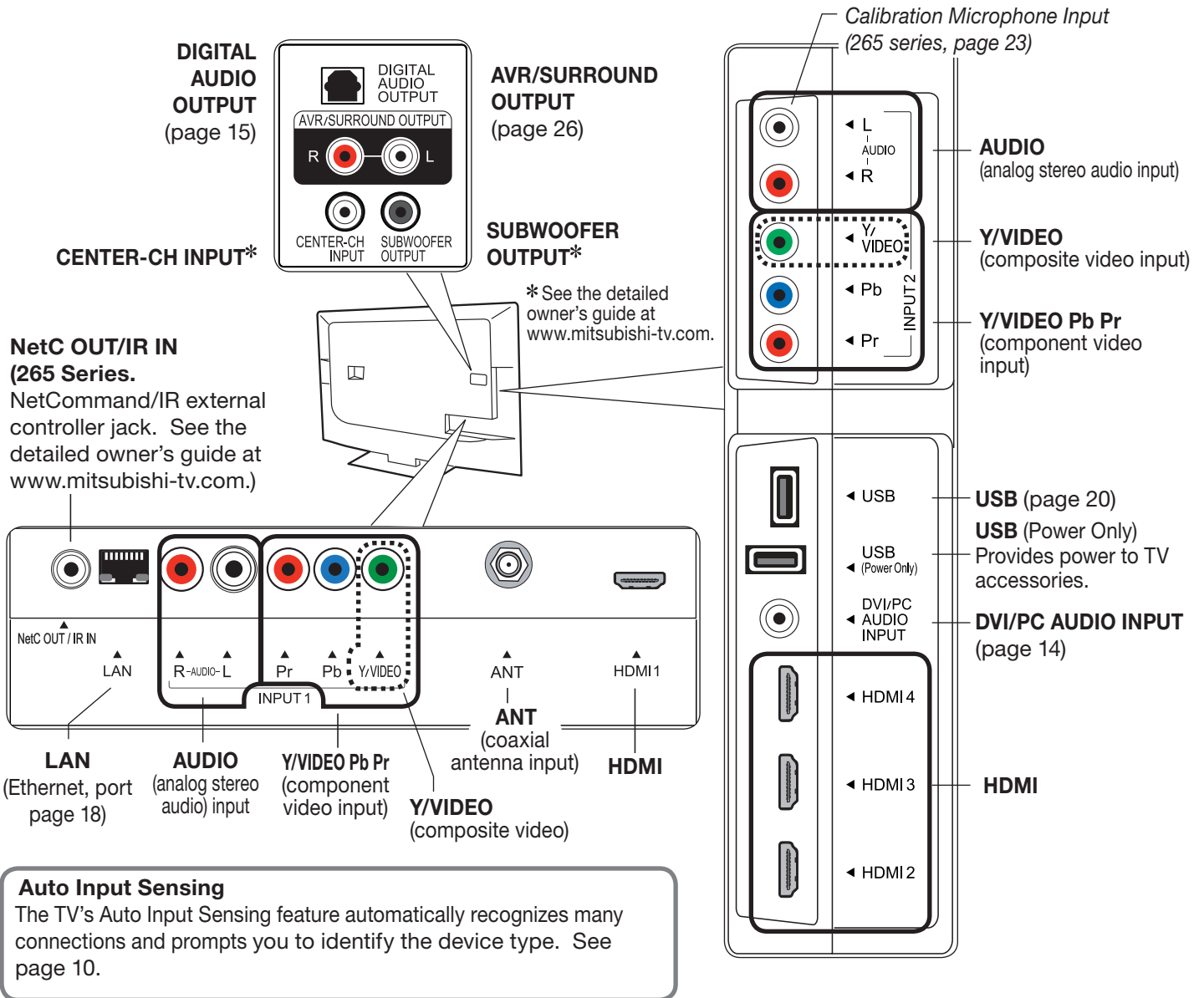

## Cable Routing

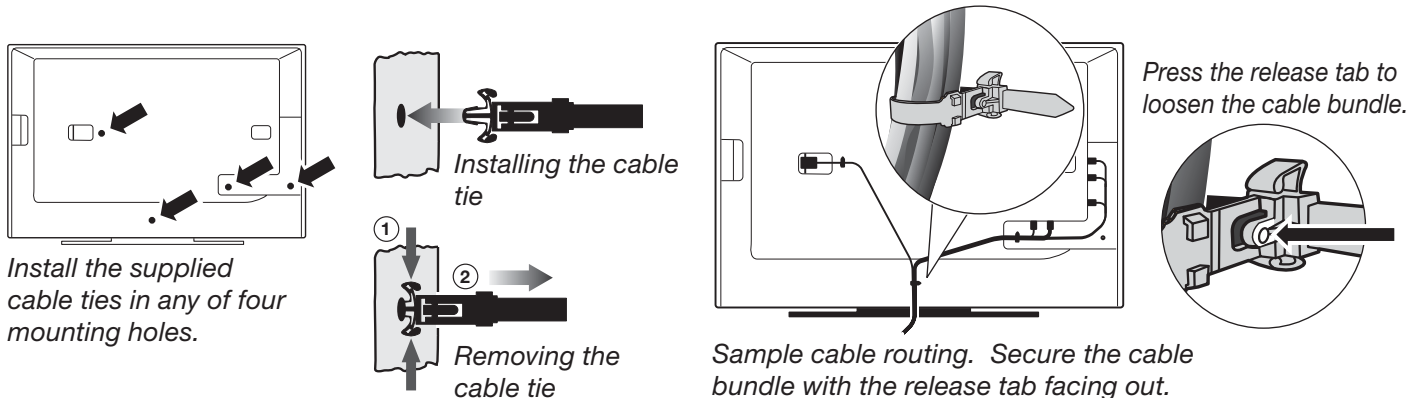

### HDMI Device

Mitsubishi recommends using high-speed HDMI cables to connect newer devices incorporating HDMI technology.

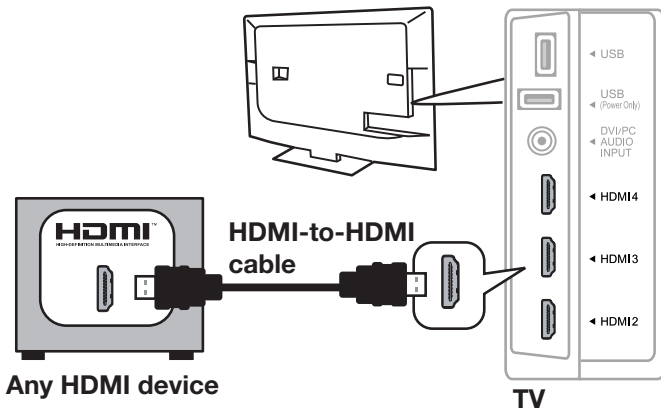

#### HDMI and Digital Surround Sound

The TV's HDMI inputs can receive digital surround sound from an HDMI device. Use an HDMI connection if you want to hear digital surround sound from the TV's internal speaker array.

### Y Pb Pr Component Video Device

Required:

- RCA-type component video cables
- Left/right analog stereo audio cables

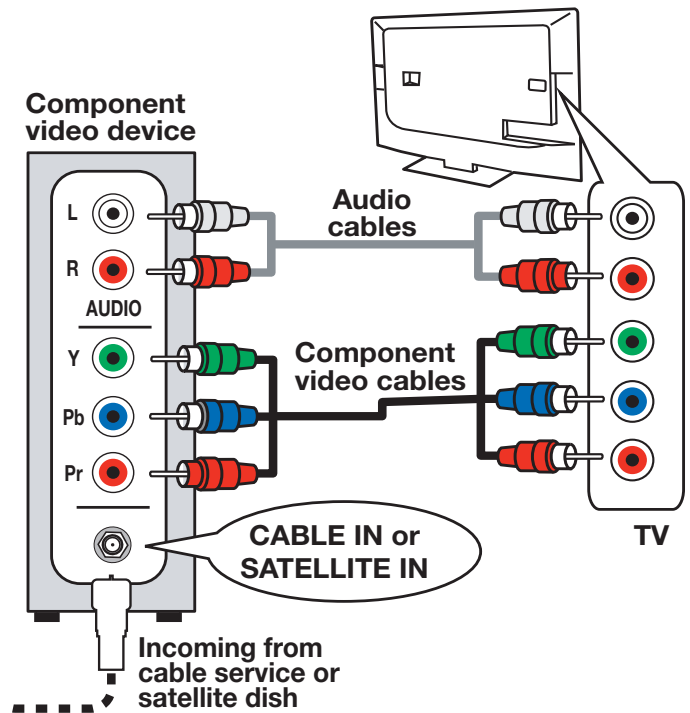

### Composite Video Device

Required:

- Composite video cable (usually yellow)
- Left/right analog stereo audio cables

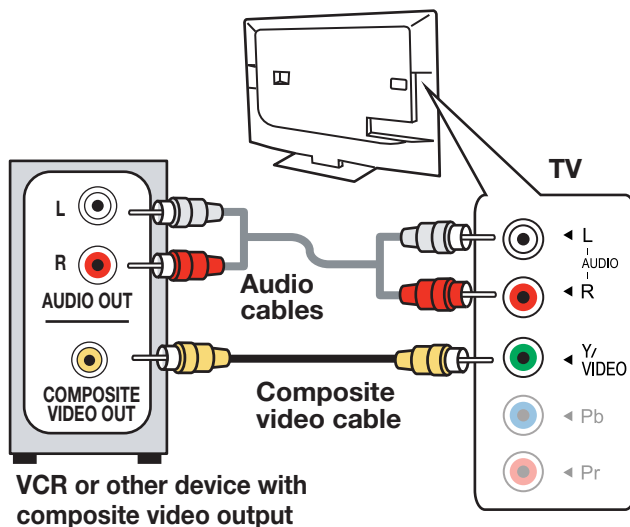

### DVI Video Device

Required:

- DVI-to-HDMI cable or DVI/HDMI adapter and HDMI cable
- Analog stereo cable with mini plugs

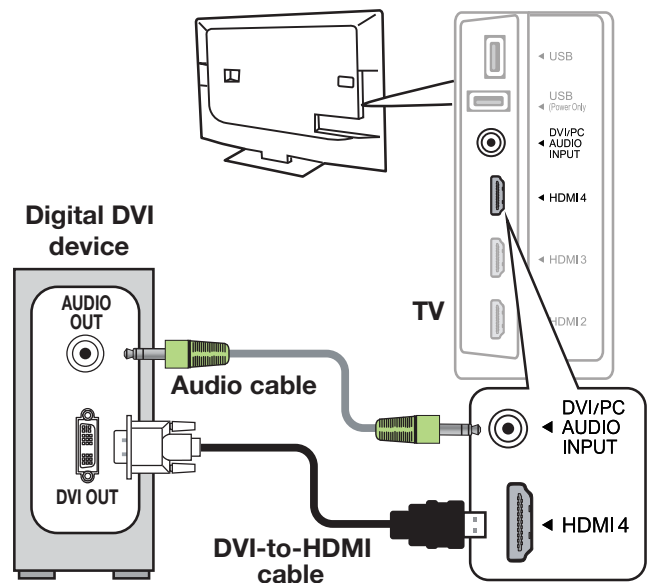

## A/V Receiver

Most setups require either an optical audio cable or analog stereo audio cables. To send audio from TV channels received on the **ANT** input or devices connected directly to the TV, you must use one of the connections shown below.

The TV makes all audio available in digital and analog formats:

- Analog audio coming into the TV is available as output in digital stereo format on the **DIGITAL AUDIO OUTPUT** jack.
- Digital incoming audio is available as analog output on the **AVR/SURROUND L** and **R** jacks.

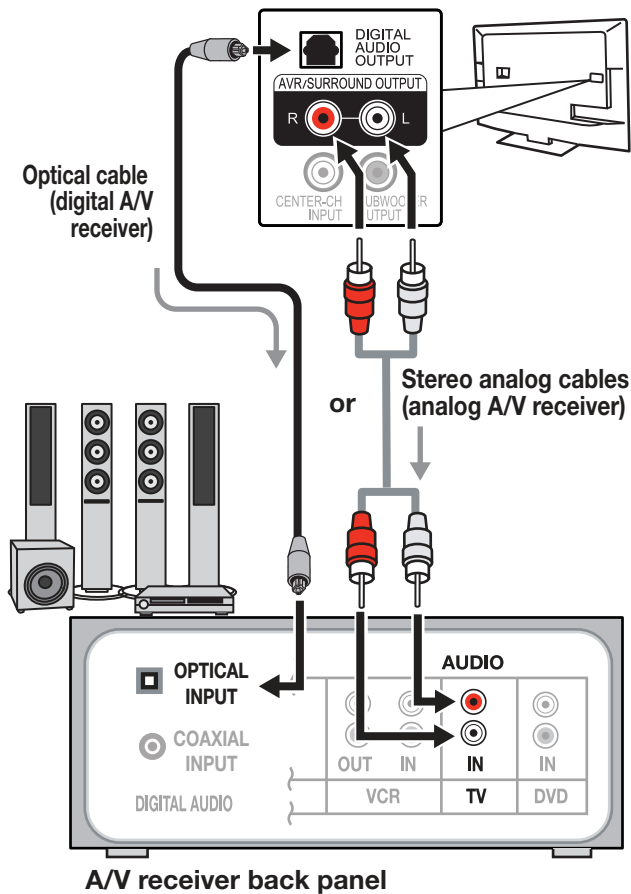

## A/V Receiver with HDMI Output

Required: One HDMI-to-HDMI cable

This option allows you to view content from devices connected to an A/V receiver. The A/V receiver can send audio and video to the TV over a single HDMI cable. You can use an HDMI connection as described here in addition to an audio connection from the TV's audio output. The optional audio connection allows you to hear, through the A/V receiver, devices connected to the TV only, e.g., an antenna on the **ANT** input.

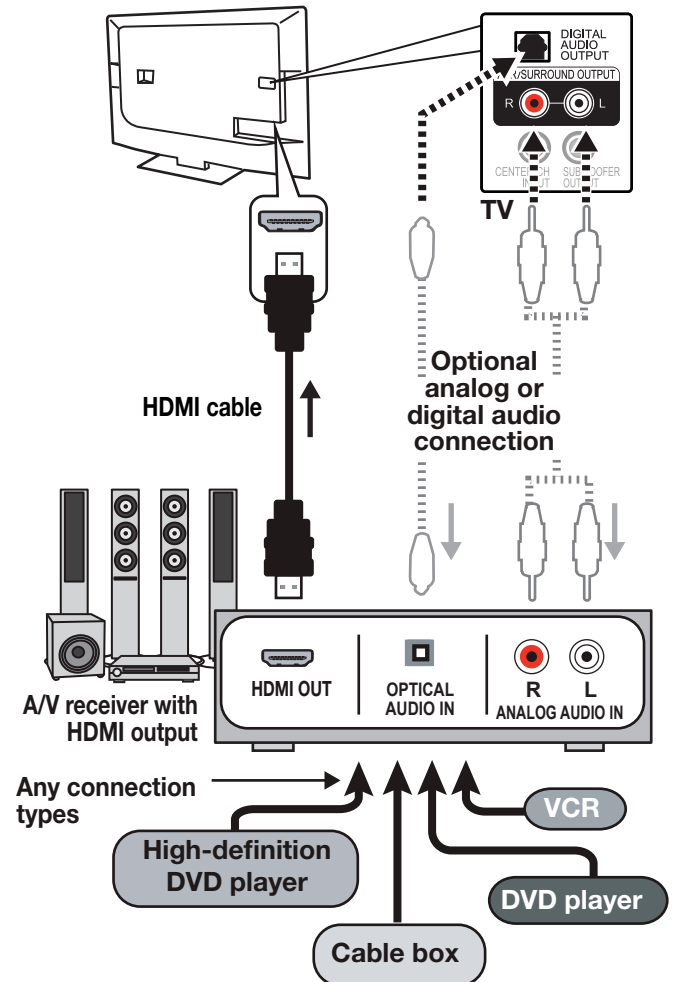

### Antenna or Cable TV Service

Connect the incoming cable to the TV's ANT input.

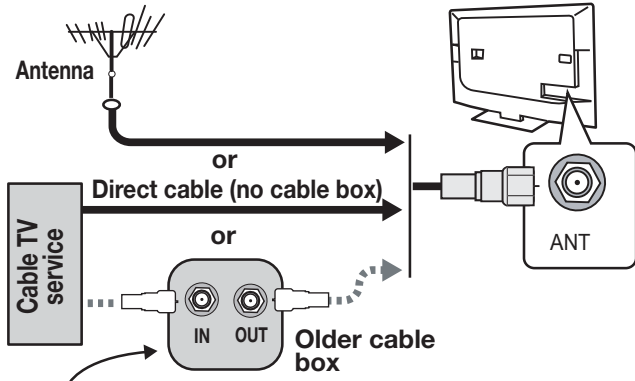

Not recommended. Other connection types provide better quality audio and video.

### VCR or DVD Recorder to an Antenna or Wall Outlet Cable

Required:

1. Video cables
  - 1a. Component video cables (red/blue/green) or
  - 1b. Composite video cable (usually yellow)
2. Left/right analog audio cables.
3. Two-way RF splitter
4. Two coaxial cables

**Note:** If your recording device has an analog-only tuner, you must use a digital converter box to enable recording of digital broadcasts.

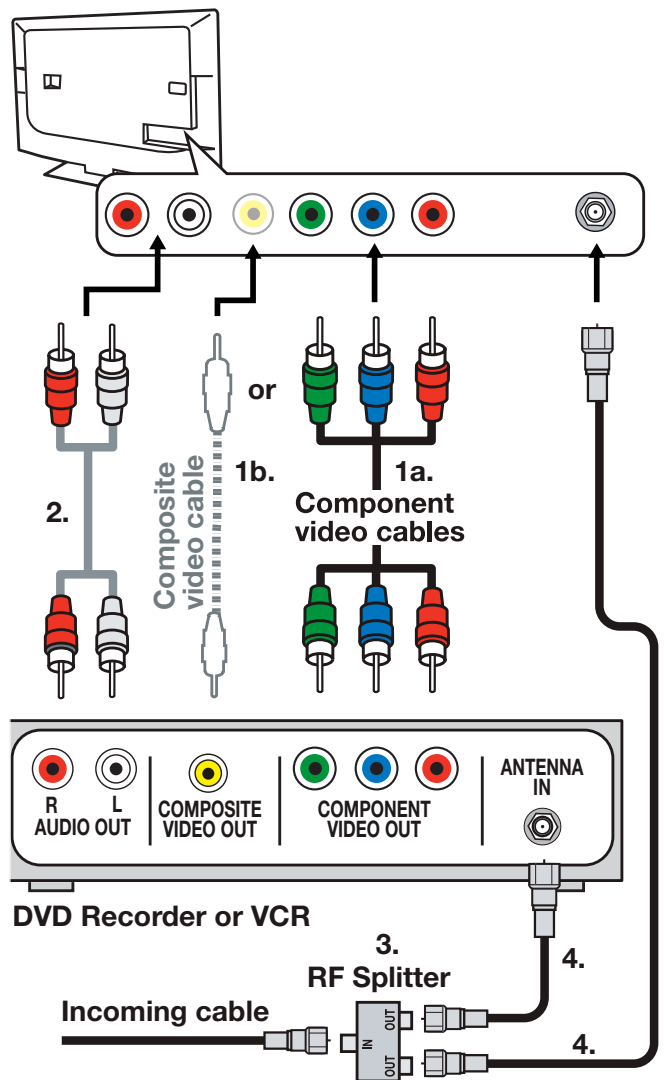

### Connection Types and Audio/Video Quality

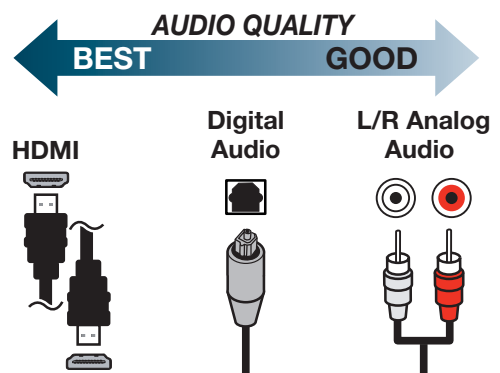
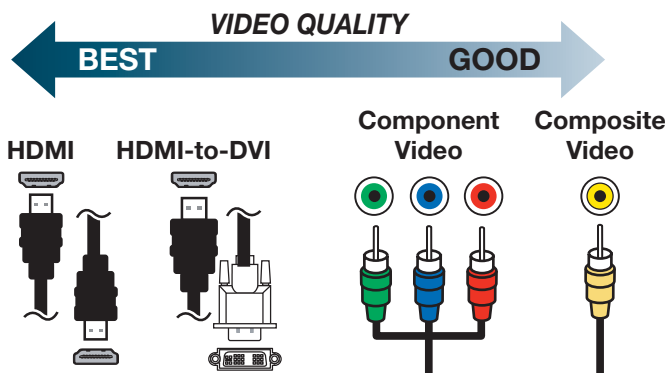



# 3 TV Features

## FAV (Favorites)

The **FAV** key gives you quick access to favorite program sources. Sources can be channels from the **ANT** input or devices connected to the TV. You can store up to nine favorites.

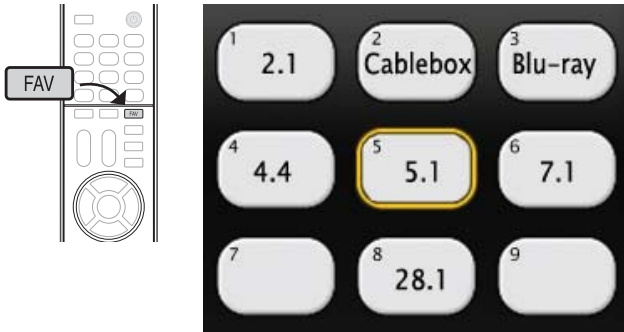

Sample Favorites menu. Switch to favorite channels or inputs using number keys.

### Adding Favorites

1. Press **INPUT** and switch the TV to the input you want to add. If adding a channel, switch to the **ANT** input and tune to the channel.
2. Press the **FAV** key.
3. Move the highlight to the number position you want to assign to the channel or input.
4. Press **ENTER**.

### Removing

1. While watching TV, press the **FAV** key.
2. In the **Favorites** menu, highlight the channel or input you want to remove.
3. Press **CANCEL**.

### Tuning

1. While watching TV, press the **FAV** key.
2. Press the number key for the channel or input you want.

## ChannelView Channel Listings

### About ChannelView

ChannelView displays program descriptions sent by broadcasters. This information may be unavailable in some areas.

ChannelView™ shows memorized channels on the **ANT** input. It displays channel names and program information for digital channels. No program information is displayed for analog channels.

ChannelView allows you to set up three banks of custom channels for convenient access. You can save groups of channels by content (e.g., news, sports, children’s programming) or by TV user.

**Note:** You must first set the TV Clock (page 27) to receive ChannelView listings.



ChannelView “All” channels tab. Programs for the tuned channel are listed on right side of screen.

### ChannelView Custom Channel Banks

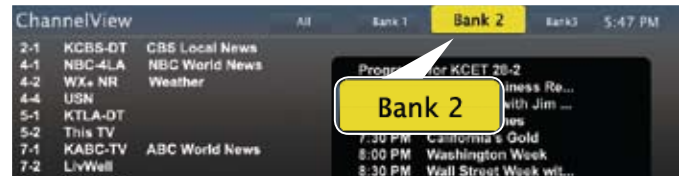

Select a channel bank to customize.

1. Press **GUIDE** to display ChannelView.
2. Press **MENU** to move the highlight to the bank header.
3. Press **◀ ▶** to select Bank 1, 2, or 3.
4. With the bank name highlighted, press **ENTER** to enter setup mode where you can select channels to include in the bank.
5. Press **EXIT** when finished with setup.

### Using Custom Channel Banks

- While watching TV, press **CH**  $\wedge/\vee$ . The TV will tune only to channels stored in the current bank.
- To change to a different channel bank:
  1. Press **GUIDE**.
  2. Press **MENU**.
  3. Press **◀ ▶** to highlight a bank.
  4. Press **MENU** to see channels in the bank.
- To allow tuning to any channel in memory, select the **All** bank.

For assistance call 1(800) 332-2119

## StreamTV™ Internet Media

Internet services provided by VUDU™ Apps let you access many popular on-line applications. In addition to free content, VUDU's movie service lets you buy and rent movies through the TV. Visit [www.VUDU.com](http://www.VUDU.com) to learn more about available movie titles, prices, and services offered. For a list of recommended routers and switches, see the **Support > FAQ** section at [VUDU.com](http://VUDU.com).

### Home Network Setup

Before using StreamTV internet media, you must connect the TV to the internet using one of these methods.

#### Ethernet Connection

##### DHCP (automatic)

1. Connect the TV to your network router with a Category-5 Ethernet cable (not supplied).

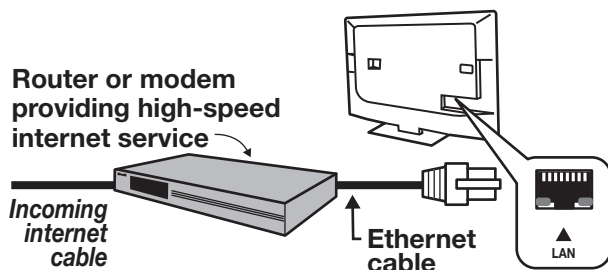

2. Open the **Setup > Network** menu to review settings.
3. Press **EXIT** to clear the menu.

##### Manual

1. Connect the TV to your network router with a Category-5 Ethernet cable (not supplied).
2. In the **Setup > Network** menu, highlight **Manual** and press **ENTER**.
3. Press **▶** to move to the **Connection Data** area.
4. Input the connection data.
5. After entering connection data, press **ENTER** to connect.
6. Change any of the following if needed:
  - Default Gateway
  - DNS
  - Subnet Mask

#### Wireless Connection

- **164 and 265 series** models have built-in wireless capabilities and can communicate directly with your wireless router.
- **154 series** TVs require an Azurewave AW-NU231 USB wireless adapter.

1. Disconnect the Ethernet cable if present.
2. For a 154 series TV, connect the USB wireless adapter.

#### Required for StreamTV internet media:

- Broadband internet service (at least 2 Mbps for SD, 4 Mbps for HD, and 8 Mbps for 1080p HDX)
- Ethernet cable **or** to connect a 154 series TV wirelessly, an Azurewave AW-NU231 USB wireless adapter.
- Computer access to the [VUDU.com](http://VUDU.com) website (required for initial account activation).
- A credit card for rental and purchase transactions from VUDU's movie service.

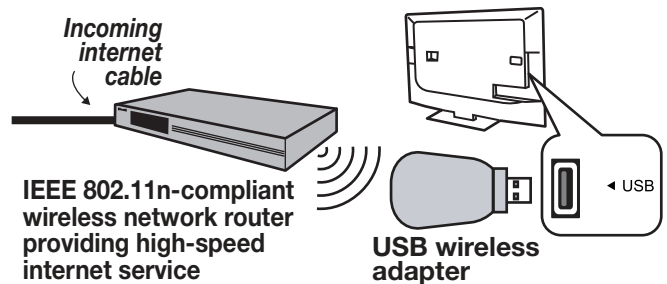

154 Series TV. A USB wireless adapter is required for wireless connection.

3. Open the **Setup > Network** menu. After a few moments, detected networks will appear listed on the screen in order of signal strength.



Setup > Network menu

4. Highlight the desired network and press **ENTER** to connect. A check will appear next to the connected network.

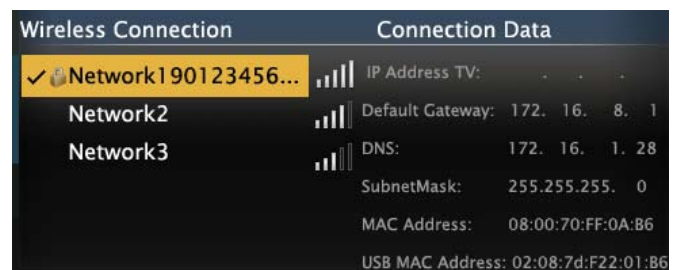

Setup > Network menu after connecting. The active network is checked and connection data displays.

5. If connecting to a secure network, enter the network key or password on the remote control when prompted.

For assistance call 1(800) 332-2119

## StreamTV™ Internet Media, continued

### Using StreamTV Internet Media

After establishing internet connectivity, press the **INTERNET** key to display services from VUDU Apps. Press **ENTER** to launch an application.

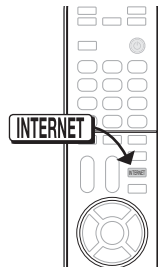

### Getting Started with VUDU Movies

1. After establishing internet connectivity, press **INTERNET** to display offerings from VUDU™.
2. Select the VUDU movie service.
3. Browse the VUDU movie catalog and offerings.
4. When you are ready to rent or buy a movie, you will be prompted to activate your VUDU account. Follow the on-screen instructions and use a computer to go to [www.VUDU.com/activation](http://www.VUDU.com/activation). A credit card is required for activation.

Once your account is activated, you can rent and buy movies using only the TV and the TV's remote control.

### Specialized Keys for VUDU

<b>INTERNET</b>	Displays the VUDU internet menu.
<b>GUIDE</b>	VUDU <b>HOME</b> key
<b>INFO</b>	VUDU <b>MORE</b> key
<b>LAST</b>	VUDU <b>BACK</b> key (goes to previous menu)
<b>CANCEL</b>	VUDU backspace (in text-entry screens)
<b>F2</b>	VUDU System menu
<b>EXIT</b>	Exit VUDU

### Troubleshooting

#### If You Are Unable to Connect to the Internet

- Check all power and data connections.
- If you can reach the internet with a computer or other device on the same internet service used by the TV, consult the router or modem owner's guide for reset instructions.
- If you cannot reach the internet, contact your service provider. You may be asked for network information such as the TV's IP address. Go to the **Setup > Network** menu to see connection data.

#### For Further Assistance

- If you are having trouble connecting your TV or accessing internet applications, contact Mitsubishi Customer Care at 1-800-332-2119.
- If you are having difficulty with your VUDU account, contact VUDU Customer Care at [www.VUDU.com/support](http://www.VUDU.com/support).
- See more troubleshooting tips in Appendix B.

## Wireless Audio Playback

**164 and 265 Series.** The TV's built-in speaker array can play audio from a handheld device using *Bluetooth*® A2DP (stereo audio) wireless technology.

### Pairing the TV with an Audio Device

1. Turn on the wireless device you wish to use for playback. Turn off all other wireless devices in the area as the TV can pair with only one device at a time.
2. Press **INPUT** to display the **Input Selection** menu.



*Bluetooth® icon in Input Selection Menu*

3. Highlight the **Bluetooth** icon and press **ENTER**.
4. Pair your device with the TV and then connect. Some devices pair and connect automatically, while others require you to enter the TV pass code displayed.
5. Use keys on the TV's remote control to control playback. Not all keys work for all devices.

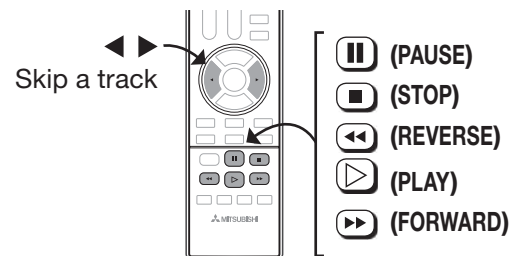

### Resetting Bluetooth Pairing or Connection

Perform this reset if the audio device does not connect properly to the TV.

1. If the audio device has been previously paired with the TV, delete the TV from the device's paired list.
2. Go to the TV's **Inputs > Name** menu and highlight the *Bluetooth* icon. Press **ENTER** to select **Off**.
3. Press **EXIT**.
4. Go to the **Inputs > Name** menu and highlight the *Bluetooth* icon. Press **ENTER** to select **On**.
5. Press **EXIT**.

### Tips for Wireless Playback

- Selecting the **Bluetooth** icon at a later time will reconnect the TV to the paired device.
- If the paired device is not available, the TV will accept pairing from a different device.
- Once connection is lost, the TV will power off after five minutes without receiving a signal.
- To clear a paired device, turn off the **Bluetooth** icon (**Inputs > Name** menu) or pair the TV with a different device.

**For assistance call 1(800) 332-2119**

## Camera Images and Music Files

### USB Media Player Menu

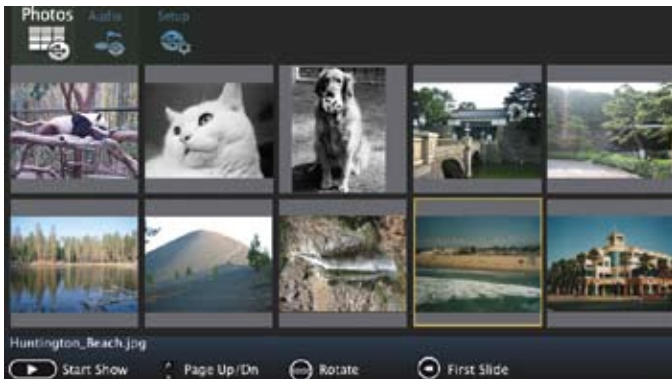

USB Media menu, Photos option selected

#### Displaying the Menu

**Note:** Back up the data on your USB drive before connecting it to the TV. Mitsubishi is not responsible for any file damage or data loss.

1. Connect your USB drive to the TV's USB port.  
The **USB Media Player** menu displays while files are being read. Wait until icons appear in the menu before continuing.

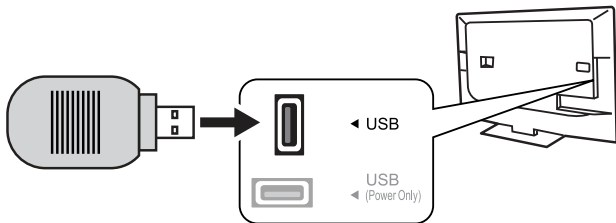

The TV can read photo and music files from the USB port.

#### Notes on Using the USB Port

- The TV ignores all commands while reading files.
- Large files or high-capacity storage devices may take a long time to display.
- Some manufacturers' devices may be incompatible with the TV. If the TV is unable to display your photos, you can:
  - Transfer files to a different USB device.
  - Use your digital camera's composite video output.

#### Picture Files Compatible with the USB Port

- Still images recorded using the Exchangeable Image File Format, version 2.1 (EXIF 2.1) standard for digital still cameras and Design Rules for Camera File Systems version 1.0 (DCF 1.0)
- Some images opened and resaved on a computer may not play back or may not display in the thumbnail list.
- Full file path names can be no longer than 50 characters and must end in a .jpg extension.



#### USB Media Setup Menu

Use the **USB Media Setup** menu to set up play of a slide show or playlist.

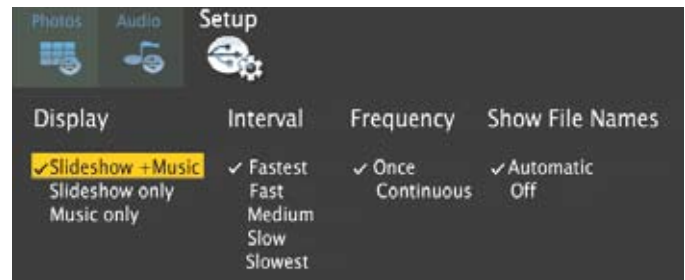





#### IMPORTANT

Always stop playback with **STOP** or change to a different TV input before disconnecting your USB device.



#### Using the Photos and Audio Menus

Use these keys with your photo and audio files.

Key	For Photo or Audio Tracks
 or <b>ENTER</b>	Plays the slide show or playlist starting from the highlighted item.
	Pauses a slide show or playlist.
	Stops a slide show or playlist.
	<ul style="list-style-type: none"> <li>• Highlights the first or last item on the current page.</li> <li>• Skips to the previous or next item during play.</li> </ul>
	<ul style="list-style-type: none"> <li>• Displays the previous or next page of items.</li> <li>• Skips immediately to the previous or next item during play.</li> </ul>
<b>GUIDE</b>	Rotates an image clockwise in 90° increments.
<b>INFO</b>	Displays the item name during play. Press <b>EXIT</b> to clear.
<b>EXIT</b>	Clears on-screen displays.
<b>MENU</b>	Displays the main menu; stops play.
<b>INPUT</b>	Displays the <b>Input Selection</b> menu; stops play.

For assistance call 1(800) 332-2119

## Camera Images and Music Files continued

### Photos and Moving Video as Composite Video

Connect the camera to the TV using a composite video cable and control the slide show or movie through the camera. The display resolution will be standard-definition (480i).

1. Refer to the owner's manual supplied with the camera for instructions needed for this setup.
2. Set the camera's output signal type to **NTSC** and put the camera into playback mode.
3. With the camera still turned on, connect your digital camera's composite video cable (usually yellow) to the TV's **Y/VIDEO** jack. To hear audio, connect the camera's audio output cable to the **AUDIO L** jack.

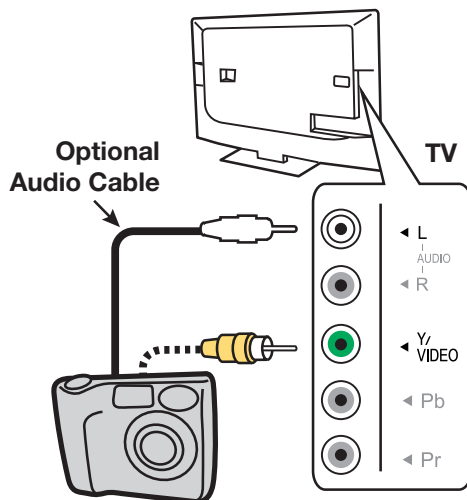

Camera connection using a composite video cable

4. When the **New Device Found** screen displays, assign the name **Camcorder**.
5. Press **EXIT** to close the **New Device Found** screen.
6. Highlight the icon for the camera input and press **ENTER**.



7. If viewing photos, advance through the images manually or set the camera to advance automatically.
8. If viewing photos, control the slideshow from the camera. Advance through the images manually or check if the camera can advance automatically.

## Sleep Timer

The Sleep Timer turns the TV off after the length of time you set. To set the TV to turn on at a certain time of day, see the **Setup > Timer** menu on page 27.

### Setting the Sleep Timer

1. Press **SLEEP**.



2. Press **SLEEP** additional times to increase the time in 30-minute increments up to the maximum of 120 minutes.
3. Press **EXIT** or wait five seconds without pressing any keys for the message to clear.

### Viewing or Changing the Sleep Timer

1. Press **SLEEP** to display the on-screen message.
2. Press **SLEEP** additional times to change the time before the TV powers off. To cancel the Sleep Timer, press **SLEEP** repeatedly until **OFF** is displayed.

## Sound Projector

### Positioning the TV

The TV's built-in speaker array can be set up to reflect sound off the room walls to create a surround sound effect.

- **Center the seating area in front of the TV and at least six feet away.**
- **Arrangements that give good results:**

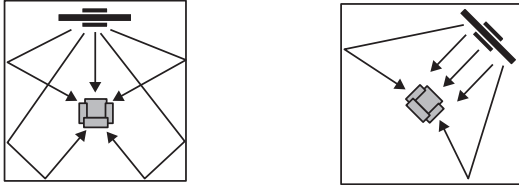

- **If the room is an odd shape, locate the TV to take best advantage of wall reflections.**

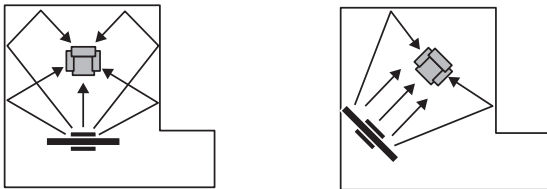

- **Avoid locations that may distort sound reflections.**

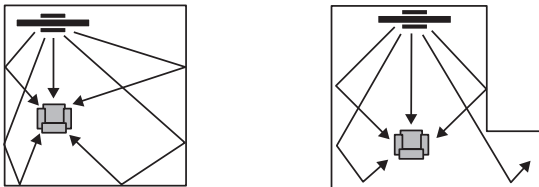

### Connecting the TV

To hear digital surround sound, the TV must be connected to a digital surround sound source. The surround sound source can be on an HDMI input or the **ANT** input (for some digital broadcasts). Other stereo connections will provide Dolby Pro Logic surround sound.

### Manual Setup

*Manual setup is available for all models.*

**Note:** If you have already performed Auto setup, any manual adjustments will erase all settings created during Auto setup.

1. Press **MENU** and go to **Sound > SoundPro**.



2. Enter the room dimensions and layout information requested in the screen. To change measurements, press **▲▼** or enter numbers using the remote control's keypad.



3. Press **EXIT** to exit and save settings.
4. Play some sample audio to check sound quality. If further adjustment is needed, use the **Custom** menu as described next.

### Custom Menu

Use the **Custom** menu after defining the room layout.

1. From the **Sound > SoundPro** menu go to the **CUSTOM** menu.

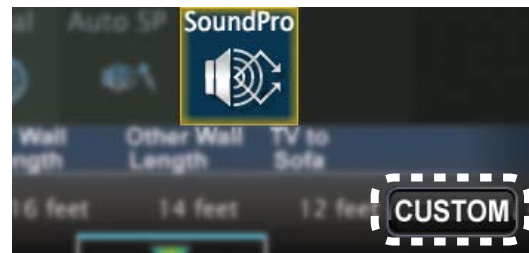

2. Position yourself in your usual viewing location. Remain in this position, looking at the TV, while making the following adjustments.

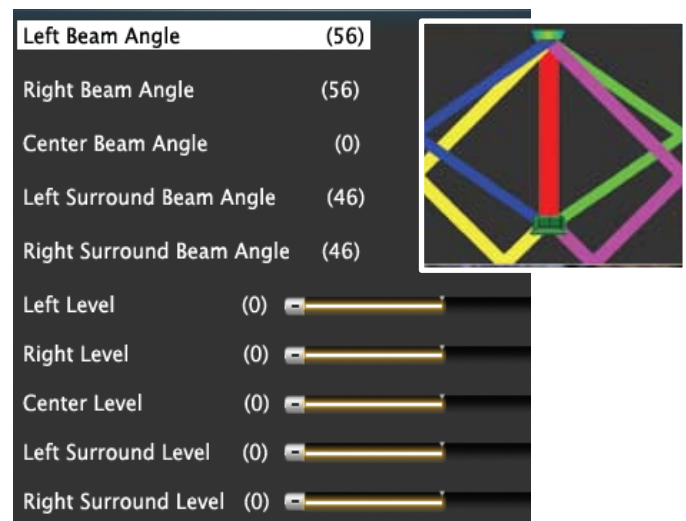

*Controls in the SoundPro > Custom menu adjust the TV's sound output.*

## Sound Projector, continued

### 3. Adjusting Beam Angles

- Adjust **Center Beam Angle** until sound is about equal in both ears.
- Adjust **Left Beam Angle** to maximize sound heard from the front left side.
- Adjust **Right Beam Angle** to maximize sound heard from the front right side.
- Adjust **Left Surround Beam Angle** to where the sound seems to come from the left rear side. If this cannot be achieved, make the setting the same as that for Left Beam Angle.
- Adjust **Right Surround Beam Angle** to where the sound seems to come from the right rear side. If this cannot be achieved, make the setting the same as that for Right Beam Angle.

### 4. Adjusting Levels

- Adjust **Center Level** to the mid level.
- Adjust the following levels one at a time so that each one sounds about the same as the center level:
  - Left Level**
  - Right Level**
  - Left Surround Level**
  - Right Surround Level**
- Check all sound levels by quickly switching between them using ▲▼.
- Readjust individual levels in small increments and recheck as above until all sound levels seem about the same.

## Resetting Angle and Level Values in the Custom Menu

- Press **EXIT** to clear all menus.
- Press **MENU**. Go to the **Sound > SoundPro** menu and press **ENTER**.
- Change any setting (e.g., **TV Location**).
- Press **EXIT** to clear all menus.
- Press **MENU**. Go to the **Sound > SoundPro** menu and press **ENTER**.
- Enter the correct values for the room layout.
- Return to the **CUSTOM** menu to adjust angles and levels.

## Auto Setup

### 265 Series

This section describes auto-setup available with 265 series TVs. Auto setup uses the included calibration microphone.

- Power on the TV and external subwoofer, if any.
- Plug the microphone cable into the TV's **INPUT 2** left audio jack.

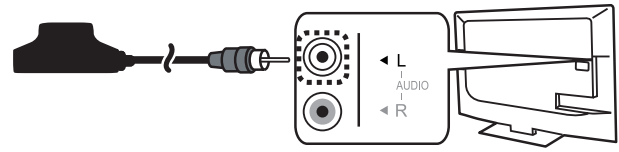

- Place the microphone as described in the guidelines.
- Press **MENU** and go to **Sound > AutoSP**.



- Highlight **START** and press **ENTER**. 
  - Quietly exit the room right away. The calibration sequence may be loud. Wait for completion of setup before returning to the room.
  - Play some sample audio material to check the sound quality.
- Note:** Do not perform manual adjustments after running Auto setup.
- Store the microphone out of direct sunlight and away from heat.

## Microphone Placement

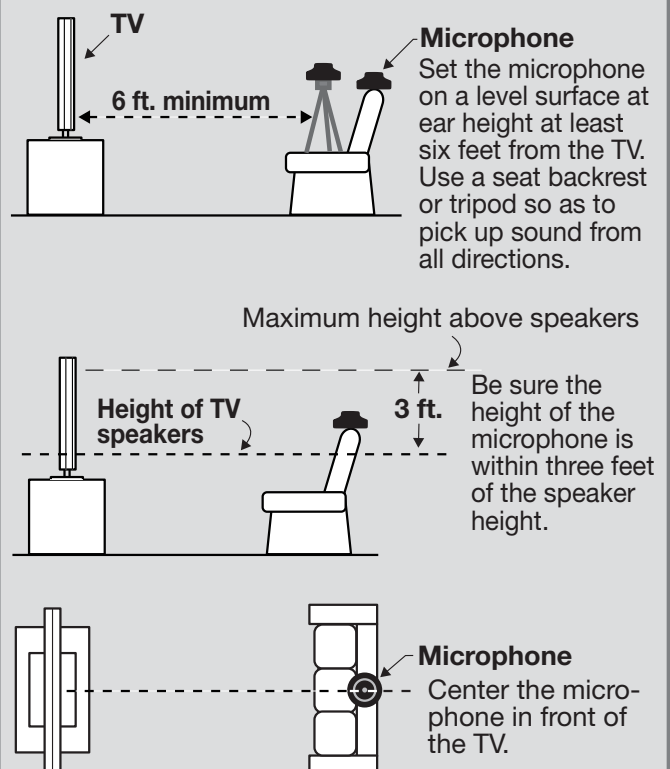

# 4 TV Menus

Press MENU on the remote control to open the main menu and access these settings.



## Picture

### Picture

### Video

Settings in this menu are saved for the current input only. **To make picture adjustments:**

#### From the *Picture* > *Video* menu

#### While watching TV



1. Press ▲▼ to highlight an option
2. Press ◀▶ to adjust.

1. Press the VIDEO key.
2. Press ▲▼ to select a video option.
3. Press ◀▶ to change the setting.

<b>Picture Mode</b>	<b>Brilliant</b>	For use under bright light.	Use Picture Modes to get the best image under different viewing conditions. Set the Picture Mode first, before changing other video settings.
	<b>Game</b>	Optimizes picture and video processing for game consoles	
	<b>Bright</b>	For most daytime viewing	
	<b>Natural</b>	For most nighttime viewing	
<b>Advanced Modes. 164 and 265 Series.</b> Contact your professional installer for setup.			
<b>Contrast</b>	In most home lighting situations, medium contrast looks best. Stored for each Picture Mode.		
<b>Brightness</b>	Adjusts overall picture brightness. Settings are stored independently for each Picture Mode.		
<b>Color</b>	Adjusts overall color intensity from monochromatic to fully saturated. Saved by input.		
<b>Tint</b>	Adjusts the red-to-green ratio. Saved by input.		
<b>Sharpness</b>	Adjusts picture detail and clarity. Saved by input.		
<b>Color Temp</b>	<b>High</b> gives white a cool cast. <b>Low</b> gives white a warm cast. Stored for each Picture Mode.		
<b>Video Noise</b>	Reduces minor noise (graininess) in the picture. Saved by input.		
<b>EdgeEnhance</b>	<b>164 and 265 Series TVs.</b> EdgeEnhance™ makes the image appear sharper. Saved by input.		
<b>DeepField Imager</b>	<b>164 and 265 Series TVs.</b> Provides strong contrast with detail over mixed screen content. <b>Demo</b> displays a split picture to show <b>On</b> (right side) and <b>Off</b> (left side). Saved by input.		
<b>Backlight</b>	Adjusts peak brightness of the backlight. Applies uniformly to all inputs. Press <b>ENTER</b> to turn the backlight on or off.		

### Picture

### Picture+

(Picture Plus)



<b>Video Mute</b>	Displays a solid background when there is no video signal from the current input.
<b>Screensaver</b>	Displays a screensaver while playing an audio-only source.
<b>Film Mode</b>	<b>480i and 1080i signals only.</b> In <b>Auto</b> , the TV automatically detects and applies film-decoding correction to movies filmed at 24 frames per second. Try the <b>Off</b> setting if images show many jagged edges. Setting saved by input.
<b>True 120 Hz</b> (154, 164 series)	Reduces motion blur in action scenes. Works in conjunction with Film Mode. Press <b>ENTER</b> to see an adjustment screen.
<b>True 240 Hz</b> (265 series)	
<b>Test Picture</b>	Displays a test picture.

For assistance call 1(800) 332-2119



**Picture, continued****Picture****Reset**

- Resets sound and picture adjustments for the current input. Highlight the **Reset** icon and press **ENTER** twice to perform reset.
- Reset** has no effect on universal settings (**Balance**, **Listen To**, **Language**) or on **Advanced** picture settings.

**Picture****Perfect**

(PerfectColor™/PerfectTint™) **265 Series**. Sliders let you adjust the saturation (intensity) and hues of six separate colors for the current image source.

**Picture****Advanced**

**Advanced Modes**. Contact your professional installer for setup.  
**164 Series. Special/ADV.**  
**265 Series. ISF Day/ADV1, ISF Night/ADV2**

**Sound****Sound****Audio**

Settings in this menu are saved for the current input only. To make audio adjustments:

**From the *Sound* > *Audio* menu**

- Press **▲▼** to highlight an option
- Press **◀▶** to adjust.

**While watching TV**

- Press the **AUDIO** key.
- Press **▲▼** to select an audio option.
- Press **◀▶** to change the setting.

<b>TV Speakers</b>	<b>On</b>	Turns on the internal TV speakers.
	<b>Off</b>	Turns off the internal TV speakers so you hear sound only through a connected device (A/V receiver or headphones).
	<b>Center</b>	Makes the TV's speaker array act as a center channel. <b>Sound &gt; Global &gt; Center Channel</b> must be set to <b>On</b> to use this option. See the detailed owner's guide at <a href="http://www.mitsubishi-tv.com">www.mitsubishi-tv.com</a> for use of this feature.
<b>Bass</b>	Controls bass sound from the TV speakers.	
<b>Treble</b>	Controls high-pitched sound from the TV speakers.	
<b>Balance</b>	Controls audio balance between the right and left TV speakers (Sound Mode Stereo only)	
<b>Subwoofer</b>	<b>[Subwoofer level adjustment]</b>	Adjusts the volume level of a connected subwoofer. Set <b>Sound &gt; Global &gt; Subwoofer</b> to <b>On</b> to make this adjustment available.
<b>Sound Mode</b>	<b>Stereo</b>	No special audio effects from the TV speakers
	<b>Surround</b>	Modifies audio from the TV speakers. <ul style="list-style-type: none"> <li>For monaural (non-stereo) programs, creates a simulated stereo effect.</li> <li>For stereo programs, creates a simulated surround sound effect.</li> <li>The TV's speaker array plays surround sound if available.</li> </ul>
	<b>Music</b>	Optimizes the TV's speaker array for music listening.
	<b>Night</b>	Focuses the TV's speaker array to a single point to limit sound heard by others outside the room. Press <b>ENTER</b> to adjust the focal point ( <b>Night Angle</b> ).
<b>Level Sound</b>	<b>On, Off</b>	Reduces differences in sound volume between programming segments.



## Sound, continued

Analog Listen To (For ANT analog channels)	<b>Stereo</b>	The TV plays stereo broadcasts in stereo and mono broadcasts in mono.
	<b>Mono</b>	Reduces background noise. Use when receiving a weak stereo audio signal.
	<b>SAP</b>	Second Audio Program. Selects an additional monaural sound track.

**Sound**   **Global**   Settings in this menu apply to all inputs.



<b>Analog Audio Out</b>	These settings affect audio from the <b>AVR/SURROUND</b> jacks.	
	<b>Fixed</b>	Use with an analog A/V receiver.
	<b>Variable</b>	Use with headphones; adjust headphone volume using the TV's remote control.
	<b>Rear</b>	Use when supplementing the TV's speaker array with external rear speakers.
<b>Subwoofer</b>	Select <b>On</b> to turn on audio to a connected subwoofer. Set to <b>Off</b> if no subwoofer is connected.	
<b>Center Channel</b>	<b>On</b> allows the TV's speakers to complement your external sound system as a center channel. Set to <b>Off</b> if not in use.	

**Sound**   **Auto SP**   **265 Series.** See page 23 for setup instructions.



**Sound**   **SoundPro**   Lets you set up the Sound Projector speaker array manually. See page 22.



## Captions

**Captions**   **Services**



<b>Service</b>	<b>On if Mute:</b> Displays digital closed-caption signal Caption 1 (digital) or CC1 (analog) when audio from the TV speakers is muted. While watching TV, press <b>MUTE</b> to turn closed captions on/off.
<b>Digital</b>	<b>Caption 1–Caption 6:</b> Caption signals sent by the broadcaster.
<b>Analog</b>	<ul style="list-style-type: none"> <li>• <b>CC 1–CC 4.</b> Standard closed-caption signals</li> <li>• <b>Text 1–Text 4.</b> Text-service signals</li> </ul>

**Captions**   **Font**   **As Broadcast** changes settings to those selected by the captions provider, or, if none, to the TV's own caption defaults.



**Captions**   **Color**   A white font on a black translucent background makes an easy-to-read combination.





## Setup

### Setup

#### Language

- Select either English or Spanish for on-screen menus.
- Select the language for a digital program from the **ANT** input (if available).



### Setup

#### Clock

Set the TV clock to:

- Use the TV Timer to power on the TV automatically at a preset time
- Receive correct updates to ChannelView listings



**Note:** When the Daylight Saving Time change occurs, you must open this menu and set the TV's clock ahead or back.

### Setup

#### Timer

The Timer tells the TV to power on automatically at a time you set. Use this menu to set a day, time, input, and channel for the Timer. If the TV is already on at the set time, the TV will automatically change to the designated channel or input.



- The TV clock must be set before you can use the Timer feature.
- As a reminder that the TV Timer is set, the TV **POWER** indicator flashes slowly while the TV is powered off.
- When the Timer turns on the TV, press any key on the remote control to keep it from turning off after five minutes.

### Setup

#### Channel

See "Memorizing Channels with Channel Scan" on page 9 to scan for all available channels on the **ANT** input.



#### Edit

After channel scan, **Edit** lets you add and delete memorized channels.

- Press **PAGE DN/UP** to jump to the next or previous page of channel numbers.
- Press **▲▼◀▶** to move through all channel numbers, one at a time.

#### Adding/Deleting Channels Using the Channel Edit Menu

- Channels marked with a check are in memory.
- To add or delete a channel from memory, highlight the channel number and press **ENTER**.
- To add a single digital channel not in the list, see the full owner's guide at [www.mitsubishi-tv.com](http://www.mitsubishi-tv.com).

### Setup

#### Energy



**Blue Glow**  
(265 series)

**On, Off**

Select **On** to see blue accent lighting when the TV is powered on.

### Setup

#### Network



**Ethernet Connection**  
**Wireless Connection**

See "Home Network Setup" on page 18.

 **Inputs**

<b>Inputs</b>	<b>Name</b>	<ul style="list-style-type: none"> <li>Lets you assign or change names of inputs appearing in the <b>Input Selection</b> menu.</li> <li>Lets you turn the <b>Ant</b> and <b>Bluetooth</b> inputs <b>On/Off</b> (to display or hide them in the <b>Input Selection</b> menu); a paired device is cleared from memory when the <b>Bluetooth</b> icon is turned off.</li> <li>Lets you delete unused HDMI inputs from the <b>Input Selection</b> menu.</li> <li>Highlight the input and press <b>ENTER</b> to see the name choices.</li> </ul>
---------------	-------------	---



<b>Inputs</b>	<b>Learn</b>	<b>265 Series.</b> Sets up or changes NetCommand IR control of the current device. See the full owner's guide at <a href="http://www.mitsubishi-tv.com">www.mitsubishi-tv.com</a> .
---------------	--------------	--



<b>Inputs</b>	<b>AVR</b>	<b>265 Series.</b> Sets up or changes NetCommand IR control of an A/V receiver. See the full owner's guide at <a href="http://www.mitsubishi-tv.com">www.mitsubishi-tv.com</a> .
---------------	------------	---



<b>Inputs</b>	<b>HDMI Control</b>	<b>On, Off</b> Select <b>On</b> or <b>Off</b> to enable or disable the TV's control of a CEC-enabled HDMI device. See the full owner's guide at <a href="http://www.mitsubishi-tv.com">www.mitsubishi-tv.com</a> for use of this feature.
---------------	---------------------	---



<b>Inputs</b>	<b>Order</b>	Lets you rearrange icons in the <b>Input Selection</b> menu.
---------------	--------------	--



<b>Inputs</b>	<b>Demo</b>	See demonstrations showcasing selected TV features.
---------------	-------------	---





## Lock

### Parental Menu

The TV comes from the factory with the rating locks turned off and with pre-set U.S. ratings TV-PG and movie rating PG. You must turn on blocking for U.S. ratings to activate these rating restrictions. You will be prompted to enter a pass code when you select **Lock** on the main menu.

#### Important Notes on Rating Locks

- **Parental** menu rating locks apply only to channels and signals received on the **ANT** and composite **VIDEO** jacks.
- **Other** menu rating locks apply only to digital channels received on **ANT**.
- When viewing a cable box, satellite receiver, or other device connected to the component **Y Pb Pr** or **HDMI** inputs, check the device's owner's guide for parental locks.
- When accessing VUDU's internet movie service, use the parental controls provided by VUDU.

### Lock Parental



<b>Lock</b>	Disables or enables blocking based on V-Chip signals and the U.S. rating system.	
<b>TV Rating</b>	Highlight the rating level you wish to change and press <b>ENTER</b> to block it (🔒) or allow it (🔓). You can apply supplemental content blocking to the age-based ratings by using the TV content categories. ( <b>FV, D, L, S, V</b> )	
<b>Movie Rating</b>	Highlight the rating level you wish to change and press <b>ENTER</b> to block it (🔒) or allow it (🔓).	
<b>Start Time/ Stop Time</b>	Sets the time of day for enforcement of rating restrictions set in the <b>Parental</b> menu. <b>Note:</b> To make rating restrictions active 24 hours a day, make <b>Start Time</b> and <b>Stop Time</b> the same.	

### Lock Time



Blocks all use of the TV during the time period you specify. Once a lock time is set, it goes into effect immediately and you must enter a pass code to use the TV during the lock period. To reactivate the time lock, power the TV off and then back on. To make **Lock by Time** active 24 hours a day, make **Start Time** and **Stop Time** the same.

### Lock Channel



The **Channel Lock** menu lists channels currently in memory (see page 27). Highlight a channel and press **ENTER** to lock (🔒) or allow (🔓) the channel. Channels locks will be cleared the next time you perform a channel scan.

### Lock Panel



Use this option if small children try to press TV buttons.

- To release the Panel Lock from the TV's control panel, press and hold the **INPUT** button for ten seconds. If the TV is powered off, press **POWER** after the lock releases to power on the TV.
- To reactivate the lock, return to this menu and change the setting to **On**.

### Lock Other



#### Other Menu Options (alternate rating system)

This TV can recognize new rating systems that may come into effect in the future. Such alternate rating systems will apply only to digital programming received on the **ANT** input.

## Appendix A: Programming the Remote Control

### Programming the Remote Control

1. Change the control mode to match the device type.

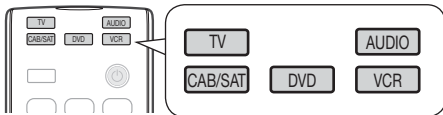

Mode	Affected Device
CAB/SAT	Cable Box, DTV Receiver, Satellite Receiver
VCR	VCR, DVR, DVD Player/Recorder
DVD	DVD Player/Recorder, DVR, VCR
AUDIO	A/V Receiver, Audio Amplifier, CD Player

2. Press and hold **POWER** on the remote control for several seconds until the key blinks twice and goes off.

3. Enter the first five-digit code listed for your equipment.
4. Point the remote control at the equipment and press **POWER**. If the product has no power on/off function, press a different key, such as **▶ (PLAY)**, **■ (STOP)**, **VOLUME UP**, or **MUTE**.  
If the equipment does not respond, repeat the preceding two steps using the next five-digit code.
5. Once you have found the correct code, write it in the space below for future reference.

Mode	Device Type	Code
CABLE/SAT		
VCR		
DVD		
AUDIO		

This is an abbreviated list showing the most popular codes. For a full list, see the detailed owner's guide at [www.mitsubishi-tv.com](http://www.mitsubishi-tv.com).

Cable Boxes	
General Instrument	10476
Jerrold	
Motorola	11376, 11187, 10476
Pace	11982, 11877, 11376
Pioneer	11877, 10877
Scientific Atlanta	11877, 10877

A/V Receivers	
Bose	41933, 41841, 41629, 41253, 41229, 40639
Denon	42857, 42279
Harman/Kardon	42443, 42241, 41306, 41304, 40891
Integra	41805, 41320, 41298
JVC	42331, 42239, 42040, 41495, 41374
Kenwood	41570, 41569, 41313
Mitsubishi	41957, 41922, 41921, 41920, 41393
Onkyo	41805, 41531, 41320, 41298, 40842
Panasonic	41763, 41633, 41548, 41518, 41316, 41308, 41288, 41275, 42967, 42452, 42221, 41764
Pioneer	41935, 41384, 41023, 40630
Sony	41759, 41758, 41658, 41622, 41558, 41441, 41258, 41058, 42522, 42216, 42172, 41858, 41822
Technics	41518, 41308
Yamaha	41476, 41376, 41375, 41331, 41276, 41176, 40376, 40176, 42471, 42467, 42061, 41815

Satellite Receivers	
DirecTV	11749, 11377, 11142, 10749, 10639, 10566, 10392, 10247, 11856, 11609, 11442, 11414, 11109, 11076
Dish Network System	11775, 1150, 1077
Hughes Network Systems	11749, 11442, 11142, 10749
Mitsubishi	10749
RCA	10566, 10392, 10143
Samsung	11609, 11442, 11377, 11276, 11109

VCRs	
Hitachi	20042, 20000
JVC	20067
Magnavox	21593, 20593, 20081, 20039, 20035, 20000
Matsushita	20162, 20035
MGA	20043
Mitsubishi	20173, 20067, 20043
Panasonic	21062, 20616, 20614, 20162, 20035
RCA	20880, 20060, 20042
Sony	21972, 21032, 20636, 20035, 20033, 20032, 20000
Tivo	20739, 20636, 20618
Toshiba	21972, 21008, 20045, 20043
Zenith	21139, 20039, 20037, 20033, 20000

DVD Players	
Apex Digital	31061, 31056, 31020, 31004, 30797, 30796, 30794, 30755, 30672
Coby	31628, 31351, 31177, 31165, 31107, 31086, 30852, 30778
Denon	32258, 30634, 30490

DVD Players	
Funai	30675
Hitachi	30664, 30573
Insignia	32596, 32428, 32095, 30675
Integra	32147, 31769, 30627, 30571
JVC	32365, 31602, 31550, 31275, 31164, 30867, 30623, 30558
LG	31602, 30869, 30741, 30591
Magnavox	31506, 31472, 31354, 31177, 30675, 30646, 30539, 30503
Mitsubishi	31521, 30521
Onkyo	32147, 31769, 30627, 30503
Panasonic	31762, 31641, 31579, 30703, 30632, 30503, 30490
Philips	32084, 32056, 31340,, 31267, 30675, 30646, 30539, 30503, 32434, 31506, 31354
Pioneer	31571, 31512, 31460, 30632, 30631, 30571, 30525, 30142, 32442
RCA	32213, 31769, 30822, 30790, 30571, 30522
Samsung	32069, 31470, 31075, 31044, 30820, 30573, 30490, 30199, 32556, 32489, 32369, 32329
Sharp	32250, 31256, 30752, 30675, 30630
Sony	31633, 31536, 31516, 31431, 31070, 31033, 30864, 30533
Sylvania	30675
Tivo	31512, 31503
Yamaha	32558, 32298, 30817, 30646, 30545, 30539, 30490
Zenith	30869, 30741, 30591, 30503

## Appendix B: Troubleshooting

To contact Mitsubishi customer service, see page 6.

### TV Reset Comparison Guide

You can resolve many common TV problems using the reset functions described in the following table.

#### IMPORTANT

**Before you change sound or picture settings:** If picture or sound settings seem wrong for a broadcast

channel (a channel from the **ANT** input, a cable box, or satellite receiver), first check other channels from the same input before changing settings. If most other channels from the same input seem correct, there is likely a problem with the broadcast rather than with the TV. Use care in this case, as changes you make to fix problems on individual channels also affect all other channels on the same input.

Reset Name	When to Use	How to Use	Resulting Action
<b>Format</b>	If the picture shape seems incorrect, use the <b>FORMAT</b> key to change the picture shape.	Press <b>FORMAT</b> to cycle through the picture shapes available for the signal.	The last-used format for the signal type will be recalled on the input. <b>Note:</b> Also check the aspect ratio feature on your cable box or satellite receiver as this may be altering the picture.
<b>PerfectColor™/ PerfectTint™ Reset (265 Series)</b> (for the single input currently being watched)	When the color intensities seem out of balance, use the PerfectColor/PerfectTint reset to reset the color balances to the original factory settings. Both PerfectColor and PerfectTint are reset at the same time.	<ol style="list-style-type: none"> <li>1. While viewing the input to reset, press <b>MENU</b> and go to <b>Picture &gt; Perfect</b>.</li> <li>2. Press <b>ENTER</b> to display the PerfectColor adjustment screen.</li> <li>3. Press <b>CANCEL</b> to reset the colors.</li> </ol>	All PerfectColor/PerfectTint sliders are reset to the original center position. The PerfectColor/PerfectTint settings for other inputs remain unchanged.
<b>A/V Memory Reset</b> (for the single current input)	When audio and/or video settings for a single input seem incorrect, use A/V Memory Reset to return the input to the original factory settings.	<ol style="list-style-type: none"> <li>1. While viewing the input to reset, press <b>MENU</b> and go to <b>Picture &gt; Reset</b>.</li> <li>2. Press <b>▼</b> to highlight <b>Reset</b>.</li> <li>3. Press <b>ENTER</b> again to reset.</li> </ol>	All Audio and Video settings for the individual input are reset except for the global settings for audio Balance, Listen To, Language, Video Mute, True 120 Hz.
<b>A/V Reset</b> (for all inputs)	To reset audio and video adjustments for all inputs to the original factory settings.	While viewing the TV, press the control-panel buttons <b>INPUT</b> and <b>VOLUME DOWN</b> at the same time for at least two seconds.	All Audio and Video settings are returned to the original factory settings, including global settings not affected by <b>Picture &gt; Reset</b> .
<b>Channel Memorization</b>	To erase and re-memorize channels on the <b>ANT</b> input.	<ol style="list-style-type: none"> <li>1. Press <b>MENU</b> and go to <b>Setup &gt; Channel</b>.</li> <li>2. Highlight the reception mode, e.g. <b>Ant Air</b>, and press <b>ENTER</b>.</li> <li>3. Highlight <b>All Channels</b> and press <b>ENTER</b>.</li> <li>4. Highlight <b>Scan</b>.</li> <li>5. Press <b>ENTER</b> to start channel memorization.</li> </ol>	All previously memorized channels for the antenna input are erased and a new set of memorized channels is created. To add or delete individual channels, see the <b>Setup &gt; Channel &gt; Edit</b> menu instructions on page 27.
<b>Lock Menu Pass Code</b>	To change your <b>Lock</b> menu pass code	See the detailed owner's guide at <a href="http://www.mitsubishi-tv.com">www.mitsubishi-tv.com</a> for instructions.	

## Appendix B: Troubleshooting, continued

Reset Name	When to Use	How to Use	Resulting Action
<b>Control-Panel Lock Release</b>	To re-enable the control-panel buttons after activation of the Control-Panel Lock	Press and hold the <b>INPUT</b> button on the control panel for ten seconds. If the TV is powered off, you can now press the <b>POWER</b> button to turn it on.	Allows the control panel to be unlocked if the remote control is misplaced.
<b>System Reset</b>	If the TV does not turn on or off, does not respond to the remote control or control-panel buttons, or has audio but no video.	Press and hold the <b>POWER</b> button on the control panel for ten seconds.	The TV will turn off. Power on the TV and the green LED will flash quickly for about one minute. The changes you made most recently, before using <b>SYSTEM RESET</b> , may be lost.
<b>TV Reset</b> <b>IMPORTANT:</b> Use this reset only if other troubleshooting has been unsuccessful.	To reset all consumer-accessible settings and all memories to the original factory defaults.  Use TV Reset if the TV can respond to controls but TV behavior is abnormal.  <b>CAUTION:</b> All owner-performed setups and adjustments will be erased.	<ol style="list-style-type: none"> <li>1. While viewing the TV, press <b>MENU</b> to display the TV main menu.</li> <li>2. With the main menu displayed, press number keys <b>1 2 3</b> to display the <b>Reset</b> menu.</li> <li>3. <b>READ THE ON-SCREEN WARNING AND INSTRUCTIONS.</b> <ul style="list-style-type: none"> <li>• If you do not wish to use this reset, press <b>EXIT</b> or <b>MENU</b> to back out.</li> <li>• If you wish to continue, press <b>ENTER</b> to erase all memories and settings.</li> </ul> </li> </ol>	The TV will start the initialization process and then turn off. Power on the TV and the front green LED will start flashing. All memory and settings outlined in this Owner's Guide will need to be set again.
<b>VUDU</b> Reset VUDU Account Password	You have forgotten your account password.	Using a computer, go to <a href="http://www.VUDU.com">www.VUDU.com</a> .	Reset your account password from the VUDU website (requires access to e-mail).
<b>VUDU</b> Reset Parental Controls Pass code	You have forgotten your pass code.	Call VUDU Customer Care at 1-888-554-VUDU (8838).	VUDU Customer Care will reset your pass code.

### Common Picture Problems

Symptom	Remarks
1. Picture does not look like a high-definition picture.	<p>Compare the picture to the TV's test picture (Picture &gt; Picture+ menu) to check if the source signal is supplying a lesser-quality image.</p> <p>Not all signals are high-definition signals. To receive high-definition programming from your cable or satellite provider, you must subscribe to the provider's high-definition service. Some over-the-air broadcasts are in high-definition and can be received with a high-quality antenna suited to your location.</p>
2. TV has sound but no picture.	<ul style="list-style-type: none"> <li>• Press <b>MENU</b> on the remote control. If the menu displays, then there is a problem with the incoming signal.</li> <li>• Check that all video inputs are plugged in firmly to the correct input jacks.</li> <li>• Press and hold the <b>POWER</b> button on the control panel for ten seconds to perform System Reset.</li> </ul>



## Appendix B: Troubleshooting, continued

### Common Picture Problems

Symptom	Remarks
3. A color program appears as a black and white image, or the colors are dim, or the screen is black.	<ul style="list-style-type: none"> <li>If using component video, check that the red, green, and blue input cables are correctly connected to the red, green, and blue component video jacks.</li> <li>If using composite video, check that the incoming cable is connected to the TV's green Y/VIDEO jack.</li> <li>The PerfectColor color balance has been incorrectly set. Reset the PerfectColor balance.</li> </ul>
4. Picture from an HDMI input is noisy (poor quality).	<ul style="list-style-type: none"> <li>Compare the picture to the TV's test picture (Picture &gt; Picture+ menu) to check the source of the noise.</li> <li>Upgrade a Category 1 (unmarked) HDMI cable to a Category 2 high-speed HDMI cable.</li> </ul>

### Home Network

Symptom	Remarks
1. I cannot connect the TV to the network.	Go to the Setup > Network menu. Obtain the TV MAC address and provide it to the router.
2. I plugged in a wireless USB adapter, but the wireless connection is not working.	The network may be locked. Go to setup > Network. Highlight the network name and supply the pass code.
3. The INTERNET key only goes to VUDU.	Normal operation. The TV receives all internet services through VUDU. The TV does not provide full internet access as does a web browser on a computer.

## Trademark and License Information

LICENSOR'S SUPPLIERS DO NOT MAKE OR PASS ON TO END USER OR ANY OTHER THIRD PARTY, ANY EXPRESS, IMPLIED OR STATUTORY WARRANTY OR REPRESENTATION ON BEHALF OF SUCH SUPPLIERS, INCLUDING, BUT NOT LIMITED TO THE IMPLIED WARRANTIES OF NON-INFRINGEMENT, TITLE, MERCHANTABILITY OR FITNESS FOR A PARTICULAR PURPOSE.



Manufactured under license from Cambridge Mechatronics Ltd.  
Rapidfire and the 1... logo are trademarks of Cambridge Mechatronics Ltd

The *Bluetooth*® word mark and logos are registered trademarks owned by Bluetooth SIG, Inc. and any use of such marks by Mitsubishi Electric is under license. Other trademarks and trade names are those of their respective owners.

Digital Light Processing® and DLP® are registered trademarks of Texas Instruments.

Manufactured under license from Dolby Laboratories. Dolby is a trademark of Dolby Laboratories.

ENERGY STAR® and the ENERGY STAR mark are registered U.S. marks. ENERGY STAR is a registered mark owned by the U.S. government.

HDMI®, the HDMI Logo, and High-Definition Multimedia Interface are trademarks or registered trademarks of HDMI Licensing LLC in the United States and other countries.



Imaging Science Foundation Certified Calibration Controls

The software in this TV is based in part on the work of the Independent JPEG Group, copyright © 1991-1998, Thomas G. Lane, all rights reserved.

VUDU™ is a trademark of VUDU, Inc.

“x.v.Color” and the “x.v.Color” logo are trademarks of Sony Corporation.

ChannelView™, DeepField™ Imager, Easy Connect™, EdgeEnhance™, NetCommand®, PerfectColor™, PerfectTint™, Plush 1080p® 5G, StreamTV™, Unisen™ are trademarks of Mitsubishi Digital Electronics America, Inc.

**For assistance call 1(800) 332-2119**

# Mitsubishi TV Software

## END-USER LICENSE AGREEMENT FOR EMBEDDED SOFTWARE

**IMPORTANT – READ CAREFULLY:** This License Agreement is a legal agreement between you (either an individual or an entity) and Mitsubishi Digital Electronics America, Inc. (MDEA) for all software pre installed and/or provided along with this television (“Software”). By utilizing this television and Software, you agree to be bound by the terms of this License Agreement.

The Software is protected by United States copyright laws and international treaty provisions, as well as other intellectual property laws and treaties. The Software is licensed, not sold.

1. **LICENSE GRANT.** MDEA grants you a non-exclusive, non-transferable, limited right and license to use one copy of the Software only with the Mitsubishi television model that included this owner’s guide and owned by you.

2. **RIGHTS AND LIMITATIONS.**

Software Not for Resale. You may not resell or otherwise transfer for value the Software, except in conjunction with a sale of the TV that Software has been pre installed.

Prohibition on Reverse Engineering, Decompilation and Disassembly. The Software contains trade secrets or other proprietary material in its human perceivable form and to protect them, you may not reverse engineer, decompile, or disassemble, or otherwise reduce the Software to any human perceivable form, except to the extent that the foregoing restriction is expressly prohibited by applicable law.

Separation of Components. The Software is licensed as a single product. Its component parts may not be separated for use on more than one TV.

No Rental. You may not rent, lease, lend, or sublicense the Software.

Trademarks. This License Agreement does not grant you any rights to any trademarks of MDEA.

3. **VIOLATIONS.** You understand that any use, copying or transfer of the Software, except as permitted pursuant to this License, may subject you to serious criminal and civil penalties including damages and an award to MDEA of attorneys’ fees in connection with any violation of this License. You further understand that you may be held legally responsible for any copyright infringement or other violation of intellectual property rights that is caused, encouraged, or induced by your failure to abide by the terms of the License. This license is effective until terminated, and will terminate immediately without notice from MDEA or judicial resolution if you fail to comply with any provision of this License.

4. **COPYRIGHT.** All title and intellectual property rights in and to the Software (including but not limited to any images, photographs, animations, video, audio, music, text, and “applets” incorporated into the Software), and any accompanying printed materials are owned by or licensed to MDEA. All title and intellectual property rights in and to the content which may be accessed through use of the Software is the property of the respective content owner and may be protected by applicable copyright or other intellectual property laws and treaties. This License Agreement grants you no rights to use such content, except that you own the media on which the Software is recorded, but MDEA and its licensors retain ownership of the Software itself. All rights not expressly granted are reserved by MDEA.

5. **EXPORT RESTRICTIONS.** MDEA is licensing the Software for use within the United States. You agree that you will not export or re-export the Software. You specifically agree not to export or re-export the Software: (i) to any country to which the U.S. has embargoed or restricted the export of goods or services, which currently include, but are not necessarily limited to Cuba, Iran, Iraq, Libya, North Korea, Sudan, and Syria, or to any national of any such country, wherever located, who intends to transmit or transport the Software back to such country; (ii) to any person or entity who you know or have reason to know will utilize the Software in the design, development, or production of nuclear, chemical, or biological weapons; or (iii) to any person or entity who has been prohibited from participating in U.S. export transactions by any federal agency of the U.S. government. You warrant and represent that neither the BXA nor any other U.S. federal agency has suspended, revoked, or denied your export privileges.

6. **DISCLAIMER OF WARRANTY. EXCEPT AS OTHERWISE PROVIDED IN THIS LICENSE OR IN THE LIMITED WARRANTY APPLICABLE TO THE TV, MDEA MAKES NO OTHER WARRANTIES OF ANY KIND WHATSOEVER REGARDING THE SOFTWARE AND HEREBY EXPRESSLY DISCLAIMS ALL WARRANTIES OF ANY KIND WHATSOEVER, EXPRESS OR IMPLIED, WITH RESPECT TO THE SOFTWARE. ALL IMPLIED WARRANTIES, INCLUDING, WITHOUT LIMITATION, THE IMPLIED WARRANTIES OF MERCHANTABILITY AND FITNESS FOR A PARTICULAR PURPOSE ARE HEREBY EXPRESSLY DISCLAIMED BY MDEA. IN NO EVENT SHALL MDEA BE LIABLE TO YOU OR ANY THIRD PARTIES, IN CONTRACT, IN TORT OR OTHERWISE, FOR ANY DIRECT, INDIRECT, SPECIAL, INCIDENTAL OR CONSEQUENTIAL DAMAGES OF ANY KIND OR NATURE. BECAUSE SOME JURISDICTIONS DO NOT ALLOW THE EXCLUSION OR LIMITATION OF IMPLIED WARRANTIES, THE ABOVE LIMITATION MAY NOT APPLY TO YOU.**

7. **LIMITATION OF LIABILITY. MDEA SHALL NOT, UNDER ANY CIRCUMSTANCES BE LIABLE TO YOU OR ANY THIRD PARTIES FOR ANY DAMAGES OF ANY NATURE, WHETHER INDIRECT, SPECIAL, INCIDENTAL, CONSEQUENTIAL OR OTHERWISE, INCLUDING, BUT NOT LIMITED TO, ANY CLAIMS FOR LOST PROFITS, LOSS OF GOOD WILL OR EXPENDITURES MADE OR COMMITTED FOR IN RELIANCE ON THE CONTINUATION OF THIS LICENSE. YOU AGREE THAT NEITHER MDEA’S BREACH OF THIS LICENSE NOR ITS FAILURE TO REPAIR A DEFECT, ERROR OR BUG SHALL CONSTITUTE A FAILURE OF THE ESSENTIAL PURPOSE OF THIS LICENSE. BECAUSE SOME JURISDICTIONS DO NOT ALLOW THE EXCLUSION OR LIMITATION OF LIABILITY FOR CONSEQUENTIAL OR INCIDENTAL DAMAGES, THE ABOVE LIMITATIONS MAY NOT APPLY TO YOU. MDEA’S liability to you for direct damages for any cause whatsoever and regardless of the form of the action, will be limited to the money paid by you for the TV (based on fair market value of the TV) that caused the damages.**

8. **GENERAL.** This License Agreement will be governed by the laws of the State of California.

# GNU General Public License

Version 2, June 1991

Copyright (C) 1989, 1991

Free Software Foundation, Inc.

675 Mass Ave, Cambridge, MA 02139, USA

Everyone is permitted to copy and distribute verbatim copies of this license document, but changing it is not allowed.

## Preamble

The licenses for most software are designed to take away your freedom to share and change it. By contrast, the GNU General Public License is intended to guarantee your freedom to share and change free software--to make sure the software is free for all its users. This General Public License applies to most of the Free Software Foundation's software and to any other program whose authors commit to using it. (Some other Free Software Foundation software is covered by the GNU Library General Public License instead.) You can apply it to your programs, too.

When we speak of free software, we are referring to freedom, not price. Our General Public Licenses are designed to make sure that you have the freedom to distribute copies of free software (and charge for this service if you wish), that you receive source code or can get it if you want it, that you can change the software or use pieces of it in new free programs; and that you know you can do these things.

To protect your rights, we need to make restrictions that forbid anyone to deny you these rights or to ask you to surrender the rights. These restrictions translate to certain responsibilities for you if you distribute copies of the software, or if you modify it.

For example, if you distribute copies of such a program, whether gratis or for a fee, you must give the recipients all the rights that you have. You must make sure that they, too, receive or can get the source code. And you must show them these terms so they know their rights.

We protect your rights with two steps: (1) copyright the software, and (2) offer you this license which gives you legal permission to copy, distribute and/or modify the software.

Also, for each author's protection and ours, we want to make certain that everyone understands that there is no warranty for this free software. If the software is modified by someone else and passed on, we want its recipients to know that what they have is not the original, so that any problems introduced by others will not reflect on the original authors' reputations.

Finally, any free program is threatened constantly by software patents. We wish to avoid the danger that redistributors of a free program will individually obtain patent licenses, in effect making the program proprietary. To prevent this, we have made it clear that any patent must be licensed for everyone's free use or not licensed at all.

The precise terms and conditions for copying, distribution and modification follow.

## GNU GENERAL PUBLIC LICENSE

### TERMS AND CONDITIONS FOR COPYING, DISTRIBUTION AND MODIFICATION

0. This License applies to any program or other work which contains a notice placed by the copyright holder saying it may be distributed under the terms of this General Public License. The "Program", below, refers to any such program or work, and a "work based on the Program" means either the Program or any derivative work under copyright law; that is to say, a work containing the Program or a portion of it, either verbatim or with modifications and/or translated into another language. (Hereinafter, translation is included without limitation in the term "modification".) Each licensee is addressed as "you".

Activities other than copying, distribution and modification are not covered by this License; they are outside its scope. The act of running the Program is not restricted, and the output from the Program is covered only if its contents constitute a work based on the Program (independent of having been made by running the Program). Whether that is true depends on what the Program does.

1. You may copy and distribute verbatim copies of the Program's source code as you receive it, in any medium, provided that you conspicuously and appropriately publish on each copy an appropriate copyright notice and disclaimer of warranty; keep intact all the notices that refer to this License and to the absence of any warranty; and give any other recipients of the Program a copy of this License along with the Program.

You may charge a fee for the physical act of transferring a copy, and you may at your option offer warranty protection in exchange for a fee.

2. You may modify your copy or copies of the Program or any portion of it, thus forming a work based on the Program, and copy and distribute such modifications or work under the terms of Section 1 above, provided that you also meet all of these conditions:

- You must cause the modified files to carry prominent notices stating that you changed the files and the date of any change.
- You must cause any work that you distribute or publish, that in whole or in part contains or is derived from the Program or any part thereof, to be licensed as a whole at no charge to all third parties under the terms of this License.
- If the modified program normally reads commands interactively when run, you must cause it, when started running for such interactive use in the most ordinary way, to print or display an announcement including an appropriate copyright notice and a notice that there is no warranty (or else, saying that you provide a warranty) and that users may redistribute the program under these conditions, and telling the user how to view a copy of this License. (Exception: if the Program itself is interactive but does not normally print such an announcement, your work based on the Program is not required to print an announcement.)

These requirements apply to the modified work as a whole. If identifiable sections of that work are not derived from the Program, and can be reasonably considered independent and separate works in themselves, then this License, and its terms, do not apply to those sections when you distribute them as separate works. But when you distribute the same sections as part of a whole which is a work based on the Program, the distribution of the whole must be on the terms of this License, whose permissions for other licensees extend to the entire whole, and thus to each and every part regardless of who wrote it.

Thus, it is not the intent of this section to claim rights or contest your rights to work written entirely by you; rather, the intent is to exercise the right to control the distribution of derivative or collective works based on the Program.

In addition, mere aggregation of another work not based on the Program with the Program (or with a work based on the Program) on a volume of a storage or distribution medium does not bring the other work under the scope of this License.

3. You may copy and distribute the Program (or a work based on it, under Section 2) in object code or executable form under the terms of Sections 1 and 2 above provided that you also do one of the following:

- Accompany it with the complete corresponding machine-readable source code, which must be distributed under the terms of Sections 1 and 2 above on a medium customarily used for software interchange; or,
- Accompany it with a written offer, valid for at least three years, to give any third party, for a charge no more than your cost of physically performing source distribution, a complete machine-readable copy of the corresponding source code, to be distributed under the terms of Sections 1 and 2 above on a medium customarily used for software interchange; or,
- Accompany it with the information you received as to the offer to distribute corresponding source code. (This alternative is allowed only for noncommercial distribution and only if you received the program in object code or executable form with such an offer, in accord with Subsection b above.)

The source code for a work means the preferred form of the work for making modifications to it. For an executable work, complete source code means all the source code for all modules it contains, plus any associated interface definition files, plus the scripts used to control compilation and installation of the executable. However, as a special exception, the source code distributed need not include anything that is normally distributed (in either source or binary form) with the major components (compiler, kernel, and so on) of the operating system on which the executable runs, unless that component itself accompanies the executable.

If distribution of executable or object code is made by offering access to copy from a designated place, then offering equivalent access to copy the source code from the same place counts as distribution of the source code, even though third parties are not compelled to copy the source along with the object code.

4. You may not copy, modify, sublicense, or distribute the Program except as expressly provided under this License. Any attempt otherwise to copy, modify, sublicense or distribute the Program is void, and will automatically terminate your rights under this License. However, parties who have received copies, or rights, from you under this License will not have their licenses terminated so long as such parties remain in full compliance.

5. You are not required to accept this License, since you have not signed it. However, nothing else grants you permission to modify or distribute the Program or its derivative works. These actions are prohibited by law if you do not accept this License. Therefore, by modifying or distributing the Program (or any work based on the Program), you indicate your acceptance of this License to do so, and all its terms and conditions for copying, distributing or modifying the Program or works based on it.

6. Each time you redistribute the Program (or any work based on the Program), the recipient automatically receives a license from the original licensor to copy, distribute or modify the Program subject to these terms and conditions. You may not impose any further restrictions on the recipients' exercise of the rights granted herein. You are not responsible for enforcing compliance by third parties to this License.

7. If, as a consequence of a court judgment or allegation of patent infringement or for any other reason (not limited to patent issues), conditions are imposed on you (whether by court order, agreement or otherwise) that contradict the conditions of this License, they do not excuse you from the conditions of this License. If you cannot distribute so as to satisfy simultaneously your obligations under this License and any other pertinent obligations, then as a consequence you may not distribute the Program at all. For example, if a patent license would not permit royalty-free redistribution of the Program by all those who receive copies directly or indirectly through you, then the only way you could satisfy both it and this License would be to refrain entirely from distribution of the Program.

If any portion of this section is held invalid or unenforceable under any particular circumstance, the balance of the section is intended to apply and the section as a whole is intended to apply in other circumstances.

It is not the purpose of this section to induce you to infringe any patents or other property right claims or to contest validity of any such claims; this section has the sole purpose of protecting the integrity of the free software distribution system, which is implemented by public license practices. Many people have made generous contributions to the wide range of software distributed through that system in reliance on consistent application of that system; it is up to the author/donor to decide if he or she is willing to distribute software through any other system and a licensee cannot impose that choice.

This section is intended to make thoroughly clear what is believed to be a consequence of the rest of this License.

8. If the distribution and/or use of the Program is restricted in certain countries either by patents or by copyrighted interfaces, the original copyright holder who places the Program under this License may add an explicit geographical distribution limitation excluding those countries, so that distribution is permitted only in or among countries not thus excluded. In such case, this License incorporates the limitation as if written in the body of this License.

9. The Free Software Foundation may publish revised and/or new versions of the General Public License from time to time. Such new versions will be similar in spirit to the present version, but may differ in detail to address new problems or concerns.

Each version is given a distinguishing version number. If the Program specifies a version number of this License which applies to it and "any later version", you have the option of following the terms and conditions either of that version or of any later version published by the Free Software Foundation. If the Program does not specify a version number of this License, you may choose any version ever published by the Free Software Foundation.

**If you are interested in obtaining open source code for this product, please contact Mitsubishi at (800) 332-2119. A nominal handling and mailing charge may apply.**

**For assistance call 1(800) 332-2119**

10. If you wish to incorporate parts of the Program into other free programs whose distribution conditions are different, write to the author to ask for permission. For software which is copyrighted by the Free Software Foundation, write to the Free Software Foundation; we sometimes make exceptions for this. Our decision will be guided by the two goals of preserving the free status of all derivatives of our free software and of promoting the sharing and reuse of software generally.

#### NO WARRANTY

11. BECAUSE THE PROGRAM IS LICENSED FREE OF CHARGE, THERE IS NO WARRANTY FOR THE PROGRAM, TO THE EXTENT PERMITTED BY APPLICABLE LAW. EXCEPT WHEN OTHERWISE STATED IN WRITING THE COPYRIGHT HOLDERS AND/OR OTHER PARTIES PROVIDE THE PROGRAM "AS IS" WITHOUT WARRANTY OF ANY KIND, EITHER EXPRESSED OR IMPLIED, INCLUDING, BUT NOT LIMITED TO, THE IMPLIED WARRANTIES OF MERCHANTABILITY AND FITNESS FOR A PARTICULAR PURPOSE. THE ENTIRE RISK AS TO THE QUALITY AND PERFORMANCE OF THE PROGRAM IS WITH YOU. SHOULD THE PROGRAM PROVE DEFECTIVE, YOU ASSUME THE COST OF ALL NECESSARY SERVICING, REPAIR OR CORRECTION.

12. IN NO EVENT UNLESS REQUIRED BY APPLICABLE LAW OR AGREED TO IN WRITING WILL ANY COPYRIGHT HOLDER, OR ANY OTHER PARTY WHO MAY MODIFY AND/OR REDISTRIBUTE THE PROGRAM AS PERMITTED ABOVE, BE LIABLE TO YOU FOR DAMAGES, INCLUDING ANY GENERAL, SPECIAL, INCIDENTAL OR CONSEQUENTIAL DAMAGES ARISING OUT OF THE USE OR INABILITY TO USE THE PROGRAM (INCLUDING BUT NOT LIMITED TO LOSS OF DATA OR DATA BEING RENDERED INACCURATE OR LOSSES SUSTAINED BY YOU OR THIRD PARTIES OR A FAILURE OF THE PROGRAM TO OPERATE WITH ANY OTHER PROGRAMS), EVEN IF SUCH HOLDER OR OTHER PARTY HAS BEEN ADVISED OF THE POSSIBILITY OF SUCH DAMAGES.

# GNU GENERAL PUBLIC LICENSE

## Version 3, 29 June 2007

Copyright © 2007 Free Software Foundation, Inc. <<http://fsf.org/>>

Everyone is permitted to copy and distribute verbatim copies of this license document, but changing it is not allowed.

### Preamble

The GNU General Public License is a free, copyleft license for software and other kinds of works.

The licenses for most software and other practical works are designed to take away your freedom to share and change the works. By contrast, the GNU General Public License is intended to guarantee your freedom to share and change all versions of a program--to make sure it remains free software for all its users. We, the Free Software Foundation, use the GNU General Public License for most of our software; it applies also to any other work released this way by its authors. You can apply it to your programs, too.

When we speak of free software, we are referring to freedom, not price. Our General Public Licenses are designed to make sure that you have the freedom to distribute copies of free software (and charge for them if you wish), that you receive source code or can get it if you want it, that you can change the software or use pieces of it in new free programs, and that you know you can do these things.

To protect your rights, we need to prevent others from denying you these rights or asking you to surrender the rights. Therefore, you have certain responsibilities if you distribute copies of the software, or if you modify it: responsibilities to respect the freedom of others.

For example, if you distribute copies of such a program, whether gratis or for a fee, you must pass on to the recipients the same freedoms that you received. You must make sure that they, too, receive or can get the source code. And you must show them these terms so they know their rights.

Developers that use the GNU GPL protect your rights with two steps: (1) assert copyright on the software, and (2) offer you this License giving you legal permission to copy, distribute and/or modify it.

For the developers' and authors' protection, the GPL clearly explains that there is no warranty for this free software. For both users' and authors' sake, the GPL requires that modified versions be marked as changed, so that their problems will not be attributed erroneously to authors of previous versions.

Some devices are designed to deny users access to install or run modified versions of the software inside them, although the manufacturer can do so. This is fundamentally incompatible with the aim of protecting users' freedom to change the software. The systematic pattern of such abuse occurs in the area of products for individuals to use, which is precisely where it is most unacceptable. Therefore, we have designed this version of the GPL to prohibit the practice for those products. If such problems arise substantially in other domains, we stand ready to extend this provision to those domains in future versions of the GPL, as needed to protect the freedom of users. Finally, every program is threatened constantly by software patents. States should not allow patents to restrict development and use of software on general-purpose computers, but in those that do, we wish to avoid the special danger that patents applied to a free program could make it effectively proprietary. To prevent this, the GPL assures that patents cannot be used to render the program non-free.

The precise terms and conditions for copying, distribution and modification follow.

### TERMS AND CONDITIONS

#### 0. Definitions.

"This License" refers to version 3 of the GNU General Public License.

"Copyright" also means copyright-like laws that apply to other kinds of works, such as semiconductor masks.

"The Program" refers to any copyrightable work licensed under this License. Each licensee is addressed as "you", "Licensees" and "recipients" may be individuals or organizations.

To "modify" a work means to copy from or adapt all or part of the work in a fashion requiring copyright permission, other than the making of an exact copy. The resulting work is called a "modified version" of the earlier work or work "based on" the earlier work.

A "covered work" means either the unmodified Program or a work based on the Program.

To "propagate" a work means to do anything with it that, without permission, would make you directly or secondarily liable for infringement under applicable copyright law, except executing it on a computer or modifying a private copy. Propagation includes copying, distribution (with or without modification), making available to the public, and in some countries other activities as well.

To "convey" a work means any kind of propagation that enables other parties to make or receive copies. Mere interaction with a user through a computer network, with no transfer of a copy, is not conveying.

An interactive user interface displays "Appropriate Legal Notices" to the extent that it includes a convenient and prominently visible feature that (1) displays an appropriate copyright notice, and (2) tells the user that there is no warranty for the work (except to the extent that warranties are provided), that licensees may convey the work under this License, and how to view a copy of this License. If the interface presents a list of user commands or options, such as a menu, a prominent item in the list meets this criterion.

#### 1. Source Code.

The "source code" for a work means the preferred form of the work for making modifications to it. "Object code" means any non-source form of a work.

A "Standard Interface" means an interface that either is an official standard defined by a recognized standards body, or, in the case of interfaces specified for a particular programming language, one that is widely used among developers working in that language.

The "System Libraries" of an executable work include anything, other than the work as a whole, that (a) is included in the normal form of packaging a Major Component, but which is not part of that Major Component, and (b) serves only to enable use of the work with that Major Component, or to implement a Standard Interface for which an implementation is available to the public in source code form. A "Major Component", in this context, means a major essential component (kernel, window system, and so on) of the specific operating system (if any) on which the executable work runs, or a compiler used to produce the work, or an object code interpreter used to run it. The "Corresponding Source" for a work in object code form means all the source code needed to generate, install, and for an executable work) run the object code and to modify the work, including scripts to control those activities. However, it does not include the work's System Libraries, or general-purpose tools or generally available free programs which are used unmodified in performing those activities but which are not part of the work. For example, Corresponding Source includes interface definition files associated with source files for the work, and the source code for shared libraries and dynamically linked subprograms that the work is specifically designed to require, such as by intimate data communication or control flow between those subprograms and other parts of the work.

The Corresponding Source need not include anything that users can regenerate automatically from other parts of the Corresponding Source.

The Corresponding Source for a work in source code form is that same work.

#### 2. Basic Permissions.

All rights granted under this License are granted for the term of copyright on the Program, and are irrevocable provided the stated conditions are met. This License explicitly affirms your unlimited permission to run the unmodified Program. The output from running a covered work is covered by this License only if the output, given its content, constitutes a covered work. This License acknowledges your rights of fair use or other equivalent, as provided by copyright law.

You may make, run and propagate covered works that you do not convey, without conditions so long as your license otherwise remains in force. You may convey covered works to others for the sole purpose of having them make modifications exclusively for you, or provide you with facilities for running those works, provided that you comply with the terms of this License in conveying all material for which you do not control copyright. Those thus making or running the covered works for you must do so exclusively on your behalf, under your direction and control, on terms that prohibit them from making any copies of your copyrighted material outside their relationship with you.

Conveying under any other circumstances is permitted solely under the conditions stated below. Sublicensing is not allowed; section 10 makes it unnecessary.

#### 3. Protecting Users' Legal Rights From Anti-Circumvention Law.

No covered work shall be deemed part of an effective technological measure under any applicable law fulfilling obligations under article 11 of the WIPO copyright treaty adopted on 20 December 1996, or similar laws prohibiting or restricting circumvention of such measures.

When you convey a covered work, you waive any legal power to forbid circumvention of technological measures to the extent such circumvention is effected by exercising rights under this License with respect to the covered work, and you disclaim any intention to limit operation or modification of the work as a means of enforcing, against the work's users, your or third parties' legal rights to forbid circumvention of technological measures.

#### 4. Conveying Verbatim Copies.

You may convey verbatim copies of the Program's source code as you receive it, in any medium, provided that you conspicuously and appropriately publish on each copy an appropriate copyright notice; keep intact all notices stating that this License and any non-permissive terms added in accord with section 7 apply to the code; keep intact all notices of the absence of any warranty; and give all recipients a copy of this License along with the Program.

You may charge any price or no price for each copy that you convey, and you may offer support or warranty protection for a fee.

#### 5. Conveying Modified Source Versions.

You may convey a work based on the Program, or the modifications to produce it from the Program, in the form of source code under the terms of section 4, provided that you also meet all of these conditions:

a) The work must carry prominent notices stating that you modified it, and giving a relevant date.

b) The work must carry prominent notices stating that it is released under this License and any conditions added under section 7. This requirement modifies the requirement in section 4 to "keep intact all notices".

c) You must license the entire work, as a whole, under this License to anyone who comes into possession of a copy. This License will therefore apply, along with any applicable section 7 additional terms, to the whole of the work, and all its parts, regardless of how they are packaged. This License gives no permission to license the work in any other way, but it does not invalidate such permission if you have separately received it.

d) If the work has interactive user interfaces, each must display Appropriate Legal Notices; however, if the Program has interactive interfaces that do not display Appropriate Legal Notices, your work need not make them do so. A compilation of a covered work with other separate and independent works, which are not by their nature extensions of the covered work, and which are not combined with it such as to form a larger program, in or on a volume of a storage or distribution medium, is called an "aggregate" if the compilation and its resulting copyright are not used to limit the access or legal rights of the compilation's users beyond what the individual works permit. Inclusion of a covered work in an aggregate does not cause this License to apply to the other parts of the aggregate.

#### 6. Conveying Non-Source Forms.

You may convey a covered work in object code form under the terms of sections 4 and 5, provided that you also convey the machine-readable Corresponding Source under the terms of this License, in one of these ways:

a) Convey the object code in, or embodied in, a physical product (including a physical distribution medium), accompanied by the Corresponding Source fixed on a durable physical medium customarily used for software interchange.

b) Convey the object code in, or embodied in, a physical product (including a physical distribution medium), accompanied by a written offer, valid for at least three years and valid for as long as you offer spare parts or customer support for that product model, to give anyone who possesses the object code either (1) a copy of the Corresponding Source for all the software in the product that is covered by this License, on a durable physical medium customarily used for software interchange, for a price no more than your reasonable cost of physically performing this conveying of source, or (2) access to copy the Corresponding Source from a network server at no charge.

c) Convey individual copies of the object code with a copy of the written offer to provide the Corresponding Source. This alternative is allowed only occasionally and noncommercially, and only if you received the object code with such an offer, in accord with subsection 6b.

d) Convey the object code by offering access from a designated place (gratis or for a charge), and offer equivalent access to the Corresponding Source in the same way through the same place at no further charge. You need not require recipients to copy the Corresponding Source along with the object code. If the place to copy the object code is a network server, the Corresponding Source may be on a different server (operated by you or a third party) that supports equivalent copying facilities, provided you maintain clear directions next to the object code saying where to find the Corresponding Source. Regardless of what server hosts the Corresponding Source, you

**For assistance call 1(800) 332-2119**

remain obligated to ensure that it is available for as long as needed to satisfy these requirements.

e) Convey the object code using peer-to-peer transmission, provided you inform other peers where the object code and Corresponding Source of the work are being offered to the general public at no charge under subsection 6d.

A separable portion of the object code, whose source code is excluded from the Corresponding Source as a System Library, need not be included in conveying the object code work.

A "User Product" is either (1) a "consumer product", which means any tangible personal property which is normally used for personal, family, or household purposes, or (2) anything designed or sold for incorporation into a dwelling. In determining whether a product is a consumer product, doubtful cases shall be resolved in favor of coverage. For a particular product received by a particular user, "normally used" refers to a typical or common use of that class of product, regardless of the status of the particular user or of the way in which the particular user actually uses, or expects or is expected to use, the product. A product is a consumer product regardless of whether the product has substantial commercial, industrial or non-consumer uses, unless such uses represent the only significant mode of use of the product.

"Installation Information" for a User Product means any methods, procedures, authorization keys, or other information required to install and execute modified versions of a covered work in that User Product from a modified version of its Corresponding Source. The information must suffice to ensure that the continued functioning of the modified object code is in no case prevented or interfered with solely because modification has been made. If you convey an object code work under this section in, or with, or specifically for use in, a User Product, and the conveying occurs as part of a transaction in which the right of possession and use of the User Product is transferred to the recipient in perpetuity or for a fixed term (regardless of how the transaction is characterized), the Corresponding Source conveyed under this section must be accompanied by the Installation Information. But this requirement does not apply if neither you nor any third party retains the ability to install modified object code on the User Product (for example, the work has been installed in ROM).

The requirement to provide Installation Information does not include a requirement to continue to provide support service, warranty, or updates for a work that has been modified or installed by the recipient, or for the User Product in which it has been modified or installed. Access to a network may be denied when the modification itself materially and adversely affects the operation of the network or violates the rules and protocols for communication across the network.

Corresponding Source conveyed, and Installation Information provided, in accord with this section must be in a format that is publicly documented (and with an implementation available to the public in source code form), and must require no special password or key for unpacking, reading or copying.

#### 7. Additional Terms.

"Additional permissions" are terms that supplement the terms of this License by making exceptions from one or more of its conditions. Additional permissions that are applicable to the entire Program shall be treated as though they were included in this License, to the extent that they are valid under applicable law. If additional permissions apply only to part of the Program, that part may be used separately under those permissions, but the entire Program remains governed by this License without regard to the additional permissions.

When you convey a copy of a covered work, you may at your option remove any additional permissions from that copy, or from any part of it. (Additional permissions may be written to require their own removal in certain cases when you modify the work.) You may place additional permissions on material, added by you to a covered work, for which you have or can give appropriate copyright permission.

Notwithstanding any other provision of this License, for material you add to a covered work, you may (if authorized by the copyright holders of that material) supplement the terms of this License with terms:

- Disclaiming warranty or limiting liability differently from the terms of sections 15 and 16 of this License; or
- Requiring preservation of specified reasonable legal notices or author attributions in that material or in the Appropriate Legal Notices displayed by works containing it; or
- Prohibiting misrepresentation of the origin of that material, or requiring that modified versions of such material be marked in reasonable ways as different from the original version; or
- Limiting the use for publicity purposes of names of licensors or authors of the material; or
- Declining to grant rights under trademark law for use of some trade names, trademarks, or service marks; or
- Requiring indemnification of licensors and authors of that material by anyone who conveys the material (or modified versions of it) with contractual assumptions of liability to the recipient, for any liability that these contractual assumptions directly impose on those licensors and authors.

All other non-permissive additional terms are considered "further restrictions" within the meaning of section 10. If the Program as you received it, or any part of it, contains a notice stating that it is governed by this License along with a term that is a further restriction, you may remove that term. If a license document contains a further restriction but permits relicensing or conveying under this License, you may add to a covered work material governed by the terms of that license document, provided that the further restriction does not survive such relicensing or conveying.

If you add terms to a covered work in accord with this section, you must place, in the relevant source files, a statement of the additional terms that apply to those files, or a notice indicating where to find the applicable terms.

Additional terms, permissive or non-permissive, may be stated in the form of a separately written license, or stated as exceptions; the above requirements apply either way.

#### 8. Termination.

You may not propagate or modify a covered work except as expressly provided under this License. Any attempt otherwise to propagate or modify it is void, and will automatically terminate your rights under this License (including any patent licenses granted under the third paragraph of section 11).

However, if you cease all violation of this License, then your license from a particular copyright holder is reinstated (a) provisionally, unless and until the copyright holder explicitly and finally terminates your license, and (b) permanently, if the copyright holder fails to notify you of the violation by some reasonable means prior to 60 days after the cessation.

Moreover, your license from a particular copyright holder is reinstated permanently if the copyright holder notifies you of the violation by some reasonable means, this is the first time you have received notice of violation of this License (for any work) from that copyright holder, and you cure the violation prior to 30 days after your receipt of the notice.

Termination of your rights under this section does not terminate the licenses of parties who have received copies or rights from you under this License. If your rights have been terminated and not permanently reinstated, you do not qualify to receive new licenses for the same material under section 10.

#### 9. Acceptance Not Required for Having Copies.

You are not required to accept this License in order to receive or run a copy of the Program. Ancillary propagation of a covered work occurring solely as a consequence of using peer-to-peer transmission to receive a copy likewise does not require acceptance. However, nothing other than this License grants you permission to propagate or modify any covered work. These actions infringe copyright if you do not accept this License. Therefore, by modifying or propagating a covered work, you indicate your acceptance of this License to do so.

#### 10. Automatic Licensing of Downstream Recipients.

Each time you convey a covered work, the recipient automatically receives a license from the original licensors, to run, modify and propagate that work, subject to this License. You are not responsible for enforcing compliance by third parties with this License.

An "entity transaction" is a transaction transferring control of an organization, or substantially all assets of one, or subdividing an organization, or merging organizations. If propagation of a covered work results from an entity transaction, each party to that transaction who receives a copy of the work also receives whatever licenses to the work the party's predecessor in interest had or could give under the previous paragraph, plus a right to possession of the Corresponding Source of the work from the predecessor in interest, if the predecessor has it or can get it with reasonable efforts.

You may not impose any further restrictions on the exercise of the rights granted or affirmed under this License. For example, you may not impose a license fee, royalty, or other charge for exercise of rights granted under this License, and you may not initiate litigation (including a cross-claim or counterclaim in a lawsuit) alleging that any patent claim is infringed by making, using, selling, offering for sale, or importing the Program or any portion of it.

#### 11. Patents.

A "contributor" is a copyright holder who authorizes use under this License of the Program or a work on which the Program is based. The work thus licensed is called the contributor's "contributor version".

A contributor's "essential patent claims" are all patent claims owned or controlled by the contributor, whether already acquired or hereafter acquired, that would be infringed by some manner, permitted by this License, of making, using, or selling its contributor version, but do not include claims that would be infringed only as a consequence of further modification of the contributor version. For purposes of this definition, "control" includes the right to grant patent sublicenses in a manner consistent with the requirements of this License.

Each contributor grants you a non-exclusive, worldwide, royalty-free patent license under the contributor's essential patent claims, to make, use, sell, offer for sale, import and otherwise run, modify and propagate the contents of its contributor version.

In the following three paragraphs, a "patent license" is any express agreement or commitment, however denominated, not to enforce a patent (such as an express permission to practice a patent or covenant not to sue for patent infringement). To "grant" such a patent license to a party means to make such an agreement or commitment not to enforce a patent against the party.

If you convey a covered work, knowingly relying on a patent license, and the Corresponding Source of the work is not available for anyone to copy, free of charge and under the terms of this License, through a publicly available network server or other readily accessible means, then you must either (1) cause the Corresponding Source to be so available, or (2) arrange to deprive yourself of the benefit of the patent license for this particular work, or (3) arrange, in a manner consistent with the requirements of this License, to extend the patent license to downstream recipients. "Knowingly relying" means you have actual knowledge that, but for the patent license, your conveying the covered work in a country, or your recipient's use of the covered work in a country, would infringe one or more identifiable patents in that country that you have reason to believe are valid.

If, pursuant to or in connection with a single transaction or arrangement, you convey, or propagate by procuring conveyance of, a covered work, and grant a patent license to some of the parties receiving the covered work authorizing them to use, propagate, modify or convey a specific copy of the covered work, then the patent license you grant is automatically extended to all recipients of the covered work and works based on it.

A patent license is "discriminatory" if it does not include within the scope of its coverage, prohibits the exercise of, or is conditioned on the non-exercise of one or more of the rights that are specifically granted under this License. You may not convey a covered work if you are a party to an arrangement with a third party that is in the business of distributing software, under which you make payment to the third party based on the extent of your activity of conveying the work, and under which the third party grants, to any of the parties who would receive the covered work from you, a discriminatory patent license (a) in connection with copies of the covered work conveyed by you (or copies made from those copies), or (b) primarily for and in connection with specific products or compilations that contain the covered work, unless you entered into that arrangement, or that patent license was granted, prior to 28 March 2007.

Nothing in this License shall be construed as excluding or limiting any implied license or other defenses to infringement that may otherwise be available to you under applicable patent law.

#### 12. No Surrender of Others' Freedom.

If conditions are imposed on you (whether by court order, agreement or otherwise) that contradict the conditions of this License, they do not excuse you from the conditions of this License. If you cannot convey a covered work so as to satisfy simultaneously your obligations under this License and any other pertinent obligations, then as a consequence you may not convey it at all. For example, if you agree to terms that obligate you to collect a royalty for further conveying from those to whom you convey the Program, the only way you could satisfy both those terms and this License would be to refrain entirely from conveying the Program.

#### 13. Use with the GNU Affero General Public License.

Notwithstanding any other provision of this License, you have permission to link or combine any covered work with a work licensed under version 3 of the GNU Affero General Public License into a single combined work, and to convey the resulting work. The terms of this License will continue to apply to the part which is the covered work, but the special requirements of the GNU Affero General Public License, section 13, concerning interaction through a network will apply to the combination as such.

#### 14. Revised Versions of this License.

The Free Software Foundation may publish revised and/or new versions of the GNU General Public License from time to time. Such new versions will be similar in spirit to the present version, but may differ in detail to address new problems or concerns.

Each version is given a distinguishing version number. If the Program specifies that a certain numbered version of the GNU General Public License "or any later version" applies to it, you have the option of following the terms and conditions either of that numbered version or of any later version published by the Free Software Foundation. If the Program does not specify a version number of the GNU General Public License, you may choose any version ever published by the Free Software Foundation.

If the Program specifies that a proxy can decide which future versions of the GNU General Public License can be used, that proxy's public statement of acceptance of a version permanently authorizes you to choose that version for the Program.

Later license versions may give you additional or different permissions. However, no additional obligations are imposed on any author or copyright holder as a result of your choosing to follow a later version.

#### 15. Disclaimer of Warranty.

IN NO EVENT UNLESS REQUIRED BY APPLICABLE LAW OR AGREED TO IN WRITING WILL ANY COPYRIGHT HOLDER, OR ANY OTHER PARTY WHO MODIFIES AND/OR CONVEYS THE PROGRAM AS PERMITTED ABOVE, BE LIABLE TO YOU FOR DAMAGES, INCLUDING ANY GENERAL, SPECIAL, INCIDENTAL OR CONSEQUENTIAL DAMAGES ARISING OUT OF THE USE OR INABILITY TO USE THE PROGRAM (INCLUDING BUT NOT LIMITED TO LOSS OF DATA OR DATA BEING RENDERED INACCURATE OR LOSSES SUSTAINED BY YOU OR THIRD PARTIES OR A FAILURE OF THE PROGRAM TO OPERATE WITH ANY OTHER PROGRAMS), EVEN IF SUCH HOLDER OR OTHER PARTY HAS BEEN ADVISED OF THE POSSIBILITY OF SUCH DAMAGES.

#### 16. Limitation of Liability.

IN NO EVENT UNLESS REQUIRED BY APPLICABLE LAW OR AGREED TO IN WRITING WILL ANY COPYRIGHT HOLDER, OR ANY OTHER PARTY WHO MODIFIES AND/OR CONVEYS THE PROGRAM AS PERMITTED ABOVE, BE LIABLE TO YOU FOR DAMAGES, INCLUDING ANY GENERAL, SPECIAL, INCIDENTAL OR CONSEQUENTIAL DAMAGES ARISING OUT OF THE USE OR INABILITY TO USE THE PROGRAM (INCLUDING BUT NOT LIMITED TO LOSS OF DATA OR DATA BEING RENDERED INACCURATE OR LOSSES SUSTAINED BY YOU OR THIRD PARTIES OR A FAILURE OF THE PROGRAM TO OPERATE WITH ANY OTHER PROGRAMS), EVEN IF SUCH HOLDER OR OTHER PARTY HAS BEEN ADVISED OF THE POSSIBILITY OF SUCH DAMAGES.

#### 17. Interpretation of Sections 15 and 16.

If the disclaimer of warranty and limitation of liability provided above cannot be given local legal effect according to their terms, reviewing courts shall apply local law that most closely approximates an absolute waiver of all civil liability in connection with the Program, unless a warranty or assumption of liability accompanies a copy of the Program in return for a fee.

## Mitsubishi LCD Flat Panel HDTV Limited Warranty

MITSUBISHI DIGITAL ELECTRONICS AMERICA, INC. ("MDEA") warrants to the original purchaser of this LCD Flat Panel HDTV that if purchased from an authorized MITSUBISHI Audio/Video Dealer, should it prove defective by reason of improper workmanship and/or material:

**a. Parts.** All parts (except any software incorporated into this HDTV) are warranted for a period of one year from the date of the original purchase at retail. We will repair or replace, at our option, any defective part without charge for the part. Parts used for replacement may be replaced with those of like kind and quality and may be new or remanufactured. Parts used for replacement are warranted for the remainder of the original warranty period.

**b. Embedded Software.** MDEA warrants that all software incorporated into this HDTV (the "Embedded Software") will perform in accordance with the functional description of Embedded Software in all material respects, but MDEA does not warrant that the Embedded Software is error-free. The warranty contained in this section shall continue for a period of one year, from the date of the original purchase from the authorized dealer. If, after prompt notice within the warranty period, MDEA determines that the Embedded Software has failed to perform in accordance with such functional description in all material respects and if such failure is not due to accident, misuse, modification or misapplication of the Embedded Software, then MDEA shall modify or replace the nonconforming Embedded Software at no charge to you, which at MDEA's sole discretion may be fulfilled by means of modification or replacement software contained on a replacement memory card for Consumer installation. The foregoing shall be MDEA's sole obligation to you under this limited warranty. All rights under this limited warranty on the Embedded Software also subject to your compliance with the terms of the Software License Agreement applicable to this HDTV, and this limited warranty on the Embedded Software shall be null and void if the Embedded Software is modified or changed in any manner except as specifically authorized by MDEA.

**c. Labor.** For certain items that are designed to be replaced by the consumer, including (but not limited to) some Embedded Software, the consumer is solely responsible for any replacement labor. For all other parts, we will provide the labor for a warranty repair by an authorized MITSUBISHI service center without charge for one year from the original date of purchase at retail.

**d. Notice.** To obtain warranty service, you must notify an authorized MITSUBISHI service center of any defect within the applicable warranty time period.

**BEFORE REQUESTING SERVICE, please review the TV owner's guide to insure proper installation and correct customer control adjustment. If the problem persists, please arrange for warranty service.**

### 1. TO OBTAIN WARRANTY SERVICE:

**a.** Contact your nearest authorized MITSUBISHI service center whose name and address can be obtained from your MITSUBISHI dealer, by writing to the address provided below, calling MDEA at 800-332-2119, or using the support feature of our website at [www.Mitsubishi-tv.com](http://www.Mitsubishi-tv.com).

**b.** Warranty service will be provided in your home or, if required, at an authorized service shop, provided that your television is located within the geographic territory customarily covered by an authorized MITSUBISHI service center. If not, you must either deliver your television to an authorized service location at your own expense, or pay for any travel and/or transportation costs the service center may charge to and from you home. Actual service labor will be provided without charge.

**c.** Proof of purchase from an authorized MITSUBISHI dealer is required when requesting warranty service. Present your sales receipt or other document which establishes proof and date of purchase. THE RETURN OF THE OWNER REGISTRATION CARD IS NOT A CONDITION OF WARRANTY COVERAGE. However, please return the Owner Registration Card so that we can contact you should a question of safety arise which could affect you.

### 2. THIS LIMITED WARRANTY DOES NOT COVER:

**a.** Up to .01% pixel outages (small dot picture elements that are dark or incorrectly illuminated).

**b.** Cosmetic damage or any other damage where such damage is caused by unauthorized modification, alteration, repairs to or service of the product by anyone other than an authorized MITSUBISHI service center; physical abuse to or misuse of the product (or any product damaged by excessive physical or electrical stress); any products that have had a serial number or any part thereof altered, defaced or removed; product use in any manner contrary to the Owner's Guide; freight damage; or any damage caused by acts of God or other factors beyond the reasonable control of MDEA, such as power surge damage caused by electrical system or damages caused by use of third party mounting brackets or stands. This limited warranty also excludes service calls where no defect in the product covered under this warranty is found, service calls related to unsatisfactory audio or visual reception or signal unless caused by a defect in the product that is covered under this limited warranty, all costs, expenses or any other damages arising from product installation, removal from or re-installation into custom installations or on

**For assistance call 1(800) 332-2119**

wall mountings, or set-ups, any adjustments of user controls (including contrast, brightness, color, tint, fine tuning, sharpness), other adjustment necessary to prepare the unit for display or use, connection with any external audio receiver, antenna, cable or satellite systems, or service of products purchased or serviced outside the U.S.A. Please consult the operating instructions contained in the Owner's Guide furnished with the product for information regarding user controls.

**3.** ANY EXPRESS WARRANTY NOT PROVIDED HEREIN, AND ANY REMEDY WHICH, BUT FOR THIS PROVISION, MIGHT ARISE BY IMPLICATION OR OPERATION OF LAW, IS HEREBY EXCLUDED AND DISCLAIMED. THE IMPLIED WARRANTIES OF MERCHANTABILITY AND OF FITNESS FOR ANY PARTICULAR PURPOSE ARE EXPRESSLY LIMITED TO A TERM OF ONE YEAR.

**4.** UNDER NO CIRCUMSTANCES SHALL MDEA BE LIABLE TO PURCHASER OR ANY OTHER PERSON FOR ANY INCIDENTAL, SPECIAL OR CONSEQUENTIAL DAMAGES, WHETHER ARISING OUT OF BREACH OF WARRANTY, BREACH OF CONTRACT, OR OTHERWISE.

**5.** Some states do not allow limitations on how long an implied warranty lasts, or the exclusion or limitation of incidental, special, or consequential damages, so the above limitations or exclusions may not apply to you.

**6.** This limited warranty gives you specific legal rights, and you may also have other rights which vary from state to state.

**7.** In the event of any dispute under this limited warranty, jurisdiction and venue for resolving that dispute will be in the state where the television was purchased and the laws of such state will govern. In no event shall Mitsubishi have any liability, including with out limitation, for general, consequential, incidental, or special damages for loss, destruction, damage or corruption of recorded data, media or software resulting from use of this television, or cost of recovery of lost data, media or software therefore.



MITSUBISHI DIGITAL ELECTRONICS AMERICA, INC.  
9351 Jeronimo Road  
Irvine, CA 92618-1904

## Network Service Disclaimer

Third party content and services, including without limitation home entertainment services by VUDU, Inc., are provided in accordance with whatever terms and conditions are established by the third party providers and agreed to by you. Mitsubishi Digital Electronics America ("MDEA") has no control over any such third parties or any agreement you reach with them. MDEA has no control over the networks or transmission facilities by which content and services are provided by third parties. Your connection to the internet may vary in availability and quality. Customer service questions are to be directed to the third-party provider, not MDEA.

MDEA DOES NOT WARRANT CONTENT OR SERVICES PROVIDED BY ANY THIRD PARTY, EITHER EXPRESSLY OR IMPLIEDLY, FOR ANY PURPOSE. MDEA DOES NOT WARRANT THAT ANY THIRD PARTY SERVICE WILL REMAIN AVAILABLE FOR ANY PERIOD OF TIME OR THAT IT WILL BE SATISFACTORY, UNINTERRUPTED OR ERROR FREE. MDEA EXPRESSLY DISCLAIMS ANY IMPLIED WARRANTIES, INCLUDING BUT NOT LIMITED TO, WARRANTIES OF MERCHANTABILITY OR FITNESS FOR A PARTICULAR PURPOSE WITH RESPECT TO ANY THIRD PARTY CONTENT AND SERVICES.

MDEA WILL NOT, UNDER ANY CIRCUMSTANCES, BE LIABLE, WHETHER IN CONTRACT OR TORT OR OTHER LEGAL THEORY, FOR ANY DIRECT, INDIRECT, INCIDENTAL, SPECIAL OR CONSEQUENTIAL DAMAGES, ATTORNEY FEES, EXPENSES, OR ANY OTHER DAMAGES ARISING OUT OF, OR IN CONNECTION WITH, YOUR USE OF ANY CONTENT OR SERVICE THAT IS PROVIDED TO YOU BY ANY THIRD PARTY, EVEN IF ADVISED OF THE POSSIBILITY OF SUCH DAMAGES.



**Website:**  
www.mitsubishi-tv.com

**E-mail:**  
MDEAservice@mdea.com

**Call Consumer Relations for operational or connection assistance at  
800-332-2119**

**To order replacement or additional  
remote controls or NetCommand IR emitters,**

**Visit our website [www.mitsuparts.com](http://www.mitsuparts.com)**

**or call**

**800-553-7278**

**SYSTEM RESET**

If the TV does not respond to the remote control, control-panel buttons, or will not power on/off, press and hold the **POWER** button on the control panel for ten seconds.

The TV will turn off. Power on the TV and the green LED will flash quickly for about one minute. Recent settings changes may be lost.

**For Your Records**

Record the model number, serial number, and purchase date of your TV. The model and serial numbers are on the back of the TV. Refer to this page when requesting assistance with the TV.

**MODEL NUMBER** \_\_\_\_\_  
**SERIAL NUMBER** \_\_\_\_\_  
**PURCHASE DATE** \_\_\_\_\_  
**RETAILER NAME** \_\_\_\_\_  
**LOCATION** \_\_\_\_\_