

atom

Wholesale Catalogue

2020-21



Content

atomⁱ

LED DOWNLIGHTS

SMART CONNECTED DOWNLIGHTS	9 - 10
RECESSED DOWNLIGHTS	11 - 33
SURFACE MOUNT DOWNLIGHTS	34 - 35
TRACK SPOT LIGHTING	36 - 37
DOWNLIGHT TRIM KIT	38
ACCESSORIES	39 - 41

LED OYSTERS

WIZ CONNECTED PRO	45 - 46
TRI COLOUR OYSTERS	47 - 52
DIMMABLE OYSTERS	53 - 54
ACCESSORIES	55

LED STRIPS

LED STRIPS KITS	59
SHALLOW EXTRUSIONS KITS	60
DEEP EXTRUSIONS KITS	60
CORNER EXTRUSIONS KITS	61
ACCESSORIES	61

LED STEPS LIGHTS

SQUARE OPAL RECESSED STEP LIGHT	64
SQUARE CLEAR RECESSED STEP LIGHT	64
RECTANGULAR OPAL RECESSED STEP LIGHT	65
RECTANGULAR CLEAR RECESSED STEP LIGHT	65

LED BUNKERS

CORRIDOR FUNCTION LED BUNKERS	68
TRI COLOUR LED BUNKERS	69 - 70
LED BUNKERS OVAL	71
LED BUNKERS ROUND	72
LED BUNKERS RECTANGLE	73

LED LAMPS

WIZ CONNECTED PRO	77 - 79
LED GLS LAMPS	80 - 81
LED CANDLE LAMPS	82 - 83
LED STICK LAMPS	83
LED G95 LAMPS	84
LED G120 LAMPS	85
LED G45 LAMPS	86
LED R63/R80 LAMPS	87
LED GU10 LAMPS	88
LED MR16 LAMPS	89
LED ST64 LAMPS	90 - 91
LED PAR38 LAMPS	92
LED LAMPS WITH DRIVER	92
ACCESSORIES	93

LED EXTERIOR AND WORKLIGHTS

UP/DOWN EXTERIOR LIGHTS	96
WALL SPOTS EXTERIOR LIGHTS	97
SPOTLIGHTS	98
SPOTLIGHTS WITH SENSOR	99
GARDEN SPIKES	100 - 101
BOLLARDS	102
WORKLIGHTS	103

COMMERCIAL LIGHTING

BACKLIT PANELS	106 - 107
TROFFER	108 - 109
FLOODLIGHTS	110 - 114
HIGHBAYS	115 - 116
WEATHERPROOF BATTENS	117 - 118
DIFFUSED BATTENS	119 - 120
WIRE GUARDS BATTENS	121
ACCESSORIES	122 - 123

DRIVERS AND ACCESSORIES

WEATHERPROOF DRIVERS	126
CONSTANT VOLTAGE DRIVERS	126 - 127
VOLTAGE DRIVERS	127
CONSTANT CURRENT DRIVERS	127
DIMMERS	128

VALUE, INNOVATION, QUALITY

atomⁱ

Originating in Queensland Atom Lighting is a major player in the lighting industry, with a high level of service and continual introduction of new products.

Through constant product development and testing, Atom not only focuses on the everyday needs of the market, but in technology, innovation and ensuring Atom products continue to challenge the norm in the industry.

New product development for Atom includes easy to install products that survive in the extreme environments found in Australia and New Zealand.







LED Downlights

LED Downlights are a great energy-saving light with a range of sizes, brightness and application abilities. For a light that fits perfectly into residential and commercial applications and with so many options, LED Downlights are the choice for you.

Overview

LED DOWNLIGHTS

SMART CONNECTED DOWNLIGHTS	9 - 10
RECESSED DOWNLIGHTS	11 - 33
SURFACE MOUNT DOWNLIGHTS	34 - 35
TRACK SPOT LIGHTING	36 - 37
DOWNLIGHT TRIM KIT	38
ACCESSORIES	39 - 41







AT4010/WIZ

10W LED Downlight WiZ Connected Pro - Flush lens

Product specification

Voltage	230~50Hz
Power consumption	10W
Dimmable	Yes*
Light colour options	RGB (64,000 Whites + 16 Million Colours) Tunable White
Colour temperature	3000K - 5700K + RGB
Beam angle	90°
IP Rating	IP44 (Front face only)
IC Rating	IC - 4

*Via the App or voice control. For additional information please visit our website

Product range

Code	Description
AT4010/WH/WIZ/TR SKU: 15331	10W LED Downlight - WiZ Connected Pro - Colours + Adjustable White - White - 820 - 860lm
AT4010/WH/WIZ/TW SKU: 15210	10W LED Downlight - WiZ Connected Pro - Adjustable white - White - 785 - 815lm



> 64,000 WHITES > 16 MILLION COLOURS

WiZ Pro Enterprise lighting interface

SET THE RULES AND SUPERVISE

Control multiple rooms and floors, pre-program schedules and set scenes

ENERGY USAGE MONITORING

Reports can be generated and exported based on each lamp's usage and energy consumption

PREDICTIVE MAINTENANCE

Each light reports its usage to the cloud. Lifespan can be calculated to proactively identify and replace fading lights

Finish

White

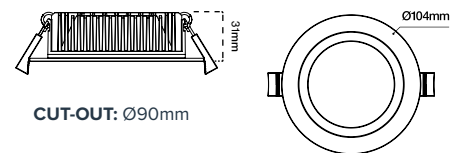

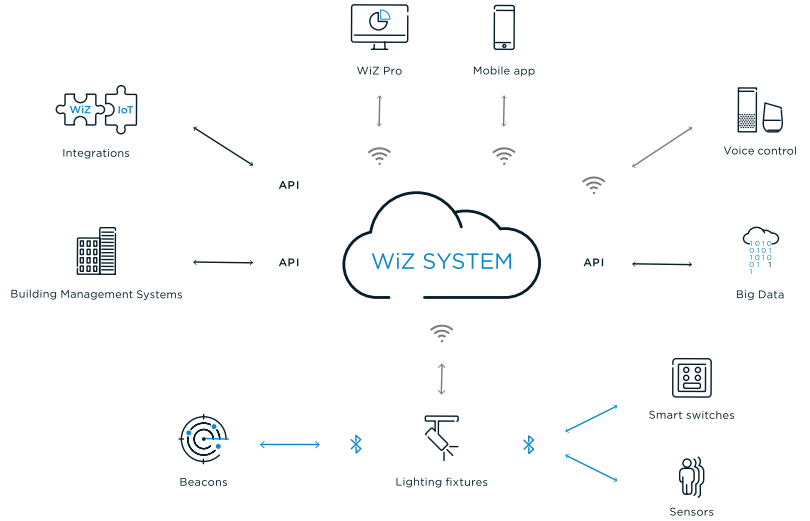

AT9017/WIZ

10W LED Downlight WiZ Connected Pro

Product specification

Voltage	230~50Hz
Power consumption	10W
Dimmable	Yes*
Light colour options	RGB (64,000 Whites + 16 Million Colours) Tunable White
Colour temperature	3000K - 5700K + RGB
Beam angle	90°
IP Rating	IP54 (Front face only)
IC Rating	IC - 4

*Via the App or voice control. For additional information please visit our website

Product range

Code	Description
AT9017/WH/WIZ/TR SKU: 15078	10W LED Downlight - WiZ Connected Pro - Colours + Adjustable White - White - 740 - 760lm
AT9017/WH/WIZ/TW SKU: 15082	10W LED Downlight - WiZ Connected Pro - Adjustable white - White - 720 - 750lm

> 64,000 WHITES > 16 MILLION COLOURS

WiZ Pro Enterprise lighting interface

SET THE RULES AND SUPERVISE

Control multiple rooms and floors, pre-program schedules and set scenes

ENERGY USAGE MONITORING

Reports can be generated and exported based on each lamp's usage and energy consumption

PREDICTIVE MAINTENANCE

Each light reports its usage to the cloud. Lifespan can be calculated to proactively identify and replace fading lights

Finish

White

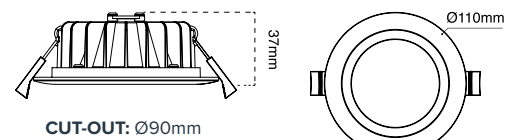



Finish

White

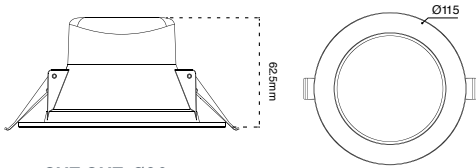

CUT-OUT: Ø90mm

AT9039/TRI

8W LED Downlight with Dimmable Integral Driver- Tri Colour

Product specification

Voltage	230~50Hz
Power consumption	8W
Dimmable	Yes
Light colour options	Tri Colour
Colour temperature	3000, 4000K & 5700K
Beam angle	90°
IP Rating	IP44 (Front face only)
IC Rating	IC - 4

Product range

Code	Description
AT9039/WH/TRI SKU: 14536	8W LED Downlight with Dimmable Integral Driver - White - Tri Colour - 670 - 755lm



Finish

White

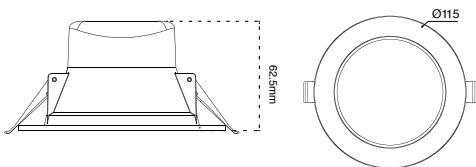

CUT-OUT: Ø90mm

AT9039

8W LED Downlight with Dimmable Integral Driver

Product specification

Voltage	230~50Hz
Power consumption	8W
Dimmable	Yes
Light colour options	Warm white, Cool white
Colour temperature	3000K 4000K
Beam angle	90°
IP Rating	IP44 (Front face only)
IC Rating	IC - 4

Product range

Code	Description
AT9039/WH/WW SKU: 11396	8W LED Downlight with Dimmable Integral Driver - White - Warm white - 750lm
AT9039/WH/CW SKU: 11458	8W LED Downlight with Dimmable Integral Driver - White - Cool white - 750lm

AT9039/F/TRI

8W LED Downlight with Dimmable Integral Driver- Tri Colour



Finish

White

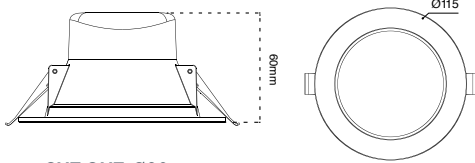

CUT-OUT: Ø90mm

Product specification

Voltage	230~50Hz
Power consumption	8W
Dimmable	Yes
Light colour options	Tri Colour
Colour temperature	3000, 4000K & 5700K
Beam angle	90°
IP Rating	IP44 (Front face only)
IC Rating	IC - 4

Product range

Code	Description
AT9039/WH/F/TRI SKU: 11269	8W LED Downlight with Dimmable Integral Driver - White - Flush Lens - Tri Colour - 670 - 755lm



Finish

White

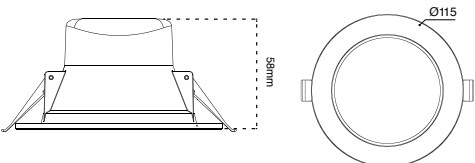

CUT-OUT: Ø90mm

AT9039/FLUSH

8W LED Downlight with Dimmable Integral Driver

Product specification

Voltage	230~50Hz
Power consumption	8W
Dimmable	Yes
Light colour options	Warm white, Cool white
Colour temperature	3000K 4000K
Beam angle	90°
IP Rating	IP44 (Front face only)
IC Rating	IC - 4

Product range

Code	Description
AT9039/WH/F/WW SKU: 12383	8W LED Downlight with Dimmable Integral Driver - White - Flush Lens - Warm white - 700lm
AT9039/WH/F/CW SKU: 12389	8W LED Downlight with Dimmable Integral Driver - White - Flush Lens - Cool white - 750lm



AT9012/TRI

12W LED Downlight supplied with Dimmable Driver- Tri Colour

Product specification

Voltage	230~50Hz
Power consumption	12W
Dimmable	Yes
Light colour options	Tri Colour
Colour temperature	3000, 4000K & 6000K
Beam angle	90°
IP Rating	IP44 (Front face only)
IC Rating	IC - 4

Product range

Code	Description
AT9012/WH/TRI SKU: 11148	12W LED Downlight with Dimmable Driver - 90° beam - White - TRI
AT9012/BLK/TRI SKU: 11060	12W LED Downlight with Dimmable Driver - 90° beam - Black - TRI - 910 - 1035lm
AT9012/SIL/TRI SKU: 11099	12W LED Downlight with Dimmable Driver - 90° beam - Silver - TRI - 910 - 1035lm
AT9012/AND/TRI SKU: 11075	12W LED Downlight with Dimmable Driver - 90° beam - Anodised aluminium - TRI - 910 - 1035lm
AT9012/SC/TRI SKU: 11218	12W LED Downlight with Dimmable Driver - 90° beam - Satin chrome - TRI - 910 - 1035lm



Finish

- White
- Black
- Silver
- Satin chrome
- Anodised aluminium

Accessories

AT9018
140mm extension plate. Available in white, black and satin chrome

AT9019
170mm extension plate. Available in white and satin chrome

For full product list see pages 39 - 41

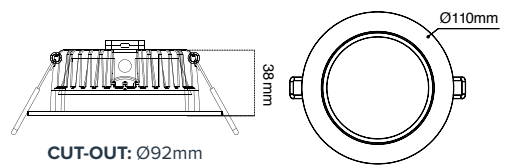



AT9012/COB

12W Fixed COB LED Downlight with Dimmable Driver

Product specification

Voltage	230~50Hz
Power consumption	12W
Dimmable	Yes
Light colour options	Warm white, & Cool white
Colour temperature	3000K & 4000K
Beam angle	90°
IP Rating	IP44
IC Rating	IC - 4

Product range

Code	Description
AT9012/WH/COB/WW SKU: 11146	12W Fixed COB LED Downlight - White - Warm white - 1020lm
AT9012/WH/COB/CW SKU: 11133	12W Fixed COB LED Downlight - White - Cool white - 1070lm

Finish

White

Accessories

AT9018

140mm extension plate. Available in white, black and satin chrome

AT9019

170mm extension plate. Available in white and satin chrome

For full product list see pages 39 - 41

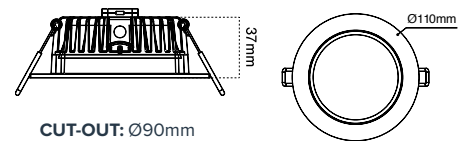



AT9012/FR

12W Fired rated LED Downlight with Dimmable Driver

Product specification

Voltage	230~50Hz
Power consumption	12W
Dimmable	Yes
Light colour options	Warm white & Cool white
Colour emperature	3000K & 4000K
Beam angle	120°
IP Rating	IP65 (Front face only)
IC Rating	IC - 4
Fire Rating	_/120/120*

Product range

Code	Description
AT9012/WH/FR/WW SKU: 11434	12W LED Fire rated Downlight with dimmable driver - Warm white - White - 900lm
AT9012/WH/FR/CW SKU: 11426	12W LED Fire rated Downlight with dimmable driver - Cool white - White - 960lm

* Standard fire rated platerboard / steel. Check application suitability prior to purchase.



Finish

White

Recommended dimmers

AT9302
200W Trailing - edge LED Dimmer mechanism

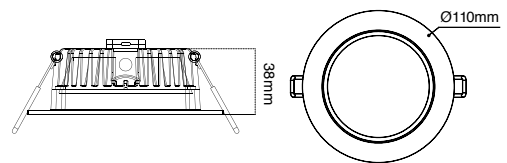



Finish

White

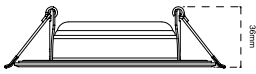

CUT-OUT: Ø80mm - Ø110mm

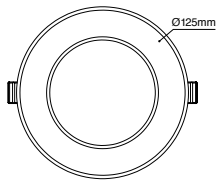

AT9034/LT

12W LED Downlight supplied with Dimmable Driver - Large Trim

Product specification

Voltage	230~50Hz
Power consumption	12W
Dimmable	Yes
Light colour options	Warm white & Cool white
Colour temperature	3000K & 4000K
Beam angle	120°
IP Rating	IP44 (Front face only)
IC Rating	IC - 4

Product range

Code	Description
AT9034/LT/WH/WW SKU: 11373	12W LED Downlight with Dimmable Driver - Large Trim 125mm - White - Warm white - 855lm
AT9034/LT/WH/CW SKU: 11194	12W LED Downlight with Dimmable Driver - Large Trim 125mm - White - Cool white - 845lm



Finish

White Satin chrome



CUT-OUT: Ø90mm

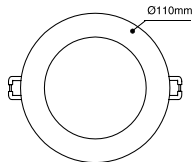

AT9034

12W LED Downlight supplied with Dimmable Driver

Product specification

Voltage	230~50Hz
Power consumption	12W
Dimmable	Yes
Light colour options	Warm white, Cool white & Daylight
Colour temperature	3000K 4000K & 5000K
Beam angle	120°
IP Rating	IP44 (Front face only)
IC Rating	IC - 4

Product range

Code	Description
AT9034/WH/WW SKU: 11817	12W LED Downlight with Dimmable Driver - 110° beam - White - Warm white - 780lm
AT9034/WH/CW SKU: 12000	12W LED Downlight with Dimmable Driver - 110° beam - White - Cool white - 780lm
AT9034/WH/DL SKU: 11235	12W LED Downlight with Dimmable Driver - 110° beam - White - Daylight - 780lm
AT9034/SC/WW SKU: 12358	12W LED Downlight with Dimmable Driver - 110° beam - Satin chrome - Warm white - 780lm
AT9034/SC/CW SKU: 12230	12W LED Downlight with Dimmable Driver - 110° beam - Satin chrome - Cool white - 780lm



ALTIUS

7W LED Downlight Quad colour with interchangeable trims

Product specification

Voltage	230~50Hz
Power consumption	7W
Dimmable	Yes
Light colour options	Warm white, Cool white, Natural & Daylight
Colour temperature	3000, 3500K, 4000K & 5000K
Beam angle	100°
IP Rating	IP44 (Front face only)
IC Rating	IC - 4

Product range

Code	Description
ALTIUS 18700 SKU: 18700	7W LED Downlight with dimmable driver - Interchangeable trims - 100° - F&P - White - 4-CCT - 715 - 800lm

Finish

White

Accessories

ALTIUS 18723
SKU: 18723
Black flush trim for Altius 18700

ALTIUS 18774
SKU: 18774
Black recessed trim for Altius 18700

ALTIUS 18746
SKU: 18746
Satin nickel trim for Altius 18700

ALTIUS 18797
SKU: 18797
Satin nickel flush trim for Altius 18700

For full product list see pages 39 - 41

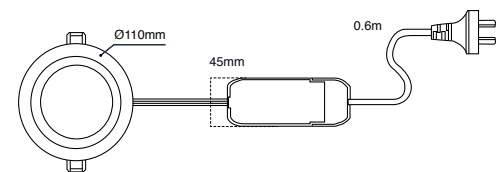

Flush

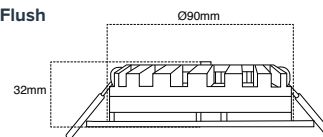

Recessed

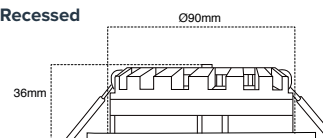



Finish

- White
- Black
- Satin chrome
- Silver

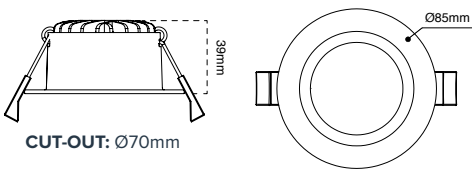

Finish

- White

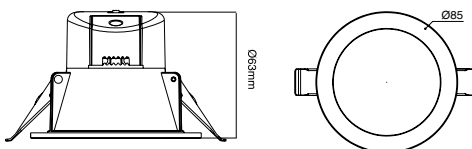

AT9023/TRI

7W LED Downlight supplied with Dimmable Driver- Tri Colour

Product specification

Voltage	230~50Hz
Power consumption	7W
Dimmable	Yes
Light colour options	Tri Colour
Colour temperature	3000 - 5000K
Beam angle	90°
IP Rating	IP54 (Front face only)
IC Rating	IC - 4

Product range

Code	Description
AT9023/WH/TRI SKU: 10991	7W LED Downlight with Dimmable Driver - 90° beam - White - TRI - 910 - 1035lm
AT9023/BLK/TRI SKU: 14903	7W LED Downlight with Dimmable Driver - 90° beam - Black - TRI - 910 - 1035lm
AT9023/SIL/TRI SKU: 12538	7W LED Downlight with Dimmable Driver - 90° beam - Silver - TRI - 910 - 1035lm
AT9023/SC/TRI SKU: 12546	7W LED Downlight with Dimmable Driver - 90° beam - Satin Chrome - TRI - 910 - 1035lm

AT9038/FLUSH/TRI

7W LED Downlight with Dimmable Integral Driver- Tri Colour

Product specification

Voltage	230~50Hz
Power consumption	7W
Dimmable	Yes
Light colour options	Tri Colour
Colour temperature	3000 - 5700K
Beam angle	90°
IP Rating	IP54 (Front face only)
IC Rating	IC - 4

Product range

Code	Description
AT9038/WH/F/TRI SKU: 13262	12W LED Square Downlight with Dimmable Driver - 90° beam - White - TRI - 560 - 650lm

atom



Finish

□ White ■ Satin chrome



CUT-OUT: Ø70mm

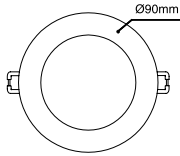

AT9036

9W LED Downlight with Dimmable Driver

Product specification

Voltage	230~50Hz
Power consumption	9W
Dimmable	Yes
Light colour options	Warm white & Cool white
Colour temperature	3000K & 4000K
Beam angle	120°
IP Rating	IP44

Product range

Code	Description
AT9036/WH/WW SKU: 11669	Small 9W LED Downlight with Dimmable Driver - 120° beam - White - Warm white - 530lm
AT9036/WH/CW SKU: 11664	Small 9W LED Downlight with Dimmable Driver - 120° beam - White - Cool white - 600lm
AT9036/SC/CW SKU: 11655	Small 9W LED Downlight with Dimmable Driver - 120° beam - Satin chrome - Daylight - 600lm



IPART VEU

Finish

□ White

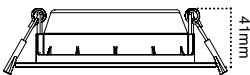

CUT-OUT: Ø125mm

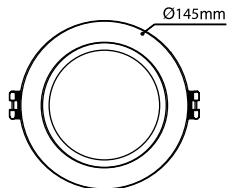

AT9045

12W LED Downlight with Driver

Product specification

Voltage	230~50Hz
Power consumption	12W
Dimmable	Yes
Light colour options	Warm white, Cool white & Daylight
Colour temperature	3000K 4000K & 5000K
Beam angle	90°
IP Rating	IP44 (Front face only)
IC Rating	IC - 4

Product range

Code	Description
AT9045/WH/WW SKU: 10459	12W LED Downlight with Driver - White - Warm white - 1060lm
AT9045/WH/CW SKU: 10341	12W LED Downlight with Driver - White - Cool white - 1115lm
AT9045/WH/DL SKU: 10577	12W LED Downlight with Driver - White - Daylight - 1140lm

atom





CUT-OUT
Ø165mm

I PART **VEU**

Finish

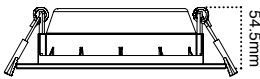
White



CUT-OUT: Ø165mm

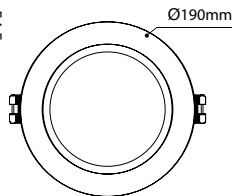

CUT-OUT
Ø200mm

I PART **VEU**

Finish

White



CUT-OUT: Ø200mm

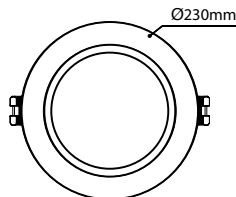

AT9046

19W LED Downlight with Driver

Product specification

Voltage	230~50Hz
Power consumption	19W
Dimmable	Yes
Light colour options	Warm white, Cool white & Daylight
Colour temperature	3000K 4000K & 5000K
Beam angle	90°
IP Rating	IP44 (Front face only)
IC Rating	IC - 4

Product range

Code	Description
AT9046/WH/WW SKU: 10585	19W LED Downlight with Driver - White - Warm white - 1680lm
AT9046/WH/CW SKU: 10820	19W LED Downlight with Driver - White - Cool white - 1720lm
AT9046/WH/DL SKU: 10349	19W LED Downlight with Driver - White - Daylight - 1780lm

AT9047

24W LED Downlight with Driver

Product specification

Voltage	230~50Hz
Power consumption	24W
Dimmable	Yes
Light colour options	Warm white, Cool white & Daylight
Colour temperature	3000K 4000K & 5000K
Beam angle	90°
IP Rating	IP44 (Front face only)
IC Rating	IC - 4

Product range

Code	Description
AT9047/WH/WW SKU: 10473	24W LED Downlight with Driver - White - Warm white - 2260lm
AT9047/WH/CW SKU: 10827	24W LED Downlight with Driver - White - Cool white - 2280lm
AT9047/WH/DL SKU: 10709	24W LED Downlight with Driver - White - Daylight - 2310lm





Finish

White
 Satin chrome

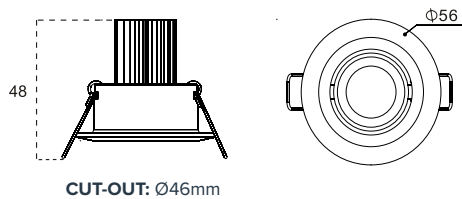

Finish

White
 Satin chrome

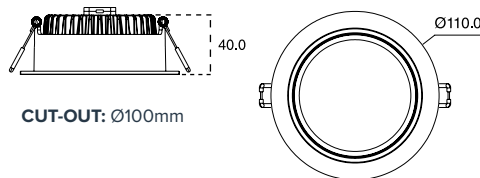

AT9014

3W LED Adjustable Downlight with Driver

Product specification

Voltage	230~50Hz
Power consumption	3W
Dimmable	No
Light colour options	Warm white & Cool white
Colour temperature	3000K & 4000K
Beam angle	45°
IP Rating	IP20
IC Rating	IC

Product range

Code	Description
AT9014/SC/WW SKU: 10640	3W LED Adjustable Downlight 45° beam - Cool White - Satin chrome with Driver - 155lm
AT9014/SC/CW SKU: 10404	3W LED Adjustable Downlight 45° beam - Cool White - Satin chrome with Driver - 185lm
AT9014/WH/WW SKU: 10279	3W LED Adjustable Downlight 45° beam - Cool White - White Finish with Driver - 155lm
AT9014/WH/CW SKU: 10632	3W LED Adjustable Downlight 45° beam - Cool White - White Finish with Driver - 185lm

AT9020

13W LED Adjustable Downlight with Dimmable Driver

Product specification

Voltage	230~50Hz
Power consumption	13W
Dimmable	Yes
Light colour options	Warm white & Cool white
Colour temperature	3000K & 4000K
Beam angle	90°
IP Rating	IP20
IC Rating	IC

Product range

Code	Description
AT9020/SC/WW SKU: 10658	13W LED Adjustable Downlight - Satin chrome - with Dimmable Driver - Cool white - 965lm
AT9020/SC/CW SKU: 10422	13W LED Adjustable Downlight - Satin chrome - with Dimmable Driver - Cool white - 1020lm
AT9020/WH/WW SKU: 10652	13W LED Adjustable Downlight - White - with Dimmable Driver - Cool white - 965lm
AT9020/WH/CW SKU: 10534	13W LED Adjustable Downlight - White - with Dimmable Driver - Cool white - 1020lm



Finish

White

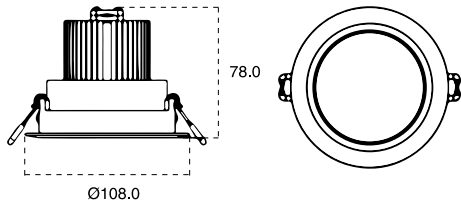

CUT-OUT: Ø90mm



Finish

White Satin chrome

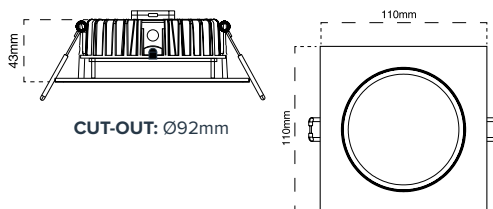

CUT-OUT: Ø92mm

AT9015

15W High Powered LED Fixed Downlight with Dimmable Driver

Product specification

Voltage	230~50Hz
Power consumption	15W
Dimmable	Yes
Light colour options	Warm white & Cool white
Colour temperature	3000K & 4000K
Beam angle	90°
IP Rating	IP20
IC Rating	IC - 4

Product range

Code	Description
AT9015/WH/WW SKU: 10663	15W High Powered LED Fixed Downlight- 3000K - Dimmable Driver - White - 970lm
AT9015/WH/CW SKU: 10781	15W High Powered LED Fixed Downlight- 4000K - Dimmable Driver - White - 1070lm

AT9021/TRI

12W LED Square Downlight with Dimmable Driver- Tri Colour

Product specification

Voltage	230~50Hz
Power consumption	12W
Dimmable	Yes
Light colour options	Tri Colour
Colour temperature	3000, 4000K & 6000K
Beam angle	90°
IP Rating	IP44 (Front face only)
IC Rating	IC - 4

Product range

Code	Description
AT9021/WH/TRI SKU: 10671	12W LED Square Downlight with Dimmable Driver - 90° beam - White - TRI - 1040 - 1120lm
AT9021/SC/TRI SKU: 10655	12W LED Square Downlight with Dimmable Driver - 90° beam - Satin chrome - TRI - 1040 - 1120lm



Finish

White

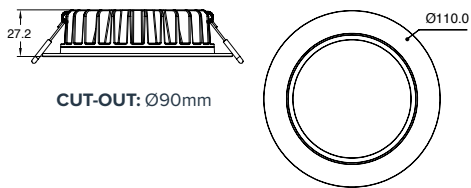

AT9027

9W LED Flush Lens Downlight with Dimmable Driver

Product specification

Voltage	230~50Hz
Power consumption	9W
Dimmable	Yes
Light colour options	Warm white, & Cool white
Colour temperature	3000K & 4000K
Beam angle	90°
IP Rating	IP20
IC Rating	IC - 4

Product range

Code	Description
AT9027/WH/WW SKU: 10528	9W LED Flush Lens Downlight with Dimmable Driver - White - Warm white - 640lm
AT9027/WH/CW SKU: 10646	9W LED Flush Lens Downlight with Dimmable Driver - White - Cool white - 815lm



Finish

White

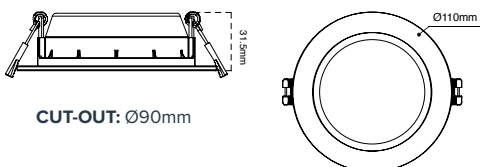

AT9032

10W LED Plastic Trim Downlight with Dimmable Driver

Product specification

Voltage	230~50Hz
Power consumption	10W
Dimmable	Yes
Light colour options	Warm white, Cool white & Daylight
Colour temperature	3000K 4000K & 5000K
Beam angle	90°
IP Rating	IP44 (Front face only)
IC Rating	IC - 4

Product range

Code	Description
AT9032/WH/WW SKU: 11874	10W LED Plastic trim Downlight with Dimmable driver - White - Warm white - 720lm
AT9032/WH/CW SKU: 10216	10W LED Plastic trim Downlight with Dimmable driver - White - Cool white - 890lm
AT9032/WH/DL SKU: 10222	10W LED Plastic trim Downlight with Dimmable driver - White - Daylight - 770lm



AT9044

40W Adjustable LED Round Recessed Scoop with Dimmable Driver

Product specification

Voltage	230~50Hz
Power consumption	40W
Dimmable	Yes
Light colour options	Cool white
Colour temperature	4000K
Beam angle	60°
IP Rating	IP20
IC Rating	IC

Product range

Code	Description
AT9044/WH/60/CW SKU: 10500	40W Adjustable LED Round Recessed Scoop with Dimmable Driver - White - Cool white - 3600lm

Finish

White

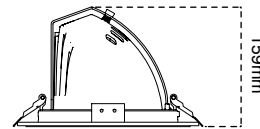

CUT-OUT: Ø170mm

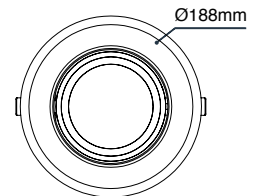



Finish

White

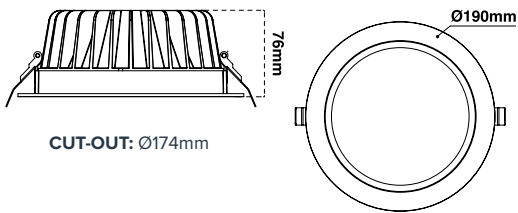

AT9060

20W LED Recessed Downlight with Driver

Product specification

Voltage	230~50Hz
Power consumption	20W
Dimmable	Yes
Light colour options	Warm white, Cool white & Daylight
Colour temperature	3000K 4000K & 5000K
Beam angle	90°
IP Rating	IP54 (Front face only)
IC Rating	IC - 4

Product range

Code	Description
AT9060/WH/WW SKU: 15148	20W LED Recessed Downlight with Driver - White - Warm white - 1835lm
AT9060/WH/CW SKU: 15060	20W LED Recessed Downlight with Driver - White - Cool white - 1915lm
AT9060/WH/DL SKU: 15769	20W LED Recessed Downlight with Driver - White - Daylight - 1920lm



Finish

White

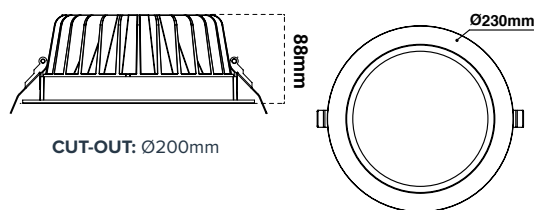

AT9061

30W LED Downlight with Driver

Product specification

Voltage	230~50Hz
Power consumption	30W
Dimmable	Yes
Light colour options	Warm white, Cool white & Daylight
Colour temperature	3000K 4000K & 5000K
Beam angle	90°
IP Rating	IP54 (Front face only)
IC Rating	IC - 4

Product range

Code	Description
AT9061/WH/WW SKU: 16407	30W LED Recessed Downlight with Driver - White - Warm white - 2860lm
AT9061/WH/CW SKU: 16197	30W LED Recessed Downlight with Driver - White - Cool white - 2715lm
AT9061/WH/DL SKU: 16542	30W LED Recessed Downlight with Driver - White - Daylight - 2760lm



AT1204/15 & AT1204/25

15W LED 60° Lamp comes with Dimmable Driver

Product specification

Voltage	230~50Hz
Power consumption	15W & 25W
Dimmable	Yes
Light colour options	Warm white & Cool white
Colour temperature	3000K & 4000K
Beam angle	60°
IP Rating	IP20

Product range

Code	Description
AT1204/15/60/WW SKU: 10939	15W LED 60° Lamp comes with Dimmable Driver - 3000K - 1090lm
AT1204/15/60/CW SKU: 10935	15W LED 60° Lamp comes with Dimmable Driver - 3000K - 1115lm
AT1204/25/60/WW SKU: 10968	25W LED 60° Lamp comes with Dimmable Driver - 4000K - 1816lm
AT1204/25/60/CW SKU: 10944	25W LED 60° Lamp comes with Dimmable Driver - 4000K - 1860lm

Finish

■ Black

Accessories

AT1214
SKU: 10926
125mm White Recessed Downlight reflector to suit AT1204

AT1234
SKU: 10942
138mm White Recessed Wall Washer reflector to suit AT1204

For full product list see pages 39 - 41

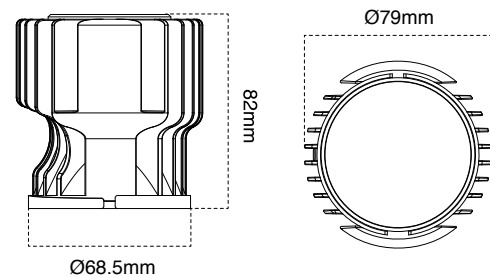



atom



Finish

White
 Satin chrome

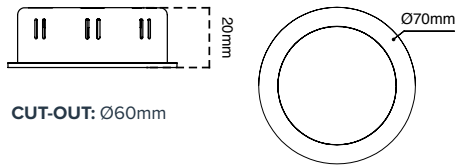

Compatible drivers

AT9601 SKU: 10147 6W 12Vdc Constant voltage LED Driver (1 fitting max.)
AT9602 SKU: 10174 10W 12Vdc Constant voltage LED Driver (2 fittings max.)
AT9603 SKU: 10259 20W 12Vdc Constant voltage LED Driver (4 fittings max.)



Finish

White

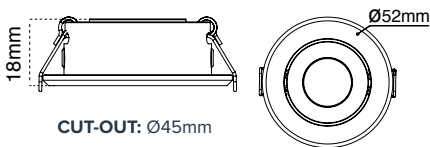

Compatible LED drivers

AT9621 SKU: 10201 6W 700mA Constant current dimmable driver (1 - 2 fittings)
AT9628 SKU: 10784 18W 700mA Constant current dimmable driver (4 - 6 fittings)

AT9011

3W LED 12Vdc Cabinet Light

Product specification

Voltage	12Vdc
Power consumption	3W
Dimmable	No
Light colour options	Warm white & Cool white
Colour temperature	3000 & 4000K
Beam angle	90°
IP Rating	IP20
IC Rating	IC - 4

Product range

Code	Description
AT9011DC/SC/CW SKU: 10866	3W LED 12V d.c. Shelf Light Cool White - Satin chrome - 305lm
AT9011DC/SC/WW SKU: 10867	3W LED 12V d.c. Shelf Light Cool White - Satin chrome - 200lm
AT9011DC/WH/CW SKU: 10870	3W LED 12V d.c. Shelf Light Cool White - White - 305lm
AT9011DC/WH/WW SKU: 10871	3W LED 12V d.c. Shelf Light Cool White - White - 200lm

AT9025

3W LED Shelf Light

Product specification

Voltage	3Vdc
Power consumption	3W
Dimmable	No
Light colour options	Warm white & Cool white
Colour temperature	3000 & 4000K
Beam angle	45°
IP Rating	IP20

Product range

Code	Description
AT9025/WH/CW SKU: 10226	3W LED shelf light - White Trim - Cool White - 185lm
AT9025/WH/WW SKU: 10229	3W LED shelf light - White Trim - Warm White - 155lm

atom



Finish

White

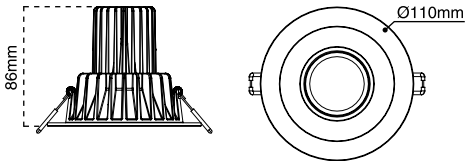

CUT-OUT: Ø90mm



Finish

White

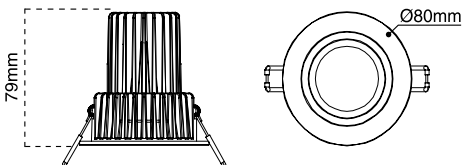

CUT-OUT: Ø70mm

AT9029/ADJ

12W LED COB Adjustable Downlight with Dimmable Driver

Product specification

Voltage	230~50Hz
Power consumption	12W
Dimmable	Yes
Light colour options	Cool white
Colour temperature	4000K
Beam angle	60°
IP Rating	IP44 (Front face only)
IC Rating	IC - 4

Product range

Code	Description
AT9029/ADJ/WH/WW SKU: 18851	12W LED COB Adjustable Downlight with Dimmable Driver - White - Warm white - 800lm
AT9029/ADJ/WH/CW SKU: 10247	12W LED COB Adjustable Downlight with Dimmable Driver - White - Cool white - 915lm

AT9029/SML

12W LED COB Downlight with Dimmable Driver

Product specification

Voltage	230~50Hz
Power consumption	12W
Dimmable	Yes
Light colour options	Cool white
Colour temperature	4000K
Beam angle	60°
IP Rating	IP44 (Front face only)
IC Rating	IC - 4

Product range

Code	Description
AT9029/SML/WH/CW SKU: 11607	12W LED COB Downlight with Dimmable Driver - White - Flush Lens - Cool white - 885lm



Finish

White

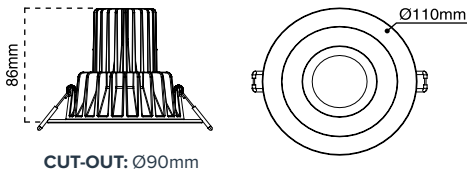

Finish

White

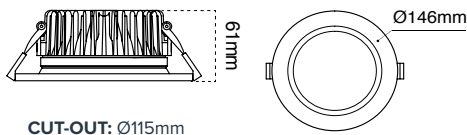

AT9029

12W LED COB Downlight with Dimmable Driver

Product specification

Voltage	230~50Hz
Power consumption	12W
Dimmable	Yes
Light colour options	Warm white & Cool white
Colour temperature	3000K & 4000K
Beam angle	60°
IP Rating	IP44 (Front face only)
IC Rating	IC - 4

Product range

Code	Description
AT9029/WH/WW SKU: 10652	12W LED COB Downlight with Dimmable Driver - White - Warm white - 755lm
AT9029/WH/CW SKU: 10534	12W LED COB Downlight with Dimmable Driver - White - Cool white - 885lm

AT9087/15

15W LED COB Downlight with Dimmable Driver- Tri Colour

Product specification

Voltage	230~50Hz
Power consumption	15W
Dimmable	Yes
Light colour options	Tri Colour
Colour temperature	3000 - 5000K
Beam angle	60°
IP Rating	IP40 (Front face only)
IC Rating	IC - 4

Product range

Code	Description
AT9087/15/WH/TRI SKU: 11180	15W 60° COB Tri - colour Downlight with Dimmable Driver - Tempered Glass and Sil Refl - Tri Colour - 1515 - 1700lm



Finish

- White

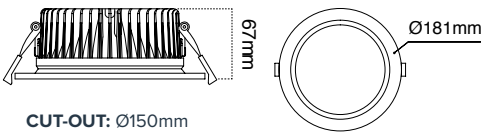

AT9087/20

20W LED COB Downlight with Dimmable Driver- Tri Colour

Product specification

Voltage	230~50Hz
Power consumption	20W
Dimmable	Yes
Light colour options	Tri Colour
Colour temperature	3000 - 5000K
Beam angle	60°
IP Rating	IP40 (Front face only)
IC Rating	IC - 4

Product range

Code	Description
AT9087/20/WH/TRI SKU: 11221	20W 60° COB Tri - colour Downlight with Dimmable Driver - Tempered Glass and Sil Refl - Tri Colour - 1890 - 2130lm



Finish

- White

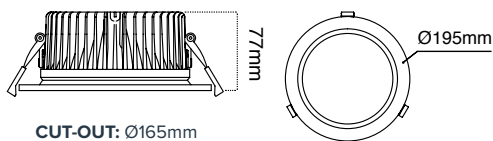

AT9087/30

30W LED COB Downlight with Dimmable Driver- Tri Colour

Product specification

Voltage	230~50Hz
Power consumption	30W
Dimmable	Yes
Light colour options	Tri Colour
Colour temperature	3000 - 5000K
Beam angle	60°
IP Rating	IP40 (Front face only)
IC Rating	IC - 4

Product range

Code	Description
AT9087/30/WH/TRI SKU: 11313	30W 60° COB Tri - colour Downlight with Dimmable Driver - Tempered Glass and Sil Refl - Tri Colour - 2720 - 3425lm



AT9043

35W SMD Rectangular Shop Light with Driver

Product specification

Voltage	230~50Hz
Power consumption	35W
Dimmable	Yes
Light colour options	Cool white & Daylight
Colour temperature	4000K & 5000K
Beam angle	120°
IP Rating	IP20
IC Rating	IC

Product range

Code	Description
AT9043/WH/CW SKU: 10715	35W SMD Shop light - White - Cool white - 3380lm
AT9043/WH/DL SKU: 10833	35W SMD Shop light - White - Daylight - 3440lm

Finish

White

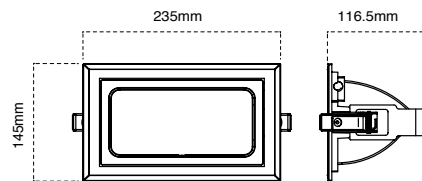

CUT-OUT: 220mm x 130mm

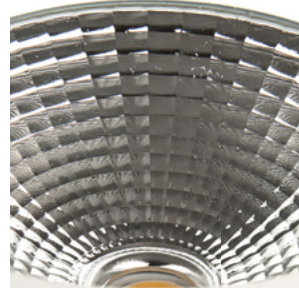

AT9064

10W LED Dimmable Surface Mount Downlight

Product specification

Voltage	230~50Hz
Power consumption	10W
Dimmable	Yes
Light colour options	Warm white & Cool white
Colour temperature	3000 & 4000K
Beam angle	60°
IP Rating	IP54 (Front face only)

Product range

Code	Description
AT9064/WH/60/WW SKU: 10673	10W LED Dimmable Surface Mount Downlight - White - Warm white - 760lm
AT9064/WH/60/CW SKU: 10791	10W LED Dimmable Surface Mount Downlight - White - Cool white - 790lm
AT9064/BLK/60/WW SKU: 10320	10W LED Dimmable Surface Mount Downlight - Black - Warm white - 760lm
AT9064/BLK/60/CW SKU: 10319	10W LED Dimmable Surface Mount Downlight - Black - Cool white - 790lm

Finish

White
 Black

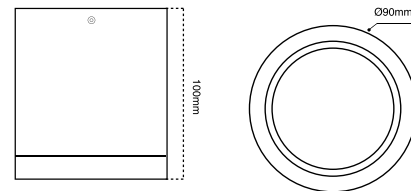



Finish

- White
- Black

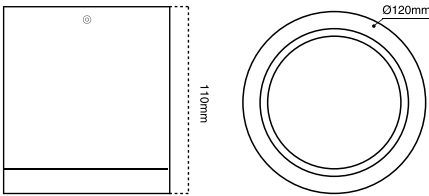

Finish

- Black

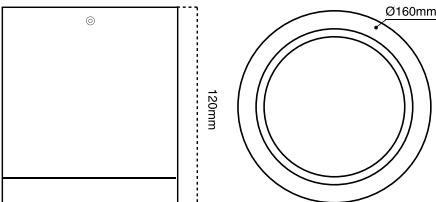

AT9065

25W LED Dimmable Surface Mount Downlight

Product specification

Voltage	230~50Hz
Power consumption	25W
Dimmable	Yes
Light colour options	Warm white & Cool white
Colour temperature	3000 & 4000K
Beam angle	60°
IP Rating	IP54 (Front face only)

Product range

Code	Description
AT9065/WH/60/WW SKU: 10593	25W LED Dimmable Surface Mount Downlight - White - 2580lm
AT9065/WH/60/CW SKU: 10475	25W LED Dimmable Surface Mount Downlight - White - 2670lm
AT9065/BLK/60/WW SKU: 10711	25W LED Dimmable Surface Mount Downlight - Black - 2580lm
AT9065/BLK/60/CW SKU: 10710	25W LED Dimmable Surface Mount Downlight - Black - 2670lm

AT9066

32W LED Dimmable Surface Mount Downlight

Product specification

Voltage	230~50Hz
Power consumption	32W
Dimmable	Yes
Light colour options	Warm white & Cool white
Colour temperature	3000 & 4000K
Beam angle	60°
IP Rating	IP54 (Front face only)

Product range

Code	Description
AT9066/BLK/60/WW SKU: 10614	32W LED Dimmable Surface Mount Downlight - Black - Warm white - 3275lm
AT9066/BLK/60/CW SKU: 10613	32W LED Dimmable Surface Mount Downlight - Black - Cool white - 3630lm





AT1107

10W LED Dimmable Track Mounted Spotlight

Product specification

Voltage	230~50Hz
Power consumption	10W
Dimmable	Yes
Light colour options	Warm white & Cool white
Colour temperature	3000 & 4000K
Beam angle	60°
IP Rating	IP20

Product range

Code	Description
AT1107/WH/WW SKU: 11704	White Track Mounted adjustable spotlight - Warm white - 900lm
AT1107/WH/CW SKU: 17073	White Track Mounted adjustable spotlight - Cool white - 950lm
AT1107/BLK/WW SKU: 11214	Black Track Mounted adjustable spotlight - Warm white - 810lm
AT1107/BLK/CW SKU: 11227	Black Track Mounted adjustable spotlight - Cool white - 855lm
AT1107/WH/WW/KIT SKU: 18749	White KIT (1m track + 2 spotlights) - Warm white - 900lm
AT1107/WH/CW/KIT SKU: 12830	White KIT (1m track + 2 spotlights) - Cool white - 950lm

Finish

White
 Black

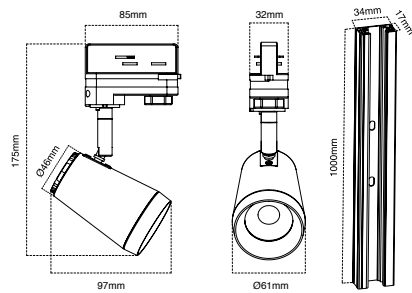

Accessories

AT1100/1M 3 wire - Track 1m aluminium alloy	AT1100/2M 3 wire - Track 2m aluminium alloy
AT1100/CF 3 wire - Centre feed joiner	AT1100/T 3 wire - T shape joiner
AT1100/STR 3 wire - Straight joiner	AT1100/RA 3 wire - Right angle joiner
AT1100/RAR 3 wire - Right angle right joiner	AT1100/X 3 wire - X shape joiner
AT1100/BEND 3 wire - Bendable joiner	AT1100/DEAD 3 wire - Dead end joiner
AT1100/LIVE 3 wire - Live end joiner	

All accessories are available in white and black. For full product list see pages 39 - 41



AT1108

12W LED Track Mounted Spotlight

Product specification

Voltage	230~50Hz
Power consumption	12W, 20W & 30W
Dimmable	No
Light colour options	Warm white & Cool white
Colour temperature	3000 & 4000K
Beam angle	55°
IP Rating	IP20

Product range

Code	Description
AT1108/12/WH/WW SKU: 11940	12W LED Track Mounted spotlight - 55° beam - White - Warm white - 670lm
AT1108/12/WH/CW SKU: 11934	12W LED Track Mounted spotlight - 55° beam - White - Cool white - 630lm
AT1108/12/BLK/WW SKU: 11917	12W LED Track Mounted spotlight - 55° beam - Black - Cool white - 670lm
AT1108/12/BLK/CW SKU: 11896	12W LED Track Mounted spotlight - 55° beam - Black - Cool white - 630lm
AT1108/20/WH/WW SKU: 12050	20W LED Track Mounted spotlight - 55° beam - White - Warm white - 1210lm
AT1108/20/WH/CW SKU: 12006	20W LED Track Mounted spotlight - 55° beam - White - Cool white - 1180lm
AT1108/20/BLK/WW SKU: 11909	20W LED Track Mounted spotlight - 55° beam - Black - Warm white - 1210lm
AT1108/20/BLK/CW SKU: 11844	20W LED Track Mounted spotlight - 55° beam - Black - Cool white - 1180lm
AT1108/30/WH/WW SKU: 12231	30W LED Track Mounted spotlight - 55° beam - White - Warm white - 1780lm
AT1108/30/WH/CW SKU: 12170	30W LED Track Mounted spotlight - 55° beam - White - Cool white - 1820lm
AT1108/30/BLK/WW SKU: 12061	30W LED Track Mounted spotlight - 55° beam - Black - Warm white - 1780lm
AT1108/30/BLK/CW SKU: 11914	30W LED Track Mounted spotlight - 55° beam - Black - Cool white - 1820lm

Finish

□ White ■ Black

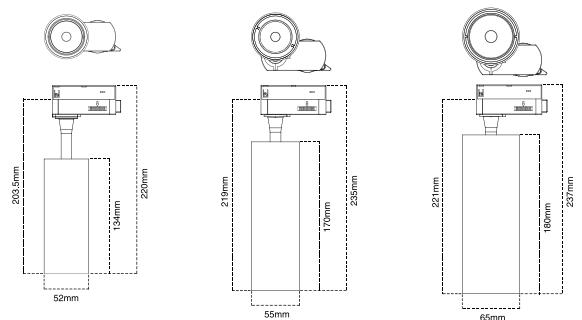

Accessories

AT1100/1M 3 wire - Track 1m aluminium alloy	AT1100/2M 3 wire - Track 2m aluminium alloy
AT1100/CF 3 wire - Centre feed joiner	AT1100/T 3 wire - T shape joiner
AT1100/STR 3 wire - Straight joiner	AT1100/RA 3 wire - Right angle joiner
AT1100/RAR 3 wire - Right angle right joiner	AT1100/X 3 wire - X shape joiner
AT1100/BEND 3 wire - Bendable joiner	AT1100/DEAD 3 wire - Dead end joiner
AT1100/LIVE 3 wire - Live end joiner	

All accessories are available in white and black. For full product list see pages 39 - 41

TRACKS



AT1100/BLK/1M
SKU 11345
3 Wire Track 1m Aluminium Alloy - Black.
Suitable for *AT1107*



AT1100/BLK/2M
SKU 11359
3 Wire Track 2m Aluminium Alloy - Black.
Suitable for *AT1107*



AT1100/BLK/BEND
SKU 16833
3 Wire - Bendable Joiner - Black.
Suitable for *AT1107*



AT1100/BLK/CF
SKU 11376
3 Wire - Straight Joiner Feeder - Black.
Suitable for *AT1107*



AT1100/BLK/DEAD
SKU 11195
3 Wire - Dead End - Black.
Suitable for *AT1107*



AT1100/BLK/LIVE
SKU 11175
3 Wire - Live End - Black.
Suitable for *AT1107*



AT1100/BLK/RA
SKU 11415
3 Wire - Right Angle Joiner Left - Black.
Suitable for *AT1107*



AT1100/BLK/RAR
SKU 11302
3 Wire - Right Angle Joiner Right - Black.
Suitable for *AT1107*



AT1100/BLK/STR
SKU 11393
3 Wire - Straight Joiner - Black.
Suitable for *AT1107*



AT1100/BLK/T
SKU 11430
3 Wire - T Joiner - Black.
Suitable for *AT1107*



AT1100/BLK/X
SKU 11450
3 Wire - X Joiner - Black.
Suitable for *AT1107*

JOINERS

TRACKS



AT1100/WH/1M
SKU 18136
3 Wire Track 1m Aluminium Alloy - White.
Suitable for **AT1107**



AT1100/WH/2M
SKU 11643
3 Wire Track 2m Aluminium Alloy - White.
Suitable for **AT1107**



AT1100/WH/BEND
SKU 14739
3 Wire - Bendable Joiner - White.
Suitable for **AT1107**



AT1100/WH/CF
SKU 17149
3 Wire - Straight Joiner Feeder - White.
Suitable for **AT1107**



AT1100/WH/DEAD
SKU 18095
3 Wire - Dead End - White.
Suitable for **AT1107**



AT1100/WH/LIVE
SKU 16693
3 Wire - Live End - White.
Suitable for **AT1107**



AT1100/WH/RA
SKU 11415
3 Wire - Right Angle Joiner Left - White.
Suitable for **AT1107**



AT1100/WH/RAR
SKU 11284
3 Wire - Right Angle Joiner Right - White.
Suitable for **AT1107**



AT1100/WH/STR
SKU 13416
3 Wire - Straight Joiner - White.
Suitable for **AT1107**

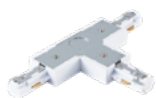

AT1100/WH/T
SKU 15094
3 Wire - T Joiner - White.
Suitable for **AT1107**



AT1100/WH/X
SKU 12348
3 Wire - X Joiner - White.
Suitable for **AT1107**

JOINERS

EXTENSION PLATES



AT9018/BLK
SKU 10117
140mm Extension Plate - Black.
Suitable for AT9012

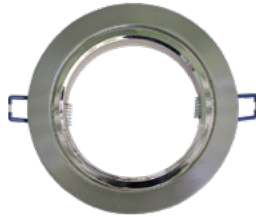

AT9018/SC
SKU 10146
140mm Extension Plate - Satin chrome.
Suitable for AT9012

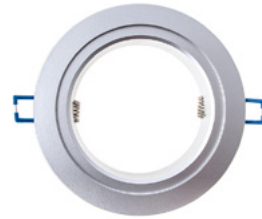

AT9018/SIL
SKU 10119
140mm Extension Plate - Silver.
Suitable for AT9012

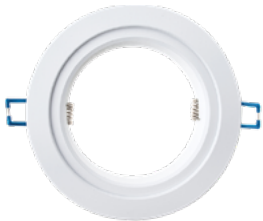

AT9018/WH
SKU 10121
140mm Extension Plate - White.
Suitable for AT9012



AT9019/BLK
SKU 10128
170mm Extension Plate - Black.
Suitable for AT9012

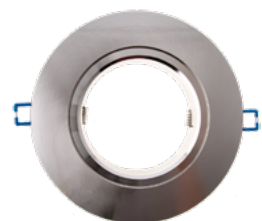

AT9019/SC
SKU 10150
170mm Extension Plate - Satin chrome.
Suitable for AT9012

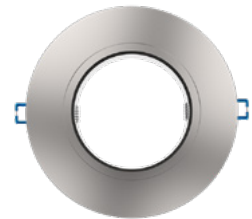

AT9019/SIL
SKU 10126
170mm Extension Plate - Silver.
Suitable for AT9012

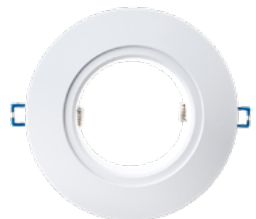

AT9019/WH
SKU 10130
170mm Extension Plate - White.
Suitable for AT9012

TRIMS



AT9038/BC/F/RING
SKU 13345
Brushed Chrome Trim Flush.
Suitable for AT9038



AT9039/BC/F/RING
SKU 11096
Brushed Chrome Trim Flush.
Suitable for AT9039



AT9039/BC/RING
SKU 12405
Brushed Chrome Trim.
Suitable for AT9039



LED Oysters

LED Oysters are not only a great energy - saving light, they also have a large area of light distribution which means less lights needed. With a range of sizes, brightness and application abilities.

Overview

LED OYSTERS

WIZ CONNECTED PRO	45 - 46
TRI COLOUR LED OYSTERS	47 - 52
DIMMABLE LED OYSTERS	53 - 54
ACCESSORIES	55

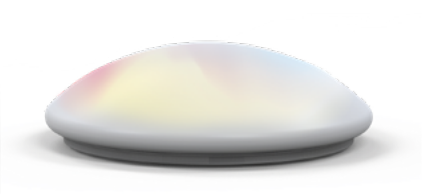



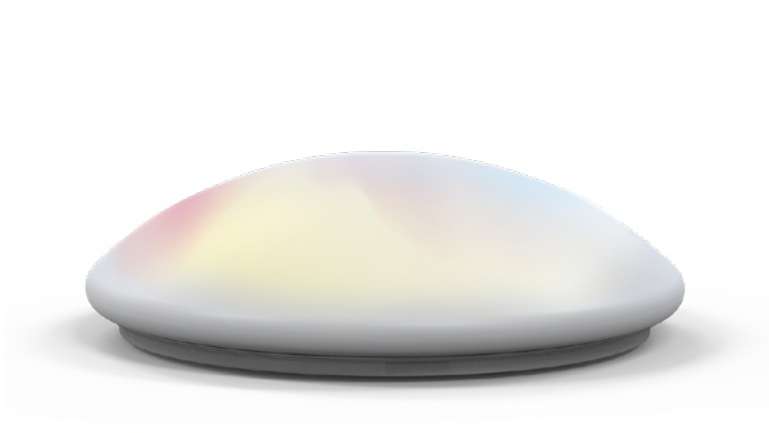

AT3013/WiZ

16W 350mm Opal acrylic LED Oyster WiZ Connected Pro

Product specification

Voltage	230~50Hz
Power consumption	16W
Dimmable	Yes*
Light colour options	RGB (64,000 Whites + 16 Million Colours) Tunable White
Colour temperature	3000K - 5700K + RGB
Beam angle	120°
IP Rating	IP54

*Via the App or voice control. For additional information please visit our website

Product range

Code	Description
AT3013/16/WiZ/TR SKU: 15117	16W 350mm Opal acrylic LED Oyster - WiZ Connected Pro - Colours + Adjustable White - 1560 - 1590lm
AT3013/16/WiZ/TW SKU: 15102	16W 350mm Opal acrylic LED Oyster - WiZ Connected Pro - Adjustable White - 1585 - 1595lm



> 64,000 WHITES > 16 MILLION COLOURS

WiZ Pro Enterprise lighting interface

SET THE RULES AND SUPERVISE

Control multiple rooms and floors, pre-program schedules and set scenes

ENERGY USAGE MONITORING

Reports can be generated and exported based on each lamp's usage and energy consumption

PREDICTIVE MAINTENANCE

Each light reports its usage to the cloud. Lifespan can be calculated to proactively identify and replace fading lights

Finish

White

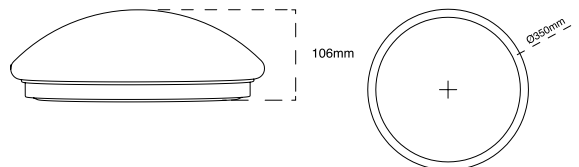

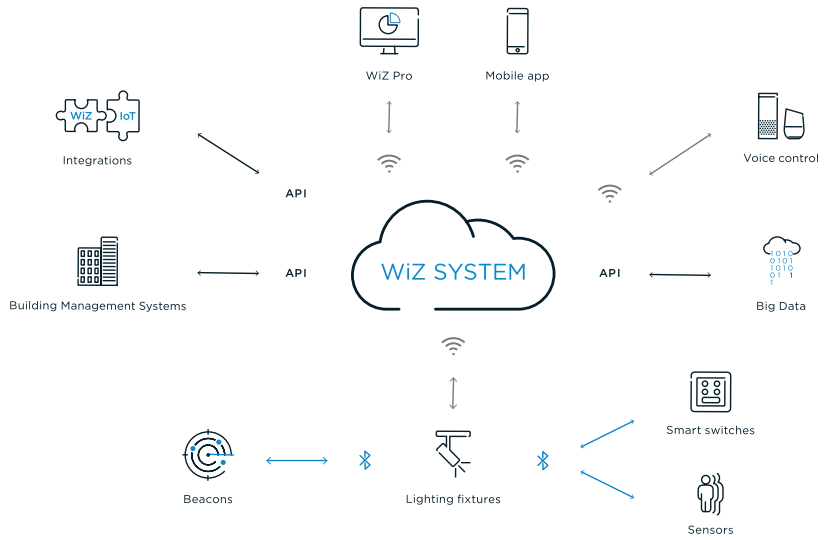

AT3017/WiZ

16W 300mm Opal acrylic LED Oyster WiZ Connected Pro

Product specification

Voltage	230~50Hz
Power consumption	16W
Dimmable	Yes*
Light colour options	RGB (64,000 Whites + 16 Million Colours) Tunable White
Colour temperature	3000K - 5700K + RGB
Beam angle	120°
IP Rating	IP20

*Via the App or voice control. For additional information please visit our website

Product range

Code	Description
AT3017/16/WiZ/TR SKU: 15180	16W 300mm Opal acrylic LED Oyster - WiZ Connected Pro - Colours + Adjustable White - 1435 - 1500lm
AT3017/16/WiZ/TW SKU: 15195	16W 300mm Opal acrylic LED Oyster - WiZ Connected Pro - Adjustable White - 1450 - 1570lm

> 64,000 WHITES > 16 MILLION COLOURS

WiZ Pro Enterprise lighting interface

SET THE RULES AND SUPERVISE

Control multiple rooms and floors, pre-program schedules and set scenes

ENERGY USAGE MONITORING

Reports can be generated and exported based on each lamp's usage and energy consumption

PREDICTIVE MAINTENANCE

Each light reports its usage to the cloud. Lifespan can be calculated to proactively identify and replace fading lights

Finish

White

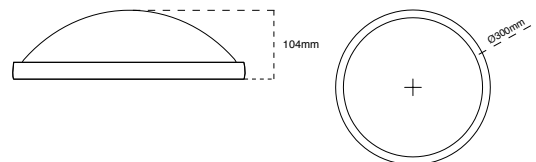



AT3013/13/TRI

13W 260mm Opal Acrylic LED Oyster- Tri Colour

Product specification

Voltage	230~50Hz
Power consumption	13W
Dimmable	No
Light colour options	Tri Colour 
Colour temperature	3000K, 4000K & 5000K
Beam angle	120°
IP Rating	IP20

Product range

Code	Description
AT3013/13/TRI SKU: 12846	13W 260mm Opal Acrylic LED Oyster - Tri Colour - 900 - 1080lm



Finish

White

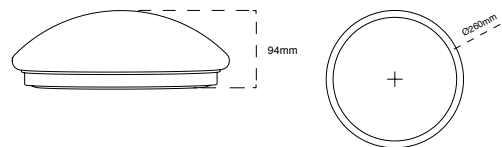



AT3013/16/TRI

16W 330mm Opal Acrylic LED Oyster- Tri Colour

Product specification

Voltage	230~50Hz
Power consumption	16W
Dimmable	No
Light colour options	Tri Colour 
Colour temperature	3000K, 4000K & 5000K
Beam angle	120°
IP Rating	IP20

Product range

Code	Description
AT3013/16/TRI SKU: 11886	16W 330mm Opal Acrylic LED Oyster - Tri Colour - 1100 - 1280lm



Finish

White

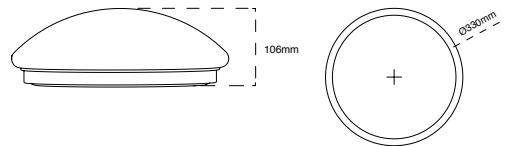



AT3013/16/TRI/CF

16W 330mm LED Opal Acrylic Oyster - Tri Colour with sensor and corridor function

Product specification

Voltage	230~50Hz
Power consumption	16W
Dimmable	Yes*
Light colour options	Tri Colour
Colour temperature	3000K, 4000K & 5000K
Beam angle	120°
IP Rating	IP20
Detection range	4m (at 3m mounting height)

Product range

Code	Description
AT3013/16/TRI/CF SKU: 14053	16W LED Opal Acrylic Oyster 330mm - Tri Colour with sensor and corridor function - 1330 - 1530lm

3 Step Dimming Function

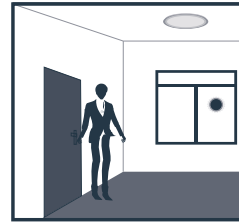

With sufficient ambient light, the sensor does not switch on the lamp



With insufficient ambient light, the sensor switches on the lamp when motion is detected



After hold time, the sensor dims the lamp at a low light level if no new motion trigger

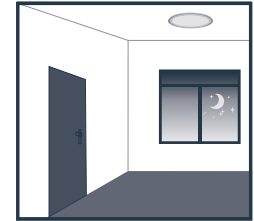

After stand - by period, the sensor switches off the lamp if no motion is detected in its detection zone



Sensor functions

ON - OFF FUNCTION

With insufficient ambient light, the sensor switches on the lamp when motion is detected

3 STEP DIMMING FUNCTION

When there is insufficient light the sensor switches on the lamp when motion is detected. After hold time, the sensor dims the lamp at a low light level if no new motion trigger. After a stand - by period, the sensor switches off the lamps if no motion is detected in its detection zone

SETTING SENSOR

By selecting the combination on the DIP switch, sensor data can be precisely set for each specific application

Finish

White

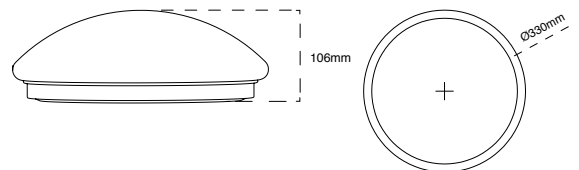



AT3013/26/TRI

26W 380mm Opal Acrylic LED Oyster - Tri Colour

Product specification

Voltage	230~50Hz
Power consumption	26W
Dimmable	No
Light colour options	Tri Colour 
Colour temperature	3000K, 4000K & 5000K
Beam angle	120°
IP Rating	IP20

Product range

Code	Description
AT3013/26/TRI SKU: 11493	26W 380mm Opal Acrylic LED Oyster - Tri Colour - 1140 - 1260lm



Finish

White

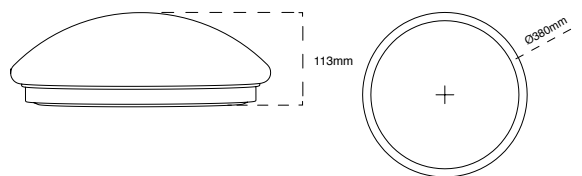



AT3013/26/TRI/CF

26W 380mm LED Opal Acrylic Oyster - Tri Colour with sensor and corridor function

Product specification

Voltage	230~50Hz
Power consumption	26W
Dimmable	No
Light colour options	Tri Colour
Colour temperature	3000K, 4000K & 5000K
Beam angle	120°
IP Rating	IP20
Detection range	4m (at 3m mounting height)

Product range

Code	Description
AT3013/26/TRI/CF SKU: 14127	26W LED Opal Acrylic Oyster 380mm - TRI Colour with sensor and corridor function - 2260 - 2815lm

3 Step Dimming Function

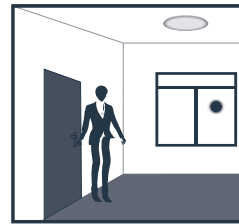

With sufficient ambient light, the sensor does not switch on the lamp

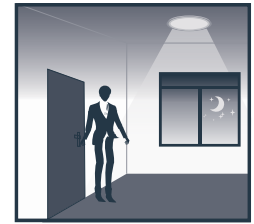

With insufficient ambient light, the sensor switches on the lamp when motion is detected



After hold time, the sensor dims the lamp at a low light level if no new motion trigger

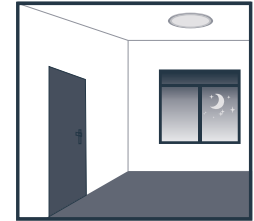

After stand - by period, the sensor switches off the lamp if no motion is detected in its detection zone



Sensor functions

ON - OFF FUNCTION

With insufficient ambient light, the sensor switches on the lamp when motion is detected

3 STEP DIMMING FUNCTION

When there is insufficient light the sensor switches on the lamp when motion is detected. After hold time, the sensor dims the lamp at a low light level if no new motion trigger. After a stand - by period, the sensor switches off the lamps if no motion is detected in its detection zone

SETTING SENSOR

By selecting the combination on the DIP switch, sensor data can be precisely set for each specific application

Finish

White

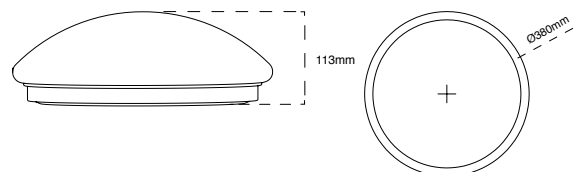



AT3014/12

12W 250mm LED Round Low Profile Dimmable IP54 Polycarbonate Oyster



Finish

White

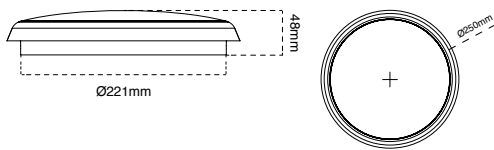

Product specification

Voltage	230~50Hz
Power consumption	12W
Dimmable	Yes
Light colour options	Warm white & Cool white
Colour temperature	3000 & 4000K
Beam angle	120°
IP Rating	IP54

Product range

Code	Description
AT3014/12/LED/WH/WW SKU: 11029	250mm 12W LED Round Low Profile Dimmable IP54 Polycarbonate Oyster - White Trim - 3000K - Warm white - 1190lm
AT3014/12/LED/WH/CW SKU: 10924	250mm 12W LED Round Low Profile Dimmable IP54 Polycarbonate Oyster - White Trim - 4000K - Cool white - 1280lm



Finish

White

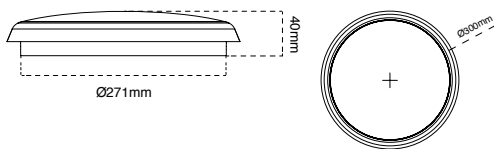

AT3014/18

18W 300mm LED Round Low Profile Dimmable IP54 Polycarbonate Oyster

Product specification

Voltage	230~50Hz
Power consumption	18W
Dimmable	Yes
Light colour options	Warm white & Cool white
Colour temperature	3000 & 4000K
Beam angle	120°
IP Rating	IP54

Product range

Code	Description
AT3014/18/LED/WH/WW SKU: 11042	300mm 18W LED Round Low Profile Dimmable Polycarbonate Oyster - White Trim - 3000K - Warm white - 1745lm
AT3014/18/LED/WH/CW SKU: 10933	300mm 18W LED Round Low Profile Dimmable Polycarbonate Oyster - White Trim - 4000K - Cool white - 1800lm



Finish

White

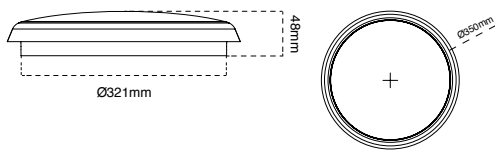

Finish

White

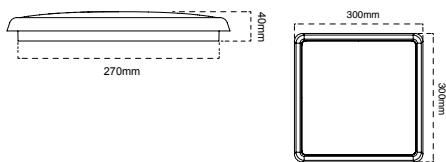

AT3014/25

25W 350mm LED Round Low Profile Dimmable IP54 Polycarbonate Oyster

Product specification

Voltage	230~50Hz
Power consumption	25W
Dimmable	Yes
Light colour options	Warm white & Cool white
Colour temperature	3000 & 4000K
Beam angle	120°
IP Rating	IP54

Product range

Code	Description
AT3014/25/LED/WH/WW SKU: 11032	350mm 25W LED Round Low Profile Dimmable IP54 Polycarbonate Oyster - White Trim - 3000K - Warm white - 2355lm
AT3014/25/LED/WH/CW SKU: 10928	350mm 25W LED Round Low Profile Dimmable IP54 Polycarbonate Oyster - White Trim - 4000K - Cool white - 2545lm

AT3015/18

18W 300mm LED Square Low Profile Dimmable IP54 Polycarbonate Oyster

Product specification

Voltage	230~50Hz
Power consumption	18W
Dimmable	Yes
Light colour options	Cool white
Colour temperature	4000K
Beam angle	120°
IP Rating	IP54

Product range

Code	Description
AT3015/18/LED/WH/CW SKU: 10912	300mm 18W LED Square Low Profile Dimmable IP54 Polycarbonate Oyster - White Trim - 4000K - Cool white - 2000lm

DIFFUSERS



AT3013/13/TRI/DIFF

SKU 10083

13W 260mm Opal Acrylic LED Oyster - Tri Colour Diffuser Only.

Suitable for *AT3013/13*



AT3013/16/TRI/DIFF

SKU 10094

16W 330mm Opal Acrylic LED Oyster - Tri Colour Diffuser Only.

Suitable for *AT3013/16*



AT3013/26/TRI/DIFF

SKU 10488

26W 380mm Opal Acrylic LED Oyster - Tri Colour Diffuser Only.

Suitable for *AT3013/26*



LED Strips

LED Strip lighting can illuminate areas that are normally dark and allow features to be made underneath cabinets and stairs.

Overview

LED STRIPS

LED STRIPS KITS	59
SHALLOW EXTRUSIONS KITS	60
DEEP EXTRUSIONS KITS	60
CORNER EXTRUSIONS KITS	61
ACCESSORIES	61







AT9208/KIT

5m LED Strip Kit (150PC)

Product specification

Voltage	230~50Hz
Power consumption	5W (per metre)
Dimmable	No
Light colour options	Warm white, Daylight & RGB
Colour temperature	2000K, 4000K & RGB
IP Rating	IP65
Length	5m

Product range

Code	Description
AT9208WW/KIT SKU: 10442	5m LED Strip Kit (150 PC) - 3000K - Warm white - 2000lm
AT9208DL/KIT SKU: 10678	5m LED Strip Kit (150PC) - 5000K - Daylight - 2000lm
AT9208RGB/KIT SKU: 10806	5m LED Strip Kit (150 PC) - RGB - comes with controller



Finish

Anodised aluminium

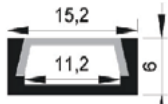

Finish

Anodised aluminium

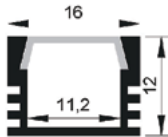

Finish

Anodised aluminium

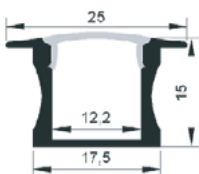

AT9220

Square Shallow Extrusion Kit

Product range

Code	Description
AT9220/1M SKU: 11688	Square Shallow Extrusion KIT - 1M
AT9220/2M SKU: 11735	Square Shallow Extrusion KIT - 2M

AT9221

Square Deep Extrusion Kit

Product range

Code	Description
AT9221/2M SKU: 12057	Square Deep Extrusion KIT - 2M

AT9228

Square Deep Recessed Extrusion Kit

Product range

Code	Description
AT9228/2M SKU: 10520	Square Deep Recessed Extrusion KIT - 2M

atom

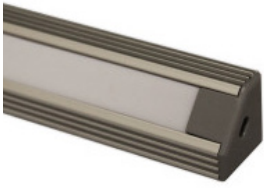

Finish

■ Anodised aluminium

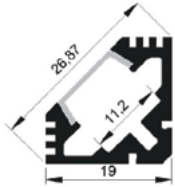

CONNECTOR



AT9213

SKU 10013

Connector - directly to single colour strips
'Non Waterproof' with 500mm leads

AT9227

Triangular Corner Extrusion Kit

Product range

Code	Description
AT9227/2M SKU: 12359	Triangular Corner Extrusion KIT - 2M



LED Step Lights

Install wall lights to keep staircases and corridors illuminated so that everyone in the residence is safe at all times of the day and night.

Overview

LED STEP LIGHTS

SQUARE OPAL RECESSED STEP LIGHT	64
SQUARE CLEAR RECESSED STEP LIGHT	64
RECTANGULAR OPAL RECESSED STEP LIGHT	65
RECTANGULAR CLEAR RECESSED STEP LIGHT	65





AT9500

2W LED Square 70 x 70mm Recessed Step Light with Driver

Product specification

Voltage	230~50Hz
Power consumption	2W
Dimmable	No
Light colour options	Warm white & Cool white
Colour temperature	3000 & 4000K
Beam angle	100°
IP Rating	IP44 (Front face only)
IC Rating	IC - 4

Product range

Code	Description
AT9500/SC/WW/C SKU: 10753	2W LED Square Recessed Step Light with Driver - Satin chrome - Clear Lens - 3000K - Warm white - 95lm
AT9500/SC/WW/O SKU: 10518	2W LED Square Recessed Step Light with Driver - Satin chrome - Opal Lens - 3000K - Warm white - 95lm
AT9500/SC/CW/C SKU: 10635	2W LED Square Recessed Step Light with Driver - Satin chrome - Clear Lens - 4000K - Cool white - 105lm
AT9500/SC/CW/O SKU: 10282	2W LED Square Recessed Step Light with Driver - Satin chrome - Opal Lens - 4000K - Cool white - 105lm
AT9500/WH/WW/C SKU: 10636	2W LED Square Recessed Step Light with Driver - White - Clear Lens - 3000K - Warm white - 95lm
AT9500/WH/WW/O SKU: 10283	2W LED Square Recessed Step Light with Driver - White - Opal Lens - 3000K - Warm white - 95lm
AT9500/WH/CW/C SKU: 10400	2W LED Square Recessed Step Light with Driver - White - Clear Lens - 4000K - Cool white - 105lm
AT9500/WH/CW/O SKU: 10754	2W LED Square Recessed Step Light with Driver - White - Opal Lens - 4000K - Cool white - 105lm

Finish

□ White ■ Satin chrome

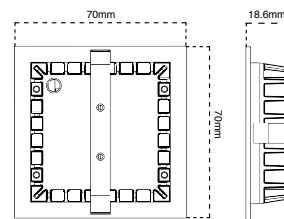

CUT-OUT: 62mm x 62mm



AT9501

3W LED Rectangular 110 x 70mm Recessed Step Light with Driver

Product specification

Voltage	230~50Hz
Power consumption	3W
Dimmable	No
Light colour options	Warm white & Cool white
Colour temperature	3000 & 4000K
Beam angle	100°
IP Rating	IP44 (Front face only)
IC Rating	IC - 4

Product range

Code	Description
AT9501/WH/WW/C SKU: 10524	3W LED Rectangular Recessed Step Light with Driver - White - Clear Lens - 3000K - Warm white - 185lm
AT9501/WH/WW/O SKU: 10642	3W LED Rectangular Recessed Step Light with Driver - White - Opal Lens - 3000K - Warm white - 185lm
AT9501/WH/CW/C SKU: 10288	3W LED Rectangular Recessed Step Light with Driver - White - Clear Lens - 4000K - Cool white - 190lm
AT9501/WH/CW/O SKU: 10406	3W LED Rectangular Recessed Step Light with Driver - White - Opal Lens - 4000K - Cool white - 190lm

Finish

White

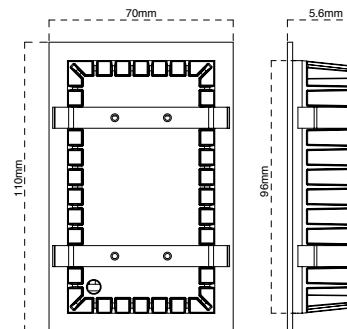

CUT-OUT: 100mm x 60mm



LED Bunkers

Illuminate dark external areas with LED Bunker lights, they look great in pool areas and walkways.

Overview

LED BUNKERS

CORRIDOR FUNCTION LED BUNKERS	68
TRI COLOUR LED BUNKERS	69 - 70
LED BUNKERS OVAL	71
LED BUNKERS ROUND	72
LED BUNKERS RECTANGLE	73





3 Step Dimming Function

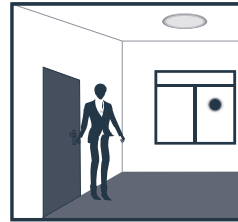

With sufficient ambient light, the sensor does not switch on the lamp



With insufficient ambient light, the sensor switches on the lamp when motion is detected



After hold time, the sensor dims the lamp at a low light level if no new motion trigger

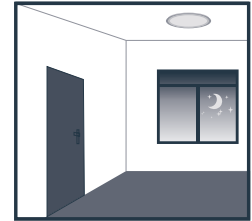

After stand - by period, the sensor switches off the lamp if no motion is detected in its detection zone

AT5812/TRI/CF

27W/17W LED Square Polycarbonate Bulkhead IP65 - with selectable power consumption and corridor function

Product specification

Voltage	230~50Hz
Power consumption	17W & 27W
Dimmable	No
Light colour options	Tri Colour
Colour temperature	3000K, 4000K & 5000K
Beam angle	120°
IP Rating	IP65
IK Rating	IK08
Detection range	7m (at 2m mounting height)

Product range

Code	Description
AT5812/TRI/CF SKU:12209	27W/17W LED Square Polycarbonate Bulkhead IP65 - with sensor and corridor function - 1355 - 1440lm (17W) - 2575 - 2825lm (27W)



Corridor function

SENSOR

Adjust sensor sensitivity according to location, the detection distance of low sensitivity could be only 2m and high sensitivity could be up to 16m for a larger room

TIME

The time that the luminaire stays on at full power once motion is detected. The minimum time is 10sec±3sec, the maximum is 12min±1min. (The luminaire will stay on while the sensor detects movement)

LUX

The amount of ambient light at which the luminaire will switch on the lights if movement is detected. When set to the 'sun' position (max) the luminaire will work in both daytime and night. When set to the '3' position (min) the luminaire will only work when the ambient light is 3LUX (twilight)

Finish

Grey

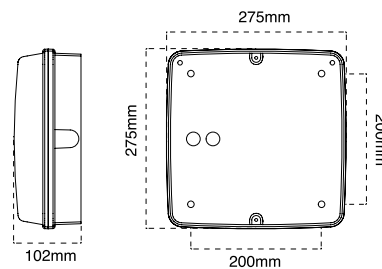



AT5709/TRI/CF

LED Large 14W Polycarbonate Bulkhead with corridor function - Tri Colour

Product specification

Voltage	230~50Hz
Power consumption	14W
Dimmable	No
Light colour options	Tri Colour 
Colour temperature	3000K - 5000K
Lumen output	1270 - 1390lm
Beam angle	120°
IP Rating	IP65
Detection range	4m (at 3m mounting height)

Product range

Code	Description
AT5709/WH/TRI/CF SKU: 16066	LED Large 14W Polycarbonate Bunker with corridor function - White - Tri Colour
AT5709/BLK/TRI/CF SKU: 16038	LED Large 14W Polycarbonate Bunker with corridor function - Black - Tri Colour

Sensor functions

ON - OFF FUNCTION

With insufficient ambient light, the sensor switches on the lamp when motion is detected

3 STEP DIMMING FUNCTION

When there is insufficient light the sensor switches on the lamp when motion is detected. After hold time, the sensor dims the lamp at a low light level if no new motion trigger. After a stand - by period, the sensor switches off the lamps if no motion is detected in its detection zone

SETTING SENSOR

By selecting the combination on the DIP switch, sensor data can be precisely set for each specific application

Finish

 White  Black

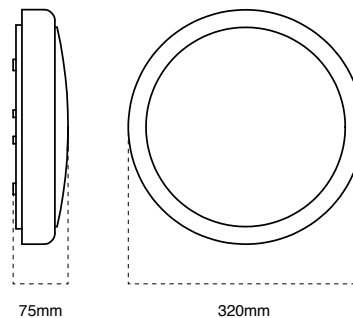



AT5709/TRI

LED Large 14W Polycarbonate Bulkhead - Tri Colour

Product specification

Voltage	230~50Hz
Power consumption	14W
Dimmable	No
Light colour options	Tri - colour
Colour temperature	3000 - 5000K
Lumen output	1280 - 1390lm
Beam angle	120°
IP Rating	IP65

Product range

Code	Description
AT5709/WH/TRI SKU: 16051	LED Large 14W Polycarbonate Bunker - White - Tri Colour
AT5709/BLK/TRI SKU: 16020	LED Large 14W Polycarbonate Bunker - Black - Tri Colour

Finish

White
 Black

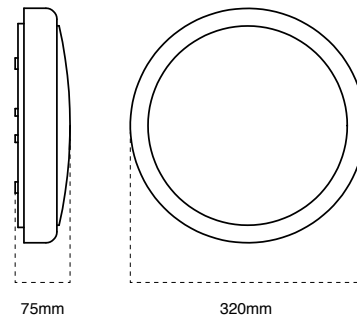



AT3016/OH

Oval 12W LED Polycarbonate Bulkhead - with Eyelid option

Product specification

Voltage	230~50Hz
Power consumption	12W
Light colour options	Cool white
Colour temperature	4000K
Dimmable	No
Beam angle	120°
IP Rating	IP66
IK Rating	IK10

Product range

Code	Description
AT3016/WH/OH/CW SKU: 11188	Oval 12W LED Polycarbonate Bunker - with Eyelid option - White - 860lm (600lm with eyelid)
AT3016/BLK/OH/CW SKU: 11132	Oval 12W LED Polycarbonate Bunker - with Eyelid option - Black - 860lm (520lm with eyelid)



Finish

□ White ■ Black

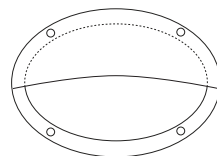
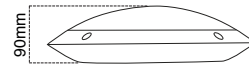
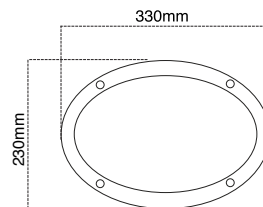

(with eyelid option fitted)



AT3016/RD

Round 12W LED Polycarbonate Bulkhead - with Eyelid option

Product specification

Voltage	230~50Hz
Power consumption	12W
Light colour options	Cool white
Colour temperature	4000K
Dimmable	No
Beam angle	120°
IP Rating	IP66
IK Rating	IK10

Product range

Code	Description
AT3016/WH/RD/CW SKU: 11171	Round 12W LED Polycarbonate Bunker - with Eyelid option - White - 930lm (665lm with eyelid)
AT3016/BLK/RD/CW SKU: 11179	Round 12W LED Polycarbonate Bunker - with Eyelid option - Black - 900lm (930lm with eyelid)



Finish

White
 Black

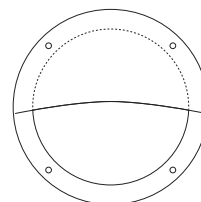
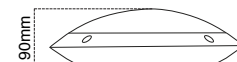
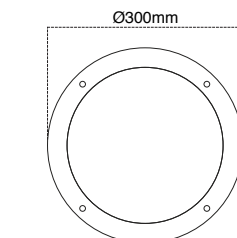

(With eyelid option fitted)



AT5832

12W LED Rectangle Polycarbonate Bulkhead - IP65 with Wall Washer option

Product specification

Voltage	230~50Hz
Power consumption	12W
Light colour options	Cool white
Colour temperature	4000K
Dimmable	No
Beam angle	120°
IP Rating	IP65

Product range

Code	Description
AT5832/WH SKU: 10419	12W LED Rectangle Polycarbonate Bulkhead - IP65 with wall washer option - White - Cool White - 980lm
AT5832/BLK SKU: 10269	12W LED Rectangle Polycarbonate Bulkhead - IP65 with wall washer option - Black - Cool White - 980lm

*Lumens measured with plain cover.

Finish

□ White ■ Black

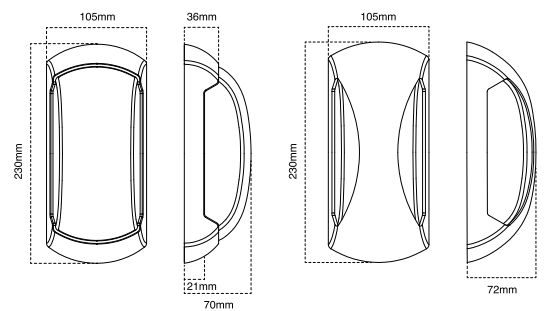

(with wall cover option attached)



LED Lamps

Light up your living space with our extensive Atom LED lamps range. From traditional to smart lighting, we have the right lamp to suit your needs.

Overview

LED LAMPS

WIZ CONNECTED PRO	77 - 79
LED GLS LAMPS	80 - 81
LED CANDLE LAMPS	82 - 83
LED STICK LAMPS	83
LED G95 LAMPS	84
LED G120 LAMPS	85
LED G45 LAMPS	86
LED R63/R80 LAMPS	87
LED GU10 LAMPS	88
LED MR16 LAMPS	89
LED ST64 LAMPS	90 - 91
LED PAR38 LAMPS	92
LED LAMPS WITH DRIVER	92
ACCESSORIES	93







AT9424/WIZ/TR, AT9429/WIZ/TR, AT9426/WIZ/TR & AT9430/WIZ/TR

WiZ Colours + Adjustable White WiFi Lamps

Product specification

Voltage	230~50Hz
Power consumption	6.6W, 7.5W, 11.5W & 15.5W
Light colour options	Tri Colour (3000K, 4000K & 6500K) + RGB
Lamp shape	A60, G100, E14 & GU10
Dimmable	Yes*
Beam angle	240°
Colour rendering index	80
Average rated life	L70 (6k) 25,000 hours
Switching cycles	≥50,000 cycles

*Via the App or voice control. For additional information please visit www.atomlighting.com.au

Product range

Code	Description
AT9424/WIZ/A60/TR SKU: 17718	11.5W A60 WiZ Connected Pro Colours + Adjustable White WiFi Lamp - ES/E27 - 806lm
AT9424/WIZ/A60/TR/2PK SKU: 17736	Twin pack 11.5W A60 WiZ Connected Pro Colours + Adjustable White WiFi Lamp - ES/E27 - 806lm
AT9424/WIZ/G100/TR SKU: 17802	15.5W G100 WiZ Connected Pro - ES/E27 - 1055lm
AT9429/WIZ/A60/TR SKU: 17532	11.5W A60 WiZ Connected Pro - BC/B22 - 806lm
AT9429/WIZ/A60/TR/2PK SKU: 17844	Twin pack 11.5W A60 WiZ Connected Pro Tunable White Lamp - Warm White - BC/B22 - 806lm
AT9426/WIZ/E14/TR SKU: 17934	7.5W E14 WiZ Connected Pro - E14 - 470lm
AT9430/WIZ/GU10/TR SKU: 17948	Twin pack 6.6W GU10 WiZ Connected Pro - GU10 - 360lm

> 64,000 WHITES > 16 MILLION COLOURS

WiZ Pro Enterprise lighting interface

SET THE RULES AND SUPERVISE

Control multiple rooms and floors, pre-program schedules and set scenes

ENERGY USAGE MONITORING

Reports can be generated and exported based on each lamp's usage and energy consumption

PREDICTIVE MAINTENANCE

Each light reports its usage to the cloud. Lifespan can be calculated to proactively identify and replace fading lights

Finish

White

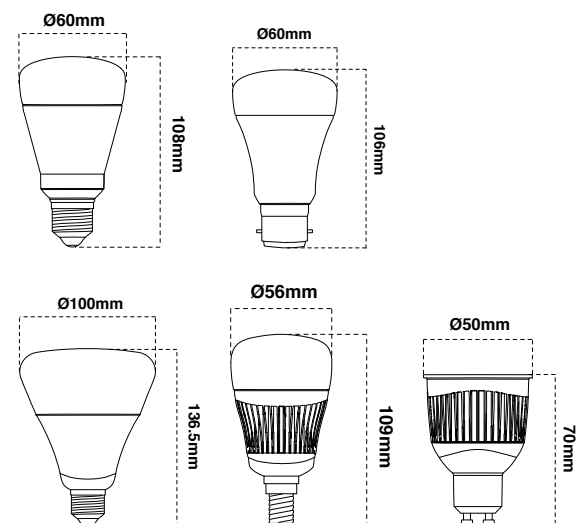

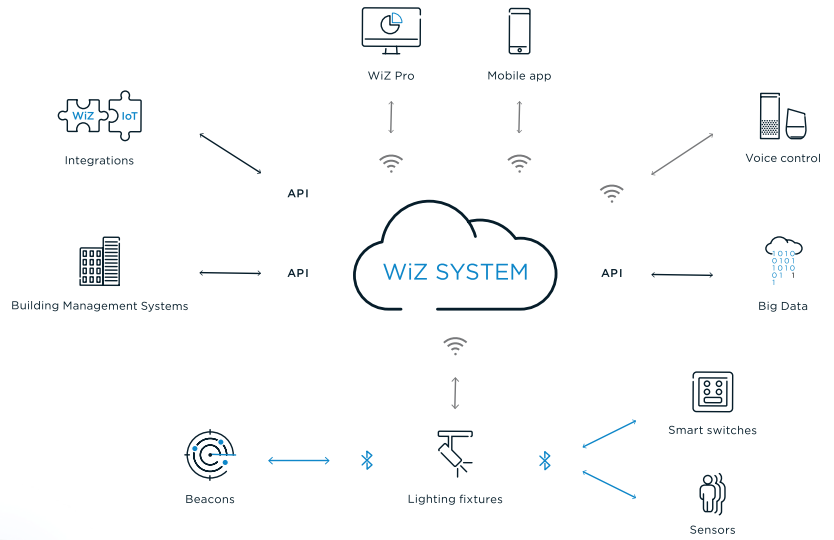

AT9424/WIZ/G100

13W WiZ Tunable White Lamp

Product specification

Voltage	230~50Hz
Power consumption	13W
Light colour options	Warm white & Daylight
Lamp shape	G100
Dimmable	Yes*
Beam angle	240°
Colour rendering index	80
Average rated life	L70 (6k) 25,000 hours
Switching cycles	≥50,000 cycles

*Via the App or voice control. For additional information please visit www.atomlighting.com.au

Product range

Code	Description
AT9424/WIZ/G100/WW SKU: 17671	13W G100 LED Dimmable WiZ Connected Pro Tunable White Lamp - Warm White - ES/E27 - 1055lm
AT9424/WIZ/G100/DL SKU: 17692	13W G100 LED Dimmable - WiZ Connected Pro Tunable White Lamp - Daylight - ES/E27 - 1055lm

> 64,000 WHITES

WiZ Pro Enterprise lighting interface

SET THE RULES AND SUPERVISE

Control multiple rooms and floors, pre-program schedules and set scenes

ENERGY USAGE MONITORING

Reports can be generated and exported based on each lamp's usage and energy consumption

PREDICTIVE MAINTENANCE

Each light reports its usage to the cloud. Lifespan can be calculated to proactively identify and replace fading lights

Finish

White

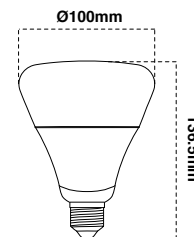



AT9424/WIZ & AT9429/WIZ

10W WiZ Tunable White Lamp

Product specification

Voltage	230~50Hz
Power consumption	10W
Light colour options	Warm white & Daylight
Lumen output	806lm
Lamp shape	A60
Dimmable	Yes*
Beam angle	240°
Colour rendering index	80
Average rated life	L70 (6k) 25,000 hours
Switching cycles	≥50,000 cycles

*Via the App or voice control. For additional information please visit www.atomlighting.com.au

Product range

Code	Description
AT9424/WIZ/A60/WW SKU: 17555	10W A60 LED Dimmable - WiZ Connected Pro Tunable White Lamp - Warm White - ES/E27 - 806lm
AT9424/WIZ/A60/WW/2PK SKU: 17549	(2x) 10W A60 LED Dimmable - WiZ Connected Pro Tunable White Lamp - Warm White - ES/E27 - 806lm
AT9424/WIZ/A60/DL SKU: 17524	10W A60 LED Dimmable - WiZ Connected Pro Tunable White Lamp - Daylight - ES/E27 - 806lm
AT9424/WIZ/A60/DL/2PK SKU: 17511	(2x) 10W A60 LED Dimmable - WiZ Connected Pro Tunable White Lamp - Daylight - ES/E27 - 806lm
AT9429/WIZ/A60/WW SKU: 17865	10W A60 LED Dimmable - WiZ Connected Pro Tunable White Lamp - Warm White - BC/B22 - 806lm
AT9429/WIZ/A60/WW/2PK SKU: 17870	(2x) 10W A60 LED Dimmable - WiZ Connected Pro Tunable White Lamp - Warm White - BC/B22 - 806lm
AT9429/WIZ/A60/DL SKU: 17888	10W A60 LED Dimmable - WiZ Connected Pro Tunable White Lamp - Daylight - BC/B22 - 806lm
AT9429/WIZ/A60/DL/2PK SKU: 17911	(2x) 10W A60 LED Dimmable - WiZ Connected Pro Tunable White Lamp - Daylight - BC/B22 - 806lm

> 64,000 WHITES

WiZ Pro Enterprise lighting interface

SET THE RULES AND SUPERVISE

Control multiple rooms and floors, pre-program schedules and set scenes

ENERGY USAGE MONITORING

Reports can be generated and exported based on each lamp's usage and energy consumption

PREDICTIVE MAINTENANCE

Each light reports its usage to the cloud. Lifespan can be calculated to proactively identify and replace fading lights

Finish

White

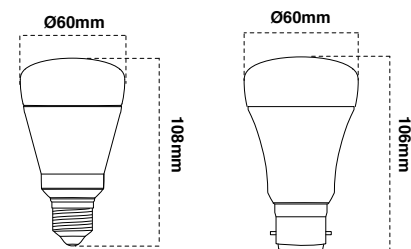

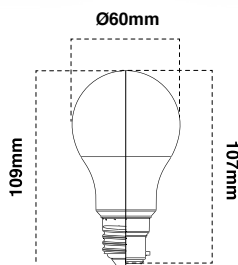
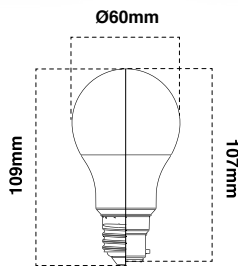

AT9423

9.4W Non - Dimmable GLS LED Lamp - Frosted

Product specification

Voltage	230~50Hz
Power consumption	9.4W
Lamp shape	A60
Dimmable	No
Beam angle	240°
Colour rendering index	80
Average rated life	15,000 hours
Switching cycles	≥50,000 cycles

Product range

Code	Description
AT9423/ES/WW SKU: 16630	9.4W Non - Dimmable GLS Lamp - Warm white 3000K ES/E27 Frosted - 806lm
AT9423/ES/CW SKU: 10737	9.4W Non - Dimmable GLS Lamp - Cool white 4000K ES/E27 Frosted - 840lm
AT9423/ES/DL SKU: 16238	9.4W Non - Dimmable GLS Lamp - Daylight 6500K ES/E27 Frosted - 840l
AT9423/BC/WW SKU: 17335	9.4W Non - Dimmable GLS Lamp - Warm white 3000K BC/B22 Frosted - 806lm
AT9423/BC/CW SKU: 16116	9.4W Non - Dimmable GLS Lamp - Cool white 4000K BC/B22 Frosted - 840lm
AT9423/BC/DL SKU: 16074	9.4W Non - Dimmable GLS Lamp - Daylight 6500K BC/B22 Frosted - 840l

AT9424

9.8W Dimmable GLS LED Lamp - Frosted

Product specification

Voltage	230~50Hz
Power consumption	9.8W
Lamp shape	A60
Dimmable	Yes
Beam angle	240°
Colour rendering index	80
Average rated life	15,000 hours
Switching cycles	≥50,000 cycles

Product range

Code	Description
AT9424/ES/WW SKU: 18895	9.8W Dimmable GLS Lamp - Warm White 3000K ES/E27 Frosted - 806lm
AT9424/ES/CW SKU: 17710	9.8W Dimmable GLS Lamp - Cool White 4000K ES/E27 Frosted - 840lm
AT9424/ES/DL SKU: 15904	9.8W Dimmable GLS Lamp - Daylight 6500K ES/E27 Frosted - 840l
AT9424/BC/WW SKU: 18274	9.8W Dimmable GLS Lamp - Warm White 3000K BC/B22 Frosted - 806lm
AT9424/BC/CW SKU: 16828	9.8W Dimmable GLS Lamp - Cool White 4000K BC/B22 Frosted - 840lm
AT9424/BC/DL SKU: 16595	9.8W Dimmable GLS Lamp - Daylight 6500K BC/B22 Frosted - 840l

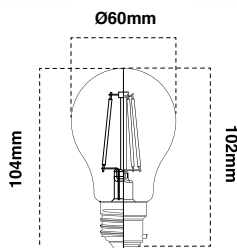
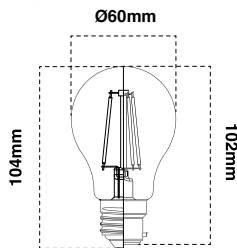

AT9474

8.3W Dimmable GLS Filament Lamp - Clear

Product specification

Voltage	230~50Hz
Power consumption	8.3W
Lamp shape	A60
Dimmable	Yes
Beam angle	360°
Colour rendering index	80
Average rated life	15,000 hours
Switching cycles	≥50,000 cycles

Product range

Code	Description
AT9474/ES/WW/C SKU: 11152	A60 Filament 8.3W Dimmable - Warm white 2700K ES/E27 Clear - 806lm
AT9474/BC/WW/C SKU: 12623	A60 Filament 8.3W Dimmable Warm white 2700K BC/B22 Clear - 806lm

AT9476

5.1W Dimmable GLS Filament Lamp - Clear

Product specification

Voltage	230~50Hz
Power consumption	5.1W
Lamp shape	A60
Dimmable	Yes
Beam angle	360°
Colour rendering index	80
Average rated life	15,000 hours
Switching cycles	≥50,000 cycles

Product range

Code	Description
AT9476/ES/WW/C SKU: 10017	A60 Filament 5.1W Dimmable 2700K ES/E27 Clear - 470lm
AT9476/BC/WW/C SKU: 10006	A60 Filament 5.1W Dimmable 2700K BC/B22 Clear - 470lm



AT9421

6W Dimmable Candle Lamp - Frosted

Product specification

Voltage	230~50Hz
Power consumption	6W
Light colour options	Warm white, Cool white & Daylight
Colour temperature	3000K, 4000K & 6500K
Lamp shape	C35
Dimmable	Yes
Beam angle	300°
Colour rendering index	>80
Average rated life	15,000 hours
Switching cycles	≥50,000 cycles

Product range

Code	Description
AT9421/ES/WW SKU: 18444	6W Dimmable Candle lamp - Warm white 3000K ES/E27 Frosted - 490lm
AT9421/ES/CW SKU: 10751	6W Dimmable Candle lamp - Cool white 4000K ES/E27 Frosted - 500lm
AT9421/ES/DL SKU: 12516	6W Dimmable Candle lamp - Daylight 6500K ES/E27 Frosted - 500lm
AT9421/BC/WW SKU: 10645	6W Dimmable Candle lamp - Warm white 3000K BC/B22 Frosted - 490lm
AT9421/BC/CW SKU: 10747	6W Dimmable Candle lamp - Cool white 4000K BC/B22 Frosted - 500lm
AT9421/BC/DL SKU: 15794	6W Dimmable Candle lamp - Daylight 6500K BC/B22 Frosted - 500lm
AT9421/SES/WW SKU: 16935	6W Dimmable Candle lamp - Warm white 3000K SES/E14 Frosted - 490lm
AT9421/SES/CW SKU: 15719	6W Dimmable Candle lamp - Cool white 4000K SES/E14 Frosted - 500lm
AT9421/SES/DL SKU: 12896	6W Dimmable Candle lamp - Daylight 6500K SES/E14 Frosted - 500lm
AT9421/SBC/WW SKU: 10104	6W Dimmable Candle lamp - Warm white 3000K SBC/B15 Frosted - 490lm
AT9421/SBC/CW SKU: 12560	6W Dimmable Candle lamp - Cool white 4000K SBC/B15 Frosted - 500lm

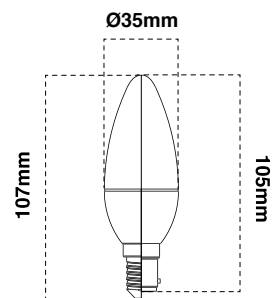
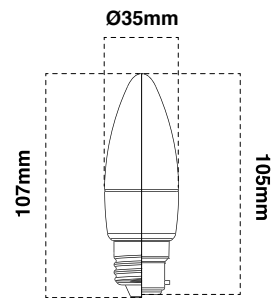

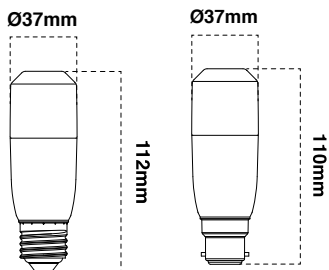
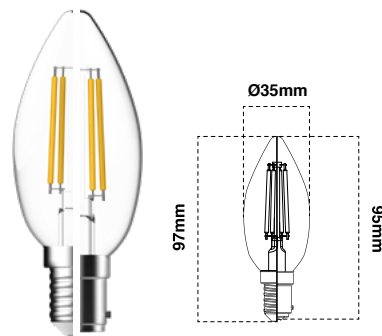
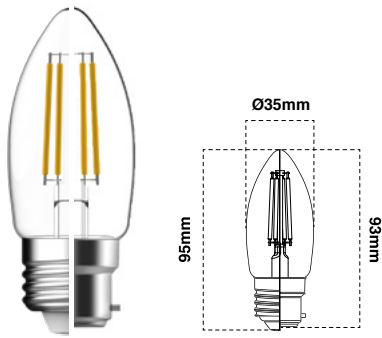

AT9471

4.8W Dimmable Candle Lamp - Clear

Product specification

Voltage	230~50Hz
Power consumption	4.8W
Lamp shape	C35
Dimmable	Yes
Beam angle	360°
Colour rendering index	>80
Average rated life	15,000 hours
Switching cycles	≥50,000 cycles

Product range

Code	Description
AT9471/ES/WW/C SKU: 12777	C35 Filament 4.8W Dimmable 2700K ES/E27 Clear - 470lm
AT9471/BC/WW/C SKU: 12782	C35 Filament 4.8W Dimmable 2700K BC/B22 Clear - 470lm
AT9471/SES/WW/C SKU: 10763	C35 Filament 4.8W Dimmable 2700K SES/E14 Clear - 470lm
AT9471/SBC/WW/C SKU: 12785	C35 Filament 4.8W Dimmable 2700K SBC/B15 Clear - 470lm

AT9431

9W Dimmable Stick Lamp - Frosted

Product specification

Voltage	230~50Hz
Power consumption	9W
Lamp shape	Stick
Dimmable	Yes
Beam angle	240°
Colour rendering index	>80
Average rated life	15,000 hours
Switching cycles	≥50,000 cycles

Product range

Code	Description
AT9431/ES/WW SKU: 13294	Stick Lamp 9W Dimmable 3000K ES/E27 Frosted - 850lm
AT9431/ES/CW SKU: 13256	Stick Lamp 9W Dimmable 4000K ES/E27 Frosted - 900lm
AT9431/ES/DL SKU: 13219	Stick Lamp 9W Dimmable 6500K ES/E27 Frosted - 900lm
AT9431/BC/WW SKU: 13283	Stick Lamp 9W Dimmable 3000K BC/B22 Frosted - 850lm
AT9431/BC/CW SKU: 13216	Stick Lamp 9W Dimmable 4000K BC/B22 Frosted - 900lm
AT9431/BC/DL SKU: 13298	Stick Lamp 9W Dimmable 6500K BC/B22 Frosted - 900lm

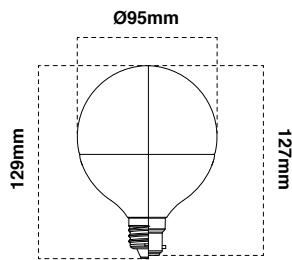

AT9427

13W Non - Dimmable G95 Lamp - Frosted

Product specification

Voltage	230~50Hz
Power consumption	13W
Lamp shape	G95
Dimmable	No
Beam angle	150°
Colour rendering index	80
Average rated life	15,000 hours
Switching cycles	≥50,000 cycles

Product range

Code	Description
AT9427/ES/WW SKU: 13292	G95 13W Non - Dimmable 3000K ES/E27 Frosted - 1055lm
AT9427/ES/CW SKU: 13260	G95 13W Non - Dimmable 4000K ES/E27 Frosted - 1055lm
AT9427/ES/DL SKU: 13282	G95 13W Non - Dimmable 6500K ES/E27 Frosted - 1055lm
AT9427/BC/WW SKU: 13302	G95 13W Non - Dimmable 3000K BC/B22 Frosted - 1055lm
AT9427/BC/CW SKU: 13214	G95 13W Non - Dimmable 4000K BC/B22 Frosted - 1055lm
AT9427/BC/DL SKU: 13234	G95 13W Non - Dimmable 6500K BC/B22 Frosted - 1055lm

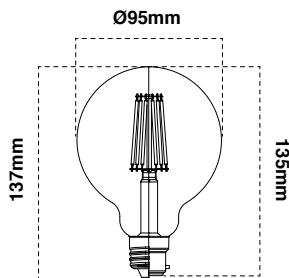

AT9477

7.7W Dimmable G95 Filament Lamp - Clear

Product specification

Voltage	230~50Hz
Power consumption	7.7W
Lamp shape	G95
Dimmable	Yes
Beam angle	360°
Colour rendering index	80
Average rated life	15,000 hours
Switching cycles	≥50,000 cycles

Product range

Code	Description
AT9477/ES/WW/C SKU: 10024	G95 Filament 7.7W Dimmable 2700K ES/E14 Clear - 1055lm
AT9477/BC/WW/C SKU: 10021	G95 Filament 7.7W Dimmable 2700K BC/B22 Clear - 1055lm

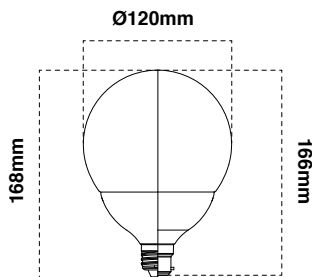

AT9428

13W Non - Dimmable G120 Lamp - Frosted

Product specification

Voltage	230~50Hz
Power consumption	13W
Light colour options	Warm white, Cool white & Daylight
Colour temperature	3000K, 4000K & 6500K
Lamp shape	G120
Dimmable	No
Beam angle	150°
Colour rendering index	80
Average rated life	15,000 hours
Switching cycles	≥50,000 cycles

Product range

Code	Description
AT9428/ES/WW SKU: 10975	G95 13W Non - Dimmable 3000K ES/E27 Frosted - Warm white - 1055lm
AT9428/ES/CW SKU: 10876	G95 13W Non - Dimmable 4000K ES/E27 Frosted - Cool white - 1055lm
AT9428/ES/DL SKU: 10758	G95 13W Non - Dimmable 6500K ES/E27 Frosted - Daylight - 1055lm
AT9428/BC/WW SKU: 10029	G95 13W Non - Dimmable 3000K BC/B22 Frosted - Warm white - 1055lm
AT9428/BC/CW SKU: 10536	G95 13W Non - Dimmable 4000K BC/B22 Frosted - Cool white - 1055lm
AT9428/BC/DL SKU: 10990	G95 13W Non - Dimmable 6500K BC/B22 Frosted - Daylight - 1055lm

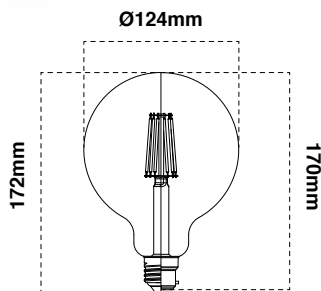

AT9478

7.7W Dimmable G120 Filament Lamp - Clear

Product specification

Voltage	230~50Hz
Power consumption	7.7W
Lamp shape	G95
Dimmable	Yes
Beam angle	360°
Colour rendering index	80
Average rated life	15,000 hours
Switching cycles	≥50,000 cycles

Product range

Code	Description
AT9478/ES/WW/C SKU: 10792	G120 Filament 7.7W Dimmable 2700K ES/E14 Clear - 1055lm
AT9478/BC/WW/C SKU: 10769	G120 Filament 7.7W Dimmable 2700K BC/B22 Clear - 1055lm



AT9422

6W Dimmable G45 Fancy Round Lamp - Frosted

Product specification

Voltage	230~50Hz
Power consumption	6W
Lamp shape	G45
Dimmable	Yes
Beam angle	300°
Colour rendering index	>80
Average rated life	15,000 hours
Switching cycles	≥50,000 cycles

Product range

Code	Description
AT9422/BC/WW SKU: 12047	6W Dimmable Fancy Round Lamp - Cool White 3000K BC/B22 Frosted - 490lm
AT9422/BC/CW SKU: 16599	6W Dimmable Fancy Round Lamp - Cool White 4000K BC/B22 Frosted - 490lm
AT9422/BC/DL SKU: 16804	6W Dimmable Fancy Round Lamp - Cool White 6500K BC/B22 Frosted - 500lm
AT9422/ES/WW SKU: 11960	6W Dimmable Fancy Round Lamp - Cool White 3000K ES/E272 Frosted - 490lm
AT9422/ES/CW SKU: 18233	6W Dimmable Fancy Round Lamp - Cool White 4000K ES/E27 Frosted - 490lm
AT9422/ES/DL SKU: 11011	6W Dimmable Fancy Round Lamp - Cool White 6500K ES/E27 Frosted - 500lm
AT9422/SBC/WW SKU: 10741	6W Dimmable Fancy Round Lamp - Cool White 3000K SBC/B15 Frosted - 490lm
AT9422/SBC/CW SKU: 16748	6W Dimmable Fancy Round Lamp - Cool White 4000K SBC/B15 Frosted - 490lm
AT9422/SBC/DL SKU: 14643	6W Dimmable Fancy Round Lamp - Cool White 6500K SBC/B15 Frosted - 500lm
AT9422/SES/WW SKU: 17630	6W Dimmable Fancy Round Lamp - Cool White 3000K SES/E14 Frosted - 490lm
AT9422/SES/CW SKU: 18316	6W Dimmable Fancy Round Lamp - Cool White 4000K SES/E14 Frosted - 490lm
AT9422/SES/DL SKU: 14772	6W Dimmable Fancy Round Lamp - Cool White 6500K SES/E14 Frosted - 500lm

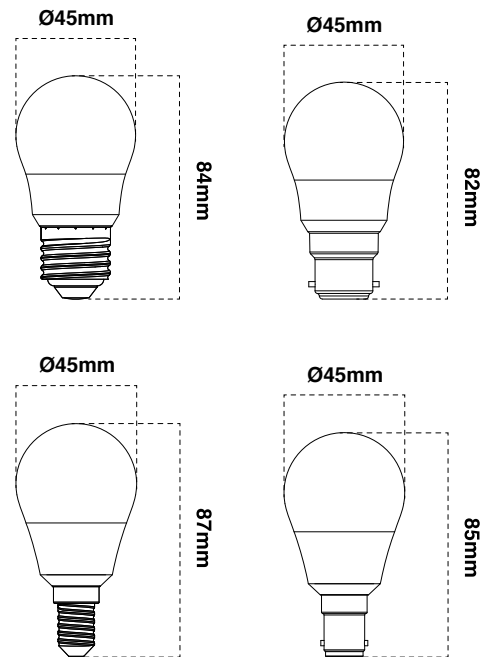

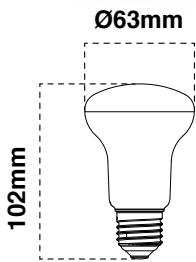

AT9724

6.5W Non - Dimmable R63 Lamp - Frosted

Product specification

Voltage	230~50Hz
Power consumption	6.5W
Lamp shape	R63
Dimmable	No
Beam angle	100°
Colour rendering index	>80
Average rated life	15,000 hours
Switching cycles	≥50,000 cycles

Product range

Code	Description
AT9724/ES/WW SKU: 11224	R63 6.5W Non - Dimmable 3000K ES/E27 Frosted - 420lm
AT9724/ES/CW SKU: 11156	R63 6.5W Non - Dimmable 4000K ES/E27 Frosted - 490lm
AT9724/ES/DL SKU: 11349	R63 6.5W Non - Dimmable 6500K ES/E27 Frosted - 490lm

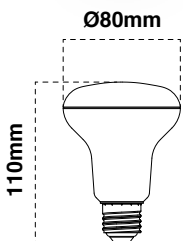

AT9721

9.3W Non - Dimmable R80 Lamp - Frosted

Product specification

Voltage	230~50Hz
Power consumption	9.3W
Lamp shape	R80
Dimmable	No
Beam angle	100°
Colour rendering index	>80
Average rated life	15,000 hours
Switching cycles	≥50,000 cycles

Product range

Code	Description
AT9721/ES/WW SKU: 11444	R80 9.3W Non - Dimmable 3000K ES/E27 Frosted - 840lm
AT9721/ES/CW SKU: 11353	R80 9.3W Non - Dimmable 4000K ES/E27 Frosted - 890lm
AT9721/ES/DL SKU: 11416	R80 9.3W Non - Dimmable 6500K ES/E27 Frosted - 890lm

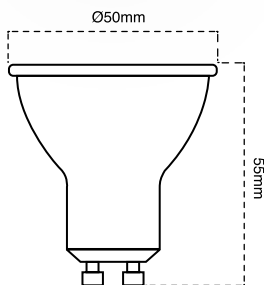
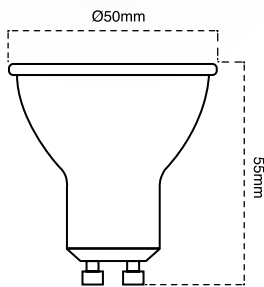

AT9450

4W Non - Dimmable LED GU10 Lamp

Product specification

Voltage	230~50Hz
Power consumption	4W
Lamp shape	GU10
Dimmable	No
Beam angle	36°
Colour rendering index	80
Average rated life	15,000 hours
Switching cycles	≥50,000 cycles

Product range

Code	Description
AT9450/36/WW SKU: 10563	4W GU10 36° Lamp - Warm White 3000K - 270lm
AT9450/36/CW SKU: 10557	4W GU10 36° Lamp - Warm White 4000K - 300lm
AT9450/36/DL SKU: 10598	4W GU10 36° Lamp - Warm White 6500K - 300lm

AT9451

6.7W Dimmable LED GU10 Lamp

Product specification

Voltage	230~50Hz
Power consumption	6.7W
Lamp shape	GU10
Dimmable	Yes
Beam angle	36° & 60°
Colour rendering index	80
Average rated life	15,000 hours
Switching cycles	≥50,000 cycles

Product range

Code	Description
AT9451/36/WW SKU: 10623	6.7W Dimmable GU10 36° Lamp - Cool White 3000K - 650lm
AT9451/36/CW SKU: 10589	6.7W Dimmable GU10 36° Lamp - Warm White 4000K - 700lm
AT9451/36/DL SKU: 10670	6.7W Dimmable GU10 36° Lamp - Daylight 6500K - 700lm
AT9451/60/WW SKU: 10755	6.7W Dimmable GU10 60° Lamp - Warm White 3000K - 600lm
AT9451/60/CW SKU: 15940	6.7W Dimmable GU10 60° Lamp - Cool White 4000K - 680lm
AT9451/60/DL SKU: 16001	6.7W Dimmable GU10 60° Lamp - Daylight 6500K - 680lm

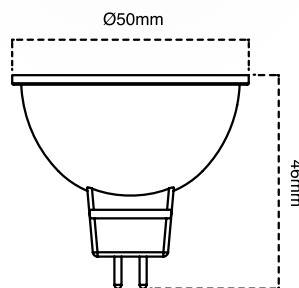
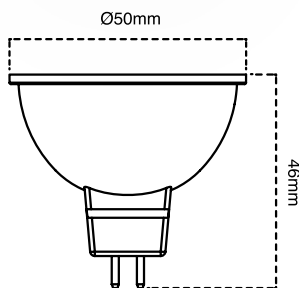

AT9452

3.1W Non - Dimmable LED MR16 Lamp

Product specification

Voltage	230~50Hz
Power consumption	3.1W
Lamp shape	MR16
Dimmable	No
Beam angle	36° & 60°
Colour rendering index	80
Average rated life	15,000 hours
Switching cycles	≥50,000 cycles

Product range

Code	Description
AT9452/36/WW SKU: 10721	3.1W MR16 36° Lamp - Cool White 3000K - 270lm
AT9452/36/CW SKU: 10712	3.1W MR16 36° Lamp - Warm White 4000K - 290lm
AT9452/36/DL SKU: 10821	3.1W MR16 36° Lamp - Daylight 6500K - 290lm
AT9452/60/WW SKU: 10794	3.1W MR16 60° Lamp - Warm White 3000K - 270lm
AT9452/60/CW SKU: 10703	3.1W MR16 60° Lamp - Cool White 4000K - 290lm
AT9452/60/DL SKU: 10834	3.1W MR16 60° Lamp - Daylight 6500K - 290lm

AT9453

6W Non - Dimmable LED MR16 Lamp

Product specification

Voltage	230~50Hz
Power consumption	6W
Lamp shape	MR16
Dimmable	No
Beam angle	36° & 60°
Colour rendering index	80
Average rated life	15,000 hours
Switching cycles	≥50,000 cycles

Product range

Code	Description
AT9453/36/WW SKU: 16359	6W MR16 36° Lamp - Warm White 3000K - 520lm
AT9453/36/CW SKU: 10841	6W MR16 36° Lamp - Cool White 3000K - 520lm
AT9453/36/DL SKU: 10855	6W MR16 36° Lamp - Daylight 6500K - 520lm
AT9453/60/WW SKU: 10679	6W MR16 60° Lamp - Warm White 3000K - 520lm
AT9453/60/CW SKU: 10949	6W MR16 60° Lamp - Cool White 3000K - 520lm
AT9453/60/DL SKU: 11087	6W MR16 60° Lamp - Daylight 6500K - 520lm

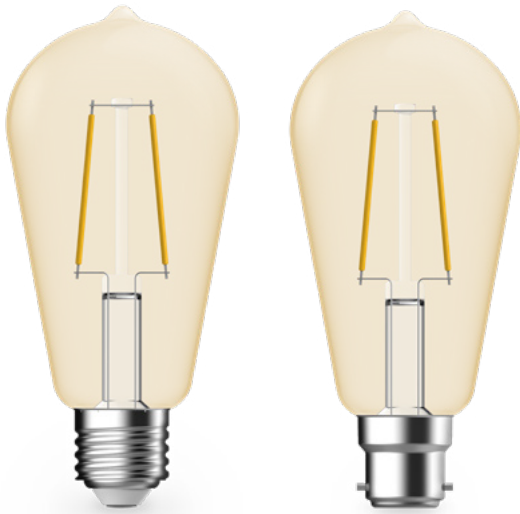

AT9480

5.1W Dimmable ST64 Filament Lamp - Golden Clear

Product specification

Voltage	230~50Hz
Power consumption	5.1W
Lamp shape	ST64
Dimmable	Yes
Beam angle	360°
Colour rendering index	80
Average rated life	15,000 hours
Switching cycles	≥50,000 cycles

Product range

Code	Description
AT9480/ES/WW/GC SKU: 10840	ST64 Filament 5.1W Dimmable 2500K ES/E27 Golden Clear - 380lm
AT9480/BC/WW/GC SKU: 10880	ST64 Filament 5.1W Dimmable 2500K BC/B22 Golden Clear - 380lm

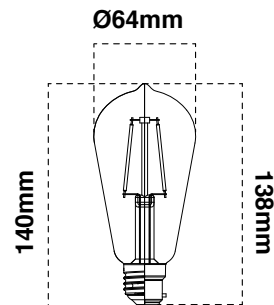



AT9481

8.3W Dimmable ST64 Filament Lamp - Golden Clear

Product specification

Voltage	230~50Hz
Power consumption	8.3W
Lamp shape	ST64
Dimmable	Yes
Beam angle	360°
Colour rendering index	80
Average rated life	15,000 hours
Switching cycles	≥50,000 cycles

Product range

Code	Description
AT9481/ES/WW/GC SKU: 10983	ST64 Filament 8.3W Dimmable 2500K ES/E27 Golden Clear - 660lm
AT9481/BC/WW/GC SKU: 11005	ST64 Filament 8.3W Dimmable 2500K BC/B22 Golden Clear - 660lm

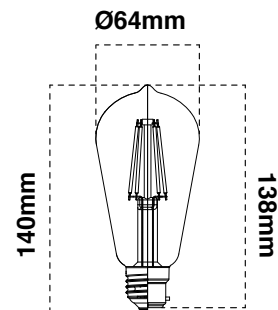

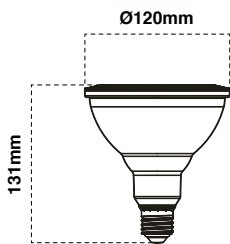

CUT-OUT: Ø45mm
Dimensions: 103mm x Ø50mm

AT9425

16W Weatherproof PAR38 Lamp - Frosted

Product specification

Voltage	230~50Hz
Power consumption	16W
Lamp shape	PAR38
Dimmable	No
Beam angle	100°
Colour rendering index	80
Average rated life	15,000 hours
Switching cycles	≥50,000 cycles
IP Rating	IP65

Product range

Code	Description
AT9425/ES/WW SKU: 11536	PAR38 16W Weatherproof IP65 3000K ES/E27 - 1400lm
AT9425/ES/CW SKU: 11591	PAR38 16W Weatherproof IP65 4000K ES/E27 - 1400lm
AT9425/ES/DL SKU: 11486	PAR38 16W Weatherproof IP65 5000K ES/E27 - 1400lm

AT9120

10W LED Lamp with Dimmable LED Driver

Product specification

Voltage	230~50Hz
Power consumption	10W
Dimmable	Yes
Beam angle	60°
Colour rendering index	80
Average rated life	15,000 hours
Switching cycles	≥50,000 cycles

Product range

Code	Description
AT9120/WW/60 SKU: 10651	10W LED Lamp with Dimmable LED Driver - Warm White - 60° Beam - 590lm
AT9120/CW/60 SKU: 10533	10W LED Lamp with Dimmable LED Driver - Cool White - 60° Beam - 600lm

REMOTE



AT9612/WIZ/RC

SKU 17955

WiZ Infra-red remote - can control a light + 4 light modes.

Suitable for *WiZ lights with Infrared compatibility*



LED Exterior

Exterior lighting is essential for safety and wellbeing, being able to see walkways and entrances. The added bonus is the beauty that a perfect light can add to the entrance of any property.

Overview

LED EXTERIOR AND WORKLIGHTS

UP/DOWN EXTERIOR LIGHTS	96
WALL SPOTS EXTERIOR LIGHTS	97
SPOTLIGHTS	98
SPOTLIGHTS WITH SENSOR	99
GARDEN SPIKES	100 - 101
BOLLARDS	102
WORKLIGHT	103



atom

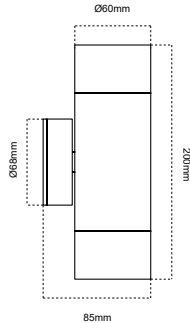

Finish

- Anodised aluminium
- Anodised titanium
- Anodised black
- Stainless steel (316)
- White

AT5004

2 x 6W LED Up/Down Light

Product specification

Voltage	230~50Hz
Power consumption	2 x 6W
Light colour options	Cool white
Colour temperature	4000K
Beam angle	38°
Dimmable	No
Lamp type	GU10
IP Rating	IP65

Product range

Code	Description
AT5004/AND/LED SKU: 12674	2 x 6W LED Anodised Aluminium Up/Down Light - 2 x 570lm
AT5004/AND/AT/LED SKU: 12780	2 x 6W LED Anodised Aluminium Titanium Up/Down Light - 2 x 570lm
AT5005/AND/BLK/LED SKU: 12747	6W LED Anodised Aluminium Adjustable Black Wall Spot - 2 x 570lm
AT5004/316/LED SKU: 12831	2x 6W LED - 316L Stainless Steel Up/Down Light - 2 x 570lm
AT5004/WHT/LED SKU: 12576	2 x 6W LED White Up/Down Light - 2 x 570lm

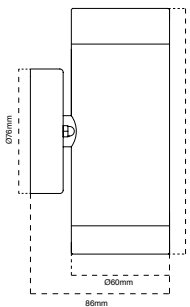

Finish

- Stainless steel (304)

AT5007

2 x 3.5W LED Up/Down Light

Product specification

Voltage	230~50Hz
Power consumption	2 x 3.5W
Light colour options	Cool white
Colour temperature	4000K
Beam angle	38°
Dimmable	No
Lamp type	GU10
IP Rating	IP44

Product range

Code	Description
AT5007 SKU: 10293	304 Stainless Steel Up/Down Light LED - 2 x 250lm

AT5006

6W LED Fixed Wall Spot

Product specification

Voltage	230~50Hz
Power consumption	6W
Light colour options	Cool white
Colour temperature	4000K
Beam angle	36°
Dimmable	No
Lamp type	GU10
IP Rating	IP65

Product range

Code	Description
AT5006/AND/BLK/LED SKU: 16188	6W LED Anodised Aluminium Fixed Wall Spot - Black - 570lm



Finish

■ Anodised black

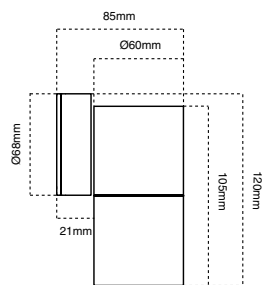

AT5005

6W LED Adjustable Wall Spot

Product specification

Voltage	230~50Hz
Power consumption	6W
Light colour options	Cool white
Colour temperature	4000K
Beam angle	38°
Dimmable	No
Lamp type	GU10
IP Rating	IP65

Product range

Code	Description
AT5005/AND/LED SKU: 12607	6W LED Anodised Aluminium Adjustable Wall Spot - 570lm
AT5005/AND/BLK/LED SKU: 12694	6W LED Anodised Aluminium Adjustable Black Wall Spot - 570lm

Finish

■ Anodised aluminium

■ Anodised black

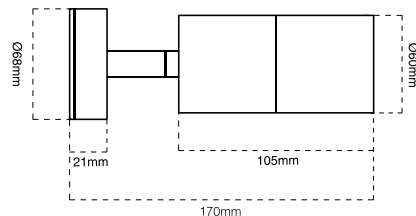



Finish

Black
 Silver
 White

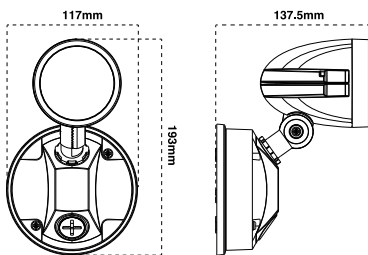

AT9130

10W LED Single Spotlight

Product specification

Voltage	230~50Hz
Power consumption	10W
Light colour options	Daylight
Colour temperature	5000K
Beam angle	115°
Dimmable	No
IP Rating	IP44

Product range

Code	Description
AT9130/BLK SKU: 10060	10W IP44 Black LED Single Spotlight - 1100lm
AT9130/SIL SKU: 10062	10W IP44 Silver LED Single Spotlight - 1100lm
AT9130/WH SKU: 10105	10W IP44 White LED Single Spotlight - 1100lm



Finish

Black
 Silver
 White

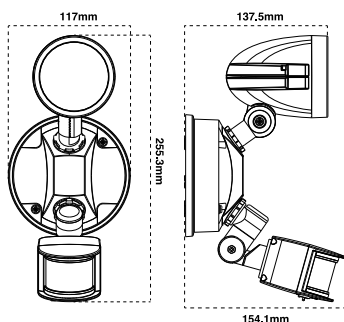

AT9131

10W LED Single Spotlight with sensor

Product specification

Voltage	230~50Hz
Power consumption	10W
Light colour options	Daylight
Colour temperature	5000K
Beam angle	115°
Dimmable	No
IP Rating	IP44

Product range

Code	Description
AT9131/BLK SKU: 10132	10W IP44 Black LED Twin Spotlight with sensor - 1000lm
AT9131/SIL SKU: 10107	10W IP44 Silver LED Twin Spotlight with sensor - 1000lm
AT9131/WH SKU: 10134	10W IP44 White LED Single Spotlight with sensor - 1000lm

atomⁱ



Finish

Black
 Silver
 White

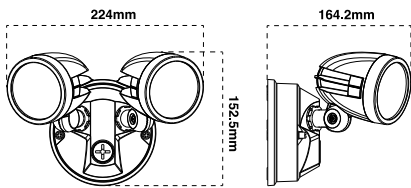

Finish

Black
 Silver
 White

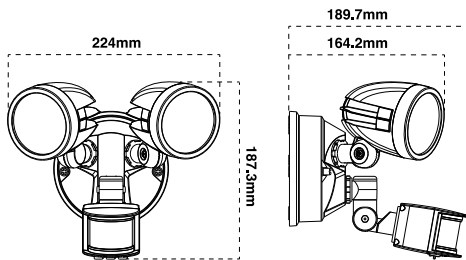

AT9132

2 x 10W LED Twin Spotlight

Product specification

Voltage	230~50Hz
Power consumption	20W
Light colour options	Daylight
Colour temperature	5000K
Beam angle	115°
Dimmable	No
IP Rating	IP44

Product range

Code	Description
AT9132/BLK SKU: 10136	20W IP44 Black LED Twin Spotlight - 2300lm
AT9132/SIL SKU: 10138	20W IP44 Silver LED Twin Spotlight - 2300lm
AT9132/WH SKU: 10140	20W IP44 White LED Twin Spotlight - 2300lm

AT9133

2 x 10W LED Twin Spotlight with sensor

Product specification

Voltage	230~50Hz
Power consumption	24W
Light colour options	Cool white
Colour temperature	4000K
Beam angle	115°
Dimmable	No
IP Rating	IP44

Product range

Code	Description
AT9133/BLK SKU: 10152	20W IP44 Black LED Twin Spotlight with sensor - 2200lm
AT9133/SIL SKU: 10137	20W IP44 Silver LED Twin Spotlight with sensor - 2200lm
AT9133/WH SKU: 10142	20W IP44 White LED Twin Spotlight with sensor - 2200lm



AT5101

6W LED 12V Spike Spot

Product specification

Voltage	12V
Power consumption	6W
Light colour options	Cool white
Colour temperature	4000K
Beam angle	38°
Dimmable	No
Lamp type	MR16
IP Rating	IP65

Product range

Code	Description
AT5101/AND/LED SKU: 12147	6W LED IP65 12v Anodised Aluminium Spike Spot - 570lm
AT5101/316/LED SKU: 11947	6W LED IP65 12v 316L Stainless Steel Spike Spot - 570lm
AT5101/AND/BLK/LED SKU: 12084	6W LED IP65 12v Spike Spot Anodised Aluminium - Black - 570lm
AT5101/BLK/LED SKU: 12205	6W LED IP65 12v Spike Spot - Black - 570lm

Finish

- Anodised aluminium
- Anodised black
- Stainless steel (316)
- Black

Compatible drivers

AT - 28000507 SKU: 12945 12Vdc - 15W IP67 LED Driver
AT - 28000508 SKU: 11169 12Vdc - 35W IP67 LED Driver
AT - 28000509 SKU: 11257 12Vdc - 60W IP67 LED Driver
AT - 28000510 SKU: 11291 12Vdc - 35W IP67 LED Driver
AT030VA W/P SKU: 10321 30VA Weatherproof transformer
AT050VA W/P SKU: 10445 50W Weatherproof transformer
AT060VA W/P SKU: 10665 60W Mini Weatherproof transformer
AT100VA W/P SKU: 10573 100W Mini Weatherproof transformer
AT105VA W/P SKU: 10650 105W Mini Weatherproof transformer
AT200VA W/P SKU: 10575 200W Weatherproof transformer
AT300VA W/P SKU: 10524 300W Weatherproof transformer
AT400VA W/P SKU: 10722 400W Weatherproof transformer

Must use appropriate driver. Sold separately.

atom

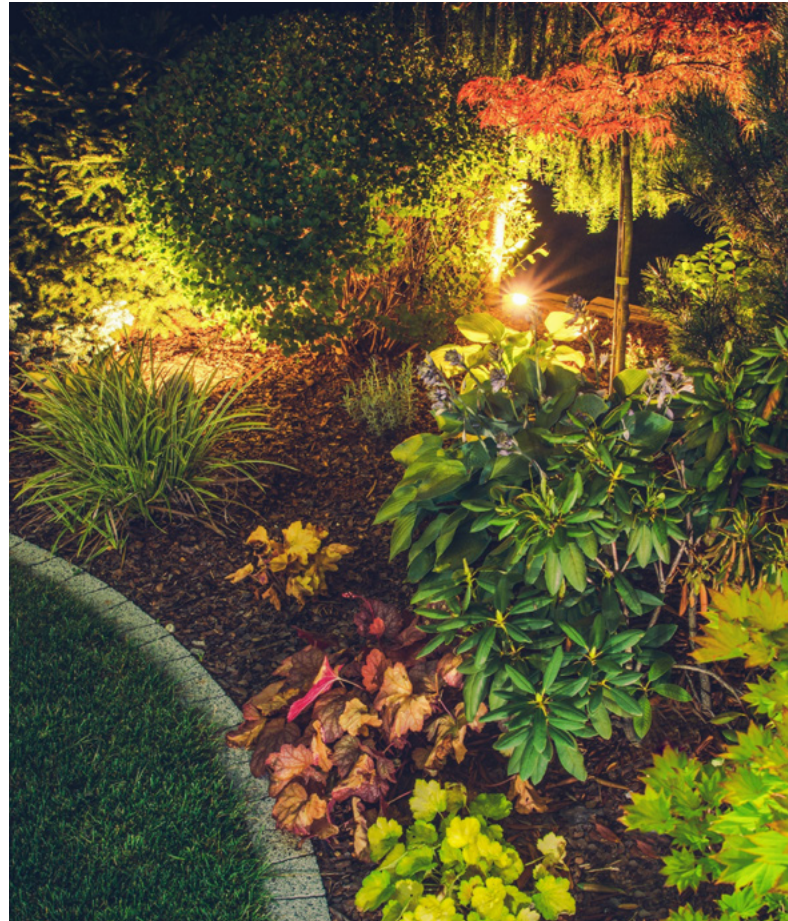
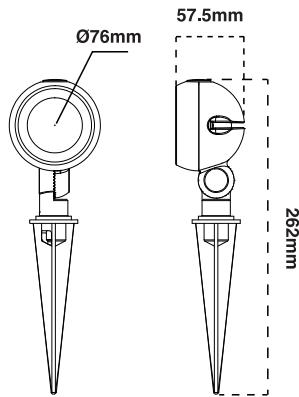

AT5107

6W & 10W LED Garden Spike Light

Product specification

Voltage	12V
Power consumption	6W & 10W
Light colour options	Warm white & Daylight
Colour temperature	3000K & 5000K
Beam angle	60°
Dimmable	No
IP Rating	IP65

Product range

Code	Description
AT5107/6/BLK/WW SKU: 11781	6W LED Garden Spike light - Black - Warm White - 490lm
AT5107/6/BLK/DL SKU: 11754	6W LED Garden Spike Light - Black - Daylight - 510lm
AT5107/10/BLK/WW SKU: 11834	10W LED Garden Spike Light - Black - Warm White - 850lm
AT5107/10/BLK/DL SKU: 11809	10W LED Garden Spike Light - Black - Daylight - 880lm

Finish

Black

Compatible drivers

AT - 28000507 SKU: 12945 12Vdc - 15W IP67 LED Driver
AT - 28000508 SKU: 11169 12Vdc - 35W IP67 LED Driver
AT - 28000509 SKU: 11257 12Vdc - 60W IP67 LED Driver
AT - 28000510 SKU: 11291 12Vdc - 35W IP67 LED Driver
AT060VA W/P SKU: 10665 60W Mini Weatherproof transformer
AT105VA W/P SKU: 10680 105W Mini Weatherproof transformer

Must use appropriate driver. Sold separately.



AT5908

12V Bollard with clear diffuser

Product specification

Voltage	12V
Dimmable	No
Lamp type	1 x MR16* (max. 6W)
IP Rating	IP65

*Lamp not included

Product range

Code	Description
AT5908/AND/LED SKU: 12850	12V LED 445mm Bollard light with clear diffuser - Anodised titanium
AT5908/AND/BLK/LED SKU: 12872	12V LED 445mm Bollard light with clear diffuser - Anodised black

Suitable lamp range

Code	Description
AT5908/AND/BLK/LED SKU: 12872	12v LED 445mm Bollard light with clear diffuser - Anodised black
AT5908/AND/LED SKU: 12850	12v LED 445mm Bollard light with clear diffuser - Anodised titanium

Finish

■ Anodised titanium ■ Anodised black

Accessories

AT5908/EXT/AND/BLK
SKU: 12953
380mm Extension for AT5908 Bollard Anodised Black

AT5908/EXT/AND
SKU: 12941
380mm Extension for AT5908 Bollard Anodised

Compatible drivers

AT-28000507
SKU: 12945
12Vdc - 15W IP67 LED Driver

AT-28000508
SKU: 11169
12Vdc - 35W IP67 LED Driver

AT-28000509
SKU: 11257
12Vdc - 60W IP67 LED Driver

AT-28000510
SKU: 11291
12Vdc - 100W IP67 LED Driver

AT060VA W/P
SKU: 10665
60W Mini Weatherproof transformer

AT105VA W/P
SKU: 10680
105W Mini Weatherproof transformer

Must use appropriate driver. Sold separately.



AT6002

10W LED Adjustable Security & Worklight

Product specification

Voltage	230~50Hz
Power consumption	10W
Light colour options	Daylight
Colour temperature	5000K
Lumen output	1000lm
Beam angle	45°- 120°
Dimmable	No
IP Rating	IP54

Product range

Code	Description
AT6002 SKU: 11250	10W LED Adjustable Security & Worklight

Finish

■ Yellow

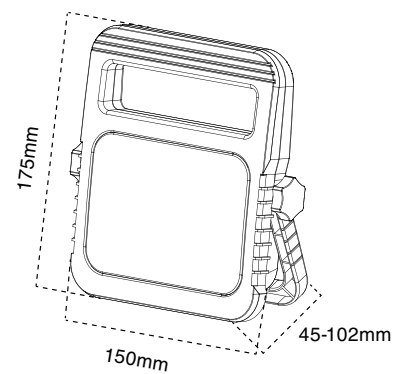



Commercial Lighting

Lighting built tough to withstand harsh internal and external environments. Giving the light needed to secure your property and ensure safety for all.

Overview

COMMERCIAL LIGHTING

BACKLIT PANELS	106 - 107
TROFFER	108 - 109
FLOODLIGHTS	110 - 114
HIGHBAYS	115 - 116
WEATHERPROOF BATTENS	117 - 118
DIFFUSED BATTENS	119 - 120
WIRE GUARD BATTENS	121
ACCESSORIES	122 - 123

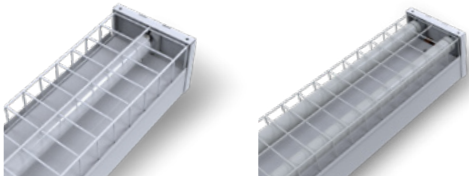
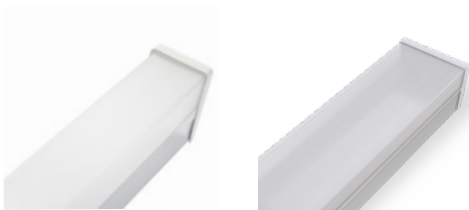

AT6020

LED Backlit Panel

Product specification

Voltage	230~50Hz
Power consumption	20W, 36W & 60W
Dimmable	No
Colour temperature	Cool white & Daylight
Light colour options	4000K & 6500K
Beam angle	120°
IP Rating	IP20
Average rated life	L70 (6K)>33,000 Hrs

Product range

Code	Description
AT6020/306/CW SKU: 13106	20W LED Backlit panel 300 x 600mm - Cool white - 2050lm
AT6020/306/DL SKU: 13108	20W LED Backlit panel 300 x 600mm - Daylight - 2035lm
AT6020/312/CW SKU: 13160	36W LED Backlit panel 300 x 1200mm - Cool white - 3485lm
AT6020/312/DL SKU: 13172	36W LED Backlit panel 300 x 1200mm - Daylight - 3430lm
AT6020/606/CW SKU: 13135	36W LED Backlit panel 600 x 600mm - Cool white - 3600lm
AT6020/606/DL SKU: 13147	36W LED Backlit panel 600 x 600mm - Daylight - 3565lm
AT6020/612/CW SKU: 13186	60W LED Backlit panel 600 x 1200mm - Cool white - 6280lm
AT6020/612/DL SKU: 13199	60W LED Backlit panel 600 x 1200mm - Daylight - 6320lm

Finish

White

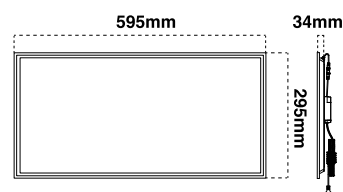
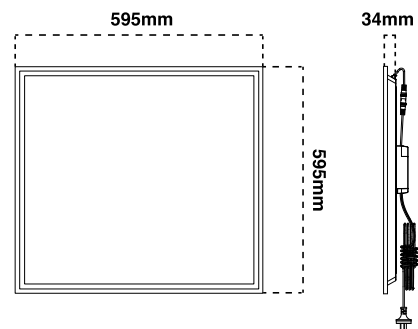
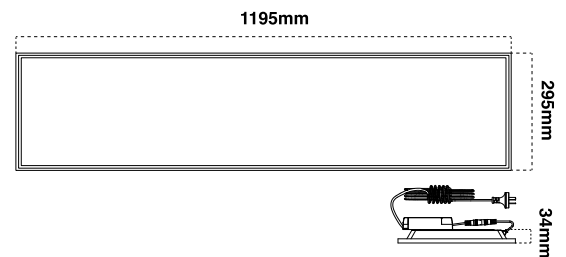
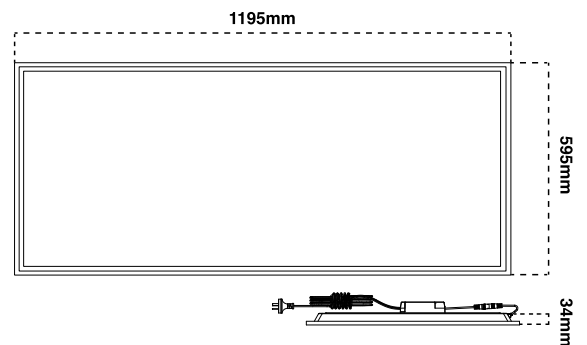
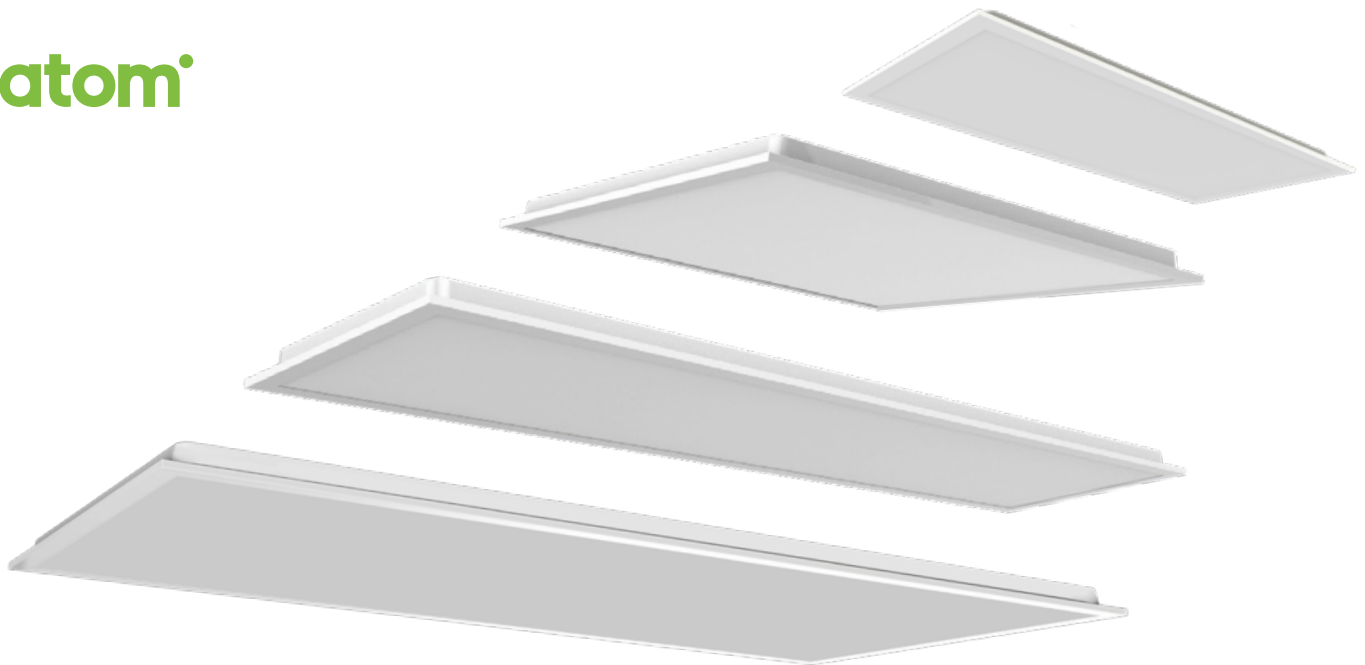

AT6021

LED Backlit Panel

Product specification

Voltage	230~50Hz
Power consumption	20W, 36W & 60W
Dimmable	No
Colour temperature	Cool white & Daylight
Light colour options	4000K & 6500K
Beam angle	90°
Diffuser	PC
IP Rating	IP20
Average rated life	L70 (10K) B10 >60,000 Hrs

Product range

Code	Description
AT6021/306/CW SKU: 13110	20W LED Backlit panel 300 x 600mm - Cool white - 1975lm
AT6021/306/DL SKU: 13112	20W LED Backlit panel 300 x 600mm - Daylight - 1930lm
AT6021/312/CW SKU: 13332	36W LED Backlit panel 300 x 1200mm - Cool white - 3455lm
AT6021/312/DL SKU: 13346	36W LED Backlit panel 300 x 1200mm - Daylight - 3500lm
AT6021/606/CW SKU: 13311	36W LED Backlit panel 600 x 600mm - Cool white - 3680lm
AT6021/606/DL SKU: 13328	36W LED Backlit panel 600 x 600mm - Daylight - 3560lm
AT6021/612/CW SKU: 13355	60W LED Backlit panel 600 x 1200mm - Cool white - 5925lm
AT6021/612/DL SKU: 13367	60W LED Backlit panel 600 x 1200mm - Daylight - 5860lm

Finish

White

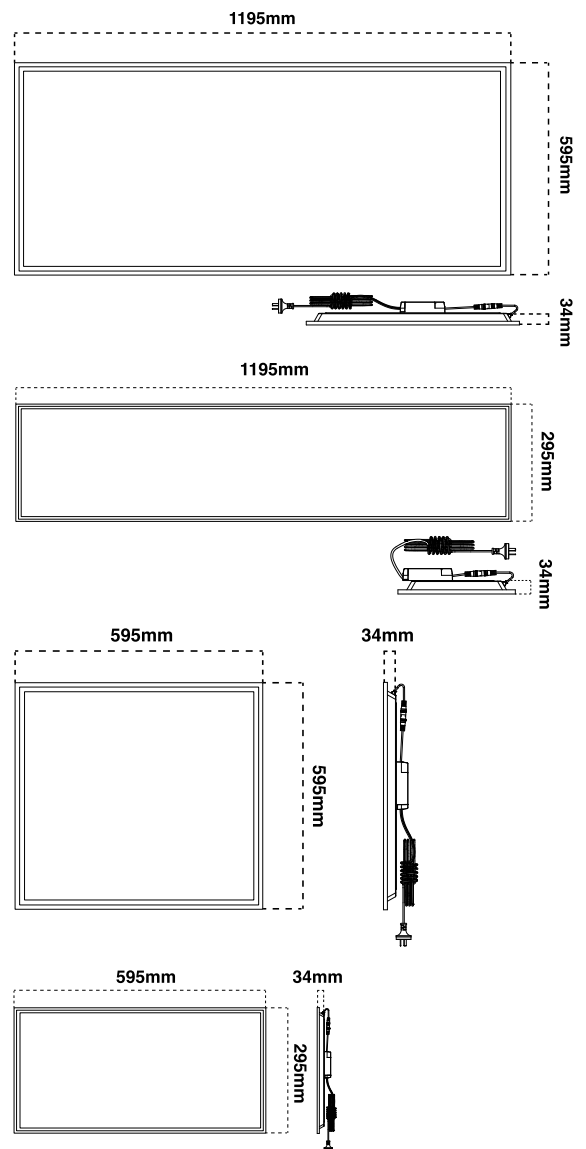



AT7050 & AT7053

LED Low Glare Direct/Indirect Troffer

Product specification

Voltage	230~50Hz
Power consumption	25W & 30W
Dimmable	DALI Dimmable
Colour temperature	Cool white
Light colour options	4000K
Beam angle	90°
IP Rating	IP40
IC Rating	IC-4
Average rated life	L70 (9K)B10 >54,000 Hrs

Product range

Code	Description
AT7050/WH/CW SKU: 13106	30W LED Low Glare Direct/Indirect Troffer - Ø1200 x 300mm - Cool White 4000K - 3450lm
AT7053/WH/CW SKU: 13106	25W LED Low Glare Direct/Indirect Troffer - Ø600 x 300mm - Cool White 4000K - 2850lm

Finish

White

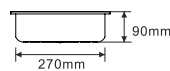
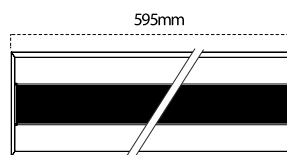
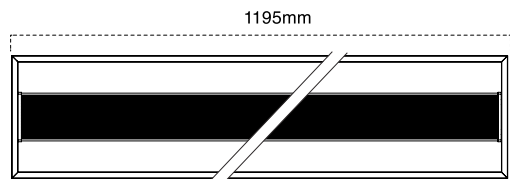



AT9054

LED Low Glare Troffer

Product specification

Voltage	230~50Hz
Power consumption	35W
Light colour options	Cool white
Colour temperature	4000K
Dimmable	No
Beam angle	90°
IP Rating	IP40

Product range

Code	Description
AT9054/WH/CW SKU: 18974	35W LED Troffer Low Glare Ø1200 x 300mm - Cool White 4000K - 4000lm

Finish

White

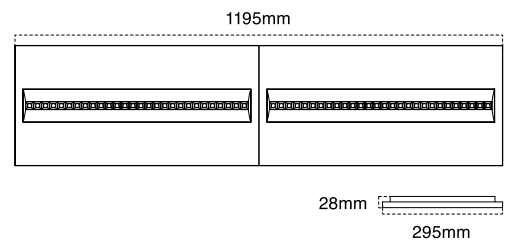



AT9814

LED IP65 Floodlight

Product specification

Voltage	230~50Hz
Power consumption	100W, 150W & 200W
Light colour options	Daylight
Colour temperature	5000K
Dimmable	No
IP Rating	IP66
IK Rating	IK08

Product range

Code	Description
AT99814/100 SKU: 17920	100W commercial LED Floodlight - 13380lm
AT99814/150 SKU: 17816	150W commercial LED Floodlight - 19745lm
AT99814/200 SKU: 10994	200W commercial LED Floodlight - 25540lm

Finish

■ Black

Accessories

AT9812/PMB
SKU: 12207
Pole mounting bracket.
Suitable for AT9814

For full product list see pages 119 - 120

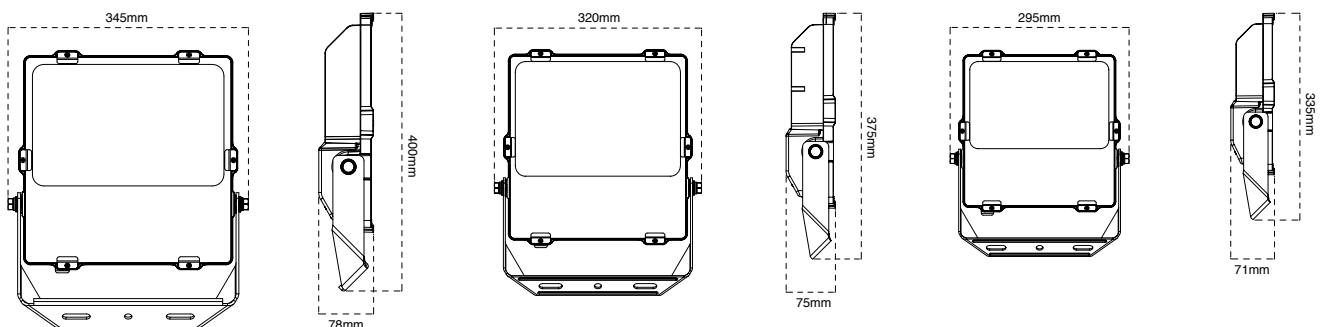

AT9819/10

10W LED Slim Floodlight



Finish

■ Black □ White

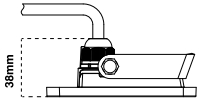
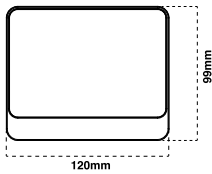

Product specification

Voltage	230~50Hz
Power consumption	10W
Light colour options	Daylight
Colour temperature	5000K
Beam angle	120°
Dimmable	No
IP Rating	IP65

Product range

Code	Description
AT9819/10/BLK SKU: 12038	10W Slim Floodlight - IP65 - Black - 910lm
AT9819/10/WH SKU: 11560	10W Slim Floodlight - IP65 - White - 910lm



Finish

■ Black □ White

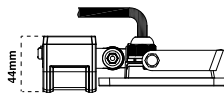
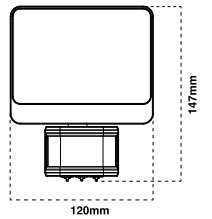

AT9819/10/S

10W LED Slim Floodlight with sensor

Product specification

Voltage	230~50Hz
Power consumption	10W
Light colour options	Daylight
Colour temperature	5000K
Beam angle	120°
Dimmable	No
IP Rating	IP44
Detection range	12m (at 1.8m mounting height)
Duration time adjustment	10±5 seconds to 4±minutes
Detection circuitry	Passive infra - red (PIR)

Product range

Code	Description
AT9819/10/BLK/S SKU: 12112	10W Slim Floodlight - Black with Sensor - 860lm
AT9819/10/WH/S SKU: 11587	10W Slim Floodlight - White with Sensor - 860lm

AT9819/20

20W LED Slim Floodlight



Finish

■ Black □ White

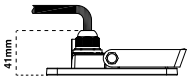
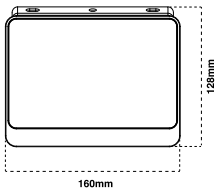

Product specification

Voltage	230~50Hz
Power consumption	20W
Light colour options	Daylight
Colour temperature	5000K
Beam angle	120°
Dimmable	No
IP Rating	IP65

Product range

Code	Description
AT9819/20/BLK SKU: 12206	20W Slim Floodlight - IP65 - Black - 1835lm
AT9819/20/WH SKU: 11653	20W Slim Floodlight - IP65 - White - 1835lm



Finish

■ Black □ White

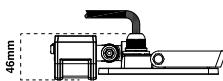
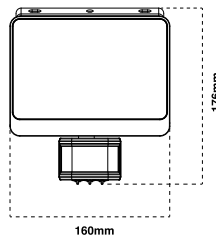

AT9819/20/S

20W LED Slim Floodlight with sensor

Product specification

Voltage	230~50Hz
Power consumption	20W
Light colour options	Daylight
Colour temperature	5000K
Beam angle	120°
Dimmable	No
IP Rating	IP44
Detection range	12m (at 1.8m mounting height)
Duration time adjustment	10±5 seconds to 4± minutes
Detection circuitry	Passive infra - red (PIR)

Product range

Code	Description
AT9819/20/BLK/S SKU: 12285	20W Slim Floodlight - Black with Sensor -1690lm
AT9819/20/WH/S SKU: 11725	20W Slim Floodlight - White with Sensor -1690lm

atom

AT9819/30

30W LED Slim Floodlight

Product specification

Voltage	230~50Hz
Power consumption	30W
Light colour options	Daylight
Colour temperature	5000K
Beam angle	120°
Dimmable	No
IP Rating	IP65

Product range

Code	Description
AT9819/30/BLK SKU: 12340	30W Slim Floodlight - IP65 - Black - 2320lm
AT9819/30/WH SKU: 11793	30W Slim Floodlight - IP65 - White - 2320lm

Finish

■ Black □ White

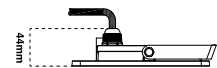
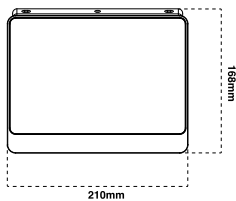

AT9819/30/S

30W LED Slim Floodlight with sensor

Product specification

Voltage	230~50Hz
Power consumption	30W
Light colour options	Daylight
Colour temperature	5000K
Beam angle	120°
Dimmable	No
IP Rating	IP44
Detection range	12m (at 1.8m mounting height)
Duration time adjustment	10±5 seconds to 4± minutes
Detection circuitry	Passive infra - red (PIR)

Product range

Code	Description
AT9819/30/BLK/S SKU: 12397	30W Slim Floodlight - Black with Sensor - 2590lm
AT9819/30/WH/S SKU: 11888	30W Slim Floodlight - White with Sensor - 2590lm

Finish

■ Black □ White

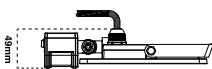
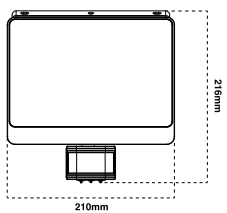

AT9819/50

50W LED Slim Floodlight

Product specification

Voltage	230~50Hz
Power consumption	50W
Light colour options	Daylight
Colour temperature	5000K
Beam angle	120°
Dimmable	No
IP Rating	IP65

Product range

Code	Description
AT9819/50/BLK SKU: 12468	50W Slim Floodlight - IP65 - Black - 4000lm
AT9819/50/WH SKU: 11982	50W Slim Floodlight - IP65 - White - 4000lm



Finish

■ Black □ White

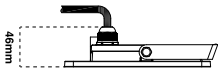
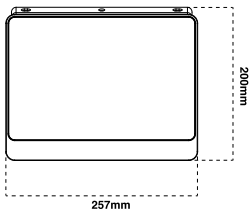

Finish

■ Black □ White

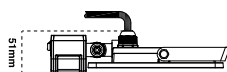
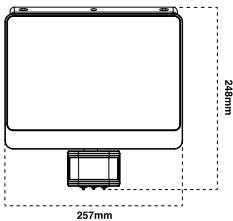

AT9819/50/S

50W LED Slim Floodlight with sensor

Product specification

Voltage	230~50Hz
Power consumption	50W
Light colour options	Daylight
Colour temperature	5000K
Beam angle	120°
Dimmable	No
IP Rating	IP44
Detection range	12m (at 1.8m mounting height)
Duration time adjustment	10±5 seconds to 4± minutes
Detection circuitry	Passive infra - red (PIR)

Product range

Code	Description
AT9819/50/BLK/S SKU: 11394	50W Slim Floodlight - Black with Sensor - 4255lm
AT9819/50/WH/S SKU: 11455	50W Slim Floodlight - White with Sensor 4255lm



AT9828

120W IP65 LED Highbay

Product specification

Voltage	230~50Hz
Power consumption	120W
Light colour options	Daylight
Colour temperature	5000K
Beam angle	120°
Dimmable	No
IP Rating	IP65

Product range

Code	Description
AT9828/120 SKU: 10409	120W LED Highbay - 18000lm



Finish

■ Black

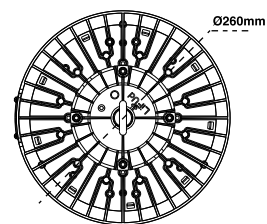
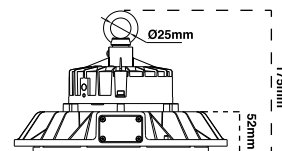



HOVER

120W, 150W & 200W IP65 LED Highbays

Product specification

Voltage	230~50Hz
Power consumption	120W, 150W & 200W
Light colour options	Daylight
Colour temperature	5000K
Beam angle	120°
Dimmable	No
IP Rating	IP65

Product range

Code	Description
HOVER SKU: 16022	120W LED Highbay - 5000K - 120° - Black - 16800lm
HOVER SKU: 16023	150W LED Highbay - 5000K - 120° - Black - 21000lm
HOVER SKU: 16024	200W LED Highbay - 5000K - 120° - Black - 28000lm



Finish

■ Black

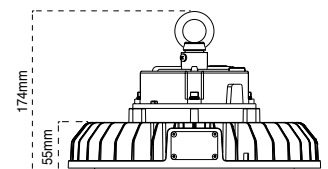
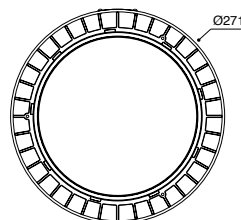
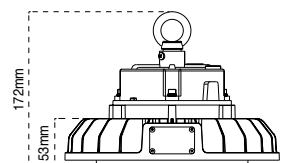
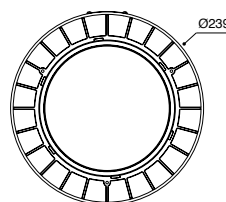



AT9890, AT9891 & AT9895

600mm & 1200mm IP65 Weatherproof LED Battens

Product specification

Voltage	230~50Hz
Power consumption	12W & 24W
Light colour options	Cool white
Colour temperature	4000K
Strips	Single & Twin
Dimmable	No
Beam angle	120°
IP Rating	IP65
IK Rating	IK08
Average rated life	L70 (9K) > 54,000 Hrs

Product range

Code	Description
AT9890 SKU: 11638	12W Single 600mm IP65 Weatherproof LED Batten - 1140lm
AT9895 SKU: 11398	24W Single 1200mm IP65 Weatherproof LED Batten - 2270lm
AT9891 SKU: 11186	24W Twin 600mm IP65 Weatherproof LED Batten - 2365lm



Finish

■ Grey

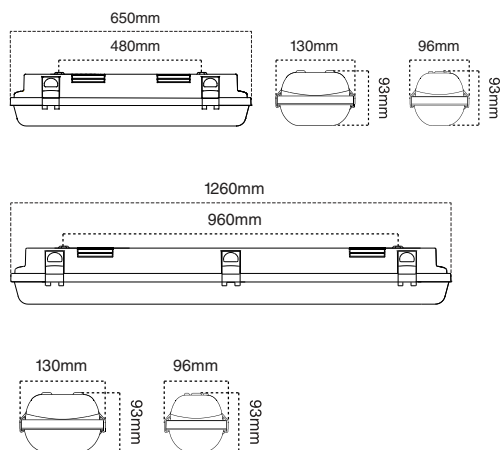



AT9873 & AT9877

600mm & 1200mm IP65 Weatherproof Basic LED Battens

Product specification

Voltage	230~50Hz
Power consumption	28W & 48W
Light colour options	Cool white
Colour temperature	4000K
Strips	Twin
Dimmable	No
Beam angle	120°
IP Rating	IP65
IK Rating	IK08
Average rated life	L70 (10K) 58,000 Hrs

Product range

Code	Description
AT9873 SKU: 11329	28W Twin 600mm IP65 Weatherproof Basic LED - 2685lm
AT9877 SKU: 11615	48W Twin 1200mm IP65 Weatherproof Basic LED - 4860lm

Finish

■ Grey

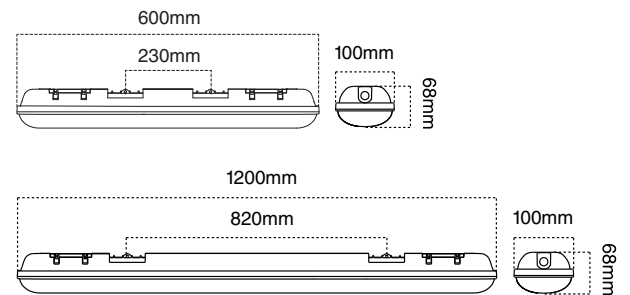



SPEAR

20W & 40W Narrow Body LED Batten - Tri-CCT

Product specification

Voltage	230~50Hz
Power consumption	21W & 42W
Light colour options	Tri Colour
Colour temperature	3000K, 4000K & 5700K
Strips	Single
Dimmable	No
Beam angle	120°
IP Rating	IP20
IK Rating	IK08
Average rated life	L70 (9K) > 54,000 Hrs

Product range

Code	Description
SPEAR SKU: 16054	20W 600mm Narrow Body LED Batten - Tri Colour - White - 2069lm
SPEAR SKU: 16055	40W 1200mm Narrow Body LED Batten - Tri Colour - White - 4490lm



Finish

White

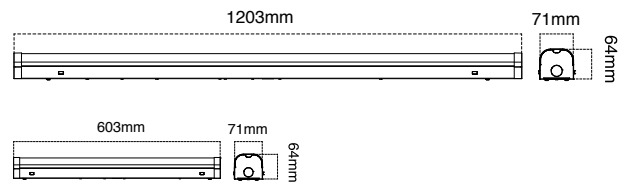



AT9842, AT9864, AT9865 & AT9866

21W & 42W Narrow and Wide Body Opal Diffused LED Battens

Product specification

Voltage	230~50Hz
Power consumption	21W & 42W
Light colour options	Cool white
Colour temperature	4000K
Strips	Single & Twin
Dimmable	No
Beam angle	120°C
IP Rating	IP20
Average rated life	L70 (9K) > 54,000 Hrs

Product range

Code	Description
AT9842/CW/O SKU: 11254	21W Single 1200mm Narrow Body Opal Diffused LED Batten - 2250lm
AT9864/CW/O SKU: 13203	21W Twin 600mm Wide Body Opal Diffused LED Batten - 2275lm
AT9865/CW/O SKU: 11145	21W Single 1200mm Narrow Body Opal Diffused LED Batten - 2275lm
AT9866/CW/O SKU: 11135	42W Twin 1200mm Wide Body Opal Diffused LED Batten - 4865lm



Finish

White

Accessories

AT9865/66/DIFF - O

SKU: 11913

Opal Diffuser only - 1200mm - Wide body.
Suitable for AT9865 and AT9866 Battens

AT9865/66/DIFF - P

SKU: 11362

Prismatic Diffuser only - 1200mm - Wide body.
Suitable for AT9865 and AT9866 Battens

For full product list see pages 119 - 120

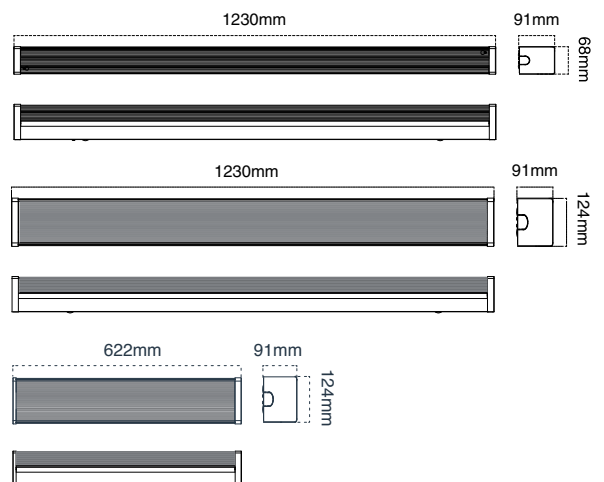



AT9884, AT9885 & AT9886

21W & 42W Single and Twin Wide Body Wire Guard LED Batten

Product specification

Voltage	230~50Hz
Power consumption	21W & 42W
Light colour options	Cool white
Colour temperature	4000K
Strips	Single & Twin
Dimmable	No
Beam angle	120°C
IP Rating	IP20
Average rated life	L70 (9K) > 54,000 Hrs

Product range

Code	Description
AT9884/CW SKU: 13954	21W Twin 600mm Wide Body Wire Guard LED Batten - 1795lm
AT9885/CW SKU: 14058	21W Single 1200mm Wide Body Wire Guard LED Batten - 1850lm
AT9886/CW SKU: 12135	42W Twin 1200mm Wide Body Wire Guard LED Batten - 3645lm



Finish

White

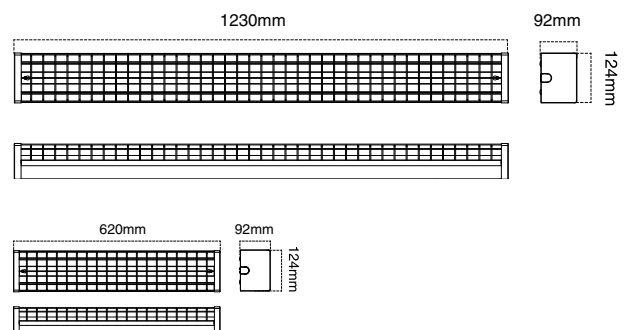

PANELS



AT9050/PRF/WH

SKU 10398
Plaster recessed frame 300 x 1200mm White.
Suitable for AT6020 & AT6021



AT9050/SMF/WH

SKU 11212
Surface mounted frame 300 x 1200mm White.
Suitable for AT6020 & AT6021



AT9051/PRF/WH

SKU 10760
Plaster recessed frame 600 x 600mm White.
Suitable for AT6020 & AT6021



AT9051/SMF/WH

SKU 11471
Surface mounted frame 600 x 600mm White.
Suitable for AT6020 & AT6021



AT9053/PRF/WH

SKU 10258
Plaster recessed frame 300 x 600mm White.
Suitable for AT6020 & AT6021



AT9053/SMF/WH

SKU 11772
Surface mounted frame 300 x 600mm White.
Suitable for AT6020 & AT6021



AT9056/PRF/WH

SKU 13856
Plaster recessed frame 300 x 1200mm White.
Suitable for AT6020 & AT6021



AT9056/SMF/WH

SKU 13673
Surface mounted frame 300 x 1200mm White.
Suitable for AT6020 & AT6021



AT9057

SKU 11315
Panel Suspension Cable Kit.
Suitable for AT6020 & AT6021

BATTENS

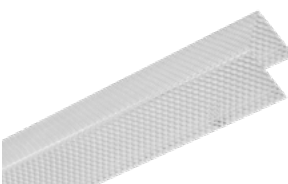

AT9842/DIFF-P

SKU 12542
Prismatic Diffuser only - 1200mm - Narrow body.
Suitable for AT9842

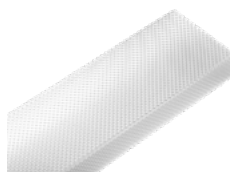

AT9865/66/DIFF - P

SKU 11362
Prismatic diffuser only - 1200mm - Wide body.
Suitable for AT9865 & AT9866

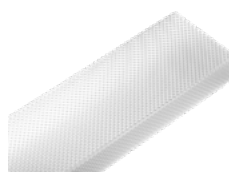

AT9864/DIFF-P

SKU 11317
Prismatic Diffuser only - 600mm - Wide body.
Suitable for AT9864

FLOODLIGHT



AT9865/66/DIFF - O

SKU 11913
Opal diffuser only - 1200mm - Wide body.
Suitable for AT9865 & AT9866



AT9812/PMB

SKU 12207
Pole mounting bracket.
Suitable for AT9814

HIGHBAYS



AT9827/29/LENS/50

SKU 10963
50° Lens for AT9827/AT9829.
Suitable for AT9827 & AT9829



AT9827/29/REF/BLK

SKU 10917
90° Lens for AT9827/AT9829.
Suitable for AT9827 & AT9829

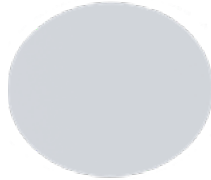

AT9812/PMB

SKU 12207
Opal Lens for AT9827/AT9829.
Suitable for AT9827 & AT9829



AT9827/29/REF/BLK

SKU 10917
90° Reflector for AT9827/AT9829 - Black.
Suitable for AT9827 & AT9829



**Drivers and
Accessories**

Overview

DRIVERS AND ACCESSORIES

- WEATHERPROOF DRIVERS 126
- CONSTANT VOLTAGE DRIVERS 126
- VOLTAGE DRIVERS 127
- CONSTANT CURRENT DRIVERS 127
- DIMMERS 128





WEATHERPROOF



AT030va W/P

SKU 10321
30Va Dimmable Weatherproof Transformer
30W - IP67 - Iron core
Dimensions: 65 x 140mm



AT050va W/P

SKU 10445
50Va Dimmable Weatherproof Transformer
50W - IP67 - Iron cor.
Dimensions: 70 x 185mm



AT060va W/P

SKU 10665
60Va Mini Weatherproof Transformer
60W - IP64 - Iron core
Dimensions: 70 x 135mm



AT100va W/P

SKU 10573
100Va Dimmable Weatherproof Transformer
100W - IP67 - Iron core
Dimensions: 70 x 175mm



AT105va W/P

SKU 10680
105Va Mini Weatherproof Transformer
105W - IP64 - Iron core
Dimensions: 70 x 180mm



AT200va W/P

SKU 10575
200Va Dimmable Weatherproof Transformer
200W - IP67 - Iron core
Dimensions: 100 x 200mm



AT300va W/P

SKU 10824
300Va Dimmable Weatherproof Transformer
300W - IP67 - Iron core
Dimensions: 100 x 200mm



AT400va W/P

SKU 10722
400Va Dimmable Weatherproof Transformer
400W - IP67 - Iron core
Dimensions: 110 x 230mm



AT500va W/P

SKU 10381
500Va Dimmable Weatherproof Transformer
500W - IP67 - Iron core
Dimensions: 110 x 230mm

CONSTANT VOLTAGE



AT9643/20

SKU 11337
20W 24V d.c. Constant voltage non - dimmable
driver with Flex & Plug
Dimensions: 107 x 41 x 22mm



AT9643/60

SKU 11370
60W 24V d.c. Constant voltage non - dimmable
driver with Flex & Plug
Dimensions: 170 x 50 x 29mm



AT9644/60

SKU 11370
60W 24V d.c. Constant voltage Dimmable driver
with Flex & Plug
Dimensions: 170 x 50 x 29mm

VOLTAGE DRIVERS



AT9601
SKU 10147
LED DC 6W Driver
Dimensions: 103 x 38 x 25mm



AT9602
SKU 10174
LED DC 10W Driver
Dimensions: 128 x 38 x 25mm



AT9603
SKU 10259
LED DC Dimmable 10W Driver
Dimensions: 112 x 38 x 25mm



AT9604
SKU 10230
LED DC 12V 20W Driver
Dimensions: 155 x 38 x 25mm



AT9605
SKU 10762
LED DC Dimmable 20W Driver
Dimensions: 128 x 35 x 25mm



AT9606
SKU 10783
LED DC 50W Driver
Dimensions: 175 x 46 x 35mm

CONSTANT CURRENT



AT9620
SKU 10154
LED 1 - 6W 350mA Constant Current Driver
Dimensions: 103 x 38 x 25mm



AT9621
SKU 10201
LED 6W - 700mA Constant Current Driver
Dimensions: 103 x 38 x 25mm



AT9628
SKU 10784
18W - 700mA Constant Current Dimmable LED Driver
Dimensions: 103 x 38 x 25mm

DIMMER



AT0972
SKU 10974
12W - 350mA Constant Current Dimmable LED Driver
Dimensions: 103 x 38 x 25mm



AT9303
SKU 11272
350W Trailing control Dimmer - Push button.
Dimensions: 23.5 x 44.3 x 23.5mm



WARRANTY

Atom products are distributed in Australia by Evolt Pty Limited ('us', 'our', or 'we'). Our contact information is shown on this catalogue.

As a responsible supplier, our goods come with guarantees that are covered under the Australian Consumer Law. You are entitled to a replacement or refund for a major failure and compensation for any other reasonably foreseeable loss or damage. You are also entitled to have the goods repaired or replaced if the goods fail to be of acceptable quality and the failure does not amount to a major failure.

In addition to your guarantees under the Australian Consumer Law, our goods also come with a contractual warranty, which is described below. This warranty is additional to your rights under the Australian Consumer Law (and any other rights or remedies you may have under a law in relation to the products) and is not intended to modify or exclude those rights.

Subject to the terms of this contractual warranty, if your Atom products are defective, we will (at our election) repair or replace the Atom products. Once we make this election (and take the relevant action), we will have honored our obligations under this contractual warranty.

Our total liability under this warranty is limited to the cost of repair or replacement of the defective product (at our election). We otherwise exclude all liability in relation to the product to the fullest extent permitted by law (noting our comments above regarding the Australian Consumer Law and any other rights or remedies you may have).

If you wish to claim under this warranty, you must, at your own expense, return the product or that part of the product which you believe is defective, together with proof of original purchase, your name, address and telephone number and a certificate of installation (or other document required by the law for the installation of electrical products in the place in which the product was installed) to Evolt at the address set out on this catalogue, within the warranty period. You bear all costs associated with claiming under this warranty (including, but not limited to, postage costs).

Without limiting the preceding sentence, this warranty does not apply to the costs of the removal or re-installation of the defective product.

The warranty period for this product is three years from the date of purchase. This warranty is not transferable and is only given to the original purchaser of the product, provided the purchaser has purchased the product from us. Proof of purchase must be provided to us with any warranty claim. We recommend that you attach your proof of purchase to your product manual.

This warranty does not apply to consumable items within your product (including, but not limited to, lamps or batteries). This warranty does not apply to products that have been improperly stored, installed, or used. This warranty does not apply to products that have not been maintained in accordance with the instructions contained within this product manual.

This warranty does not apply to loss or damage caused by wear and tear, misuse, incorrect installation or operation, failure to clean and maintain, incorrect voltage or non-authorized electrical connections, adverse external conditions (such as power surges and dips, acts of God, exposure to heat, corrosion, insect or vermin infestation), use of non-authorized or defective parts or globes, or to items that have been repaired than by a person other than us or a repairer approved by us.

TERMS & CONDITIONS OF SALE

Unless otherwise agreed to in writing, all goods (“Goods”) sold or offered for sale by Evolt Pty. Ltd ACN 112 123 529 ABN 83 112 123 529 (hereinafter referred to as “Evolt”) are done so subject to the following conditions:

PRICES

PRICES:

All prices are quoted excluding GST, and any GST applicable will be charged to the Buyer on a Tax Invoice (as defined in the GST Act).

QUOTATIONS:

Quotation pricing is valid for three (3) months.

DELIVERY

Late delivery or non-delivery due to any circumstances or events beyond Evolt’s control shall not constitute a breach of contract by Evolt and Evolt shall not be liable for any loss or damage howsoever arising through such late delivery or non-delivery. The choice of the carrier and method of transport remains with Evolt, unless transport is paid for by the Buyer.

WARRANTIES

THE WARRANTIES:

Subject to paragraphs 4 and 5, unless otherwise agreed between the parties in writing, Goods manufactured, or sold, by Evolt under any of its’ Brand Names, are warranted against faulty materials and/or workmanship for (1) one year from date of delivery.

CONDITIONS OF WARRANTY

The warranties set out in paragraph 3 are subject to compliance with the following conditions:

Goods must be used and handled with due care, under normal operating conditions and in accordance with the Relevant Standards and good practices.

Goods must be mounted, installed and connected with due care and in accordance with the Relevant Standards and good practices.

Goods must be returned to Evolt’s local office within 14 days of the detection of the alleged fault in their then current condition. Wilfully damaged or defaced Goods are excluded from this warranty.

Evolt reserves the right to request that the complete piece of equipment containing the allegedly faulty component be returned to Evolt for inspection and testing.

In the case of any dispute under this warranty, Evolt reserves the right to obtain the opinion of a suitably qualified independent expert whose opinion as to any question of fact under this warranty shall be binding on the parties.

LIMITATION OF LIABILITY

Evolt will not be liable for any loss or damage incurred by the Buyer or End User for Goods damaged as a result of negligence, alteration, accident, use of the Goods in a way which is not in compliance with the Relevant Standards or use of the Goods in any way for which the Goods were not designed or approved by Evolt or as a result of improper fitting, repair or replacement.

The liability of Evolt in respect of faulty materials or workmanship shall, at the option of Evolt, be limited to one of the following:

the replacement of the Goods;

the supply of equivalent Goods;

the repair of the Goods; or

the payment of the cost of having the Goods repaired.

Evolt will not be liable for any special indirect or consequential damage arising out of the supply of the Goods.

If a claim is made by a Buyer or End User under one of the warranties set out in paragraph 4, Evolt will not accept any claim for costs, charges or expenses incurred by the Buyer or End User in relation to replacement, supply or repair of the Goods.

Except for any warranties and conditions which cannot be excluded under any Act, all warranties and conditions with regard to the Goods sold which are implied by common law, statute or trade usage are excluded to the full extent legally permissible.

PAYMENTS

Unless otherwise agreed to in writing, all invoices are net payable thirty (30) days following the month of delivery to Evolt’s head office. All payments received by Evolt must, in all cases, be allocated to the oldest account due for payment.

RETURN OF GOODS

Goods will not be accepted for return without prior written consent from Evolt. Goods manufactured to Buyer’s requirements and/or specification cannot be returned for credit. Please see attachment for more details.

LOCATION OF CONTRACT (LEGAL DOMICILE)

Any contract with Evolt shall be deemed to have been executed and entered into in the State of New South Wales, Australia and the same shall be construed enforced and performed in accordance with the laws thereof. Any proceedings shall be brought and heard in the courts of the State of New South Wales.

TITLE AND RISK

Evolt supplies Goods on condition that, property in the Goods does not pass to the Buyer until they have been paid in full and Evolt has been paid for all other moneys then owing to Evolt by the Buyer.

notwithstanding paragraph 11.1, the Goods are at the risk of the Buyer as soon as they have been delivered to or into the custody of the Buyer or the Buyer's agent.

until property in the Goods passes to the Buyer under paragraph 11.1, the Goods are merely entrusted to the Buyer as fiduciary and Evolt remains the legal and beneficial owner of the Goods with full power to re-sell and regain possession of them if the Buyer defaults in payment of the purchase price.

if the Buyer defaults in payment of the purchase price or if the Buyer becomes insolvent, Evolt and/or its authorised agents may at any time without notice to the Buyer enter onto the Buyer's premises and any other premises at which the Goods are situated including but not limited to the Buyer's premises or the End Users Premises for the purpose of recovering possession of them. The Buyer agrees to indemnify the Seller against all costs, losses and expenses (including without limitation legal costs) incurred by the Seller as a result of or in connection with any default or breach of these Terms and Conditions of Sale by the Buyer.

if the Buyer receives any proceeds from the sale of the Goods from any other party, the Buyer receives those proceeds on trust for Evolt to be applied in payment of the purchase price for the Goods and shall remit such sum forthwith to Evolt. All such payments received by Evolt shall be allocated to the oldest account due for payment.

CONFLICT WITH BUYER'S TERMS

If any purchase order or other trading terms of the Buyer conflict with or are inconsistent with any of Evolt's terms and conditions of sale, then Evolt's terms and conditions of sale as amended from time to time prevail and will apply notwithstanding any conflicting or inconsistent terms of the Buyer. The Buyer acknowledges that the sale by Evolt of any Goods will not constitute acceptance of any conditions of purchase of the Buyer which conflict or are inconsistent with any of Evolt's terms and conditions of sale, even where Evolt acknowledges the Buyer's conditions prior to, upon or by delivery of Goods.

NON-WAIVER

A waiver by Evolt with respect to any breach or default by the Buyer shall not constitute a continuing waiver of any other breach or default or of any other right or remedy. A failure or delay by Evolt in exercising a right or remedy does not operate as a waiver of that right or remedy.

VARIATION

A variation of these Terms and Conditions of Sale shall be ineffective unless it is in writing and signed by Evolt.

SEVERABILITY

If a Court determines that a condition or part of these conditions is unenforceable, illegal or void then it shall be severed and the remainder of these Terms and Conditions of Sale shall remain operative.

DEFINITIONS

In these Terms and Conditions of Sale the following terms shall have the following meanings:

"Brand Names" means "Evolt", "Ektor"; "Atom", **"WiZ"**.

"Buyer" means the buyer of the Goods;

"End User" means a person or business which purchases or uses Goods supplied directly or indirectly by the Buyer;

"Goods and Services Tax" or **"GST"** has the same meaning as given in the GST Act;

"GST Act" means the A New Tax System (Goods and Services Tax) Act 1999 (Commonwealth);

"Relevant Standards" means the relevant International Organisation for Standardisation ("ISO") standard and the relevant International Electro technical Commission ("IEC") standard applicable to the Goods.

ACKNOWLEDGMENT & INDEMNITY

The Buyer shall, in every instance where the Goods are being purchased from Evolt for an End User or the Goods are on sold to an End User,;

ensure either by inclusion into any contract between the Buyer and the End User or otherwise that the End User is aware of and agrees to these Terms and Conditions upon which Evolt supplies the Goods, and

indemnifies and agrees to keep indemnified Evolt from all claims, demands, suits and liabilities whatsoever and howsoever arising whether in tort or in contract that may be made by End Users regarding the Goods.



evolt

sales@evolt.com.au

PO Box 271

Kingsgrove NSW 1480

evolt.com.au