

Alienware m15 R7

Service Manual

Notes, cautions, and warnings

 **NOTE:** A NOTE indicates important information that helps you make better use of your product.

 **CAUTION:** A CAUTION indicates either potential damage to hardware or loss of data and tells you how to avoid the problem.

 **WARNING:** A WARNING indicates a potential for property damage, personal injury, or death.

Contents

| | |
|---|-----------|
| Chapter 1: Working inside your computer | 5 |
| Before working inside your computer..... | 5 |
| Safety instructions..... | 5 |
| Electrostatic discharge—ESD protection..... | 6 |
| ESD field service kit | 6 |
| Transporting sensitive components..... | 7 |
| After working inside your computer..... | 7 |
| | |
| Chapter 2: Removing and installing components | 9 |
| Recommended tools..... | 9 |
| Screw list..... | 9 |
| Major components of Alienware m15 R7..... | 10 |
| Disassembly and reassembly | 12 |
| Base cover..... | 12 |
| Solid-state drive..... | 17 |
| Memory..... | 27 |
| Wireless card..... | 29 |
| Rear-I/O cover..... | 32 |
| Battery..... | 34 |
| Battery cable..... | 36 |
| Speakers..... | 38 |
| Power-adaptor port..... | 39 |
| Touchpad..... | 41 |
| Display assembly..... | 44 |
| Keyboard-controller board..... | 48 |
| System board..... | 50 |
| Fan and heat-sink assembly..... | 56 |
| Ethernet and audio board..... | 59 |
| USB board..... | 60 |
| Power button..... | 62 |
| Palm-rest and keyboard assembly..... | 64 |
| | |
| Chapter 3: Drivers and downloads | 67 |
| | |
| Chapter 4: System setup | 68 |
| BIOS overview..... | 68 |
| Entering BIOS setup program..... | 68 |
| Navigation keys..... | 68 |
| Boot Sequence..... | 68 |
| System setup options..... | 69 |
| System and setup password..... | 79 |
| Assigning a system setup password..... | 79 |
| Deleting or changing an existing system setup password..... | 80 |
| Clearing CMOS settings..... | 80 |

| | |
|--|-----------|
| Clearing BIOS (System Setup) and System passwords..... | 80 |
| Updating the BIOS..... | 81 |
| Updating the BIOS in Windows..... | 81 |
| Updating the BIOS using the USB drive in Windows..... | 81 |
| Updating the BIOS from the F12 One-Time boot menu..... | 81 |
| Chapter 5: Troubleshooting..... | 83 |
| Handling swollen Lithium-ion batteries..... | 83 |
| SupportAssist diagnostics..... | 83 |
| System-diagnostic lights..... | 84 |
| Recovering the operating system..... | 85 |
| Backup media and recovery options..... | 85 |
| WiFi power cycle..... | 85 |
| Drain residual flea power (perform hard reset)..... | 85 |
| Chapter 6: Getting help and contacting Alienware..... | 87 |

Working inside your computer

Before working inside your computer

About this task

 **NOTE:** The images in this document may differ from your computer depending on the configuration you ordered.

Steps

1. Save and close all open files and exit all open applications.

2. Shut down your computer. Click **Start** >  **Power** > **Shut down**.

 **NOTE:** If you are using a different operating system, see the documentation of your operating system for shut-down instructions.

3. Disconnect your computer and all attached devices from their electrical outlets.

4. Disconnect all attached network devices and peripherals, such as keyboard, mouse, and monitor from your computer.

 **CAUTION:** To disconnect a network cable, first unplug the cable from your computer and then unplug the cable from the network device.

5. Remove any media card and optical disc from your computer, if applicable.

Safety instructions

Use the following safety guidelines to protect your computer from potential damage and to ensure your personal safety. Unless otherwise noted, each procedure included in this document assumes that you have read the safety information that shipped with your computer.

 **WARNING:** Before working inside your computer, read the safety information that is shipped with your computer. For more safety best practices, see the Regulatory Compliance home page at www.dell.com/regulatory_compliance.

 **WARNING:** Disconnect your computer from all power sources before opening the computer cover or panels. After you finish working inside the computer, replace all covers, panels, and screws before connecting your computer to an electrical outlet.

 **CAUTION:** To avoid damaging the computer, ensure that the work surface is flat, dry, and clean.

 **CAUTION:** To avoid damaging the components and cards, handle them by their edges, and avoid touching the pins and the contacts.

 **CAUTION:** You should only perform troubleshooting and repairs as authorized or directed by the Dell technical assistance team. Damage due to servicing that is not authorized by Dell is not covered by your warranty. See the safety instructions that is shipped with the product or at www.dell.com/regulatory_compliance.

 **CAUTION:** Before touching anything inside your computer, ground yourself by touching an unpainted metal surface, such as the metal at the back of the computer. While you work, periodically touch an unpainted metal surface to dissipate static electricity which could harm internal components.

 **CAUTION:** When you disconnect a cable, pull it by its connector or its pull tab, not the cable itself. Some cables have connectors with locking tabs or thumbscrews that you must disengage before disconnecting the cable. When disconnecting cables, keep them evenly aligned to avoid bending the connector pins. When connecting cables, ensure that the ports and the connectors are correctly oriented and aligned.

 **CAUTION:** Press and eject any installed card from the media-card reader.

⚠ CAUTION: Exercise caution when handling Lithium-ion batteries in laptops. Swollen batteries should not be used and should be replaced and disposed properly.

i NOTE: The color of your computer and certain components may appear differently than shown in this document.

Electrostatic discharge—ESD protection

ESD is a major concern when you handle electronic components, especially sensitive components such as expansion cards, processors, memory DIMMs, and system boards. Very slight charges can damage circuits in ways that may not be obvious, such as intermittent problems or a shortened product life span. As the industry pushes for lower power requirements and increased density, ESD protection is an increasing concern.

Due to the increased density of semiconductors used in recent Dell products, the sensitivity to static damage is now higher than in previous Dell products. For this reason, some previously approved methods of handling parts are no longer applicable.

Two recognized types of ESD damage are catastrophic and intermittent failures.

- **Catastrophic** – Catastrophic failures represent approximately 20 percent of ESD-related failures. The damage causes an immediate and complete loss of device functionality. An example of catastrophic failure is a memory DIMM that has received a static shock and immediately generates a "No POST/No Video" symptom with a beep code emitted for missing or nonfunctional memory.
- **Intermittent** – Intermittent failures represent approximately 80 percent of ESD-related failures. The high rate of intermittent failures means that most of the time when damage occurs, it is not immediately recognizable. The DIMM receives a static shock, but the tracing is merely weakened and does not immediately produce outward symptoms related to the damage. The weakened trace may take weeks or months to melt, and in the meantime may cause degradation of memory integrity, intermittent memory errors, etc.

The more difficult type of damage to recognize and troubleshoot is the intermittent (also called latent or "walking wounded") failure.

Perform the following steps to prevent ESD damage:

- Use a wired ESD wrist strap that is properly grounded. The use of wireless anti-static straps is no longer allowed; they do not provide adequate protection. Touching the chassis before handling parts does not ensure adequate ESD protection on parts with increased sensitivity to ESD damage.
- Handle all static-sensitive components in a static-safe area. If possible, use anti-static floor pads and workbench pads.
- When unpacking a static-sensitive component from its shipping carton, do not remove the component from the anti-static packing material until you are ready to install the component. Before unwrapping the anti-static packaging, ensure that you discharge static electricity from your body.
- Before transporting a static-sensitive component, place it in an anti-static container or packaging.

ESD field service kit

The unmonitored Field Service kit is the most commonly used service kit. Each Field Service kit includes three main components: anti-static mat, wrist strap, and bonding wire.

Components of an ESD field service kit

The components of an ESD field service kit are:

- **Anti-Static Mat** – The anti-static mat is dissipative and parts can be placed on it during service procedures. When using an anti-static mat, your wrist strap should be snug and the bonding wire should be connected to the mat and to any bare metal on the system being worked on. Once deployed properly, service parts can be removed from the ESD bag and placed directly on the mat. ESD-sensitive items are safe in your hand, on the ESD mat, in the system, or inside a bag.
- **Wrist Strap and Bonding Wire** – The wrist strap and bonding wire can be either directly connected between your wrist and bare metal on the hardware if the ESD mat is not required, or connected to the anti-static mat to protect hardware that is temporarily placed on the mat. The physical connection of the wrist strap and bonding wire between your skin, the ESD mat, and the hardware is known as bonding. Use only Field Service kits with a wrist strap, mat, and bonding wire. Never use wireless wrist straps. Always be aware that the internal wires of a wrist strap are prone to damage from normal wear and tear, and must be checked regularly with a wrist strap tester in order to avoid accidental ESD hardware damage. It is recommended to test the wrist strap and bonding wire at least once per week.
- **ESD Wrist Strap Tester** – The wires inside of an ESD strap are prone to damage over time. When using an unmonitored kit, it is a best practice to regularly test the strap prior to each service call, and at a minimum, test once per week. A wrist strap tester is the

best method for doing this test. If you do not have your own wrist strap tester, check with your regional office to find out if they have one. To perform the test, plug the wrist-strap's bonding-wire into the tester while it is strapped to your wrist and push the button to test. A green LED is lit if the test is successful; a red LED is lit and an alarm sounds if the test fails.

- **Insulator Elements** – It is critical to keep ESD sensitive devices, such as plastic heat sink casings, away from internal parts that are insulators and often highly charged.
- **Working Environment** – Before deploying the ESD Field Service kit, assess the situation at the customer location. For example, deploying the kit for a server environment is different than for a desktop or portable environment. Servers are typically installed in a rack within a data center; desktops or portables are typically placed on office desks or cubicles. Always look for a large open flat work area that is free of clutter and large enough to deploy the ESD kit with additional space to accommodate the type of system that is being repaired. The workspace should also be free of insulators that can cause an ESD event. On the work area, insulators such as Styrofoam and other plastics should always be moved at least 12 inches or 30 centimeters away from sensitive parts before physically handling any hardware components
- **ESD Packaging** – All ESD-sensitive devices must be shipped and received in static-safe packaging. Metal, static-shielded bags are preferred. However, you should always return the damaged part using the same ESD bag and packaging that the new part arrived in. The ESD bag should be folded over and taped shut and all the same foam packing material should be used in the original box that the new part arrived in. ESD-sensitive devices should be removed from packaging only at an ESD-protected work surface, and parts should never be placed on top of the ESD bag because only the inside of the bag is shielded. Always place parts in your hand, on the ESD mat, in the system, or inside an anti-static bag.
- **Transporting Sensitive Components** – When transporting ESD sensitive components such as replacement parts or parts to be returned to Dell, it is critical to place these parts in anti-static bags for safe transport.

ESD protection summary

It is recommended that all field service technicians use the traditional wired ESD grounding wrist strap and protective anti-static mat at all times when servicing Dell products. In addition, it is critical that technicians keep sensitive parts separate from all insulator parts while performing service and that they use anti-static bags for transporting sensitive components.

Transporting sensitive components

When transporting ESD sensitive components such as replacement parts or parts to be returned to Dell, it is critical to place these parts in anti-static bags for safe transport.

Lifting equipment

Adhere to the following guidelines when lifting heavy weight equipment:

 **CAUTION: Do not lift greater than 50 pounds. Always obtain additional resources or use a mechanical lifting device.**

1. Get a firm balanced footing. Keep your feet apart for a stable base, and point your toes out.
2. Tighten stomach muscles. Abdominal muscles support your spine when you lift, offsetting the force of the load.
3. Lift with your legs, not your back.
4. Keep the load close. The closer it is to your spine, the less force it exerts on your back.
5. Keep your back upright, whether lifting or setting down the load. Do not add the weight of your body to the load. Avoid twisting your body and back.
6. Follow the same techniques in reverse to set the load down.

After working inside your computer

About this task

 **CAUTION: Leaving stray or loose screws inside your computer may severely damage your computer.**

Steps

1. Replace all screws and ensure that no stray screws remain inside your computer.
2. Connect any external devices, peripherals, or cables you removed before working on your computer.
3. Replace any media cards, discs, or any other parts that you removed before working on your computer.

4. Connect your computer and all attached devices to their electrical outlets.
5. Turn on your computer.

Removing and installing components

NOTE: The images in this document may differ from your computer depending on the configuration you ordered.

Recommended tools

The procedures in this document may require the following tools:

- Phillips screwdriver #0
- Plastic scribe

Screw list

NOTE: When removing screws from a component, it is recommended to note the screw type, the quantity of screws, and then place them in a screw storage box. This is to ensure that the correct number of screws and correct screw type is restored when the component is replaced.

NOTE: Some computers have magnetic surfaces. Ensure that the screws are not left attached to such surfaces when replacing a component.

NOTE: Screw color may vary with the configuration ordered.

Table 1. Screw list























| Component | Screw type | Quantity | Screw image |
|--|-------------------------|----------|---|
| Base cover | M2.5x14 (captive screw) | 4 |  |
| Base cover | M2.5x5 | 4 |  |
| 2230 or 2280 solid-state drive in SSD Slot one | M2x4 | 2 |  |
| 2230 or 2280 solid-state drive in SSD Slot two | M2x4 | 2 |  |
| Wireless-card bracket | M2x4 | 1 |  |
| Rear I/O cover | M2x2 | 3 |  |
| Rear I/O cover | M2.5x5 | 2 |  |
| Battery | M2x4 | 4 |  |
| Battery | M2x3 | 1 |  |
| Power-adaptor port-bracket | M2x4 | 2 |  |

Table 1. Screw list (continued)

| Component | Screw type | Quantity | Screw image |
|----------------------------|----------------|----------|---|
| Display-assembly hinges | M2.5x5 | 6 |  |
| Touchpad bracket | M2.5x2.5 | 2 |  |
| Touchpad | M2x2 | 2 |  |
| Keyboard-controller board | M2x2 | 1 |  |
| Type-C bracket | M2x4 | 2 |  |
| System board | M2x4 | 7 |  |
| System board | M2x2 | 2 |  |
| Fan and heat-sink assembly | M2x4 (captive) | 6 |  |
| Left-I/O board | M2x4 | 2 |  |
| Right-I/O board | M2x4 | 3 |  |
| Rear I/O cover | M2x4 | 2 |  |
| Rear I/O cover | M2.5x5 | 2 |  |
| Power button | M2x2 | 3 |  |

Major components of Alienware m15 R7

The following image shows the major components of Alienware m15 R7.

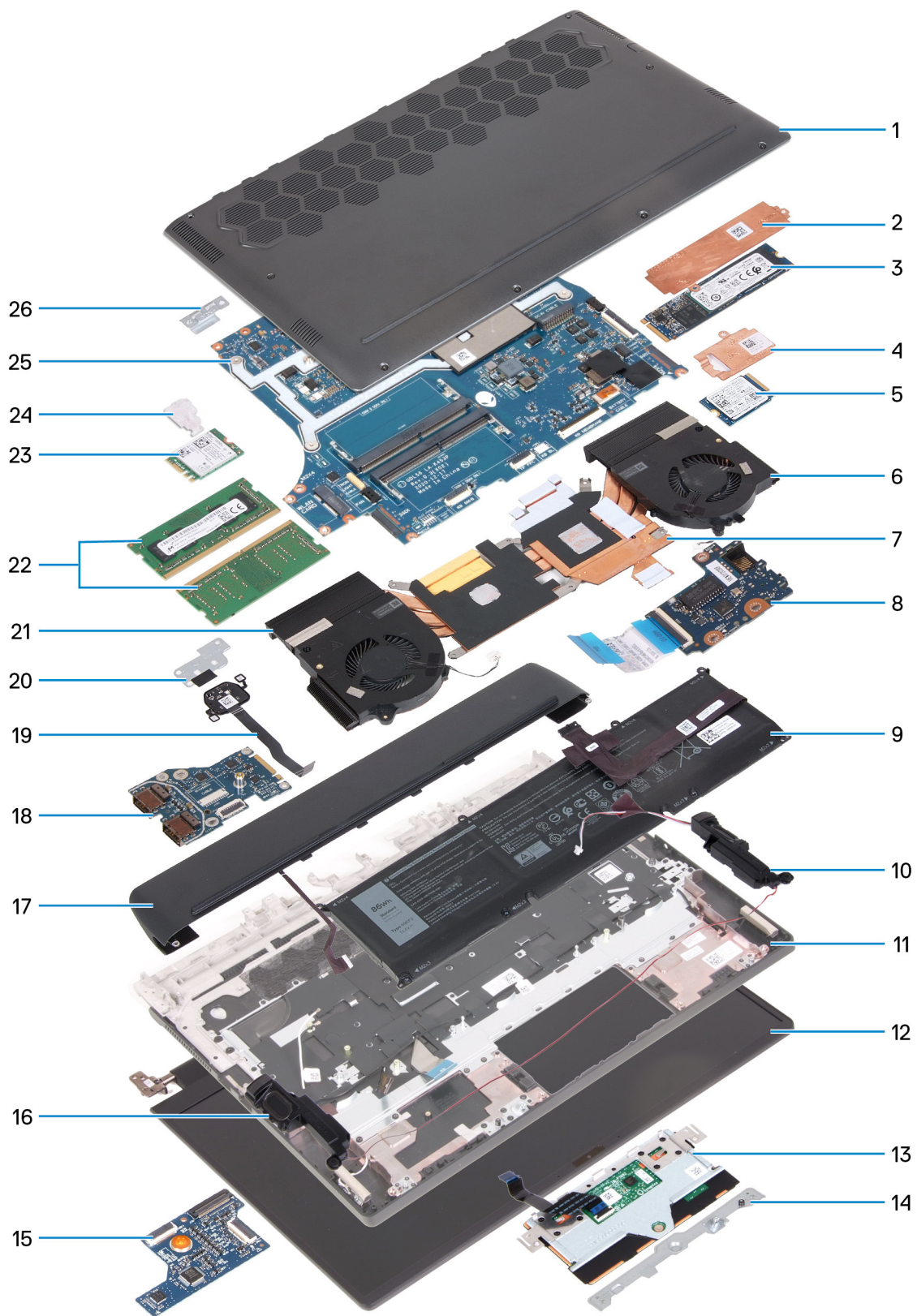

1. Base cover
2. 2280 solid-state drive thermal shield
3. 2280 solid-state drive
4. 2230 solid-state drive thermal shield
5. 2230 solid-state drive
6. Left fan

7. Heat sink
8. Right-I/O board
9. Battery
10. Left speaker
11. Palm-rest and keyboard assembly
12. Display assembly
13. Touchpad
14. Touchpad bracket
15. Keyboard-controller board
16. Right speaker
17. Rear-I/O cover
18. Left-I/O board
19. Power button
20. Power-button bracket
21. Right fan
22. Memory modules
23. Wireless card
24. Wireless-card bracket
25. System board
26. Type-C bracket

i **NOTE:** Dell provides a list of components and their part numbers for the original system configuration purchased. These parts are available according to warranty coverages purchased by the customer. Contact your Dell sales representative for purchase options.

Disassembly and reassembly

i **NOTE:** The images in this document may differ from your computer depending on the configuration you ordered.

Base cover

Removing the base cover

Prerequisites

1. Follow the procedure in [Before working inside your computer](#).

About this task

The following image(s) indicate the location of the base cover and provides a visual representation of the removal procedure.



4x
M2.5x5



4x

1



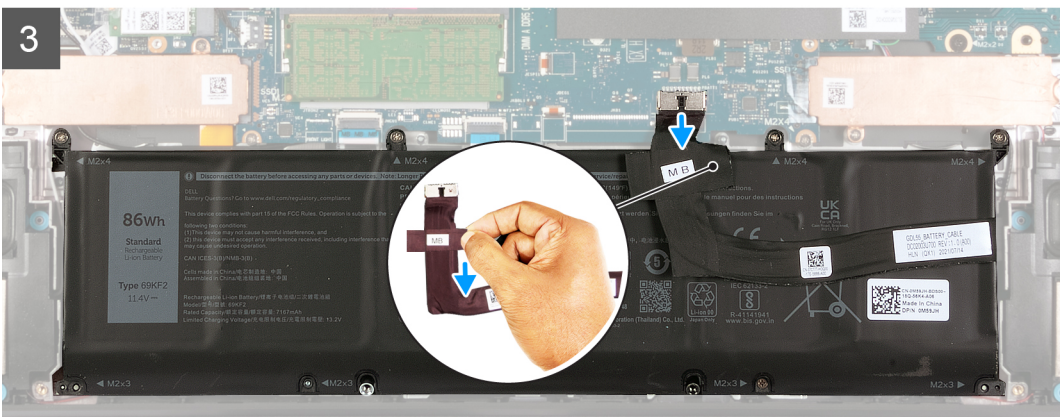
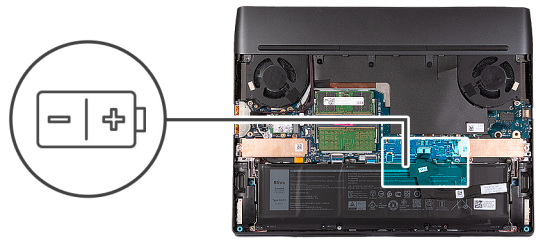
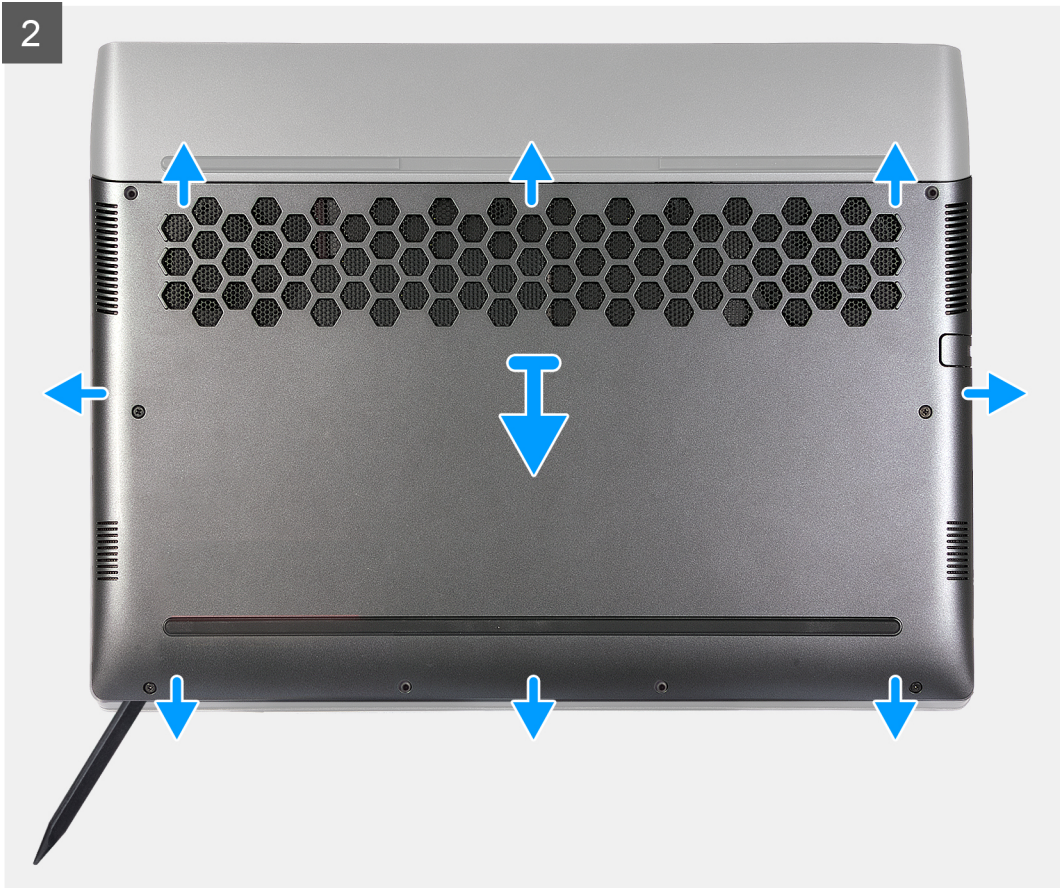



Steps

1. Remove the four screws (M2.5x5) that secure the base cover to the palm-rest and keyboard assembly.
2. Loosen the four captive screws that secure the base cover to the palm-rest and keyboard assembly.
3. Using a plastic scribe, pry the base cover from the bottom left and continue to work on the sides to open the base cover.
4. Slide and lift the base cover off the palm-rest and keyboard assembly.
5. Peel the tape that secures the battery cable to the battery.
6. Disconnect the battery cable from the system board.
7. Turn over the computer and open the display.
8. Press and hold the power button for 20 seconds to ground the computer and drain the flea power.

Installing the base cover

Prerequisites

If you are replacing a component, remove the existing component before performing the installation process.

About this task

The following image(s) indicate the location of the base cover and provides a visual representation of the installation procedure.

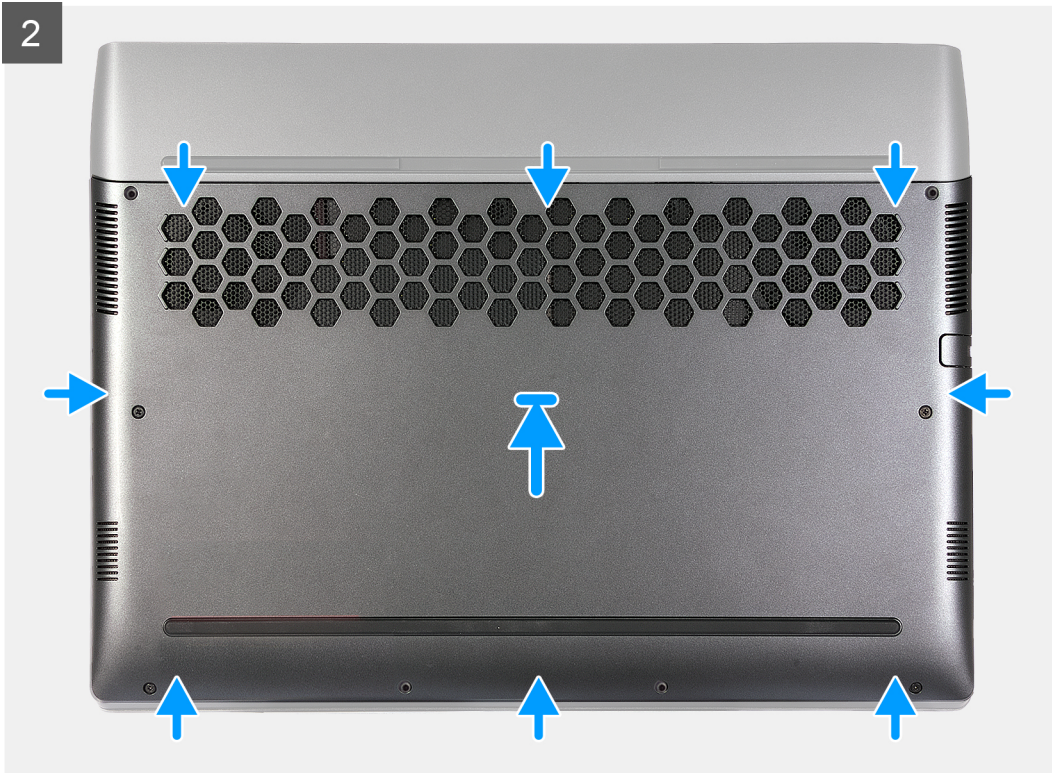
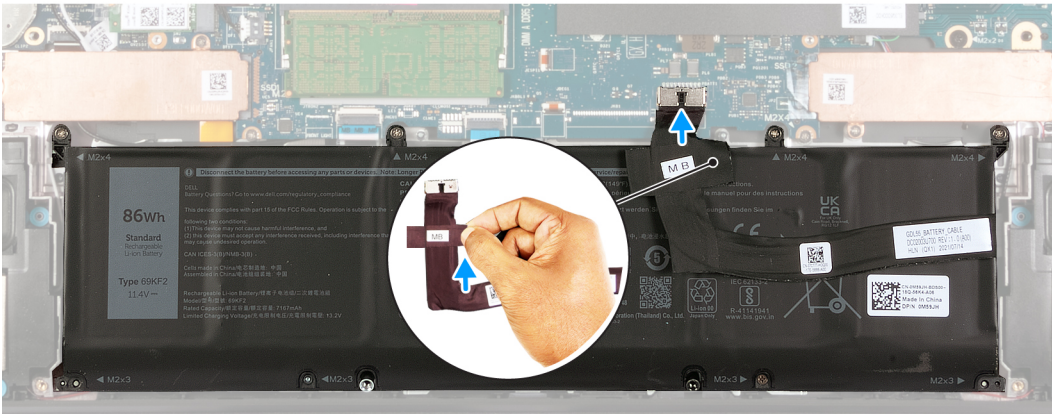
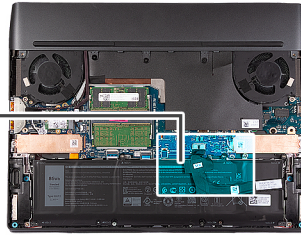
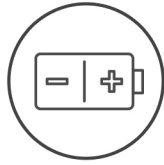

3



Steps

1. Connect the battery cable to the system board.
2. Adhere the tape that secures the battery cable to the battery.
3. Slide the tabs on the top of the base cover under the rear I/O-cover and snap the base cover to the palm-rest and keyboard assembly.
4. Tighten the four captive screws on the base cover that secure the base cover to the palm-rest and keyboard assembly.
5. Replace the four screws (M2.5x5) that secure the base cover to the palm-rest and keyboard assembly.

Next steps

1. Follow the procedure in [After working inside your computer](#).

Solid-state drive

Removing the 2230 solid-state drive in slot one

Prerequisites

1. Follow the procedure in [Before working inside your computer](#).
2. Remove the [base cover](#).

About this task

- i** **NOTE:** This procedure applies only to computers shipped with an 2230 solid-state drive installed in M.2 slot one (SSD1).
- i** **NOTE:** The M.2 card installed on M.2 slot one (SSD1) will depend on the configuration ordered. Supported card configurations:
- 2230 solid-state drive
 - 2280 solid-state drive

The following image(s) indicate the location of the 2230 solid-state drive in slot one and provides a visual representation of the removal procedure.



2x
M2x4

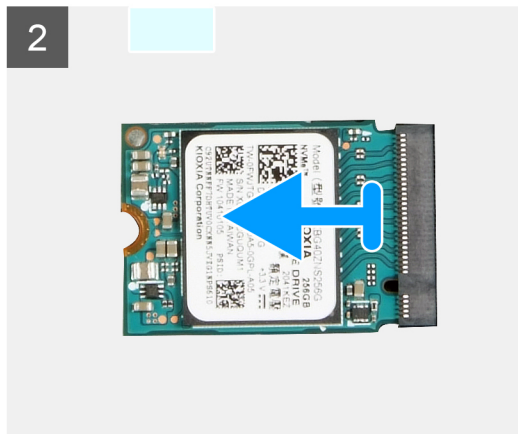
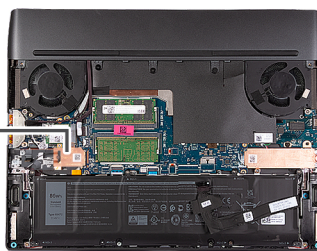

Steps

1. Remove the two screws (M2x4) that secure the 2230 thermal shield to the palm-rest and keyboard assembly.
2. Slide and remove the 2230 thermal shield off the solid-state drive.
3. Slide and remove the 2230 solid-state drive from the solid-state drive slot.

Installing the 2230 solid-state drive in slot one

Prerequisites

If you are replacing a component, remove the existing component before performing the installation process.

About this task

NOTE: This procedure applies if you are installing a 2230 solid-state drive into M.2 slot one (SSD1).

NOTE: Supported card configurations on M.2 slot one (SSD1):

- 2230 solid-state drive
- 2280 solid-state drive

The following image(s) indicate the location of the 2230 solid-state drive in slot one and provides a visual representation of the installation procedure.



2x
M2x4

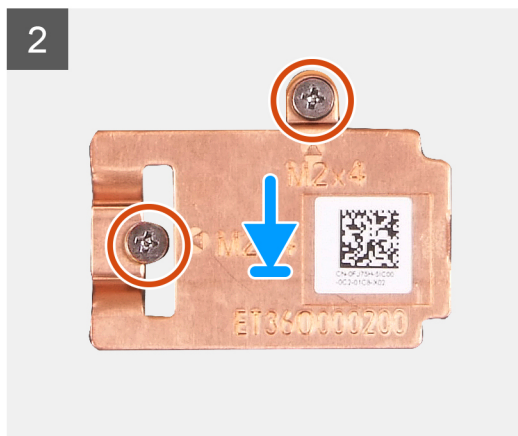
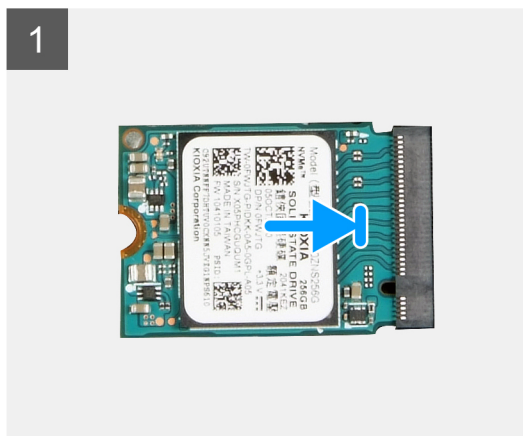
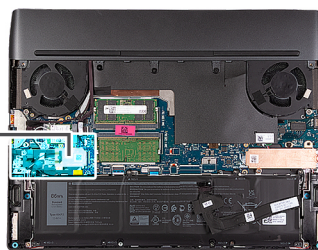

Steps

1. Align the notch on the 2230 solid-state drive with the tab on the M.2 card slot on the system board.
2. Slide the 2230 solid-state drive into the M.2 card slot on the system board.
3. Align and place the solid-state drive thermal shield on the solid-state drive.
4. Align the screw hole on the solid-state drive thermal shield with the screw hole on the solid-state drive and palm-rest and keyboard assembly.
5. Replace the two screws (M2x4) that secure the 2230 thermal shield to the palm-rest and keyboard assembly.

Next steps

1. Install the [base cover](#).
2. Follow the procedure in [After working inside your computer](#).

Removing the 2280 solid-state drive in slot one

Prerequisites

1. Follow the procedure in [Before working inside your computer](#).
2. Remove the [base cover](#).

About this task

- ⓘ **NOTE:** This procedure applies only to computers shipped with an 2280 solid-state drive installed in M.2 slot one (SSD1).
- ⓘ **NOTE:** The M.2 card installed on M.2 slot one (SSD1) will depend on the configuration ordered. Supported card configurations:
 - 2230 solid-state drive
 - 2280 solid-state drive

The following image(s) indicate the location of the 2280 solid-state drive in slot one and provides a visual representation of the removal procedure.



2x
M2x4

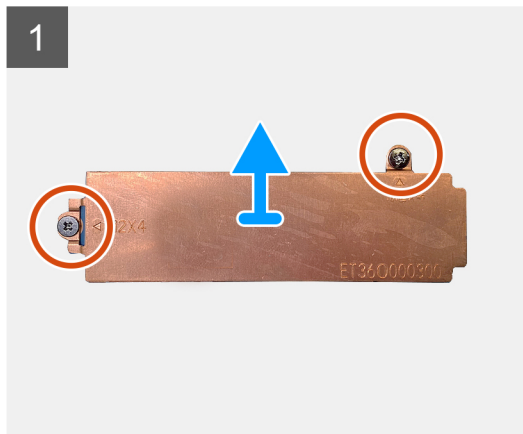
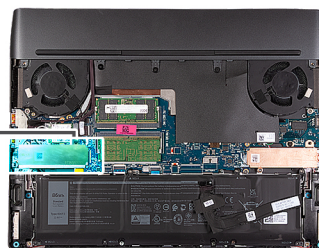

Steps

1. Remove the two screws (M2x4) that secure the 2280 thermal shield to the palm-rest and keyboard assembly.
2. Lift the 2280 thermal shield off the solid-state drive.
3. Slide and remove the 2280 solid-state drive from the solid-state drive slot.

Installing the 2280 solid-state drive in slot one

Prerequisites

If you are replacing a component, remove the existing component before performing the installation process.

About this task

NOTE: This procedure applies if you are installing a 2280 solid-state drive into M.2 slot one (SSD1).

NOTE: Supported card configurations on M.2 slot one (SSD1):

- 2230 solid-state drive
- 2280 solid-state drive

The following image(s) indicate the location of the 2280 solid-state drive in slot one and provides a visual representation of the installation procedure.

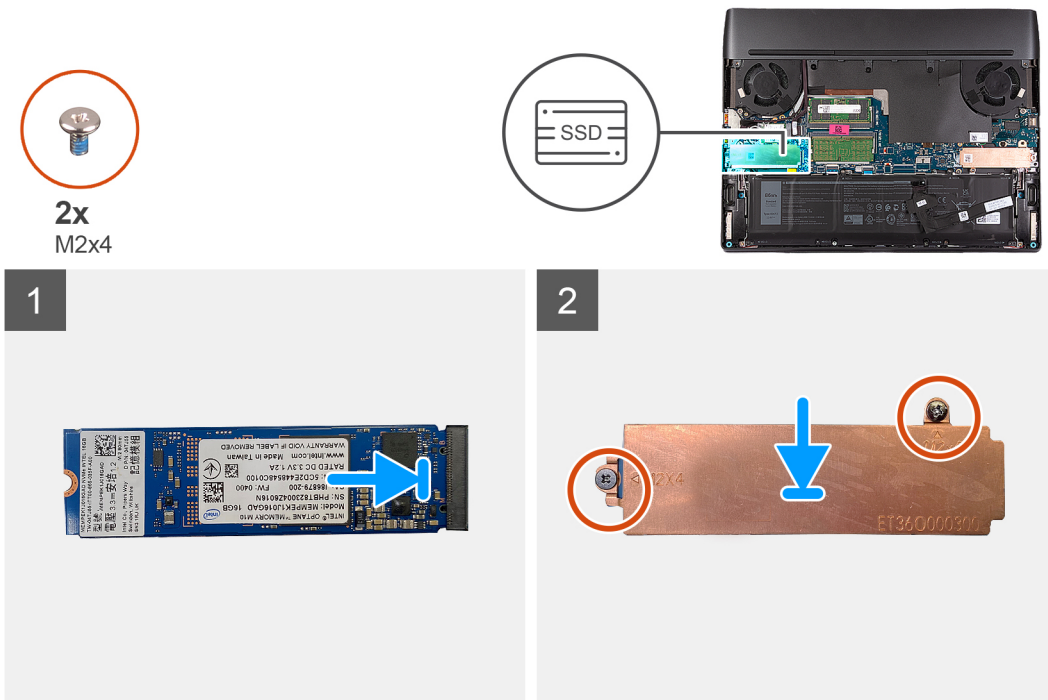

Steps

1. Align the notch on the 2280 solid-state drive with the tab on the M.2 card slot on the system board.
2. Slide the 2280 solid-state drive into the M.2 card slot on the system board.
3. Slide the tab on the 2280 thermal shield into the M.2 card slot and align the screw holes on the thermal shield to the screw holes on the palm-rest and keyboard assembly.
4. Replace the screws (M2x4) that secure the 2280 thermal shield to the palm-rest and keyboard assembly.
5. Replace the two screws (M2x4) that secure the 2280 thermal shield to the palm-rest and keyboard assembly.

Next steps

1. Install the [base cover](#).
2. Follow the procedure in [After working inside your computer](#).

Procedure to move the screw mount in SSD slot one

About this task

This computer supports two solid-state drive form factors in SSD slot one:

- M.2 2230
- M.2 2280

If you are replacing the current solid-state drive in SSD slot one, with another solid-state drive that is of a different form factor, see the following procedure to move the location of the screw mount in SSD slot one.

Steps

1. Slide to remove the screw mount from the palm-rest and keyboard assembly.
2. Slide the screw mount into the other screw mount slot on the palm-rest and keyboard assembly.

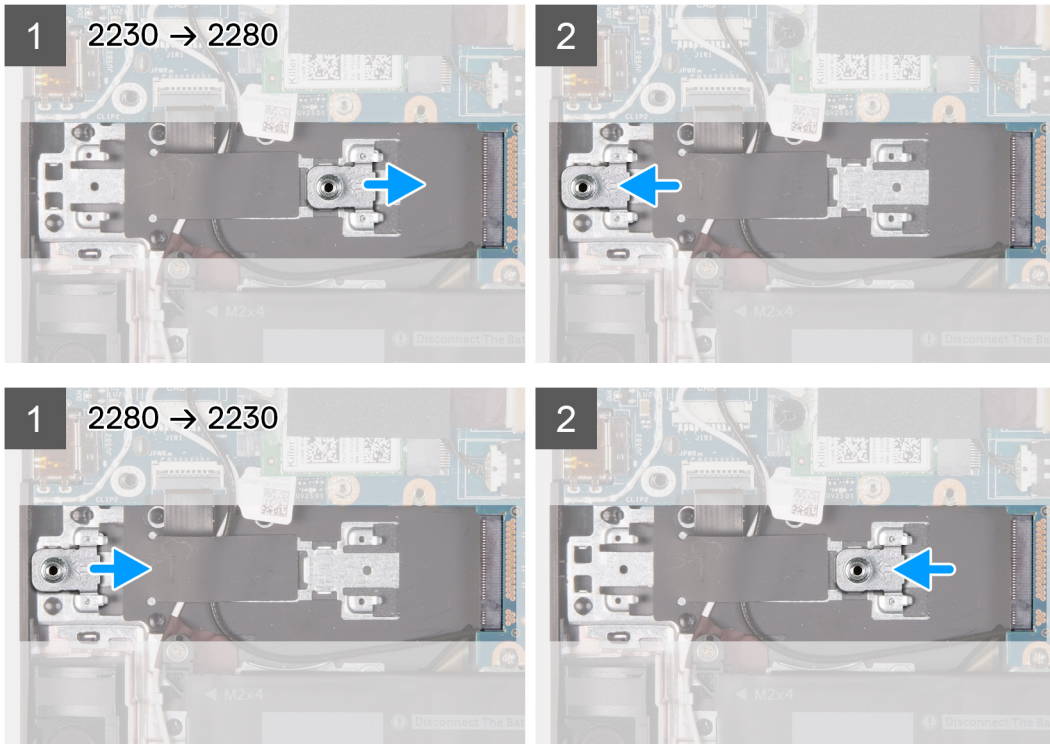

3. To install a 2230 solid-state drive in SSD slot one, see [installing the 2230 solid-state drive in SSD slot one](#).
4. To install a 2280 solid-state drive in SSD slot one, see [installing the 2280 solid-state drive in SSD slot one](#).

Removing the 2230 solid-state drive in slot two

Prerequisites

1. Follow the procedure in [Before working inside your computer](#).
2. Remove the [base cover](#).

About this task

- ⓘ **NOTE:** This procedure applies only to computers shipped with an 2230 solid-state drive installed in M.2 slot two (SSD2).
- ⓘ **NOTE:** The M.2 card installed on M.2 slot two (SSD2) will depend on the configuration ordered. Supported card configurations:
 - 2230 solid-state drive
 - 2280 solid-state drive
- ⓘ **NOTE:** Only computers shipped with a NVIDIA GeForce 3060/3070 Ti/3080 Ti graphics card can have a solid-state drive installed in M.2 slot two (SSD2).

The following image(s) indicate the location of the 2230 solid-state drive in slot two and provides a visual representation of the removal procedure.

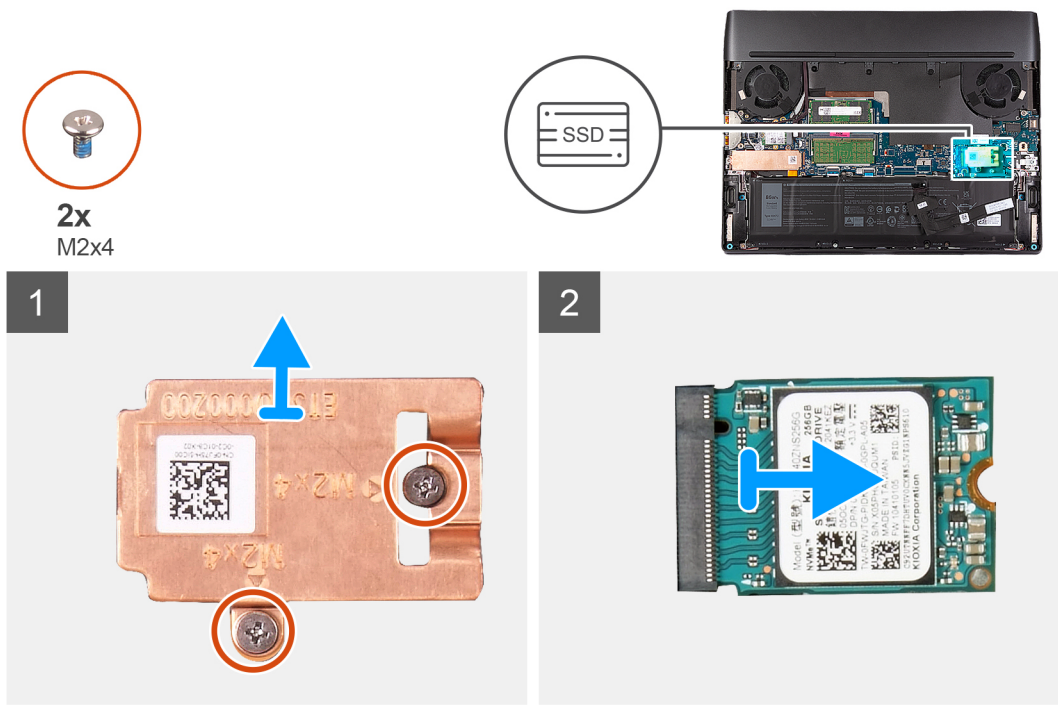

Steps

1. Remove the two screws (M2x4) that secure the 2230 thermal shield to the palm-rest and keyboard assembly.
2. Slide and remove the 2230 thermal shield off the solid-state drive.
3. Slide and remove the 2230 solid-state drive from the solid-state drive slot.

Installing the 2230 solid-state drive in slot two

Prerequisites

If you are replacing a component, remove the existing component before performing the installation process.

About this task

- ⓘ **NOTE:** This procedure applies if you are installing a M.2 2230 solid-state drive into M.2 slot two (SSD2).
- ⓘ **NOTE:** Supported card configurations on M.2 slot two (SSD2):
 - M.2 2230 solid-state drive
 - M.2 2280 solid-state drive
- ⓘ **NOTE:** You may only install a solid-state drive in M.2 slot 2 (SSD2) for computers shipped with a NVIDIA GeForce 3060/3070 Ti/3080 Ti.

The following image(s) indicate the location of the 2230 solid-state drive in slot two and provides a visual representation of the installation procedure.



2x
M2x4

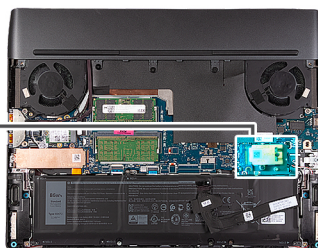

Steps

1. Align the notch on the M.2 2230 solid-state drive with the tab on the M.2 card slot on the system board.
2. Slide the M.2 2230 solid-state drive into the M.2 card slot on the system board.
3. Align and place the solid-state drive thermal shield on the solid-state drive.
4. Align the screw hole on the solid-state drive thermal shield with the screw hole on the solid-state drive and palm-rest and keyboard assembly.
5. Replace the two screws (M2x4) that secure the 2230 thermal shield to the palm-rest and keyboard assembly.

Next steps

1. Install the [base cover](#).
2. Follow the procedure in [After working inside your computer](#).

Removing the 2280 solid-state drive in slot two

Prerequisites

1. Follow the procedure in [Before working inside your computer](#).
2. Remove the [base cover](#).

About this task

- NOTE:** This procedure applies only to computers shipped with a 2280 solid-state drive installed in M.2 slot two (SSD2).
- NOTE:** The M.2 card installed on M.2 slot two (SSD2) will depend on the configuration ordered. Supported card configurations:
 - 2230 solid-state drive
 - 2280 solid-state drive
- NOTE:** Only computers shipped with a NVIDIA GeForce 3060/3070 Ti/3080 Ti graphics card can have a solid-state drive installed in M.2 slot two (SSD2).

The following image(s) indicate the location of the 2280 solid-state drive in slot two and provides a visual representation of the removal procedure.



2x
M2x4

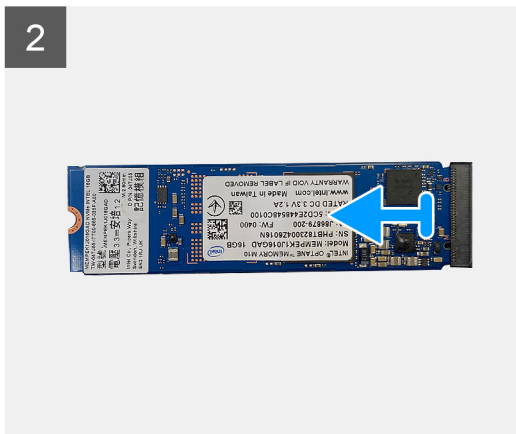
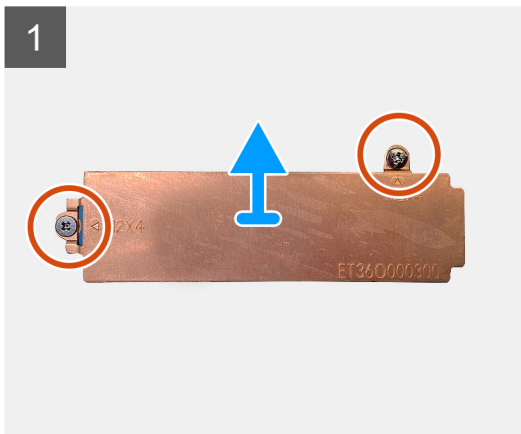
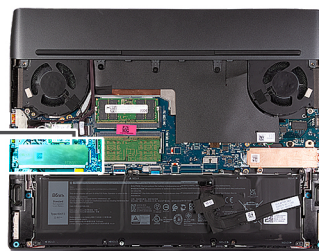

Steps

1. Remove the two screws (M2x4) that secure the 2280 thermal shield to the palm-rest and keyboard assembly.
2. Lift the 2280 thermal shield off the solid-state drive.
3. Slide and remove the 2280 solid-state drive from the solid-state drive slot.

Installing the 2280 solid-state drive in slot two

Prerequisites

If you are replacing a component, remove the existing component before performing the installation process.

About this task

- NOTE:** This procedure applies if you are installing a M.2 2280 solid-state drive into M.2 slot two (SSD2).
- NOTE:** Supported card configurations on M.2 slot two (SSD2):
 - M.2 2230 solid-state drive
 - M.2 2280 solid-state drive
- NOTE:** You may only install a solid-state drive in M.2 slot 2 (SSD2) for computers shipped with a NVIDIA GeForce 3060/3070 Ti/3080 Ti.

The following image(s) indicate the location of the 2280 solid-state drive in slot two and provides a visual representation of the installation procedure.

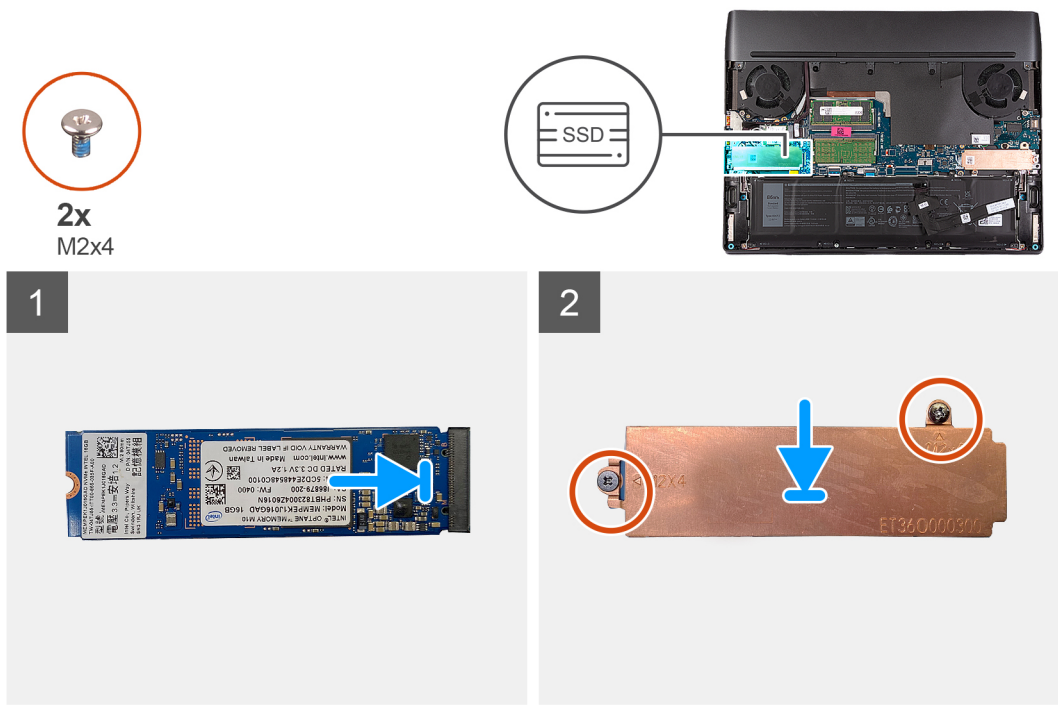

Steps

1. Align the notch on the M.2 2280 solid-state drive with the tab on the M.2 card slot on the system board.
2. Slide the M.2 2280 solid-state drive into the M.2 card slot on the system board.
3. Slide the tab on the 2280 thermal shield into the M.2 card slot and align the screw holes on the thermal shield to the screw holes on the palm-rest and keyboard assembly.
4. Replace the screws (M2x4) that secure the 2280 thermal shield to the palm-rest and keyboard assembly.
5. Replace the two screws (M2x4) that secure the 2280 thermal shield to the palm-rest and keyboard assembly.

Next steps

1. Install the [base cover](#).
2. Follow the procedure in [After working inside your computer](#).

Procedure to move the screw mount in SSD slot two

About this task

This computer supports two solid-state drive form factors in SSD slot two:

- M.2 2230
- M.2 2280

If you are replacing the current solid-state drive in SSD slot two, with another solid-state drive that is of a different form factor, see the following procedure to move the location of the screw mount in SSD slot two.

Steps

1. Slide to remove the screw mount from the palm-rest and keyboard assembly.
2. Slide the screw mount into the other screw mount slot on the palm-rest and keyboard assembly.

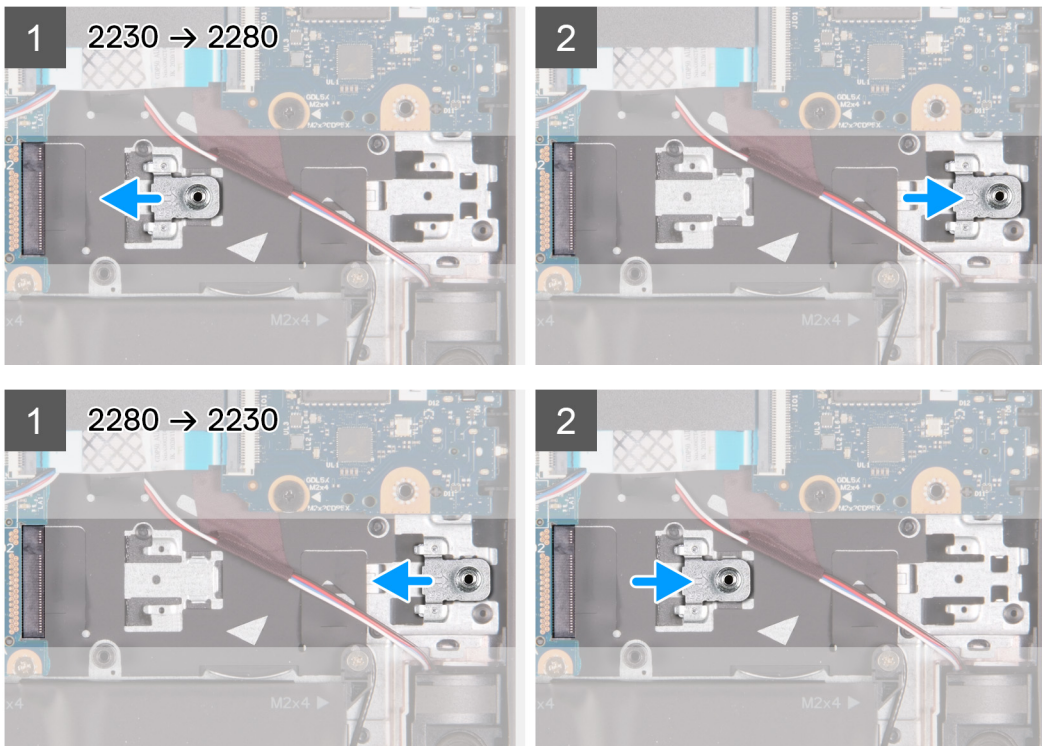

3. To install a 2230 solid-state drive in SSD slot two, see [installing the 2230 solid-state drive in SSD slot two](#).
4. To install a 2280 solid-state drive in SSD slot two, see [installing the 2280 solid-state drive in SSD slot two](#).

Memory

Removing the memory

Prerequisites

1. Follow the procedure in [Before working inside your computer](#).
2. Remove the [base cover](#).

About this task

NOTE: This computer may have up to two memory modules installed.

The following image(s) indicate the location of the memory and provides a visual representation of the removal procedure.

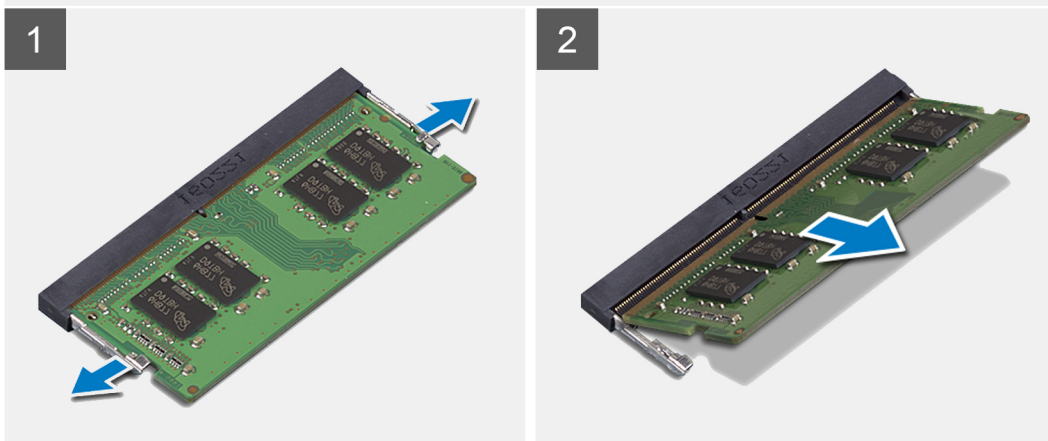
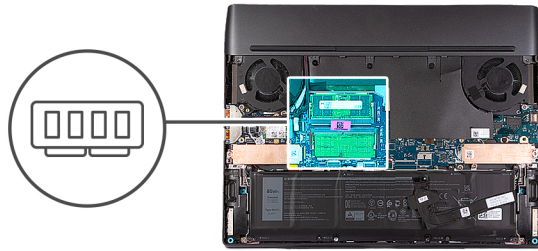

Steps

1. Use your fingertips to carefully spread apart the securing-clips on each end of the memory-module slot until the memory module pops up.
2. Slide and remove the memory module from the memory-module slot.

⚠ CAUTION: To prevent damage to the memory module, hold the memory module by the edges. Do not touch the components on the memory module.

ⓘ NOTE: Repeat the steps to remove any other memory module installed in your computer.

ⓘ NOTE: Note the slot and the orientation of the memory module in order to replace it in the correct slot.

ⓘ NOTE: If the memory module is difficult to remove, gently ease the memory module back and forth to remove it from the slot.

Installing the memory

Prerequisites

If you are replacing a component, remove the existing component before performing the installation process.

About this task

ⓘ NOTE: Up to two memory modules may be installed into this computer.

The following image(s) indicate the location of the memory and provides a visual representation of the installation procedure.

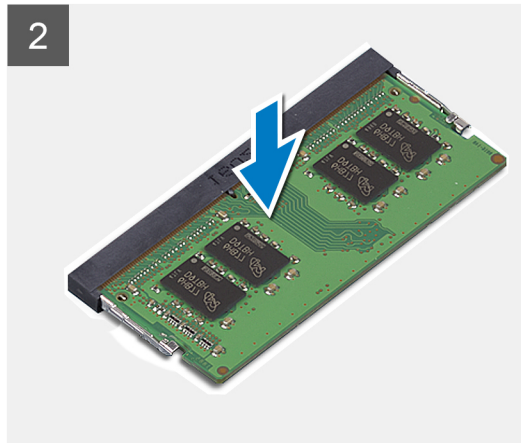
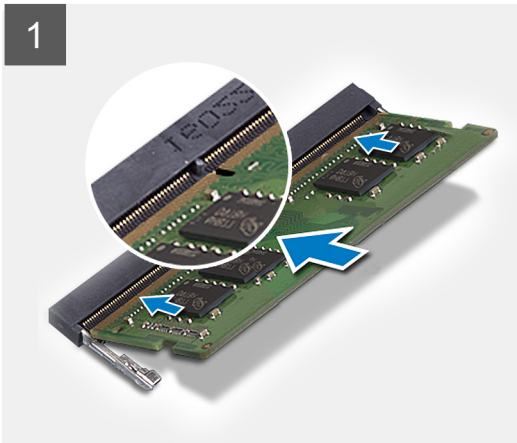
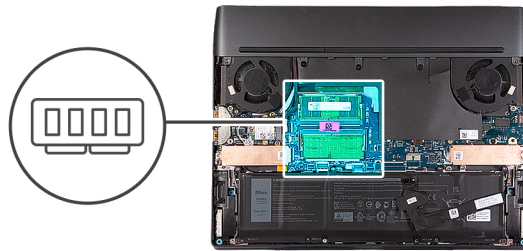

Steps

1. Align the notch on the memory module with the tab on the memory-module slot.
2. Slide the memory module firmly at an angle, into the memory-module slot.
3. Press the memory module down until it clicks into place.

CAUTION: To prevent damage to the memory module, hold the memory module by the edges. Do not touch the components on the memory module.

NOTE: Repeat the steps to install a second memory into your computer.

NOTE: The securing clips return to a locked position. If you do not hear the click, remove the memory module and reinstall it.

Next steps

1. Install the [base cover](#).
2. Follow the procedure in [After working inside your computer](#).

Wireless card

Removing the wireless card

Prerequisites

1. Follow the procedure in [Before working inside your computer](#).
2. Remove the [base cover](#).

About this task

The following image(s) indicate the location of the wireless card and provides a visual representation of the removal procedure.



1x
M2x4

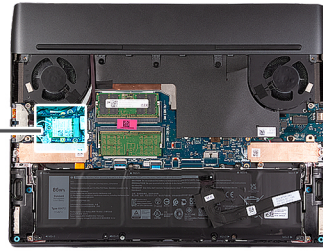

Steps

1. Remove the screw (M2x4) that secures the wireless-card bracket to the wireless card and palm-rest and keyboard assembly.
2. Slide and lift the wireless-card bracket off the wireless card.
3. Disconnect the antenna cables from the wireless card.
4. Slide and remove the wireless card at an angle from the wireless-card slot.

Installing the wireless card

Prerequisites

If you are replacing a component, remove the existing component before performing the installation process.

About this task

The following image(s) indicate the location of the wireless card and provides a visual representation of the installation procedure.



1x
M2x4

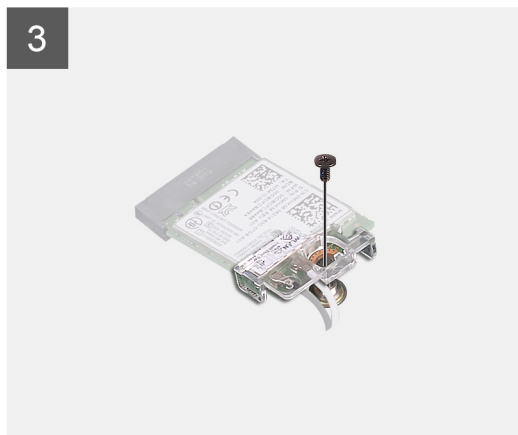
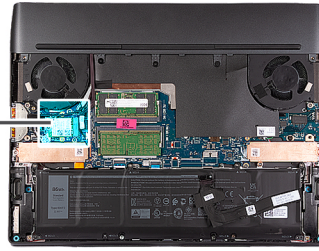

Steps

1. Connect the antenna cables to the wireless card.



NOTE: The following table provides the antenna-cable color scheme for the wireless card that is supported by your computer.

Table 2. Antenna-cable color scheme

| Connectors on the wireless card | Antenna-cable color | Silkscreen marking | |
|---------------------------------|---------------------|--------------------|--------------------|
| Main | White | MAIN | △ (white triangle) |
| Auxiliary | Black | AUX | ▲ (black triangle) |

2. Align and place the wireless-card bracket on the wireless card.
3. Align the notch on the wireless card with the tab on the wireless-card slot and insert the wireless card at an angle into the wireless-card slot.
4. Align the screw hole on the wireless-card bracket with the screw hole on the wireless card and palm-rest and keyboard assembly.
5. Replace the screw (M2x4) that secures the wireless-card bracket to the wireless card and the palm-rest and keyboard assembly.

Next steps

1. Install the [base cover](#).
2. Follow the procedure in [After working inside your computer](#).

Rear-I/O cover

Removing the rear-I/O cover

Prerequisites

1. Follow the procedure in [Before working inside your computer](#).
2. Remove the [base cover](#).

About this task

The following image(s) indicate the location of the rear-I/O cover and provides a visual representation of the removal procedure.

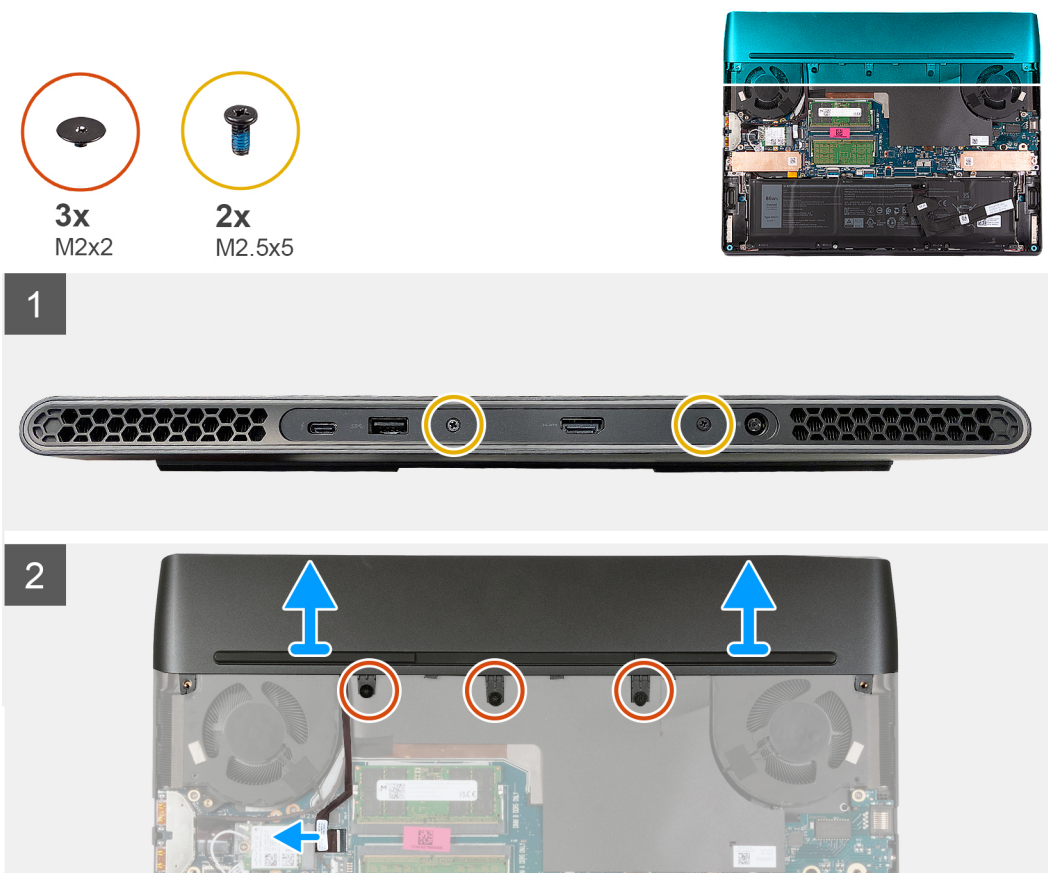

Steps

1. Remove the two screws (M2.5x5) that secure the rear I/O-cover to the palm-rest and keyboard assembly.
2. Remove the three screws (M2x2) that secure the rear I/O-cover to the palm-rest and keyboard assembly.
3. Disconnect the Tron-light cable from the system board.
NOTE: To prevent damaging your computer, ensure that the Tron-light cable has been disconnected from the system board before removing the rear I/O-cover.
4. Firmly grasp the sides of your computer with both hands and push the rubber feet on the rear I/O-cover outwards with your thumbs to release the rear I/O-cover from the palm-rest and keyboard assembly.
5. Remove the rear I/O-cover from the palm-rest and keyboard assembly.

Installing the rear-I/O cover

Prerequisites

If you are replacing a component, remove the existing component before performing the installation process.

About this task

The following image(s) indicate the location of the rear-I/O cover and provides a visual representation of the installation procedure.

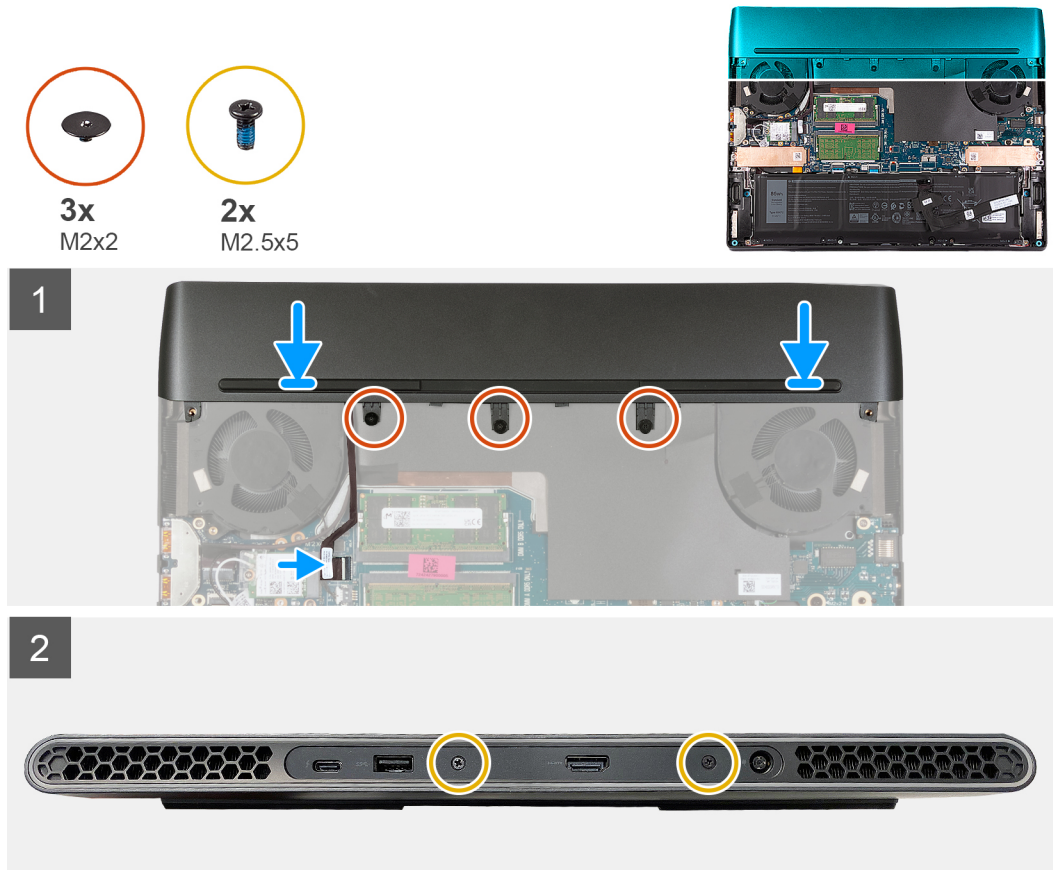

Steps

1. With the correct orientation, slide the rear I/O-cover into the palm-rest and keyboard assembly, and snap it into place.

NOTE: To avoid damaging your computer, ensure the Tron-light cable is not pinched before snapping the rear I/O-cover into place.

2. Replace the three screws (M2x2) that secure the rear I/O-cover to the palm-rest and keyboard assembly.
3. Replace the two screws (M2.5x5) that secure the rear I/O-cover to the palm-rest and keyboard assembly.
4. Connect the Tron-light cable to the system board.

Next steps

1. Install the [base cover](#).
2. Follow the procedure in [After working inside your computer](#).

Battery

Lithium-ion battery precautions

⚠ CAUTION:

- Exercise caution when handling Lithium-ion batteries.
- Discharge the battery completely before removing it. Disconnect the AC power adapter from the system and operate the computer solely on battery power—the battery is fully discharged when the computer no longer turns on when the power button is pressed.
- Do not crush, drop, mutilate, or penetrate the battery with foreign objects.
- Do not expose the battery to high temperatures, or disassemble battery packs and cells.
- Do not apply pressure to the surface of the battery.
- Do not bend the battery.
- Do not use tools of any kind to pry on or against the battery.
- Ensure any screws during the servicing of this product are not lost or misplaced, to prevent accidental puncture or damage to the battery and other system components.
- If the battery gets stuck inside your computer as a result of swelling, do not try to release it as puncturing, bending, or crushing a lithium-ion battery can be dangerous. In such an instance, contact Dell technical support for assistance. See www.dell.com/contactdell.
- Always purchase genuine batteries from www.dell.com or authorized Dell partners and resellers.
- Swollen batteries should not be used and should be replaced and disposed properly. For guidelines on how to handle and replace swollen Lithium-ion batteries, see [Handling swollen Lithium-ion batteries](#).

Removing the battery

Prerequisites

1. Follow the procedure in [Before working inside your computer](#).
2. Remove the [base cover](#).

About this task

- ⓘ **NOTE:** This computer is designed without an RTC coin cell-battery. After a service incident where the computer battery is disconnected, when the battery is fully discharged, or when the computer is reassembled and turned on, an RTC reset cycle will occur. When an RTC Reset cycle occurs, the computer turns on and off three times. An "Invalid Configuration" error message is displayed prompting you to enter the BIOS and configure the date and time. The computer starts functioning normally after setting the date and time.
- ⓘ **NOTE:** Removing the battery resets the BIOS setup program's settings to default. It is recommended that you note the BIOS setup program's settings before removing the battery.

The following image(s) indicate the location of the battery and provides a visual representation of the removal procedure.

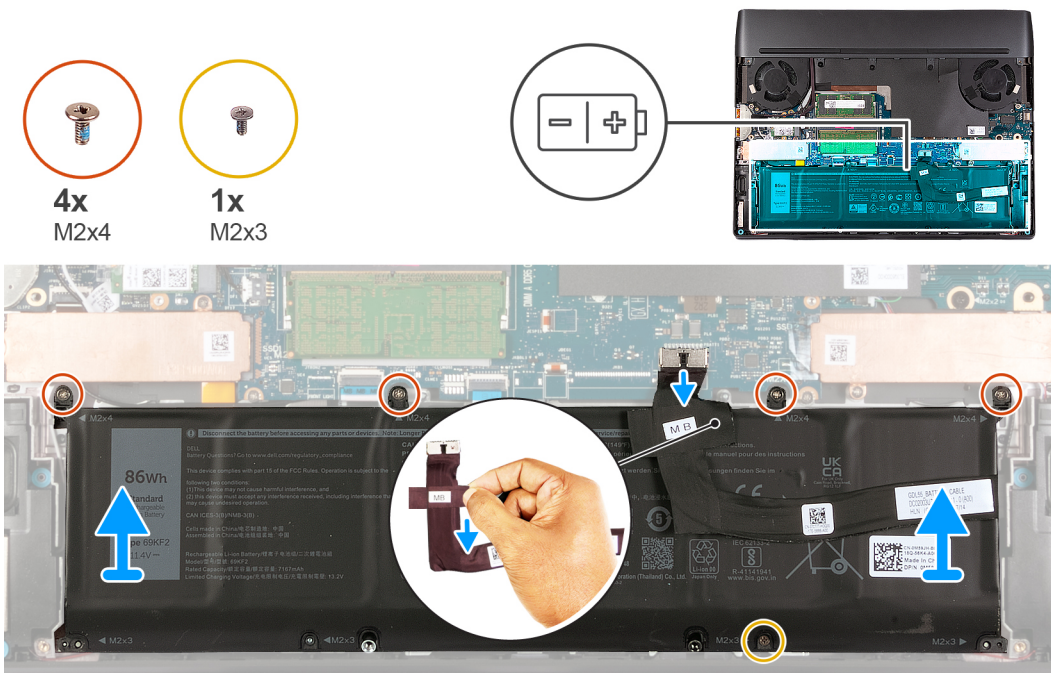

Steps

1. Peel the tape that secures the battery cable to the battery.
2. Disconnect the battery cable from the system board.
 - ⓘ **NOTE:** This step is applicable only if the battery cable has not been disconnected.
3. Remove the four screws (M2x4) that secure the battery to the palm-rest and keyboard assembly.
4. Remove the screw (M2x3) that secures the battery to the palm-rest and keyboard assembly.
5. Lift the battery off the palm-rest and keyboard assembly.

Installing the battery

Prerequisites

If you are replacing a component, remove the existing component before performing the installation process.

About this task

The following image(s) indicate the location of the battery and provides a visual representation of the installation procedure.

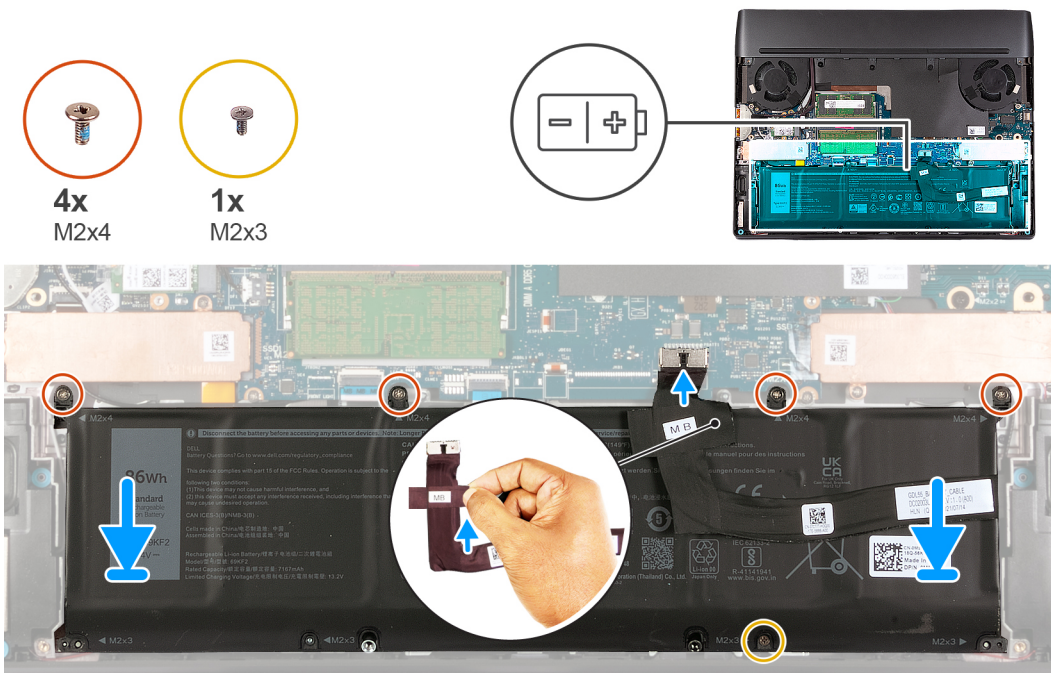

Steps

1. Using the alignment posts, place the battery on the palm-rest and keyboard assembly.
2. Align the screw holes on the battery with the screw holes on the palm-rest and keyboard assembly.
3. Replace the four screws (M2x4) that secure the battery to the palm-rest and keyboard assembly.
4. Replace the screw (M2x3) that secure the battery to the palm-rest and keyboard assembly.
5. Connect the battery cable to the system board.
6. Adhere the tape that secures the battery cable to the battery.

Next steps

1. Install the [base cover](#).
2. Follow the procedure in [After working inside your computer](#).

Battery cable

Removing the battery cable

Prerequisites

1. Follow the procedure in [Before working inside your computer](#).
2. Remove the [base cover](#).
3. Remove the [battery](#).

About this task

NOTE: If the battery is disconnected from system board for service, then there is a delay during boot as the computer undergoes RTC battery reset.

The following image(s) indicate the location of the battery cable and provides a visual representation of the removal procedure.

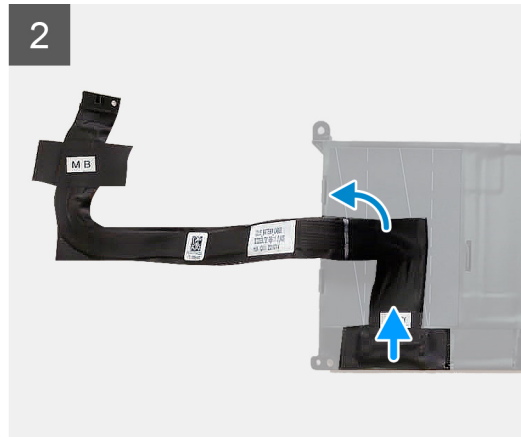
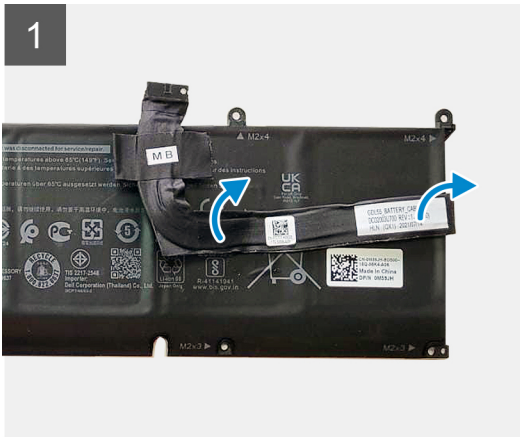

Steps

1. Turn the battery over.
2. Peel the battery cable off the battery.
3. Disconnect the battery cable from the battery.
4. Lift the battery cable off the battery.

Installing the battery cable

Prerequisites

If you are replacing a component, remove the existing component before performing the installation process.

About this task

The following image(s) indicate the location of the battery cable and provides a visual representation of the installation procedure.

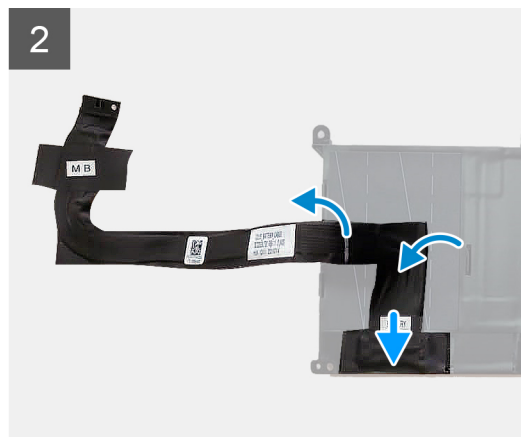
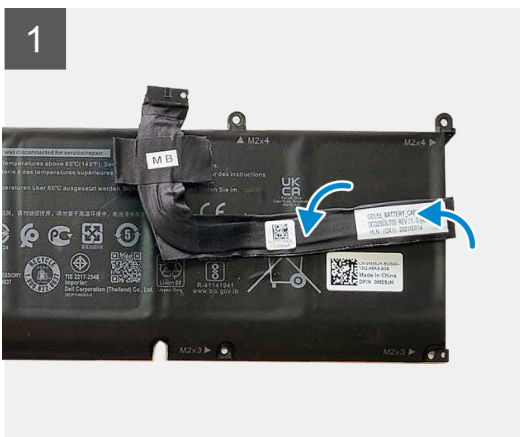

Steps

1. Connect the battery cable to the battery.
2. Adhere the battery cable to the battery.
3. Turn the battery over.

Next steps

1. Install the [battery](#).
2. Install the [base cover](#).
3. Follow the procedure in [After working inside your computer](#).

Speakers

Removing the speakers

Prerequisites

1. Follow the procedure in [Before working inside your computer](#).
2. Remove the [base cover](#).
3. Remove the [battery](#).
4. Remove the [2230 solid-state drive](#) or [2280 solid-state drive](#) in slot two, whichever applicable.

About this task

The following image(s) indicate the location of the speakers and provides a visual representation of the removal procedure.

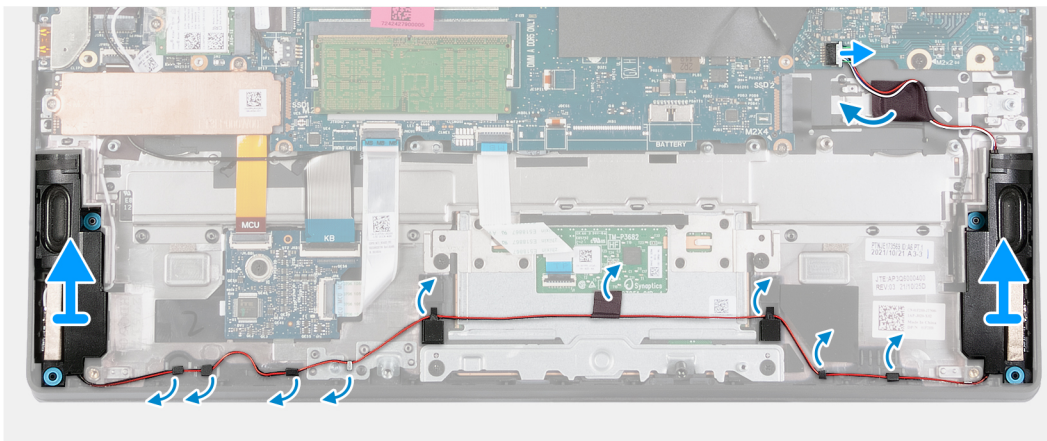
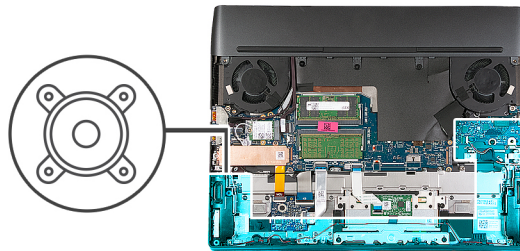

Steps

1. Disconnect the speaker cable from the system board.
2. Peel the tapes that secure the speaker cable to the palm-rest and keyboard assembly.
3. Remove the speaker cable from the routing guides on the palm-rest and keyboard assembly.
4. Lift the right and left speaker, along with its cable, off the palm-rest and keyboard assembly.

Installing the speakers

Prerequisites

If you are replacing a component, remove the existing component before performing the installation process.

About this task

The following image(s) indicate the location of the speakers and provides a visual representation of the installation procedure.

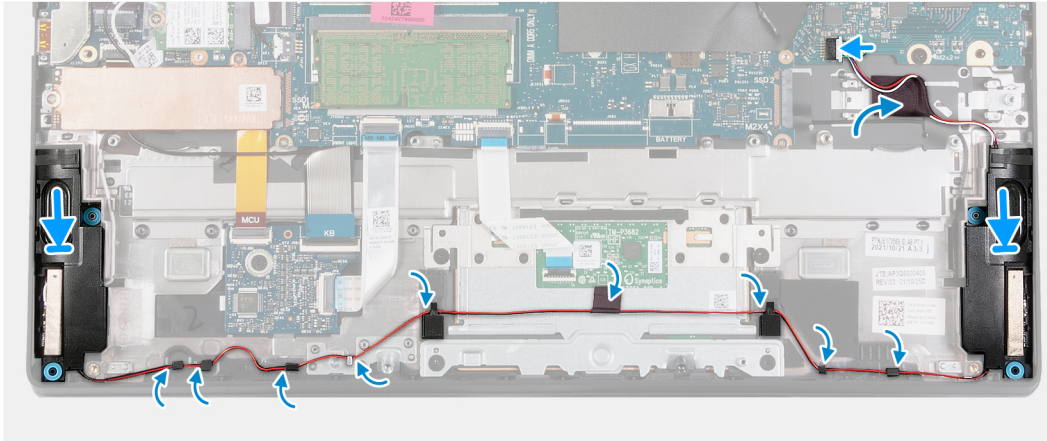
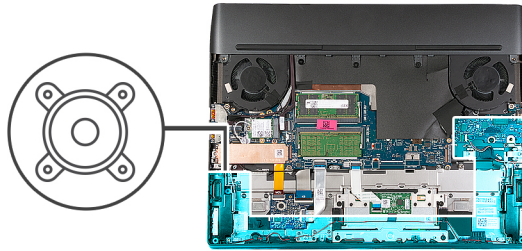

Steps

1. Using the alignment posts, place the left and right speakers into their slots on the palm-rest and keyboard assembly.
 - NOTE:** Ensure that the alignment posts are threaded through the rubber grommets on the speaker.
2. Route the speaker cable through the routing guides on the palm-rest and keyboard assembly.
3. Adhere the tape that secures the speaker cable to the palm-rest and keyboard assembly.
4. Connect the speaker cable to the system board.

Next steps

1. Install the [2230 solid-state drive](#) or [2280 solid-state drive](#) in slot two, whichever applicable.
2. Install the [battery](#).
3. Install the [base cover](#).
4. Follow the procedure in [After working inside your computer](#).

Power-adapter port

Removing the power-adapter port

Prerequisites

1. Follow the procedure in [Before working inside your computer](#).
2. Remove the [base cover](#).
3. Remove the [rear-I/O cover](#).

About this task

The following image(s) indicate the location of the power-adapter port and provides a visual representation of the removal procedure.



2x
M2x4

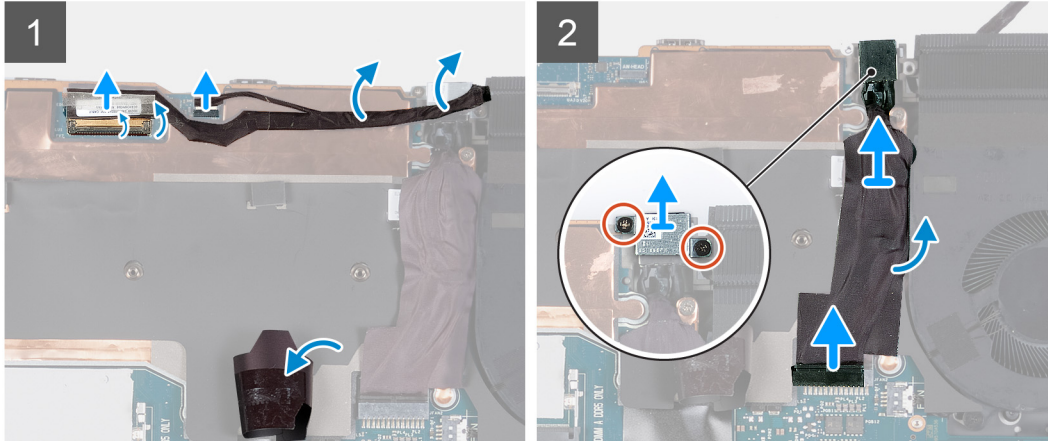
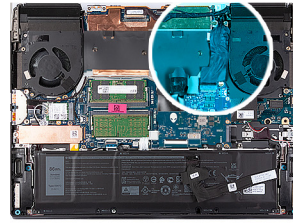

Steps

1. Peel the tape that secures the display-cable connector latch to the system board.
2. Open the latch and disconnect the display cable from the system board.
3. Disconnect the Alien head LED-cable from the system board.
4. Peel the display cable off the system board and move it out of the way.
5. Lift the corner of the Mylar that covers the system board.
6. Remove the two screws (M2x4) that secure the power-adapter port-bracket to the palm-rest and keyboard assembly.
7. Lift the power-adapter port bracket off the palm-rest and keyboard assembly.
8. Disconnect the power-adapter port-cable from the system board.
9. Peel the power-adapter port-cable from the Mylar.

Installing the power-adapter port

Prerequisites

If you are replacing a component, remove the existing component before performing the installation process.

About this task

The following image(s) indicate the location of the power-adapter port and provides a visual representation of the installation procedure.



2x
M2x4

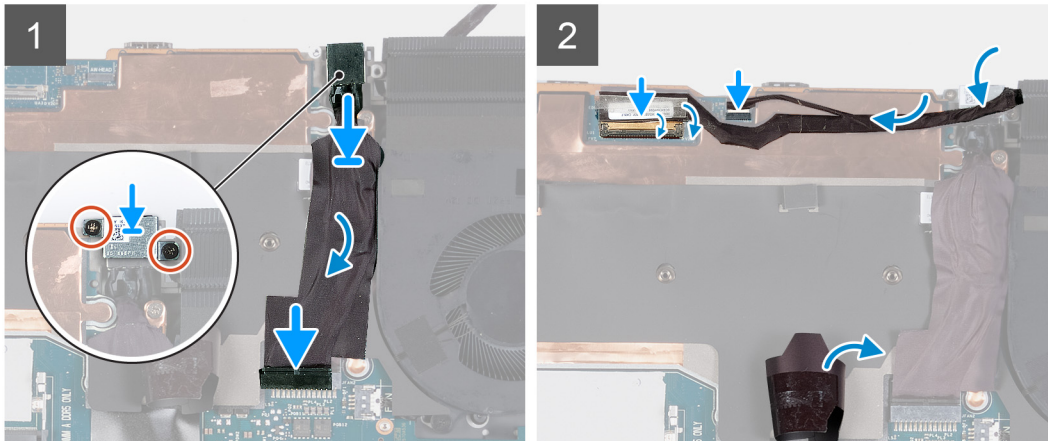
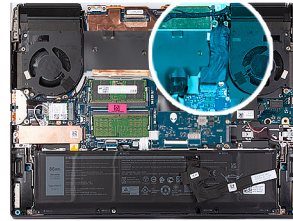

Steps

1. Lift the corner of the Mylar that covers the system board.
2. Slide the power-adapter port at an angle into the slot on the palm-rest and keyboard assembly and adhere the power-adapter port cable to the Mylar.
3. Connect the power-adapter port cable to the system board.
4. Place the power-adapter port bracket on the power-adapter port.
5. Align the screw holes on the power-adapter port bracket to the screw holes on the palm-rest and keyboard assembly.
6. Replace the two screws (M2x4) that secure the power-adapter port bracket to the palm-rest and keyboard assembly.
7. Connect the Alien head LED-cable to the system board.
8. Adhere the display cable to the system board.
9. Connect the display cable to the system board and close the latch to secure the cable.
10. Adhere the tape that secures the display-cable connector latch to the system board.

Next steps

1. Install the [rear-I/O cover](#).
2. Install the [base cover](#).
3. Follow the procedure in [After working inside your computer](#).

Touchpad

Removing the touchpad

Prerequisites

1. Follow the procedure in [Before working inside your computer](#).
2. Remove the [base cover](#).
3. Remove the [battery](#).

About this task

The following image(s) indicate the location of the touchpad and provides a visual representation of the removal procedure.

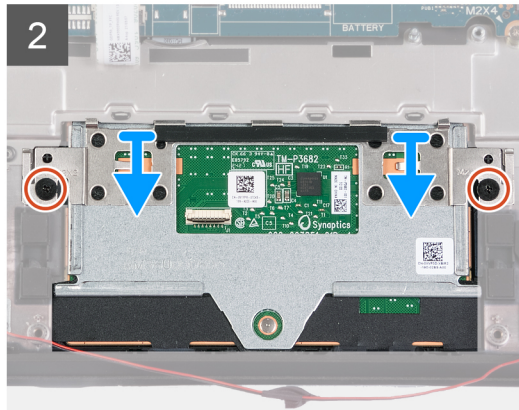
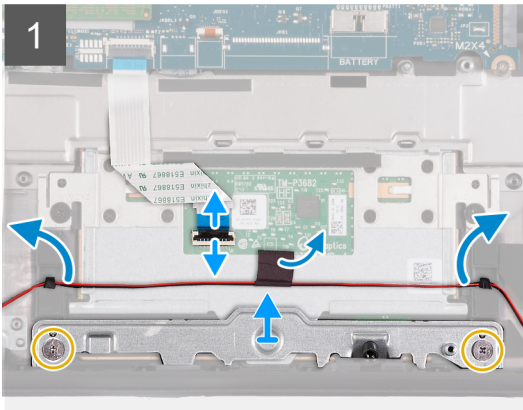
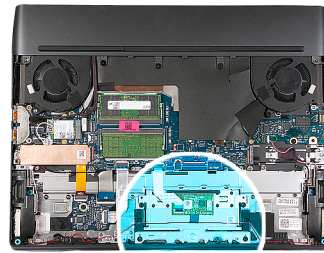
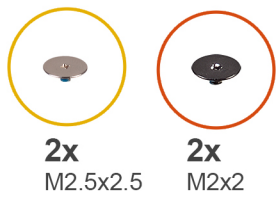

Steps

1. Open the latch and disconnect the touchpad cable from the touchpad.
2. Peel the tape that secures the speaker cable to the touchpad.
3. Remove the speaker cable off the routing guides on the palm-rest and keyboard assembly and move the speaker cable out of the way.
4. Remove the two screws (M2.5x2.5) that secure the touchpad bracket to the palm-rest and keyboard assembly.
5. Lift the touchpad bracket off the palm-rest and keyboard assembly.
6. Remove the two screws (M2x2) that secure the touchpad to the palm-rest and keyboard assembly.
7. Remove the touchpad from the palm-rest and keyboard assembly.

Installing the touchpad

Prerequisites

If you are replacing a component, remove the existing component before performing the installation process.

About this task

The following image(s) indicate the location of the touchpad and provides a visual representation of the installation procedure.

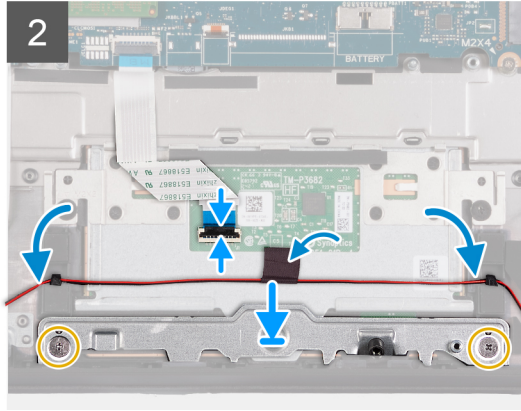
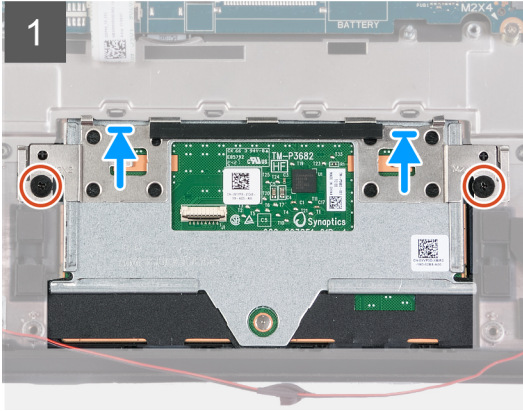
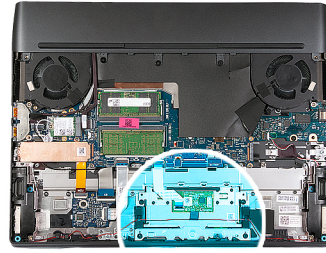
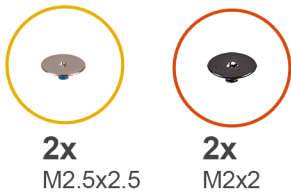

Steps

1. At an angle slide the touchpad into the slot on the palm-rest and keyboard assembly.
2. Turn the computer over and open the display to ensure that the touchpad is equally aligned on all sides.

(i) NOTE: The image below shows the proper touchpad alignment for your computer.

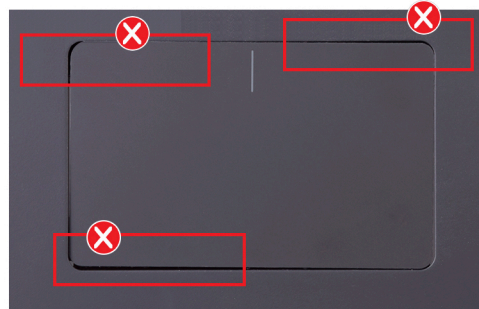

3. Close the display and turn the computer over.
4. Replace the two screws (M2x2) that secure the touchpad to the palm-rest and keyboard assembly.
5. Align the screw holes on the touchpad bracket to the screw holes on the palm-rest and keyboard assembly.
6. Replace the two screws (M2.5x2.5) that secure the touchpad bracket to the palm-rest and keyboard assembly.
7. Route the speaker cable through the routing guides on the palm-rest and keyboard assembly.
8. Adhere the tape that secures the speaker cable to the touchpad.
9. Connect the touchpad cable to the touchpad and close the latch to secure the cable.

Next steps

1. Install the [battery](#).
2. Install the [base cover](#).
3. Follow the procedure in [After working inside your computer](#).

Display assembly

Removing the display assembly

Prerequisites

1. Follow the procedure in [Before working inside your computer.](#)
2. Remove the [base cover.](#)
3. Remove the [rear-I/O cover.](#)

About this task

The following image(s) indicate the location of the display assembly and provides a visual representation of the removal procedure.



6x
M2.5x5

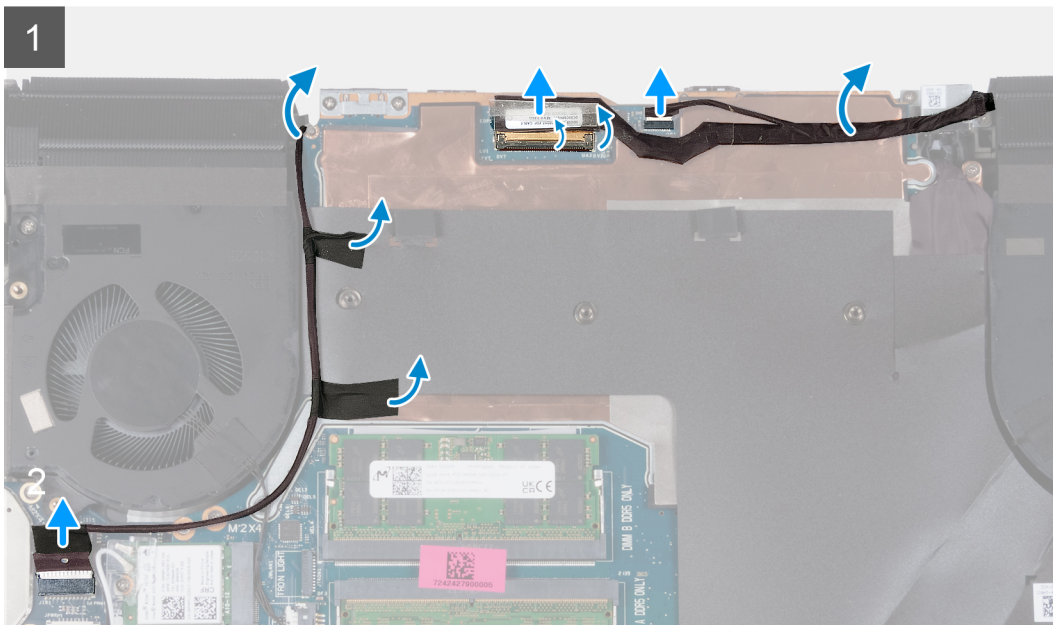
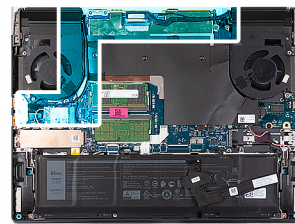

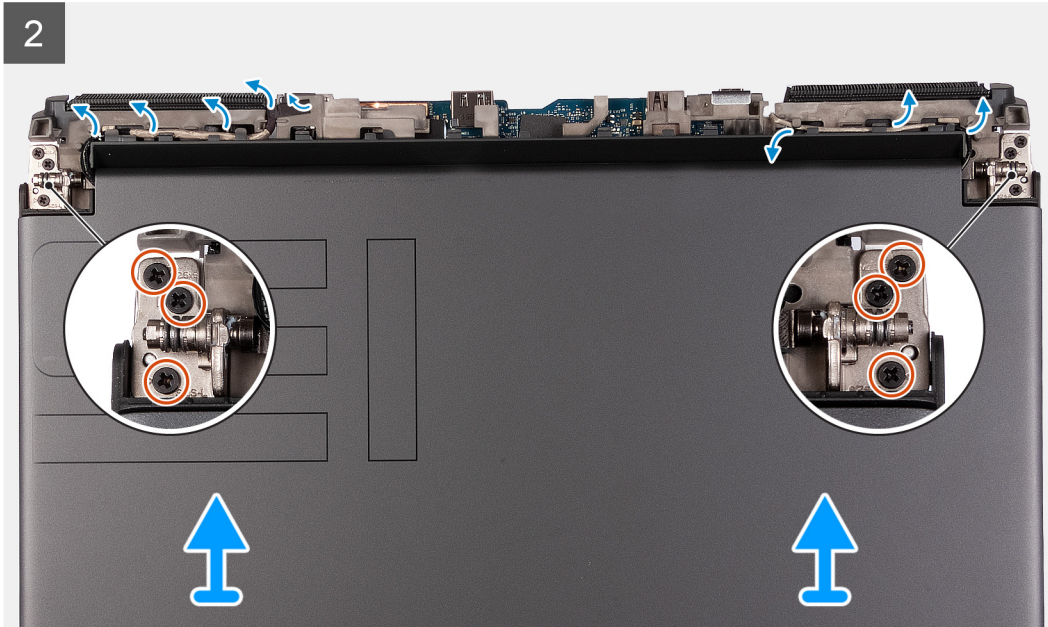

Steps

1. Disconnect the camera cable from the system board.
2. Peel the tapes securing the camera cable to the system board and lift the camera cable off the system board.
(i) NOTE: This step is applicable only for computers shipped with an infrared camera.
3. Peel the tape that secures the display-cable connector latch to the system board.
4. Open the latch and disconnect the display cable from the system board.
5. Disconnect the Alien head LED-cable from the system board.
6. Peel the display cable off the system board and move it out of the way.
7. Turn the computer over.
8. Peel the tape that secures the display cable and Alien head LED-cable to the palm-rest and keyboard assembly..
9. Remove the display cable and Alien head LED-cable from the routing guides on the display assembly.
10. Remove the camera cable from the routing guides on the display assembly.
(i) NOTE: This step is applicable only for computers shipped with an infrared camera.
11. Remove the six screws (M2.5x5) that secure the display assembly to the palm-rest and keyboard assembly.
12. Lift the display assembly off the palm-rest and keyboard assembly.

Installing the display assembly

Prerequisites

If you are replacing a component, remove the existing component before performing the installation process.

About this task

The following image(s) indicate the location of the display assembly and provides a visual representation of the installation procedure.



6x
M2.5x5

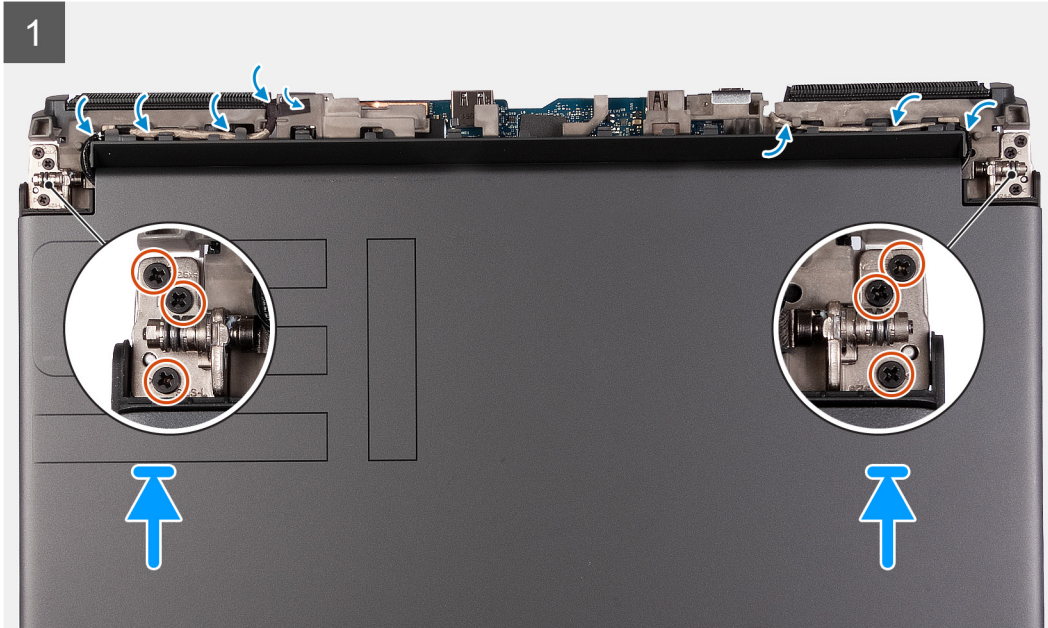

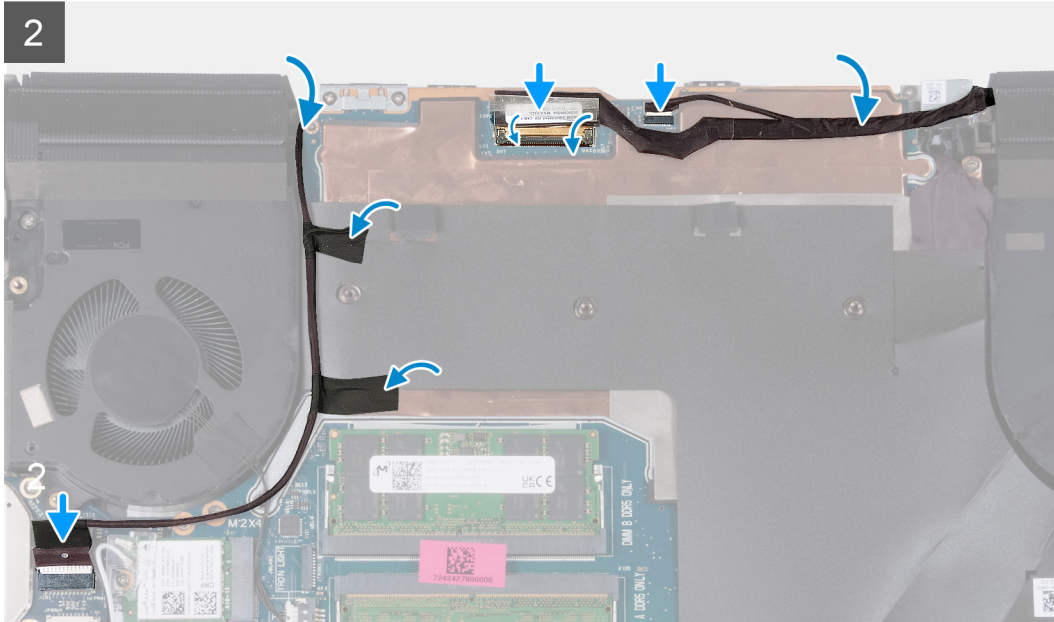
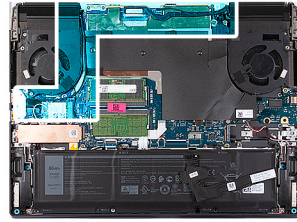

Steps

1. Place the display assembly on the palm-rest and keyboard assembly.

CAUTION: To avoid damaging the display, do not slide display assembly over the palm-rest and keyboard assembly.

2. Align the screw holes on the display assembly to the screw holes on the palm-rest and keyboard assembly.
3. Replace the six screws (M2.5x5) that secure the display assembly to the palm-rest and keyboard assembly.
4. Route the display cable and Alien head LED-cable through the routing guides on the display assembly.
5. Adhere the tape that secures the Alien head LED-cable to the palm-rest and keyboard assembly.
6. Route the camera cable through the routing guides on the display assembly.

NOTE: For computers shipped with an infrared camera, route the camera cable through the routing guides on the display assembly and then into the opening to the right of the HDMI port.

7. Turn over the computer.
8. Connect the Alien head LED-cable to the system board.
9. Adhere the display cable to the system board.
10. Connect the display cable to the system board and close the latch to secure the cable.
11. Adhere the tape that secures the display-cable connector latch to the system board.
12. Adhere the tapes that secure the camera cable to the system board.
13. Connect the camera cable to the system board.

NOTE: Step 11 to step 12 are applicable only for computers shipped with an infrared camera.

Next steps

1. Install the [rear-I/O cover](#).
2. Install the [base cover](#).

3. Follow the procedure in [After working inside your computer.](#)

Keyboard-controller board

Removing the keyboard-controller board

Prerequisites

1. Follow the procedure in [Before working inside your computer.](#)
2. Remove the [base cover.](#)
3. Remove the [battery.](#)

About this task

The following image(s) indicate the location of the keyboard-controller board and provides a visual representation of the removal procedure.



1x
M2x2

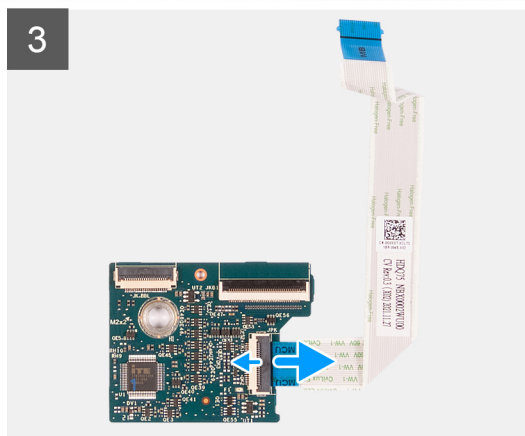
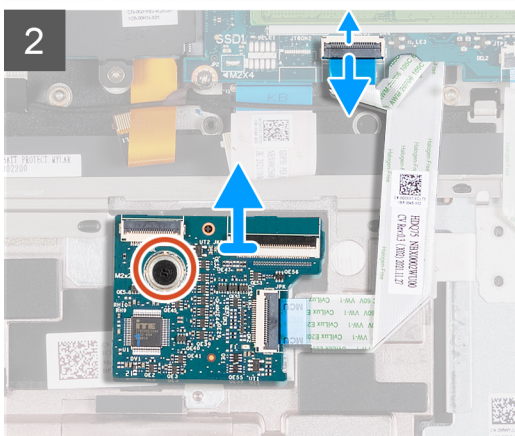
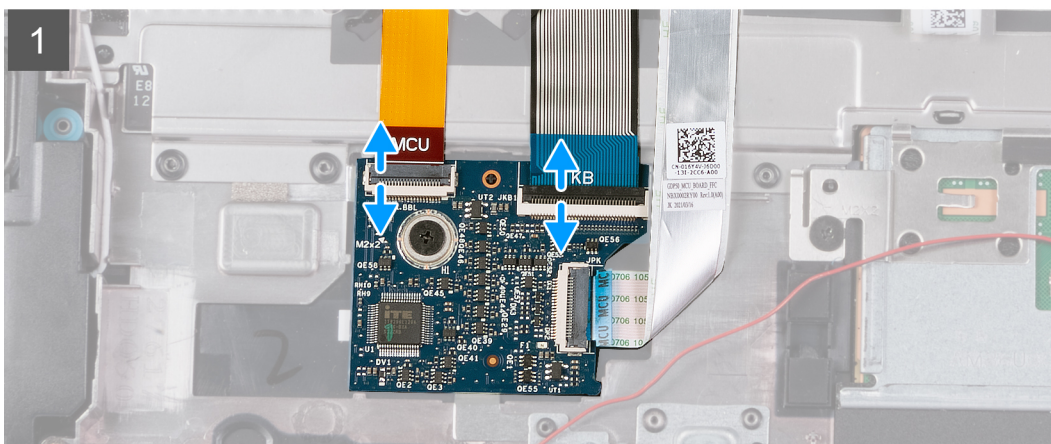
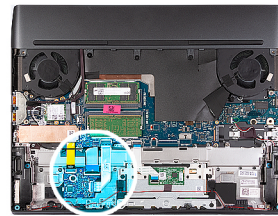

Steps

1. Open the latch and disconnect the keyboard-backlight cable from the keyboard-controller board.
2. Open the latch and disconnect the keyboard cable from the keyboard-controller board.

3. Open the latch and disconnect the keyboard-controller board cable from the system board.
4. Remove the screw (M2x2) that secures the keyboard-controller board to the palm-rest and keyboard assembly.
5. Lift the keyboard-controller board off the palm-rest and keyboard assembly.
6. Open the latch and disconnect the keyboard-controller board cable from the keyboard-controller board.

Installing the keyboard-controller board

Prerequisites

If you are replacing a component, remove the existing component before performing the installation process.

About this task

The following image(s) indicate the location of the keyboard-controller board and provides a visual representation of the installation procedure.

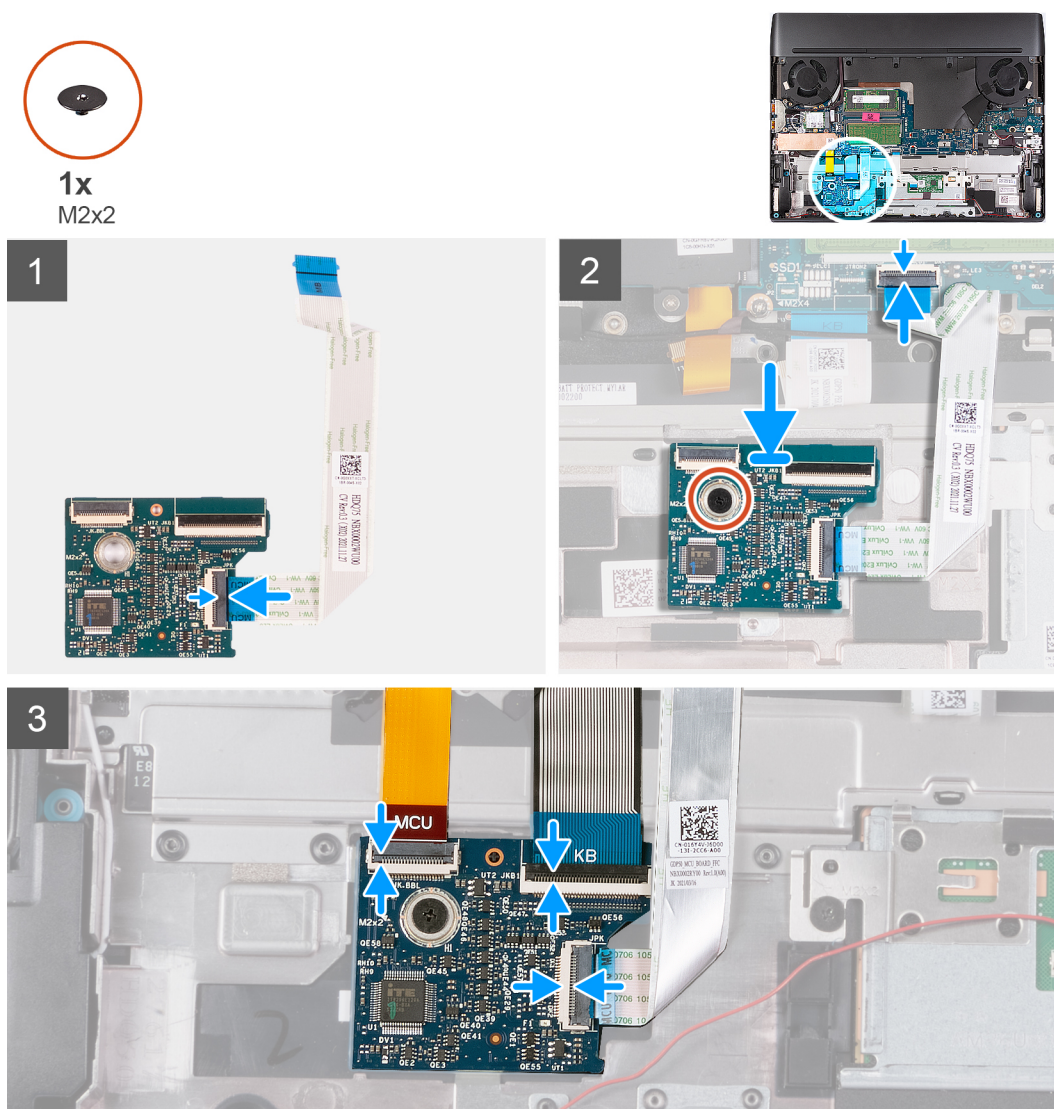

Steps

1. Connect the keyboard-controller board cable to the keyboard-controller board and close the latch to secure the cable.
2. Using the alignment posts, place the keyboard-controller board into the slot on the palm-rest and keyboard assembly.
3. Replace the screw (M2x2) that secures the keyboard-controller board to the palm-rest and keyboard assembly.

4. Connect the keyboard-backlight cable to the keyboard-controller board and close the latch to secure the cable.
5. Connect the keyboard cable to the keyboard-controller board and close the latch to secure the cable.
6. Connect the keyboard-controller board cable to the system board and close the latch to secure the cable.

Next steps

1. Install the [battery](#).
2. Install the [base cover](#).
3. Follow the procedure in [After working inside your computer](#).

System board

Removing the system board

Prerequisites

1. Follow the procedure in [Before working inside your computer](#).
2. Remove the [base cover](#).
3. Remove the [memory](#).
4. Remove the [2230 solid-state drive](#) or [2280 solid-state drive](#) in slot one, whichever applicable.
5. Remove the [2230 solid state drive](#) or [2280 solid-state drive](#) in slot two, whichever applicable.
6. Remove the [wireless card](#).
7. Remove the [rear-I/O cover](#).
8. Remove the [battery](#).

About this task

- i** **NOTE:** When removing this component, please refer to the techsheet bundled with the service kit. This is only applicable for computers with the following Graphics Processing Unit (GPU) configurations that have Element 31 grease is applied to the CPU.
- NVIDIA GeForce RTX 3070 Ti
 - NVIDIA GeForce RTX 3080 Ti

The following image indicates the connectors on your system board.

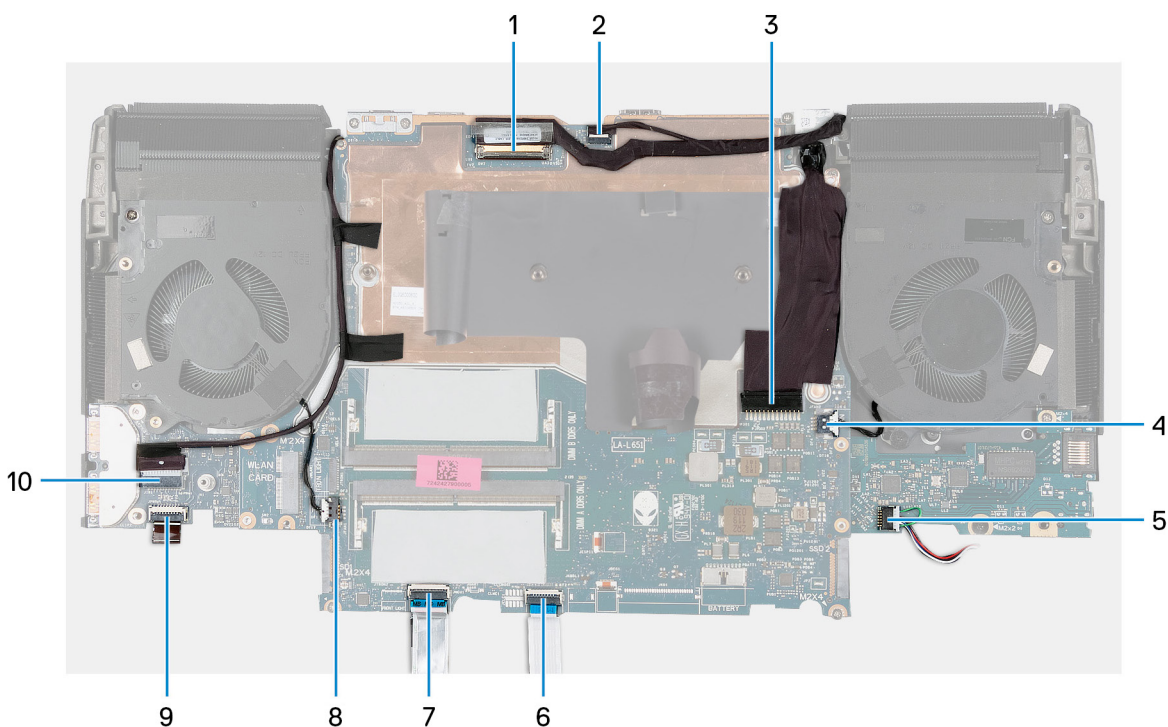

1. Display cable
2. Alien head LED-cable
3. Power-adapter cable
4. Right-fan cable
5. Speaker cable
6. Touchpad cable
7. Keyboard-controller board cable
8. Left-fan cable
9. Power-button cable
10. Camera cable

The following image(s) indicate the location of the system board and provides a visual representation of the removal procedure.

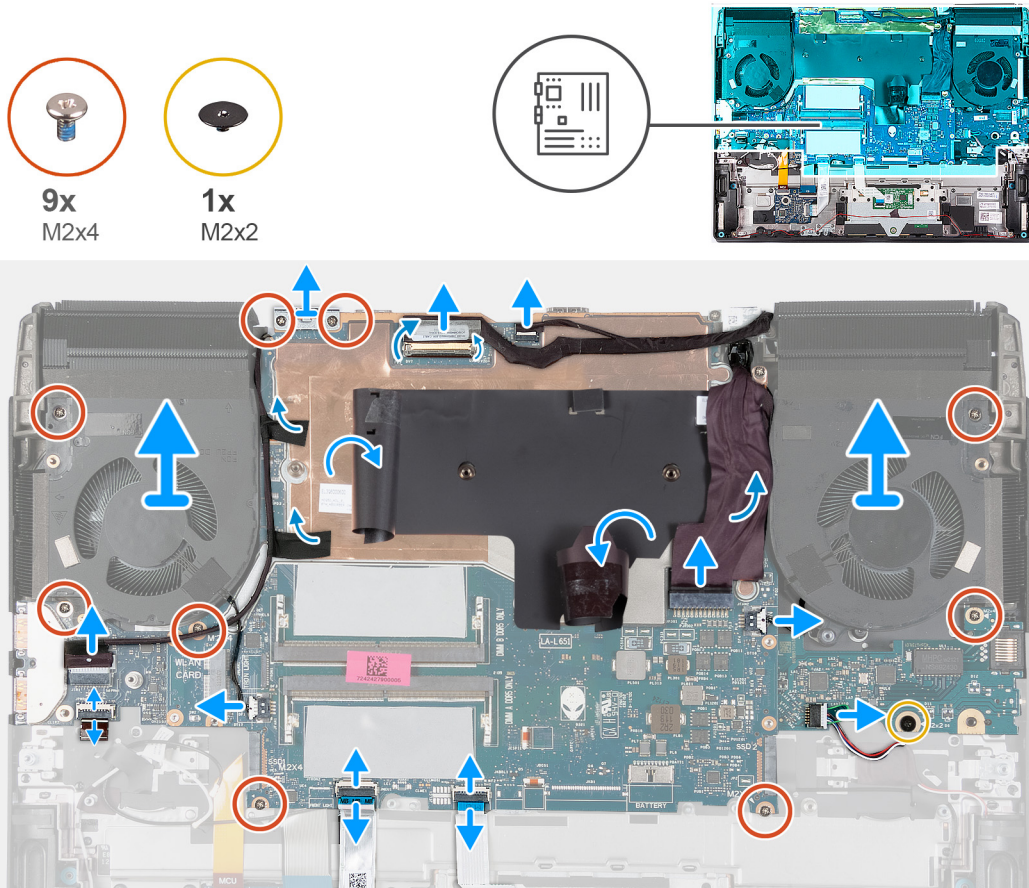

i **NOTE:** Peel off and lift parts of the Mylar to access the cables connected to the system board. Remove the Mylar off the old system board to adhere onto the new system board if the system board is going to be replaced.

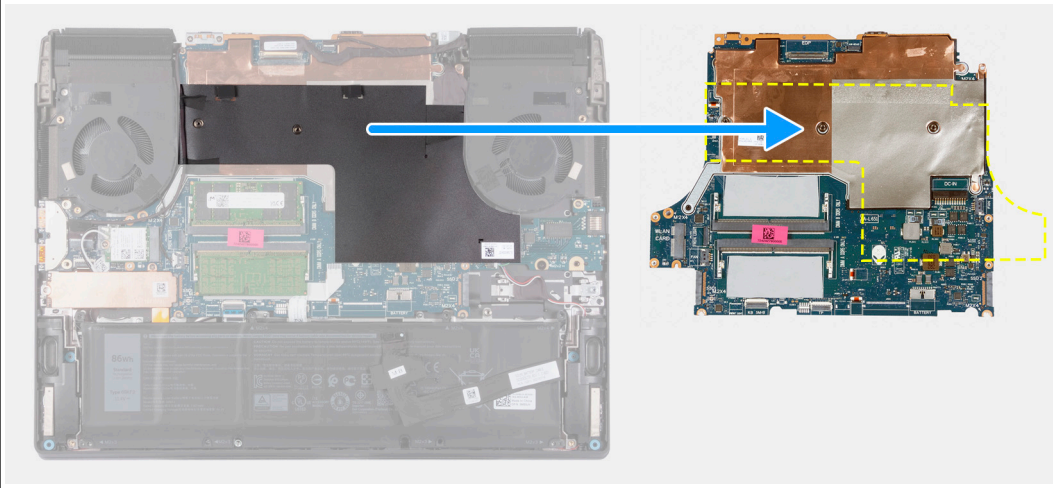

Steps

1. Remove the two screws (M2x4) that secure the Type-C bracket to the system board.
2. Lift the Type-C bracket off the system board.
3. Peel the tape that secures the display-cable connector latch to the system board.
4. Open the latch and disconnect the display cable from the system board.
5. Disconnect the Alien head LED-cable from the system board.
6. Peel the display cable off the system board and move it out of the way.
7. Lift the corner of the Mylar covering the system board.
8. Disconnect the power-adapter port-cable from the system board.
9. Peel the power-adapter port-cable from the Mylar.
10. Disconnect the right-fan cable from the system board.
11. Disconnect the speaker cable from the system board.
12. Open the latch and disconnect the touchpad cable from the system board.
13. Open the latch and disconnect the keyboard-controller board cable from the system board.
14. Disconnect the left-fan cable from the system board.
15. Open the latch and disconnect the power-button cable from the system board.
16. Disconnect the camera cable from the system board.
17. Lift the Mylar that covers the tapes that secure the camera cable to the system board.
18. Peel the tapes securing the camera cable to the system board and lift the camera cable off the system board.

i **NOTE:** Step 16 to step 18 are applicable only for computers shipped with an infrared camera.

19. Remove the seven screws (M2x4) that secure the system board to the palm-rest and keyboard assembly.
20. Remove the screw (M2x2) that secures the system board to the palm-rest and keyboard assembly.
21. Hold firmly on the left and right fans and lift the system-board assembly off the palm-rest and keyboard assembly.
22. Remove the [fan and heat-sink assembly](#).

i **NOTE:** Before returning the old system board. Adhere the processor (CPU) sticker over the processor (CPU) chip surface and ensure that it is fully covered .

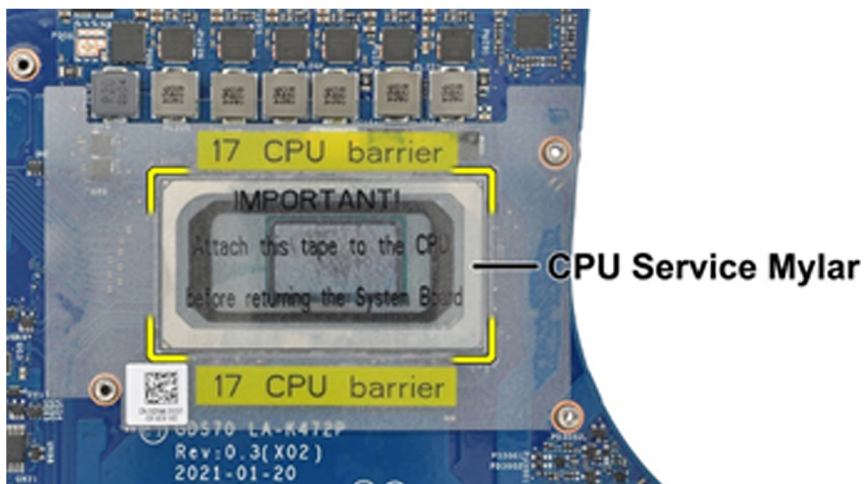

- △ **CAUTION:** Once the system board assembly has been removed from the computer, follow the instructions in the tech sheet dispatched with the replacement system board assembly.
- △ **CAUTION:** Do not use an alcohol wipe to clean the Element 31 thermal grease from the processor (CPU) chip which is surrounded by the processor (CPU) barrier sheet. The alcohol solution from the wipes will dissolve the Element 31 grease into conductive metal particles. If these conductive metal particles come into contact with the surface of the system board, it will cause the an electrical short when your computer is powered on.

23. Remove the [ethernet and audio board](#).
24. Remove the [USB board](#).
25. Turn the system board over.
26. After performing all the above steps, you are left with the system board.

Installing the system board

Prerequisites

If you are replacing a component, remove the existing component before performing the installation process.

About this task

- ⓘ **NOTE:** When installing this component, refer to the techsheet bundled with the service kit. This is only applicable for computers with the following Graphics Processing Unit (GPU) configurations that have Element 31 grease is applied to the CPU.
- NVIDIA GeForce 3070 Ti
 - NVIDIA GeForce 3080 Ti

The following image indicates the connectors on your system board.

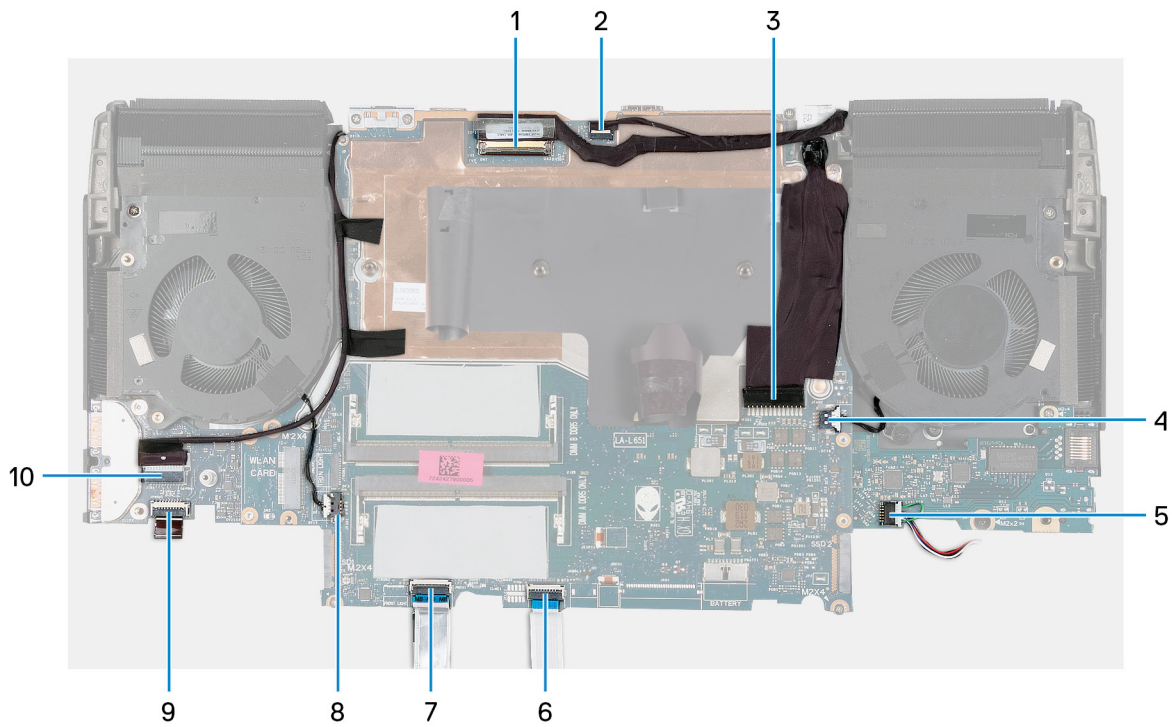

1. Display cable
2. Alien head LED-cable
3. Power-adapter cable
4. Right-fan cable
5. Speaker cable
6. Touchpad cable
7. Keyboard-controller board cable
8. Left-fan cable
9. Power-button cable
10. Camera cable

The following image(s) indicate the location of the system board and provides a visual representation of the installation procedure.



9x
M2x4



1x
M2x2

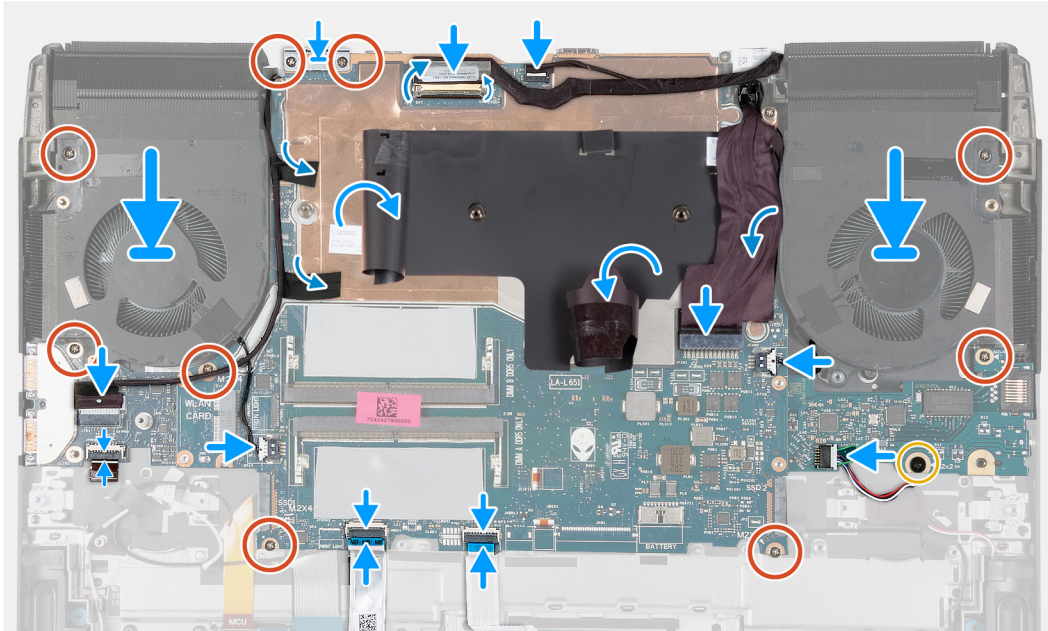
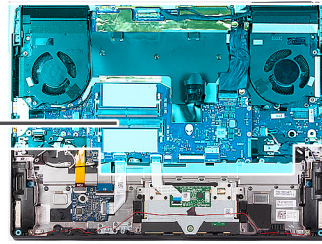

Steps

1. Turn the system board over.
2. Install the [fan and heat-sink assembly](#).
3. Install the [ethernet and audio board](#).
4. Install the [USB board](#).
5. Turn the system-board assembly over.
6. Using the alignment posts, place the system-board assembly on the palm-rest and keyboard assembly.
7. Replace the seven screws (M2x4) that secure the system board to the palm-rest and keyboard assembly.
8. Replace the screw (M2x2) that secures the system board to the palm-rest and keyboard assembly.
9. Connect the camera cable to the system board.
10. Adhere the tapes securing the camera cable to the system board.

i **NOTE:** Step 9 to step 10 are applicable only for computers shipped with an infrared camera.

11. Connect the power-button cable to the system board and close the latch to secure the cable.

i **NOTE:** Ensure that the power-button cable is routed under the system-board assembly and is connected to the system board. Without performing this step, the computer will not power on.

12. Connect the left-fan cable to the system board.
13. Connect the keyboard-controller board cable to the system board and close the latch to secure the cable.
14. Connect the touchpad cable to the system board and close the latch to secure the cable.
15. Connect the speaker cable to the system board.
16. Connect the right-fan cable to the system board.
17. Lift the corner of the Mylar covering the system board.
18. Adhere the power-adaptor port-cable to the Mylar.
19. Connect the power-adaptor port-cable to the system board.

20. Connect the Alien head LED-cable to the system board.
21. Adhere the display cable to the system board.
22. Connect the display cable to the system board and close the latch to secure the cable.
23. Adhere the tape that secures the display-cable connector latch to the system board.
24. Place the Type-C bracket on the system board and align the screw holes on the bracket to the screw holes on the system board.
25. Replace the two screws (M2x4) that secure the Type-C bracket to the system board.

Next steps

1. Install the [battery](#).
2. Install the [rear-I/O cover](#).
3. Install the [wireless card](#).
4. Install the [2230 solid-state drive](#) or [2280 solid-state drive](#) in slot one, whichever applicable.
5. Install the [2230 solid-state drive](#) or [2280 SSD](#) in slot two, whichever applicable.
6. Install the [base cover](#).
7. Follow the procedure in [After working inside your computer](#).

Fan and heat-sink assembly

Removing the fan and heat-sink assembly

Prerequisites

1. Follow the procedure in [Before working inside your computer](#).
2. Remove the [base cover](#).
3. Remove the [2230 solid-state drive](#) or [2280 solid-state drive](#) in slot one, whichever applicable.
4. Remove the [2230 solid state drive](#) or [2280 solid-state drive](#) in slot two, whichever applicable.
5. Remove the [wireless card](#).
6. Remove the [rear-I/O cover](#).
7. Remove the [battery](#).
8. Follow the procedure from step 1 to step 21 in [Removing the system board](#).

i **NOTE:** The system board can be removed and installed along with the memory, ethernet and audio board, USB board, and fan and heat sink-assembly. This simplifies the removal and installation procedure and avoids breaking the thermal bond between the system board and heat sink.

About this task

i **NOTE:** When installing this component, please refer to the techsheet bundled with the service kit. This is only applicable for computers with the following Graphics Processing Unit (GPU) configurations that have Element 31 grease is applied to the CPU.

- NVIDIA GeForce RTX 3070 Ti
- NVIDIA GeForce RTX 3080 Ti

△ **CAUTION:** The heat sink may become hot during normal operation. Allow sufficient time for the heat sink to cool before you touch it.

i **NOTE:** For maximum cooling of the processor, do not touch the heat transfer areas on the heat sink. The oils in your skin can reduce the heat transfer capability of the thermal grease.

The following image(s) indicate the location of the fan and heat-sink assembly and provides a visual representation of the removal procedure.



6x
M2x4

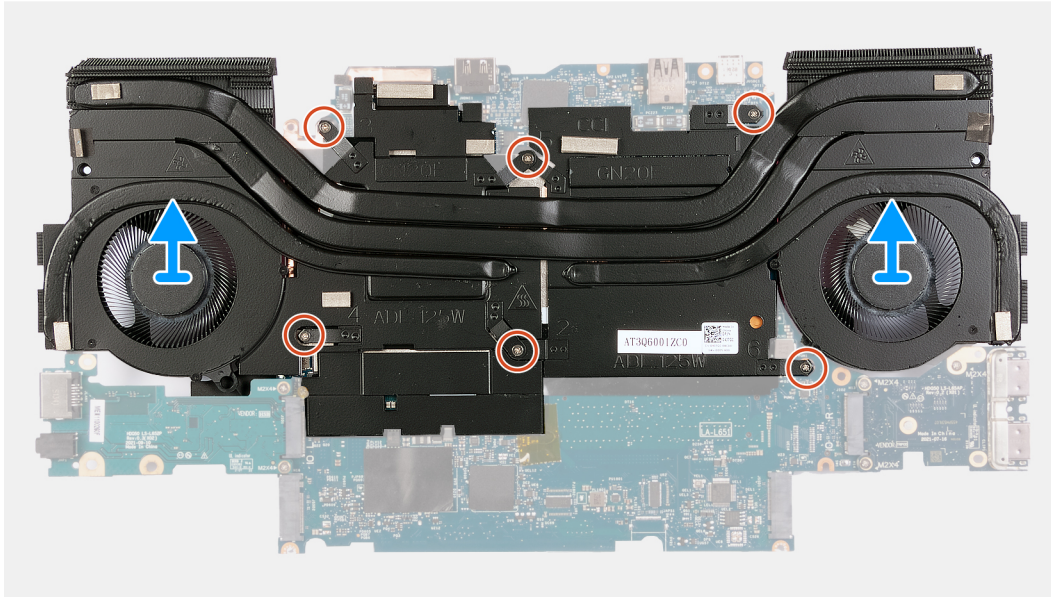
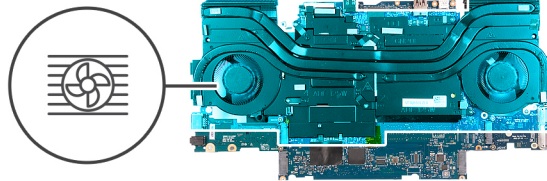

Steps

1. Turn over the system-board assembly.
2. In reverse sequential order (6>5>4>3>2>1), loosen the six captive screws (M2x4) that secure the fan and heat-sink assembly to the system board.
3. Lift the fan and heat-sink assembly off the system board.

CAUTION: Do not use an alcohol wipe to clean the thermal grease, the alcohol solution from the wipes will dissolve the Element 31 grease into conductive metal particles. If these conductive metal particles come into contact with the surface of the system board, it will cause the an electrical short when system is powered on.

Installing the fan and heat-sink assembly

Prerequisites

If you are replacing a component, remove the existing component before performing the installation process.

About this task

- NOTE:** When installing this component, please refer to the techsheet bundled with the service kit. This is only applicable for computers with the following Graphics Processing Unit (GPU) configurations that have Element 31 grease is applied to the CPU.
 - NVIDIA GeForce RTX 3070 Ti
 - NVIDIA GeForce RTX 3080 Ti
- NOTE:** If either the system board or the fan and heat-sink assembly is replaced, use the thermal grease provided in the kit to ensure that thermal conductivity is achieved.

The following image(s) indicate the location of the fan and heat-sink assembly and provides a visual representation of the installation procedure.



6x
M2x4

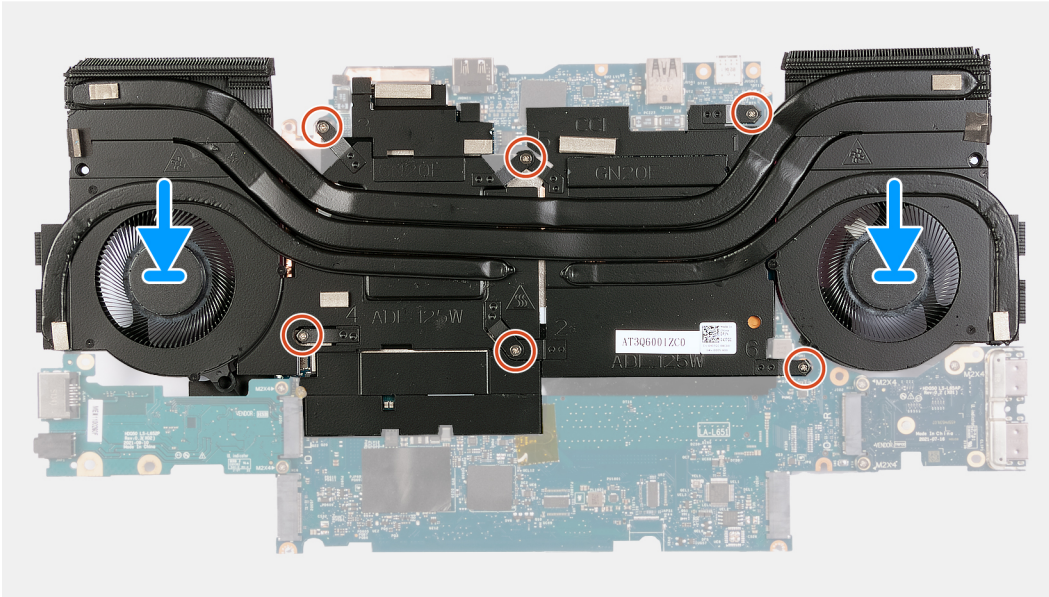
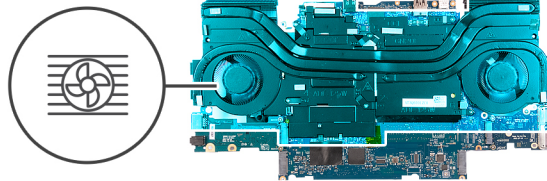

Steps

1.  **CAUTION:** Do not use an alcohol wipe to clean the Element 31 thermal grease off the surface of the processor, the alcohol solution from the wipes will dissolve the Element 31 grease into conductive metal particles. If these conductive metal particles come into contact with the surface of the system board, it will cause the an electrical short when your computer is powered on.

Place the fan and heat-sink assembly on the system board.

2. Align the screw holes on the fan and heat-sink assembly to the screw holes on the system board.
3. In sequential order (1>2>3>4>5>6>), tighten the six captive screws (M2x4) that secure the fan and heat-sink assembly to the system board.
4. Turn over the system-board assembly.

Next steps

1. Follow the procedure from step 6 to step 25 in [Installing the system board](#).
2. Install the [battery](#).
3. Install the [rear-I/O cover](#).
4. Install the [wireless card](#).
5. Install the [2230 solid-state drive](#) or [2280 solid-state drive](#) in slot one, whichever applicable.
6. Install the [2230 solid-state drive](#) or [2280 solid-state drive](#) in slot two, whichever applicable.
7. Install the [base cover](#).
8. Follow the procedure in [After working inside your computer](#).

Ethernet and audio board

Removing the ethernet and audio board

Prerequisites

1. Follow the procedure in [Before working inside your computer](#).
2. Remove the [base cover](#).
3. Remove the [2230 solid-state drive](#) or [2280 solid-state drive](#) in slot one, whichever applicable.
4. Remove the [2230 solid state drive](#) or [2280 solid-state drive](#) in slot two, whichever applicable.
5. Remove the [wireless card](#).
6. Remove the [rear-I/O cover](#).
7. Remove the [battery](#).
8. Follow the procedure from step 1 to step 21 in [Removing the system board](#).

NOTE: The system board can be removed and installed along with the memory, ethernet and audio board, USB board, and fan and heat sink-assembly. This simplifies the removal and installation procedure and avoids breaking the thermal bond between the system board and heat sink.

About this task

The following image(s) indicate the location of the ethernet and audio board and provides a visual representation of the removal procedure.



2x
M2x4

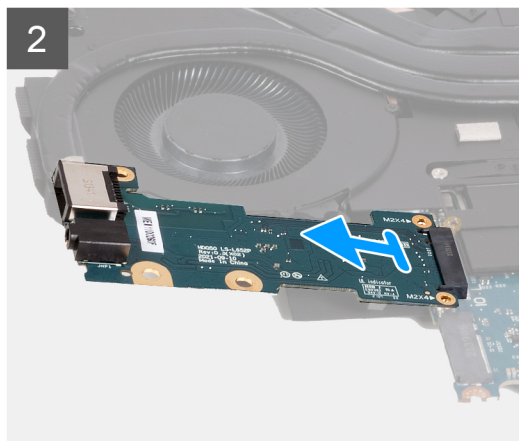
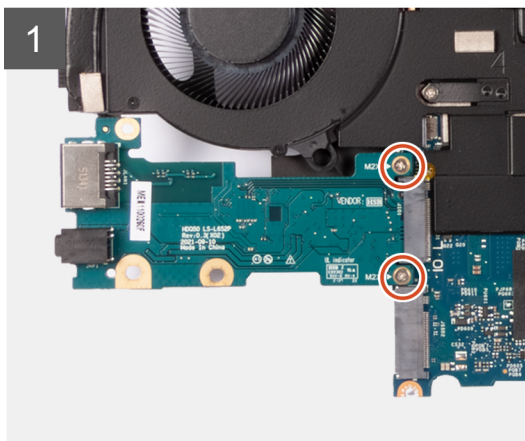
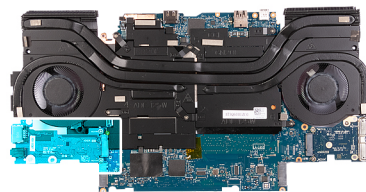

Steps

1. Turn the system-board assembly over.
2. Remove the two screws (M2x4) that secure the ethernet and audio board to the system-board assembly.
3. Lift at an angle and remove the ethernet and audio board from the system-board assembly.

Installing the ethernet and audio board

Prerequisites

If you are replacing a component, remove the existing component before performing the installation process.

About this task

The following image(s) indicate the location of the ethernet and audio board and provides a visual representation of the installation procedure.



2x
M2x4

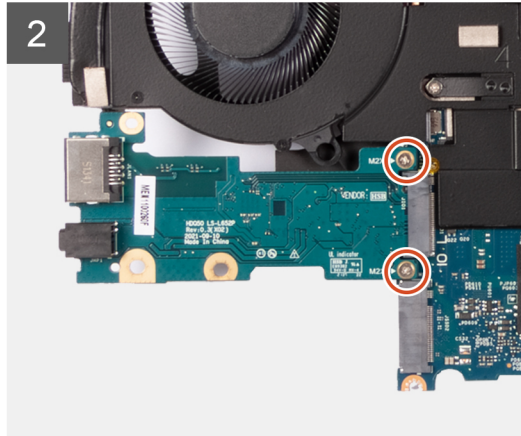
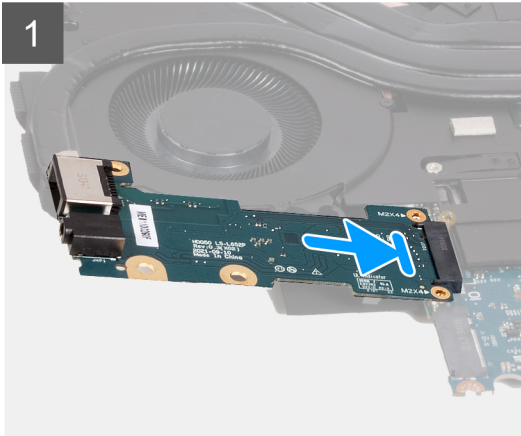
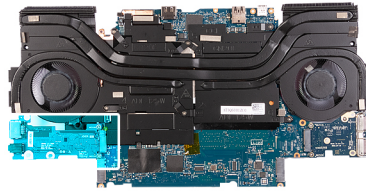

Steps

1. Connect the ethernet and audio board to the system board.
2. Align the screw holes on the ethernet and audio board to the screw holes on the system-board assembly.
3. Replace the two screws (M2x4) that secure the ethernet and audio board to the system-board assembly.
4. Turn the system-board assembly over.

Next steps

1. Follow the procedure from step 6 to step 25 in [Installing the system board](#).
2. Install the [battery](#).
3. Install the [rear-I/O cover](#).
4. Install the [wireless card](#).
5. Install the [2230 solid-state drive](#) or [2280 solid-state drive](#) in slot one, whichever applicable.
6. Install the [2230 solid-state drive](#) or [2280 solid-state drive](#) in slot two, whichever applicable.
7. Install the [base cover](#).
8. Follow the procedure in [After working inside your computer](#).

USB board

Removing the USB board

Prerequisites

1. Follow the procedure in [Before working inside your computer](#).
2. Remove the [base cover](#).
3. Remove the [2230 solid-state drive](#) or [2280 solid-state drive](#) in slot one, whichever applicable.
4. Remove the [2230 solid state drive](#) or [2280 solid-state drive](#) in slot two, whichever applicable.
5. Remove the [wireless card](#).
6. Remove the [rear-I/O cover](#).

7. Remove the [battery](#).
8. Follow the procedure from step 1 to step 21 in [Removing the system board](#).
 - NOTE:** The system board can be removed and installed along with the memory, ethernet and audio board, USB board, and fan and heat sink-assembly. This simplifies the removal and installation procedure and avoids breaking the thermal bond between the system board and heat sink.

About this task

The following image(s) indicate the location of the USB board and provides a visual representation of the removal procedure.

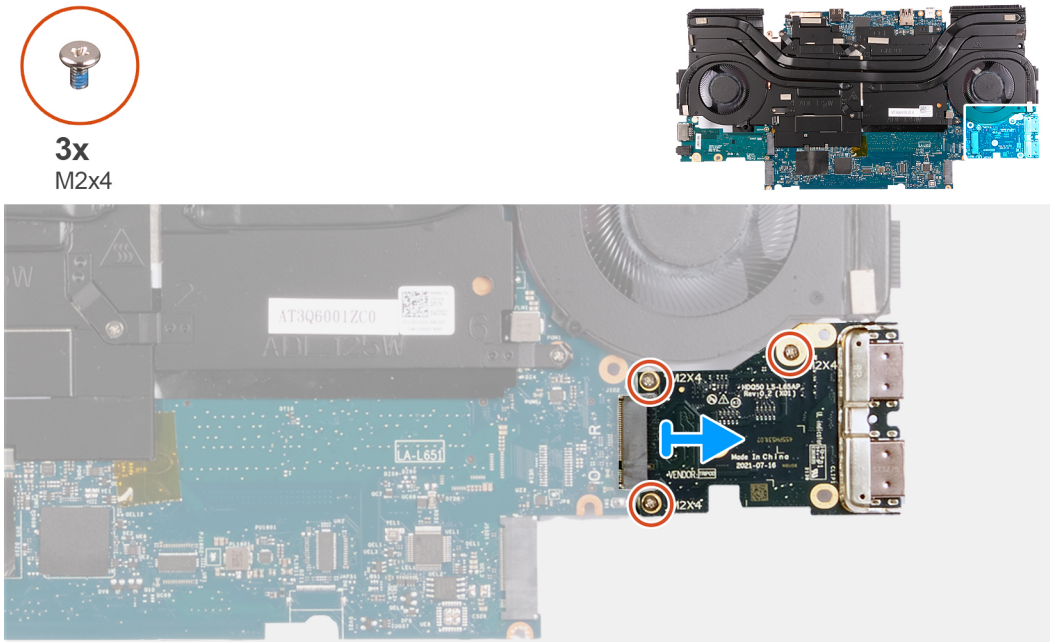

Steps

1. Turn over the system-board assembly.
2. Remove the three screws (M2x4) that secure the USB board to the system-board assembly.
3. Lift at an angle and remove the USB board from the system-board assembly.

Installing the USB board

Prerequisites

If you are replacing a component, remove the existing component before performing the installation process.

About this task

The following image(s) indicate the location of the USB board and provides a visual representation of the installation procedure.



3x
M2x4

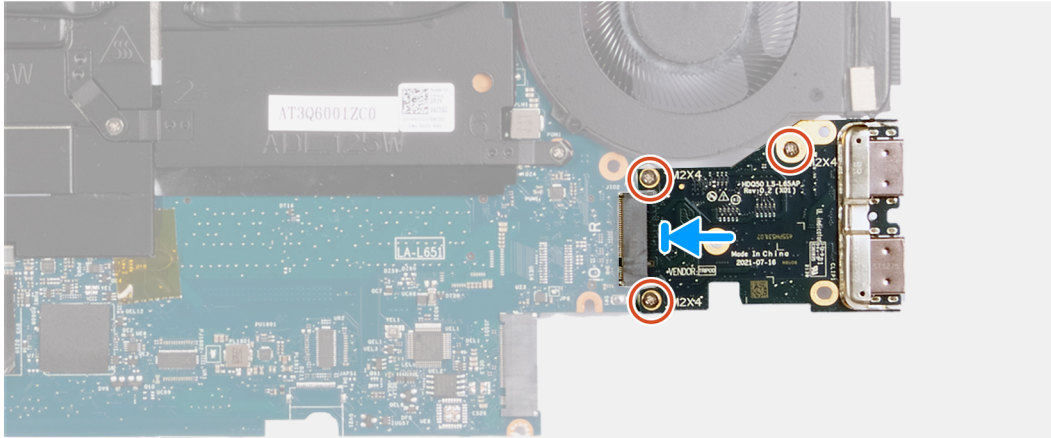
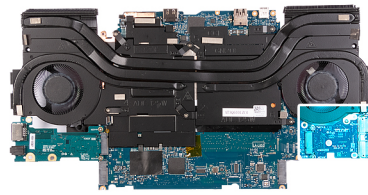

Steps

1. Connect the USB board to the system-board assembly.
2. Align the screw holes on the USB board to the screw holes on the system-board assembly.
3. Replace the three screws (M2x4) that secure the USB board to the system-board assembly.
4. Turn the system-board assembly over.

Next steps

1. Follow the procedure from step 6 to step 25 in [Installing the system board](#).
2. Install the [battery](#).
3. Install the [rear-I/O cover](#).
4. Install the [wireless card](#).
5. Install the [2230 solid-state drive](#) or [2280 solid-state drive](#) in slot one, whichever applicable.
6. Install the [2230 solid-state drive](#) or [2280 solid-state drive](#) in slot two, whichever applicable.
7. Install the [base cover](#).
8. Follow the procedure in [After working inside your computer](#).

Power button

Removing the power button

Prerequisites

1. Follow the procedure in [Before working inside your computer](#).
2. Remove the [base cover](#).
3. Remove the [2230 solid-state drive](#) or [2280 solid-state drive](#) in slot one, whichever applicable.
4. Remove the [2230 solid state drive](#) or [2280 solid-state drive](#) in slot two, whichever applicable.
5. Remove the [wireless card](#).
6. Remove the [rear-I/O cover](#).
7. Remove the [battery](#).
8. Follow the procedure from step 1 to step 21 in [Removing the system board](#).

NOTE: The system board can be removed and installed along with the memory, ethernet and audio board, USB board, and fan and heat sink-assembly. This simplifies the removal and installation procedure and avoids breaking the thermal bond between the system board and heat sink.

About this task

The following image(s) indicate the location of the power button and provides a visual representation of the removal procedure.

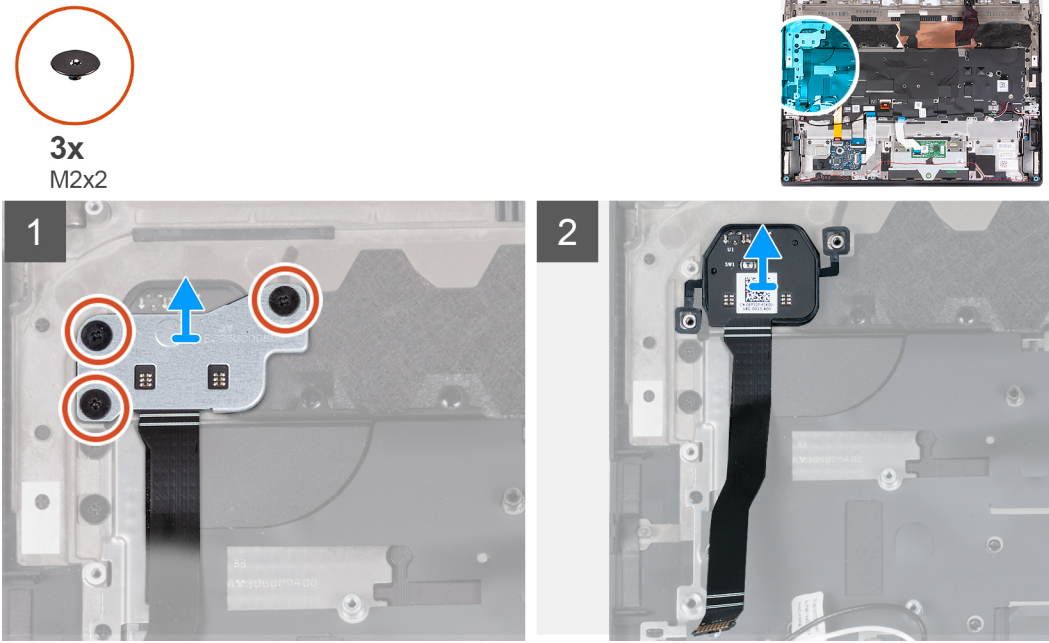

Steps

1. Remove the three screws (M2x2) that secure the power-button bracket to the palm-rest and keyboard assembly.
2. Lift the power-button bracket off the power button.
3. Lift the power button, along with its cable, off the palm-rest and keyboard assembly.

Installing the power button

Prerequisites

If you are replacing a component, remove the existing component before performing the installation process.

About this task

The following image(s) indicate the location of the power button and provides a visual representation of the installation procedure.



3x
M2x2

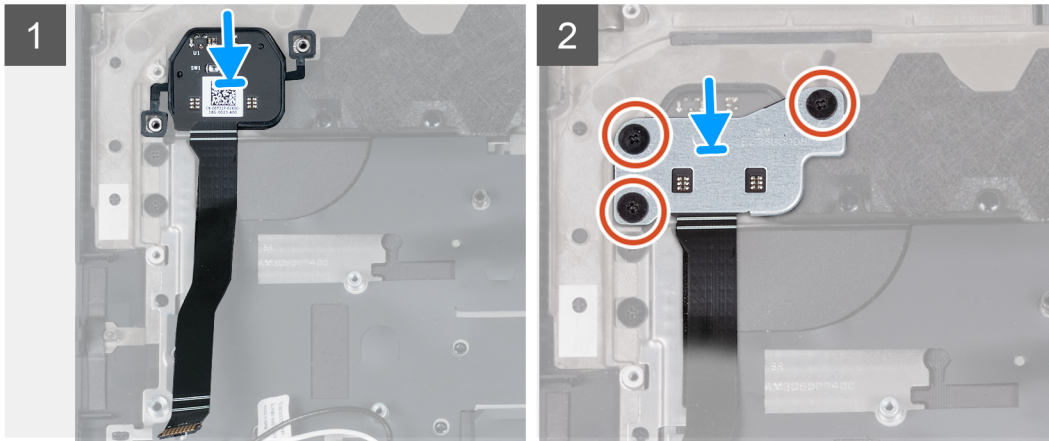

Steps

1. Align and place the power button, along with its cable, into the slot on the palm-rest and keyboard assembly.
2. Align the screw holes on the power-button bracket to the screw holes on the palm-rest and keyboard assembly.
3. Replace the three screws (M2x2) that secure the power-button bracket to the palm-rest and keyboard assembly.

Next steps

1. Follow the procedure from step 6 to step 25 in [Installing the system board](#).
2. Install the [battery](#).
3. Install the [rear-I/O cover](#).
4. Install the [wireless card](#).
5. Install the [2230 solid-state drive](#) or [2280 solid-state drive](#) in slot one, whichever applicable.
6. Install the [2230 solid-state drive](#) or [2280 solid-state drive](#) in slot two, whichever applicable.
7. Install the [base cover](#).
8. Follow the procedure in [After working inside your computer](#).

Palm-rest and keyboard assembly

Removing the palm-rest and keyboard assembly

Prerequisites

1. Follow the procedure in [Before working inside your computer](#).
2. Remove the [base cover](#).
3. Remove the [2230 solid-state drive](#) or [2280 solid-state drive](#) in slot one, whichever applicable.
4. Remove the [2230 solid state drive](#) or [2280 solid-state drive](#) in slot two, whichever applicable.
5. Remove the [wireless card](#).
6. Remove the [rear-I/O cover](#).
7. Remove the [battery](#).
8. Remove the [speakers](#).
9. Remove the [power-adaptor port](#).
10. Remove the [touchpad](#).

11. Remove the [display assembly](#).
12. Remove the [keyboard-controller board](#).
13. Follow the procedure from step 1 to step 21 in [Removing the system board](#).
 - i **NOTE:** The system board can be removed and installed along with the memory, ethernet and audio board, USB board, and fan and heat sink-assembly. This simplifies the removal and installation procedure and avoids breaking the thermal bond between the system board and heat sink.
14. Remove the [power button](#).

About this task

The following image(s) indicate the location of the palm-rest and keyboard assembly and provides a visual representation of the removal procedure.

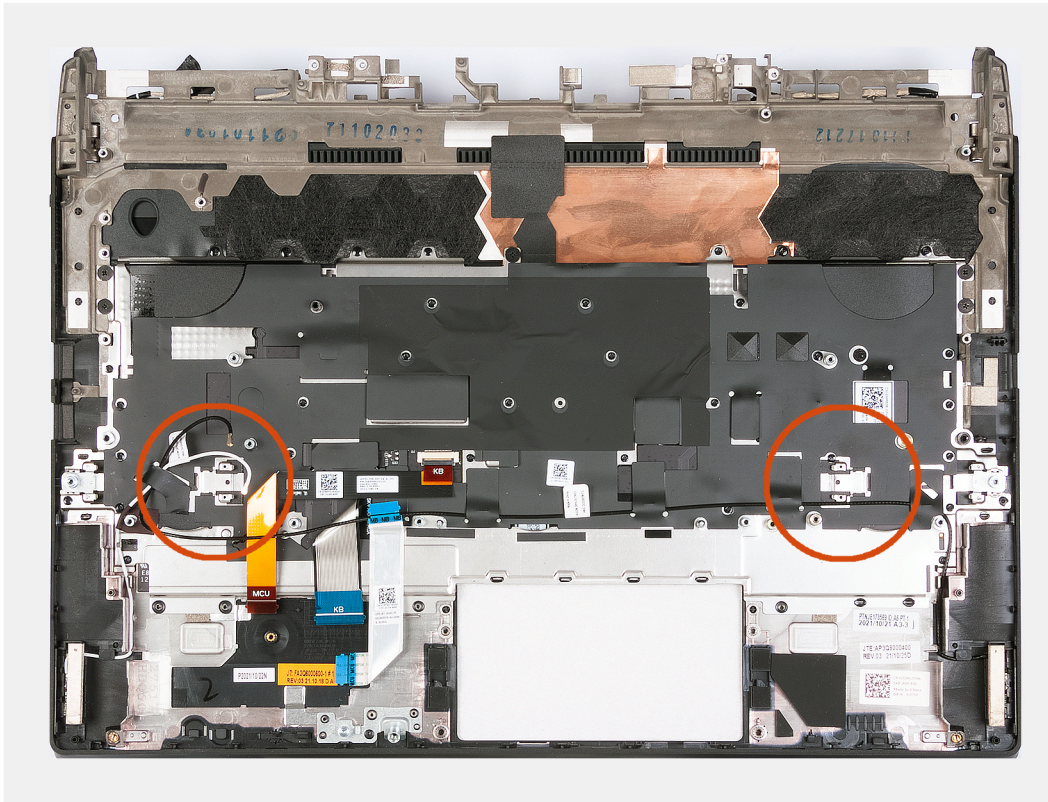

Steps

After performing the pre-requisites you are left with the palm-rest and keyboard assembly.

- i **NOTE:** Ensure that the solid-state drive mounts on slot one and two are removed from the old palm-rest and keyboard assembly before installing the new palm-rest and keyboard assembly. These solid-state drive mounts will be installed into the new palm-rest and keyboard assembly.

Installing the palm-rest and keyboard assembly

Prerequisites

If you are replacing a component, remove the existing component before performing the installation process.

About this task

The following image(s) indicate the location of the palm-rest and keyboard assembly and provides a visual representation of the installation procedure.

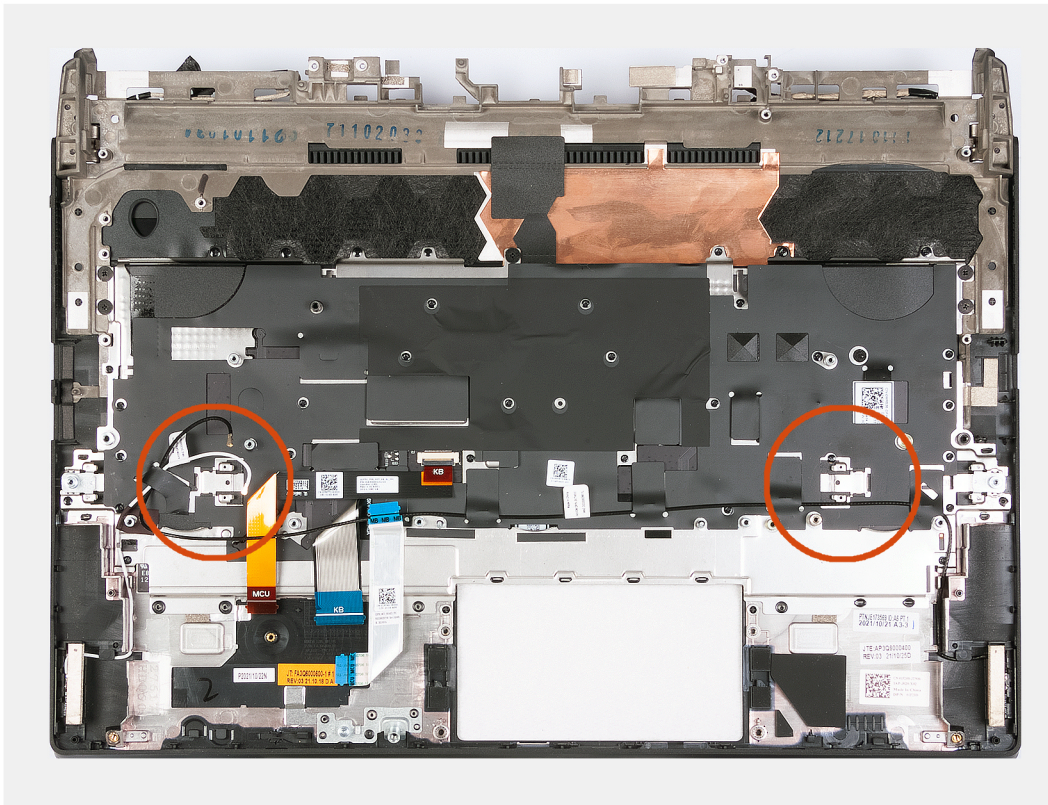

Steps

Place the palm-rest and keyboard assembly on a flat and clean surface and perform the post-requisites to install the palm-rest and keyboard assembly.

i **NOTE:** Install the solid-state drive mounts on slot one and two from the old palm-rest and keyboard assembly into the new palm-rest and keyboard assembly.

Next steps

1. Install the [power button](#).
2. Follow the procedure from step 6 to step 25 in [Installing the system board](#).
3. Install the [keyboard-controller board](#).
4. Install the [display assembly](#).
5. Install the [touchpad](#).
6. Install the [power-adaptor port](#).
7. Install the [speakers](#).
8. Install the [battery](#).
9. Install the [rear-I/O cover](#).
10. Install the [wireless card](#).
11. Install the [2230 solid-state drive](#) or [2280 solid-state drive](#) in slot one, whichever applicable.
12. Install the [2230 solid-state drive](#) or [2280 solid-state drive](#) in slot two, whichever applicable.
13. Install the [base cover](#).
14. Follow the procedure in [After working inside your computer](#).

Drivers and downloads

When troubleshooting, downloading or installing drivers it is recommended that you read the Dell Knowledge Based article, Drivers and Downloads FAQ [000123347](#).

System setup

CAUTION: Unless you are an expert computer user, do not change the settings in the BIOS Setup program. Certain changes can make your computer work incorrectly.

NOTE: Before you change BIOS Setup program, it is recommended that you write down the BIOS Setup program screen information for future reference.

Use the BIOS Setup program for the following purposes:

- Get information about the hardware installed in your computer, such as the amount of RAM and the size of the hard drive.
- Change the system configuration information.
- Set or change a user-selectable option, such as the user password, type of hard drive installed, and enabling or disabling base devices.

BIOS overview

The BIOS manages data flow between the computer's operating system and attached devices such as hard disk, video adapter, keyboard, mouse, and printer.

Entering BIOS setup program

Steps

1. Turn on (or restart) your computer.
2. During POST, when the DELL logo is displayed, watch for the F2 prompt to appear, and then press F2 immediately.

NOTE: The F2 prompt indicates that the keyboard is initialized. This prompt can appear very quickly, so you must watch for it, and then press F2. If you press F2 before the F2 prompt, this keystroke is lost. If you wait too long and the operating system logo appears, continue to wait until you see the desktop. Then, turn off your computer and try again.

Navigation keys

NOTE: For most of the System Setup options, changes that you make are recorded but do not take effect until you restart the system.

| Keys | Navigation |
|-------------------|---|
| Up arrow | Moves to the previous field. |
| Down arrow | Moves to the next field. |
| Enter | Selects a value in the selected field (if applicable) or follow the link in the field. |
| Spacebar | Expands or collapses a drop-down list, if applicable. |
| Tab | Moves to the next focus area. |
| Esc | Moves to the previous page until you view the main screen. Pressing Esc in the main screen displays a message that prompts you to save any unsaved changes and restarts the system. |

Boot Sequence

Boot Sequence allows you to bypass the System Setup–defined boot device order and boot directly to a specific device (for example: optical drive or hard drive). During the Power-on Self Test (POST), when the Dell logo appears, you can:

- Access System Setup by pressing F2 key
- Bring up the one-time boot menu by pressing F12 key

The one-time boot menu displays the devices that you can boot from including the diagnostic option. The boot menu options are:

- Removable Drive (if available)
- STXXXX Drive (if available)
- **i** **NOTE:** XXX denotes the SATA drive number.
- Optical Drive (if available)
- SATA Hard Drive (if available)
- Diagnostics

The boot sequence screen also displays the option to access the System Setup screen.

System setup options

i **NOTE:** Depending on this computer and its installed devices, the items that are listed in this section may or may not be displayed.

Table 3. System setup options—System information menu

| Overview | |
|-------------------------------|---|
| BIOS Version | Displays the BIOS version number. |
| Service Tag | Displays the Service Tag of the computer. |
| Asset Tag | Displays the Asset Tag of the computer. |
| Manufacture Date | Displays the manufacture date of the computer. |
| Ownership Date | Displays the ownership date of the computer. |
| Express Service Code | Displays the express service code of the computer. |
| Ownership Tag | Displays the ownership tag of the computer. |
| Signed Firmware Update | Displays whether the signed firmware update is enabled. Default: Enabled |
| BATTERY | |
| Primary | |
| Battery Level | Displays the battery level. |
| Battery State | Displays the battery state. |
| Health | Displays the battery health information. |
| AC Adapter | Displays whether an AC adapter is connected. If connected, the AC adapter type. |
| PROCESSOR | |
| Processor Type | Displays the processor type. |
| Maximum Clock Speed | Displays the maximum processor clock speed. |
| Minimum Clock Speed | Displays the minimum processor clock speed. |
| Current Clock Speed | Displays the current processor clock speed. |
| Core Count | Displays the number of cores on the processor. |
| Processor ID | Displays the processor identification code. |
| Processor L2 Cache | Displays the processor L2 Cache size. |
| Processor L3 Cache | Displays the processor L3 Cache size. |
| Microcode Version | Displays the microcode version. |
| Intel Hyper-Threading Capable | Displays whether the processor is Hyper-Threading (HT) capable. |
| 64-Bit Technology | Displays whether 64-bit technology is used. |

Table 3. System setup options—System information menu (continued)

| Overview | |
|-----------------------|---|
| MEMORY | |
| Memory Installed | Displays the total computer memory installed. |
| Memory Available | Displays the total computer memory available. |
| Memory Speed | Displays the memory speed. |
| Memory Channel Mode | Displays single or dual channel mode. |
| Memory Technology | Displays the technology that is used for the memory. |
| DIMM A Size | Displays the memory configuration of DIMM A. |
| DIMM B Size | Displays the memory configuration of DIMM B. |
| DEVICES | |
| Panel Type | Displays the Panel Type of the computer. |
| Video Controller | Displays the integrate graphics information of the computer. |
| Video Memory | Displays the video memory information of the computer. |
| Wi-Fi Device | Displays the Wi-Fi device installed in the computer. |
| Native Resolution | Displays the native resolution of the computer. |
| Video BIOS Version | Displays the video BIOS version of the computer. |
| Audio Controller | Displays the audio controller information of the computer. |
| Bluetooth Device | Displays whether a Bluetooth device is installed in the computer. |
| LOM MAC Address | Displays the MAC address of the LAN on Motherboard (LOM). |
| dGPU Video Controller | Displays the discrete graphics controller. |

Table 4. System setup options—Boot Configuration menu

| Boot Configuration | |
|------------------------------|--|
| Boot Sequence | |
| Boot Mode: UEFI only | Displays the boot mode of this computer. |
| Boot Sequence | Enables or disables Windows Boot Manager and UEFI Hard Drive. By default, Windows Boot Manager is selected By default, UEFI Hard Drive is selected |
| Secure Boot | |
| Enable Secure Boot | Enables secure boot using only validated boot software. Default: OFF |
| Secure Boot Mode | Displays the secure boot mode . Default: Deployed Mode |
| Expert Key Management | |
| Enable Custom Mode | Allows the PK, KEK, db, and dbx security key databases to be modified. Default: OFF |
| Custom Mode Key Management | Allows for selection of key database. Default: PK |

Table 5. System setup options—Integrated Devices menu

| Integrated Devices | |
|--|--|
| Date/Time | |
| Date | Sets the computer date in MM/DD/YYYY format. Changes to the date take effect immediately. |
| Time | Sets the computer time in HH/MM/SS 24-hour format. You can switch between 12-hour and 24-hour clock. Changes to the time take effect immediately. |
| Camera | |
| Enable Camera | Enables or disables the camera. By default, Enable Camera is selected. |
| Audio | |
| Enable Audio | Enables or disables all integrated audio controller. Default: ON |
| Enable Microphone | Enables or disables microphone. By default, Enable Microphone is selected. |
| Enable Internal Speaker | Enables or disables internal speaker. By default, Enable Internal Speaker is selected. |
| USB/Thunderbolt Configuration | |
| Enable External USB Ports | Enables or disables all external USB ports in an OS environment. By default, Enable External USB Ports is selected. |
| Enable USB Boot Support | Enables or disables booting from USB mass storage devices such as external hard drive, optical drive, and USB drive. By default, Enable USB Boot Support is selected. |
| Enable Thunderbolt Boot Support | Enables or disables Thunderbolt™ adapter peripheral devices and USB devices connected to the Thunderbolt™ adapter to be used during BIO's pre-boot. Default: OFF |
| Enable Thunderbolt (and PCIe behind TBT) pre-boot modules | Enables or disables PCIe devices that are connected through a Thunderbolt™ adapter to run the PCIe device's UEFI Option ROM(s) during pre-boot. Default: OFF |

Table 6. System setup options—Storage menu

| Storage | |
|----------------------------|--|
| SATA/NVMe Operation | |
| SATA/NVMe Operation | Sets the operating mode of the integrated storage device controller. Default: RAID On |
| Storage Interface | |
| Port Enablement | Enables or disables the onboard drives. |
| M.2 PCIe SSD-0 | Enables or disables the M.2 PCIe SSD-0. Default: ON |
| M.2 PCIe SSD-1 | Enables or disables the M.2 PCIe SSD-1. Default: ON |
| SMART Reporting | |

Table 6. System setup options—Storage menu (continued)

| Storage | |
|--------------------------|--|
| Enable SMART Reporting | Enables or disables Self-Monitoring, Analysis, and Reporting Technology (SMART). Default: OFF |
| Drive Information | Displays the information of various onboard drives. |

Table 7. System setup options—Display menu

| Display | |
|--|---|
| Display Brightness | |
| Brightness on battery power | Sets the screen brightness when the computer is running on battery power. Default: 50 |
| Brightness on AC power | Sets the screen brightness when the computer is running on AC power. Default: 100 |
| Full Screen Logo | |
| Full Screen Logo | When turned on, the full screen logo is displayed if the image matches the screen resolution. Default: OFF |
| Hybrid Graphics / Advanced Optimus | |
| Enable Hybrid Graphics / Advanced Optimus (when available) | When turned on, the system allows both integrated and discrete graphics controllers to work together for optimized capability and battery life. When turned off, the discrete graphics controller will drive all displays to prioritize graphics capability over battery life. Default: On |
| | NOTE: Linux is not supported with Hybrid Graphics enabled. |

Table 8. System setup options—Connection menu

| Connection | |
|---|--|
| Network Controller Configuration | |
| Integrated NIC | Controls the onboard LAN controller. Default: Enabled with PXE |
| Wireless Device Enable | |
| WLAN | Enable or disable internal WLAN devices. By default, WLAN is selected. |
| Bluetooth | Enable or disable internal Bluetooth devices. By default, Bluetooth is selected. |
| Enable UEFI Network Stack | |
| Enable UEFI Network Stack | Enables or disables UEFI networking protocols, if they are installed and available. Default: ON |
| HTTP(s) Boot Feature | |
| HTTP(s) Boot | Enable or disable HTTP(s) Boot feature. Default: ON |
| HTTP(s) Boot Modes | Configures HTTP(s) Boot Modes. |

Table 8. System setup options—Connection menu (continued)

| Connection | |
|------------|--|
| | <p>Default: Auto Mode. HTTP(s) Boot automatically extracts Boot URL from the Dynamic Host Configuration (DHCP).</p> <p>NOTE: Provisioning of the Certificate is required to connect to HTTPs Boot server.</p> |

Table 9. System setup options—Power menu

| Power | |
|--|---|
| Battery 1 Charge Mode | |
| Battery 1 Charge Mode | <p>Enables the computer to run on battery during peak power usage hours. Use the below options to prevent AC power usage between certain times of each day.</p> <p>Default: Adaptive. Battery settings are adaptively optimized based on your typical battery usage pattern.</p> |
| Advanced Configuration | |
| Enable Advanced Battery Charge Configuration | <p>Enables Advanced Battery Charge Configuration from the beginning of the day to a specified work period. Advanced Battery Charged maximizes battery health while still supporting heavy use during the work day.</p> <p>Default: OFF</p> |
| USB PowerShare | |
| Enable USB PowerShare | <p>Enables external devices such as phones and portable music players to be powered or charged using the stored system battery..</p> <p>Default: OFF</p> |
| Thermal Management | |
| Thermal Management | <p>Enables the cooling fan and processor heat management to adjust system performance, noise, and temperature.</p> <p>Default: Optimized. Standard settings for cooling fan and processor heat management. This setting is a balance of performance, noise, and temperature.</p> |
| Block Sleep | |
| Block Sleep | <p>Blocks the computer from entering Sleep (S3) mode in the operating system.</p> <p>Default: OFF</p> <p>NOTE: If enabled, the computer will not go to sleep, Intel® Rapid Start will be disabled automatically, and the operating system power option will be blank if it was set to Sleep.</p> |
| Lid Switch | |
| Enable Lid Switch | <p>Enable or disable the lid switch.</p> <p>Default: ON</p> |
| Power On Lid Open | <p>Enables the computer to turn on from the off state whenever the lid is opened.</p> <p>Default: ON</p> |
| Intel Speed Shift Technology | |
| Intel Speed Shift Technology | <p>Enables or disables the Intel Speed Shift Technology support. Setting this option to enable allows the operating system to select the appropriate processor performance automatically.</p> <p>Default: ON</p> |

Table 10. System setup options—Security menu

| Security | |
|---|--|
| Intel® Platform Trust Technology | |
| Intel® Platform Trust Technology On | Enable or disable the Intel® Platform Trust Technology (PPT) feature in the OS. Default: ON |
| PPI Bypass for Clear Commands | Enables or disables the Trusted Platform Model (TPM) Physical Presence Interface (PPI). When enabled, the OS will skip BIOS Physical Presence Interface (PPI) user prompts when issuing the Clear command. Default: OFF |
| Clear | Enables or disables the computer to clear the PTT owner information, and returns the PTT to the default state. Default: OFF |
| SMM Security Mitigation | |
| SMM Security Mitigation | Enables or disables additional UEFI SMM Security Mitigation protections. Default: OFF |
| | i NOTE: This feature may cause compatibility issues or loss of functionality with some legacy tools and applications. |
| Data Wipe on Next Boot | |
| Start Data Wipe | When enabled, the BIOS will schedule a data wipe cycle for all storage devices that are connected to the system board on the next reboot. Default: OFF |
| Absolute | |
| Absolute | Enables, disables or permanently disable the BIOS module interface of the optional Absolute Persistence Module service from Absolute Software. Default: Enabled |
| UEFI Boot Path Security | |
| UEFI Boot Path Security | Determines if the system will prompt the user to enter the admin password (if set) when booting to a UEFI boot path device from the F12 boot menu. Default: Always Except Internal HDD. |

Table 11. System setup options—Passwords menu

| Passwords | |
|-------------------------------|--|
| Admin Password | Enables you to set, change, or delete the administrator (admin) password. The admin password enables several security features |
| System Password | Enables you to set, change, or delete the system password. |
| M.2 PCIe SSD-0 | Enables you to set, change, or delete the M.2 PCIe SSD-0 password. |
| Password Configuration | |
| Upper Case Letter | Enforces password restriction that the password must contain at least one upper case letter. Default: OFF |
| Lower Case Letter | Enforces password restriction that the password must contain at least one lower case letter. Default: OFF |
| Digit | Enforces password restriction that the password must contain at least one digit. |

Table 11. System setup options—Passwords menu (continued)

| Passwords | |
|------------------------------------|--|
| | Default: OFF |
| Special Character | Enforces password restriction that the password must contain at least one special character. |
| | Default: OFF |
| Minimum Characters | Controls the minimum number of characters allowed for password. |
| | Default: 04 |
| Password Bypass | |
| Password Bypass | Bypass the System (Boot) Password and the internal hard drive password prompts during a system restart. |
| | Default: Disabled |
| Password Changes | |
| | Bypass the System (Boot) Password and the internal hard drive password prompts during a system restart. |
| | Default: Disabled |
| Enable Non-Admin Password Changes | Enables or disables the user to change the system and hard drive password without the need for admin password. |
| | Default: ON |
| Admin Setup Lockout | |
| Enable Admin Setup Lockout | Enables or disables the user from entering BIOS Setup when an Admin Password is set. |
| | Default: OFF |
| Master Password Lockout | |
| Enable Master Password Lockout | Enables or disables master password support. |
| | Default: OFF |
| | ⓘ NOTE: Hard drive passwords must be cleared before the setting can be changed. |
| Allow Non-Admin PSID Revert | |
| Enable Allow Non-Admin PSID Revert | Controls access to the Physical Security ID (PSID) revert of NVMe hard-drives from the Dell Security Manager prompt. |
| | Default: OFF |

Table 12. System setup options—Update,Recovery menu

| Update,Recovery | |
|--------------------------------------|--|
| UEFI Capsule Firmware Updates | |
| Enable UEFI Capsule Firmware Updates | Enables or disables BIOS updates through UEFI capsule update packages. |
| | Default: ON |
| BIOS Recovery from Hard Drive | |
| BIOS Recovery from Hard Drive | Enables the computer to recover from a bad BIOS image, as long as the Boot Block portion is intact and functioning. |
| | Default: ON |
| | ⓘ NOTE: BIOS recovery is designed to fix the main BIOS block and cannot work if the Boot Block is damaged. In addition, this feature cannot work in |

Table 12. System setup options—Update,Recovery menu (continued)

| Update,Recovery | |
|--|---|
| | the event of EC corruption, ME corruption, or a hardware issue. The recovery image must exist on an unencrypted partition on the drive. |
| BIOS Downgrade | |
| Allow BIOS Downgrade | Controls flashing of the system firmware to previous revisions. Default: ON |
| SupportAssist OS Recovery | |
| | Enables or disables the boot flow for SupportAssist OS Recovery tool, in the event of certain system error. Default: ON |
| BIOSConnect | |
| BIOSConnect | Enables or disables cloud Service OS recovery if the main OS fails to boot within the number of failures equal or greater than the value specified by Dell Auto OS Recovery Threshold, and local Service does not boot, or is not installed. Default: ON |
| Dell Auto OS Recovery Threshold | |
| Dell Auto OS Recovery Threshold | Controls the automatic boot flow for SupportAssist System Resolution Console and for Dell operating system Recovery tool. Default: 2. |

Table 13. System setup options—System Management menu

| System Management | |
|----------------------------|--|
| Service Tag | Displays the Service Tag of the computer. |
| Asset Tag | Creates a system Asset Tag that can be used by an IT administrator to uniquely identify a particular system. Once set in BIOS, the Asset Tag cannot be changed. |
| AC Behavior | |
| Wake on AC | Enables or disables basic checks when AC power is applied to the device. The checks include determining how the AC Recovery option is set. The system will boot up if Wake on AC is enabled, the system will power off, if Wake on AC is disabled. Default: OFF |
| Auto On Time | |
| Auto On Time | Controls automatic powering up of system for defined days and times. Default: Every Day |
| First Power On Date | |
| Set Ownership Date | Enables the user to configure the Ownership date. Default: OFF |

Table 14. System setup options—Keyboard menu

| Keyboard | |
|------------------------|--|
| Fn Lock Options | |
| Fn Lock Options | Enables or disables the Fn lock mode. Default: ON |
| Lock Mode | Controls operation of function keys F1-F12. |

Table 14. System setup options—Keyboard menu (continued)



| Keyboard | |
|--|--|
| | Default: Lock Mode Standard |
| Keyboard Backlight Timeout on AC | |
| Keyboard Backlight Timeout on AC | Enables the user to define the timeout value for the keyboard backlight when an AC adapter is plugged into the system. Default: Never |
| Keyboard Backlight Timeout on Battery | |
| Keyboard Backlight Timeout on Battery | Enables the user to define the timeout value for the keyboard backlight when the system is operating only on battery power. Default: Never |
| RGB Per Key Keyboard Language | Enables the user to select the language that matches the keyboard installed on the system. Default: English US |
| |  WARNING: Selecting the incorrect language may cause the keyboard and lighting malfunction. |
| RGB Per Key Keyboard Color | Enables the user to select the keyboard color that matches the keyboard installed on the system. Default: Dark |
| |  WARNING: Selecting the incorrect language may cause the keyboard and lighting malfunction. |

Table 15. System setup options—Pre-boot Behavior menu

| Pre-boot Behavior | |
|------------------------------|--|
| Adapter warnings | |
| Enable Adapter warnings | Enables or disables the computer to display adapter warning messages when adapters with too little power capacity are detected. Default: ON |
| Warnings and Errors | |
| Warnings and Errors | Selects an action on encountering a warning or error during boot. Default: Prompt on Warnings and Errors. Stop, prompt, and wait for user input when warnings or errors are detected. |
| |  NOTE: Errors deemed critical to the operation of the computer hardware will always halt the computer. |
| USB-C Warnings | Specify the maximum number of characters allowed for Admin password. Default: 32 |
| Enable Dock Warning Messages | Enable or disable dock warning messages. Default: ON |
| Fastboot | |
| Fastboot | Configures the speed of the UEFI boot process. Default: Thorough. Performs complete hardware and configuration initialization during boot. |
| Extend BIOS POST Time | |
| Extend BIOS POST Time | Configures the BIOS POST (Power-On Self-Test) load time. |

Table 15. System setup options—Pre-boot Behavior menu (continued)

| | |
|--------------------------|--------------------|
| Pre-boot Behavior | |
| | Default: 0 seconds |

Table 16. System setup options—Virtualization Support menu

| | |
|--|--|
| Virtualization | |
| Intel® Virtualization Technology | |
| Enable Intel® Virtualization Technology (VT) | Enables the computer to run a virtual machine monitor (VMM). Default: ON |
| VT for Direct I/O | |
| Enable Intel® VT for Direct I/O | Enables the computer to perform Virtualization Technology for Direct I/O (VT-d). VT-d is an Intel method that provides virtualization for memory map I/O. Default: ON |

Table 17. System setup options—Performance menu

| | |
|--|---|
| Performance | |
| Multi-Core Support | |
| Active Cores | Changes the number of CPU cores available to the operating system. The default value is set to the maximum number of cores. Default: All |
| Intel SpeedStep | |
| Enable Intel® SpeedStep Technology | Enables or disables the Intel® SpeedStep Technology to dynamically adjust processor voltage and core frequency, decreasing average power consumption and heat production. Default: ON |
| C-States Control | |
| Enable C-State Control | Enables or disables the CPU's ability to enter and exit low-power states. Default: ON |
| Enable Adaptive C-States for Discrete Graphics | Allows to dynamically detect high usage of discrete graphics and adjust system parameters for higher performance during that time period. Default: ON |
| Intel Turbo Boost Technology | |
| Enable Intel® Turbo Boost Technology | Enabled or disabled the Intel® TurboBoost mode of the processor. If enabled, the Intel® TurboBoost driver increases the performance of the CPU or graphics processor. Default: ON |
| Intel Hyper-Threading Technology | |
| Enable Intel® Hyper-Threading Technology | Enabled or disabled the Intel® Hyper-Threading mode of the processor. If enabled, the Intel® Hyper-Threading increases the efficiency of the processor resources when multiple threads run on each core. Default: ON |
| Extreme Memory Profile | |
| Extreme Memory Profile | Enables the user to select one of two alternate memory time profiles, in order to take advantage of the fastest possible memory performance. Default: DIMM profile |

Table 17. System setup options—Performance menu (continued)

| Performance | |
|------------------------------|--|
| TCC Activation Offset | |
| TCC Activation Offset | Enables user to adjust CPU's Tcc offset to moderate the performance of the CPU. Default: 00 |

Table 18. System setup options—System Logs menu

| System Logs | |
|--------------------------|---|
| BIOS Event Log | |
| Clear BIOS Event Log | Select keep or clear BIOS events. Default: Keep Log |
| Thermal Event Log | |
| Clear Thermal Event Log | Select keep or clear Thermal events. Default: Keep Log |
| Power Event Log | |
| Clear Power Event Log | Select keep or clear Power events. Default: Keep Log |

System and setup password

Table 19. System and setup password

| Password type | Description |
|-----------------|--|
| System password | Password that you must enter to log on to your system. |
| Setup password | Password that you must enter to access and make changes to the BIOS settings of your computer. |

You can create a system password and a setup password to secure your computer.

 **CAUTION: The password features provide a basic level of security for the data on your computer.**

 **CAUTION: Anyone can access the data stored on your computer if it is not locked and left unattended.**

 **NOTE:** System and setup password feature is disabled.

Assigning a system setup password

Prerequisites

You can assign a new **System or Admin Password** only when the status is in **Not Set**.

About this task

To enter the system setup, press F12 immediately after a power-on or reboot.

Steps

1. In the **System BIOS** or **System Setup** screen, select **Security** and press Enter.
The **Security** screen is displayed.
2. Select **System/Admin Password** and create a password in the **Enter the new password** field.

Use the following guidelines to assign the system password:

- A password can have up to 32 characters.
- At least one special character: ! " # \$ % & ' () * + , - . / : ; < = > ? @ [\] ^ _ ` { | }
- Numbers 0 through 9.
- Upper case letters from A to Z.
- Lower case letters from a to z.

3. Type the system password that you entered earlier in the **Confirm new password** field and click **OK**.
4. Press Esc and save the changes as prompted by the pop-up message.
5. Press Y to save the changes.
The computer restarts.

Deleting or changing an existing system setup password

Prerequisites

Ensure that the **Password Status** is Unlocked (in the System Setup) before attempting to delete or change the existing System and/or Setup password. You cannot delete or change an existing System or Setup password, if the **Password Status** is Locked.

About this task

To enter the System Setup, press F12 immediately after a power-on or reboot.

Steps

1. In the **System BIOS** or **System Setup** screen, select **System Security** and press Enter.
The **System Security** screen is displayed.
2. In the **System Security** screen, verify that **Password Status** is **Unlocked**.
3. Select **System Password**, update, or delete the existing system password, and press Enter or Tab.
4. Select **Setup Password**, update, or delete the existing setup password, and press Enter or Tab.
 **NOTE:** If you change the System and/or Setup password, reenter the new password when prompted. If you delete the System and/or Setup password, confirm the deletion when prompted.
5. Press Esc and a message prompts you to save the changes.
6. Press Y to save the changes and exit from System Setup.
The computer restarts.

Clearing CMOS settings

About this task

 **CAUTION:** Clearing CMOS settings will reset the BIOS settings on your computer.

Steps

1. Remove the [base cover](#).
2. Disconnect the battery cable from the system board.
3. Press the power button for 20 seconds.
4. Wait for one minute.
5. Connect the battery cable to the system board.
6. Install the [base cover](#).

Clearing BIOS (System Setup) and System passwords

About this task

To clear the system or BIOS passwords, contact Dell technical support as described at www.dell.com/contactdell.

NOTE: For information on how to reset Windows or application passwords, refer to the documentation accompanying Windows or your application.

Updating the BIOS

Updating the BIOS in Windows

Steps

1. Go to www.dell.com/support.
2. Click **Product support**. In the **Search support** box, enter the Service Tag of your computer, and then click **Search**.
NOTE: If you do not have the Service Tag, use the SupportAssist feature to automatically identify your computer. You can also use the product ID or manually browse for your computer model.
3. Click **Drivers & Downloads**. Expand **Find drivers**.
4. Select the operating system installed on your computer.
5. In the **Category** drop-down list, select **BIOS**.
6. Select the latest version of BIOS, and click **Download** to download the BIOS file for your computer.
7. After the download is complete, browse the folder where you saved the BIOS update file.
8. Double-click the BIOS update file icon and follow the on-screen instructions.
For more information, see knowledge base article [000124211](https://www.dell.com/support/000124211) at www.dell.com/support.

Updating the BIOS using the USB drive in Windows

Steps

1. Follow the procedure from step 1 to step 6 in [Updating the BIOS in Windows](#) to download the latest BIOS setup program file.
2. Create a bootable USB drive. For more information, see the knowledge base article [000145519](https://www.dell.com/support/000145519) at www.dell.com/support.
3. Copy the BIOS setup program file to the bootable USB drive.
4. Connect the bootable USB drive to the computer that needs the BIOS update.
5. Restart the computer and press **F12**.
6. Select the USB drive from the **One Time Boot Menu**.
7. Type the BIOS setup program filename and press **Enter**.
The **BIOS Update Utility** appears.
8. Follow the on-screen instructions to complete the BIOS update.

Updating the BIOS from the F12 One-Time boot menu

Update your computer BIOS using the BIOS update.exe file that is copied to a FAT32 USB drive and booting from the F12 One-Time boot menu.

About this task

BIOS Update

You can run the BIOS update file from Windows using a bootable USB drive or you can also update the BIOS from the F12 One-Time boot menu on the computer.

Most of the Dell computers built after 2012 have this capability, and you can confirm by booting your computer to the F12 One-Time Boot Menu to see if BIOS FLASH UPDATE is listed as a boot option for your computer. If the option is listed, then the BIOS supports this BIOS update option.

NOTE: Only computers with BIOS Flash Update option in the F12 One-Time boot menu can use this function.

Updating from the One-Time boot menu

To update your BIOS from the F12 One-Time boot menu, you need the following:

- USB drive formatted to the FAT32 file system (key does not have to be bootable)
- BIOS executable file that you downloaded from the Dell Support website and copied to the root of the USB drive
- AC power adapter that is connected to the computer
- Functional computer battery to flash the BIOS

Perform the following steps to perform the BIOS update flash process from the F12 menu:

 **CAUTION: Do not turn off the computer during the BIOS update process. The computer may not boot if you turn off your computer.**

Steps

1. From a turn off state, insert the USB drive where you copied the flash into a USB port of the computer.
2. Turn on the computer and press F12 to access the One-Time Boot Menu, select BIOS Update using the mouse or arrow keys then press Enter.
The flash BIOS menu is displayed.
3. Click **Flash from file**.
4. Select external USB device.
5. Select the file and double-click the flash target file, and then click **Submit**.
6. Click **Update BIOS**. The computer restarts to flash the BIOS.
7. The computer will restart after the BIOS update is completed.

Troubleshooting

Handling swollen Lithium-ion batteries

Like most laptops, Dell laptops use lithium-ion batteries. One type of lithium-ion battery is the lithium-ion polymer battery. Lithium-ion polymer batteries have increased in popularity in recent years and have become standard in the electronics industry due to customer preferences for a slim form factor (especially with newer ultra-thin laptops) and long battery life. Inherent to lithium-ion polymer battery technology is the potential for swelling of the battery cells.

Swollen battery may impact the performance of the laptop. To prevent possible further damage to the device enclosure or internal components leading to malfunction, discontinue the use of the laptop and discharge it by disconnecting the AC adapter and letting the battery drain.

Swollen batteries should not be used and should be replaced and disposed of properly. We recommend contacting Dell product support for options to replace a swollen battery under the terms of the applicable warranty or service contract, including options for replacement by a Dell authorized service technician.

The guidelines for handling and replacing Lithium-ion batteries are as follows:

- Exercise caution when handling Lithium-ion batteries.
- Discharge the battery before removing it from the system. To discharge the battery, unplug the AC adapter from the system and operate the system only on battery power. When the system will no longer power on when the power button is pressed, the battery is fully discharged.
- Do not crush, drop, mutilate, or penetrate the battery with foreign objects.
- Do not expose the battery to high temperatures, or disassemble battery packs and cells.
- Do not apply pressure to the surface of the battery.
- Do not bend the battery.
- Do not use tools of any type to pry on or against the battery.
- If a battery gets stuck in a device as a result of swelling, do not try to free it as puncturing, bending, or crushing a battery can be dangerous.
- Do not attempt to reassemble a damaged or swollen battery into a laptop.
- Swollen batteries that are covered under warranty should be returned to Dell in an approved shipping container (provided by Dell)—this is to comply with transportation regulations. Swollen batteries that are not covered under warranty should be disposed of at an approved recycling center. Contact Dell product support at <https://www.dell.com/support> for assistance and further instructions.
- Using a non-Dell or incompatible battery may increase the risk of fire or explosion. Replace the battery only with a compatible battery purchased from Dell that is designed to work with your Dell computer. Do not use a battery from other computers with your computer. Always purchase genuine batteries from <https://www.dell.com> or otherwise directly from Dell.

Lithium-ion batteries can swell for various reasons such as age, number of charge cycles, or exposure to high heat. For more information on how to improve the performance and lifespan of the laptop battery and to minimize the possibility of occurrence of the issue, see [Dell Laptop Battery - Frequently Asked Questions](#).

SupportAssist diagnostics

About this task

The SupportAssist diagnostics (previously known as ePSA diagnostics) performs a complete check of your hardware. The SupportAssist diagnostics is embedded in the BIOS and is launched by it internally. The SupportAssist diagnostics provides a set of options for particular devices or device groups. It allows you to:

- Run tests automatically or in an interactive mode.
- Repeat tests
- Display or save test results
- Run thorough tests to introduce additional test options and provide extra information about the failed device(s)
- View status messages that indicate if the tests are completed successfully
- View error messages that indicate if problems were encountered during the test

 **NOTE:** Some tests are meant for specific devices and require user interaction. Ensure that you are present in front of the computer when the diagnostic tests are performed.

For more information, see [SupportAssist Pre-Boot System Performance Check](#).

System-diagnostic lights

Power and battery-status light

The power and battery status light indicates the power and battery status of the computer. These are the power states:

Solid white:Power adapter is connected and the battery has more than 5% charge.

Amber:Computer is running on battery and the battery has less than 5% charge.

Off:

- Power adapter is connected, and the battery is fully charged.
- Computer is running on battery, and the battery has more than 5% charge.
- Computer is in sleep state, hibernation, or turned off.

The power and battery-status light may also blink red or blue according to pre-defined "beep codes" indicating various failures.

For example, the power and battery-status light blinks red two times followed by a pause, and then blinks blue three times followed by a pause. This 2,3 pattern continues until the computer is turned off, indicating no memory or RAM is detected.

The following table shows different power and battery-status light patterns and associated problems.

i **NOTE:** The following diagnostic light codes and recommended solutions are intended for Dell service technicians to troubleshoot problems. You should only perform troubleshooting and repairs as authorized or directed by the Dell technical support team. Damage due to servicing that is not authorized by Dell is not covered by your warranty.

Table 20. Diagnostic-light LED codes

| Diagnostic light codes | Problem description |
|------------------------|--|
| 1,1 | TPM detection failure |
| 1,2 | Unrecoverable SPI Flash Failure |
| 1,3 | Short in hinge cable tripped OCP1 (camera/ touchpad) |
| 1,4 | Short in hinge cable tripped OCP2 (display) |
| 1,5 | EC unable to program i-Fuse |
| 1,6 | Generic catch-all for ungraceful EC code flow errors |
| 2,1 | Processor failure |
| 2,2 | System board: BIOS or ROM (Read-Only Memory) failure |
| 2,3 | No memory or RAM (Random-Access Memory) detected |
| 2,4 | Memory or RAM (Random-Access Memory) failure |
| 2,5 | Invalid memory installed |
| 2,6 | System-board or chipset error |
| 2,7 | Display failure - SBIOS message |
| 2,8 | Display failure - EC detection of power rail failure |
| 3,1 | RTC power failure |
| 3,2 | PCI, video card/chip failure |
| 3,3 | Recovery image not found |
| 3,4 | Recovery image found but invalid |
| 3,5 | Power-rail failure |
| 3,6 | System BIOS Flash incomplete |
| 3,7 | Management Engine (ME) error |

Recovering the operating system

When your computer is unable to boot to the operating system even after repeated attempts, it automatically starts Dell SupportAssist OS Recovery.

Dell SupportAssist OS Recovery is a standalone tool that is preinstalled in all Dell computers installed with Windows operating system. It consists of tools to diagnose and troubleshoot issues that may occur before your computer boots to the operating system. It enables you to diagnose hardware issues, repair your computer, back up your files, or restore your computer to its factory state.

You can also download it from the Dell Support website to troubleshoot and fix your computer when it fails to boot into their primary operating system due to software or hardware failures.

For more information about the Dell SupportAssist OS Recovery, see *Dell SupportAssist OS Recovery User's Guide* at www.dell.com/serviceabilitytools. Click **SupportAssist** and then, click **SupportAssist OS Recovery**.

Backup media and recovery options

It is recommended to create a recovery drive to troubleshoot and fix problems that may occur with Windows. Dell proposes multiple options for recovering Windows operating system on your Dell PC. For more information, see [Dell Windows Backup Media and Recovery Options](#).

WiFi power cycle

About this task

If your computer is unable to access the internet due to WiFi connectivity issues a WiFi power cycle procedure may be performed. The following procedure provides the instructions on how to conduct a WiFi power cycle:

 **NOTE:** Some ISPs (Internet Service Providers) provide a modem/router combo device.

Steps

1. Turn off your computer.
2. Turn off the modem.
3. Turn off the wireless router.
4. Wait for 30 seconds.
5. Turn on the wireless router.
6. Turn on the modem.
7. Turn on your computer.

Drain residual flea power (perform hard reset)

About this task

Flea power is the residual static electricity that remains in the computer even after it has been powered off and the battery is removed.

For your safety, and to protect the sensitive electronic components in your computer, you are requested to drain residual flea power before removing or replacing any components in your computer.

Draining residual flea power, also known as a performing a "hard reset", is also a common troubleshooting step if your computer does not power on or boot into the operating system.

To drain residual flea power (perform a hard reset)

Steps

1. Turn off your computer.
2. Disconnect the power adapter from your computer.
3. Remove the base cover.

4. Remove the battery.
5. Press and hold the power button for 20 seconds to drain the flea power.
6. Install the battery.
7. Install the base cover.
8. Connect the power adapter to your computer.
9. Turn on your computer.



 **NOTE:** For more information about performing a hard reset, see the knowledge base article [000130881](https://www.dell.com/support) at www.dell.com/support.

Getting help and contacting Alienware

Self-help resources



You can get information and help on Alienware products and services using these online self-help resources:

Table 21. Alienware products and online self-help resources

| Self-help resources | Resource location |
|---|---|
| Information about Alienware products and services | www.alienware.com |
| My Dell app |  |
| Tips |  |
| Contact Support | In Windows search, type Contact Support , and press Enter . |
| Online help for operating system | www.dell.com/support/windows |
| Access top solutions, diagnostics, drivers and downloads, and learn more about your computer through videos, manuals and documents. | Your Alienware computer is uniquely identified by a Service Tag or Express Service Code. To view relevant support resources for your Dell computer, enter the Service Tag or Express Service Code at www.dell.com/support . For more information on how to find the Service Tag for your computer, see Locate the Service Tag on your computer . |
| Videos providing step-by-step instructions to service your computer | www.youtube.com/alienwareservices |

Contacting Alienware

To contact Alienware for sales, technical support, or customer service issues, see www.alienware.com.

-  **NOTE:** Availability varies by country/region and product, and some services may not be available in your country/region.
-  **NOTE:** If you do not have an active Internet connection, you can find contact information about your purchase invoice, packing slip, bill, or Dell product catalog.