



Installation, Operation, and Maintenance Trane® Pivot™ Smart Thermostat



BAYSTAT814*

X39641353001

⚠ SAFETY WARNING

Only qualified personnel should install and service the equipment. The installation, starting up, and servicing of heating, ventilating, and air-conditioning equipment can be hazardous and requires specific knowledge and training. Improperly installed, adjusted or altered equipment by an unqualified person could result in death or serious injury. When working on the equipment, observe all precautions in the literature and on the tags, stickers, and labels that are attached to the equipment.

December 2022

BAS-SVX078F-EN

TRANE
TECHNOLOGIES



Introduction

The Trane® Pivot™ Smart Thermostat is a programmable thermostat that features a color touch-screen and an intuitive user interface for easy operation. With built-in remote access capability, users can easily perform tasks via a mobile device (iOS or Android).

Warnings, Cautions, and Notices

Safety advisories appear throughout this manual as required. Your personal safety and the proper operation of this machine depend upon the strict observance of these precautions.

The three types of advisories are defined as follows:



Indicates a potentially hazardous situation which, if not avoided, could result in death or serious injury.



Indicates a potentially hazardous situation which, if not avoided, could result in minor or moderate injury. It could also be used to alert against unsafe practices.



Indicates a situation that could result in equipment or property-damage only accidents.

⚠ WARNING

Proper Field Wiring and Grounding Required!

Failure to follow code could result in death or serious injury.

All field wiring **MUST** be performed by qualified personnel. Improperly installed and grounded field wiring poses **FIRE** and **ELECTROCUTION** hazards. To avoid these hazards, you **MUST** follow requirements for field wiring installation and grounding as described in NEC and your local/state/national electrical codes.

⚠ WARNING

Personal Protective Equipment (PPE) Required!

Failure to wear proper PPE for the job being undertaken could result in death or serious injury. Technicians, in order to protect themselves from potential electrical, mechanical, and chemical hazards, **MUST** follow precautions in this manual and on the tags, stickers, and labels, as well as the instructions below:

- Before installing/servicing this unit, technicians **MUST** put on all PPE required for the work being undertaken (Examples; cut resistant gloves/sleeves, butyl gloves, safety glasses, hard hat/bump cap, fall protection, electrical PPE and arc flash clothing). **ALWAYS** refer to appropriate Safety Data Sheets (SDS) and OSHA guidelines for proper PPE.
- When working with or around hazardous chemicals, **ALWAYS** refer to the appropriate SDS and OSHA/GHS (Global Harmonized System of Classification and Labelling of Chemicals) guidelines for information on allowable personal exposure levels, proper respiratory protection and handling instructions.
- If there is a risk of energized electrical contact, arc, or flash, technicians **MUST** put on all PPE in accordance with OSHA, NFPA 70E, or other country-specific requirements for arc flash protection, **PRIOR** to servicing the unit. **NEVER PERFORM ANY SWITCHING, DISCONNECTING, OR VOLTAGE TESTING WITHOUT PROPER ELECTRICAL PPE AND ARC FLASH CLOTHING. ENSURE ELECTRICAL METERS AND EQUIPMENT ARE PROPERLY RATED FOR INTENDED VOLTAGE.**

⚠ WARNING**Follow EHS Policies!**

Failure to follow instructions below could result in death or serious injury.

- All Trane personnel must follow the company's Environmental, Health and Safety (EHS) policies when performing work such as hot work, electrical, fall protection, lockout/tagout, refrigerant handling, etc. Where local regulations are more stringent than these policies, those regulations supersede these policies.
- Non-Trane personnel should always follow local regulations.

Copyright

This document and the information in it are the property of Trane, and may not be used or reproduced in whole or in part without written permission. Trane reserves the right to revise this publication at any time, and to make changes to its content without obligation to notify any person of such revision or change.

Trademarks

All trademarks referenced in this document are the trademarks of their respective owners.

Revision History

- New wiring diagram added (Symbio 700 with Non Variable Speed Blower).
- Modifications made to Binary Input Open/Closed states in Specifications section.
- Updates to content in FCC and IC Notices.



Table of Contents

Specifications	6
Contents and Accessories	7
Optional Equipment	7
Installation and Wiring	8
Location	8
Network Connections	8
Mounting	9
Wiring	11
Wiring Diagrams	12
System Setup	19
Power-up Sequence	19
Installation Wizard Overview	19
Installer Setup Screens	19
Settings	20
Service Reminders	27
Contractor Code	27
Software Updates	27
Pivot Mobile App Setup	27
Transferring the Account	27
Operation	29
PI Control	29
Load Values	29
Load Value, Heating	29
Load Value, Cooling	29
Duty Cycles	30
Overshoot Clamp	30
Staging	30
Stage Thresholds	30
Staging Inhibits	31
Modes	32
System Mode	32
Fan Mode	33
Advanced Operation	34
Control Response Rate	34
Dehumidification	34
Dehumidification System Operation	34
Dual Fuel Operations (Heat Pump with Aux Indoor Heat)	35
Lockouts	36

Humidifier Operation	36
Optimal Start/Stop	37
Open Automatic Demand Response (OADR)	37
Recovery	38
Ventilation Operation	38
Occupancy Signal	38
Warm Air Discharge	39
Wet Heat (Hydronic) Operation	39
Diagnostics	40
Test Modes	40
Save Logs	40
Diagnostics	40
History	41
System Report	41
Restore Factory Defaults	42
Troubleshooting	43
PIN Access Code	44
Pivot Smart Thermostat Support	45
FCC and IC Notices	46



Specifications

Specification	Description
Touch Screen Display	4.15 inches x 2.65 inches (4.3 inches diagonal)
Configurations	<ul style="list-style-type: none"> • Heat/cool • Dual fuel • Heat only • Cooling only • Heat pump
Maximum Number of Stages	<ul style="list-style-type: none"> • Conventional: Three heat/two cool • Heat pump: Two compressors, three auxiliary heat
Storage/Operating Temperatures	-40°F to 175°F, 5% to 95% RH non-condensing
Input Power	24 Vac
Power Consumption	3 VA typical, 7 VA maximum
Wire Usage	18 AWG (300 ft maximum for remote sensors)
System Modes	<ul style="list-style-type: none"> • Auto • Heating • Cooling • Off
Fan Modes	<ul style="list-style-type: none"> • Auto • On
Binary Input Open state	(RS1 or ODT input configured as a Binary Input). In order for the Binary Input to recognize an open signal, the external device, such as mechanical relay contacts (recommended gold-plated contacts), switch, solid state relay, or opto-isolator outputs must provide an open signal that measures greater than 330K ohms —preferably near infinite ohms. Binary Inputs are polarity sensitive, which may affect solid state relay and opto-isolator output operation.
Wi-Fi	Pivot supports IEEE 802.11b/g/n, 2.4GHz only.
Relay contact rating	2 Amps, 24 Vac

Specification	Description
Auxiliary Heat Lockout	32°F to 70°F
Compressor Heat Lockout	5°F to 70°F
Cooling Setpoint Temperature Range	60°F to 99°F, 1°F resolution
Heating Setpoint Temperature Range	55°F to 99°F, 1°F resolution
Indoor Temperature Display Range	-40°F to 122°F
Outdoor Temperature Display Range	-40°F to 147°F
Indoor Humidity Display Range	0% to 100%, 1% resolution
Minimum Cycle Off Time	<ul style="list-style-type: none"> • Compressor; 5 minutes • Indoor Heat; 1 minute
Mobile App operating system	Android and iOS
Binary Input Closed state	(RS1 or ODT input configured as a Binary Input). In order for the Binary Input to recognize a closed signal, the external device, such as mechanical relay contacts (recommended gold-plated contacts), switch, solid state relay, or opto-isolator outputs must provide a closed signal that measures less than 3.0K ohms — preferably near 0 ohms. Binary Inputs are polarity sensitive, which may affect solid state relay and opto-isolator output operation.
Ethernet	Pivot supports IEEE 802.3



Contents and Accessories

- One (1) Thermostat BAYSTAT814A
- One (1) Sub-base
- Three (3) #6, 18x1 Phillips Slotted Head Mounting Screws
- Three (3) #6x1 Nylon Drywall Anchors
- One (1) Installation, Operation, and Maintenance Guide
- One (1) RJ-45 Holder and Screw
- One (1) USB Adapter Cable (Micro USB Plug-to-Standard USB Receptacle)
- One (1) User Guide

Optional Equipment

Remote Zone Temperature Sensor (The following bullets have part numbers that reference the same part)

- Part Number X1351152801
- Unitary Part Number BAYSENS077A or ZZSENSAL0400AA
- Global Parts SEN01448

Remote Outdoor Sensor

- BAYSEN01ATEMPA

Note: Limit remote sensor wiring to 300 ft of 18 AWG.



Installation and Wiring

Location

The Pivot thermostat is designed for installation in climate controlled spaces. Use the following guidelines during installation:

- Place the unit in a central location with good air circulation.
- For proper temperature sensing, avoid exposing the unit to heat radiating from lamps, sunlight, fireplaces, or any other radiant heat sources.
- Avoid locations close to windows, behind doors or alcoves with poor circulation, adjoining outside walls, or doors leading to the outside.
- Select a location that prevents the unit from direct exposure to air currents from supply registers, ceiling diffusers, or ceiling fans.
- Mount the unit on a section of interior wall that does not contain hot/cold water pipes or duct work.

Note: The Pivot thermostat utilizes a 4.3 inch color touch screen which generates heat that is vented out of the top of the unit. If an air source is directed at or from above, heat from the screen can become trapped within the unit causing inaccurate indoor temperature readings. Refer to the illustration below.

Correct Location

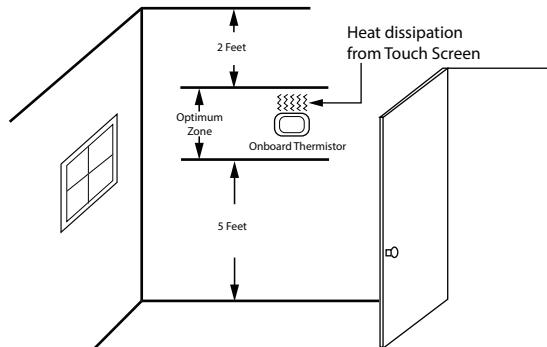

Incorrect Location

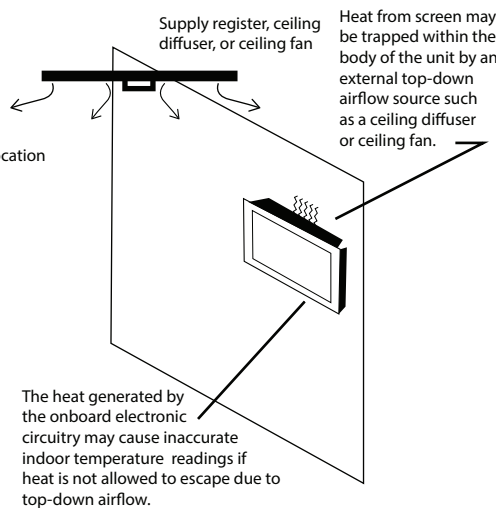

Network Connections

Connect the Pivot thermostat to the Internet (wireless or wired) for full advantage of the unit features.

- Wireless (Wi-Fi IEEE 802.11 b/g/n, 2.4 GHz only)

- Choose a mounting location that ensures adequate signal strength from the unit to the Internet router.
- Do not mount the unit more than 30 feet from the wireless router.
- For strong signal strength, ensure there are no more than three (3) interior walls between the unit and the router.
- Do not mount the unit in areas where electromagnetic emissions from other devices, appliances, or where wiring can interfere with communication to the unit.
- Do not mount the unit in recessed areas, near metal objects, or near structures.
- Do not have metal obstructions, concrete or brick walls between the unit and the router.
Do not mount the unit closer than 2 inches to any pipes, duct work, or other metal obstructions.
- Wired (Ethernet IEEE 802.3)
 - The Pivot thermostat can be connected to the Internet using the built-in RJ-45 connector. When using a wired connection, verify that a CAT 5, or better, Ethernet cable with an RJ-45 plug is present from the unit to the router.

Mounting

⚠ WARNING

Live Electrical Components!

Failure to follow all electrical safety precautions when exposed to live electrical components could result in death or serious injury.

When it is necessary to work with live electrical components, have a qualified licensed electrician or other individual who has been properly trained in handling live electrical components perform these tasks.

⚠ WARNING

Hazardous Voltage!

Failure to disconnect power before servicing could result in death or serious injury.

Disconnect all electric power, including remote disconnects before servicing. Follow proper lockout/tagout procedures to ensure the power can not be inadvertently energized. Verify that no power is present with a voltmeter.

***Note:** If replacing an existing unit, remove the unit from the wall, record the color/terminal markings of each wire, and disconnect the wires from old unit. Do not let the wires fall back through the wall.*

1. Turn off all power to cooling/heating equipment.
2. Remove the Pivot thermostat from the box and carefully pry the sub-base away from the unit with a flat-blade screwdriver.
3. Route the wires through the opening of the sub-base.
4. If using a wired Internet connection, route the Ethernet cable through the opening.
5. Place the sub-base against the wall in the desired location and mark the mounting holes as shown below.

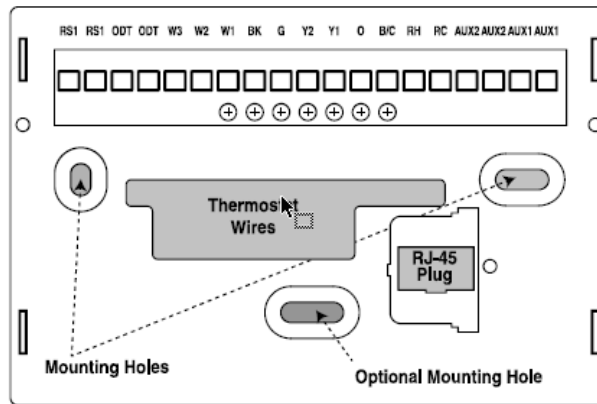

6. Drill the holes.

Note: An optional mounting hole is provided for more secure mounting.

Note: If using a wireless Internet connection, proceed to [Step 8](#).

7. When using a wired Ethernet connection:

- a. With the sub-base and RJ-45 properly oriented, press the holder into the sub-base as shown below.

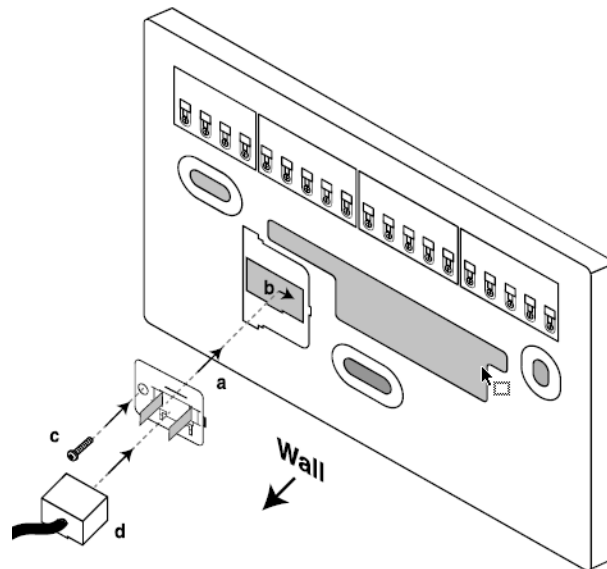

- b. Slide the holder to the right to snap it into place.
 - c. Secure the holder with provided screw.
 - d. Insert the RJ-45 connector into the RJ-45 holder until it snaps into place.
8. Mount the sub-base to the wall using the provided screws and drywall anchors.

Note: Ensure all wires extend through the hole in the sub-base as shown below.

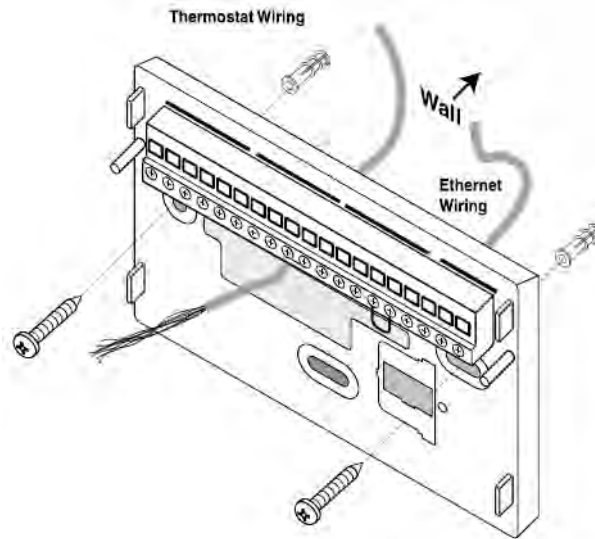

Wiring

1. Adjust the length and position of each wire so they reach the proper terminal on the connector block of the sub-base.
2. Strip away 0.25 inch of insulation from each wire. Do not allow adjacent wires to short together when connected.
3. Match and connect the unit wires to the proper terminals on the connector block.
4. Push excess wire back into the wall and seal the drilled hole to prevent air leaks.
5. Attach the unit to the sub-base.
6. Turn on power to the cooling/heating equipment.

Wiring Diagrams

Figure 1. Trane Reliabel 1 or 2 stage constant volume rooftop unit with non-variable speed blower

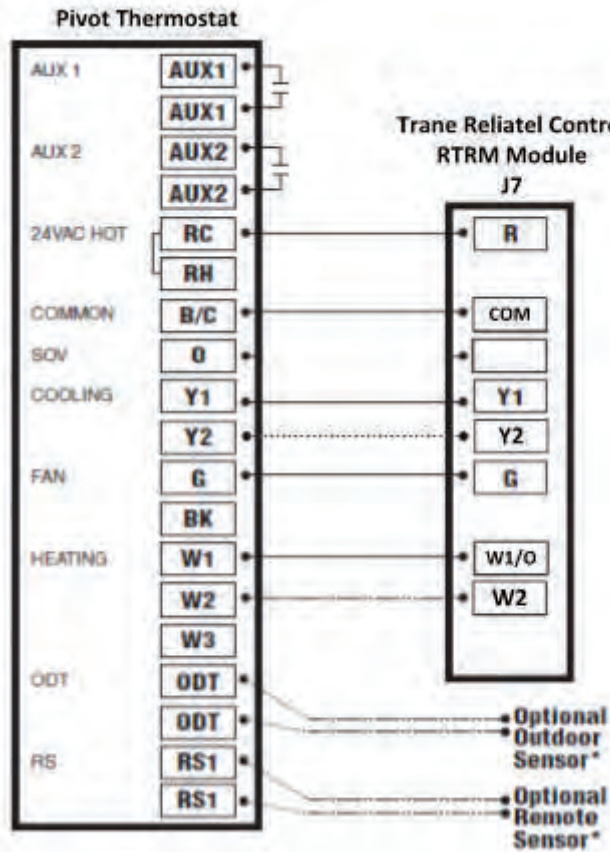

* Can be configured as Outdoor Air Sensor, Other Temperature, or a Binary Input using the Installer Setup. See System Setup section.

Important: Do not run Outdoor/Remote sensor wires in the same bundle with HVAC wires. Keep away from high voltage wiring to avoid interference.

Figure 2. Trane Reliabel 1 or 2 stage heat pump rooftop unit with non-variable speed blower

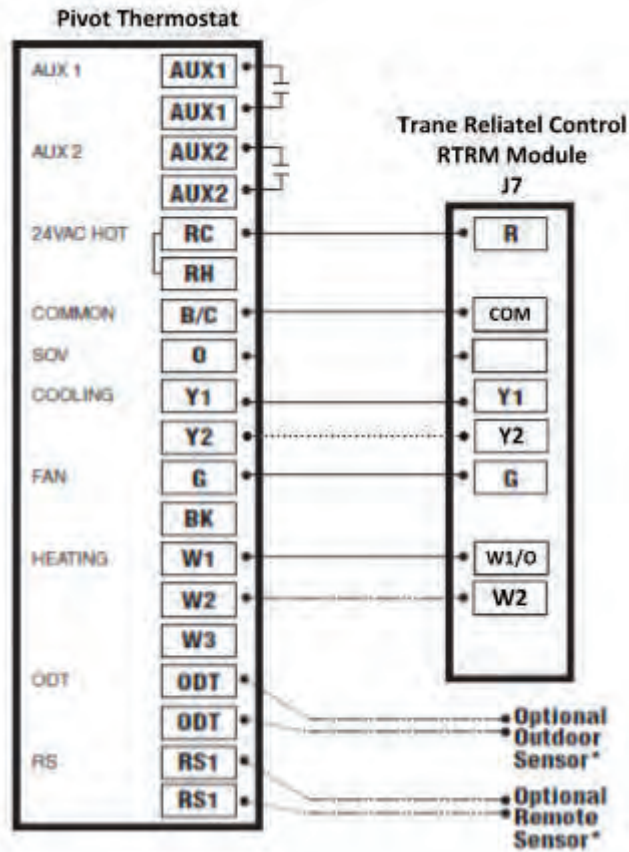

* Can be configured as Outdoor Air Sensor, Other Temperature, or a Binary Input using the Installer Setup. See System Setup section.

Important: Do not run Outdoor/Remote sensor wires in the same bundle with HVAC wires. Keep away from high voltage wiring to avoid interference.

Figure 3. Generic constant volume rooftop unit with non-variable speed blower

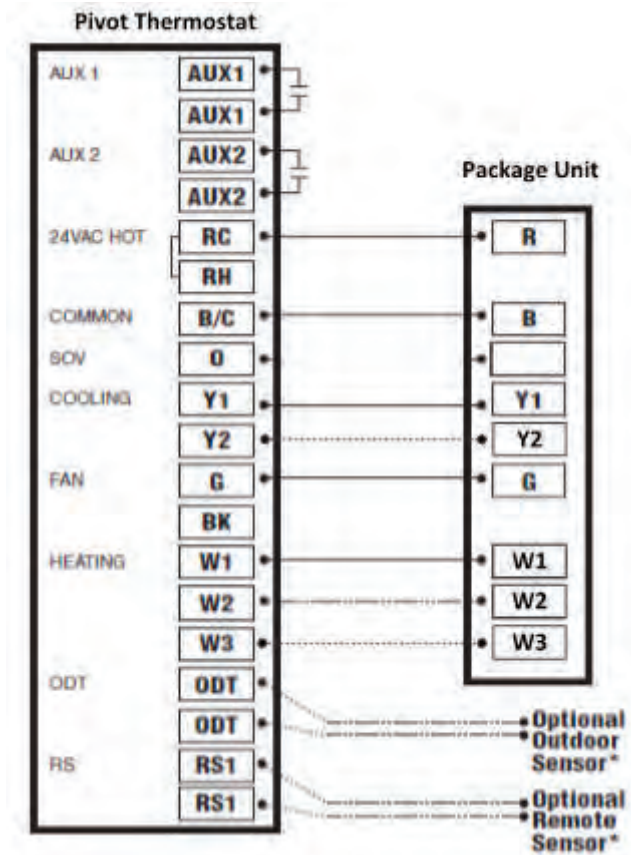

* Can be configured as Outdoor Air Sensor, Other Temperature, or a Binary Input using the Installer Setup. See System Setup section.

Important: Do not run Outdoor/Remote sensor wires in the same bundle with HVAC wires. Keep away from high voltage wiring to avoid interference.

Figure 4. Package 1 or 2 stage generic heat pump rooftop unit with non-variable speed blower

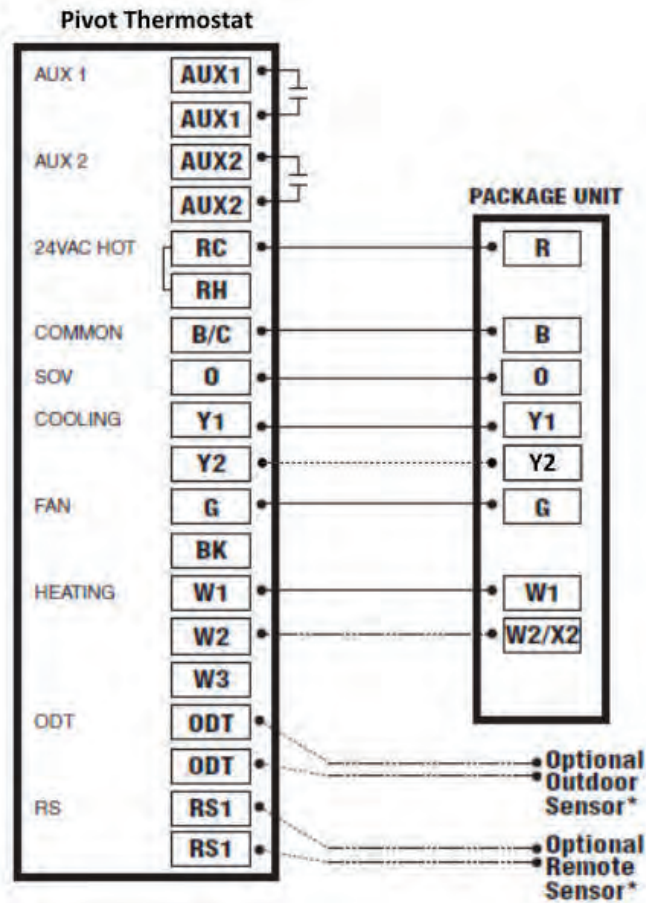

* Can be configured as Outdoor Air Sensor, Other Temperature, or a Binary Input using the Installer Setup. See System Setup section.

Important: Do not run Outdoor/Remote sensor wires in the same bundle with HVAC wires. Keep away from high voltage wiring to avoid interference.

Figure 5. ReliaTel constant volume with non-variable speed blower and occupancy signal for economizer

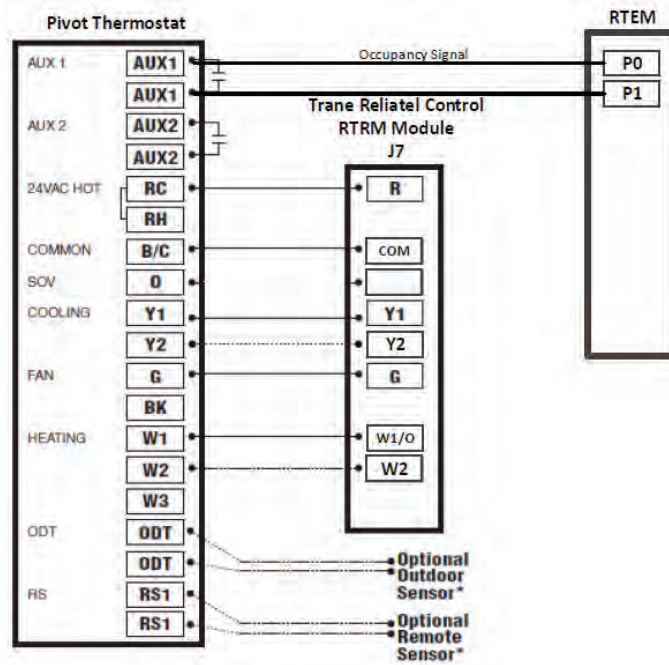

Trane ReliaTel RTEM Economizer Module

Aux 1 must be set up as a Ventilation output with minimum run time 60 minutes per hour. Done this way, AUX 1 output acts as an Occupancy signal. The output must be closed during unoccupied periods and open during occupied periods. See the Ventilation Operation section for more information.

* Can be configured as Outdoor Air Sensor, Other Temperature, or a Binary Input using the Installer Setup. See System Setup section.

Important: Do not run Outdoor/Remote sensor wires in the same bundle with HVAC wires. Keep away from high voltage wiring to avoid interference.

Figure 6. Trane ReliaTel 1 or 2 stage constant volume rooftop unit with non-variable speed blower and dehumidification

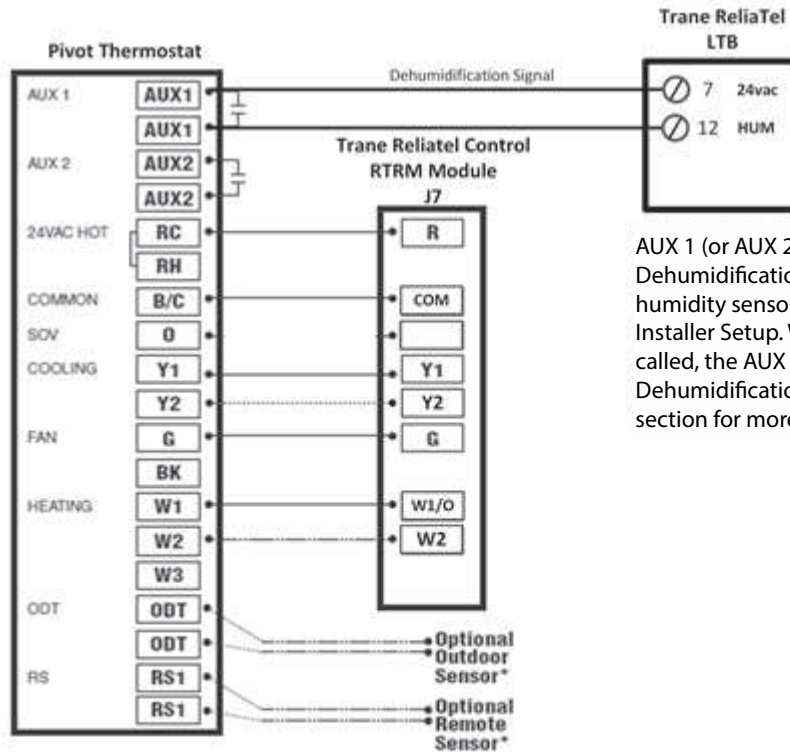

AUX 1 (or AUX 2) must be set up for Dehumidification and the on-board humidity sensor must be enabled in Installer Setup. When Dehumidification is called, the AUX output closes. See Dehumidification System Operation section for more information.

* Can be configured as Outdoor Air Sensor, Other Temperature, or a Binary Input using the Installer Setup. See System Setup section.

Important: Do not run Outdoor/Remote sensor wires in the same bundle with HVAC wires. Keep away from high voltage wiring to avoid interference.

Note: This is applicable for Hot Gas Reheat system only, and not for Enhanced Dehumidification system.

Note: For Trane residential equipment, refer to XL824 Installation Guide 18-HD72D1-6.

Figure 7. Symbio 700 with non-variable speed blower

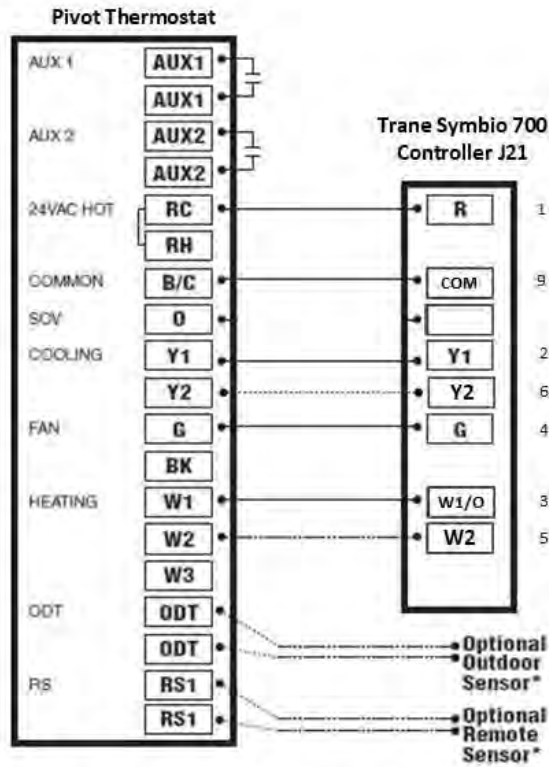

* Can be configured as Outdoor Air Sensor, Other Temperature, or a Binary Input using the Installer Setup. See System Setup section.

Important: Do not run Outdoor/Remote sensor wires in the same bundle with HVAC wires. Keep away from high voltage wiring to avoid interference.



System Setup

Power-up Sequence

The unit initiates a 90 to 120 second power-up sequence. During the sequence, the **Screen Calibration** option is made available for five (5) seconds. However, **Screen Calibration** is available for five (5) minutes if the screen has never been calibrated and following a **Restore Factory Defaults** command.

Note: *The Pivot thermostat comes factory calibrated.*

If the unit screen is not pressed within 5 minutes, the unit defaults to previously stored calibration settings. The unit can be re-calibrated any time by rebooting the unit.

Note: *Temperature display may be inaccurate until the unit acclimates to ambient room temperature. This may take up to one (1) hour.*

Installation Wizard Overview

The **Installation Wizard** displays when:

- The unit is initially powered on.
- The **Restore Factory Defaults** function is invoked.
- Selected from Service Menu (**Home > Menu > Service > Technician Access** (press for 5 seconds) **>Proceed > Service Menu > Installation Wizard or Installer Setup**).

Note: *A PIN access code may have been previously set up on the thermostat by the building owner, which may restrict access to the Menu screen and/or Service screen. If PIN access has been set up, the thermostat will display a notification when attempting to access the Menu or Service screen. In this case, the technician must obtain the PIN access code from the building owner or request to have the thermostat unlocked.*

The wizard setup guides the installer through:

- Time/Date
Set the current time/date and set Daylight Saving Time to On/Off.
- Installer Setup
Configure the basic equipment components installed and customize how the unit operates.
- Service Reminders
Various service reminders can be enabled based on the system configuration, such as, System, Filter, Ventilation, UV Light, and Humidifier. The frequency can be selected based on calendar or runtime days.
- Contractor Identification Code
The contractor identification code is used to populate the contractor contact information and associate the unit with a Pivot contractor portal account. The contractor's primary telephone number is entered to activate this feature.

Note: *Only units connected to the Internet will auto-populate the contractor information.*

Installer Setup Screens

Individual parameters are configured and edited from the Installer Setup screens. Use the up/down arrows to scroll through groups of settings. To change a setting within a specific group, press **Edit** and then press **Next** to navigate to the desired setting. Press **Save** to retain changes or **Exit** to discard changes.



System Setup

Settings

Table 1. Group 1 standard settings

Menu Item	Options [Default]	Description
Cooling Type	None [Cooling Only]/ Heat Pump	Select the type of outdoor unit installed
Cooling Stages	[Single Stage], Two Stage	Select the number of outdoor unit stages.
Compressor Type	Single Compressor Two Stage, [Two Compressor Two Stage]	Select the compressor type for multi-stage outdoor units.
Heating Type	[Gas/Oil], Electric, Hydronic	Select the type of indoor unit installed.
Heat Stages	[Single Stage], Two Stage, Three Stage	Select the number of heat stages
Blower Type	Variable, [Non-Variable] ^(a)	Select the blower type [Constant Torque motors are considered non-variable speed] ^(a)
SOV Operation	[with Cooling Call], with Heating Call	Select which mode of operation energizes the switch-over valve.

^(a) Variable speed applies only to supported Trane residential equipment

Table 2. Group 2 equipment settings

Menu Item	Options [Default]	Description
Compressor Cooling Cycles per Hour	2 to 6 Cph [3]	Select the number of cycles per hour during cooling operation.
1st Stage Compressor Cooling Cycles Per Hour	2 to 6 Cph [3]	Select the cycles per hour during 1st stage cooling operation
2nd Stage Compressor Cooling Cycles Per Hour	2 to 6 Cph [3]	Select the number of cycles per hour during 2nd stage cooling operation
Compressor Heating Cycles Per Hour	2 to 6 Cph [3]	Select number of cycles per hour during compressor heating operation.
1st Stage Compressor Heating Cycles Per Hour	2 to 6 Cph [3]	Select the minimum runtime [MRT] of stage 1 heat
2nd Stage Compressor heating Cycles Per Hour	2 to 6 Cph [5]	Select the minimum runtime [MRT] of stage 2 heat
Heating Cycles Per Hour	2 to 6 Cph [5]	Select the number of cycles per hour during heat operation
1st Stage Heat Cycles Per Hour	2 to 6 Cph [5]	Select the number of cycles per hour during 1st stage heat operation
2nd Stage Heat Cycles Per Hour	2 to 6 Cph [5]	Select the number of cycles per hour during 2nd stage heat operation
3rd Stage Heat Cycles Per Hour	2 to 6 Cph [5]	Select the number of cycles per hour during 3rd stage heat operation

Table 3. Group 3 sensor settings

Menu Item	Options [Default]	Description
Use Internet Weather**	[No]*, [Yes]	<p>This menu item is asking if the installer wants to use Internet Weather as a temperature source for lockouts during heat pump operation, temperature overrides for outdoor air temperature ventilation, or outdoor temperature for Optimal Start/Stop calculations.</p> <p>See Outdoor Air Sensor Priority section below if both Internet Weather and a wired OAT sensor are desired as primary and secondary source for outdoor air temperature.</p> <p>*During initial installer setup, the only choice will be 'No' because an Internet connection does not yet exist and therefore Internet Weather has not yet been set up. After an Internet connection is made and Internet Weather is set up (via the User Setup Wizard on the Settings Menu), the default changes to Yes, and No is also a choice.</p> <p>Even if No is selected, Internet Weather values will still be available to display on the Home screen on the Outdoor Temperature widget. To display Internet Weather on the Outdoor Temperature widget, navigate to Home > Menu > Settings > Thermostat > Temperature Calibration > Select Internet Weather under Outdoor Sensor column.</p>
Configure ODT Input**	[None] Outdoor Air Temperature Other Temperature Binary Input	<p>Outdoor Air Temperature and Other Temperature requires wiring a 10K Type 2 thermistor sensor to ODT Input. See Optional Equipment section for sensor part numbers.</p> <p>Outdoor Air Temperature (OAT) will be used for temperature lockouts, overrides, and Optimal S/S calculations.</p> <p>The Outdoor Air Temperature value can also be displayed on the Home screen Outdoor Temperature widget if enabled. To display ODT Input, Outdoor Air Temperature value on the Outdoor Temperature widget, navigate to Home > Menu > Settings > Thermostat > Temperature Calibration > Select Local OAT Sensor under Outdoor Sensor column.</p> <p><i>Note: Internet forecast and sky conditions in the widget will continue to be displayed in the widget with temperature from ODT input.</i></p> <p>Other Temperature can be selected to display a temperature other than outdoor air. The value can be displayed on the thermostat Home screen as a widget, and on the mobile app. It is not used for lockouts, overrides or any other calculation or control.</p> <p>Binary Input responds to an open or closed external contact such as a mechanical relay, and displays the state on the thermostat Home screen and on the mobile app.</p>
ODT Other Temperature Input Label	[Input ODT], Installer entered name	<p>Pressing the Input ODT button brings up a keypad allowing the installer to name the button, such as "Discharge Air". The input value will be available on a widget that can be displayed on the Home screen by navigating to Home > Menu > Settings > Screen > Screen Layout > [button label], and in the mobile app. The value is not used for lockouts or any other control.</p> <p><i>Note: Special characters exist that cannot be used in the name.</i></p>

Table 3. Group 3 sensor settings (continued)

Menu Item	Options [Default]	Description
ODT Binary Input Label	[Input ODT], Installer entered name	Pressing the Input ODT button brings up a keypad allowing the installer to name the button, such as "Occupancy". The input value will be available on a widget that can be displayed on the Home screen by navigating to Home > Menu > Settings > Screen > Screen Layout > [button label] , and in the mobile app. The state is not used for any other control. <i>Note: Special characters exist that cannot be used in the name.</i>
ODT Binary Input Open State Label	[Open], Installer entered name	Installer can rename the Open state using up to 20 characters, for example, "Occupied." <i>Note: Special characters exist that cannot be used in the name.</i>
ODT Binary Input Closed State Label	[Closed], Installer entered name	Installer can rename the Closed state using up to 20 characters, for example, "Unoccupied." <i>Note: Special characters exist that cannot be used in the name.</i>
Configure RS1 Input	[None] Remote Space Temperature Other Temperature Binary Input	Remote Space Temperature and Other Temperature requires wiring a 10K Type 2 thermistor sensor to RS1 Input. See Optional Equipment section for sensor part numbers. Remote Space Temperature value will be displayed directly on the Home screen. Other Temperature can be selected to display a temperature other than Remote Space Temperature. The value can be displayed on the thermostat Home screen as a widget, and on the mobile app. It is not used for lockouts, overrides or any other calculation or control. Binary Input responds to an open or closed external contact such as a mechanical relay and displays the state on the thermostat Home screen and on the mobile app.
RS1 Input Other Temperature Label	[Input RS1], Installer entered name	Pressing the Input RS1 button brings up a keypad allowing the installer to name the button, such as "Discharge Air". The input value will be available on a widget that can be displayed on the Home screen by navigating to Home > Menu > Settings > Screen > Screen Layout > [button label] , and in the mobile app. The value is not used for lockouts, overrides, or any other control. <i>Note: Special characters exist that cannot be used in the name.</i>
RS1 Binary Input Label	[Input RS1], Installer entered name	Pressing the Input RS1 button brings up a keypad allowing the installer to name the button, such as "Occupancy". The input state will be available on a widget that can be displayed on the Home screen by navigating to Home > Menu > Settings > Screen > Screen Layout > [button label] , and in the mobile app. The state is not used for any control. <i>Note: Special characters exist that cannot be used in the name.</i>
RS1 Binary Input Open State Label	[Open], Installer entered name	Installer can rename the Open state using up to 20 characters, for example, "Occupied." <i>Note: Special characters exist that cannot be used in the name.</i>
RS1 Binary Input Closed State Label	[Closed], Installer entered name	Installer can rename the Closed state using up to 20 characters, for example, "Unoccupied." <i>Note: Special characters exist that cannot be used in the name.</i>

Table 3. Group 3 sensor settings (continued)

Menu Item	Options [Default]	Description
Select Zone Temperature Sensor	[Onboard] Remote	If RS1 Input has been configured for None, Other Temperature or Binary Input, the only choice will be Onboard. Remote requires wiring a 10K Type 2 thermistor sensor to RS1 Input. See Optional Equipment section for sensor part number. Temperature value will be displayed on the Home Screen.
Thermostat Humidity Sensor	[Enable], Disable	This screen only shows up in Installer Setup if RS1 is configured as Remote Space Temperature allowing the installer to disable the on-board humidity sensor if desired. When RS1 is configured for None, Other Temperature, or Binary, the on-board humidity sensor is enabled by default and cannot be disabled. Humidity value can be displayed on the Home screen by navigating to Home > Menu > Settings > Screen > Screen Layout > Indoor Humidity widget , and in the mobile app. In addition to displaying on the Home screen or mobile app, the humidity value is also used for humidification and dehumidification control. Humidity can also be set up for high and low alerts in the mobile app. See Alerts section in User Guide.

****Outdoor Air Temperature Priority**

Both a wired outdoor air temperature sensor and Internet Weather can be enabled when a backup source of outdoor air temperature is desired. When both are enabled, a priority sequence is followed. If the higher priority source fails, the next lower priority will be used. The priority sequence is as follows when a sensor is wired to ODT input and Internet Weather is enabled:

1. Wired ODT input (configured as Outdoor Air Temperature)
2. Internet Weather
3. None (unrestricted mode)

If you disable Wired ODT input by selecting None, Other Temperature, or Binary Input for Configure ODT Input in the Installer Setup menu, there will be no back up source. The priority sequence then becomes:

1. Internet Weather
2. None (unrestricted mode)

If you disable Internet Weather by selecting “No” for *Use Internet Weather* in the Installer Setup menu, there will be no back up source. The priority sequence then becomes:

1. Wired ODT input (configured as Outdoor air Temperature)
2. None (unrestricted mode)

Failure Modes

- If Wired ODT input fails, a fault will be sent.
- If Internet Weather goes offline for more than 12 hours, the control will revert to None (unrestricted mode) and will use the last reported temperature value for up to 12 hours. After 12 hours, the display shows double dashes.

Table 4. Group 4 accessories settings

Menu Item	Options [Default]	Description
Filtration Type Installed	Air Cleaner, [Media Filter]	Select the filter type installed
Humidifier Installed	[None], Yes	Select whether a humidifier is installed
Humidifier — Select Aux Contact ^(a)	[Aux1], Aux2	Select which set of Aux contacts is controlling the humidifier

Table 4. Group 4 accessories settings (continued)

Menu Item	Options [Default]	Description
Humidifier Type	[Powered/Bypass], Steam	Select what type of humidifier is installed
Humidifier Control	[RH Control], Frost Control	Select how the humidifier will be controlled [A wired Outdoor Air Temperature sensor must be connected to ODT input and ODT input must be set to Outdoor Air Temperature to allow Frost Control to be selected.]
Humidifier Fan Action	[Humidity with active Heat Call], Humidity without active Heat Call	Select when the humidifier is allowed to operate.
Airflow During Humidifier Only Mode	35% to 100%	Select the desired airflow when the humidifier is operating without an active call for heat — requires variable speed blower. ^(b)
UV Light Installed	[None], Yes	Select whether a UV Light is installed.
Ventilation installed	[None], Yes	Select whether ventilation is installed.
Ventilation — Select Aux Contact	Aux1, [Aux2]	Select which set of Aux contacts is controlling the ventilation system.
Ventilation Relay	[On Ventilation Closed], On Ventilation Open ^(c)	Select whether ventilation is on when contact relay is closed or open.
Minimum Ventilation Run Time	0–60 Minutes, [5 Minutes] ^(c)	Select minimum runtime per hour for ventilation system.
Ventilation Fan Action	[Ventilate with Blower], Ventilate without Blower	Select whether ventilation will run with the fan or without the fan. Ventilate with blower – Ventilation is provided through the roof top unit. Ventilate without blower – Ventilation will be provided by a dedicated ventilation system.
Outdoor Air Temperature Ventilation Override	[Disable], Enable	Select whether an outdoor temperature override is allowed (Outdoor air temperature sensor must be connected and enabled, or Internet Weather enabled to allow this setting to be selected).
Ventilation — Minimum Outdoor Air Temperature	-10°F to 50°F [0°F]	Select the minimum outdoor temperature that ventilation is allowed.
Ventilation — Maximum Outdoor Air Temperature	80°F to 110°F [0°F]	Select the maximum outdoor temperature that ventilation is allowed.
Accumulate Overridden Runtime	[No], Yes	Select whether the overridden ventilation runtime will be made up.
Accumulated Period	[4 hours – recover based on outdoor conditions] 24 hours – recover based on outdoor conditions 4 hours – recover to maintain minimum ventilation 24 hours – recover to maintain minimum ventilation	Select when to recover missed ventilation runtime due to outdoor conditions exceeding the minimum/maximum outdoor temperature setting (The first two options will not meet ASHRAE 62.2 Standard for minimum ventilation requirements).
Dehumidification Installed	[None], Yes	Select whether a dehumidifier is installed.
Dehumidification — Select Aux Contact ^(a)	Aux1, [Aux2]	Select which set of aux contacts is controlling the ventilation system.
Dehumidification Control Options	[Stand alone Operation], With Active Call for Cooling Only	Select when the dehumidifier is allowed to operate.
Run System Fan with Dehumidification Request	Yes, [No]	Select if the indoor fan should operate with a call for dehumidifier operation.

^(a) There are only two Aux outputs. You can only activate two accessories once both of the Aux outputs are used, other accessories will not be displayed.

^(b) Variable speed applies only to supported Trane residential equipment

^(c) For a Trane ReliaTel controls with Economizer configure minimum runtime for ventilation at 60 minutes per hour, blower with interlock, and ventilate on open for relay configuration. This configuration will tell the economizer when occupied provide minimum ventilation.

Table 5. Group 5 comfort settings

Menu Item	Options [Default]	Description
Dehumidification	[Enable], Disable	Select if enhanced dehumidification features are enabled. Reduces airflow up to 30% on residential equipment using the BK terminal. See Airflow Reduction section for more details.
Dehumidification Overcooling Limit — Degrees	[0°F] to 3°F	Select the maximum amount of overcooling allowed when the indoor humidity exceeds the cooling target humidity setpoint.
Smart Continuous Fan	Enable, [Disable]	Select to enable or disable Smart Continuous Fan.
Control Response Rate	[Normal], Fast	Select the response rate of the control.
Aggressive Recovery > 2° Setpoint Change	Enable, [Disable]	Select whether the 10-minute staging inhibit is disabled compressor (heating or cooling mode) with a setpoint change greater than 2°.
Heating Aggressive Recovery by outdoor Air Temperature	Enable, [Disable]	Select whether the 10-minute staging inhibit is disabled during compressor heating mode when the outdoor temperature falls below the selected outdoor temperature (Outdoor Air temperature sensor must be connected and enabled to allow the setting to be selected).
Heating Aggressive Recover Setting	0°F to 70°F, [40°F]	Select the outdoor temperature for compressor Heating Aggressive Recovery.
Warm Air Discharge	Enable, [Disable]	When enabled, the indoor airflow will be limited to 80% on a call for heat pump heating. This only applies to heat pump heating with no call for aux heat (an indoor unit with a variable speed blower is required). ^(a)

^(a) Variable speed applies only to supported Trane residential equipment

Table 6. Group 6 airflow settings

Menu Item	Options [Default]	Description
VS Blower On Delay — Clg	[No Delay], Enhanced Mode, 7.5 Minutes @ 80% 4 Minutes @ 80% 1 Minutes @ 50% 30 Seconds	Select the blower on delay for cooling operation. Enhanced Mode is a tiered Blower on Delay for variable speed blowers only (1 minute at 50%, 7.5 minutes at 80%, then 100%). ^(a)
Non VS Blower On Delay — Clg	[No Delay], 15 Seconds 30 Seconds	Select the blower on delay for cooling operation.
VS Blower Off Delay — Clg	[No Delay], 1.5 Minutes @ 100% 45 Seconds @ 100% 30 Seconds @ 100% 1.5 Minutes @ 50% 3 Minutes @ 50% 30 Seconds @ 35%	Select the blower off delay for cooling operation.
Non VS Blower Off Delay — Clg	[No Delay], 30 Seconds 60 Seconds 90 Seconds	Select the blower off delay for cooling operation.
VS Blower On Delay — Comp Htg	[No Delay], Enhanced Mode 7.5 Minutes @ 80% 4 Minutes @ 80% 1 Minute @ 50% 30 Seconds	Select the blower on delay for compressor heating operation. Enhanced Mode is a tiered Blower on Delay for variable speed blowers only (1 minute at 50%, 7.5 minutes at 80%, then 100%). ^(a)
Non VS Blower On Delay — Comp Htg	[No Delay], 15 Seconds 30 Seconds	Select the blower on delay for compressor heating operation.

Table 6. Group 6 airflow settings (continued)

Menu Item	Options [Default]	Description
VS Blower Off Delay — Comp Htg	[No Delay], 1.5 Minutes @ 100% 45 Seconds @ 100% 30 Seconds @ 100% 1.5 Minutes @ 50% 3 Minutes @ 50% 30 Seconds @ 35%	Select the blower off delay for compressor heating operation.
Non VS Blower Off Delay — Comp Htg	[No Delay], 30 Seconds 60 Seconds 90 Seconds	Select the blower off delay for compressor heating operation.
Hydronic Heat Blower On Delay	[No Delay], 30 Seconds 60 Seconds	Select the blower on delay for hydronic heating operation.
Hydronic Heat Blower Off Delay	[No Delay], 30 Seconds 60 Seconds 90 Seconds	Select the blower off delay for hydronic heating operation.
Compressor 1st Stage Air Flow% — Comp Clg	35% to 60%, [50%]	Select the 1st stage air flow for a two stage/two compressor unit in cooling mode.
Compressor 1st Stage Air Flow % — Comp Clg	55% to [80%]	Select the 1st stage air flow for a two stage/single compressor unit in cooling mode
Compressor 1st stage Air Flow% — Comp Htg	35% to 60% [50%]	Select the 1st stage air flow for a two stage/two compressor unit in heating mode
Compressor 1st stage Air Flow% — Comp Htg	55% to [80%]	Select the 1st stage air flow for a two stage/single compressor unit in heating mode.

^(a) Variable speed applies only to supported Trane residential equipment

Table 7. Group 7 lockout (Must have OAT enabled to use either Internet Weather or a sensor wired to ODT input for Group 7 to appear)

Menu Item	Options [Default]	Description
Auxiliary Heat Lockout	[Disable], Enable	Enable auxiliary heat lockout (10°F minimum separation when enabling auxiliary heat lockout and compressor heat lockout)
Auxiliary Heat Lockout Setting	32°F to 70°F, [45°F]	Select an outdoor temperature to prevent auxiliary heat above the selected outdoor temperature.
Compressor Lockout	[Disable], Enable	Enable compressor heat lockout (10°F minimum separation when enabling auxiliary heat lockout and compressor heat lockout)
Compressor Lockout Setting	5°F to 70°F, [30°F]	Select an outdoor temperature to prevent compressor heating below the selected outdoor temperature
Defrost Heater Balance Point (W1)	[Disable], Enable	Enable defrost heater balance point for W1 and W2 (only applicable when indoor heat is electric or hydronic)
Defrost Heater Balance Point (W1) Setting	40°F to 55°F, [55°F]	Select an outdoor temperature to disallow 1st, 2nd and 3rd stage of indoor heat during defrost above this temperature
Defrost Heater Balance Point (W2)	[Disable], Enable	Enable defrost heater balance point for W1 and W2 (only applicable when indoor heat is electric or hydronic)
Defrost Heater Balance Point (W2) Setting	10°F to 50°F, [40°F]	Select an outdoor temperature to disallow 2nd and 3rd stage of indoor heat during defrost above this temperature

Table 7. Group 7 lockout (Must have OAT enabled to use either Internet Weather or a sensor wired to ODT input for Group 7 to appear) (continued)

Menu Item	Options [Default]	Description
Defrost Heater Balance Point (W3)	[Disable], Enable	Enable defrost heater balance point for W3 only (only applicable when indoor heat is electric or hydronic)
Defrost Heater Balance Point (W3)	5°F to 45°F, [25°F]	Select an outdoor temperature to disallow 3rd stage of indoor heat during defrost above this temperature
Compressor Cooling 1st Stage Lockout	[Disable], Enable	Enable compressor cooling 1st stage lockout
Compressor Cooling 1st Stage Lockout Setting	80°F to [120°F]	Select an outdoor temperature to force the system 2nd stage compressor cooling
Compressor Heating 1st Stage Lockout	[Disable], Enable	Enable compressor heating 1st stage compressor heating lockout
Compressor Heating 1st Stage Lockout Setting	0°F to [50°F]	Select an outdoor temperature to force the system to 2nd stage compressor heating
1st Stage Lockout	[Disable], Enable	Enable furnace heating 1st stage lockout
1st Stage Lockout Setting	0°F to [50°F]	Select an outdoor temperature to force the system to 2nd stage furnace heating

Service Reminders

Reminders can be enabled to trigger an alert when service is required. The reminder is time-based and can be configured on system run time or calendar days. Reminders can be configured for humidifiers, filters, ventilation systems, UV lights, and HVAC system maintenance. The type of reminders available are based on the accessories enabled in the installer settings.

Contractor Code

When a Pivot thermostat is connected to the internet, a contractor code can be entered to auto-populate the contractor's contact information and logo. The code is the contractor's registered phone number listed on ComfortSite. The contractor code is also used to associate the thermostat with a specific contractor on the Contractor Diagnostic Portal. If contractors do not have an account in ComfortSite, they will need to work with their local Trane office to set up the account. The contractor information required in the thermostat can be left blank until a contractor account has been set up in ComfortSite. At the thermostat navigate to **Home > Menu > Service > Contractor Code > Next >**. Enter the contractor phone number registered in Comfortsite.

Software Updates

Software updates will occur automatically when the Pivot thermostat is connected to the internet. To manually force the thermostat to update, navigate to **Home > Menu > Reboot**. The thermostat will update within an hour, provided you do not touch the screen.

Note: The thermostat will only update if an update is available.

Pivot Mobile App Setup

The Pivot Mobile App allows the customer to remotely connect to the thermostat to view status and make changes. It may be necessary or expected for the installer to help customers set up their mobile device and connect to the Pivot thermostat. Refer to the Trane Pivot Smart Thermostat User Guide (BAS-SVU044) for information on creating an account and adding users and thermostats to the account.

Transferring the Account

It may be necessary for the installer to set up an account while installing and configuring the Pivot thermostat. It is now possible for the installer to transfer this account over to the building owner when installation is complete.



System Setup

1. From the Pivot mobile app, tap **Transfer Account**.
2. Follow the on-screen directions to transfer the installer account over to the building owner.
Upon successful transfer of the account, the building owner then becomes the account owner.



Operation

PI Control

The Pivot thermostat uses proprietary control schemes to provide comfort and energy efficiency. The unit senses the indoor temperature and determines capacity required based on the following:

- Mode of Operation
- Proportional Error- Distance from Setpoint
- Integral Error- Time Away from Setpoint

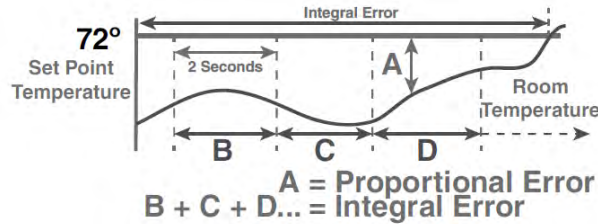

Load Values

Load Value, Heating

The Pivot thermostat uses proportional, plus integral error, to determine the amount of capacity required. The calculated capacity is displayed as load value. Load value is a numerical representation of the needed capacity to maintain setpoint and the range is dependent on the applied system.

0-100	Single Stage Heat Pump Only
0-200	Two State Heat Pump Only
0-200	Single Stage Heat Pump + 1 Stage Electric/Wet Heat
0-300	Single Stage Heat Pump + 2 Stage Electric/Wet Heat
0-400	Single Stage Heat Pump + 3 Stage Electric/Wet Heat
0-300	Two Stage Heat Pump + 1 Stage Electric/Wet Heat
0-400	Two Stage Heat Pump + 2 Stage Electric/Wet Heat
0-500	Two Stage Heat Pump + 3 Stage Electric/Wet Heat
0-100	Single Stage Indoor Heat Only
0-200	Two Stage Indoor Heat Only
0-300	Three Stage Indoor Heat Only
0-175	Single Stage Heat Pump + 1 Stage Gas/Oil Heat
0-275	Single Stage Heat Pump + 2 Stage Gas/Oil Heat
0-375	Single Stage Heat Pump + 2 Stage Gas/Oil Heat
0-275	Two Stage Heat Pump + 1 Stage Gas/Oil Heat
0-375	Two Stage Heat Pump + 2 Stage Gas/Oil Heat
0-475	Two Stage Heat Pump + 3 Stage Gas/Oil Heat

Load Value, Cooling

- 0 to 100; single stage compressor
- 0 to 200; two-stage compressor

A load value of 50 represents a request of 50% demand for single stage cooling units (Y) or 50% demand for state one of multi-stage cooling unit (Y1). A load value of 150 represents a request of 100% demand for stage one (Y1) and 50% demand of stage two (Y2) for multi-stage cooling units.

Duty Cycles

Indoor temperature control is achieved by duty-cycling the equipment when the load value is less than 100% of the current stage of operation. The duty cycle rate is dependent on the calculated load value. The illustration below shows the number of cycles at 50% load, for example, LV = 50.

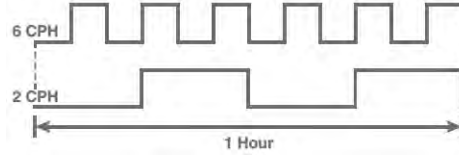

With all PI-based controls, the indoor temperature fluctuates above/below the user-selected setpoint to maintain comfort in the space. Adjusting the factory Cycles Per Hour (CPH) can affect how tight the unit operates around the setpoint. The CPH can be adjusted by navigating to **Installer Setup > Equipment Settings** (Group 2).

- Factory default for compressor operation = 3 CPH
- Factory default for indoor heat = 5 CPH

The effects of changing the cycle rates:

- Lower CPH results in longer run cycles with less cycling, but the indoor temperature may deviate above/below setpoint.
- Higher CPH results in tighter indoor temperature control, but shorter and more frequent cycles.

Overshoot Clamp

The Pivot thermostat enforces an Off Cycle anytime the control overshoots more than 2.5°F. Once the indoor temperature is within 0.75°F of setpoint, an ON Cycle is allowed dependent on load value and minimum Off times. Refer to the following illustration showing cooling overshoot clamping.

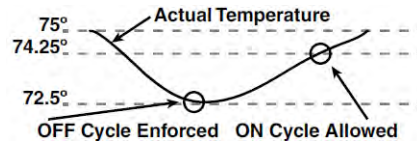

Staging

Stage Thresholds

The threshold that allows operation is a load value greater than 5 and operation is always terminated with a load value less than 1. In addition, load value determines when additional stages of operation are requested. To prevent rapid cycling between stages, a stage threshold is enforced. The stage threshold is dependant on the applied system. See examples of staging thresholds below.

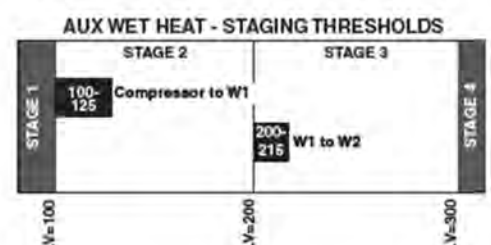
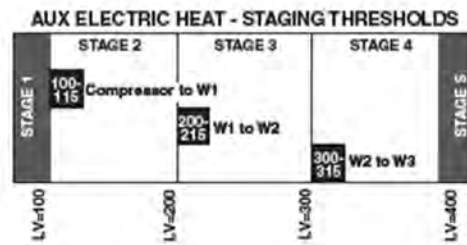
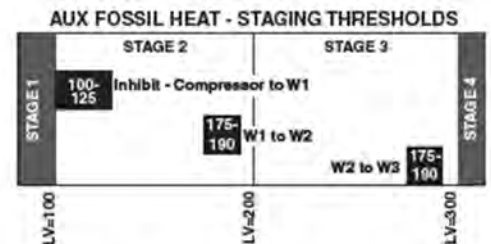
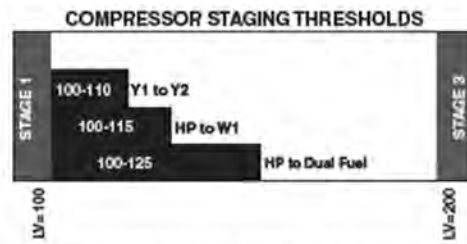

Staging Inhibits

When the stage threshold is exceeded, a stage inhibit is applied. The stage inhibit calculates the rate of recovery over a 10 minute period and determines if the next stage is required to meet the current demand. If the rate of recovery is great enough, a new 10 minute inhibit is enabled. The unit will not go to the next stage of operation until it determines that the current stage cannot satisfy the current demand. Stage inhibits apply only between compressor stages and compressor heat to Aux indoor heat. Stage inhibits do not apply to non-compressor heat stages. Stage inhibits are disabled by navigating to **Installer Setup > Comfort Settings > Aggressive Recovery**. See examples of staging inhibits below.

Stage Inhibits - Compressor Staging

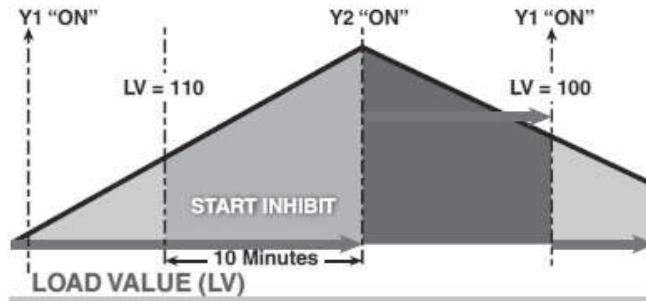

Stage Inhibits - Compressor Heat to Aux Heat

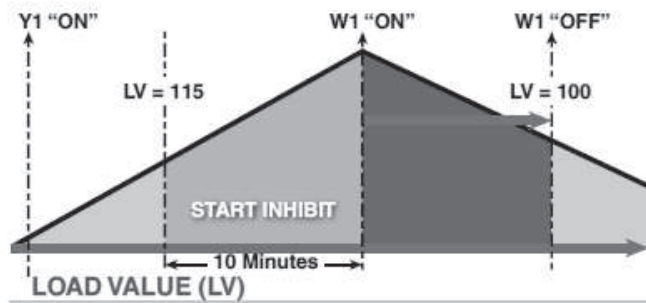

Stage Inhibits - Dual Fuel

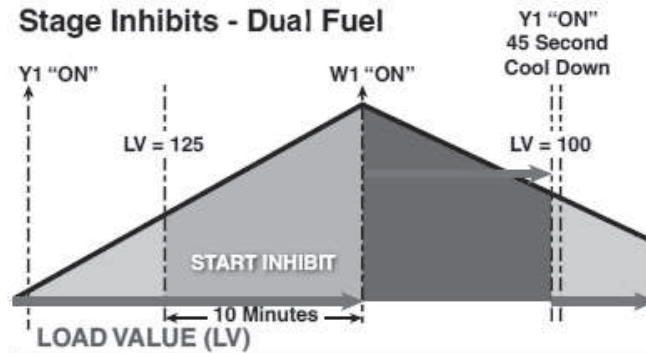

Modes

System Mode

The Pivot thermostat has five (5) system modes:

- Heating; system only operates in heating mode.
 - Cooling; system only operates in cooling mode.
 - Off; system does not operate in either heating/cooling modes.
 - Emergency Heating; system operates only the indoor heat source.
- Note:** Only available when the outdoor unit type is a heat pump.
- Auto; the unit determines which mode of operation based on the following rules:
 - The indoor temperature is \leq heating setpoint.
 - The indoor temperature is \geq cooling setpoint or within 1°F of cooling setpoint.

Note: There is a minimum deadband between heating/cooling setpoints of 3°F.

Fan Mode

The Pivot thermostat has two (2) fan modes:

- Auto; fan runs only with a call for heating or cooling.
- On; fan runs continuously while in occupied mode. In unoccupied mode the fan will only run when there is a call for heating or cooling.



Advanced Operation

Control Response Rate

Note: *Installer Setup is located under the Service Menu. Navigate to **Home > Menu > Service > Technician Access** (press for 5 seconds) >**Proceed > Service Menu > Installation Wizard or Installer Setup.***

Control response rate provides the capability of selecting a set of higher proportional-integral control constants to increase the responsiveness of the unit. Selecting *fast* will cause the unit to generate load value as a faster rate. Control response rate is adjusted by navigating to **Installer Setup > Comfort Settings.**

Dehumidification

Dehumidification is enabled/disabled by navigating to **Installer Setup > Comfort Settings.**

The Pivot thermostat uses the following methods of dehumidification:

- Over-cooling
 - If cooling is enabled, the unit will allow 0.1°F of over-cooling for each 1% of RH error. A maximum amount of over-cooling can be configured for 1°F, 2°F, or 3°F. When the system is actively over-cooling, **Dehumidifying** displays on the unit home screen. The maximum amount of over-cooling is configured by navigating to **Installer Setup > Comfort Settings.** Refer to the following example.

EXAMPLE OF OVERCOOLING WITH MAXIMUM CONFIGURED AT 2°			
TARGET HUMIDITY	ACTUAL HUMIDITY	PERCENT OF RH ERROR	DEGREES OF OVERSHOOT
40%	45%	5%	0.5° Overshoot
40%	55%	15%	1.5° Overshoot
40%	65%	25%	2.0° Overshoot
40%	70%	30%	2.0° Overshoot

- Smart continuous fan
 - If enabled, continuous fan operation interrupts when indoor RH exceeds desired cooling RH target. A humidity icon displays along with the fan icon to indicate that continuous fan operation has been disabled due to high humidity conditions. Smart continuous fan will not interrupt the fan circulate mode. This option is enabled by navigating to **Installer Settings > Comfort Settings > Smart Continuous Fan.**
- Airflow reduction (applies only to Trane residential variable speed blowers)
 - If BK is connected, the unit can reduce the system airflow by 30% anytime the indoor RH is higher than the cooling RH target. Airflow reduction is disallowed if the indoor temperature is more than 2°F above the cooling setpoint. Dehumidification is factory enabled by navigating to **Installer Setup > Comfort Settings.** All *Fan Off* delays are also defeated when dehumidification is enabled and the indoor RH exceeds the cooling RH target.

Dehumidification System Operation

The Pivot thermostat is capable of enabling the dehumidification system through the normally open (NO) dry AUX contacts on the unit sub-base. Control options are:

- Stand-alone operation
 - Dehumidifier operates independently from cooling operation as long as the unit is in cooling or auto mode and the last call is for cooling. When selecting stand-alone operation, the unit allows the selection of whether the indoor fan operates with the dehumidifier request.

- Active call for cooling only
 - Dehumidifier can operate only during an active call for cooling.

Dehumidifier control options are accessed by navigating to **Installer Setup > Accessories Settings**.

Note: *Pivot thermostat has an onboard humidity sensor which can be enabled through **Installer Setup > Sensor Settings**.*

Dual Fuel Operations (Heat Pump with Aux Indoor Heat)

The Pivot thermostat can control a dual fuel system without the need of an external dual fuel kit.

Important: *An outdoor temperature sensor must be installed and enabled for restricted modes to be available.*

Dual fuel operations:

- Non-restricted mode (Thermostat uses non-restricted mode when you have heat pump with aux heat, but no outdoor air sensor)
 - The unit determines which heat mode operates to maintain comfort based on the calculated system load value. With a load value in compressor heating range, the heat pump operates and if the load value raises to auxiliary heat range, the heat pump cycles Off and the auxiliary heat source cycles On. Once the load value falls below the auxiliary heat range, the auxiliary heat cycles Off and the heat pump cycles back On.
- Restricted mode (only compressor heat — Thermostat has ODT and lockouts setup)
 - When restricted mode is enabled, an outdoor temperature lockout can be set to disable compressor heating operation. When the outdoor temperature falls below the compressor heat lockout, the system only operates on auxiliary heat source. At any temperature above the compressor heat lockout, the system operates the same as non-restricted mode, heat pump, or auxiliary heat that are allowed based on system load value. When the compressor heat is locked out, the outdoor temperature must rise at least 4°F above the compressor heat lockout setting above, allowing compressor heat again. Refer to the illustration below.

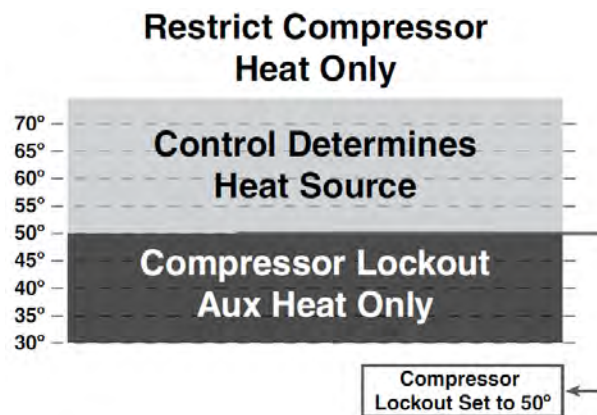

- Restricted mode (compressor and auxiliary heat — Thermostat has ODT and lockouts setup)
 - When the outdoor temperature is above the auxiliary heat lockout, only compressor heat is allowed.
 - When the outdoor temperature falls below the compressor heat lockout, only auxiliary heat is allowed.
 - When the outdoor temperature is between the compressor heat lockout and auxiliary heat lockout, the system operates the same as non-restricted mode, heat pump, or auxiliary heat is allowed based on system load value.

There is a 10°F minimum deadband between the compressor heat lockout and auxiliary heat lockout. Once the compressor heat or auxiliary heat is locked out, the outdoor temperature must rise or fall at least 4°F above or below the lock setting before allowing compressor or auxiliary heat again. Refer to the following illustration.

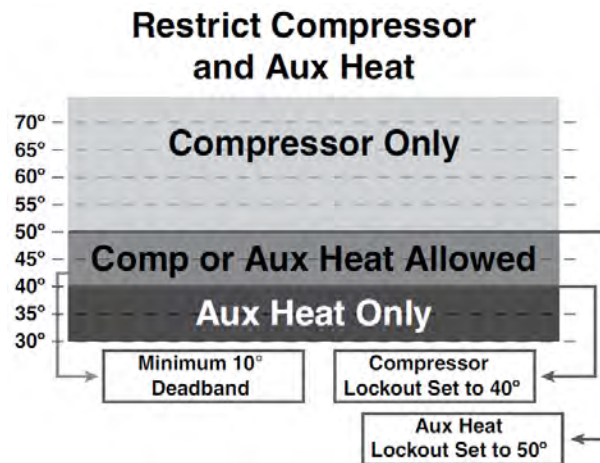

Note: An outdoor temperature sensor must be enabled for lockout settings to be available. Lockout options are set by navigating to *Installer Setup > Lockout Settings*.

Lockouts

The Pivot thermostat lockout methods are:

- Auxiliary heat lockout
 - When enabled, select an outdoor temperature which disables auxiliary heat anytime the outdoor temperature is above the selected temperature. Compressor heat is allowed.
- Compressor lockout
 - When enabled, select an outdoor temperature which disables compressor heat anytime the outdoor temperature is below the selected temperature. Auxiliary heat is allowed.

Note: When enabling auxiliary heat lockout and compressor heat lockout, there is a minimum of 10°F deadband between the two settings.
- Defrost heater balance point (W1)
 - When enabled, select an outdoor temperature which disables all electric heat during defrost above the selected temperature.
- Defrost heater balance Point (W2)
 - When enabled, select an outdoor temperature which disables the 2nd and 3rd stages of electric heat during defrost above the selected temperature.
- Defrost heater balance Point (W3)
 - When enabled, select an outdoor temperature which disables the 3rd stage of electric heat during defrost above the selected temperature.
- Compressor cooling 1st stage lockout
 - When enabled, select an outdoor temperature which forces the 2nd stage compressor cooling operation anytime the outdoor temperature is above the selected temperature.
- Compressor heating 1st stage lockout
 - When enabled, select an outdoor temperature which forces the 2nd stage compressor heating operation anytime the outdoor temperature is below the selected temperature.
- Heating 1st stage lockout
 - When enabled, select an outdoor temperature which forces the 2nd stage non-compressor heating operation anytime the outdoor temperature is below the selected temperature.

Humidifier Operation

The Pivot thermostat is capable of controlling humidification through the normally open (NO) dry AUX contacts on the unit sub-base. The humidifier operation methods are:

- RH control
 - Dry contacts are closed anytime the indoor humidity is less than the heating target relative humidity.
- Frost control
 - The unit references the outdoor temperature through a wired outdoor air temperature sensor and structure integrity to offset the heating target relative humidity. This helps to limit the risk of frost or condensation from forming on interior walls and windows. A scale of 1 to 10 is provided based on the insulation properties and expected leakage of the building (1 = Leaky with poor insulation and 10 = very tight with good insulation). The unit can be setup to allow dehumidification anytime in heating mode or only when actively heating. The airflow during humidifier-only is factory set to 100%. However, it can be adjusted between 35% and 100%, requiring a variable speed indoor blower with BK connected. All humidifier control options are accessed by navigating to **Installer Setup > Accessories Settings**. Refer to the following illustration.

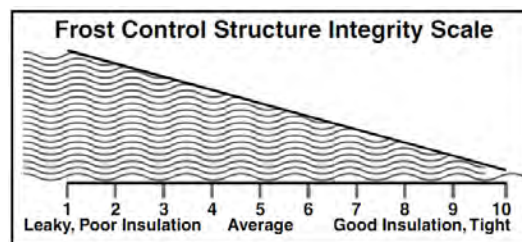

Optimal Start/Stop

Optimal Start is an enhancement to Occupied/Unoccupied scheduling. If Scheduling is disabled on the Pivot thermostat, Optimal Start will not be available.

Optimal Start is a strategy that calculates equipment to make the space comfortable (that is, be at its occupied setpoints) at the occupied time. Optimal Start is a preoccupied event. When the Optimal Start algorithm brings the equipment on, the thermostat will switch to the occupied setpoints; however, the equipment's OA damper remains closed. Thus, no ventilation occurs during optimal start.

The user shall be able to enable and disable Optimal Start. If Optimal Start is enabled, the user shall be able to specify the maximum early start time in minutes. Both of these items are entered on a configuration screen.

Optimal Stop is an enhancement to Occupied/Unoccupied scheduling. If scheduling is disabled on the Pivot thermostat, Optimal Stop will not be available.

Optimal Stop is a control strategy that calculates how early, in minutes, the equipment can save energy by "coasting" to its shutdown. Unlike Optimal Start, Optimal Stop is an occupied event. When Optimal Stop begins, the thermostat switches to use the unoccupied setpoints.

The equipment will do less heating or cooling while using unoccupied setpoints and the space should "coast" into the unoccupied mode. The equipment still must deliver Outside Air to the space until the unoccupied time; thus, ventilation of the space continues during Optimal Stop.

The user can enable and disable Optimal Stop. If Optimal Stop is enabled, the user shall be able to specify the maximum early stop time in minutes. Both of these items are entered on a configuration screen.

Optimal Start and Stop can be enabled by navigating to **Menu > Settings > Optimal Start/Stop**.

Open Automatic Demand Response (OADR)

Users can participate in energy saving programs offered by utilities and energy aggregators using OADR features in the thermostat. When enrolled in this program, the utility or energy aggregator will send a signal to the thermostat which will help reduce energy consumption by automatically setting the cooling setpoints higher or the heating setpoints lower. Typically these events last for a few hours and



only occur on peak energy demand days. The Pivot thermostat now has OADR screens which allows it to participate in these events if the user chooses.

To register your thermostat in the Demand Response program, navigate to **Home > Menu > System Info > Demand Response > Registration**.

The **URL** and **Port Number** will be from the utility or aggregator website. The **VEN ID** is an identity you create for your thermostat.

Recovery

The Pivot thermostat uses a stage inhibit to limit equipment staging. The stage inhibit can be disabled by two methods:

- Aggressive recovery disables stage inhibits in heating/cooling mode anytime the setpoint is adjusted more than 2°F.
- Heating aggressive recovery disables stage inhibits in only heating mode when the outdoor temperature falls below the selected outdoor temperature.

Ventilation Operation

The Pivot thermostat is capable of controlling a ventilation system through a configurable dry AUX contact on the unit sub-base. All ventilation operation control options are accessed by navigating to **Installer Setup > Accessories Settings**. Refer to figure 5, "Reliabel constant volume with non-variable speed blower and occupancy signal" in the Wiring Diagrams section for a wiring example.

- Ventilation only runs during scheduled occupied periods.
- The blower can be configured for interlocked on a call for ventilation (Ventilator Fan Action).
- The ventilation runtime per hour can be adjusted to meet ASHRAE 62 standards for acceptable indoor air quality by setting up Minimum Ventilation Runtime.
- Temperature override can be set to prevent ventilation operation when the outdoor temperature exceeds the minimum or maximum outdoor temperature settings. (Ventilation – Minimum Outdoor Air Temperature and Ventilation - Maximum Outdoor Air Temperature).
- Missed Ventilation Runtime. A selection can be made to accumulate the missed ventilation runtime. The following ventilation accumulate options will only be displayed as a choice in the Installer Setup when all of the following four options are set up as described:
 - **Use Internet Weather** is set to Yes, and/or ODT Input is configured for outdoor air temperature sensor (**Installer Setup > Sensor Settings**).
 - A valid postal code must be configured in the weather settings if using Internet Weather for outdoor air temperature (**Home > Menu > Settings > Weather**).
 - **Outdoor Air Temperature Ventilation Override** is enabled (**Installer Setup > Accessories Settings**).
 - **Accumulate Overridden Run Time** is Yes (**Installer Setup > Accessories Settings**).

Ventilation accumulate options (Installer Setup > Accessories Settings > Accumulate Period):

- Accumulate missed ventilation runtime in 4–hour increments and make up when the outdoor temperature is within the min/max settings.
- Accumulate missed ventilation runtime in 24–hour increments and make up when the outdoor temperature is within the min/max settings.
- Accumulate missed ventilation runtime in 4–hour increments and make up at the end of the 4–hour period.
- Accumulate missed ventilation runtime in 24–hour increments and make up at the end of the 24–hour period.

Occupancy Signal

If the thermostat is running a schedule and an occupancy output signal is necessary, follow these steps using **Installer > Setup > Accessories Settings**.

1. Enable Ventilation and select an AUX output.
2. select whether you want the occupancy signal output relay to be open when occupied or closed when occupied.
3. Set the Minimum Ventilation Runtime to 60 minutes per hour. When set up this way, the Ventilation Aux output will be on during occupied periods, and off during unoccupied periods, and therefore will act as an occupancy output signal,

Refer to figure 5 in the Wiring section for an example of a typical Trane installation.

Warm Air Discharge

Enabling warm air discharge with BK connected reduces the variable speed blower airflow by 20% when in compressor heating operation. Warm air discharge only applies to compressor heating and is disabled when hydronic, fossil fuels, or electric heat (that includes supplemental heat) modes are activated. Warm air discharge is accessed by **Installer Setup>Comfort Settings**.

Wet Heat (Hydronic) Operation

A hot water coil can be applied to either a variable speed or non-variable speed indoor unit. The hot water coil can be the sole source of heat or used as auxiliary heat when applied with a heat pump. When applied with a heat pump, wet heat is considered auxiliary heat and operates in conjunction with heat pump heat. Switching the system mode to emergency heat would disable the heat pump and cycle the wet heat only.

If applied with a variable speed air handler with BK connected, the blower speed during wet heat only, varies based on the system load value. The airflow ranges from 35% to 100%, depending on the system load value. When applied with a heat pump, the blower speed during heat pump and wet heat operation is the higher of the two airflows. There are separate blower On/Off delays for wet heat on the unit.

The unit is designed to operate a forced air system and should not be applied to non-forced air systems, such as radiant floors, radiator, and so forth). The hydronic heat blower delay options are accessed by navigating to **Installer Setup > Airflow Settings**.



Diagnostics

All screens in the Diagnostics section can be accessed by navigating to **Home > Menu > Service > Technician Access** (press for 5 seconds) **>Proceed > Service Menu**.

Note: A PIN access code may have been previously set up on the thermostat by the building owner, which may restrict access to the Menu screen and/or Service screen. If PIN access has been set up, the thermostat will display a notification when attempting to access the Menu or Service screen. In this case, the technician will have to obtain the PIN access code from the building owner or request to have the thermostat unlocked.

Test Modes

All test modes automatically terminate after 60 minutes or can be done manually at any time. Access test modes by navigating to **Service Menu > Test Modes**.

Mode	Settings	Description
Test Blower	<ul style="list-style-type: none"> 50% 100% 	Energize blower at the selected speed.
Test Cool	<ul style="list-style-type: none"> Stage 1 Stage 2 	Energize the selected stage of cooling operation. The blower also operates at the speed required for the selected stage.
Test Compressor Heat	<ul style="list-style-type: none"> Stage 1 Stage 2 	Energize the selected stage of heating operation. The blower also operates at the speed required for the selected stage.
Test Indoor Heat (Auxiliary Heat)	<ul style="list-style-type: none"> Stage 1 Stage 2 Stage 3 	Energize the selected stage of auxiliary heating operation. The blower operation is dependent on the heat type: <ul style="list-style-type: none"> Electric- blower energized during test mode, but the blower speed is controlled by the unit. Fossil- blower is controlled independently by the unit during test mode. Hydronic- blower is energized during test mode.
Test Compressor and Indoor Heat (Auxiliary Heat)	<ul style="list-style-type: none"> Aux Heat1 Aux Heat2 Aux Heat3 	Energizes all stages of compressor heat and selected stage of indoor (Aux) electric heat/hydronic heat. The blower is energized and runs at the higher of the compressor heat airflow versus indoor heat airflow.
Test Aux Relay	<ul style="list-style-type: none"> AUX 1 AUX 2 	Closes the normally open (NO) AUX contacts. The blower is not energized during this test mode.

Save Logs

The Pivot thermostat is capable of logging data on a USB flash drive. Attach the USB drive to the USB connector (included) and plug it into the unit and select Save Logs under the Service menu. The amount of data logged is dependent on the number of days logged and the storage capability of the USB flash drive. To access Save Logs, navigate to **Service Menu > Save Logs**. Saved Logs are generally used by Pivot Tech Support when diagnosing an issue.

Diagnostics

The Pivot thermostat diagnostics has two (2) alert screens:

- Current alerts; alerts which are currently active.

- Alert history; cleared alerts of the last 30 days.
- From both screens, an alert code can be selected and get additional information on the alert as well as a list of possible causes.

Note: Each alert has a date/time stamp of when the alert was nullified. The date/time stamp for current alerts occurs when the alert was declared. For alert history, the date/time stamp is when the alert was nullified.

All alerts are categorized by severity:

- Critical
 - Loss of heating/cooling operation.
 - Service call required.
 - Alert messages displayed on the home screen. When closed, a flashing red icon indicates the alert condition.
- Major
 - Reduced functionality; minimum operation is possible.
 - Service call is not immediately required.
 - Alert messages displayed on the home screen, but a yellow icon indicates the alert condition.

Note: Critical/major alerts can be displayed on the home screen by pressing the alert icon on the shortcut tool bar. Diagnostics are accessed by navigating to **Service Menu > Diagnostics**.

- Normal
 - Functionality may be lost, but should recover or the information is for diagnostic purposes/performance monitoring.
 - Service call not required.
 - Normal alerts are only displayed on the diagnostic screen.

History

History allows the technician to view cycle count and runtime data for each mode and stage of operation of the system. History is accessed by navigating to **Service Menu > History**. Refer to the example below.

	TODAY	LAST 7 DAYS	CURRENT MONTH	LAST MONTH
Y1 COOLING	0 ¹ /0 ²	0 ¹ /0 ²	0 ¹ /0 ²	0 ¹ /0 ²
Y2 COOLING				
Y1 HEATING				
Y2 HEATING				
W1				
W2				
W3				
DEFROST CYCLES				

¹ Indicates cycle count

² Indicates cycle time in minutes

System Report

The system report provides technicians with important system operational data in one screen. The data is in real time and updates as the data changes. System Reports is accessed by navigating to **Service Menu > System Reports**. The system report lists:

- System Status; mode and stage of operation
- Load Value
- Fan Status



Diagnostics

- Indoor Temperature
- Indoor Relative Humidity
- Heating/Cooling Setpoints
- Relative Humidity Setpoints
- Dehumidifier Status
- Outdoor Temperature

Current energized terminals display in green at the bottom of the system report screen.

Restore Factory Defaults



Restoring factory defaults writes over all saved settings. Restore Defaults is accessed by navigating to **Service Menu > Restore Defaults**.



Troubleshooting

Symptom	Possible causes	Action
Pivot thermostat displays an alert code on the screen.	A critical or major alert is present	Navigate to the Diagnostic screen on the Pivot thermostat for a Problem Description and Possible Cause.
Display will not come on	Loss of 24 Vac between R & B at the Pivot thermostat	<ol style="list-style-type: none"> 1. Check R & B wiring 2. Check transformer for 24 Vac output. 3. Check for broken or shorted thermostat wire.
Indoor temperature display is incorrect.	<ol style="list-style-type: none"> 1. Indoor temperature display needs calibration. 2. Heat from touch screen is being trapped within the thermostat body. 	<ol style="list-style-type: none"> 1. Calibrate temperature sensor from thermostat settings or use a remote temperature sensor. Home > Menu > Settings > Thermostat > Indoor Calibration > Indoor Temp 2. Move Pivot thermostat away from competing air stream or use a remote indoor sensor.
Indoor humidity display is incorrect.	indoor humidity display needs calibration.	Calibrate humidity sensor from the thermostat settings. Home > Menu > Settings > Thermostat > Indoor Calibration > Humidity
Heating will not come on.	<ol style="list-style-type: none"> 1. System mode is not set to Heat/Auto or setpoint is set too low. 2. Minimum off time delay is being enforced. 3. Heating system may require service 	<ol style="list-style-type: none"> 1. Set mode to heat and raise the setpoint above the room temperature. 2. Wait for 5 minutes and recheck heating equipment. 3. Check/repair system.
Cooling will not come on.	<ol style="list-style-type: none"> 1. System mode is not set to Cool/Auto or the setpoint is too high. 2. Minimum off time delay is being enforced. 3. Cooling system may require service. 	<ol style="list-style-type: none"> 1. Set mode to cool and lower the setpoint below the room temperature. 2. Wait for 5 minutes and recheck cooling equipment. 3. Check/repair system.
Heating or Cooling is displayed, but no warm or cool air is coming from the registers.	<ol style="list-style-type: none"> 1. There is a fan delay as the heating or cooling equipment turns on. 2. Equipment is not working properly. 	<ol style="list-style-type: none"> 1. Wait a minute for blower delays and recheck registers. 2. Check/repair system.
Blower runs all the time	<ol style="list-style-type: none"> 1. Fan mode is set to On. 2. Field wiring issue. 3. There is a failure in the indoor unit. 	<ol style="list-style-type: none"> 1. Check Pivot thermostat settings to see if fan is set to On or Clean mode. 2. Check field wiring. 3. Check indoor unit for failures (such as tripped heating limit). 4. Check configuration. 5. Blower is interlocked with ventilation.
Blower is set to ON but not running.	<ol style="list-style-type: none"> 1. Humidity control is engaged. 2. Field wiring issue. 3. Blower motor is not functioning. 	<ol style="list-style-type: none"> 1. If indoor humidity is higher than desired setpoint, the blower will cycle off with the equipment. A humidity icon will be displayed on the Fan Mode button when the blower operation is being inhibited due to high humidity. 2. Check field wiring. 3. Check/repair system.
Cooling or Heating cycles too fast or too slow (narrow or wide temperature swings).	<ol style="list-style-type: none"> 1. Check the location of the Pivot thermostat for drafts. 2. Cycles per hour is improperly set. 	<ol style="list-style-type: none"> 1. Seal air leaks behind Pivot thermostat. Relocate Pivot thermostat or apply remote indoor temperature sensor. 2. Adjust cycle rates in the Advanced installer Setup.

Troubleshooting

Symptom	Possible causes	Action
Heat pump is not turning on; only furnace or electric heat strips are running.	<ol style="list-style-type: none"> Outdoor temperature is below compressor lockout temperature setting. System mode is set to Emergency Heat. Outdoor Unit may require service. 	<ol style="list-style-type: none"> Adjust the compressor lockout temperature setting if desired. Check/repair outdoor temperature sensor or wiring.
Cannot change system mode to desired setting.	Equipment is not configured properly.	Check the standard installer set up screen to ensure equipment is properly configured.
Screen does not respond properly to a button press.	<ol style="list-style-type: none"> Screen is out of calibration. internal Pivot thermostat fault. 	Reset /Cycle power to the Pivot thermostat by removing it from the sub-base, waiting 10 seconds, and then replacing. Follow on-screen calibration instructions when the Pivot thermostat reboots.
ODT input configured as Outdoor Air Temperature but the value on Outdoor Temp widget appears to be coming from internet weather instead of a hardwired sensor.	<ol style="list-style-type: none"> ODT input is shorted or open which then defaults to internet weather. Temperature source for Outdoor Temp widget was chosen as Internet Weather instead of Local OAT Sensor. 	<ol style="list-style-type: none"> Check ODT input wiring and connections. Check sensor. Go to Home > Menu > Settings > Thermostat > Temperature Calibration and select Local OAT Sensor.
ODT input configured as Outdoor Air Temperature displaying a value that is not changing on the Outdoor Temp widget.  (Temperature does not change and there is no Low, Hi, or sky conditions shown).	ODT input could be shorted or open which then defaults Outdoor Temp to internet weather. However, internet weather updates may have been unavailable. Outdoor Temp widget will continue to display the last known internet weather value for up to 12 hours.	<ol style="list-style-type: none"> Check ODT input wiring and connections. Check sensor. Ensure thermostat is connected to the internet and registered with the Pivot cloud. Re-establish internet weather connection with valid postal code.
ODT input configured as Outdoor Air Temperature displaying double dashes (–) on the Outdoor Temp widget. 	ODT input is shorted or open which then defaults to internet weather. However, internet weather updates have not been available for more than 12 hours, causing the Outdoor Temp widget to display double dashes.	<ol style="list-style-type: none"> Check ODT input wiring and connections. Check sensor. Ensure thermostat is connected to the internet and registered with the Pivot cloud. Re-establish internet weather connection with valid postal code.
ODT or RS1 input configured as Other Temperature displays ≤ -47 F**	Either the temperature is less than or equal to -47 F, or the input is open.	<ol style="list-style-type: none"> Confirm actual temperature. Check input wiring and connections. Check sensor for accuracy.
ODT or RS1 input configured as Other Temperature displays ≥ 130 F*.	Either the temperature is greater than or equal to 130 F, or the input is shorted.	<ol style="list-style-type: none"> Confirm actual temperature. Check input wiring and connections. Check sensor for accuracy.
RS1 input configured as Remote Space Temperature displays double dashes (–)	RS1 input is shorted or open.	<ol style="list-style-type: none"> Check RS1 input wiring and connections. Check sensor.

*If there is a negative temperature calibration offset applied to this input, the display will show the calibrated value instead of ≥ 130 F. As an example, if there is a -2 degree F calibration offset applied, it will show ≥ 128 F when this input is shorted. A positive temperature calibration offset applied to this input will not change the value. It will still show ≥ 130 F. Temperature calibration is configured here: **Home > Menu > Settings > Thermostat > Temperature Calibration**.

If there is a positive temperature calibration offset applied to this input, the display will show the calibrated value instead of ≤ -47 F. As an example, if there is a $+2$ degree F calibration offset applied, it will show ≤ -45 F when this input is open. A negative temperature calibration offset applied to this input will not change the value. It will still show ≤ -47 F. Temperature calibration is configured here: **Home > Menu > Settings > Thermostat > Temperature Calibration.

PIN Access Code

A PIN access code may have been previously set up on the thermostat by the building owner, which may restrict access to the Menu screen and/or Service screen. If PIN access has been set up, the thermostat will display a notification when attempting to access the Menu or Service screen. In this case, the technician must obtain the PIN access code from the building owner or request to have the thermostat unlocked.

Pivot Smart Thermostat Support

For issues with thermostat setup and operation, or with the Trane Pivot mobile app, contact Pivot Support (833)-222-3201.



FCC and IC Notices

10.1 FCC Notice

FCC ID: XVR-CONT8247

INFORMATION TO USER

This device complies with Part 15 of the FCC Rules. Operation is subject to the following two conditions: (1) This device may not cause harmful interference and (2) This device must accept any interference that may cause undesired operation. The antenna(s) used for this transmitter must be installed to provide a separation distance of at least 20 cm from all persons and must not be collocated or operating in conjunction with any other antenna or transmitter.

This equipment has been tested and found to comply with the limits for Class B Digital Device, pursuant to Part 15 of the FCC Rules. These limits are designed to provide reasonable protection against harmful interference in a residential installation. This equipment generates and can radiate radio frequency energy and, if not installed and used in accordance with the instructions, may cause harmful interference to radio communications. However, there is no guarantee that interference will not occur in a particular installation. If this equipment does cause harmful interference to radio or television reception, which can be determined by turning the equipment off and on, the user is encouraged to try to correct the interference by one or more of the following measures:

- Reorient or relocate the receiving antenna
- Increase the separation between the equipment and receiver
- Connect the equipment into an outlet on a circuit different from that to which the receiver is connected
- Consult the dealer or an experienced radio/TV technician for help

Any changes or modifications not expressly approved by the party responsible for compliance could void the user's authority to operate the equipment.

10.2 IC Notice

IC: 6178-CONT8247

This device complies with Industry Canada license-exempt RSS standard(s). Operation is subject to the following two conditions: (1) this device may not cause interference, and (2) this device must accept any interference, including interference that may cause undesired operation of the device. The distance between user and device should be no less than 20cm.

Le présent appareil est conforme aux CNR d'Industrie Canada applicables aux appareils radio exempts de licence. L'exploitation est autorisée aux deux conditions suivantes: (1) l'appareil ne doit pas produire de brouillage, et (2) l'utilisateur de l'appareil doit accepter tout brouillage radioélectrique subi, même si le brouillage est susceptible d'en compromettre le fonctionnement. La distance entre l'utilisation et l'appareil ne doit pas être inférieure à 20 cm.

Trane - by Trane Technologies (NYSE: TT), a global innovator - creates comfortable, energy efficient indoor environments for commercial and residential applications. For more information, please visit trane.com or tranetechnologies.com.

Trane has a policy of continuous product and product data improvements and reserves the right to change design and specifications without notice. We are committed to using environmentally conscious print practices.

BAS-SVX078F-EN 21 Dec 2022
Supersedes BAS-SVX078E-EN (August 2022)

©2022 Trane