

Quick Start

(SR04)

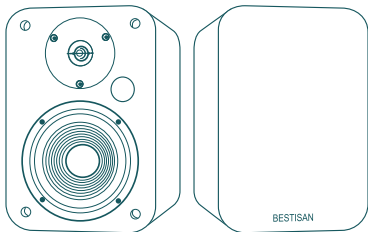

Please read all instructions before use for the best performance of this product. Save these instructions for future reference.

Box Contents

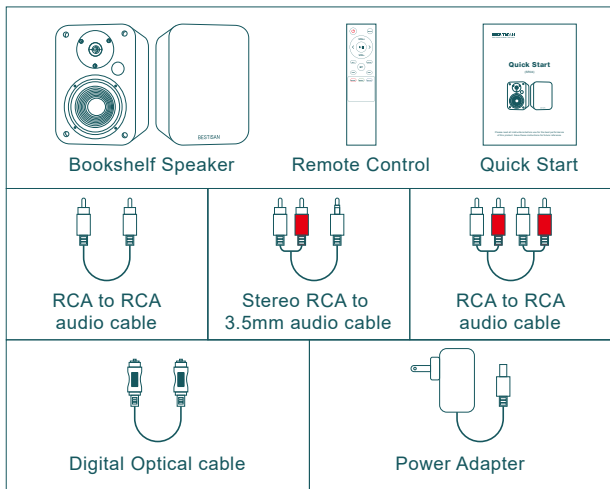

LED Indicators and Button Introduction

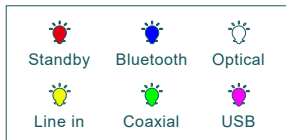
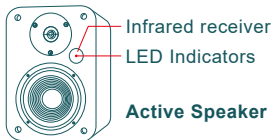

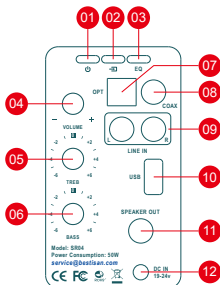

Active Speaker

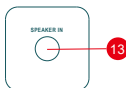

Passive Speaker

01. Power switch

02. Input selection

Press in to navigate between audio sources:
Bluetooth -> Optical -> Coaxial -> LINE IN
-> USB

03. Sound effects

Press in to navigate between audio sources:
Music -> Dialogue -> Movie

04. Volume control

05. Treble control

06. Bass control

07. Optical input port

08. Coaxial input port

09. Line in input port

10. USB input port

11. Left speaker audio output

12. Power port

13. Left speaker audio in

Know Your Remote

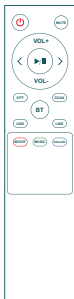

	Power button		Mute/Unmute
	Volume up		Volume down
	Previous track		Next track
	Play/pause		Optical mode
	Coaxial mode		Bluetooth mode
	USB mode		Line mode
	Movie mode		Music mode
	Dialogue mode		

Connection Diagram

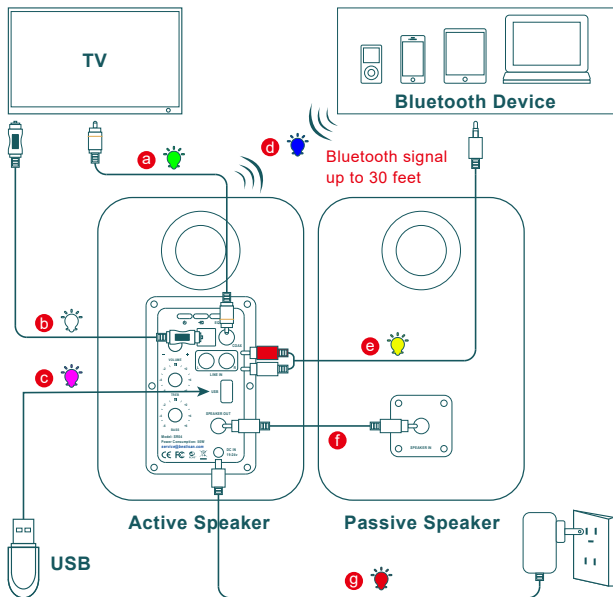

- a** Coaxial cable (not supplied)
- b** Digital Optical cable (supplied)
- c** USB (not supplied)
- d** Bluetooth
- e** Stereo RCA to 3.5mm audio cable (supplied)
- f** RCA to RCA audio cable (supplied)
- g** Power Adapter (supplied)

Connecting with a TV

Active Speaker

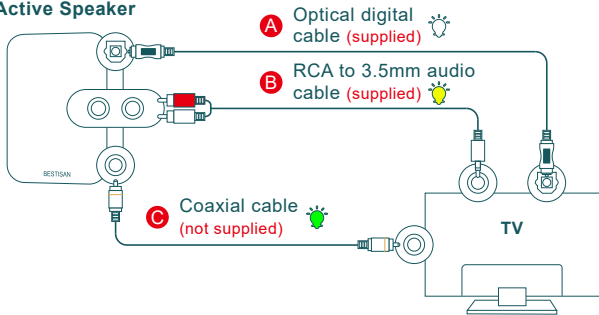

- A** Method 1. Connecting using an Optical cable. Select Optical mode and set the TV's audio output to "PCM".
(More information on PCM page)
- B** Method 2. Connecting using a RCA to 3.5mm audio cable. Select RCA mode.
- C** Method 3. Connecting using an Coaxial cable. Select Coaxial mode and set the TV's audio output to "PCM".
(More information on PCM page)

Setting "PCM" on your TV

When all cables are connected properly, and LED indicator lights properly, if there is no sound from tv or Soundbar, please setting your tv as below:

1. Press "Menu" on the TV's remote control.
2. Press the arrow keys on the remote to scroll to "Audio Settings."
3. Press "OK" on the remote control.
4. Scroll to "Advanced Audio" and press "OK". Some televisions may not have an "Advanced Audio" menu and may list various audio settings instead.
5. Scroll to "Audio Output Mode" or "Digital Audio Output Mode" and press "OK".
6. Scroll until "PCM" is displayed as the current audio output.
7. Press "OK" to save the settings.

Connecting a Bluetooth Device

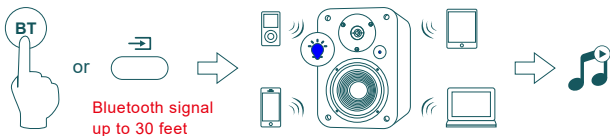

- a. Press the "BT" button on the remote or press the "BT" button on back panel of the active speaker, the LED indicator blinks blue.
- b. Turn on Bluetooth on the Bluetooth device.
- c. Select "BESTISAN SR04" and connect it. When your Bluetooth device is connected, the LED indicator blinks blue slowly.
- d. Play music files from the device, connected via Bluetooth, through the bookshelf speaker.

Specifications

Power output:	L/R: 25W + 25W
Signal to noise ratio dB(A):	L/R: ≥85dB (A)
Input sensitivity:	LINE IN: R/L: 650±50mV
	Coaxial: R/L: 500±50mV
	OPT: R/L: 500±50mFFS
	Bluetooth: R/L: 700±50mFFS
Frequency response:	40HZ-18KHZ
Bass unit:	4 inch (116mm)
Tweeter unit:	Φ13mm silk dome tweeter

Troubleshooting

No sound

- Check if the power indicator light is ON.
- Try to turn up the volume using either the master volume control or remote control.
- Ensure the audio cables are firmly connected and the input is set correctly on the speakers.
- Check if there is signal output from the audio source.

Cannot connect via Bluetooth

- Make sure the speaker is switched to Bluetooth input, in other audio input mode Bluetooth can not be paired or connected. Disconnect from any Bluetooth device by press and hold the volume dial in Bluetooth mode, then try again.
- Effective Bluetooth transmission range is 10 meters, please make sure operation is within the range.
- Try another Bluetooth device for connection.

The SR04 Bookshelf Speaker does not turn on

- Check if mains power is connected, or if the wall outlet is switched on.

FCC Statement

This device complies with Part 15 of the FCC Rules. Operation is subject to the following two conditions:

- (1) This device may not cause harmful interference.
- (2) This device must accept any interference received, including interference that may cause undesired operation.

Warning: Changes or modifications not expressly approved by the party responsible for compliance could void the user's authority to operate the equipment.

NOTE: This equipment has been tested and found to comply with the limits for a Class B digital device, pursuant to Part 15 of the FCC Rules. These limits are designed to provide reasonable protection against harmful interference in a residential installation. This equipment generates uses and can radiate radio frequency energy and, if not installed and used in accordance with the instructions, may cause harmful interference to radio communications. However, there is no guarantee that interference will not occur in a particular installation. If this equipment does cause harmful interference to radio or television reception, which can be determined by turning the equipment off and on, the user is encouraged to try to correct the interference by one or more of the following measures:

- Reorient or relocate the receiving antenna.
- Increase the separation between the equipment and receiver.
- Connect the equipment into an outlet on a circuit different from that to which the receiver is connected.
- Consult the dealer or an experienced radio/TV technician for help.

FCC Radiation Exposure Statement:

This equipment complies with FCC radiation exposure limits set forth for an uncontrolled environment. This equipment should be installed and operated with minimum distance 20cm between the radiator & your body.

Thanks for reading!

Best Artisan Corp.

801 DUPONT AVE SUITE F & G, ONTARIO, CA, 91761.

service@bestisan.com