

**SAMSUNG**



**Home Appliances**  
2022

## Contents

<b>Single Ovens</b>	<b>06</b>
Features Glossary	09
Single Ovens Range	11
<b>Compact Ovens &amp; Warming Drawers</b>	<b>17</b>
Features Glossary	18
Compact Ovens Range	20
Warming Drawers Range	23
<b>Integrated Microwaves</b>	<b>24</b>
Integrated Microwaves Range	25
<b>Hobs</b>	<b>26</b>
Features Glossary	27
Hobs Range	28
<b>Hoods</b>	<b>32</b>
Features Glossary	33
Hoods Range	34
<b>Refrigeration</b>	<b>40</b>
Features Glossary	46
Refrigeration Range	48
<b>Laundry</b>	<b>64</b>
Features Glossary	68
Washing Machines Range	72
Tumble Dryers Range	72
Washer Dryers Range	72
AirDressers Range	73
<b>Dishwashers</b>	<b>75</b>
Features Glossary	76
Dishwashers Range	78
<b>Floorcare</b>	<b>80</b>
Features Glossary	81
Bespoke Jet™ Range	82



# Why choose Samsung Home Appliances?

We are challenging the status quo of home appliances by designing innovations that adapt to our changing homes. From fridge freezers that go way beyond keeping food fresh, to ovens that let you cook more flexibly than ever. So you can come home to appliances that work around the happy chaos of our everyday lives and are a joy to use.

**#5** **BCG**  
2020  
Most Innovative  
Companies

**#5** **Interbrand**  
2020  
Best Global  
Brands

**#19** **FORTUNE**  
2020  
Global 500

**#2** **statista**  
2020  
Ten Most Popular  
Consumer Electronics  
Brands in the UK



Your Home Appliance is with you for the journey, so enjoy long lasting performance with peace of mind.

At Samsung we pride ourselves in the quality and innovation of our appliances, that's why all refrigeration, selected laundry and cooking appliances are covered by our extended five year parts and labour warranty, so you don't have to worry about a thing. To receive the warranty customers must register within 90 days of purchase. To see the full list of eligible appliances, register your warranty and see the Terms and Conditions visit: [www.samsung.com/uk/fiveyearwarranty](http://www.samsung.com/uk/fiveyearwarranty)





## Cooking

Samsung appliances make cooking both very easy and very satisfying. Whether you're warming up leftovers, rustling up a ratatouille or having guests over for dinner, our thoughtful innovations and stylish design make cooking a pleasure.

- ▶ Single Ovens
- ▶ Compact Ovens
- ▶ Warming Drawers
- ▶ Hobs
- ▶ Hoods



## Laundry

Life doesn't always go to plan. So Samsung Laundry Appliances have tons of brilliantly useful innovations to power through your washing and drying in smarter, faster and kinder ways.

- ▶ Washing Machines
- ▶ Washer Dryers
- ▶ Tumble Dryers



## Vacuum Cleaners

With the new All in one Clean Station you can clean with ease as its lightweight design also packs in incredible suction power.

- ▶ Bespoke Jet™



## Dishwashers

Loaded with slick technology, our dishwashers clean dishes like never before. From quick, everyday loads to clearing up after a dinner party, you can guarantee everything will be spot on and spotless.



## Refrigeration

When your kitchen's the heart of the home, life revolves around the fridge. So why not get a centerpiece that combines super-cool tech with stylish good looks?

- ▶ French Door
- ▶ American Side-by-Side
- ▶ Integrated
- ▶ Family Hub™
- ▶ Bespoke



## AirDresser

Part wardrobe, part steam cleaner, it does away with germs, dust and even smooths out wrinkles. Then you're good to go.





## Infinite Line™ Ovens

### Elevate your kitchen, reinvigorate your style

The Infinite Line™ of ovens transforms your single oven into two, with independent cooking zones for pulling together a full dinner party feast, all at once. Use steam to produce even more delicious results. And all the while, pre-programmed settings help you master the toughest culinary creations.

Choose from either onyx black or graphite grey. To complete the suite, there are matching compact ovens and warming drawers.

- ▶ **Steam Cooking**  
Every meal will be beautiful succulent on the inside and crisp on the outside.
- ▶ **Dual Cook**  
Cook two different dishes at different temperatures at once.
- ▶ **Wi-Fi functionality**  
Control your oven using your phone\* and have it cook a range of new recipes for you.
- ▶ **Matching Compact Ovens**
- ▶ **Matching Warming Drawers**



Onyx black



Graphite grey



\*Requires SmartThings App available on Android and iOS devices. An internet connection is required.

## Series 5 & 6 Ovens

### Master two dishes at once

Not only can you master all manner of meals by cooking at two temperatures and settings at once, but the hinged door means you can access the full oven or just the top half – so baste the roast without your Yorkshires collapsing.

There are two Dual Cook Flex™ and one Dual Cook ovens to choose from and they are available in both black stainless steel or stainless steel. To complete the suite, there are matching compact ovens and warming drawers.



Black glass



- ▶ **Dual Cook Flex™**  
With a hinged Flexible Door, you can access the whole oven or just the top half without losing heat from the bottom and ruining your meal.
- ▶ **Dual Cook**  
Cook two different dishes at different temperatures at once with no transfer of odour.
- ▶ **Add Steam**  
Every meal will be beautiful succulent on the inside and crisp on the outside.
- ▶ **Wi-Fi functionality**  
Control your oven using your phone\* and have it cook a range of new recipes for you.
- ▶ **Pyrolytic Cleaning**  
Burns off grease and spills that can easily be wiped away.

\*Requires SmartThings App available on Android and iOS devices. An internet connection is required.





## Feature Glossary



**Auto Cook Recipes**  
Take the guesswork out of cooking times and temperatures. Auto Cook has it all in hand.



**Bespoke Colour**  
Upgrade your kitchen by giving it a stylish and practical uplift. Our combi steam oven comes in 2 modern colours - Clean Navy and Satin Beige.



**Catalytic Cleaning**  
Put the spray away. The catalytic liner banishes grease at high temperatures while you cook.

## Series 4 Ovens

### Divide and conquer the kitchen

For when she wants pizza and he wants pie, Dual Cook technology gives you the flexibility to divide a single oven into two. Then you can cook different meals at different temperatures and settings at the same time – all without any tastes or smells transferring.

There are three Dual Cook and three Dual Cook Flex™ ovens to choose from and they are available in both black stainless steel or stainless steel. To complete the suite, there are matching compact ovens and warming drawers.



Black Glass



- ▶ **Dual Cook Flex™**  
With a hinged Flexible Door, you can access the whole oven or just the top half without losing heat from the bottom and ruining your meal.
- ▶ **Dual Cook**  
Cook two different dishes at different temperatures at once with no transfer of odour.
- ▶ **Pyrolytic Cleaning**  
Burns off grease and spills that can easily be wiped away.
- ▶ **Steam Cleaning**  
Easily loosen and remove food particles and stubborn stains.
- ▶ **Auto Cook Programmes**  
Take the guesswork out of cooking times and temperatures.



**Ceramic Enamel Interior**  
The exceptionally smooth antibacterial surface makes it easy to clean. It is also highly rust and scratch resistant so it won't discolour over time.



**Dual Cook**  
This single, flexible oven can cook two different dishes at different temperatures at once, whenever you need to – with no taste or smells transferring.



**Dual Cook Flex™**  
One flexible door. Two temperatures. Endless cooking combinations.



**Full Steam Cooking**  
Master the art of healthy cooking. Try full steam and dive into delicious and nutritious meals, every time.



**Meat Probe**  
This will actively manage the cooking process, regulating time and heat to ensure your food is always cooked to perfection.



**Pro-Roasting Mode**  
Roast meat like a pro. One mode heats to 220°C to sear then automatically adjusts to the slow cook temperature you've set for ideal texture inside and out.

# Feature Glossary



**Pyrolytic Cleaning**  
Forget scrubbing the oven. Reaching high temperatures, pyrolytic cleaning burns off grease and spills that can easily be wiped away.



**Soft Closing Door**  
The beautifully designed soft closing door is engineered to close both gently and quietly.



**Full Steam**  
Master the art of healthy cooking. Using the steam tray, try full steam and dive into delicious and nutritious meals, every time.



**Telescopic Rails**  
Sliding in and out smoothly and with hardly any effort, these telescopic rails are ideal for when you're using large pans and heavy dishes.

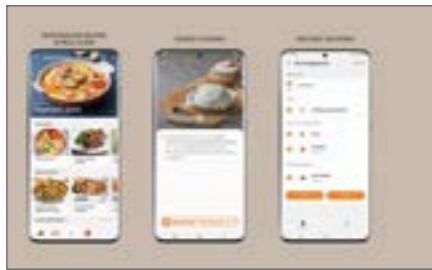

**SmartThings Cooking**  
How's this for smart? Control your oven using your phone\*1 and have it cook a range of new recipes for you.



**Dual Cook Steam™**  
Roast, bake, or steam. This oven lets you cook in two completely different styles in two different temperatures at once.

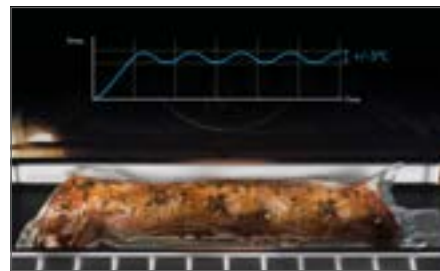

**Air Sous Vide**  
Accurately senses the temperatures in each cavity and maintains an even temperature for a long period. So everything is cooked thoroughly, wherever it is in the oven.



**Air Fry**  
Cook healthy, extra crispy food by using hot air circulation instead of deep frying. Enjoy the usual crunchy taste minus the extra fat.



**Add Steam**  
Your oven fills with steam ensuring your food retains that all-important natural moisture. Your dishes will stay succulent inside and crisp and brown outside.

# Infinite Line™ Onyx Black Oven Range



**NV75T8549RK**  
Dual Cook Oven

**KEY FEATURES**

- Dual Cook™ technology
- Wi-Fi Compatible
- 5 Year Warranty\*
- Catalytic Cleaning
- Ceramic Enamel Interior
- 50 Auto Cook Programmes
- Soft Closing Door
- Telescopic Rail
- Pro-Roasting Mode
- Steam Cleaning

**ENERGY EFFICIENCY CLASS**



**MATCHING COMPACT OVENS**  
NQ50T8939BK  
NQ50T8539BK

**MATCHING WARMING DRAWER**  
NL20T8100WK

**ACCESSORIES**  
x2 Baking Trays  
x1 Wire Rack



**NV75T8579RK**  
Dual Cook Oven

**KEY FEATURES**

- Dual Cook™ technology
- Wi-Fi Compatible
- 5 Year Warranty\*
- Pyrolytic Cleaning
- Ceramic Enamel Interior
- 50 Auto Cook Programmes
- Soft Closing Door
- Meat Probe
- Telescopic Rail
- Pro-Roasting Mode
- Steam Cleaning

**ENERGY EFFICIENCY CLASS**



**MATCHING COMPACT OVENS**  
NQ50T8939BK  
NQ50T8539BK

**MATCHING WARMING DRAWER**  
NL20T8100WK

**ACCESSORIES**  
x2 Baking Trays  
x1 Wire Rack



**NV75T8979RK**  
Dual Cook Oven

**KEY FEATURES**

- Full Steam Cooking
- Steam Assist Cooking
- Dual Cook™ technology
- Wi-Fi Compatible
- 5 Year Warranty\*
- Pyrolytic Cleaning
- Ceramic Enamel Interior
- 50 Auto Cook Programmes
- Soft Closing Door
- Meat Probe
- Telescopic Rail
- Pro-Roasting Mode
- Steam Cleaning

**ENERGY EFFICIENCY CLASS**



**MATCHING COMPACT OVENS**  
NQ50T8939BK  
NQ50T8539BK

**MATCHING WARMING DRAWER**  
NL20T8100WK

**ACCESSORIES**  
x2 Baking Trays  
x1 Wire Rack



# Infinite Line™ Graphite Grey Oven Range

## 6 Series

## 5 Series



**NV75T9579CD**  
Dual Cook Oven

**KEY FEATURES**

- Dual Cook™ technology
- Wi-Fi Compatible
- 5 Year Warranty\*
- Pyrolytic Cleaning
- Ceramic Enamel Interior
- 50 Auto Cook Programmes
- Soft Closing Door
- Telescopic Rails
- Pro-Roasting Mode
- Steam Cleaning



**NV75T9879CD**  
Dual Cook Oven

**KEY FEATURES**

- Steam Assist Cooking
- Dual Cook™ technology
- Wi-Fi Compatible
- 5 Year Warranty\*
- Pyrolytic Cleaning
- Ceramic Enamel Interior
- 50 Auto Cook Programmes
- Soft Closing Door
- Meat Probe
- Telescopic Rails
- Pro-Roasting Mode
- Steam Cleaning



**NV75T9979CD**  
Dual Cook Oven

**KEY FEATURES**

- Full Steam Cooking
- Steam Assist Cooking
- Dual Cook™ technology
- Wi-Fi Compatible
- 5 Year Warranty\*
- Pyrolytic Cleaning
- Ceramic Enamel Interior
- 50 Auto Cook Programmes
- Soft Closing Door
- Meat Probe
- Telescopic Rails
- Pro-Roasting Mode
- Steam Cleaning

**ENERGY EFFICIENCY CLASS**

A+

**MATCHING COMPACT OVENS**

NQ50T9939BD  
NQ50T9539BD

**MATCHING WARMING DRAWER**

NL20T8100WK

**ACCESSORIES**

x2 Baking Trays  
x1 Wire Rack

**ENERGY EFFICIENCY CLASS**

A+

**MATCHING COMPACT OVENS**

NQ50T9939BD  
NQ50T9539BD

**MATCHING WARMING DRAWER**

NL20T8100WK

**ACCESSORIES**

x1 Glass Steam Dish  
x2 Baking Trays  
x1 Wire Rack

**ENERGY EFFICIENCY CLASS**

A+

**MATCHING COMPACT OVENS**

NQ50T9939BD  
NQ50T9539BD

**MATCHING WARMING DRAWER**

NL20T8100WK

**ACCESSORIES**

x1 Glass Steam Dish  
x2 Baking Trays  
x1 Wire Rack



**NV7B6795JAK**  
Dual Cook Flex™ Oven

**KEY FEATURES**

- Add Steam
- Dual Cook Flex™
- 5 Year Warranty\*
- Modernised Design
- Air Fry
- Pyrolytic Cleaning
- Smart Things Cooking
- Soft Close Door
- Food Probe
- Air Sous Vide
- Big Capacity (76L)
- Telescopic Rails (One Level)

**ENERGY EFFICIENCY CLASS**

A+

**MATCHING COMPACT OVEN**

NQ5B6753CAK

**MATCHING WARMING DRAWER**

NL20T8100WK

**ACCESSORIES**

x1 Tray, x1 Glass Steam Tray,  
x1 Wire Rack



**NV7B5775XAK**  
Dual Cook Flex™ Oven

**KEY FEATURES**

- Add Steam
- Dual Cook Flex™
- 5 Year Warranty\*
- Air Fry
- Pyrolytic Cleaning
- Flexible Door
- Smart Things Cooking
- Modernised Design
- Soft Close Door
- Air Sous Vide
- Big Capacity (76L)
- Telescopic Rails (One Level)

**ENERGY EFFICIENCY CLASS**

A+

**MATCHING COMPACT OVEN**

NQ5B5763DBK

**MATCHING WARMING DRAWER**

NL20T8100WK

**ACCESSORIES**

x2 Trays, x1 Wire Rack



**NV7B5675WAK**  
Dual Cook Oven

**KEY FEATURES**

- Add Steam
- Dual Cook
- 5 Year Warranty\*
- Air Fry
- Pyrolytic Cleaning
- Smart Things Cooking
- Modernised Design
- Soft Close Door
- Food Probe
- Air Sous Vide
- Big Capacity (76L)
- Telescopic Rails (One Level)

**ENERGY EFFICIENCY CLASS**

A+

**MATCHING COMPACT OVEN**

NQ5B5763DBK

**MATCHING WARMING DRAWER**

NL20T8100WK

**ACCESSORIES**

x2 Trays, x1 Wire Rack

\*Requires registration from [www.samsung.com/uk/fiveyearwarranty](http://www.samsung.com/uk/fiveyearwarranty) within 90 days of purchase. Terms and conditions apply.

\*Requires registration from [www.samsung.com/uk/fiveyearwarranty](http://www.samsung.com/uk/fiveyearwarranty) within 90 days of purchase. Terms and conditions apply.



# 4 Series



**NV7B4355VAK**  
Dual Cook Flex™ Oven

**KEY FEATURES**

- Dual Cook Flex™
- 5 Year Warranty\*
- Flexible Door
- Smart Things Cooking
- Pyrolytic Cleaning
- Full Touch Display
- Natural Steam
- Air Sous Vide
- Soft Close Door
- Big Capacity (76L)
- Telescopic Rail



**NV7B42503AK**  
Dual Cook Oven

**KEY FEATURES**

- Dual Cook
- 5 Year Warranty\*
- Smart Things Cooking
- Pyrolytic Cleaning
- Full Touch Display
- Natural Steam
- Air Sous Vide
- Big Capacity (76L)



**NV7B42205AK**  
Dual Cook Oven

**KEY FEATURES**

- Dual Cook
- 5 Year Warranty\*
- Smart Things Cooking
- Catalytic Cleaning
- Full Touch Display
- Air Sous Vide
- Big Capacity (76L)

**ENERGY EFFICIENCY CLASS**



**MATCHING COMPACT OVEN**  
NQ5B4353FBK

**MATCHING WARMING DRAWER**  
NL20T8100WK

**ACCESSORIES**

- x1 Tray, x1 Natural Steam Tray, x1 Wire Rack

**ENERGY EFFICIENCY CLASS**



**MATCHING COMPACT OVEN**  
NQ5B4553FBK

**MATCHING WARMING DRAWER**  
NL20T8100WK

**ACCESSORIES**

- x1 Tray, x1 Natural Steam Tray, x1 Wire Rack

**ENERGY EFFICIENCY CLASS**



**MATCHING COMPACT OVEN**  
NQ5B4353FBK

**MATCHING WARMING DRAWER**  
NL20T8100WK

**ACCESSORIES**

- x2 Trays, x1 Wire Rack

# 4 Series



**NV7B45305AK**  
Dual Cook Flex™ Oven

**KEY FEATURES**

- Dual Cook Flex™
- 5 Year Warranty\*
- Pyrolytic Cleaning
- Smart Things Cooking
- Flexible Door
- Air Sous Vide
- Big Capacity (76L)



**NV7B4430ZAB**  
Dual Cook Oven

**KEY FEATURES**

- Dual Cook
- 5 Year Warranty\*
- Pyrolytic Cleaning
- Smart Things Cooking
- Air Sous Vide
- Big Capacity (76L)
- Telescopic Rail



**NV7B43205AK**  
Dual Cook Oven

**KEY FEATURES**

- Dual Cook Flex™
- 5 Year Warranty\*
- Catalytic Cleaning
- Smart Things Cooking
- Air Sous Vide
- Big Capacity (76L)
- Full Touch Display

**ENERGY EFFICIENCY CLASS**



**MATCHING COMPACT OVEN**  
NQ5B4553FBK

**MATCHING WARMING DRAWER**  
NL20T8100WK

**ENERGY EFFICIENCY CLASS**



**MATCHING COMPACT OVEN**  
NQ5B4553FBB

**MATCHING WARMING DRAWER**  
NL20T8100WK

**ENERGY EFFICIENCY CLASS**



**MATCHING COMPACT OVEN**  
NQ5B4353FBK

**MATCHING WARMING DRAWER**  
NL20T8100WK

\*Requires registration from [www.samsung.com/uk/fiveyearwarranty](http://www.samsung.com/uk/fiveyearwarranty) within 90 days of purchase. Terms and conditions apply.

\*Requires registration from [www.samsung.com/uk/fiveyearwarranty](http://www.samsung.com/uk/fiveyearwarranty) within 90 days of purchase. Terms and conditions apply.



## Compact Ovens

### A small but mighty second oven

Whether you're planning a big feast and need a second oven, or are short on space, a compact oven can be a lifesaver. Don't be fooled by their neat appearance. With up to 50L of cooking space, they can handle a turkey or tagine easily. And they're not just handy for preparing big meals – many can microwave and grill too. So compact ovens make a really flexible addition to your kitchen.

- ▶ **50L Capacity**  
Cook more at once with the large internal capacity.
- ▶ **Steam Assist Cooking**  
Every meal will be beautiful succulent on the inside and crisp on the outside.
- ▶ **Microwave Cooking**  
Convenient and quick meals.
- ▶ **Grill Function**  
Enjoy the browned, crispy food you love.
- ▶ **Steam Cleaning**  
The inside of your oven looks good as new.
- ▶ **Auto Cook Programmes**  
Take the guesswork out of cooking times and temperatures.



Graphite grey



Black Glass  
Full Touch Display



Black Glass  
Dual Knob Display



Black Stainless Steel  
Dual Knob Display





## Feature Glossary



### 50 Litre Capacity

Catering for everyone just got a whole load easier – cook more at once with a roomy 50L capacity.



### Ceramic Enamel Interior

The exceptionally smooth antibacterial surface makes it easy to clean. It is also highly rust and scratch resistant so it won't discolour over time.



### Dual Fans

Two powerful fans get the oven hot fast, then circulate heat nice and evenly. With every meal thoroughly cooked, there'll be no surprises when you dish up.



### Soft Closing Door

The beautifully designed soft closing door is engineered to close both gently and quietly.



### Full Steam

Master the art of healthy cooking. Try full steam and dive into delicious and nutritious meals, every time.



### Steam Cleaning

Cleaning your compact oven is no longer a faff thanks to easy Steam Cleaning.

## Feature Glossary



### Wi-Fi Compatible

How's this for smart? Control your compact oven using your phone\* and have it cook a range of new recipes for you.



### Add Steam

Your oven fills with steam ensuring your food retains that all-important natural moisture. Your dishes will stay succulent inside and crisp and brown outside.



### Bespoke Colour

Upgrade your kitchen by giving it a stylish and practical uplift. Our combi steam oven comes in 2 modern colours - Clean Navy and Satin Beige.



### Air Fry

Cook healthy, extra crispy food by using hot air circulation instead of deep frying. Enjoy the usual crunchy taste minus the extra fat.



### Modernised Design

Now you can control and set all your preferences with a simple touch. Because who doesn't want to take shortcuts in the kitchen?

\*Requires SmartThings App available on Android and iOS devices. An internet connection is required.

## Infinite Line™



### NQ50T8539BK

Compact Oven

#### KEY FEATURES

- Onyx Black
- Wi-Fi Compatible
- 5 Year Warranty\*
- Dual Fans
- 50L Capacity
- Ceramic Enamel Interior
- Soft Closing Door
- 35 Auto Cook Programmes
- Convection Cooking
- Microwave Cooking
- Grill Function
- Steam Cleaning

#### ENERGY EFFICIENCY CLASS

A+

#### MATCHING OVENS

NV75T8979RK  
NV75T8579RK

#### MATCHING WARMING DRAWER

NL20T8100WK

#### ACCESSORIES

x1 Ceramic Tray  
x2 Baking Trays  
x1 Wire Rack  
x1 Wire Tray Insert



### NQ50T9539BD

Compact Oven

#### KEY FEATURES

- Graphite Grey
- Wi-Fi Compatible
- 5 Year Warranty\*
- Dual Fans
- 50L Capacity
- Ceramic Enamel Interior
- Soft Closing Door
- 35 Auto Cook Programmes
- Convection Cooking
- Microwave Cooking
- Grill Function
- Steam Cleaning

#### ENERGY EFFICIENCY CLASS

A+

#### MATCHING OVENS

NV75T9979CD  
NV75T9879CD

#### MATCHING WARMING DRAWER

NL20T8100WK

#### ACCESSORIES

x1 Ceramic Tray  
x2 Baking Trays  
x1 Wire Rack  
x1 Wire Tray Insert

## 6 Series



### NQ5B6753CAK

Microwave Combi

#### KEY FEATURES

- Modernised Design
- Air Fry
- SmartThings Cooking
- Wi-Fi Connectivity
- Steam Cleaning
- 50L Large Capacity
- 5 Year Warranty\*

#### MATCHING OVEN

NV7B6795JAK

#### MATCHING WARMING DRAWER

NL20T8100WK

#### ACCESSORIES

x1 Ceramic Tray  
x1 Baking Tray  
x1 Wire Rack  
x1 Wire Tray Insert  
x1 Steam Tray  
x1 Air Fry

## 5 Series



### NQ5B5763DBK

Natural Steam Combi

#### KEY FEATURES

- Modernised Design
- Air Fry
- SmartThings Cooking
- Wi-Fi Connectivity
- Steam Cleaning
- 50L Large Capacity
- Natural Steam

#### MATCHING OVEN

NV7B5775XAK  
NV7B5675WAK

#### MATCHING WARMING DRAWER

NL20T8100WK

#### ACCESSORIES

x1 Ceramic Tray  
x1 Baking Tray  
x1 Pure Steam Bowl  
x1 Wire Tray Insert  
x1 Simple Steam Tray  
x1 Air Fry



### NQ5B4353FBK

Microwave Combi

#### KEY FEATURES

- Air Fry
- SmartThings Cooking
- Wi-Fi Connectivity
- Steam Cleaning
- 50L Large Capacity
- Full Touch

#### MATCHING OVEN

NV7B4355VAK  
NV7B42503AK  
NV7B43205AK  
NV7B42205AK

#### MATCHING WARMING DRAWER

NL20T8100WK

#### ACCESSORIES

x1 Ceramic Tray  
x1 Baking Tray



### NQ5B4553FBK

Microwave Combi

#### KEY FEATURES

- Black Glass
- Dual Knob Display
- SmartThings Cooking
- Wi-Fi Connectivity
- Steam Cleaning
- 50L Large Capacity

#### MATCHING OVEN

NV7B45305AK  
NV7B4430ZAB

#### MATCHING WARMING DRAWER

NL20T8100WK

#### ACCESSORIES

x1 Ceramic Tray  
x1 Baking Tray  
x1 Wire Tray Insert



### NQ5B4553FBB

Microwave Combi

#### KEY FEATURES

- Black Stainless Steel
- Dual Knob Display
- SmartThings Cooking
- Wi-Fi Connectivity
- Steam Cleaning
- 50L Large Capacity

#### MATCHING OVEN

NV7B4430ZAB

#### MATCHING WARMING DRAWER

NL20T8100WK

#### ACCESSORIES

x1 Ceramic Tray  
x1 Baking Tray  
x1 Wire Tray Insert



# Warming Drawers

Match the Warming Drawer with selected Compact Ovens to defrost, dough proof and keep food at the perfect temperature until dinner is ready



## Warming Drawers Range



### NL20T8100WK

Warming Drawer

#### KEY FEATURES

- Push & Pull Door Handle
- Temperature Range 30~80°C
- Anti-Slip Mat
- LED Status Lamp
- 5 Year Warranty\*

\*Requires registration from [www.samsung.com/uk/fiveyearwarranty](http://www.samsung.com/uk/fiveyearwarranty) within 90 days of purchase. Terms and conditions apply.



## Integrated Microwaves Range



**MS22M8054AK**  
Microwave Oven

**KEY FEATURES**

- 800W
- Touch Control
- 22L Capacity
- Ceramic Enamel Interior



**MG22M8074AT**  
Microwave Oven

**KEY FEATURES**

- 800W
- Touch Control
- 22L Capacity
- Grill Function
- Ceramic Enamel Interior

## Integrated Microwaves

### All the microwave must haves, built-in

Our integrated microwaves aren't just about nailing that sleek, minimal look. They pack in all the things you expect from a microwave and more besides. From easy cleaning interiors to fuss-free defrosting.

- ▶ **Quick Defrost**  
Quick Defrost lets you defrost frozen foods quickly and evenly, ensuring that it retains its original freshness and texture.
- ▶ **Deodorisation**  
Our clever Deodorisation function eliminates the lingering odour of strong smelling ingredients as you cook them and leaves the interior smelling fresh.
- ▶ **Auto Cook Programmes**  
Take the guesswork out of cooking times and temperatures.
- ▶ **Ceramic Enamel Interior**  
Super easy to clean.



Steel & black



Black





# Hobs

## Putting flexibility on the menu

There's so much more to Samsung hobs. Our range has something to suit every style of cook whether you like to rustle up and go, or take it slow and steady. Gas, electric or induction you'll have the ultimate flexibility. Add to this next generation features that bring you supercharged heat, extra control and safety and you'll feel like your cooking on gas even when you're really not.

- ▶ **Induction with ventilation**  
Create perfect meals with Dual Flex cooking zones, powerful ventilation and pre-defined hob settings.
- ▶ **Virtual Flame Technology™**  
Flame-like LED lighting shows you how hot the ring is.
- ▶ **Power Boost**  
A quick blast of power gets you to the hottest setting fast.
- ▶ **Flex Zone**  
Make the most of your hob space and cook more flexibly.
- ▶ **Auto Connectivity\***  
The cooker hood turns on automatically when you activate the hob.



\*Available on selected models and when paired with selected Samsung hobs

# Feature Glossary

## Induction



### Auto Pan Detection

Not sure which pot or pan to use? Auto pan detection does the thinking for you and tells you to choose a different one if it doesn't cover enough of the cooking zone.



### Flex Zone Plus

Divided into four zones for greater flexibility you can accommodate different sizes of cookware to cook the way you want.



### Keep Warm

Keep warm will make sure your special chilli simmers at just the right temperature. So it's still good to go whenever you are.



### Pause Function

If you're interrupted when cooking, just press the pause button to bring down the temperature. Then start again when you're ready.



### Quick Start

Why wait for heat? Quick Start gets the induction hob super hot in seconds – as quick as if you're using a gas hob.



### Sliding Control

Enables fast and precise control of your cooking temperatures. Simply touch and glide your finger across it to instantly set or adjust the heat levels.

## Gas



### Endless Design Grates

With these endless design grates you simply slide pots or pans along the seamless rails, making it easier and safer than ever to move your cookware.



### Safety Shut-off

For extra peace of mind, Safety shut-off automatically turns off cooking zones that have been inactive for a while.

## Ceramic



### Easy to clean

There's no need to worry about messy spills and splatters. Even after the greasiest cooking, the smooth, ergonomic surface will quickly wipe clean.

## Induction Hobs Range



### NZ64H37070K

Induction Cooktop (60cm)

#### KEY FEATURES

Sliding Control  
1~9 Power Level with Booster  
Quick Stop  
Residual Heat Indicator  
New Amber Display  
Cut Edge Frame  
Left Front 14cm 1.25 (1.5kW)  
Left Rear 22cm 2.35 (2.6kW)  
Right Front 22cm 2.35 (2.6kW)  
Right Rear 14cm 1.25 (1.5kW)  
Total Max. Power 7.2kW



### NZ64K7757BK

Induction Cooktop (60cm)

#### KEY FEATURES

Sliding Control  
1~15 Power Level with Booster  
Flex Zone Plus  
Keep Warm  
Quick Start/Quick Stop/Pause  
2 Stage Residual Heat Indicator  
New Amber Display  
Front Bevelled Frame  
Left 38 x 24cm 3.3 (3.6kW)  
Right Front 21cm 2.2 (3.2kW)  
Right Rear 14.5cm 1.4 (2.0kW)  
Total Max. Power 7.2kW



### NZ64N9777GK

Induction Cooktop (60cm)

#### KEY FEATURES

Virtual Flame Technology™  
Flex Zone Plus  
Auto Connectivity (with Hood) & Wi-Fi  
Sliding & DirectAccess Control  
1~15 Power Level with Booster  
Keep Warm  
Quick Start/Quick Stop/Pause  
2 Stage Residual Heat Indicator  
Ice Blue Display  
Front Bevelled Frame  
Flex Zone 38 x 24cm 3.3 (3.6kW)  
Right Front 21cm 2.2 (3.2kW)  
Right Rear 14.5cm 1.2 (2.0kW)  
Total Max. Power 7.2kW  
5 Year Warranty\*

## Induction Hobs Range



### NZ84F7NC6AB

Induction Cooktop (80cm)

#### KEY FEATURES

Sliding Control  
1~15 Power Level with Booster  
Flex Zone  
Keep Warm  
Quick Stop/Pause  
2 Stage Residual Heat Indicator  
New Amber Display  
3-side Bevelled Frame  
Left 38 x 20cm 3.3 (3.6kW)  
Centre 28cm 2.4 (3.6kW)  
Right Rear 14.5cm 1.2 (2.0kW)  
Total Max. Power 7.2kW  
5 Year Warranty\*



### NZ84T9770EK

Induction Cooktop (80cm)

#### KEY FEATURES

Virtual Flame Technology™  
Precise Control with Magnetic Knob  
1~15 Power Level with Booster  
Wide Flex Zone  
Keep Warm  
Quick Start/Quick Stop/Pause  
2 Stage Residual Heat Indicator  
Ice Blue Display  
3-side Bevelled Frame  
Left 38 x 20cm 3.3 (3.6kW)  
Centre Rear 21cm 2.2 (3.2kW)  
Right Front 14.5cm 1.2 (2.0kW)  
Total Max. Power 7.0kW  
5 Year Warranty\*



### NZ84T9747VK

Induction Cooktop (80cm)

#### KEY FEATURES

Integrated Extractor  
Sliding Control  
1~9 Power Level with Booster  
Flex Zone  
Keep Warm  
Powerful Ventilation  
Flush-fit design  
Easy Clean Aluminium Grease Filter  
Low extraction noise  
Total Max. Power 7.4kW  
5 Year Warranty\*

## Gas Hobs Range



**NA64H3000AK**  
Gas Cooktop (60cm)

### KEY FEATURES

Rapid Burner (3.0kW)  
Easy-to-Clean Tempered Glass Surface  
4 Cast Iron Grate  
Burner Types:  
1 Rapid, 2 Semi-rapid, 1 Auxiliary  
Electronic Ignition  
(One Touch Ignition)  
Safety Device (Flame Failure Device)  
LNG/LPG Convergence Kit Included



**NA64H3010AS**  
Gas Cooktop (60cm)

### KEY FEATURES

Rapid Burner (3.3kW)  
Easy-to-Clean Tempered Glass Surface  
4 Cast Iron Grate  
Burner Types:  
1 Rapid, 2 Semi-rapid, 1 Auxiliary  
Electronic Ignition  
(One Touch Ignition)  
Safety Device (Flame Failure Device)  
LNG/LPG Convergence Kit Included



**NA64H3110AS**  
Gas Cooktop (60cm)

### KEY FEATURES

Rapid Burner (3.3kW)  
Easy-to-Clean Tempered Glass Surface  
Endless Design Grates  
Burner Types:  
1 Rapid, 2 Semi-rapid, 1 Auxiliary  
Electronic Ignition  
(One Touch Ignition)  
Safety Device (Flame Failure Device)  
LNG/LPG Convergence Kit Included

## Ceramic Hobs Range



**C61R1AAMST**  
Ceramic Cooktop

### KEY FEATURES

4 Burners  
Stainless Steel Frame  
Powerful Cooking  
Touch Control  
Amber Display  
Residual Heat Indicator  
Total Power: 6.0kW



**CR61R2AEE**  
Ceramic Cooktop

### KEY FEATURES

4 Burners  
Cutting Edge Frame  
Powerful Cooking  
Touch Control  
Amber Display  
Residual Heat Indicator  
Total Power: 6.0kW





# Hoods

## Freshness is served

Our stylish wall mounted hoods are designed to work in any kitchen. But they're not all about good looks. Powerful yet quiet extraction banishes smoke, steam and odours while you're cooking – and long afterwards. Plus there's innovative features like auto connectivity with your hob and particle sensors that automatically boost the extraction power\* to defeat strong cooking smells. You'll wonder how you cooked without them.



Stainless steel



Black



## Feature Glossary



### Auto Connectivity with hob\*

Now you don't need to remember to switch your hood on. Thanks to auto connectivity on your hob, the hood turns on as soon you start cooking.



### Boost Extraction

Some cooking smells linger more than others. This extra powerful extraction removes the most pungent of odours, to keep your kitchen smelling fresh.



### Easy Clean Grease Filters

No one likes cleaning the cooker hood. These grease filters work brilliantly to protect your hood motor. What's more, they're easy to take off and clean.

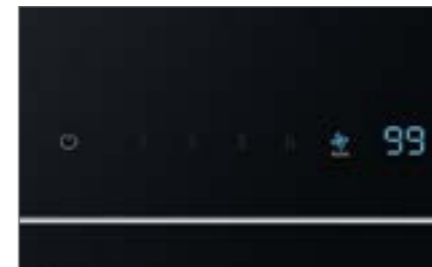

### 4 Extraction Speeds

When you're having prawn madras for tea you don't want the smell lingering days later. Thanks to 4 different extraction speeds you'll banish even the strongest smells.



### Full Touch Control

Stay in control in the kitchen. Our full touch control hood display has a bright LCD panel that's so simple to use and easy to clean.



### LED Lighting

Powerful lighting that illuminates your food, consumes less energy, and saves you money.

\*Available on selected models and when paired with selected Samsung hobs.

## 60cm Hoods Range

**NK24M1030IS**

Wall-mount Hood (60cm)

**KEY FEATURES**

Stainless Steel  
 Push button controls  
 2 Bulb Lighting Lamps  
 3 Speed Extraction Modes  
 Washable Aluminium Metallic Filters

**ENERGY EFFICIENCY CLASS****C**

**ACCESSORIES**  
 Charcoal Filter  
 Recirculation Kit

**NK24M3050PS**

Wall-mount Hood (60cm)

**KEY FEATURES**

Stainless Steel  
 Button Control  
 512m<sup>3</sup>/h Suction Power  
 LED Lighting  
 3 Speed Extraction Modes  
 Washable Aluminium Metallic Filters

**ENERGY EFFICIENCY CLASS****D**

**ACCESSORIES**  
 Charcoal Filter  
 Recirculation Kit

**NK24M5070BM**

Wall-mount Hood (60cm)

**KEY FEATURES**

Black Stainless with Stylish Front  
 Black Glass  
 Touch Control  
 High Suction Power (668m<sup>3</sup>/h)  
 2 LED Lighting  
 4 Speed Extraction Modes  
 (3 Level x 1 Booster)  
 Washable Aluminium Metallic Filter  
 Saturation Indicator  
 Timer Function  
 5 Year Warranty\*

**ENERGY EFFICIENCY CLASS****B**

**ACCESSORIES**  
 Charcoal Filter  
 Recirculation Kit

## 60cm Hoods Range

**NK24M5070BS**

Wall-mount Hood (60cm)

**KEY FEATURES**

Stainless Steel with Stylish Front  
 Black Glass  
 Touch Control  
 High Suction Power (668m<sup>3</sup>/h)  
 2 LED Lighting  
 4 Speed Extraction Modes  
 (3 Level x 1 Booster)  
 Washable Aluminium Metallic Filter  
 Saturation Indicator  
 Timer Function  
 5 Year Warranty\*

**ENERGY EFFICIENCY CLASS****B**

**ACCESSORIES**  
 Charcoal Filter  
 Recirculation Kit

**NK24M5070CS**

Wall-mount Hood (60cm)

**KEY FEATURES**

Stainless Steel Glass Construction  
 Touch Control  
 High Suction Power (670m<sup>3</sup>/h)  
 2 LED Lighting  
 4 Speed Extraction Modes  
 (3 Level x 1 Booster)  
 Washable Aluminium Metallic Filters  
 Saturation Indicator  
 Timer Function

**ENERGY EFFICIENCY CLASS****B**

**ACCESSORIES**  
 Charcoal Filter  
 Recirculation Kit

**NK24M7070VS**

Wall-mount Hood (60cm)

**KEY FEATURES**

Stainless Steel  
 Touch Control  
 High Suction Power (729m<sup>3</sup>/h)  
 2 LED Lighting  
 4 Speed Extraction Modes  
 (3 Level x 1 Booster)  
 Washable Aluminium Metallic Filters  
 Saturation Indicator  
 Timer Function  
 5 Year Warranty\*

**ENERGY EFFICIENCY CLASS****B**

**ACCESSORIES**  
 Charcoal Filter  
 Recirculation Kit

## 60cm Hoods Range



**NK24N5703BM**

Wall-mount Hood (60cm)

**KEY FEATURES**

- Auto Connectivity (with Hob)
- Black Stainless with Stylish Front Black Glass
- High Suction Power (722m<sup>3</sup>/h)
- Touch Control
- 2 LED Lighting
- 4 Speed Extraction Modes (3 Level x 1 Booster)
- Washable Aluminium Metallic Filters
- Saturation Indicator
- Timer Function
- 5 Year Warranty\*

**ENERGY EFFICIENCY CLASS**



- ACCESSORIES**
- Charcoal Filter
  - Recirculation Kit

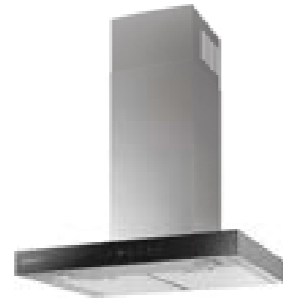

**NK24N5703BS**

Wall-mount Hood (60cm)

**KEY FEATURES**

- Auto Connectivity (with Hob)
- Stainless Steel with Stylish Front Black Glass
- High Suction Power (722m<sup>3</sup>/h)
- Touch Control
- 2 LED Lighting
- 4 Speed Extraction Modes (3 Level x 1 Booster)
- Washable Aluminium Metallic Filters
- Saturation Indicator
- Timer Function
- 5 Year Warranty\*

**ENERGY EFFICIENCY CLASS**



- ACCESSORIES**
- Charcoal Filter
  - Recirculation Kit



**NK24N9804VB**

Wall-mount Hood (60cm)

**KEY FEATURES**

- Auto Connectivity (with Hob)
- Premium Black Design
- High Suction Power (737m<sup>3</sup>/h)
- Auto Sensor
- Power Ventilation System
- Touch Control
- 1x7W LED Lighting
- 4 Speed Extraction Modes (3 Level x 1 Booster)
- Washable Aluminium Metallic Filters
- Saturation Indicator
- Timer Function
- 5 Year Warranty\*

**ENERGY EFFICIENCY CLASS**



- ACCESSORIES**
- Charcoal Filter

\*Requires registration from [www.samsung.com/uk/fiveyearwarranty](http://www.samsung.com/uk/fiveyearwarranty) within 90 days of purchase. Terms and conditions apply.

## 90cm Hoods Range



**NK36M3050PS**

Wall-mount Hood (90cm)

**KEY FEATURES**

- Stainless Steel
- Button Control
- 512m<sup>3</sup>/h Suction Power
- LED Lighting
- 3 Speed Extraction Modes
- Washable Aluminium Metallic Filters

**ENERGY EFFICIENCY CLASS**



- ACCESSORIES**
- Charcoal Filter
  - Recirculation Kit



**NK36M5070BM**

Wall-mount Hood (90cm)

**KEY FEATURES**

- Black Stainless with Stylish Front Black Glass
- Touch Control
- High Suction Power (668m<sup>3</sup>/h)
- 2 LED Lighting
- 4 Speed Extraction Modes (3 Level x 1 Booster)
- Washable Aluminium Metallic Filter
- Saturation Indicator
- Timer Function
- 5 Year Warranty\*

**ENERGY EFFICIENCY CLASS**



- ACCESSORIES**
- Charcoal Filter
  - Recirculation Kit



**NK36M5070BS**

Wall-mount Hood (90cm)

**KEY FEATURES**

- Stainless Steel with Stylish Front Black Glass
- Touch Control
- High Suction Power (668m<sup>3</sup>/h)
- 2 LED Lighting
- 4 Speed Extraction Modes (3 Level x 1 Booster)
- Washable Aluminium Metallic Filter
- Saturation Indicator
- Timer Function
- 5 Year Warranty\*

**ENERGY EFFICIENCY CLASS**



- ACCESSORIES**
- Charcoal Filter
  - Recirculation Kit

\*Requires registration from [www.samsung.com/uk/fiveyearwarranty](http://www.samsung.com/uk/fiveyearwarranty) within 90 days of purchase. Terms and conditions apply.



## 90cm Hoods Range



### NK36M5070CS

Wall-mount Hood (90cm)

#### KEY FEATURES

Stainless Steel Glass Construction  
Touch Control  
High Suction Power (670m<sup>3</sup>/h)  
2 LED Lighting  
4 Speed Extraction Modes  
(3 Level x 1 Booster)  
Washable Aluminium Metallic Filters  
Saturation Indicator  
Timer Function

#### ENERGY EFFICIENCY CLASS

B

**ACCESSORIES**  
Charcoal Filter  
Recirculation Kit



### NK36M7070VS

Wall-mount Hood (90cm)

#### KEY FEATURES

Stainless Steel  
Touch Control  
High Suction Power (729m<sup>3</sup>/h)  
2 LED Lighting  
4 Speed Extraction Modes  
(3 Level x 1 Booster)  
Washable Aluminium Metallic Filters  
Saturation Indicator  
Timer Function  
5 Year Warranty\*

#### ENERGY EFFICIENCY CLASS

B

**ACCESSORIES**  
Charcoal Filter  
Recirculation Kit

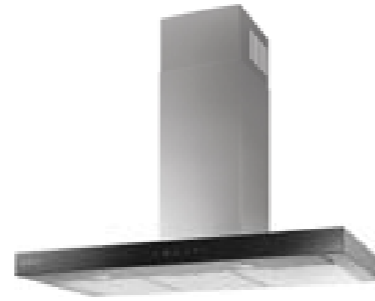

### NK36N5703BS

Wall-mount Hood (90cm)

#### KEY FEATURES

Auto Connectivity (with Hob)  
Stylish Front Black Glass  
High Suction Power (722m<sup>3</sup>/h)  
Touch Control  
2 LED Lighting  
4 Speed Extraction Modes  
(3 Level x 1 Booster)  
Washable Aluminium Metallic Filters  
Saturation Indicator  
Timer Function  
5 Year Warranty\*

#### ENERGY EFFICIENCY CLASS

A

**ACCESSORIES**  
Charcoal Filter

## 90cm Hoods Range



### NK36N9804VB

Wall-mount Hood (90cm)

#### KEY FEATURES

Auto Connectivity (with Hob)  
Auto Sensing Control  
Black Glass  
High Suction Power (737m<sup>3</sup>/h)  
Touch Control  
LED Bar Lighting  
4 Speed Extraction Modes  
(3 Level x 1 Booster)  
Washable Aluminium Metallic Filters  
Saturation Indicator  
Timer Function  
5 Year Warranty\*

#### ENERGY EFFICIENCY CLASS

A+

**ACCESSORIES**  
Charcoal Filter  
Recirculation Kit



## French Style Fridge Freezers

The statement Fridge Freezers that have so many options and are ultra roomy.

There's a place for everything in our French Style Fridge Freezers thanks to super flexible compartments. And with the latest cool technology, you can even switch the fridge to a freezer during ice lolly season.

- ▶ **Metal Cooling Interior**  
With the beautiful, reflective Metal Cooling Interior, the fridge looks as good on the inside as it does on the outside.
- ▶ **Family Hub™**  
Keeping your food fresh is just the start. Shop for food, organise your family's schedule, even see who's at your door.
- ▶ **Twin Cooling Plus™**  
Two separate air flows keep food fresher for longer.
- ▶ **SpaceMax™**  
More inside for the same space outside.
- ▶ **Total No Frost**  
Prevents ice build up, saving you the hassle and keeping your Fridge Freezer frost free.



Silver

Black



## American Style Fridge Freezers

Stylish or spacious, why choose?

Big on the inside, stunning on the outside, it's easy to see why these American Style side by side Fridge Freezers have become so desirable this side of the pond. Better still, they're stacked with features like ice makers, water dispensers, individually cooled zones and frost free technology.

- ▶ **Metal Cooling Interior**  
With the beautiful, reflective Metal Cooling Interior, the fridge looks as good on the inside as it does on the outside.
- ▶ **Family Hub™**  
Keeping your food fresh is just the start. Shop for food, organise your family's schedule, even see who's at your door.
- ▶ **Twin Cooling Plus™**  
Two separate air flows keep food fresher for longer.
- ▶ **SpaceMax™**  
More inside for the same space outside.
- ▶ **Total No Frost**  
Prevents ice build up, saving you the hassle and keeping your Fridge Freezer frost free.



Silver

Black





## Bespoke Classic

### Want to customise your fridge?

Bespoke Classic Fridge Freezers come in options to meet the needs of any kitchen. Create your perfect setup with our customisable colours and finishes in a variety of versatile configurations.



- ▶ **Customisable Module**  
Seamlessly integrate multiple refrigeration modules to increase capacity and make the fridge freezer combo for you.
- ▶ **Customisable Design**  
With custom coloured fridge freezers\* and a varied choice of finishes, it's easy to express yourself and your taste with a Bespoke refrigerator.
- ▶ **SpaceMax™**  
More inside for the same space outside.
- ▶ **All Around Cooling**  
Every item stays ideally cooled no matter where it's stored inside.
- ▶ **Total No Frost**  
Prevents ice build up, saving you the time and hassle of defrosting.
- ▶ **Power Cool & Power Freeze**  
Add a burst of power to keep food at its best.

## Bespoke One Door

### Want to customise your fridge?

Bespoke One Door Fridges and One Door Freezers come in options to meet the needs of any kitchen. Create your perfect setup with our customisable colours and finishes in a variety of versatile configurations.



- ▶ **Customisable Module**  
Seamlessly integrate multiple refrigeration modules to increase capacity and make the fridge freezer combo for you.
- ▶ **Customisable Design**  
With custom coloured fridge freezers\* and a varied choice of finishes, it's easy to express yourself and your taste with a Bespoke refrigerator.
- ▶ **SpaceMax™**  
More inside for the same space outside.
- ▶ **All Around Cooling**  
Every item stays ideally cooled no matter where it's stored inside.
- ▶ **Total No Frost**  
Prevents ice build up, saving you the time and hassle of defrosting.
- ▶ **Power Cool or Power Freeze**  
Add a burst of power to keep food at its best.





## Integrated Fridge Freezers

### Fridge Freezers that blend into your kitchen

Sometimes you just want a fridge to blend into the background. Our range of integrated Fridge Freezers slot tidily into your fitted kitchen. Behind their understated façades, there's top of the range design and technology working hard to keep things cool.



- ▶ **Total No Frost**  
Prevents ice build up, saving you the hassle and keeping your Fridge Freezer frost free.
- ▶ **Twin Cooling Plus™**  
Two separate air flows keep food fresher for longer.
- ▶ **CoolSelect Plus Zone**  
Choose the best temperature for whatever you're storing.
- ▶ **Reversible Door**  
Choose which side it opens from, making the fridge work with your kitchen.

## One Door Fridges & Freezers

### Keep it simple with a single door model with bags of capacity

Sometimes you just need a really big fridge or freezer. So keep it simple with a one door model with bags of capacity. Our One Door fridges and freezers have all round cooling, making every inch work hard to keep your groceries happy.



Silver White



- ▶ **Large Capacity**  
An immense capacity means more storage space and less trips to the shop to stock up.
- ▶ **Total No Frost**  
Prevents ice build up, saving you the hassle and keeping your appliance frost free.
- ▶ **All Around Cooling**  
Every item stays ideally cooled or frozen no matter where it's stored inside.
- ▶ **LED Lighting**  
A brightly lit, stylish and energy efficient fridge or freezer. Making it easier for you to find those jars hidden on the top shelf.
- ▶ **Reversible Door**  
Choose which side it opens from, making the fridge or freezer work with your kitchen.

# Feature Glossary



### Family Hub™

Shop for food, organise your family's schedule, even see who's at your door. These smart fridges are the centre of family life that's why we call them the Family Hub™.



### Beverage Centre™

Enjoy fast and easy access to refreshingly cold and flavored water.



### Dual Auto Ice Maker

Provides a choice of both Cubed Ice and Ice Bites™. Being stored in the freezer, the Dual Auto Ice Maker also helps free up fridge space.



### Smart Conversion™

Storage jigsaw days are over. Convert your freezer into a fridge to store more fresh products as and when needed. It's that's simple.



### CoolSelect Plus Zone

CoolSelect Plus Zone lets you choose the best temperature for whatever you're storing. Fridge or Freezer, you decide.



### Reversible Doors

The Reversible Door means you can choose which side it opens from, making your Samsung fridge work with your kitchen and not against it.



### SpaceMax™

Creates extra internal capacity but with the same size outside.



### Total No Frost

Total No Frost prevents ice build-up, saving you the hassle and keeping your Fridge Freezer frost-free.

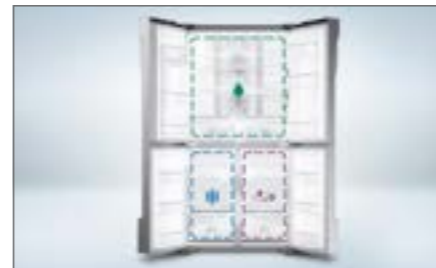

### Triple Cooling System

Three separate air flows and precise temperature control to keep food fresher for longer.



### Optimal & Humidity Fresh+ Zones

Keep items crisp and fresh by controlling the ideal temperature and humidity to suit your chosen food.



### Water & Ice Dispenser

At the touch of a button you could be sipping ice-cold drinks.

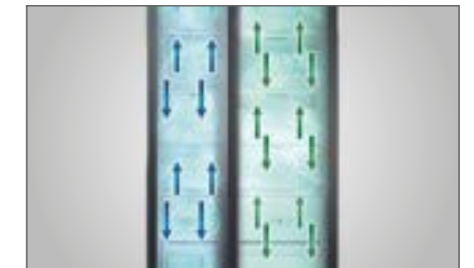

### Twin Cooling Plus™

Food is kept fresher for longer thanks to separate air flows and precise temperature control.



### All-around Cooling

Now you'll never lose your cool. Everything from chickens to cucumbers will be evenly chilled and stay fresh for longer.



### Large Capacity

Plenty of room to store your weekly grocery shopping.



### Metal Cooling Interior

With the beautiful, reflective Metal Cooling Interior, the fridge looks as good on the inside as it does on the outside.



### Power Cool

Lost some cool air while stocking the fridge with your weekly shop? Top it up with a burst from Power Cool and keep your new food fresh.



### Power Freeze

Don't worry about your frozen favourites defrosting on the way home from the shops. Add a burst of Power Freeze to the freezer to keep them at their best.



### Wine Rack

Free up the rest of your fridge by keeping your wine in the elegant built-in wine rack.



## French Style Fridge Freezers Range



**RF23BB860EQN**  
French Style

**KEY FEATURES**

- Customisable Module/Combination
- Bespoke - Customisable Design
- Seamless and Sleek Design
- Beverage Centre™
- Dual Auto Ice Maker
- CoolSelect Plus Zone™
- Triple Cooling
- Metal Cooling
- Simply Stylish
- Easy Access Control & Simple LCD Display
- 5 Year Warranty\*

**ENERGY EFFICIENCY CLASS**



**RF23R62E3B1**  
French Style

**KEY FEATURES**

- Twin Cooling Plus™
- Modern Simple Design
- Fingerprint Resistant
- Plumbed Water & Ice
- EZ-Open™ Handle
- 5 Year Warranty\*

**ENERGY EFFICIENCY CLASS**



**RF23R62E3SR**  
French Style

**KEY FEATURES**

- Twin Cooling Plus™
- Modern Simple Design
- Fingerprint Resistant
- Plumbed Water & Ice
- EZ-Open™ Handle
- 5 Year Warranty\*

**ENERGY EFFICIENCY CLASS**



## French Style Fridge Freezers Range



**RF65A977FB1**  
French Style

**KEY FEATURES**

- 5 Year Warranty\*
- Family Hub™
- CoolSelect Plus Zone™
- Triple Cooling System
- Multi-Door Design
- Plumbed Water & Ice Dispenser
- SpaceMax™
- Total No Frost
- Metal Cooling Interior
- Digital Inverter Compressor
- Power Freeze
- Power Cool
- Wine Shelf
- LED Lighting
- Vacation Mode
- Door Alarm

**ENERGY EFFICIENCY CLASS**



**RF65A977FSR**  
French Style

**KEY FEATURES**

- 5 Year Warranty\*
- Family Hub™
- CoolSelect Plus Zone™
- Triple Cooling System
- Multi-Door Design
- Plumbed Water & Ice Dispenser
- SpaceMax™
- Total No Frost
- Metal Cooling Interior
- Digital Inverter Compressor
- Power Freeze
- Power Cool
- Wine Shelf
- LED Lighting
- Vacation Mode
- Door Alarm

**ENERGY EFFICIENCY CLASS**



\*Requires registration from [www.samsung.com/uk/fiveyearwarranty](http://www.samsung.com/uk/fiveyearwarranty) within 90 days of purchase. Terms and conditions apply.



## American Style Fridge Freezers Range

## American Style Fridge Freezers Range



**RS50N3913SA**  
American Style

**RS50N3913BC**  
American Style

**RS50N3513SL**  
American Style

**RS50N3513BC**  
American Style

**RS50N3513S8**  
American Style

**RS50N3513SA**  
American Style

**KEY FEATURES**

**KEY FEATURES**

**KEY FEATURES**

**KEY FEATURES**

**KEY FEATURES**

**KEY FEATURES**

- 5 Year Warranty\*
- Home Bar
- Plumbed Water & Ice Dispenser
- Total No Frost
- All-Around Cooling
- Digital Inverter Compressor
- Power Freeze
- Door Alarm
- Vacation Mode
- Child Lock
- Wine Rack

- 5 Year Warranty\*
- Home Bar
- Plumbed Water & Ice Dispenser
- Total No Frost
- All-Around Cooling
- Digital Inverter Compressor
- Power Freeze
- Door Alarm
- Vacation Mode
- Child Lock
- Wine Rack

- 5 Year Warranty\*
- Total No Frost
- All-Around Cooling
- Digital Inverter Compressor
- Plumbed Water & Ice Dispenser
- Power Freeze
- Door Alarm
- Vacation Mode
- Child Lock
- Wine Rack

- 5 Year Warranty\*
- Total No Frost
- All-Around Cooling
- Digital Inverter Compressor
- Plumbed Water & Ice Dispenser
- Power Freeze
- Door Alarm
- Vacation Mode
- Child Lock
- Wine Rack

- 5 Year Warranty\*
- Total No Frost
- All-Around Cooling
- Digital Inverter Compressor
- Plumbed Water & Ice Dispenser
- Power Freeze
- Door Alarm
- Vacation Mode
- Child Lock
- Wine Rack

- 5 Year Warranty\*
- Total No Frost
- All-Around Cooling
- Digital Inverter Compressor
- Plumbed Water & Ice Dispenser
- Power Freeze
- Door Alarm
- Vacation Mode
- Child Lock
- Wine Rack

**ENERGY EFFICIENCY CLASS**



**ENERGY EFFICIENCY CLASS**



**ENERGY EFFICIENCY CLASS**



**ENERGY EFFICIENCY CLASS**



**ENERGY EFFICIENCY CLASS**



**ENERGY EFFICIENCY CLASS**



\*Requires registration from [www.samsung.com/uk/fiveyearwarranty](http://www.samsung.com/uk/fiveyearwarranty) within 90 days of purchase. Terms and conditions apply.

\*Requires registration from [www.samsung.com/uk/fiveyearwarranty](http://www.samsung.com/uk/fiveyearwarranty) within 90 days of purchase. Terms and conditions apply.

## American Style Fridge Freezers Range

## American Style Fridge Freezers Range



**RS50N3513WW**  
American Style

**RS50N3413BC**  
American Style

**RS52N3313SL**  
American Style

**RS52N3313SA**  
American Style

**RS52N3313WW**  
American Style

**RS52N3213BC**  
American Style

**KEY FEATURES**

**KEY FEATURES**

**KEY FEATURES**

**KEY FEATURES**

**KEY FEATURES**

**KEY FEATURES**

- 5 Year Warranty\*
- Total No Frost
- All-Around Cooling
- Digital Inverter Compressor
- Plumbed Water & Ice Dispenser
- Power Freeze
- Door Alarm
- Vacation Mode
- Child Lock
- Wine Rack

- 5 Year Warranty\*
- Total No Frost
- All-Around Cooling
- Digital Inverter Compressor
- Non-plumbed Water Dispenser
- Power Freeze
- Door Alarm
- Vacation Mode
- Child Lock
- Wine Rack

- 5 Year Warranty\*
- Total No Frost
- All-Around Cooling
- Digital Inverter Compressor
- Non-plumbed water dispenser
- Power Freeze
- Door Alarm
- Vacation Mode
- Child Lock
- Wine Rack

- 5 Year Warranty\*
- Total No Frost
- All-Around Cooling
- Digital Inverter Compressor
- Non-plumbed water dispenser
- Power Freeze
- Door Alarm
- Vacation Mode
- Child Lock
- Wine Rack

- 5 Year Warranty\*
- Total No Frost
- All-Around Cooling
- Digital Inverter Compressor
- Non-plumbed water dispenser
- Power Freeze
- Door Alarm
- Vacation Mode
- Child Lock
- Wine Rack

- 5 Year Warranty\*
- Total No Frost
- All-Around Cooling
- Digital Inverter Compressor
- Non-plumbed water dispenser
- Power Freeze
- Door Alarm
- Vacation Mode
- Child Lock
- Wine Rack

**ENERGY EFFICIENCY CLASS**



**ENERGY EFFICIENCY CLASS**



**ENERGY EFFICIENCY CLASS**



**ENERGY EFFICIENCY CLASS**



**ENERGY EFFICIENCY CLASS**



**ENERGY EFFICIENCY CLASS**



\*Requires registration from [www.samsung.com/uk/fiveyearwarranty](http://www.samsung.com/uk/fiveyearwarranty) within 90 days of purchase. Terms and conditions apply.

\*Requires registration from [www.samsung.com/uk/fiveyearwarranty](http://www.samsung.com/uk/fiveyearwarranty) within 90 days of purchase. Terms and conditions apply.

# American Style Fridge Freezers Range



**RS54N3103SA**  
American Style

**KEY FEATURES**

- 5 Year Warranty\*
- Total No Frost
- All-Around Cooling
- Digital Inverter Compressor
- Power Freeze
- Door Alarm
- Vacation Mode
- Child Lock

**ENERGY EFFICIENCY CLASS**



**RS6HA8891SL**  
American Style

**KEY FEATURES**

- 5 Year Warranty\*
- Family Hub™
- Twin Cooling Plus™
- Plumbed Water & Ice Dispenser
- SpaceMax™
- Total No Frost
- Metal Cooling Interior
- Digital Inverter Compressor
- Power Freeze
- Power Cool
- Wine Shelf
- LED Lighting
- Vacation Mode
- Door Alarm

**ENERGY EFFICIENCY CLASS**



**RS67A8810S9**  
American Style

**KEY FEATURES**

- 5 Year Warranty\*
- Large 609L Capacity
- Twin Cooling Plus™
- Plumbed Water & Ice Dispenser
- SpaceMax™
- Total No Frost
- Digital Inverter Compressor
- Power Freeze
- Power Cool
- Door Alarm
- Vacation Mode

**ENERGY EFFICIENCY CLASS**



# Bespoke Classic Range

## Classic 185cm Tall Fridge Freezer Metal



**RB34A6B2ECS**  
Cotta Sky Blue



**RB34A6B2ECE**  
Cotta Beige



**RB34A6B2ECL**  
Cotta Lavendar



**RB34A6B2ECW**  
Cotta White



**RB34A6B2E22**  
Clean Black

**KEY FEATURES**

- 5 Year Warranty\*
- Total No Frost
- All-Around Cooling
- Digital Inverter Compressor
- SpaceMax™
- Optimal Fresh+
- Humidity Fresh+ Zone
- Power Cool
- Power Freeze
- Door Alarm
- Vacation Mode
- Reversible Door
- Child Lock
- Wine Rack

**ENERGY EFFICIENCY CLASS**



**PAIRING KIT**  
RA-C00K4BAA

## Freezer door panels for Classic 185cm Tall Fridge Freezer



**RA-B23EBBCSGG**  
Cotta Sky Blue



**RA-B23EBBCEGG**  
Cotta Beige



**RA-B23EBBCLGG**  
Cotta Lavendar



**RA-B23EBBCWGG**  
Cotta White

## Bespoke Pairing Kit RA-C00K4BAA

This pairing kit provides a seamless join between Bespoke refrigeration products of the same height. It's compatible with Bespoke 185cm Fridge Freezers, 1 Door Fridges, and 1 Door Freezers.

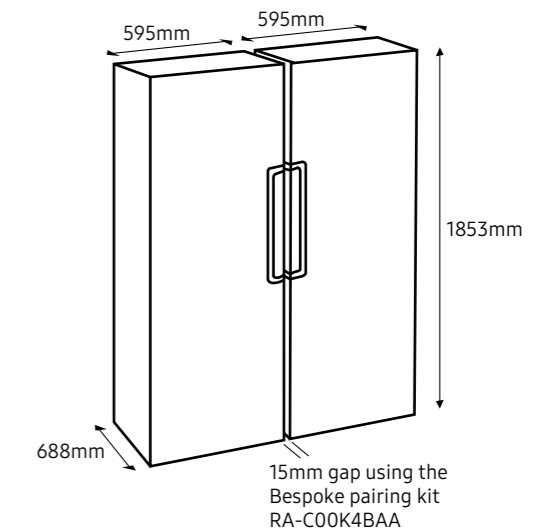

\*Requires registration from [www.samsung.com/uk/fiveyearwarranty](http://www.samsung.com/uk/fiveyearwarranty) within 90 days of purchase. Terms and conditions apply.

\*Requires registration from [www.samsung.com/uk/fiveyearwarranty](http://www.samsung.com/uk/fiveyearwarranty) within 90 days of purchase. Terms and conditions apply.



# Bespoke One Door Range

# Bespoke One Door Range

One Door 185cm Tall Fridges Metal

One Door 185cm Tall Freezers Metal

One Door 185cm Tall Fridges Glass

One Door 185cm Tall Freezers Glass

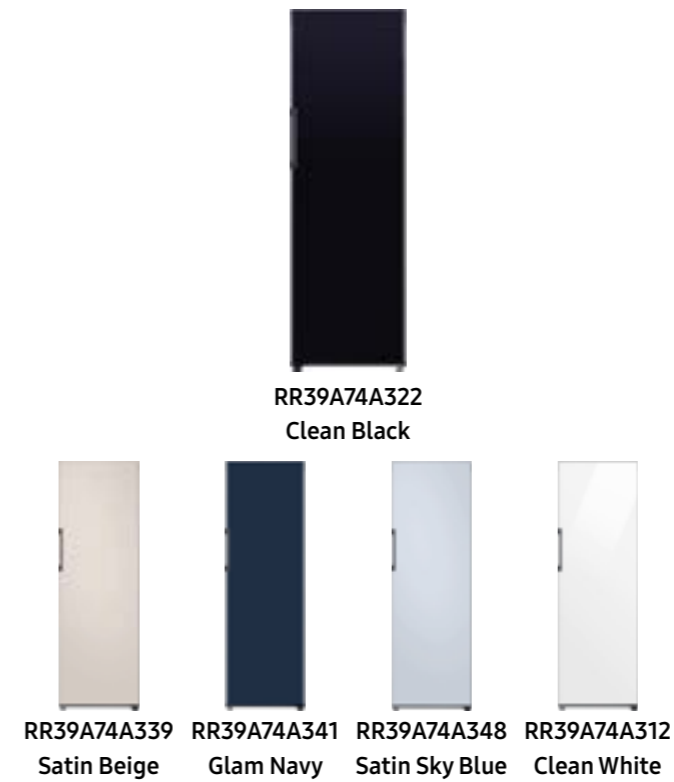

**KEY FEATURES**

- 5 Year Warranty\*
- Total No Frost
- All-Around Cooling
- Digital Inverter Compressor
- SpaceMax™
- Power Cool
- Door Alarm
- Vacation Mode
- Reversible Door
- Child Lock
- Wine Rack

**KEY FEATURES**

- 5 Year Warranty\*
- Total No Frost
- All-Around Cooling
- Smart Conversion™
- Digital Inverter Compressor
- SpaceMax™
- Power Freeze
- Door Alarm
- Vacation Mode
- Reversible Door
- Child Lock

**KEY FEATURES**

- 5 Year Warranty\*
- Total No Frost
- All-Around Cooling
- Digital Inverter Compressor
- SpaceMax™
- Power Cool
- Door Alarm
- Vacation Mode
- Reversible Door
- Child Lock
- Wine Rack

**KEY FEATURES**

- 5 Year Warranty\*
- Total No Frost
- All-Around Cooling
- Smart Conversion™
- Digital Inverter Compressor
- SpaceMax™
- Power Freeze
- Door Alarm
- Vacation Mode
- Reversible Door
- Child Lock

**ENERGY EFFICIENCY CLASS**



**ENERGY EFFICIENCY CLASS**



**ENERGY EFFICIENCY CLASS**



**ENERGY EFFICIENCY CLASS**



**PAIRING KIT**  
RA-COOK4BAA

**PAIRING KIT**  
RA-COOK4BAA

**PAIRING KIT**  
RA-COOK4BAA

**PAIRING KIT**  
RA-COOK4BAA

\*Requires registration from [www.samsung.com/uk/fiveyearwarranty](http://www.samsung.com/uk/fiveyearwarranty) within 90 days of purchase. Terms and conditions apply.

\*Requires registration from [www.samsung.com/uk/fiveyearwarranty](http://www.samsung.com/uk/fiveyearwarranty) within 90 days of purchase. Terms and conditions apply.

## Integrated Fridge Freezers Range



**BRB26600FWW**  
Integrated

**KEY FEATURES**

- 5 Year Warranty\*
- All-around Cooling
- SpaceMax™
- Total No Frost
- Door Alarm
- Vacation Mode
- Reversible Door

**ENERGY EFFICIENCY CLASS**

**F**



**BRB26615EWW**  
Integrated

**KEY FEATURES**

- 5 Year Warranty\*
- All-around Cooling
- SpaceMax™
- Total No Frost
- Door Alarm
- Vacation Mode
- Reversible Door
- Wine Rack

**ENERGY EFFICIENCY CLASS**

**E**



**BRB26705DWW**  
Integrated

**KEY FEATURES**

- 5 Year Warranty\*
- Twin Cooling Plus™
- CoolPlus Select Zone
- SpaceMax™
- Total No Frost
- Door Alarm
- Vacation Mode
- Metal Cooling Interior
- Reversible Door
- Wine Rack

**ENERGY EFFICIENCY CLASS**

**D**

## One Door Fridges Range



**RR39M73407F**  
Fridge

**KEY FEATURES**

- 5 Year Warranty\*
- 375L Capacity
- Total No Frost
- All-Around Cooling (Multi Flow Cooling)
- Non-plumbed water dispenser
- Digital Inverter Compressor
- Power Cool
- Door Alarm
- Vacation Mode
- Child Lock
- Reversible Doors
- LED Lighting
- Pairing Kit
- Hot Stamping

**ENERGY EFFICIENCY CLASS**

**F**



**RR39M7340B1**  
Fridge

**KEY FEATURES**

- 5 Year Warranty\*
- 375L Capacity
- Total No Frost
- All-Around Cooling (Multi Flow Cooling)
- Non-plumbed water dispenser
- Digital Inverter Compressor
- Power Cool
- Door Alarm
- Vacation Mode
- Child Lock
- Reversible Doors
- LED Lighting
- Pairing Kit
- Hot Stamping

**ENERGY EFFICIENCY CLASS**

**F**



**RR39M7340BC**  
Fridge

**KEY FEATURES**

- 5 Year Warranty\*
- 375L Capacity
- Total No Frost
- All-Around Cooling (Multi Flow Cooling)
- Non-plumbed water dispenser
- Digital Inverter Compressor
- Power Cool
- Door Alarm
- Vacation Mode
- Child Lock
- Reversible Doors
- LED Lighting
- Pairing Kit
- Hot Stamping

**ENERGY EFFICIENCY CLASS**

**F**

\*Requires registration from [www.samsung.com/uk/fiveyearwarranty](http://www.samsung.com/uk/fiveyearwarranty) within 90 days of purchase. Terms and conditions apply.

\*Requires registration from [www.samsung.com/uk/fiveyearwarranty](http://www.samsung.com/uk/fiveyearwarranty) within 90 days of purchase. Terms and conditions apply.

## One Door Fridges Range



**RR39M7340BN**

Fridge

**KEY FEATURES**

- 5 Year Warranty\*
- 375L Capacity
- Total No Frost
- All-Around Cooling (Multi Flow Cooling)
- Non-plumbed water dispenser
- Digital Inverter Compressor
- Power Cool
- Door Alarm
- Vacation Mode
- Child Lock
- Reversible Doors
- LED Lighting
- Pairing Kit
- Hot Stamping

**ENERGY EFFICIENCY CLASS**



**RR39M7340SA**

Fridge

**KEY FEATURES**

- 5 Year Warranty\*
- 375L Capacity
- Total No Frost
- All-Around Cooling (Multi Flow Cooling)
- Non-plumbed water dispenser
- Digital Inverter Compressor
- Power Cool
- Door Alarm
- Vacation Mode
- Child Lock
- Reversible Doors
- LED Lighting
- Pairing Kit
- Hot Stamping

**ENERGY EFFICIENCY CLASS**



**RR39M7140SA**

Fridge

**KEY FEATURES**

- 5 Year Warranty\*
- 385L Capacity
- Total No Frost
- All-Around Cooling (Multi Flow Cooling)
- Digital Inverter Compressor
- Power Cool
- Door Alarm
- Vacation Mode
- Child Lock
- Reversible Doors
- LED Lighting
- Pairing Kit
- Hot Stamping

**ENERGY EFFICIENCY CLASS**



## One Door Fridges Range



**RR39M7140WW**

Fridge

**KEY FEATURES**

- 5 Year Warranty\*
- 385L Capacity
- Total No Frost
- All-Around Cooling (Multi Flow Cooling)
- Digital Inverter Compressor
- Power Cool
- Door Alarm
- Vacation Mode
- Child Lock
- Reversible Doors
- LED Lighting
- Pairing Kit
- Hot Stamping

**ENERGY EFFICIENCY CLASS**



\*Requires registration from [www.samsung.com/uk/fiveyearwarranty](http://www.samsung.com/uk/fiveyearwarranty) within 90 days of purchase. Terms and conditions apply.

\*Requires registration from [www.samsung.com/uk/fiveyearwarranty](http://www.samsung.com/uk/fiveyearwarranty) within 90 days of purchase. Terms and conditions apply.



## One Door Freezers Range



**RZ32M71257F**  
Fridge

**KEY FEATURES**

- Customisable Module/Combination
- Large capacity in cabinet fit
- Total No Frost
- All-around Cooling
- Fast Freeze
- Flat & Cabinet Design
- Digital Inverter Technology
- LED Lighting
- Slim Ice Maker
- 5 Year Warranty\*

**ENERGY EFFICIENCY CLASS**



**RZ32M7125B1**  
Fridge

**KEY FEATURES**

- Customisable Module/Combination
- Large capacity in cabinet fit
- Total No Frost
- All-around Cooling
- Fast Freeze
- Flat & Cabinet Design
- Digital Inverter Technology
- LED Lighting
- Slim Ice Maker
- 5 Year Warranty\*

**ENERGY EFFICIENCY CLASS**



**RZ32M7125BN**  
Fridge

**KEY FEATURES**

- Customisable Module/Combination
- Large capacity in cabinet fit
- Total No Frost
- All-around Cooling
- Fast Freeze
- Flat & Cabinet Design
- Digital Inverter Technology
- LED Lighting
- Slim Ice Maker
- 5 Year Warranty\*

**ENERGY EFFICIENCY CLASS**



## One Door Freezers Range



**RZ32M7125SA**  
Fridge

**KEY FEATURES**

- Customisable Module/Combination
- Large capacity in cabinet fit
- Total No Frost
- All-around Cooling
- Fast Freeze
- Flat & Cabinet Design
- Digital Inverter Technology
- LED Lighting
- Slim Ice Maker
- 5 Year Warranty\*

**ENERGY EFFICIENCY CLASS**



**RZ32M7125WW**  
Fridge

**KEY FEATURES**

- Customisable Module/Combination
- Large capacity in cabinet fit
- Total No Frost
- All-around Cooling
- Fast Freeze
- Flat & Cabinet Design
- Digital Inverter Technology
- LED Lighting
- Slim Ice Maker
- 5 Year Warranty\*

**ENERGY EFFICIENCY CLASS**



**RZ32M71207F**  
Fridge

**KEY FEATURES**

- 5 Year Warranty\*
- 315L Capacity
- Total No Frost
- All-Around Cooling (Multi Flow Cooling)
- Digital Inverter Compressor
- Power Freeze
- Door Alarm
- Vacation Mode
- Child Lock
- Reversible Doors
- Slim IceMaker
- LED Lighting
- Compatible with Fridge
- Hot Stamping

**ENERGY EFFICIENCY CLASS**



\*Requires registration from [www.samsung.com/uk/fiveyearwarranty](http://www.samsung.com/uk/fiveyearwarranty) within 90 days of purchase. Terms and conditions apply.

\*Requires registration from [www.samsung.com/uk/fiveyearwarranty](http://www.samsung.com/uk/fiveyearwarranty) within 90 days of purchase. Terms and conditions apply.



**Save over 20% a year**  
 On your energy costs with a connected A rated Samsung Washing Machine\*<sup>1</sup>. Track your spending with SmartThings Energy\*<sup>2</sup>.



**Save over £200 a year**  
 With a connected Samsung Heat Pump Tumble Dryer\*<sup>1</sup>. Track your spending with SmartThings Energy\*<sup>2</sup>.

# Washing Machines

## The smarter way to lighten your load

Our range of Washing Machines are a breath of freshly laundered air. From being kinder to the environment and your wallet, to whizzing through each load or adding to the wash mid cycle, your wash days will be transformed.

### SmartThings



- ▶ **ecobubble™**  
Wash your clothes more efficiently at cooler temperatures.
- ▶ **AddWash™**  
You can quickly drop in anything you've forgotten during the wash.\*<sup>3</sup>
- ▶ **Smart Control+**  
Get a smarter washing experience.
- ▶ **Auto Cycle Link**  
Recommends a drying cycle based on your was cycle
- ▶ **Hygiene Steam**  
Eliminate 99.9% of bacteria and inactivating allergens.\*<sup>4</sup>
- ▶ **Bubble Soak**  
Deal with those stubborn stains.

\*1. 21% saving based on the average energy use of Samsung A rated Washing Machines versus the average energy usage of other manufacturers' washing machines sold in major UK retailers on 01/11/22. \*2. Selected models apply. SmartThings available on Android and iOS devices. A Wi-Fi connection and a Samsung account are required. \*3. AddWash™ door can be opened at any time when the drum temperature is below 50 C. \*4. Testing done by Intertek on Staphylococcus aureus and Escherichia coli and Dermatophagoides farinae Hughes, on 100% cotton, 3kg load, with standard powder detergent. Individual results may vary.

# Tumble Dryers

## Gently does it

A Tumble Dryer is a must for busy households. Our Tumble Dryers protect your clothes as they dry, so no need to worry about snagging your favourite top. As well as drying your clothes gently, they're gentler on the environment and your wallet too. And as clothes come out with less wrinkles, there's less ironing too.

### SmartThings



- ▶ **OptimalDry™**  
The temperature sensors adjust the drying time to save energy.
- ▶ **Quick Dry (35 mins)\*<sup>3</sup>**  
Quickly dry your favourite outfits for the day ahead.
- ▶ **Smart Control+**  
Get a smarter drying experience.
- ▶ **Auto Cycle Link**  
Recommends a drying cycle based on your was cycle
- ▶ **Wrinkle Prevent**  
Fewer wrinkles, less ironing.
- ▶ **Hygiene Care**  
Remove dust, mites and germs by putting your wet or dry clothes in your tumble dryer.

\*1. £207 saving based on the average energy usage of Samsung Heat Pump Tumble Dryers versus the average energy usage of condenser tumble dryers sold in major UK retailers on 21/10/21, completing 260 cycles per year on an energy cost of 18.86p per kWh. \*2. Selected models apply. SmartThings available on Android and iOS devices. A Wi-Fi connection and a Samsung account are required. \*3. 35 minute Quick Dry cycle for a 1kg load.



## Washer Dryers

Wash and dry days are no longer a chore

Getting your clothes clean is only half the battle. Our line up of Washer Dryers take the labour out of laundry by getting every basket load spotless and ready to wear.

SmartThings



- ▶ **ecobubble™**  
Wash your clothes more efficiently at cooler temperatures.
- ▶ **AddWash™**  
You can quickly drop in anything you've forgotten during the wash.\*<sup>1</sup>
- ▶ **Smart Control+**  
Get a smarter washing experience.
- ▶ **Wash & Dry (59 mins)<sup>2</sup>**  
Have your favourite outfit washed and dried in under an hour.
- ▶ **Hygiene Steam**  
Eliminate 99.9% of bacteria and inactivating allergens.\*<sup>3</sup>
- ▶ **Bubble Soak**  
Deal with those stubborn stains.

\*1. AddWash™ door can be opened at any time when the drum temperature is below 50 C. \*2. 59 minute Wash & Dry cycle for a 1Kg load. \*3. Testing done by Intertek on Staphylococcus aureus and Escherichia coli and Dermatophagoides farinae Hughes, on 100% cotton, 3kg load, with standard powder detergent. Individual results may vary.

## AirDresser

Get that just washed feeling every day

Here's a fresh idea clothes that stay hygienically clean and fresh in between washes. Say hello to AirDresser. Part wardrobe, part steam cleaner, it does away with germs, dust and even smooths out wrinkles. Then you're good to go.



- ▶ **JetSteam**  
Blasts away those lingering smells and hidden germs.
- ▶ **Deodorising Filter**  
Works wonders on those lingering smells.
- ▶ **Heatpump Drying**  
No more risking your delicates, HeatPump Drying takes gentle care of them.
- ▶ **Wrinkle Care**  
Neater, smoother clothes.
- ▶ **Self Clean**  
Eliminates germs and odours in the AirDresser.



## Feature Glossary Washing Machines & Washer Dryers



**ecobubble™**  
Make laundry less of a chore. ecobubble™ technology mixes air, water and detergent to create bubbles that wash your clothes at cooler temperatures.



**AddWash™**  
Whether it's that stray sock you missed or extra softener, with AddWash™ door you can quickly drop in anything extra during the wash\*1.



**Super Speed Wash**  
Get an entire 5kg load of laundry clean in just 39 minutes with your Samsung washing machine.



**Smart Control+**

With an intelligent, easy to use control panel, Samsung smart washing machines remember your family's laundry habits and suggest your favourite cycles first. From whites to bed change days, track every cycle's progress on the simply designed display. Then when the washing is done, you'll get a notification on your phone with the SmartThings app\*2. Want to make things even simpler? Use the app\*1 to schedule your washes and get guides to find the perfect setting.



**Hygiene Steam**  
Banish more than just stains and odours. The Hygiene Steam cycle releases hot steam, eliminating 99.9% of bacteria and inactivating allergens\*3.



**15 Minute Quick Wash**  
This programme is particularly convenient when you are short of time and need to quickly wash up to 2kg of your favourite garments.



**Fabric Care Drum**  
Our innovative Fabric Care Drum is designed to prevent clothes from snagging. While a cushioning layer of bubbles adds an extra level of care to your laundry.

\*2. Available on Android and iOS. An internet connection is required. \*1. AddWash™ door can be opened at any time when the drum temperature is below 50°C. \*3. Testing done by Intertek on Staphylococcus aureus and Escherichia coli and Dermatophagoides farinae Hughes, on 100% cotton, 3kg load, with standard powder detergent. Individual results may vary.

## Feature Glossary Washing Machines & Washer Dryers



**Drum Clean+**  
Removes 99.9% of bacteria\*4 from the drum and helps get rid of dirt from the door rubber seal. After 40 cycles the machine reminds you to run it.



**Stay Clean Drawer**  
With no soap build up, your detergent flows more freely into the drum for a cleaner, fresher wash.



**Bubble Soak**  
Whether it's cotton, synthetics or baby clothes, add a 30-minute bubble soak to your wash and deal with those stubborn stains.



**Digital Inverter Technology**  
A quiet washing machine that's built to last, economical and has the added peace of mind of a 10-year warranty.



**59 Minute Wash + Dry**  
Get your clothes washed and dried in less than an hour. It's ideal for loads of up to 1kg.

\*4. Eliminates 99.9% of bacteria from the inside of the washing machine and removes dirt from the rubber gasket. Based on testing by Intertek of the Drum Clean+ cycle.

## Feature Glossary Tumble Dryers



**Heat Pump Technology (A+++ Energy Rating)**  
Heat Pump not only takes care of your clothes, but as it's energy efficient, it keeps your wallet happy too.



**OptimalDry™**  
Who says you can't tumble dry without wasting energy? Our temperature sensors adjust the drying time to do exactly that.



**35 Minute Quick Dry**  
This cycle dries a load of clothes in just over half an hour. How handy is that? It's ideal for loads of up to 1kg.

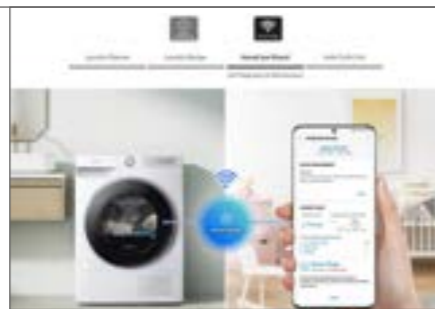

**Smart Control+**

With an intelligent, easy to use control panel, Samsung smart tumble dryers remember your family's laundry habits and suggest your favourite cycles first. Track every cycle's progress with the simply designed display. When the drying's done, you'll get a notification on your phone with the SmartThings app\*1. Schedule your dryer and get perfect cycle guides from the app. Use the Auto Cycle Link\*2 and let your washing machine recommend the right setting to your dryer.



**2 in 1 Filter**  
The filter collects fluff, meaning the heat exchange filter needs cleaning less often. It will even remind you when it needs to be done.

\*1. Available on Android and iOS. An internet connection is required. \*2. Auto Cycle Link is only available when both the washing machine and tumblers dryer have Smart Control and are Wi Fi connected.

## Feature Glossary AirDresser



**Deodorising Filter**  
Here's a real breath of fresh air. AirDresser's Deodorising Filter works wonders on those lingering smells!



**Bespoke**  
Add a stylish and unique look to your home. A customisable design means you can choose a finish to suit your lifestyle and taste.



**Heat Pump Drying**  
No more risking your delicates, let AirDresser's cool HeatPump Drying take care of them gently and quickly.



**Jet Air+ Air Hanger**  
The Jet Air system and Air Hangers blow dust and odours from your clothes so quietly, you can sleep through the whole process.

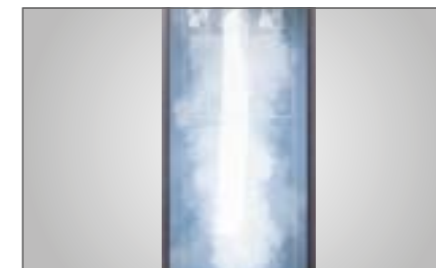

**JetSteam**  
Blasting hot steam through its bespoke clothes hangers, it tackles those lingering odours and hidden germs. The perfect way to refresh laundry.

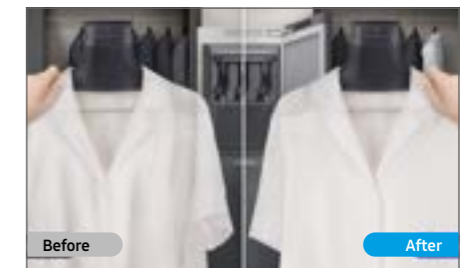

**Wrinkle Care**  
Neater, smoother clothes, without lifting a finger... all thanks to Airdresser's Wrinkle Care system relaxing creases.

Washing Machine



**WW90T554DAW**  
9Kg Washing Capacity

KEY FEATURES

- ecobubble™
- AddWash™
- Smart Control+
- Hygiene Steam
- 15min Quick Wash
- Fabric Care Drum
- Drum Clean
- Stay Clean Drawer
- Bubble Soak
- Digital Inverter Technology
- 5 Year Warranty\*

ENERGY EFFICIENCY CLASS



MATCHING TUMBLE DRYER  
DV90T5240AW

STACKING KIT  
SKK-UDW

Tumble Dryer



**DV90T5240AW**  
9Kg Drying Capacity

KEY FEATURES

- Heat Pump Technology (A+++ Energy Rating)
- OptimalDry™
- Smart Control+
- Reversible Door
- Quick Dry 35mins
- 2-in-1 Filter
- Wrinkle Prevent
- 5 Year Warranty\*

ENERGY EFFICIENCY CLASS



MATCHING WASHING MACHINES  
WW90T554DAW

STACKING KIT  
SKK-UDW

Washer Dryers



**WD80TA046BE**  
8Kg Washing Capacity  
5Kg Drying Capacity

KEY FEATURES

- ecobubble™
- Hygiene Steam
- 15min Quick Wash
- Fabric Care Drum
- Drum Clean
- Stay Clean Drawer
- Bubble Soak
- Digital Inverter Technology
- 5 Year Warranty\*

ENERGY EFFICIENCY CLASS WASH



ENERGY EFFICIENCY CLASS WASH & DRY



**WD90T654DBH**  
9Kg Washing Capacity  
6Kg Drying Capacity

KEY FEATURES

- ecobubble™
- AddWash™
- Smart Control+
- 59min Wash + Dry
- Super Speed Wash
- Hygiene Steam
- 15min Quick Wash
- Fabric Care Drum
- Drum Clean+
- Stay Clean Drawer
- Bubble Soak
- Digital Inverter Technology
- 5 Year Warranty\*

ENERGY EFFICIENCY CLASS WASH



ENERGY EFFICIENCY CLASS WASH & DRY



AirDressers



**DF60A8500HG**

KEY FEATURES

- JetSteam
- Deodorising Filter
- Heatpump Drying
- Wrinkle Care
- Jet Air + Air Hanger
- Self Clean
- SmartThings
- Soft Closing Door
- Dehumidification

KEY FEATURES

- Bespoke
- JetSteam
- Deodorising Filter
- Fine Dust Filter
- Heatpump Drying
- Wrinkle Care
- Jet Air + Air Hanger
- Self Clean
- SmartThings
- Soft Closing Door
- Dehumidification

\*Requires registration from [www.samsung.com/uk/fiveyearwarranty](http://www.samsung.com/uk/fiveyearwarranty) within 90 days of purchase. Terms and conditions apply.

\*Requires registration from [www.samsung.com/uk/fiveyearwarranty](http://www.samsung.com/uk/fiveyearwarranty) within 90 days of purchase. Terms and conditions apply.





## Integrated Dishwashers

Slots seamlessly into your life.

Our built in dishwashers are designed to fit neatly and effortlessly into the hub of your home. They're also stacked with technology to make dishwashing hassle free. From the basics done brilliantly, right up to handy little bonus features.

- ▶ **Half Load**  
Run a quick, energy saving, cycle.
- ▶ **A\* Wash and Dry Performance**  
All our dishwashers have at least an A rating.
- ▶ **Eco Wash**  
Bring down those energy bills.
- ▶ **Delicate Wash**  
Protect your delicate glasses while they wash.
- ▶ **Intensive Wash**  
Heavy duty loads are no match for this powerful deep cleanse.
- ▶ **Flexible Load System**  
Loading the dishwasher is much easier.

# Feature Glossary



### Auto Door Open

Auto Door Open lets the steam escape at the end of the cycle, so every item dries perfectly.



### Info Light

Check if your Samsung dishwasher is working with one quick glance! The floor Info Light projects a blue beam onto the floor when a wash cycle is in progress.



### Flexible Load System

Loading the dishwasher is much less fiddly with these adjustable racks.



### Flexible Third Rack

The Flexible 3rd Rack gives you extra space at the top for cutlery and utensils. So you can make the most of the space below.



### Half Load

Dishwasher only half full? No problem. Run a quick half load and save energy.



### Daily 55™ Cycle

Get all the everyday essentials clean, dry and ready to go in less than an hour.



### Daily 60min Express Wash

If you're short on time or have lighter loads, Express Wash powers through them in an hour.

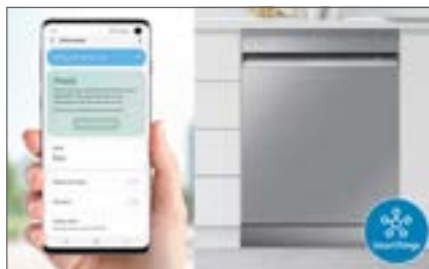

### Smart Control+

Tap into handy reminders, tailored cycles and the freedom to control your dishwasher from anywhere\*.



### Eco Wash

For lighter loads, choose Eco Wash and bring down those energy bills.

# Feature Glossary



### Delicate Wash

Trust this gentle setting to protect your delicate glasses while they wash, and still come out sparkling.



### Intensive Wash

Heavy duty loads are no match for the deep cleaning power of Intensive Wash.



### Quick Wash

Entertaining and need clean dishes fast? The Quick Wash programme has your back.



### Auto Wash

No more half cleaned crockery. Auto Wash works out the best way to get your dishes spotless, so you don't have to.



### Quiet Washing

Enjoy the peace and quiet of your home while your dishwasher silently washes away in the background.



### Ice Blue LED Display

The uber stylish Ice Blue LED display makes it easy to select the cycle you want.



### Flexible Racks

Loading the dishwasher is much less fiddly with these adjustable racks.



### Flexible Interior Space

Flex your dishwasher space to fit your every load.

\*. Available on Android and iOS. An internet connection is required.



# Integrated Dishwashers



## DW50R4040BB

Fully Built-In (Slim line)

### KEY FEATURES

- 9 Place Settings
- 6 Programmes
- 46dB(A)
- Half Load
- Flexible Racks
- Flexible interior space
- Hygiene Option
- Eco Wash
- Delicate Wash
- Intensive Wash
- Quick Wash
- Normal Wash
- Ice Blue LED Display
- Delay Start
- Child Lock
- Aqua-Stop

### ENERGY EFFICIENCY CLASS

F

## DW60M5050BB

Fully Built-In (Full Size)

### KEY FEATURES

- 13 Place Settings
- 5 Programmes
- 48dB(A)
- 60 minute Express Wash
- Flexible Racks
- Flexible interior space
- Half Load
- Hygiene Option
- Eco Wash
- Intensive Wash
- Delicate Wash
- Ice Blue LED Display
- Delay Start
- Child Lock
- Aqua-Stop

### ENERGY EFFICIENCY CLASS

F

## DW60M6040BB

Fully Built-In (Full Size)

### KEY FEATURES

- 13 Place Settings
- 6 Programmes
- 44dB(A)
- 60 minute Express Wash
- Flexible Racks
- Flexible interior space
- Half Load
- Hygiene Option
- Auto Wash
- Eco Wash
- Intensive Wash
- Delicate Wash
- Ice Blue LED Display
- Delay Start
- Child Lock
- Aqua-Stop

### ENERGY EFFICIENCY CLASS

E

## DW60A8060BB

Fully Built-In (Full Size)

### KEY FEATURES

- 14 Place Settings
- 8 / 12 Programmes
- 43dB(A)
- Auto Door Open
- 55 minute Express Wash
- Flex Load System
- Smart Things
- Flexible Racks
- Flexible interior space
- Speed Booster
- Half Load
- Metal 3rd Rack
- Self Clean Wash
- Hygiene Option
- Eco Wash
- Delicate Wash
- Intensive Wash
- Ice Blue LED Display
- Delay Start
- Child Lock
- Aqua-Stop

### ENERGY EFFICIENCY CLASS

B





# Bespoke Jet™

## Lightweight power for max efficiency

With Samsung's new All in one Clean Station you can clean with ease as its lightweight design also packs in incredible suction power of up to 210W\*1. Whether you're vacuuming your floors or hygienically emptying your vacuum's dustbin, enjoy exceptionally effective cleaning from start to finish.

- ▶ **All-in-one Clean station**  
Does all the hard work and effectively\*2 empties the dustbin using "Air Pulse" technology for maximum hygiene, while recharging the battery at the same time.
- ▶ **Multi-layered Filtration System**  
The 99.999% Multi layered Filtration system traps 99.999% of dust\*3 to boost your air quality.
- ▶ **Digital Inverter Motor**  
Makes for a super light, yet powerful vacuum.
- ▶ **Jet Cyclone**  
Enjoy clean air and consistent suction power with a high efficiency.

\*1. Suction tested based on the IEC62885-2 Cl. 5.8 standard, tested at the inlet of the non motorized tool, using Jet mode. Based on internal tests. \*2. Results may vary depending on individual use. Dust and hair stuck inside the grille may not be removed with a single cycle. \*3. Tested internally based on IEC 62885-2, CL.5.11 using the Jet mode. Results may vary depending on actual usage. \*4. Compared to the VS9000. \*5. The stated run time applies to the minimum power level with a non motorized tool attached. Results may vary depending on actual usage. \*6. The displayed time may differ from the actual usage time and is continuously updated every second. The usage time may shorten based on the number of uses.

## Feature Glossary



**All-in-one Clean station**  
Does all the hard work and effectively\*2 empties the dustbin using "Air Pulse" technology for maximum hygiene, while recharging the battery at the same time.



**Multi-layered Filtration System**  
The 99.999% Multi layered Filtration system traps 99.999% of dust\*3 to boost your air quality.



**Digital Inverter Motor**  
Makes for a super light, yet powerful vacuum. With the improved stator, rotor and 3D fan, it's now 47%\*4 lighter, delivering up to 210W\*1 of suction.



**Jet Cyclone**  
Say goodbye to unreachable dust with the extreme suction power of Samsung's Jet Cyclone.



**High-Capacity Interchangeable Battery**  
Vacuum the whole house in one go, with up to 1 hour\*5 run time, thanks to the long-lasting, removable battery



**LCD Digital Display**  
Manually check everything is ready to go. Check which suction level you're using, how much charge you have\*6, and even get troubleshooting alerts.



**Lightweight Design**  
Gain maximum usability and reduce the strain on your wrist.



**Telescopic Pipe**  
No more crouching or craning when you're vacuuming adjust or extend the telescopic pipe to make it more comfortable for your height.



**Fully Washable Dust Bin**  
No bags, no mess, no hassle, emptying the dustbin is hygienic and with easy. The whole 0.5L dustbin is fully washable, so it can be kept clean and hygienic.

# Bespoke Jet™



**VS20A95823W**  
Bespoke Jet™

**KEY FEATURES**

- All-in-one Clean station
- Multi-layered Filtration System
- Digital Inverter Motor
- Jet Cyclone
- High-Capcity Battery
- High Efficient Motorised Brushes
- LCD Digital Display
- Lightweight Design
- Telescopic Pipe
- Interchangable Batteries
- Accessory Cradle
- Fully Washable Dust Bin
- One Click Detachable Drum
- Intuitive LED Lighting

**ACCESSORIES**

- Jet Dual Brush
- Pet Tool
- Combination & Crevice Tool
- Flexible Tool
- Accessory Cradle
- x1 Battery



**VS20A95843W**  
Bespoke Jet™ Pet

**KEY FEATURES**

- All-in-one Clean station
- Multi-layered Filtration System
- Digital Inverter Motor
- Jet Cyclone
- High-Capcity Battery
- High Efficient Motorised Brushes
- LCD Digital Display
- Lightweight Design
- Telescopic Pipe
- Interchangable Batteries
- Accessory Cradle
- Fully Washable Dust Bin
- One Click Detachable Drum
- Intuitive LED Lighting

**ACCESSORIES**

- Jet Dual Brush
- Pet Tool
- Slim Action Brush
- Combination & Crevice Tool
- Flexible Tool
- Accessory Cradle
- x1 Battery



**VS20A95943N**  
Bespoke Jet™ Complete Extra

**KEY FEATURES**

- All-in-one Clean station
- Multi-layered Filtration System
- Digital Inverter Motor
- Jet Cyclone
- High-Capcity Battery
- High Efficient Motorised Brushes
- LCD Digital Display
- Lightweight Design
- Telescopic Pipe
- Interchangable Batteries
- Accessory Cradle
- Fully Washable Dust Bin
- One Click Detachable Drum
- Intuitive LED Lighting

**ACCESSORIES**

- Jet Dual Brush
- Pet Tool
- Slim Action Brush
- Combination & Crevice Tool
- Flexible Tool
- Accessory Cradle
- x2 Batteries



**VS20A95973B**  
Bespoke Jet™ Pro Extra

**KEY FEATURES**

- All-in-one Clean station
- Multi-layered Filtration System
- Digital Inverter Motor
- Jet Cyclone
- High-Capcity Battery
- High Efficient Motorised Brushes
- LCD Digital Display
- Lightweight Design
- Telescopic Pipe
- Interchangable Batteries
- Accessory Cradle
- Fully Washable Dust Bin
- One Click Detachable Drum
- Intuitive LED Lighting

**ACCESSORIES**

- Jet Dual Brush
- Spray Spinning Sweeper
- Pet Tool
- Combination & Crevice Tool
- Flexible Tool
- Antibacterial Reusable Pads
- Disposable Wet Pads
- Accessory Cradle
- x2 Batteries

