



FCC RF Test Report

APPLICANT : TCL Communication Ltd.
EQUIPMENT : Mobile Phone
BRAND NAME : ALCATEL ONETOUCH
MODEL NAME : 8050E
MARKETING NAME : PIXI 4 6" 3G Android
FCC ID : 2ACCJB036
STANDARD : FCC Part 15 Subpart C §15.247
CLASSIFICATION : (DTS) Digital Transmission System

The product was received on Nov. 03, 2015 and testing was completed on Dec. 16, 2015. We, SPORTON INTERNATIONAL (SHENZHEN) INC., would like to declare that the tested sample has been evaluated in accordance with the test procedures and has been in compliance with the applicable technical standards.

The test results in this report apply exclusively to the tested model / sample. Without written approval of SPORTON INTERNATIONAL (SHENZHEN) INC., the test report shall not be reproduced except in full.

Prepared by: Andy Yeh / Manager

Approved by: Jones Tsai / Manager

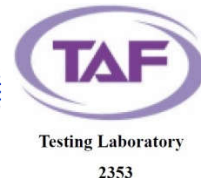

SPORTON INTERNATIONAL (SHENZHEN) INC.

**1F & 2F, Building A, Morning Business Center, No. 4003 ShiGu Rd., Xili Town,
Nanshan District, Shenzhen, Guangdong, P. R. China**



TABLE OF CONTENTS

1 GENERAL DESCRIPTION..... 5

1.1 Applicant.....5

1.2 Manufacturer.....5

1.3 Product Feature of Equipment Under Test.....5

1.4 Product Specification subjective to this standard6

1.5 Specification of Accessory.....6

1.6 Modification of EUT6

1.7 Testing Location7

1.8 Applicable Standards.....7

2 TEST CONFIGURATION OF EQUIPMENT UNDER TEST..... 8

2.1 Descriptions of Test Mode.....8

2.2 Test Mode.....9

2.3 Connection Diagram of Test System..... 10

2.4 Support Unit used in test configuration and system 11

2.5 EUT Operation Test Setup 11

2.6 Measurement Results Explanation Example..... 11

3 TEST RESULT 12

3.1 6dB Bandwidth Measurement 12

3.2 Peak Output Power Measurement 15

3.3 Power Spectral Density Measurement 17

3.4 Conducted Band Edges and Spurious Emission Measurement 23

3.5 Radiated Band Edges and Spurious Emission Measurement 32

3.6 AC Conducted Emission Measurement..... 37

3.7 Antenna Requirements..... 41

4 LIST OF MEASURING EQUIPMENT..... 42

5 UNCERTAINTY OF EVALUATION..... 43

APPENDIX A. RADIATED TEST RESULTS

APPENDIX B. SETUP PHOTOGRAPHS



REVISION HISTORY

REPORT NO.	VERSION	DESCRIPTION	ISSUED DATE
FR5N0302B	Rev. 01	Initial issue of report	Jan. 05, 2016



SUMMARY OF TEST RESULT

Report Section	FCC Rule	Description	Limit	Result	Remark
3.1	15.247(a)(2)	6dB Bandwidth	$\geq 0.5\text{MHz}$	Pass	-
3.2	15.247(b)(1)	Peak Output Power	$\leq 30\text{dBm}$	Pass	-
3.3	15.247(e)	Power Spectral Density	$\leq 8\text{dBm}/3\text{kHz}$	Pass	-
3.4	15.247(d)	Conducted Band Edges and Spurious Emission	$\leq 20\text{dBc}$	Pass	-
3.5	15.247(d)	Radiated Band Edges and Spurious Emission	15.209(a) & 15.247(d)	Pass	Under limit 9.32 dB at 61.040 MHz
3.6	15.207	AC Conducted Emission	15.207(a)	Pass	Under limit 6.82 dB at 0.440 MHz
3.7	15.203 & 15.247(b)	Antenna Requirement	N/A	Pass	-



1 General Description

1.1 Applicant

TCL Communication Ltd.

5F, C-Tower, No. 232, Liang Jing Road, ZhangJiang High-Tech Park, Pudong Area, Shanghai, 201203, P.R.China

1.2 Manufacturer

TCL Communication Ltd.

5F, C-Tower, No. 232, Liang Jing Road, ZhangJiang High-Tech Park, Pudong Area, Shanghai, 201203, P.R.China

1.3 Product Feature of Equipment Under Test

Product Feature	
Equipment	Mobile Phone
Brand Name	ALCATEL ONETOUCH
Model Name	8050E
Marketing Name	PIXI 4 6" 3G Android
FCC ID	2ACCJB036
EUT supports Radios application	GSM/GPRS/EGPRS (Downlink Only)/ WCDMA/HSPA/HSPA+ (16QAM uplink is not supported)/ WLAN 2.4GHz 802.11b/g/n HT20/HT40/ Bluetooth v3.0 + EDR/Bluetooth v4.1 LE
GSM Operating Band(s)	GSM 900/1800/1900/850MHz
GPRS / EGPRS Multi Slot Class	GPRS Class 12, EGPRS Class 12(Downlink Only)
WCDMA Operating Band(s)	FDD Band I / II / V/ VIII
MEID Code	Conducted: 014574000100436/014574000100444 Radiation: 014574000100451/014574000100469 Conduction: 014574000100519/014574000100527
HW Version	V04
SW Version	1A1D
EUT Stage	Production Unit

Remark: The above EUT's information was declared by manufacturer. Please refer to the specifications or user's manual for more detailed description.



1.4 Product Specification subjective to this standard

Product Specification subjective to this standard	
Tx/Rx Frequency Range	2402 MHz ~ 2480 MHz
Number of Channels	40
Carrier Frequency of Each Channel	40 Channel(37 hopping + 3 advertising channel)
Maximum Output Power to Antenna	-2.20 dBm (0.0006 W)
Antenna Type/Gain	PIFA Antenna with gain -1.50 dBi
Type of Modulation	Bluetooth LE : GFSK

1.5 Specification of Accessory

Specification of Accessory			
AC Adapter 1	Brand Name	ALCATEL ONETOUCH	Model Name UC11US
	Power Rating	I/P: 100-240Vac, 200mA, O/P: 5Vdc, 1000mA	
	P/N	CBA0058AG0C2	
AC Adapter 2	Brand Name	ALCATEL ONETOUCH	Model Name UC11US
	Power Rating	I/P: 100-240Vac, 200mA, O/P: 5Vdc, 1000mA	
	P/N	CBA0058AG0C3	
Battery 1	Brand Name	ALCATEL ONETOUCH	Model Name TLp025D2
	Power Rating	3.8Vdc, 2580mAh	
	S/N	C2600002C2YHV0FE	
Battery 2	Brand Name	ALCATEL ONETOUCH	Model Name TLp025DC
	Power Rating	3.8Vdc, 2580mAh	
	S/N	C2600003CCJ0006G	
USB Cable 1	Brand Name	N/A	Model Name N/A
	Signal Line Type	1.0meter,shielded cable, without ferrite core	
USB Cable 2	Brand Name	N/A	Model Name N/A
	Signal Line Type	1.0meter,shielded cable, without ferrite core	
Earphone 1	Brand Name	N/A	Model Name N/A
	Signal Line Type	1.5meter,non-shielded cable, without ferrite core	
Earphone 2	Brand Name	N/A	Model Name N/A
	Signal Line Type	1.5meter,non-shielded cable, without ferrite core	

1.6 Modification of EUT

No modifications are made to the EUT during all test items.



1.7 Testing Location

Test Site	SPORTON INTERNATIONAL (SHENZHEN) INC.	
Test Site Location	1F & 2F, Building A, Morning Business Center, No. 4003 ShiGu Rd., Xili Town, Nanshan District, Shenzhen, Guangdong, P. R. China TEL: +86-755-8637-9589 FAX: +86-755-8637-9595	
Test Site No.	Sporton Site No.	
	TH01-SZ	CO01-SZ

Test Site	SPORTON INTERNATIONAL (SHENZHEN) INC.	
Test Site Location	No. 3 Building, the third floor of south, Shahe River west, Fengzeyuan warehouse, Nanshan District, Shenzhen, Guangdong, P. R. China TEL: +86-755- 3320-2398	
Test Site No.	Sporton Site No.	FCC Registration No.
	03CH02-SZ	566869

Note: The test site complies with ANSI C63.4 2009 requirement.

1.8 Applicable Standards

According to the specifications of the manufacturer, the EUT must comply with the requirements of the following standards:

- FCC Part 15 Subpart C §15.247
- FCC KDB Publication No. 558074 D01 DTS Meas. Guidance v03r03
- ANSI C63.10-2013

Remark:

1. All test items were verified and recorded according to the standards and without any deviation during the test.
2. This EUT has also been tested and complied with the requirements of FCC Part 15, Subpart B, recorded in a separate test report.



2 Test Configuration of Equipment Under Test

2.1 Descriptions of Test Mode

The RF output power was recorded in the following table:

Channel	Frequency	Bluetooth 4.1 LE RF Output Power	
		Data Rate / Modulation	
		GFSK	
		1Mbps	
Ch00	2402MHz	-2.20 dBm	
Ch19	2440MHz	-2.42 dBm	
Ch39	2480MHz	-2.81 dBm	

- a. The EUT has been associated with peripherals and configuration operated in a manner tended to maximize its emission characteristics in a typical application. Frequency range investigated: conduction (150 kHz to 30 MHz), radiation (9 kHz to the 10th harmonic of the highest fundamental frequency or to 40 GHz, whichever is lower). Pre-scanned tests, X, Y, Z in three orthogonal panels to determine the final configuration (Z plane as worst plane) from all possible combinations.

- b. AC power line Conducted Emission was tested under maximum output power.



2.2 Test Mode

The following summary table is showing all test modes to demonstrate in compliance with the standard.

Summary table of Test Cases	
Test Item	Data Rate / Modulation
	Bluetooth 4.1 – LE / GFSK
Conducted TCs	Mode 1: Bluetooth Tx CH00_2402 MHz_1Mbps Mode 2: Bluetooth Tx CH19_2440 MHz_1Mbps Mode 3: Bluetooth Tx CH39_2480 MHz_1Mbps
Radiated TCs	Mode 1: Bluetooth Tx CH00_2402 MHz_1Mbps Mode 2: Bluetooth Tx CH19_2440 MHz_1Mbps Mode 3: Bluetooth Tx CH39_2480 MHz_1Mbps
AC Conducted Emission	Mode 1: GSM850 Idle + Bluetooth Link + WLAN Link + Earphone 1 + USB Cable 1 (Charging from Adapter 1) + Battery 1 + SIM 1
Remark: For Radiated Test Cases, The tests were performance with Adapter 1, Earphone 1, Battery 1 and USB Cable 1.	

2.3 Connection Diagram of Test System

<Bluetooth v4.1 LE Tx Mode>

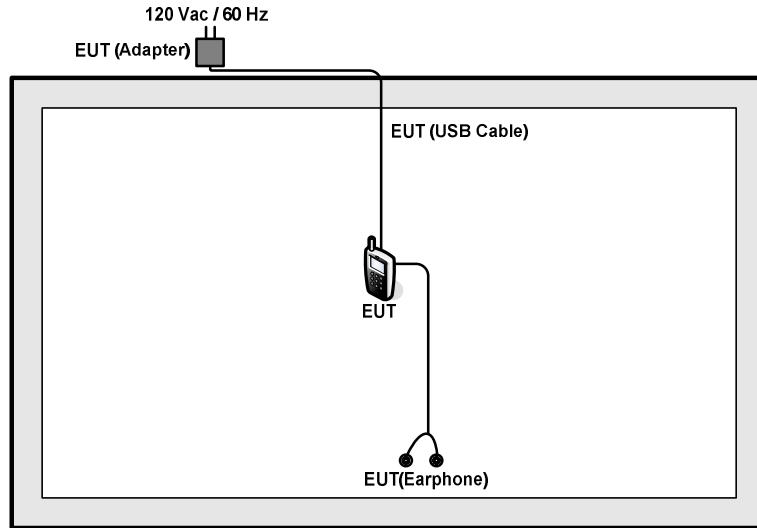

<AC Conducted Emission Mode>

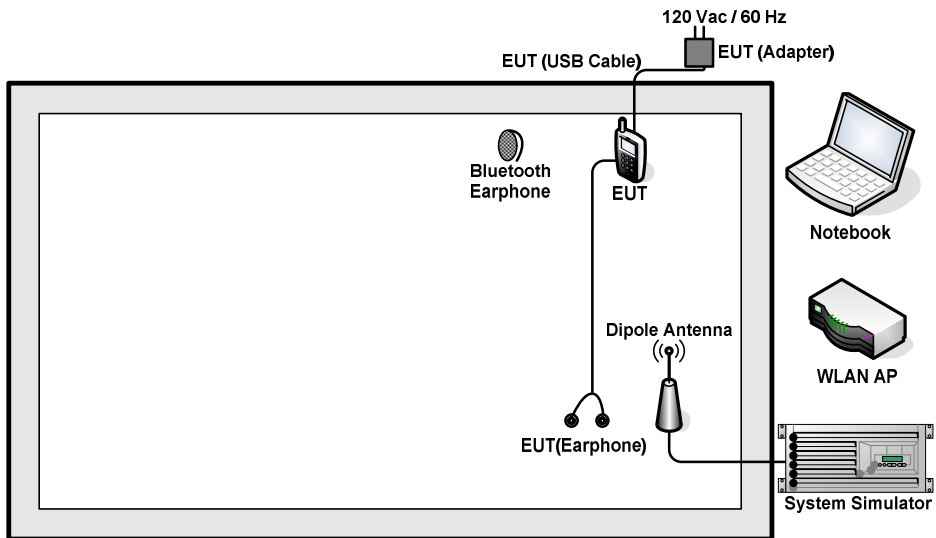



2.4 Support Unit used in test configuration and system

Item	Equipment	Trade Name	Model Name	FCC ID	Data Cable	Power Cord
1.	System Simulator	Anritsu	MT8820C	N/A	N/A	Unshielded, 1.8 m
2.	WLAN AP	D-link	DIR-628	KA2DIR628A2	N/A	Unshielded, 1.8 m
3.	Notebook	Lenovo	E540	FCC DoC	N/A	shielded cable DC O/P 1.8 m unshielded AC I/P cable 1.2 m
4.	Bluetooth Earphone	Nokia	BH-108	PYAHS-107W	N/A	N/A

2.5 EUT Operation Test Setup

For Bluetooth v4.1 LE function, the engineering test program was provided and enabled to make EUT continuous transmit/receive.

For AC power line conducted emissions, the EUT was set to connect with the WLAN AP under large package sizes transmission.

2.6 Measurement Results Explanation Example

For all conducted test items:

The offset level is set in the spectrum analyzer to compensate the RF cable loss and attenuator factor between EUT conducted output port and spectrum analyzer. With the offset compensation, the spectrum analyzer reading level is exactly the EUT RF output level.

Example :

The spectrum analyzer offset is derived from RF cable loss and attenuator factor.

Offset = RF cable loss + attenuator factor.

Following shows an offset computation example with cable loss 5.0 dB and 10dB attenuator.

Offset(dB) = RF cable loss(dB) + attenuator factor(dB).

$$= 5.0 + 10 = 15.0 \text{ (dB)}$$

3 Test Result

3.1 6dB Bandwidth Measurement

3.1.1 Limit of 6dB Bandwidth

The minimum 6 dB bandwidth shall be at least 500 kHz.

3.1.2 Measuring Instruments

The section 4.0 of List of Measuring Equipment of this test report is used for test.

3.1.3 Test Procedures

1. The testing follows FCC KDB Publication No. 558074 D01 DTS Meas. Guidance v03r03.
2. The RF output of EUT was connected to the spectrum analyzer by RF cable and attenuator. The path loss was compensated to the results for each measurement.
3. Set to the maximum power setting and enable the EUT transmit continuously.
4. Make the measurement with the spectrum analyzer's resolution bandwidth (RBW) = 100 kHz. Set the Video bandwidth (VBW) = 300 kHz. In order to make an accurate measurement. The 6 dB bandwidth must be greater than 500 kHz.
5. Measure and record the results in the test report.

3.1.4 Test Setup





3.1.5 Test Result of 6dB Bandwidth

Test Mode :	Bluetooth v4.1 LE	Temperature :	24~26°C
Test Engineer :	Mygai Mo	Relative Humidity :	50~53%

Channel	Frequency (MHz)	6dB Bandwidth (MHz)	6dB Bandwidth Min. Limit (MHz)	Pass/Fail
00	2402	0.709	0.5	Pass
19	2440	0.707	0.5	Pass
39	2480	0.707	0.5	Pass

6 dB Bandwidth Plot on Channel 00

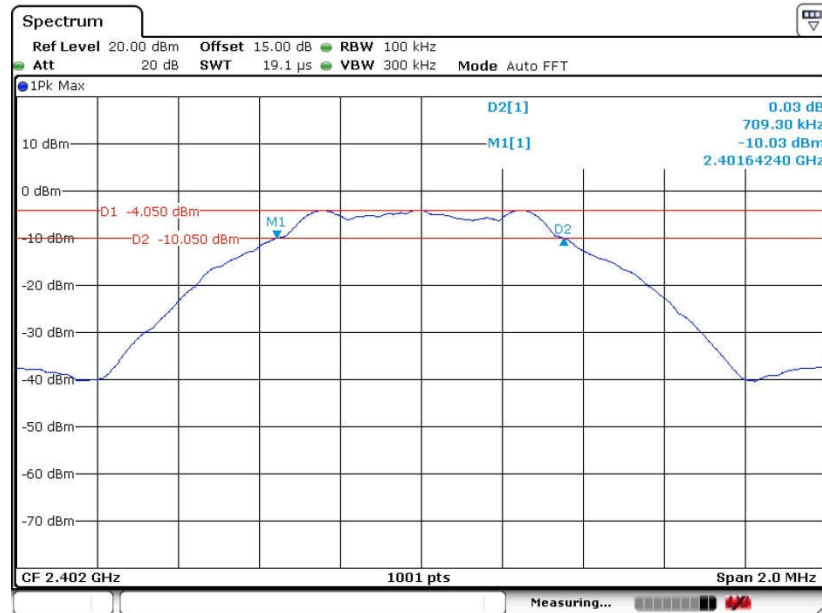

Date: 2.DEC.2015 19:18:00



6 dB Bandwidth Plot on Channel 19

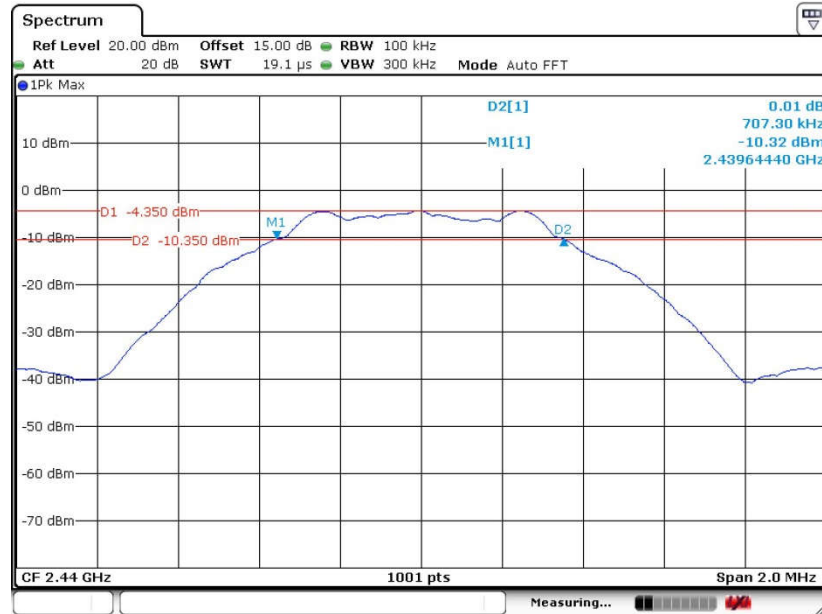

6 dB Bandwidth Plot on Channel 39

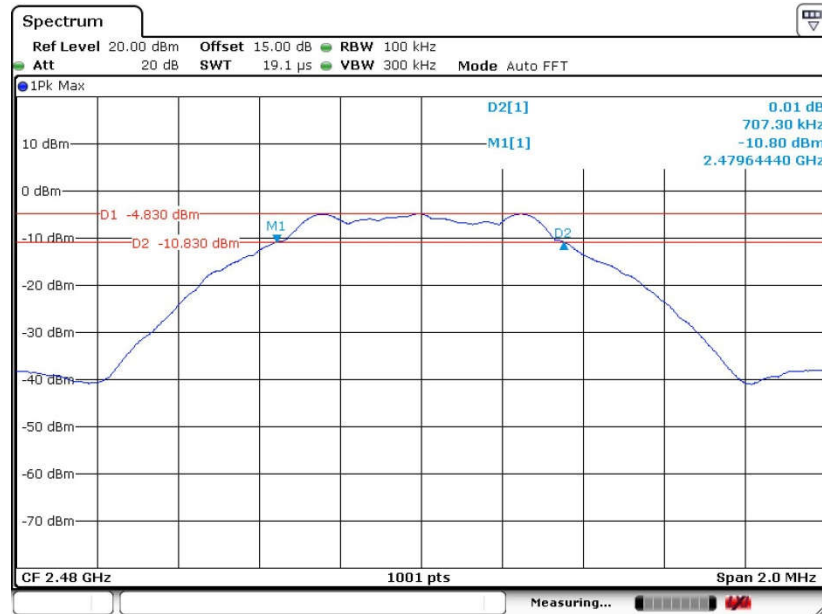

3.2 Peak Output Power Measurement

3.2.1 Limit of Peak Output Power

For systems using digital modulation in the 2400-2483.5MHz, the limit for peak output power is 30dBm. If transmitting antenna of directional gain greater than 6dBi is used, the peak output power from the intentional radiator shall be reduced below the above stated value by the amount in dB that the directional gain of the antenna exceeds 6 dBi. In case of point-to-point operation, the limit has to be reduced by 1dB for every 3dB that the directional gain of the antenna exceeds 6dBi.

3.2.2 Measuring Instruments

The section 4.0 of List of Measuring Equipment of this test report is used for test.

3.2.3 Test Procedures

1. The testing follows the Measurement Procedure of FCC KDB No. 558074 DTS D01 Meas. Guidance v03r03 section 9.1.2 PKPM1 Peak power meter method.
2. The RF output of EUT was connected to the power meter by RF cable and attenuator. The path loss was compensated to the results for each measurement.
3. Set to the maximum power setting and enable the EUT transmit continuously.
4. Measure the conducted output power and record the results in the test report.

3.2.4 Test Setup

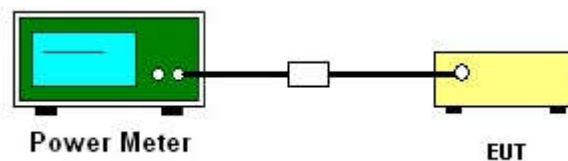



3.2.5 Test Result of Peak Output Power

Test Mode :	Bluetooth v4.1 LE	Temperature :	24~26°C
Test Engineer :	Mygai Mo	Relative Humidity :	50~53%

Channel	Frequency (MHz)	RF Power (dBm)		
		GFSK	Max. Limits (dBm)	Pass/Fail
		1 Mbps		
00	2402	-2.20	30.00	Pass
19	2440	-2.42	30.00	Pass
39	2480	-2.81	30.00	Pass

3.3 Power Spectral Density Measurement

3.3.1 Limit of Power Spectral Density

The peak power spectral density shall not be greater than 8dBm in any 3kHz band at any time interval of continuous transmission.

3.3.2 Measuring Instruments

The section 4.0 of List of Measuring Equipment of this test report is used for test.

3.3.3 Test Procedures

1. The testing follows Measurement Procedure 10.2 Method PKPSD of FCC KDB Publication No. 558074 D01 DTS Meas. Guidance v03r03
2. The RF output of EUT was connected to the spectrum analyzer by RF cable and attenuator. The path loss was compensated to the results for each measurement.
3. Set to the maximum power setting and enable the EUT transmit continuously.
4. Make the measurement with the spectrum analyzer's resolution bandwidth (RBW) = 3 kHz. Video bandwidth VBW = 10 kHz In order to make an accurate measurement, set the span to 1.5 times DTS Channel Bandwidth. (6dB BW)
5. Detector = peak, Sweep time = auto couple, Trace mode = max hold, Allow trace to fully stabilize. Use the peak marker function to determine the maximum power level.
6. Measure and record the results in the test report.
7. The Measured power density (dBm)/ 100kHz is a reference level and used as 20dBc down limit line for Conducted Band Edges and Conducted Spurious Emission.

3.3.4 Test Setup

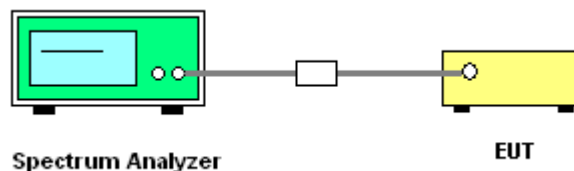



3.3.5 Test Result of Power Spectral Density

Test Mode :	Bluetooth v4.1 LE	Temperature :	24~26°C
Test Engineer :	Mygai Mo	Relative Humidity :	50~53%

Channel	Frequency (MHz)	Power Density		Max. Limits (dBm/3kHz)	Pass/Fail
		PSD/100kHz (dBm)	PSD/3kHz (dBm)		
00	2402	-4.01	-18.88	8	Pass
19	2440	-4.34	-19.23	8	Pass
39	2480	-4.85	-19.73	8	Pass

Note:

1. Measured power density (dBm) has offset with cable loss.
2. The Measured power density (dBm)/ 100kHz is reference level and used as 20dBc down for Conducted Band Edges and Conducted Spurious Emission limit line.



3.3.6 Test Result of Power Spectral Density Plots (100kHz)

PSD 100kHz Plot on Channel 00

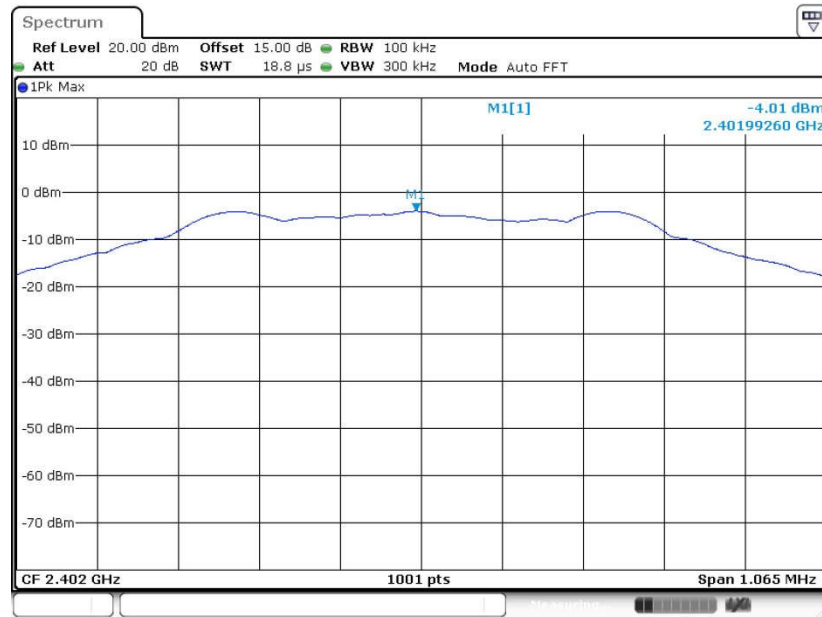

Date: 2.DEC.2015 19:22:46

PSD 100kHz Plot on Channel 19

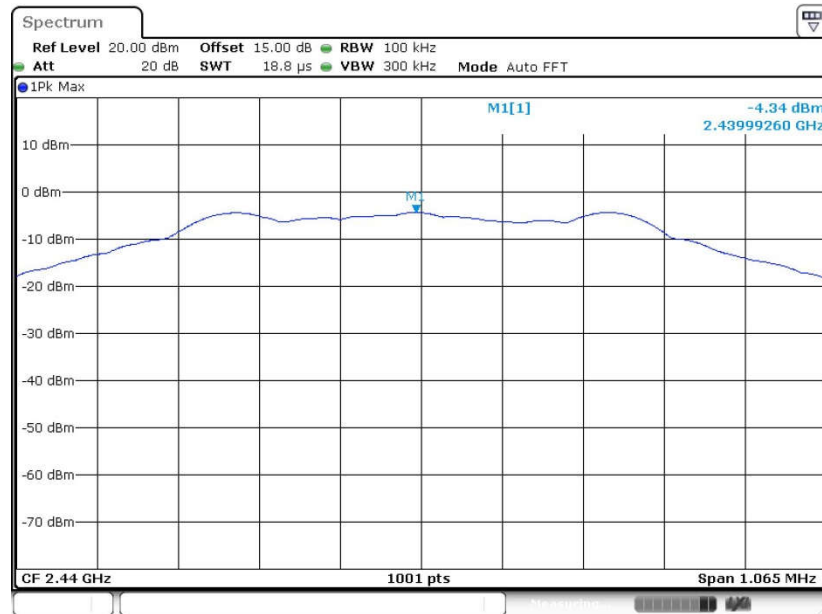

Date: 2.DEC.2015 19:33:47



PSD 100kHz Plot on Channel 39

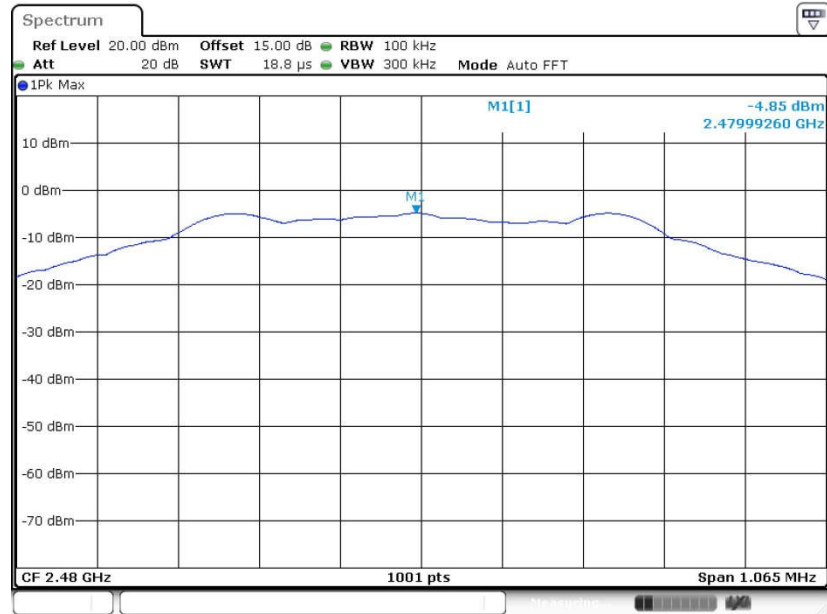

Date: 2.DEC.2015 19:42:09



3.3.7 Test Result of Power Spectral Density Plots (3kHz)

PSD 3kHz Plot on Channel 00

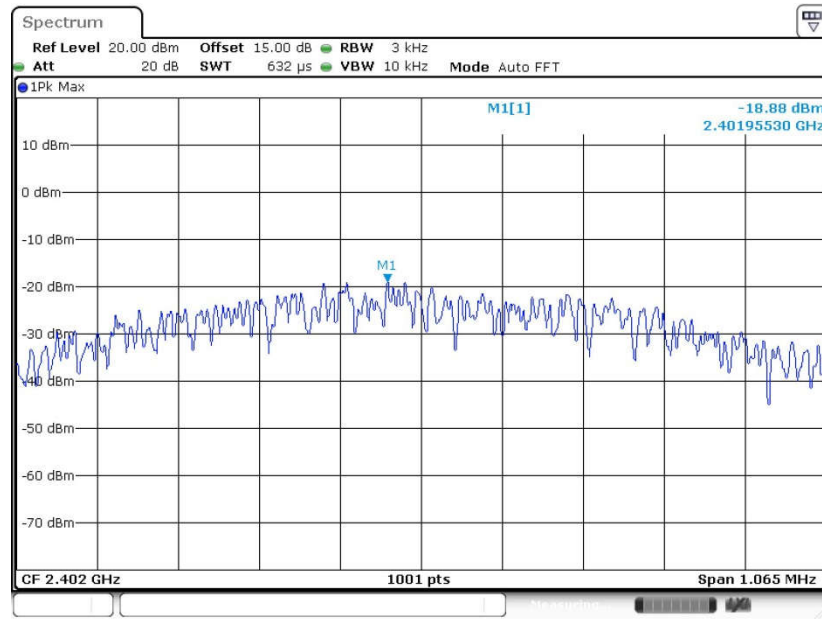

PSD 3kHz Plot on Channel 19

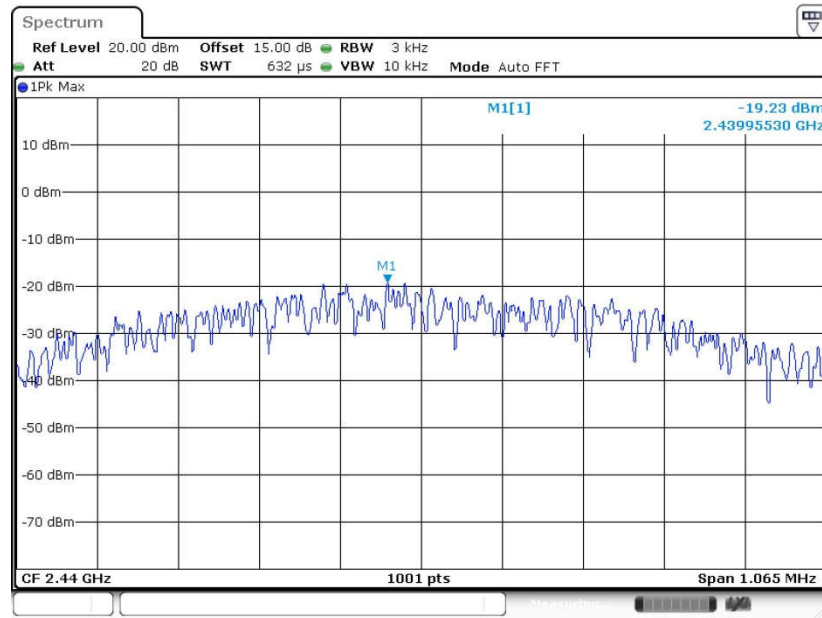



PSD 3kHz Plot on Channel 39

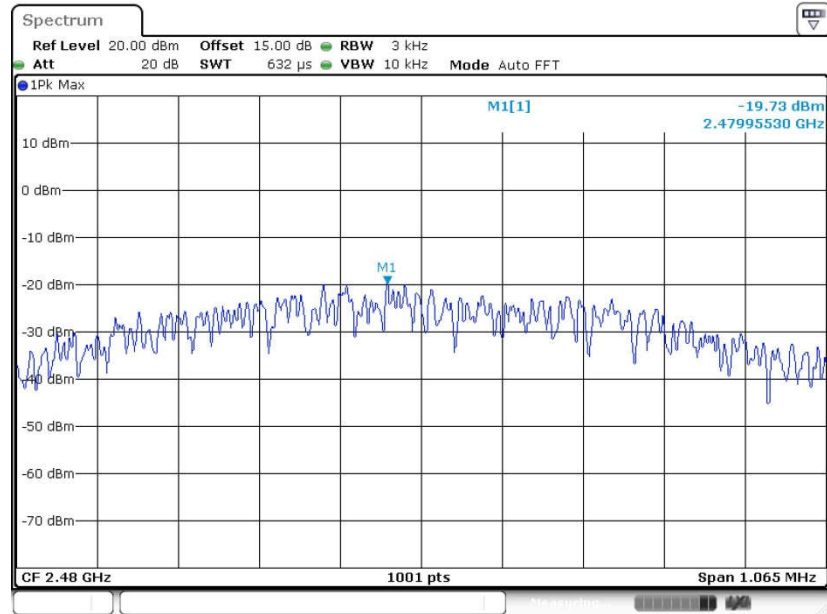

Date: 2.DEC.2015 19:39:34

3.4 Conducted Band Edges and Spurious Emission Measurement

3.4.1 Limit of Conducted Band Edges and Spurious Emission

All harmonics/spurious must be at least 20 dB down from the highest emission level within the authorized band.

3.4.2 Measuring Instruments

The section 4.0 of List of Measuring Equipment of this test report is used for test.

3.4.3 Test Procedure

1. The testing follows FCC KDB Publication No. 558074 D01 DTS Meas. Guidance v03r03.
2. The RF output of EUT was connected to the spectrum analyzer by RF cable and attenuator. The path loss was compensated to the results for each measurement.
3. Set to the maximum power setting and enable the EUT transmit continuously.
4. Set RBW = 100 kHz, VBW=300 kHz, Peak Detector. Unwanted Emissions measured in any 100 kHz bandwidth outside of the authorized frequency band shall be attenuated by at least 20 dB relative to the maximum in-band peak PSD level in 100 kHz when maximum peak conducted output power procedure is used. If the transmitter complies with the conducted power limits based on the use of RMS averaging over a time interval, the attenuation required under this paragraph shall be 30 dB instead of 20 dB per 15.247(d).
5. Measure and record the results in the test report.
6. The RF fundamental frequency should be excluded against the limit line in the operating frequency band.

3.4.4 Test Setup

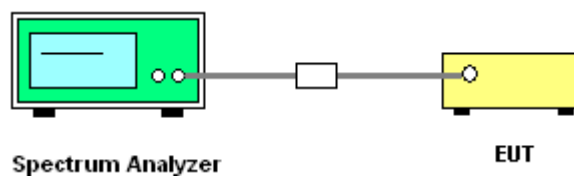



3.4.5 Test Result of Conducted Band Edges Plots

Test Mode :	Bluetooth v4.1 LE	Temperature :	24~26°C
Test Channel :	00 and 39	Relative Humidity :	50~53%
		Test Engineer :	Mygai Mo

Low Band Edge Plot on Channel 00

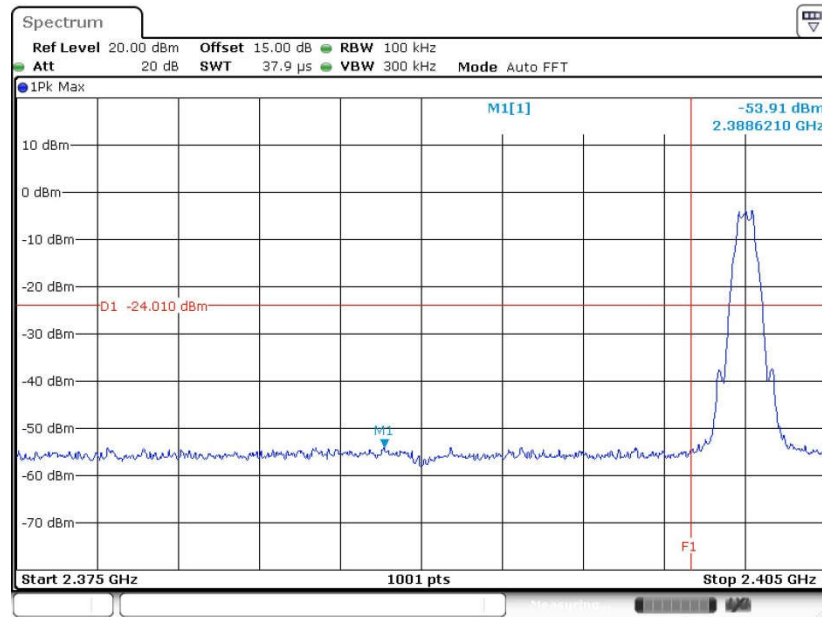

Date: 2.DEC.2015 19:25:56



High Band Edge Plot on Channel 39

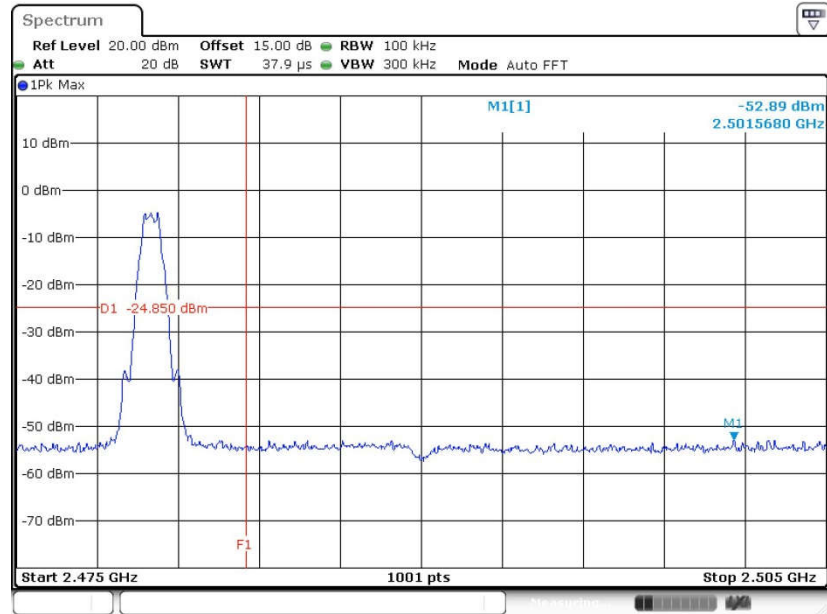

Date: 2.DEC.2015 19:44:20



3.4.6 Test Result of Conducted Spurious Emission Plots

Test Mode :	Bluetooth v4.1 LE	Temperature :	24~26°C
Test Channel :	00	Relative Humidity :	50~53%
		Test Engineer :	Mygai Mo

Conducted Spurious Emission Plot on Bluetooth LE 1Mbps GFSK Channel 00

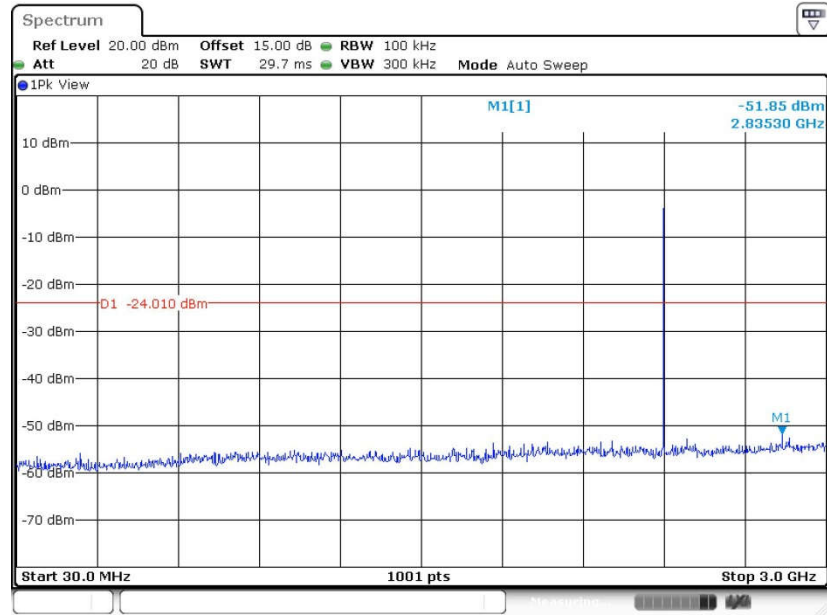



Conducted Spurious Emission Plot on Bluetooth LE 1Mbps
GFSK Channel 00

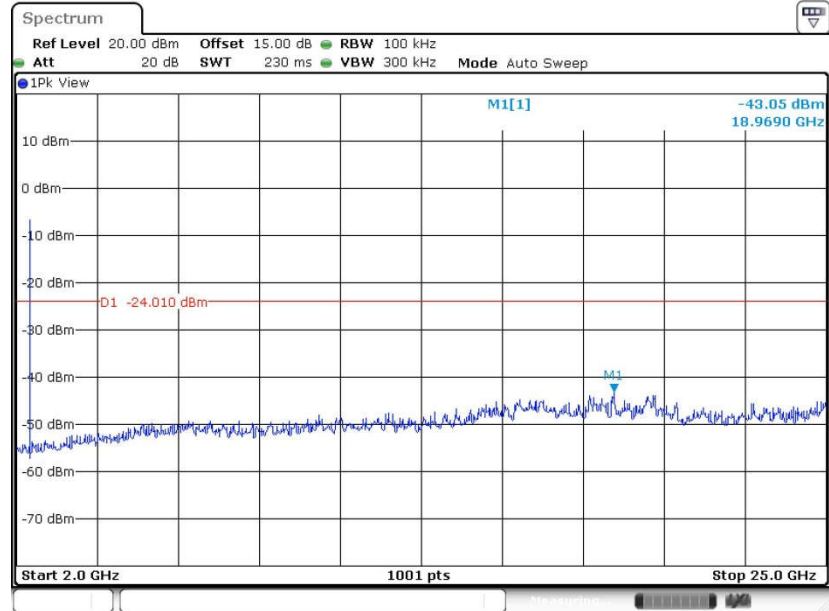

Date: 2.DEC.2015 19:26:49



Test Mode :	Bluetooth v4.1 LE	Temperature :	24~26°C
Test Channel :	19	Relative Humidity :	50~53%
		Test Engineer :	Mygai Mo

Conducted Spurious Emission Plot on Bluetooth LE 1Mbps
GFSK Channel 19

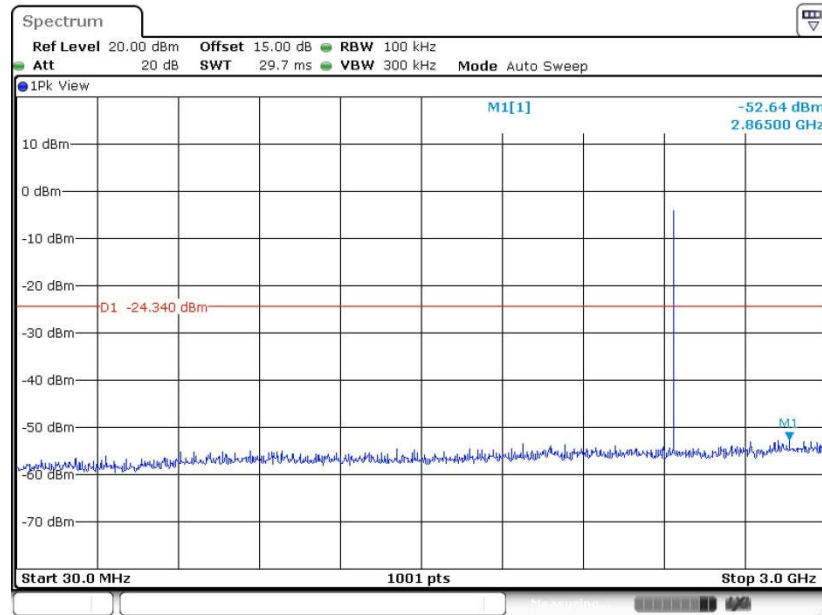



Conducted Spurious Emission Plot on Bluetooth LE 1Mbps
GFSK Channel 19

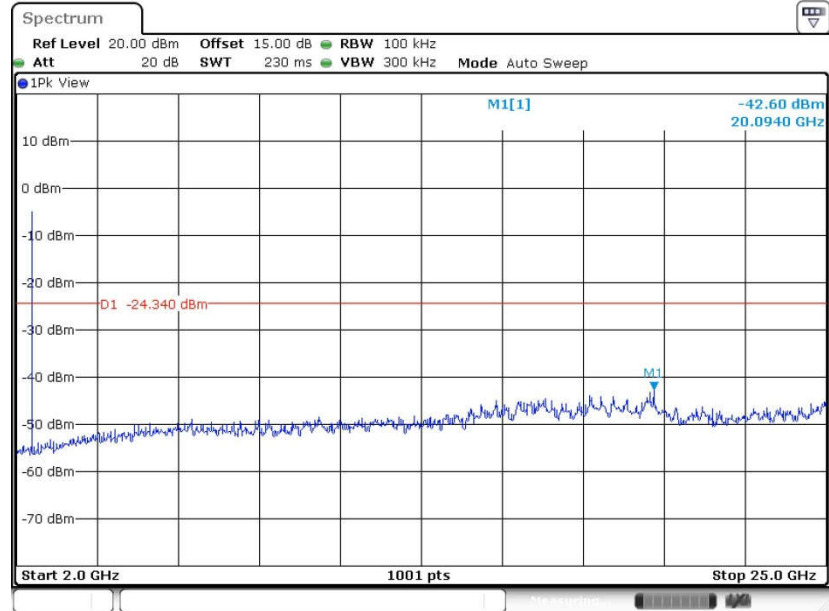

Date: 2.DEC.2015 19:35:28



Test Mode :	Bluetooth v4.1 LE	Temperature :	24~26°C
Test Channel :	39	Relative Humidity :	50~53%
		Test Engineer :	Mygai Mo

Conducted Spurious Emission Plot on Bluetooth LE 1Mbps
GFSK Channel 39

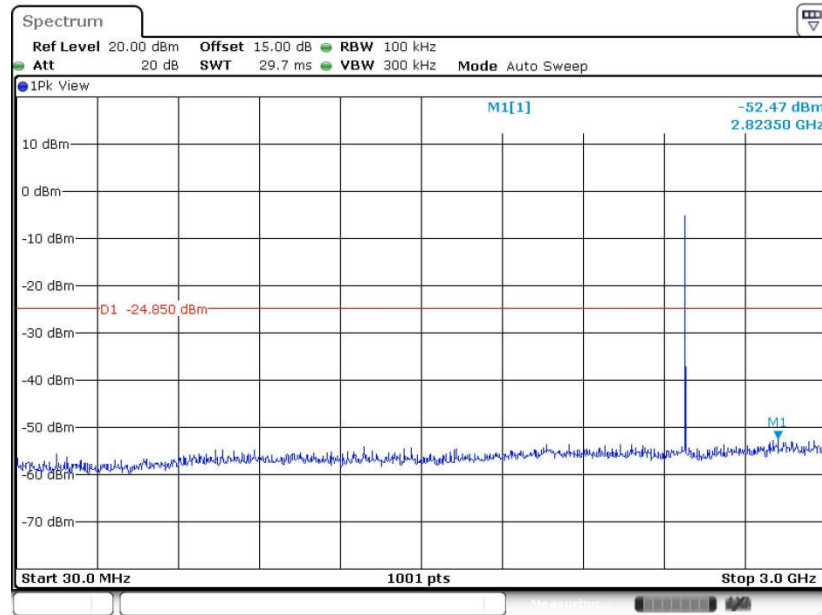

Date: 2.DEC.2015 19:47:42



Conducted Spurious Emission Plot on Bluetooth LE 1Mbps
GFSK Channel 39

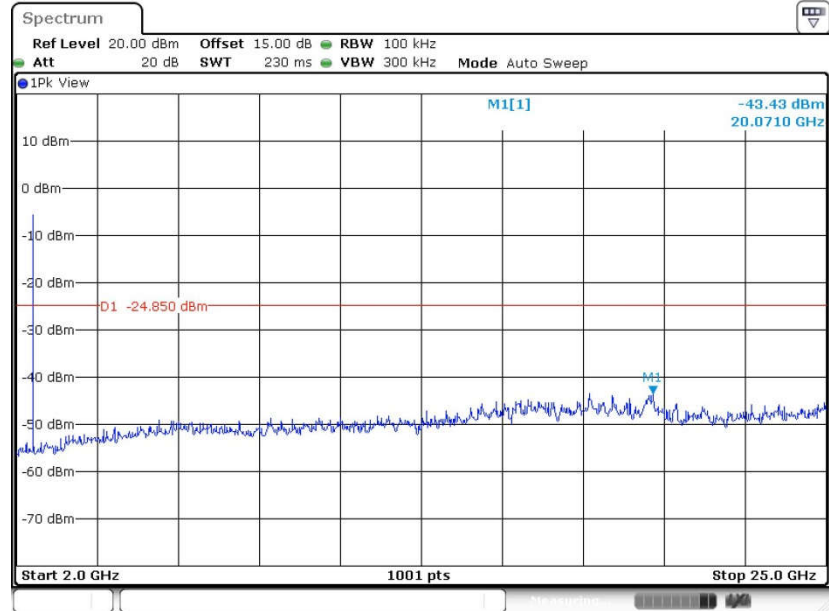

Date: 2.DEC.2015 19:47:50



3.5 Radiated Band Edges and Spurious Emission Measurement

3.5.1 Limit of Radiated Band Edges and Spurious Emission

In any 100 kHz bandwidth outside the intentional radiator frequency band, all harmonics/spurious must be at least 20 dB below the highest emission level within the authorized band. If the output power of this device was measured by spectrum analyzer, the attenuation under this paragraph shall be 30 dB instead of 20 dB. In addition, radiated emissions which fall in the restricted bands must also comply with the FCC section 15.209 limits as below.

Frequency (MHz)	Field Strength (microvolts/meter)	Measurement Distance (meters)
0.009 – 0.490	2400/F(kHz)	300
0.490 – 1.705	24000/F(kHz)	30
1.705 – 30.0	30	30
30 – 88	100	3
88 – 216	150	3
216 - 960	200	3
Above 960	500	3

3.5.2 Measuring Instruments

The section 4.0 of List of Measuring Equipment of this test report is used for test.



3.5.3 Test Procedures

1. The testing follows FCC KDB Publication No. 558074 D01 DTS Meas. Guidance v03r03.
2. The EUT was arranged to its worst case and then tune the antenna tower (from 1 m to 4 m) and turntable (from 0 degree to 360 degrees) to find the maximum reading. A pre-amp and a high pass filter are used for the test in order to get better signal level.
3. The EUT was placed on a turntable with 0.8 meter for frequency below 1GHz and 1.5 meter for frequency above 1GHz respectively above ground.
4. The EUT was set 3 meters from the interference receiving antenna, which was mounted on the top of a variable height antenna tower.
5. Corrected Reading: Antenna Factor + Cable Loss + Read Level - Preamp Factor = Level
6. For measurement below 1GHz, If the emission level of the EUT measured by the peak detector is 3 dB lower than the applicable limit, the peak emission level will be reported. Otherwise, the emission measurement will be repeated using the quasi-peak detector and reported.
7. Use the following spectrum analyzer settings:
 - (1) Span shall wide enough to fully capture the emission being measured;
 - (2) Set RBW=100 kHz for $f < 1$ GHz; $VBW \geq RBW$; Sweep = auto; Detector function = peak; Trace = max hold;
 - (3) Set RBW = 1 MHz, VBW= 3MHz for $f \geq 1$ GHz for peak measurement.

For average measurement:

 - $VBW = 10$ Hz, when duty cycle is no less than 98 percent.
 - $VBW \geq 1/T$, when duty cycle is less than 98 percent where T is the minimum transmission duration over which the transmitter is on and is transmitting at its maximum power control level for the tested mode of operation.

Band	Duty Cycle(%)	T(ms)	1/T(kHz)	VBW Setting
Bluetooth v4.1 LE	60.22	0.38	2.63	3kHz

3.5.4 Test Setup

For radiated emissions below 30MHz

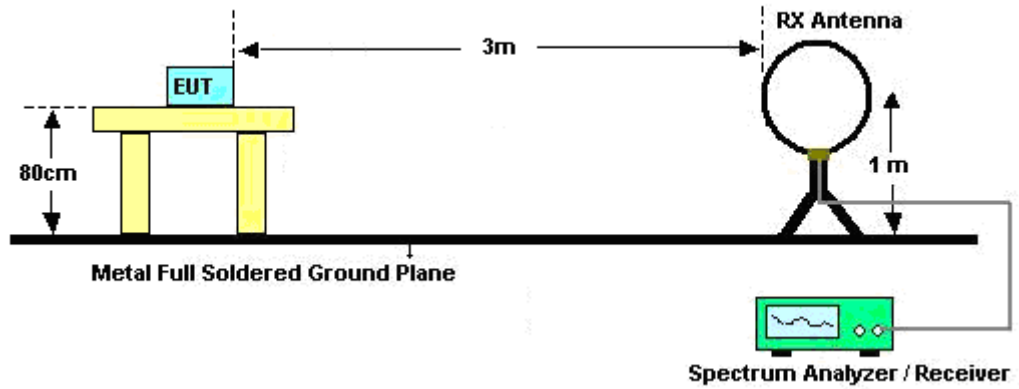

For radiated emissions from 30MHz to 1GHz

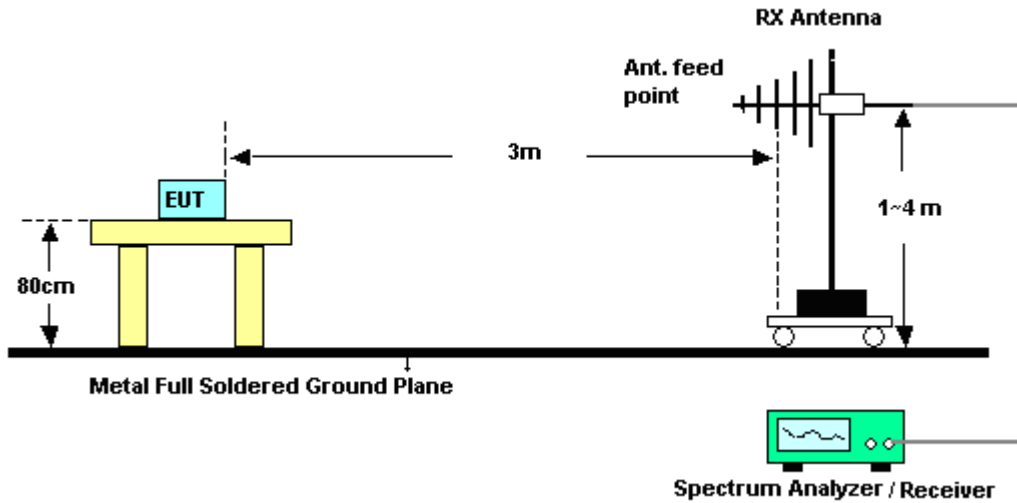

For radiated emissions above 1GHz

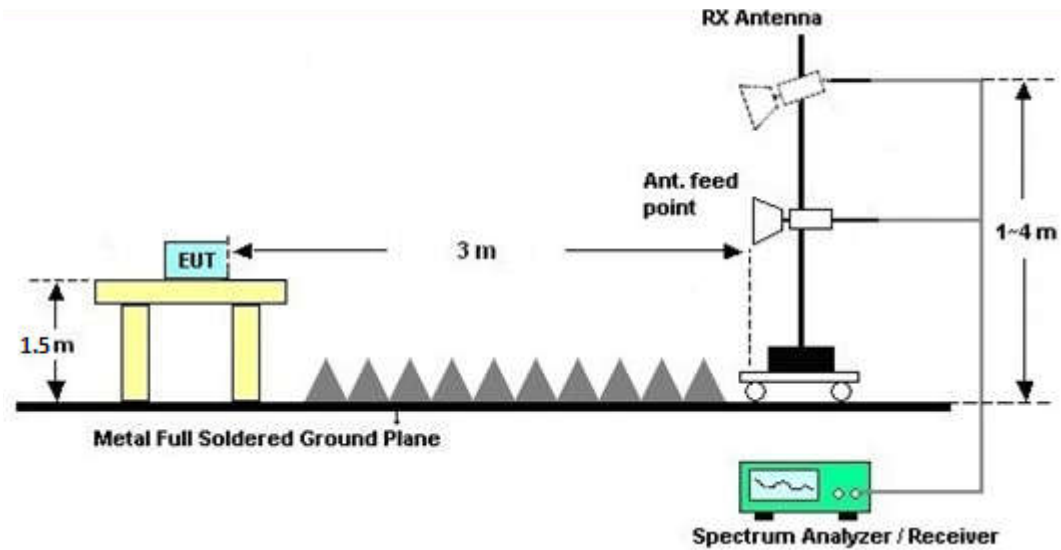

3.5.5 Test Results of Radiated Spurious Emissions (9 kHz ~ 30 MHz)

The low frequency, which started from 9 kHz to 30MHz, was pre-scanned and the result which was 20dB lower than the limit line per 15.31(o) was not reported.



3.5.6 Test Result of Radiated Spurious at Band Edges

Please refer to Appendix A.

3.5.7 Test Result of Radiated Spurious Emission (30MHz ~ 10th Harmonic)

Please refer to Appendix A.



3.6 AC Conducted Emission Measurement

3.6.1 Limit of AC Conducted Emission

For equipment that is designed to be connected to the public utility (AC) power line, the radio frequency voltage that is conducted back onto the AC power line on any frequency or frequencies within the band 150 kHz to 30 MHz shall not exceed the limits in the following table.

Frequency of emission (MHz)	Conducted limit (dB μ V)	
	Quasi-peak	Average
0.15-0.5	66 to 56*	56 to 46*
0.5-5	56	46
5-30	60	50

*Decreases with the logarithm of the frequency.

3.6.2 Measuring Instruments

The section 4.0 of List of Measuring Equipment of this test report is used for test.

3.6.3 Test Procedures

1. The EUT was placed 0.4 meter from the conducting wall of the shielding room was kept at least 80 centimeters from any other grounded conducting surface.
2. Connect EUT to the power mains through a line impedance stabilization network (LISN).
3. All the support units are connecting to the other LISN.
4. The LISN provides 50 ohm coupling impedance for the measuring instrument.
5. The FCC states that a 50 ohm, 50 microhenry LISN should be used.
6. Both sides of AC line were checked for maximum conducted interference.
7. The frequency range from 150 kHz to 30 MHz was searched.
8. Set the test-receiver system to Peak Detect Function and specified bandwidth (IF Bandwidth = 9kHz) with Maximum Hold Mode. Then measurement is also conducted by Average Detector and Quasi-Peak Detector Function respectively.

3.6.4 Test Setup





3.6.5 Test Result of AC Conducted Emission

Test Mode :	Mode 1	Temperature :	21~23°C
Test Engineer :	Jacky Yang	Relative Humidity :	41~43%
Test Voltage :	120Vac / 60Hz	Phase :	Line
Function Type :	GSM850 Idle + Bluetooth Link + WLAN Link + Earphone 1 + USB Cable 1 (Charging from Adapter 1) + Battery 1 + SIM 1		

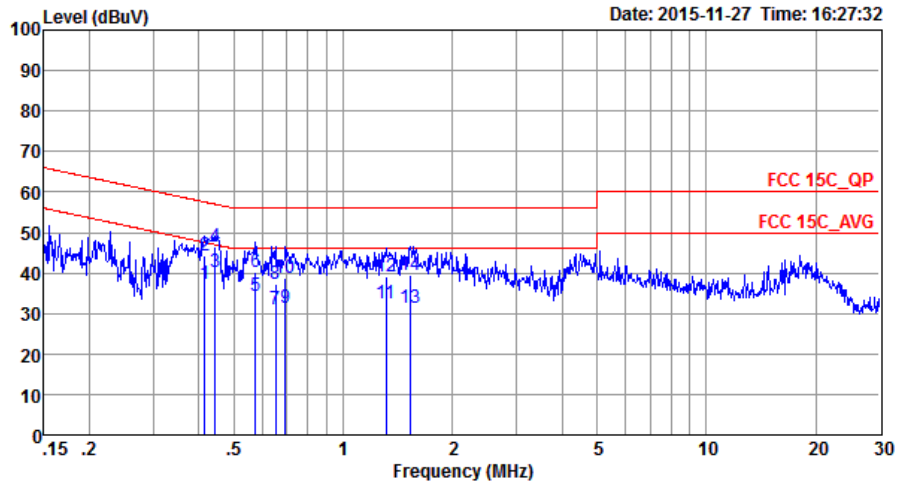

Site : CO01-SZ
 Condition: FCC 15C_QP LISN_L_20150304 LINE

Mode : Mode 1
 IMEI : 014574000100519/014574000100527

	Freq	Level	Over Limit	Limit Line	Read Level	LISN Factor	Cable Loss	Remark
	MHz	dBuV	dB	dBuV	dBuV	dB	dB	
1	0.41	37.43	-10.12	47.55	26.70	0.56	10.17	Average
2	0.41	44.13	-13.42	57.55	33.40	0.56	10.17	QP
3 *	0.44	40.16	-6.82	46.98	29.40	0.60	10.16	Average
4	0.44	46.36	-10.62	56.98	35.60	0.60	10.16	QP
5	0.57	34.47	-11.53	46.00	23.70	0.62	10.15	Average
6	0.57	40.37	-15.63	56.00	29.60	0.62	10.15	QP
7	0.65	30.82	-15.18	46.00	20.10	0.57	10.15	Average
8	0.65	37.22	-18.78	56.00	26.50	0.57	10.15	QP
9	0.69	31.19	-14.81	46.00	20.50	0.54	10.15	Average
10	0.69	38.89	-17.11	56.00	28.20	0.54	10.15	QP
11	1.31	32.56	-13.44	46.00	21.90	0.49	10.17	Average
12	1.31	39.06	-16.94	56.00	28.40	0.49	10.17	QP
13	1.53	31.35	-14.65	46.00	20.70	0.48	10.17	Average
14	1.53	39.55	-16.45	56.00	28.90	0.48	10.17	QP



Test Mode :	Mode 1	Temperature :	21~23°C
Test Engineer :	Jacky Yang	Relative Humidity :	41~43%
Test Voltage :	120Vac / 60Hz	Phase :	Neutral
Function Type :	GSM850 Idle + Bluetooth Link + WLAN Link + Earphone 1 + USB Cable 1 (Charging from Adapter 1) + Battery 1 + SIM 1		

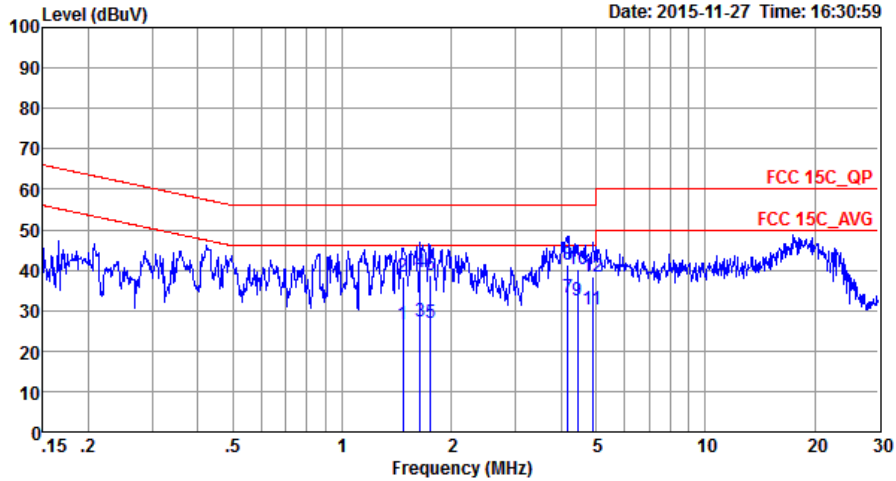

Site : CO01-SZ
 Condition: FCC 15C_QP LISN_N_20150304 NEUTRAL

Mode : Mode 1
 IMEI : 014574000100519/014574000100527

	Freq	Level	Over Limit	Limit Line	Read Level	LISN Factor	Cable Loss	Remark
	MHz	dBuV	dB	dBuV	dBuV	dB	dB	
1	1.47	26.54	-19.46	46.00	15.80	0.57	10.17	Average
2	1.47	38.44	-17.56	56.00	27.70	0.57	10.17	QP
3	1.64	27.14	-18.86	46.00	16.39	0.57	10.18	Average
4	1.64	39.54	-16.46	56.00	28.79	0.57	10.18	QP
5	1.75	26.85	-19.15	46.00	16.10	0.57	10.18	Average
6	1.75	38.85	-17.15	56.00	28.10	0.57	10.18	QP
7 *	4.18	33.36	-12.64	46.00	22.50	0.63	10.23	Average
8	4.18	41.46	-14.54	56.00	30.60	0.63	10.23	QP
9	4.45	32.47	-13.53	46.00	21.60	0.64	10.23	Average
10	4.45	40.07	-15.93	56.00	29.20	0.64	10.23	QP
11	4.90	30.29	-15.71	46.00	19.40	0.65	10.24	Average
12	4.90	38.39	-17.61	56.00	27.50	0.65	10.24	QP



3.7 Antenna Requirements

3.7.1 Standard Applicable

If directional gain of transmitting antennas is greater than 6dBi, the power shall be reduced by the same level in dB comparing to gain minus 6dBi. The use of a permanently attached antenna or of an antenna that uses a unique coupling to the intentional radiator shall be considered sufficient to comply with the FCC rule.

3.7.2 Antenna Anti-Replacement Construction

An embedded-in antenna design is used.

3.7.3 Antenna Gain

The antenna peak gain of EUT is less than 6 dBi. Therefore, it is not necessary to reduce maximum peak output power limit.



4 List of Measuring Equipment

Instrument	Manufacturer	Model No.	Serial No.	Characteristics	Calibration Date	Test Date	Due Date	Remark
Spectrum Analyzer	R&S	FSV40	101078	9kHz~40GHz	May 05, 2015	Dec. 02, 2015	May 04, 2016	Conducted (TH01-SZ)
Pulse Power Sensor	Anritsu	MA2411B	1207253	30MHz~40GHz	Jan. 28, 2015	Dec. 02, 2015	Jan. 27, 2016	Conducted (TH01-SZ)
Power Meter	Anritsu	ML2495A	1218010	50MHz Bandwidth	Jan. 28, 2015	Dec. 02, 2015	Jan. 27, 2016	Conducted (TH01-SZ)
EMI Test Receiver	R&S	ESR7	101404	9kHz~7GHz;Max x 30dBm	Oct. 20, 2015	Dec. 16, 2015	Oct. 19, 2016	Radiation (03CH02-SZ)
Spectrum Analyzer	R&S	FSV40	101041	10kHz~40GHz; Max 30dBm	Oct. 20, 2015	Dec. 16, 2015	Oct. 19, 2016	Radiation (03CH02-SZ)
Loop Antenna	R&S	HFH2-Z2	100354	9kHz~30MHz	May 06, 2015	Dec. 16, 2015	May 05, 2016	Radiation (03CH02-SZ)
Bilog Antenna	TeseQ	CBL6112D	35407	30MHz-2GHz	May 06, 2015	Dec. 16, 2015	May 05, 2016	Radiation (03CH02-SZ)
Double Ridge Horn Antenna	SCHWARZBECK	BBHA 9120D	9120D-1285	1GHz~18GHz	Jan. 20, 2015	Dec. 16, 2015	Jan. 19, 2016	Radiation (03CH02-SZ)
SHF-EHF Horn	com-power	AH-840	101071	18Ghz-40GHz	Aug. 17, 2015	Dec. 16, 2015	Aug. 16, 2016	Radiation (03CH02-SZ)
Amplifier	ADVANTEST	BB525C	E9007003	9kHz ~3000MHz / 30 dB	Jan. 28, 2015	Dec. 16, 2015	Jan. 27, 2016	Radiation (03CH02-SZ)
Amplifier	Agilent	8449B	3008A01023	1GHz~26.5GHz	Oct. 20, 2015	Dec. 16, 2015	Oct. 19, 2016	Radiation (03CH02-SZ)
AC Power Source	Chroma	61601	616010002470	N/A	NCR	Dec. 16, 2015	NCR	Radiation (03CH02-SZ)
Turn Table	Chaintek	T-200	N/A	0~360 degree	NCR	Dec. 16, 2015	NCR	Radiation (03CH02-SZ)
Antenna Mast	Chaintek	MBS-400	N/A	1 m~4 m	NCR	Dec. 16, 2015	NCR	Radiation (03CH02-SZ)
EMI Receiver	R&S	ESC17	100724	9kHz~3GHz;	Jan. 28, 2015	Nov. 27, 2015	Jan. 27, 2016	Conduction (CO01-SZ)
AC LISN	EMCO	3816/2SH	103892	9kHz~30MHz	Feb. 02, 2015	Nov. 27, 2015	Feb. 01, 2016	Conduction (CO01-SZ)
AC LISN (for auxiliary equipment)	MessTec	AN3016	16850	9kHz~30MHz	Feb. 02, 2015	Nov. 27, 2015	Feb. 01, 2016	Conduction (CO01-SZ)
AC Power Source	Chroma	61602	616020000891	100Vac~250Vac	Aug. 07, 2015	Nov. 27, 2015	Aug. 06, 2016	Conduction (CO01-SZ)
Pulse Limiter	COM-POWER	LIT-153 Transient Limiter	53139	150kHz~30MHz	Oct. 20, 2015	Nov. 27, 2015	Oct. 19, 2016	Conduction (CO01-SZ)



5 Uncertainty of Evaluation

Uncertainty of Conducted Emission Measurement (150 kHz ~ 30 MHz)

Measuring Uncertainty for a Level of Confidence of 95% ($U = 2Uc(y)$)	2.3 dB
---	--------

Uncertainty of Radiated Emission Measurement (30 MHz ~ 1000 MHz)

Measuring Uncertainty for a Level of Confidence of 95% ($U = 2Uc(y)$)	5.0 dB
---	--------



Appendix A. Radiated Test Results

15C 2.4GHz 2400~2483.5MHz

BLE (Band Edge @ 3m)

BLE	Note	Frequency	Level	Over	Limit	Read	Antenna	Cable	Preamp	Ant	Table	Peak	Pol.
		(MHz)	(dBμV/m)	(dB)	Limit	Level	Factor	Loss	Factor	Pos	Pos	Avg.	
					Line	(dBμV)	(dB/m)	(dB)	(dB)	(cm)	(deg)	(P/A)	(H/V)
BLE CH 00 2402MHz		2351.4	45.08	-28.92	74	41.07	27.07	9.2	32.26	150	300	P	H
		2373.9	32.12	-21.88	54	27.85	27.19	9.32	32.24	150	300	A	H
	*	2402	87.57	-	-	83.22	27.25	9.32	32.22	150	300	P	H
	*	2402	86.85	-	-	82.5	27.25	9.32	32.22	150	300	A	H
		2383.08	45.25	-28.75	74	40.98	27.19	9.32	32.24	179	283	P	V
		2357.88	32.37	-21.63	54	28.3	27.13	9.2	32.26	179	283	A	V
	*	2402	94.2	-	-	89.85	27.25	9.32	32.22	179	283	P	V
	*	2402	93.46	-	-	89.11	27.25	9.32	32.22	179	283	A	V
BLE CH 19 2440MHz		2379.21	44.06	-29.94	74	39.79	27.19	9.32	32.24	150	235	P	H
		2384.34	32.05	-21.95	54	27.78	27.19	9.32	32.24	150	235	A	H
	*	2440	89.59	-	-	84.93	27.42	9.43	32.19	150	235	P	H
	*	2440	88.95	-	-	84.29	27.42	9.43	32.19	150	235	A	H
		2487.08	45.63	-28.37	74	40.71	27.54	9.55	32.17	150	235	P	H
		2488.28	33.21	-20.79	54	28.12	27.6	9.66	32.17	150	235	A	H
		2372.46	45.06	-28.94	74	40.79	27.19	9.32	32.24	179	283	P	V
		2370.66	32.46	-21.54	54	28.19	27.19	9.32	32.24	179	283	A	V
	*	2440	94.02	-	-	89.36	27.42	9.43	32.19	179	283	P	V
	*	2440	93.24	-	-	88.58	27.42	9.43	32.19	179	283	A	V
		2485.32	46.12	-27.88	74	41.2	27.54	9.55	32.17	179	283	P	V
	2492.12	33.48	-20.52	54	28.37	27.6	9.66	32.15	179	283	A	V	



BLE CH 39 2480MHz	*	2480	91.15	-	-	86.23	27.54	9.55	32.17	150	235	P	H
	*	2480	90.46	-	-	85.54	27.54	9.55	32.17	150	235	A	H
		2495.24	46.38	-27.62	74	41.27	27.6	9.66	32.15	150	235	P	H
		2485.16	33.15	-20.85	54	28.23	27.54	9.55	32.17	150	235	A	H
	*	2480	92.86	-	-	87.94	27.54	9.55	32.17	179	283	P	V
	*	2480	92.13	-	-	87.21	27.54	9.55	32.17	179	283	A	V
		2488.08	45.56	-28.44	74	40.58	27.6	9.55	32.17	179	283	P	V
		2492.2	33.34	-20.66	54	28.23	27.6	9.66	32.15	179	283	A	V
Remark	1. No other spurious found. 2. All results are PASS against Peak and Average limit line.												



15C 2.4GHz 2400~2483.5MHz

BLE (Harmonic @ 3m)

BLE	Note	Frequency	Level	Over	Limit	Read	Antenna	Cable	Preamp	Ant	Table	Peak	Pol.
		(MHz)	(dBμV/m)	Limit	Line	Level	Factor	Loss	Factor	Pos	Pos	Avg.	
				(dB)	(dBμV/m)	(dBμV)	(dB/m)	(dB)	(dB)	(cm)	(deg)	(P/A)	(H/V)
BLE CH 00 2402MHz		4804	40.07	-33.93	74	52.22	31.22	13.27	56.64	150	360	P	H
		4804	40.44	-33.56	74	52.59	31.22	13.27	56.64	150	360	P	V
BLE CH 19 2440MHz		4880	40.63	-33.37	74	52.7	31.36	13.48	56.91	150	360	P	H
		7320	47.54	-26.46	74	52.83	35.98	16.59	57.86	150	360	P	H
		4880	40.41	-33.59	74	52.48	31.36	13.48	56.91	150	360	P	V
		7320	47.47	-26.53	74	52.76	35.98	16.59	57.86	150	360	P	V
BLE CH 39 2480MHz		4960	42.24	-31.76	74	53.27	31.53	13.69	56.25	150	360	P	H
		7440	46.4	-27.6	74	51.32	36.16	16.7	57.78	150	360	P	H
		4960	40.89	-33.11	74	51.92	31.53	13.69	56.25	150	360	P	V
		7440	46.77	-27.23	74	51.69	36.16	16.7	57.78	150	360	P	V
Remark	<ol style="list-style-type: none"> No other spurious found. All results are PASS against Peak and Average limit line. 												



15C Emission below 1GHz

2.4GHz BLE (LF)

BLE	Note	Frequency	Level	Over	Limit	Read	Antenna	Cable	Preamp	Ant	Table	Peak	Pol.
		(MHz)	(dBμV/m)	(dB)	(dBμV/m)	(dBμV)	(dB/m)	(dB)	(dB)	(cm)	(deg)	(P/A)	(H/V)
2.4GHz BLE LF		37.76	14.04	-25.96	40	29.44	13.96	1.22	30.58	-	-	P	H
		88.2	30.52	-12.98	43.5	48.71	10.66	1.68	30.53	100	278	P	H
		105.66	29.02	-14.48	43.5	45.14	12.38	2.01	30.51	-	-	P	H
		178.41	27.76	-15.74	43.5	44.27	11.35	2.58	30.44	-	-	P	H
		375.32	21.79	-24.21	46	32.78	15.5	3.67	30.16	-	-	P	H
		947.62	30.14	-15.86	46	31.29	22.18	5.82	29.15	-	-	P	H
		37.76	26.38	-13.62	40	41.78	13.96	1.22	30.58	-	-	P	V
		61.04	30.68	-9.32	40	53.2	6.35	1.68	30.55	120	260	P	V
		96.93	24.24	-19.26	43.5	40.88	11.87	2.01	30.52	-	-	P	V
		306.45	20.14	-25.86	46	33.21	13.92	3.28	30.27	-	-	P	V
		598.42	23.26	-22.74	46	29.31	19.17	4.55	29.77	-	-	P	V
	951.5	27.5	-18.5	46	28.62	22.21	5.82	29.15	-	-	P	V	
Remark	1. No other spurious found. 2. All results are PASS against limit line.												



Note symbol

*	Fundamental Frequency which can be ignored. However, the level of any unwanted emissions shall not exceed the level of the fundamental frequency per 15.209(c).
!	Test result is over limit line.
P/A	Peak or Average
H/V	Horizontal or Vertical



A calculation example for radiated spurious emission is shown as below:

WIFI	Note	Frequency	Level	Over	Limit	Read	Antenna	Cable	Preamp	Ant	Table	Peak	Pol.
Ant.				Limit	Line	Level	Factor	Loss	Factor	Pos	Pos	Avg.	
1+2		(MHz)	(dBμV/m)	(dB)	(dBμV/m)	(dBμV)	(dB/m)	(dB)	(dB)	(cm)	(deg)	(P/A)	(H/V)
802.11b		2390	55.45	-18.55	74	54.51	32.22	4.58	35.86	103	308	P	H
CH 01													
2412MHz		2390	43.54	-10.46	54	42.6	32.22	4.58	35.86	103	308	A	H

- Level(dBμV/m) =
Antenna Factor(dB/m) + Cable Loss(dB) + Read Level(dBμV) - Preamp Factor(dB)
- Over Limit(dB) = Level(dBμV/m) – Limit Line(dBμV/m)

For Peak Limit @ 2390MHz:

- Level(dBμV/m)
= Antenna Factor(dB/m) + Cable Loss(dB) + Read Level(dBμV) - Preamp Factor(dB)
= 32.22(dB/m) + 4.58(dB) + 54.51(dBμV) – 35.86 (dB)
= 55.45 (dBμV/m)
- Over Limit(dB)
= Level(dBμV/m) – Limit Line(dBμV/m)
= 55.45(dBμV/m) – 74(dBμV/m)
= -18.55(dB)

For Average Limit @ 2390MHz:

- Level(dBμV/m)
= Antenna Factor(dB/m) + Cable Loss(dB) + Read Level(dBμV) - Preamp Factor(dB)
= 32.22(dB/m) + 4.58(dB) + 42.6(dBμV) – 35.86 (dB)
= 43.54 (dBμV/m)
- Over Limit(dB)
= Level(dBμV/m) – Limit Line(dBμV/m)
= 43.54(dBμV/m) – 54(dBμV/m)
= -10.46(dB)

Both peak and average measured complies with the limit line, so test result is “PASS”.