

**Enjoy peace of mind.
Register your appliance today.**

Stay updated on better living services,
safety notices and shop for accessories.

- 1. Open the camera app on your smartphone and point at the QR code to scan**

Product Registration QR code is located on the front of the door or internal side wall of your fridge.

- 2. Tap the notification or link to open the registration form**

- 3. Complete your details and enjoy peace of mind**

WQE5600, WQE5650, WQE5660

REFRIGERATOR

CONTENTS

1. SAFETY INFORMATION	3
2. DESCRIPTION OF THE APPLIANCE	5
3. INSTALLING YOUR NEW APPLIANCE	8
4. TEMPERATURE CONTROL	11
5. STORAGE FEATURES.....	16
6. CONNECTING THE WATER SUPPLY.....	19
7. AUTOMATIC ICE & WATER DISPENSER.....	21
8. GENERAL INFORMATION.....	23
9. FOOD STORAGE GUIDE.....	25
10. TROUBLESHOOTING	26
11. NOISES	30

WE'RE THINKING OF YOU

Thank you for choosing Westinghouse. We have designed this product to make your life simpler and deliver impeccable performance for many years. Please spend a few minutes reading this document to get the best from your new Westinghouse appliance.

Visit our website to:



Get usage advice or service information:
www.westinghouse.com



Register your product for better service:
www.westinghouse.com/support/register-warranty



Buy Accessories, Consumables and Original spare parts for your appliance:
<https://shop.westinghouse.com.au/>

CUSTOMER CARE AND SERVICE

Always use original spare parts.

When contacting our Authorised Service Centre, ensure that you have the following data available: Model, PNC, Serial Number.

The information can be found on the rating plate.

Customer care contact : Call 13 13 49

 Warning / Caution-Safety information.

 General information and tips.

 Environmental information.

Subject to change without notice.

1. SAFETY INFORMATION

Note: You must read these warnings carefully before installing or using the refrigerator. If you need assistance, contact your customer care centre. The manufacturer will not accept liability, should these instructions or any other safety instructions incorporated in this book be ignored.



WARNING

- It is essential the electric outlet is properly earthed to ground. Consult a qualified electrician if you are unsure.
- Do not use electrical appliances inside the food storage compartments of the appliance, unless they are of the type recommended by the manufacturer.
- Unplug the refrigerator before cleaning or moving it to avoid electric shock.
- Never unplug the refrigerator by pulling the electrical cord as this may damage it. Grip the plug firmly and pull straight out.
- If the power cord is damaged, it must be replaced by the manufacturer, its service agent or similarly qualified persons in order to avoid a hazard.
- Don't use a steam cleaner. If live components come into contact with condensing steam, they may short-circuit or cause an electric shock.
- Do not store explosive substances such as aerosol cans with a flammable propellant this appliance. If pressurised aerosol containers bear the word 'flammable' and/or a small flame symbol, do not store them inside any refrigerator or freezer. If you do so you may cause an explosion.
- Do not damage the refrigerant circuit.
- This appliance contains insulation formed with flammable blowing gases. Avoid safety hazards by carefully disposing of this appliance.
- If you wish to discard this refrigerator, please contact your local authorities and ask for the correct method of disposal.
- When you dispose of your old refrigerators and freezers, remove any doors. Children can suffocate if they get trapped inside.
- When positioning the appliance, ensure the supply cord is not trapped or damaged.
- Do not locate multiple portable socket-outlets or portable power supplies at the rear of the appliance.



WARNING

R600a refrigerant warning



This appliance contains flammable R600a refrigerant. Avoid safety hazards by carefully installing, handling, servicing and disposing of this appliance.

- Ensure that the tubing of the refrigerant circuit is not damaged during transportation and installation.
- Leaking refrigerant may cause eye injuries or ignite.
- The room for installing appliance must be at least 1m³ per 8g of refrigerant. The amount of refrigerant in the appliance can be found on the rating plate inside the appliance.
- If you are unsure of the refrigerant check the rating plate inside the refrigerator compartment.
- It is hazardous for anyone other than an Authorised Service Person to service this appliance. In Queensland Australia the Authorisation Service Person MUST hold a Gas Work Authorisation for hydrocarbon refrigerants to carry out servicing or repairs which involve the removal of covers.
- Keep ventilation openings in the appliance enclosure or in the built-in structure, clear of obstruction.
- Do not use mechanical devices or other means to accelerate the defrosting process, other than those recommended by the manufacturer.
- The maximum inlet water pressure 689 kPa (100 psi), the minimum inlet water pressure 206 kPa (30 psi), if this is necessary for the correct operation of the appliance.

GENERAL WARNINGS

Read the following carefully to avoid damage or injury. It is important to use your refrigerator safely. Check these safety points before using your refrigerator.

- The appliance must be plugged into its own dedicated electrical outlet.
- The plug must be accessible when the refrigerator is in position.
- It is essential the powerpoint is properly earthed to ground. Consult a qualified electrician if you are unsure.
- Don't use extension cords or adapter plugs with this refrigerator.
- If the supply cord is damaged, it must be replaced by the manufacturer, its service agent or similarly qualified persons in order to avoid a hazard.
- Unplug the appliance before cleaning and before changing the light bulb(when fitted) to avoid electric shock.
- Never unplug the refrigerator by pulling the electrical cord as this may damage it. Grip the plug firmly and pull straight out.
- Choose a location for your refrigerator that isn't too cold. The ambient room temperature should be above 10°C.
- Stand your refrigerator in a dry place avoid areas of high moisture or humidity.
- Don't put the refrigerator in frosty or unprotected areas like a garage or on the verandah.
- Don't plug your refrigerator into a timer fitted to the powerpoint.
- Do not put the refrigerator in direct sunlight, near stoves, fires or heaters.
- Do not put the refrigerator on an uneven surface.
- Do not store flammable materials on or under the appliance, e.g. aerosols.
- Do not store explosive substances such as aerosol cans with a flammable propellant in this appliance.
- Never store fizzy drinks in the freezer compartment.
- Never try to repair the refrigerator yourself, only use a qualified or authorised service person for repairs.
- Never use electric heaters or dryers to defrost the freezer because you can receive an electric shock.
- When transporting and installing the refrigerator, care should be taken to ensure that no parts of the refrigerating circuit are damaged.
- When installed correctly, your refrigerator should:
 - Have adequate space at the back and sides for air circulation.
 - Be vertically aligned to the surrounding cupboards.
 - Have doors that will self-close from a partially open position.
- The appliance is not to be used by persons (including children) with reduced physical, sensory or mental capabilities, or lack of experience and knowledge, unless they have been given supervision or instruction concerning use of the appliance by a person responsible for their safety.
- Children being supervised not to play with the appliance.

NOTE: You must read these warnings carefully before installing or using the refrigerator. If you need assistance, contact your Customer Care Department. The manufacturer will not accept liability, should these instructions or any other safety instructions incorporated in this book be ignored.



ENVIRONMENTAL INFORMATION

This appliance is intended to be used in household and similar applications such as,

- The kitchen areas in shops, offices and other working environments;
- Farm house and by clients in hotels, motels and other residential type environments;
- Bed and breakfast type environments;
- Catering and similar non-retail applications;

2. DESCRIPTION OF THE APPLIANCE

2.1 QUATTRO FRENCH DOOR REFRIGERATOR FEATURES

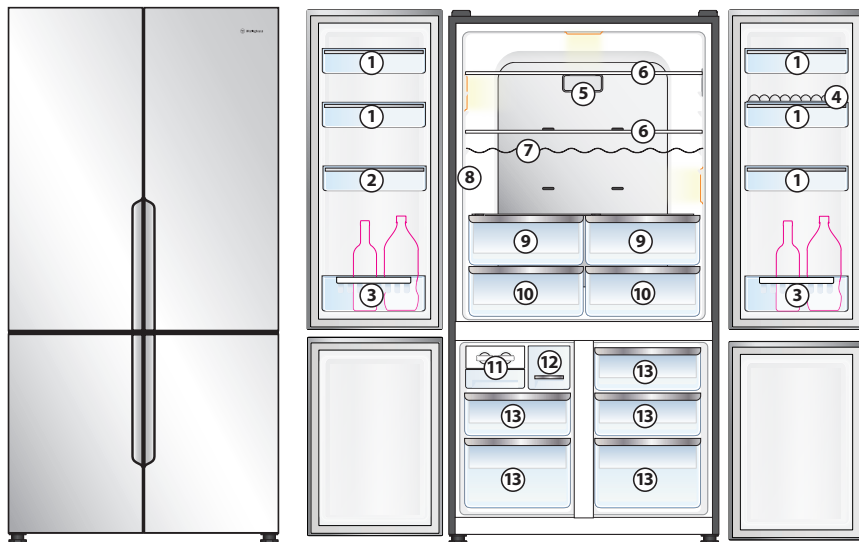

WQE5600 Illustrated

- | | | | |
|----------|--------------------------|-----------|---|
| 1 | Door Bins* | 8 | UI Control Panel (on the left side wall) |
| 2 | Door Bin Small* | 9 | Fresh Seal Manual Humidity Control Drawer |
| 3 | Bottle Storage Bins | 10 | Fresh Drawer |
| 4 | Egg Tray | 11 | Twist & Serve Ice Bin |
| 5 | Air Filter | 12 | Ice Storage Bin |
| 6 | Spillsafe™ Glass shelves | 13 | Freezer Drawer |
| 7 | Wine Rack | | |

NOTE:

* Door bin (2) is the slightly smaller than Door bin (1), Position must be installed as per above picture.

2.2 QUATTRO FRENCH DOOR WITH ICE & WATER REFRIGERATOR FEATURES

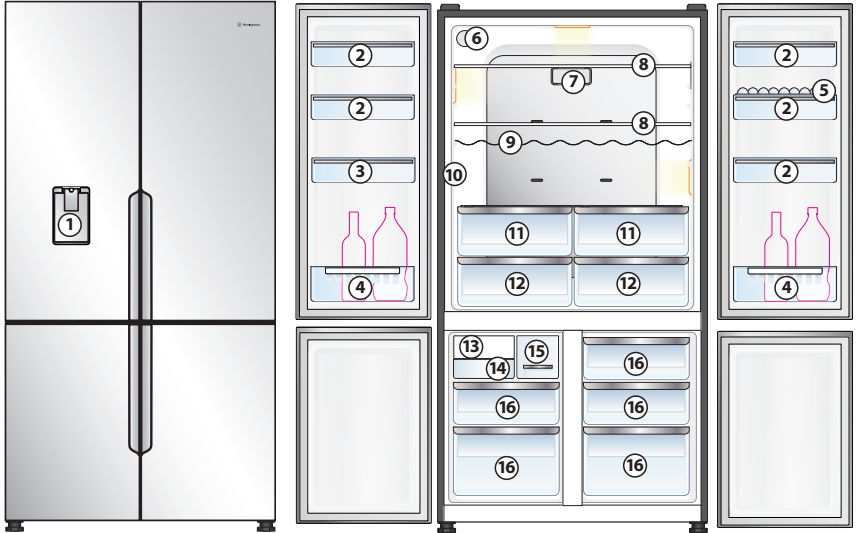

WQE5650 Illustrated

- | | |
|---|--|
| <ul style="list-style-type: none"> 1 Water Dispenser 2 Door Bins* 3 Door Bin Small* 4 Bottle Storage Bins 5 Egg Tray 6 Water Filter 7 Air Filter 8 Spillsafe™ Glass shelves | <ul style="list-style-type: none"> 9 Wine Rack 10 UI Control Panel (on the left side wall) 11 Fresh Seal Manual Humidity Control Drawer 12 Fresh Drawer 13 Automatic Ice Maker 14 Ice Storage Small 15 Ice Storage Bin 16 Freezer Drawer |
|---|--|

NOTE:

* Door bin (3) is the slightly smaller than Door bin (2). Position must be installed as per above picture.

2.3 QUATTRO FRENCH DOOR WITH TANK ICE & WATER REFRIGERATOR FEATURES

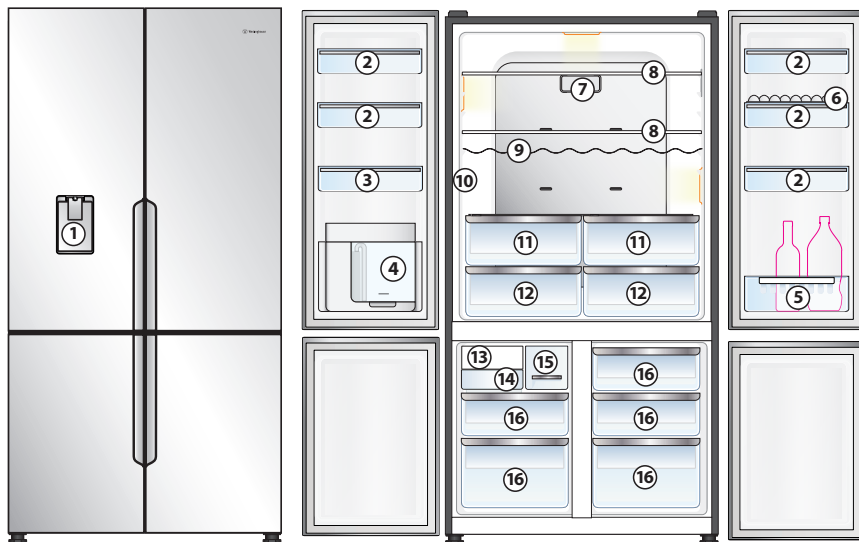

WQE5660 illustrated

- | | | | |
|----------|--------------------------|-----------|---|
| 1 | Water Dispenser | 9 | Wine Rack |
| 2 | Door Bins* | 10 | UI Control Panel (on the left side wall) |
| 3 | Door Bin Small* | 11 | Fresh Seal Manual Humidity Control Drawer |
| 4 | Water Tank | 12 | Fresh Drawer |
| 5 | Bottle Storage Bins | 13 | Automatic Ice Maker |
| 6 | Egg Tray | 14 | Ice Storage Small |
| 7 | Air Filter | 15 | Ice Storage Bin |
| 8 | Spillsafe™ Glass shelves | 16 | Freezer Drawer |

NOTE:

* Door bin (3) is the slightly smaller than Door bin (2), Position must be installed as per above picture.

3. INSTALLING YOUR NEW APPLIANCE

Unpacking



ENVIRONMENT

Most of the packing materials are recyclable. Please dispose of those materials through your local recycling depot or by placing them in appropriate collection containers.

Important – check for any damages or marks. If you find the refrigerator is damaged or marked, you must report it within 7 days should you wish to claim for damage/ marks under the manufacturers warranty. This does not affect your statutory rights.

Clean your refrigerator thoroughly following the instructions in the “Cleaning” section and wipe off any dust that has accumulated during shipping.

Locating the refrigerator



CAUTION

Automatic aerosol systems (such as insect control) should not be located adjacent to the product as the spray may cause long term damage to the external plastics of the appliance.

Do not put the refrigerator in a location that is too cold or is unprotected, for example in a garage or on a veranda. The ambient temperature should be above 10°C.

Put the refrigerator in a dry place avoiding areas of high moisture or humidity.

Ensure the refrigerator is located on an even surface.

Installing your refrigerator

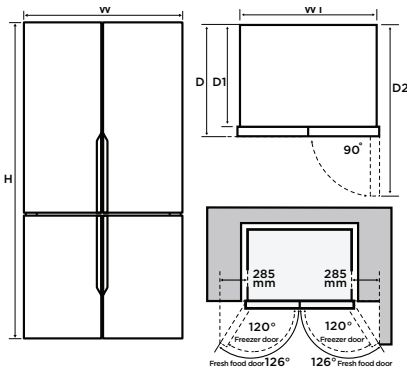

Product Dimensions

Total width (W)	mm	896
Total depth (D)	mm	726
Maximum height (H)	mm	1795
Cabinet width (W1)	mm	890
Cabinet depth (D1)	mm	640
Depth door open 90° (D2)	mm	1104

When positioned in a corner area, spacing of at least 285mm on the hinge side will allow the doors to open enough to enable the removal of bins and shelves.

Installation options for optimal aesthetics :

Minimum side clearance kitchen cabinet

Fridge body must sit 10mm proud of kitchen cabinetry.

Minimum cabinetry opening (WxDxH) : 900mm x 649mm x 1800mm

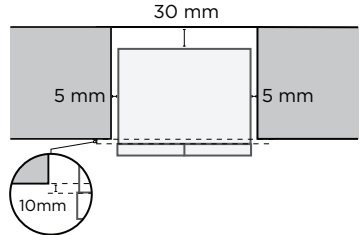

Front of fridge body in line with kitchen cabinet

Side clearance must be 25mm either side of fridge body, to have the fridge doors sitting proud of the kitchen cabinetry.

Minimum cabinetry opening (WxDxH) : 940mm x 659mm x 1800mm

Note : Spacers supplied to assist

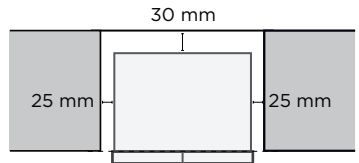

Fridge door flush with the cabinetry

Side clearance must be 30mm either side of the fridge body, to have the fridge doors sitting flush with the kitchen cabinetry.

Minimum cabinetry opening (WxDxH) :

1070mm x 741mm x 1800m

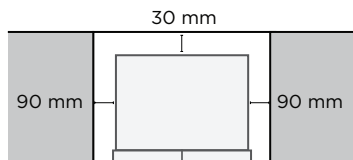

Note : Top gap all 5 mm.

- Roll the refrigerator into place.
The rollers are designed for forward or backward movement only. They are not castors. Moving the refrigerator sideways may damage your floor and the rollers. Before moving your refrigerator ensure height adjusting nut and the stability foot are fully wound up off the floor.
- Wind the large height adjusting nut under door hinge down until the refrigerator is tilted back by 10mm (see diagram).

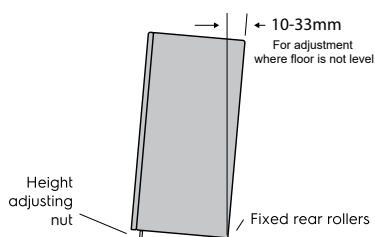

- Wind the large height adjusting nut on the handle side down until the refrigerator is level and stable. If you have difficulty winding the nut or height adjusting foot down, have someone tilt the refrigerator back so you have better access.

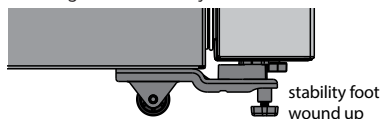

- Check the alignment of the refrigerator to the surrounding cupboards to see if it is level. You can adjust the level as detailed in step 2 and 3.

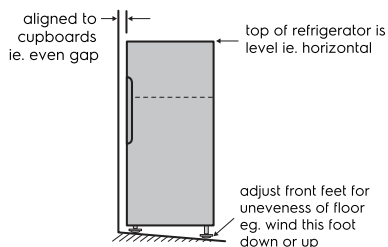

- If you find your refrigerator rocks from corner to corner, it means your floor is uneven. Find a piece of plastic or hardboard etc. and pack it firmly under the roller.
- You may now need to fine-tune the installation by repeating steps 3, 4 and 5.
- When you have the appliance in its final position, it needs to be stabilised. Wind the stability foot under the door hinge down to the floor until it just makes contact with the floor. Lift the front of the appliance to take the weight off the stability foot, then turn it half a turn further to ensure firm contact with the floor. Wind the large height adjusting nut back up to ensure all the weight is now on the front stability foot. Wind the large height adjusting nut back up to ensure all the weight is now on the front stability foot.

Front view

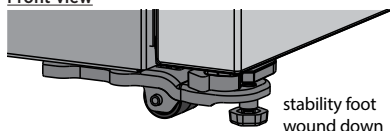

- Repeat step 7 for the stability foot on the handle side. Whenever you need to move the appliance, be sure to wind the feet back up so that the appliance can roll freely and be sure to reset it when reinstalling.
- Plug your refrigerator straight into its own power point and never use a double adapter. If you need to roll the refrigerator to get to the plug, remember to raise the stability foot first.
- Before you put any food in your refrigerator, it's recommended you leave it on for 2 or 3 hours to check it is running properly.

Door opening

Your refrigerator should be positioned to allow easy access to a counter when removing food. For best use of refrigerator drawers and freezer baskets, the refrigerator should be in a position where both door can be fully opened.



WARNING

LED lighting

Your appliance is fitted with long life LED lighting. In the unlikely event the LED lights should fail, then the LED lights should be serviced by the service agent, to avoid a safety hazard. Refer to the warranty page for contact details.

Cabinet Leveling & Refrigerator Door

Alignment (if necessary)

All four corners of the cabinet must rest firmly on the floor

- The front should be slightly elevated to ensure that doors close and seal properly.
- Doors should align with each other and be level.

Most of these conditions can be met by raising or lowering the adjustable front rollers.

To level the cabinet using the front rollers:

1. Lower anti-tip legs until they are both touching the floor. Use a pair of pliers to adjust.

To raise: turn leg clockwise.

To lower: turn leg counterclockwise.

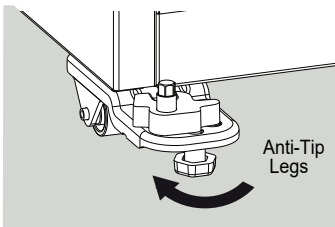

2. Ensure both doors are bind-free with their seals touching the cabinet on all four sides and that cabinet is stable.

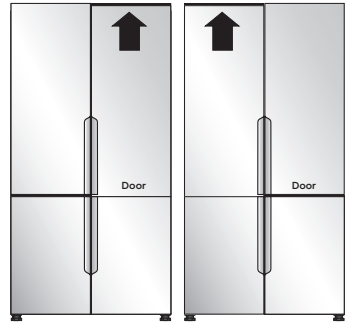

Flipper Mullion

Adjust Flipper Mullion for proper connection with the mullion guide by ensuring the flipper mullion is folded and perpendicular to the fresh food door. If the mullion guide is not in the correct position, it could prevent the door from closing completely.

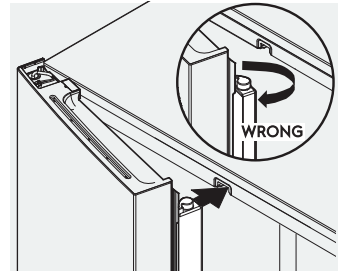

4. TEMPERATURE CONTROL

The following pages explain the various functions of the user interface to help you better understand how to get the most out of your new refrigerator.



IMPORTANT

NOTE: When you set a temperature, you set an average temperature for the whole refrigerator cabinet. Ensuring that you make only small adjustments and wait at least 24 hours to see if the new temperature is correct to your liking.







Checking the softness of ice cream is a good indication that your freezer is the right temperature, while checking the temperature of water kept in the refrigerator is a good way of checking the temperature of the food compartment.

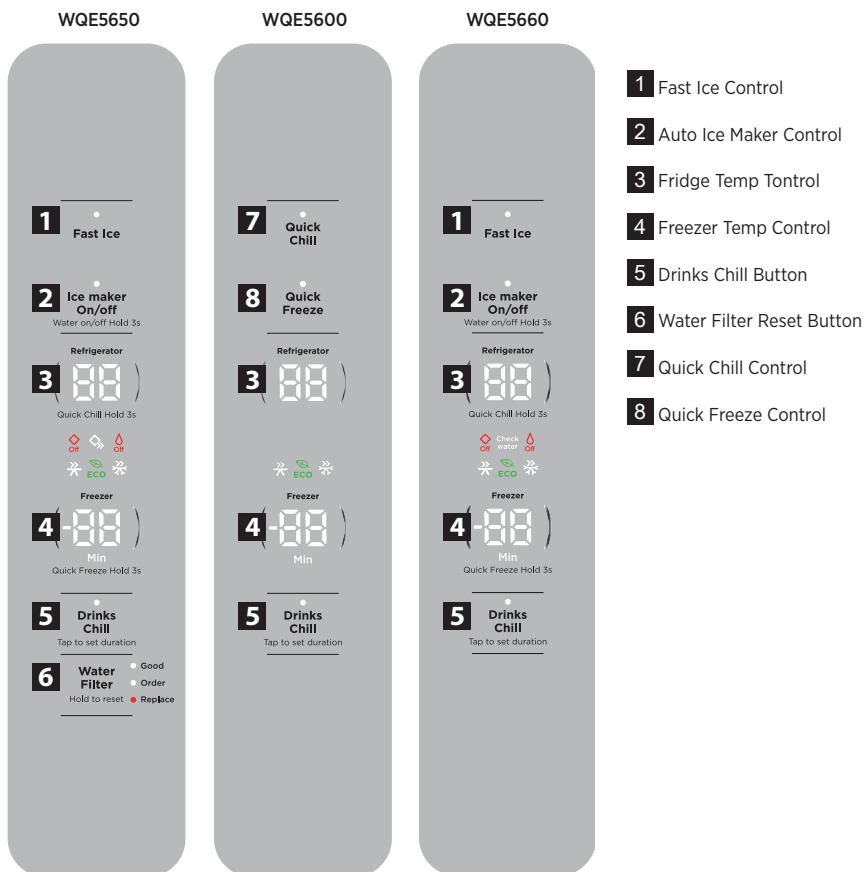

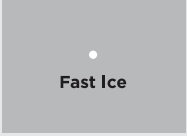



Temperatures inside each compartment may vary, depending on how much food you store and where you place it.





High or low room temperature may also affect the actual temperature inside the refrigerator.

4.1 Functions of the user interface

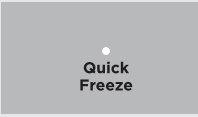

Function	Icon	Operation (depending on model)
<p>1 Fast Ice Botton</p>	 <p>Fast Ice indicator</p> 	<p>Tap on Fast ice button.</p> <p>When Fast ice is ON, the Fast Ice indicator lights up.</p> <p>When Fast ice is OFF, the Fast ice indicator turns off.</p>
<p>2 Auto Ice Maker Control</p>	 <p>Ice Off Alert indicator</p>  <p>Water Off Alert indicator</p> 	<p>Tap on Ice Maker on/off button.</p> <p>When Ice maker is ON, the button LED lights up .</p> <p>When Ice maker is OFF, the button LED turns off. Ice Off alert lights up.</p> <p>Press and hold on Ice Maker On/Off button for 3 secods.</p> <p>When it is ON, water can be dispensed when the water dispensar paddle is pressed.</p> <p>When it is OFF, water cannot be dispensed when the water dispensar paddle is pressed.</p>
<p>3 Fridge Temp Control</p>		<p>Taps on the display to cycle through the temperature range supported by the Fridge.</p> <p>From 7°C</p> <p>To 1°C</p> <p>Default 4°C</p>
<p>4 Freezer Temp Control</p>		<p>Taps on the display to cycle through the temperature range supported by the Freezer</p> <p>From -14°C</p> <p>To -23°C</p> <p>Default -18°C</p>

Function	Icon	Operation (depending on model)
<p>5 DrinksChill</p>	 <p>Drinks Chill timer indicator</p> 	<p>The Drinks Chill timer is used to quickly chill a bottle inside the freezer compartment and to warn the user when it ends.</p> <p>Tap on Drinks Chill button, Freezer display shows 20 , "Min" and Drink Chill LED turns on.</p> <p>The timer option is from 20 minutes and the user can add time in 5 min intervals up to 45 minutes. After it starts the timer will show the countdown minute by minute.</p> <p>NOTE: When timer countdown is in progress, the timer duration cannot be adjusted. User will need to deactivate Drinks Chill and activate Drinks chill again to set a new timer.</p>
<p>6 Water Filter Alert and Reset</p>		<p>"GOOD" LED turns on is mean the filter used for 0-4 months.</p> <p>"ORDER" LED turns on is mean the filter used for 5 months , to remind user to order new water filter.</p> <p>"REPLACE" LED turns on is mean the filter used for 6 months,</p> <p>Press and hold Water filter for 3 seconds to reset. Status will reset to GOOD.</p>
<p>7 Quick Chill Control</p>	<p><u>Standard model</u></p>  <p><u>I&W model</u></p>  <p>Quick chill indicator</p> 	<p><u>For Standard model</u> Tap on Quick chill button.</p> <p><u>For I&W model</u> Press & Hold on Fridge digits for 3 seconds. Tap on Fridge digits to adjust temperature.</p> <p>When Quick chill is ON, the Quick chill indicator lights up.</p> <p>When Quick chill is OFF, the Quick chill indicator turns off.</p> <p>Use the Quick Chill when you add a large amount of food to the refrigerator compartment after grocery shopping or to quickly cooled your drink. When Quick chill is on, the cold air circulate into the refrigerator to temporarily reduce the temperature to 1°C for 6 hours, Freezer compartment continue to run at set temperature.</p> <p>Quick chill auto turn off on either of this condition:</p> <ul style="list-style-type: none"> - 6 hours has elapsed - Fridge temp is adjusted

Function	Icon	Operation (depending on model)
<p>8 Quick Freeze Control</p>	<p><u>Standard model</u></p>  <p><u>I&W model</u></p>  <p>Quick Freeze indicator</p> 	<p><u>For Standard model.</u> Tap on Quick Freeze button.</p> <p><u>For I&W model</u> Press & Hold on Freezer digits for 3 seconds. Tap on Freezer digits to adjust temperature.</p> <p>When Quick freeze is ON, the Quick Freeze indicator lights up.</p> <p>When Quick freeze is OFF, the Quick Freeze indicator turns off.</p> <p>Use the Quick freeze function when you add a large amount of food to the freezer compartment after grocery shopping, to speed up the freezing process. When Quick freeze is on, the compressor will run continuously for 6 hours. Fridge compartment continue to run at set temperature.</p> <p>Quick freeze auto turn off on either of this condition:</p> <ul style="list-style-type: none"> - 6 hours has elapsed - Freezer temp is adjusted <p><i>NOTE: Quick Freeze and Fast Ice cannot be activated at the same time. If Fast ice is ON, Quick Freeze cannot be activated.</i></p>
<p>4 + 5 Sabbath mode</p>		<p>Press and hold Freezer and Drinks chill for 5 seconds and "Sb" shows on Fridge display.</p> <p>When activated, all lights and UI will not work until Sabbath Mode is deactivated.</p> <p>The Sabbath Mode is a feature that disables portions of the refrigerator and its controls in accordance with observance of the weekly Sabbath and religious holidays within the Orthodox Jewish Community.</p> <p><i>NOTE: All alarm functions are deactivated except High temperature alarm is not disabled for health reasons. If high temp alarm active, The alarm will sound intermittently for 10 minutes. The alarm will silence on its own.</i></p> <p>The unit stays in Sabbath Mode after power outage recovery. It must be deactivated by the user.</p>

4.2 Alert and Alarms

Door Alarm

When any of the door is left open for 2 minutes. The alarm will sound, and all LEDs that are currently on.

- The alarm is turned off by closing the door or resetting the countdown by pressing any key on the control panel.

High Temperature alert

In the event of high temperature condition, audio alarm is played every 10 seconds until the alert is acknowledged.

The alarm by pressing any key on the control panel.

Display and blink "HI" in the correspondent compartment display, whichever is in the high temperature condition.

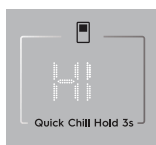

High Temp indicator on Fridge display



High Temp indicator on Freezer display

ECO indicator

Eco mode indicator will light up automatically to 100% when the fridge and freezer compartments are set within a temperature range.

Fridge range: 4°C to 7°C

Freezer range: -18°C to -14°C



Selecting any of these mode: Quick Freeze, Quick Chill, Fast Ice or Drinks Chill will deactivate the Eco mode, the Eco icon will fade.

Water Filter Alert and Reset

Water Filter alert warns user that the Water filter have to be changed as soon as possible. When water filter is used for 6 months or 120 gallons (about 454 litres) of water has been dispensed since the last filter reset, LED "Replace" will automatically illuminate.

Note:

1. Users could reset the filter when alert is not visible. Play tone_Confirm once it is reset.
2. LED "Replace" remains visible during sleep mode, except when door is closed

Check water Alert

When water tank is empty, the Ice maker senses the lack of warm water feeding in, and will turn off the ice maker.

This trigger will also displays the "Check water alert". The intention is the alert user that Ice maker has been turn off due to the lack of water.

The alert can be dismissed by turning on Ice maker. If no water is detected again, ice maker will be turn off again, and the check water alert turns on.

Error codes

Both Fridge & Freezer displays are used to communicate problems by code.

When error codes are displayed in the numeric display, the unit requires service attention.

"Er" shows up on Fridge display



Various error codes on Freezer display



Error code table	
Communication error	CE
FZ Cavity NTC	T1
FZ Evaporator NTC	T2
FF Cavity NTC	T3
Third cavity NTC	T5
FZ Ice maker NTC	T8

5. STORAGE FEATURES

SpillSafe™ glass shelves

To remove the shelves, gently pull them forward until the shelf comes clear of the shelf guides.

To return the shelf, make sure there is nothing behind that may obstruct movement. Gently push the shelf, into the cabinet and back into position.

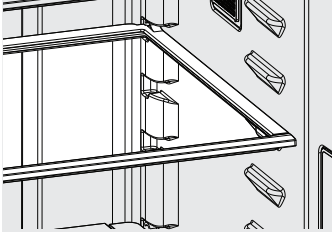

Removing glass shelves



CAUTION

To avoid personal injury or property damage, handle tempered glass shelves carefully. Shelves may break suddenly if nicked, scratched, or exposed to sudden temperature change. Allow the glass shelves to stabilize to room temperature before cleaning. Do not wash in dishwasher.

Drawer

Your refrigerator includes a variety of storage drawers.

Crisper (with humidity control)

Crisper drawers are designed for storing fruits, vegetables, and other fresh produce. Crispers have humidity control (Change the humidity by sliding the humidity control, less humidity conditions are recommended for fruit, while more humidity conditions recommended for vegetables)

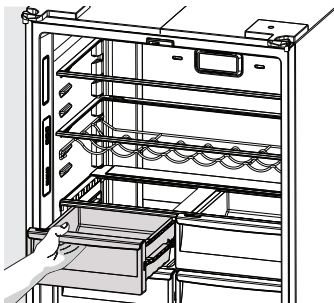

Opening the Crisper Drawer

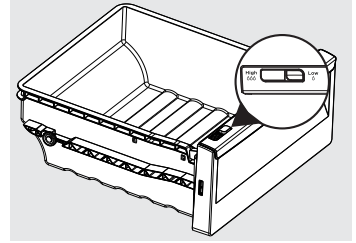

Adjust the humidity control

To remove the crisper for cleaning:

1. Pull the drawer out until it stops.
2. Lift the front slightly and remove the drawer.

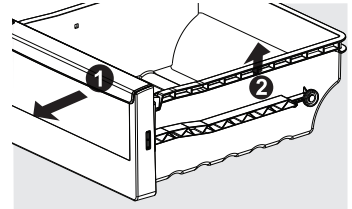

Removing Crisper

Doors

Storage bins

The doors to your fresh food compartment use a system of modular storage bins. All of these bins are removable for easy cleaning. Bins can be adjusted to your needs.

Door bins are ideal for storing jars, bottles, cans, and large drink containers. They also enable quick selection of frequently used items.

To remove the door bin:

1. lift and unlock from lugs to remove.
2. Replace by lift up and push bin down until the support lugs lock it in place.

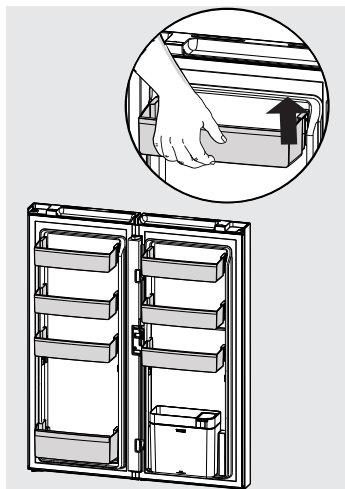

Removing door bin

Water Tank**CAUTION**

BEFORE REMOVE; to empty the water in the tank.

To remove the water tank and disassembly cleanable parts follow these steps:

1. Lift up water tank until locking release.
2. Pull water tank forward.

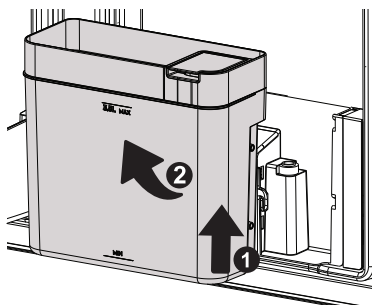

Removing the water tank

3. Remove water tank lid (1), water tank tube (2) and filter (3).



Disassembly water tank

Reverse the step to assembly the water tank and return to its place. Reverse the step to assembly the water tank and return to its place.

NOTE: The water tank for WQE5660 model only

Freezer storage

To remove freezer drawers:

All freezer drawers are removable.

1. Open doors completely to gain access to drawers.
2. Pull the drawer to the stopper. Lift up and pull to remove it from the cabinet.
3. Reverse the steps to reinstall drawer.

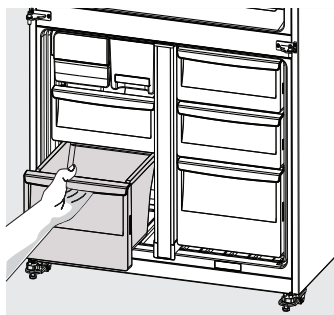

Removing Freezer Drawer

Twist & Serve Ice Bin:

1. Prior the first use clean the ice tray.
2. Fill the water up to max level of the ice tray.

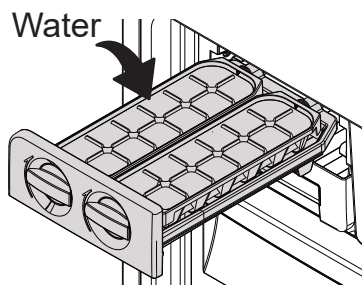

3. Put the ice tray in place.
4. Rotate ice twist clockwise to release the ice from ice tray.

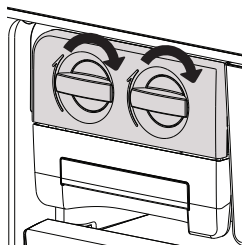

6. CONNECTING THE WATER SUPPLY



WARNING

Connect to potable water supply only. If using tank or bore water it is recommended to also use an external filter (not supplied).

The new hose-sets supplied with the appliances must be used and old hose-sets should not be reused.

Never connect the appliance to a hot water supply.

Do not use with water that is microbiologically unsafe or with water of unknown quality without adequate disinfection.

Water Filter

It should not be used on water that is micro biologically unsafe or with water of unknown quality. The service life of the filter may be reduced in water supplies that contain an excess of particles or other impurities. Reduced flow rate is an indication that a new filter is required. Failure to replace the filter when required can affect the function of the ice maker. Service calls caused by a failure to replace the filter are not covered by warranty. Replacement water filters are available from Electrolux Home Products Spare Parts Centres and can be posted to you for your convenience (refer to spare parts contact numbers on the warranty page).

Contents of installation kit

Water supply and plumbing

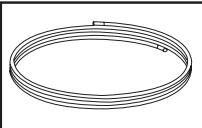
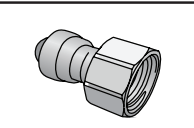
	
4 metres of water tubing	1 x 1/2" tap fitting

A drinkable water supply to suit a 1/2" tap fitting is required adjacent to the refrigerator. It is recommended that a licensed plumber install a new water supply outlet nearer to the appliance should the tubing supplied not be long enough. It is not recommended that the tubing be extended as this could adversely affect the flow of water to the ice maker or water dispenser. If there is a risk of flow rate higher than the maximum flow rate 2.46 L/min, a flow controller should be installed. The water dispenser and automatic ice maker require a drinkable water supply with a pressure range of between 206kPa and 689kPa (30psi and 100psi). If the water supply is above 100psi a pressure limiting valve should be installed.

It is recommended that a noise reduction valve also be fitted in the water supply line. This will reduce water hammer and its effects from quick action household taps and fast acting valves on appliances.

The refrigerator water valve is pre-fitted with a push-fit connector for inserting the water tube. When the tap connection is other than 1/2", adapters can be purchased from plumbing supply stores or good hardware stores.

Please read before beginning installation.

The appliance complies with the relevant backflow prevention requirements specified in AS/NZS 2845.1.

The water connection to your ice and water product can be self installed. However, it is recommended that you seek advice from a licensed plumber before commencing the installation.



IMPORTANT

Check for water leaks at all water connection points in the first 2 to 3 hours after installation, and correct it in case of any water leak. Rereck after 24 hours; if leak still occurs, it is recommended to contact a licensed plumber for advice.

Water is to be connected as per diagram below.

Step 1 Ensure that the refrigerator is disconnected from power supply.

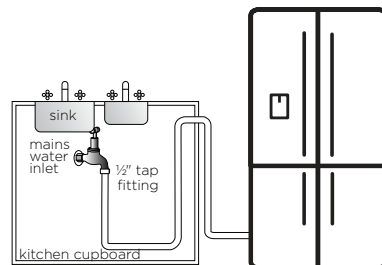

Step 2 Connect tap fitting to water supply tap. Tap must be close to the refrigerator.

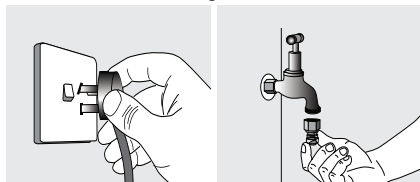

Step 3 Push the tube into tap fitting past insertion mark.

Step 4 Connect other end of tube to inlet on rear of refrigerator.

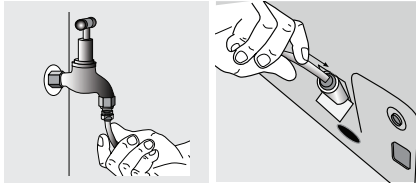

Step 5 Turn on water and check all joints and tubes for leaks.

Step 6 Reconnect the power.

Step 7 Move the refrigerator back into place being careful not to kink or split the tubing.

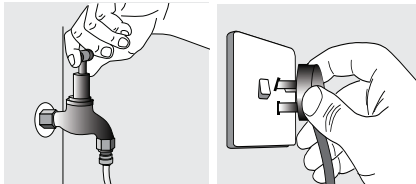

Step 8 Switch ON Water Dispenser. By referring to Ice & Water on/off function. Using a large container, run the water dispenser to clear air from lines. This may take a few minutes. Purge and dispense a minimum of 2 litres of water. Initial water may be black in colour.

This is residual carbon dust from the filter and is non-toxic. If the water is slow to shut off or the dispenser is dripping, air may still be in the lines. Either purge more water through the system to remove this air or allow some time for the air to be removed over subsequent dispensing. For normal use, water dispenser will automatically shut off after 2 minutes of continuous operation.

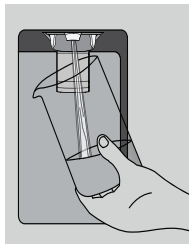

IMPORTANT

As the water cut off is not instant, leave glass under dispenser briefly until water has stopped flowing to avoid spills. Clean and empty the dispenser drip tray regularly to avoid overflow. Flushing system about 2 minutes after period of non-use exceeding 30 days.

Step 9 Switch ON Ice Maker. Once the refrigerator has been running for at least 24 hours remove the ice bin and dispose of the first few batches of ice to ensure that impurities have been flushed from the system.

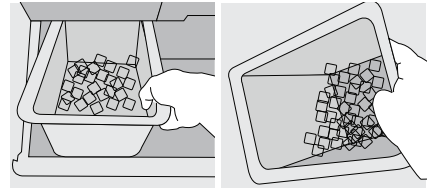

CAUTION

Water dispenser should not be used for extended periods of time. After 2 minutes of continuous use the water dispenser will automatically shut off.

Party Ice

When the Ice Bin is removed from the cabinet the Auto Ice Maker will continue to dispense ice into the top freezer drawer.



IMPORTANT

- Always fit the filter as per manufacturer's instructions.
- If you need to replace water tube, only use approved water quality piping that meets the pressure requirements.
- Make sure your refrigerator is level to avoid uneven ice cubes.
- Replace filter at suggested intervals to avoid water/ice reduction and irregularities in taste.
- Remove and clean ice bin once a month, discarding unused ice cubes. This will ensure fresh, clean ice and smooth operation of your ice maker.
- Clean and empty the dispenser drip tray regularly to avoid overflow.

7. AUTOMATIC ICE & WATER DISPENSER

Using the ice maker after installation

Before making ice for the first time, be sure to prime the water supply system. Air in new plumbing lines can result in two or three empty ice maker cycles. Furthermore, if the system is not flushed, the first ice cubes may be discolored or have an odd flavor.

Refilling the water tank

- The water tank must be placed on the door.
- Pour potable water through the funnel at the lid of water tank.
- Ensure that ice maker and dispenser is switched on.

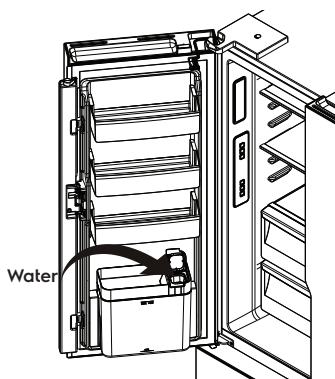

Priming the water supply system

1. Begin filling the system by pressing and holding a drinking glass against the dispenser.
2. Keep the glass in this position until water comes out of the dispenser. It may take about 1½ minutes.
3. Continue dispensing water for about four minutes to flush the system and plumbing connections of any impurities (stopping to empty the glass as necessary).

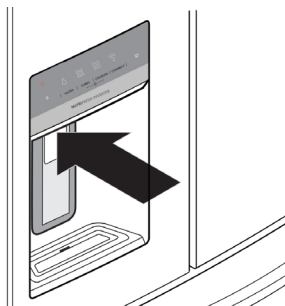

Note: The water dispenser has a built-in device that shuts off the water flow after three minutes of continuous use. To reset this shut-off device, simply release the dispenser paddle. Only the first 750 ml of dispensed water is chilled.



CAUTION

Do not fill the Water tank with anything other than clean water (Filtered or Mineral water). Soft drink, juice, tea or hot water etc, can damage your automatic icemaker. The Water tank can withstand a maximum water temperature of 60°C



TIP AND USEFUL INFORMATION

Remove and clean ice bin and water tank once a month, discarding unused ice and water. This will ensure fresh ice and smooth operation of your icemaker.

Make sure your refrigerator is level to avoid uneven ice cubes.

Ice maker operation & care

After the refrigerator is installed properly and has cooled for several hours, the ice maker can produce ice within 24 hours. The ice maker will fill the ice bin from the rear. You must dispense some ice to force the ice forward in the bin. This will allow the bin to fill completely.

Ice Maker and Storage Bin Capacity

This ice maker should produce 1 kg of ice per 24 hours. The ice bin will hold about 1.8 kg of ice.

Turning the ice maker on and off



IMPORTANT

Your ice maker is turned on at the factory so it can work as soon as you install your refrigerator. If you do not fill the water tank, set the ice maker's On/Off feature to Off; otherwise, the ice maker's fill valve may make a loud chattering noise when it attempts to operate without water.

Ice production is controlled by the ice maker's On/Off feature on the control panel. Pressing the On/Off feature turns the ice maker on & off.

Note: The ice maker also has a built-in plastic signal arm that automatically stops ice production when the ice bin is full. This signal arm should not be used to manually stop the ice maker.



IMPORTANT

Turning off the ice maker simply disables ice making. You will still be able to dispense existing ice, and you will still be able to dispense water.

Ice maker/dispenser tips

- If your refrigerator is not connected to a water supply or the water supply is turned off, turn off the ice maker as described in the previous section.
- The following sounds are normal when the ice maker is operating:
 - Motor running
 - Ice dropping into ice bin
 - Water valve opening or closing
 - Running water
- If you need a large quantity of ice at one time, it is best to get cubes directly from the ice bin.
- Ice cubes stored too long may develop an odd flavor. Empty the ice bin as explained below.
- It is normal to have a small quantity of little pieces along with the whole cube.
- It is normal for ice to fill to the top of the ice bin.

Water dispenser tips

- Check on the display make sure dispenser on.
- Keep the glass in this position until water come out of the dispenser



CAUTION

If the water supply to your refrigerator is softened, be sure the softener is properly maintained. Chemicals from a water softener can damage the ice maker.



CAUTION

It may remain water drop after your dispenser.

Cleaning the ice maker

Clean the ice maker and ice bin at regular intervals, especially prior to vacation or moving.

1. Turn off the icemaker.
2. Remove the ice bin by pulling straight out.
3. Empty and carefully clean the ice bin with mild detergent. Do not use harsh or abrasive cleaners. Do not place in dishwasher. Rinse with clear water.
4. Allow the ice bin to dry completely before placing it back into the freezer.
5. Place ice bin back into position. Turn the ice maker on.

8. GENERAL INFORMATION

8.1 CLEANING YOUR REFRIGERATOR



WARNING
BEFORE CLEANING: Turn the refrigerator off at the power point and unplug the cord to prevent any chance of electrocuting yourself.

Doors and exterior

You should only clean the doors with lukewarm soapy water and a soft cloth.

Interior

Clean the inside of your refrigerator regularly with a soft cloth, unscented mild soap and lukewarm water. Thoroughly dry all surfaces and removable parts and avoid getting water on the controls. Replace removable parts, plug power cord in and switch the power on before returning the food.

Door seals

Always keep door seals clean by washing them with a mild detergent and warm water, followed by a thorough drying. Sticky food and drink can cause seals to stick to the cabinet and tear when you open the door.

Never use hot water, solvents, commercial kitchen cleaners, aerosol cleaners, metal polishes, caustic or abrasive cleaners, or scourers to clean your refrigerator. Many commercially available cleaning products and detergents contain solvents that will damage your refrigerator. Use only a soft cloth with an unscented mild soap and lukewarm water.



CAUTION
 To clean a crisper or freezer bin with telescopic extension slides, simply wipe with a damp cloth and warm soapy water. Never immerse the cover in water, as this could affect the operation of the slide.

Switching off your refrigerator

If you switch off your refrigerator for an extended period, follow these steps to reduce the chances of mould.

1. Remove all food.
2. Remove the power plug from the power point.
3. Thoroughly clean and dry the Interior.
4. Ensure that all the doors are wedged open slightly for air circulation.

8.2 Water Filter

Your refrigerator is equipped with a water filtering system. The water filtering system filters all dispensed drinking water, as well as the water used to produce ice. The water filter is located at the top right side of the fresh food compartment.

In general, you should change the water filter every six months to ensure the highest possible water quality. Water filter status on the user interface prompts you to replace the filter after a standard amount of water (750 litres) has flowed through the system.

If your refrigerator has not been used for a period of time (during moving for example), change the filter before reinstalling the refrigerator

Note: When ordering your replacement filter, please reorder the same filter type that is currently in your refrigerator.



WARNING
 Use the appliance with water filter supplied by Electrolux Home Products Pty Ltd or its authorized service agent only.

For correct operation of this appliance it is essential to observe the manufacturer's instructions.

Replacing the Water Filter

It is not necessary to turn the water supply off to change the filter. Be ready to wipe up any small amounts of water released during the filter replacement.

1. Ensure that the ice maker is turned off.
2. Remove the filter by turning anti-clockwise 180°
3. Slide the old water filter cartridge straight out of the housing and discard it.

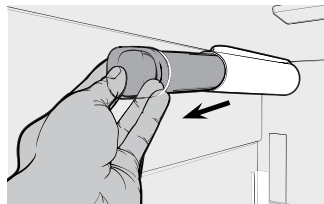

4. Unwrap the new filter cartridge and using the alignment guide, slide it gently into filter housing until it stops against the filter connection at the back of the housing.

- Engage the filter by firmly rotating clockwise until the filter snaps into position (once engaged the filter cannot be rotated further).

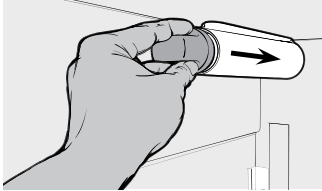

- Press a drinking glass against the water dispenser while checking for any leaks at the filter housing. Any spurts and sputters that occur as the system purges air out of the dispenser system are normal.

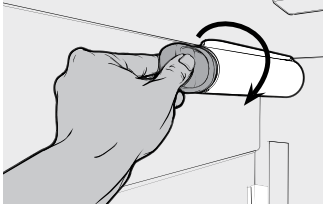

- After filling one glass of water, continue flushing the system for about four minutes.
- Turn on the ice maker.
- When the filter has been replaced press and hold the 'Reset Water Filter' button for three seconds to reset the filter replace timer.
- Replace the filter, don't take off filter cover.

8.3 Ice and water

Clean the components of the ice maker/water dispenser regularly with a soft cloth, unscented mild soap and rinsing thoroughly with lukewarm water. For further information on the care and cleaning of your ice maker, ice dispenser or water dispenser refer to the section "Ice and Water Models

8.4 Water tank

The water tank is intended to be removed only for cleaning purposes, to fill the portable water only, the tank must be placed on the door and the funnel on the lid has to be used.

Clean the inside of the water tank regularly with a soft cloth and the filter use the soft brush to clean, unscented mild soap and rinse thoroughly with lukewarm water to completely remove any soap residue.

NOTE: When customer assembled tank to door. To avoid water leaks ensure that tank nozzle fully engaged with housing socket.

9. FOOD STORAGE GUIDE

CATEGORY	PRODUCT	REFRIGERATOR	FREEZER	STORAGE TIPS
Meat	Sausages and Mince	1-2 Days	2-3 Months	Keep cold meat at the back of the refrigerator where it is coldest.
	Chops and Steak	3-4 Days	4-6 Months	Plastic can cause meat to sweat if stored in refrigerator for more than a day.
	Cold Meats	3-5 Days	4-6 Months	Roast can take up to 48 hours to defrost properly, transfer frozen roast to the refrigerator 2 days before use.
	Roasts	3-5 Days	12 Months	
Poultry	Chicken	1-2 Days	2 Months	If poultry takes on a smell or colour you are unsure about it is best to throw it out.
	Roast Chicken	3-5 Days	12 Months	
	Eggs	6 Weeks	Not Suitable	Whole eggs are not suitable for freezing, slightly beaten eggs may be frozen for four months.
Seafood	Whole fish and fillets	2-3 Days	2 Months	Store in an airtight container or foil.
	Lobster and crabs	1-2 Days	2 Months	
	Prawns	1-2 Days	2 Months	Never freeze prawns in salty water as this will dehydrate the flesh.
Dairy	Milk	7-10 Days	Not Suitable	If dairy takes on a smell or colour and you are unsure about it, it is best to throw it out.
	Yoghurt	7-10 Days	Not Suitable	
	Hard Cheeses	2 Weeks – 2 Months	2 Months (Grated)	Depending on the variety hard cheese can last from 2 weeks to 2 months.
	Soft Cheeses	1-2 Weeks	Not Suitable	
	Butter	8 Weeks	12 Months	
Fruit & Vegetables	Every fruit and vegetable has a different shelf life. Some stay fresh for a couple of days e.g beans, others can last for a couple of months e.g. onions.		8-12 Months	Keep vegetables in the crisper and away from the air vents to avoid freezing.
			When freezing chop and blanch in small portions.	
Left Overs	Homemade meals	3-4 Days	2-6 Months	Store in sealed container.
				Freeze meals in small portion sizes to limit wastage.



IMPORTANT

Please note, use this information as a guide only, actual storage times will vary depending on how you use your refrigerator, climatic conditions and the freshness of the food.

10. TROUBLESHOOTING

Appliance does not operate at desired temperature

In a modern frost free refrigerator / freezer, cold air is circulated around the various compartments through air vents using a high efficiency fan.

CONCERN	WHAT TO DO
Refrigerator is too warm	<ul style="list-style-type: none"> Adjust the refrigerator to a colder setting Ensure food is allowed to cool before placing inside the refrigerator. Ensure the appliance is set up as per instructions Ensure that contents are not obstructing the cooling vents. Ensure the door is not held open or is being opened too frequently.
Freezer is too warm	<ul style="list-style-type: none"> Adjust temperature to a colder setting. Ensure food is allowed to cool before placing inside the freezer. Ensure the appliance is set up as per instructions Ensure that contents are not obstructing the cooling vents. Ensure the door is not held open or is being opened too frequently.
Food is freezing in the refrigerator	<ul style="list-style-type: none"> Adjust temperature to a warmer setting. Ensure that fruit and vegetables are stored in the crisper. Items with a high water content should not be placed near the cooling vents.
Unable to change temperature settings	<ul style="list-style-type: none"> Refer to sections “temperature control” and “about the user interface”. Ensure that user interface is in “awake” mode before trying to adjust temperature settings.

Appliance noise

Your new refrigerator may make sounds that your old one didn't make. Because the sounds are new to you, you might be concerned about them. Most of the new sounds are normal. Hard surfaces, like the floor, walls and cabinets, can make the sounds seem louder than they actually are. The following describes the kinds of sounds and what may be making them.

CONCERN	WHAT TO DO
Motor noise (compressor)	<p>Nothing. This is normal as your new refrigerator uses a high-speed compressor which switches on and off during operation.</p> <p>Note that the compressor noise may seem louder at the start of the on cycle.</p>
Motor noise (compressor);	<p>These refrigerators are fitted with a variable speed compressor and fan. At start up and on warm days they run at a higher speed to provide additional cooling. When less cooling is required the compressor and fan will run at a lower speed. As a result it is normal for sound levels to change depending on operating conditions.</p>
A clicking noise heard just before the compressor starts.	<p>Nothing. This is normal as your new refrigerator has an automatic switching action of the temperature control, turning the compressor on and off.</p>
Occasional gurgling, similar to water boiling.	<p>Nothing. As each cycle ends, you may hear a gurgling sound due to the refrigerant flowing in your refrigerator system.</p> <p>Nothing, this is normal as your new refrigerator uses high efficiency fans to circulate air. Fan speed and noise may increase during periods of heavy usage or hot weather.</p>

CONCERN	WHAT TO DO
Rattling and other noises.	<ul style="list-style-type: none"> • Ensure that the cabinet is level and stable, refer to Installation Instructions • Check the surrounds of the appliance to ensure there is nothing touching or placed on top of the appliance. • Ensure that contents of the appliance are not placed in such a way that they are vibrating (such as bottles).

Crisper Operation

CONCERN	WHAT TO DO
Excess moisture build up in crisper It is normal for there to be some moisture and humidity in the crisper bin.	<ul style="list-style-type: none"> • Ensure that the crisper is not over packed. • Adjust crisper humidity slides.
Crisper bin can not be removed	<ul style="list-style-type: none"> • If crisper bin interferes with the door bins, remove door bins before removing crisper. • Position cabinet so that the door can be fully opened.
Freezing items in the crisper	<ul style="list-style-type: none"> • Adjust temperature to a warmer setting.

Refrigerator operation

CONCERN	WHAT TO DO
Appliance will not run It is normal for the freezer fan not to operate during the automatic defrost cycle, or for a short time after the appliance is switched on.	<ul style="list-style-type: none"> • Ensure that the cord is plugged into a live power outlet and outlet is switched on. • Ensure that the household circuit breaker has not tripped or that the fuse has not blown. • The appliance maybe in defrost mode, check again in half an hour.
Compressor motor seems to run too long At normal room temperatures, expect your motor to run about 40% to 80% of the time. Under warmer conditions, expect it to run more often.	<ul style="list-style-type: none"> • Ensure that the doors are not held open. • Check that large amounts of warm food have not just been placed inside the appliance. • Note that the appliance will run more than normal just after you install it or when adjusting the temperature setting changes.
Compressor motor seems to run too long. These appliances use a variable speed compressor, which by design can run for long periods of time, this is normal	<ul style="list-style-type: none"> • The variable speed compressor and fan that at start up and on warm days, runs at high speeds to provide additional cooling. When less cooling is required the compressor and fan will run at a lower speed, but still may not switch off. This is normal. • It is possible that the only time the compressor and fan will stop is when the refrigerator is defrosting which is approximately once per day.

CONCERN	WHAT TO DO
<p>The exterior of the appliance is warm or hot to touch</p> <p>This is normal because the appliance transfers heat from the inside out through the outer panels and the divider between the doors.</p>	<ul style="list-style-type: none"> • Ensure the appliance has the external clearances recommended in the section "Installing your new appliance". • The exterior of the cabinet will be much warmer on warmer days it may even feel hot to touch, as the appliance is working harder.
<p>User interface will not respond</p> <p>To ensure settings are not accidentally changed the user interface will go into sleep mode when not in use. Press any button to wake user interface</p>	<ul style="list-style-type: none"> • Check that the user interface is in awake mode, refer to section "About the user interface". • Check that the user interface is not locked, refer to section "About the user interface". • If the user interface is frozen turn the appliance off for five minutes for the memory to clear, then turn back on. • Check that the user interface is not in Sabbath Mode, refer to control instructions. (I&W models only).
<p>Alarms Sounding</p>	<ul style="list-style-type: none"> • Check that all doors are fully closed. • Ensure that the over temperature alarm is not being activated by hot food placed in the freezer. • Check if the drinks timer has ended, refer control instructions.
<p>Frost build up</p>	<ul style="list-style-type: none"> • Check that all doors are fully closed. • Ensure that the doors are not opened too often. • Ensure that the return air vents are not blocked with packaging. • Ensure the seals are clean and not obstructed.
<p>Odours</p>	<ul style="list-style-type: none"> • The interior may need cleaning, refer to cleaning guide. • Ensure that food is stored correctly as some food, containers and wrapping can produce odours. • Check appliance for old or unusual food.
<p>Lights not working</p> <p>The LED lighting is esigned to turn on gradually. The LED lighting is designed to dim automatically if the door is left opened for more than 5 minutes and turn off completely if the door is open for more than 7 minutes. Closing the door will reset the timer.</p>	<ul style="list-style-type: none"> • Ensure that the cord is plugged into a live power outlet and outlet is switched on. • Ensure that the household circuit breaker has not tripped or that the fuse has not blown. • Check that the user interface is not in Sabbath Mode, refer to control instructions. • Check the appliance features section to determine lighting configuration for your model.

Door operation

CONCERN	WHAT TO DO
Freezer door pops open.	<ul style="list-style-type: none"> • This is normal and should re-close. This happens when the refrigerator door is closed too quickly. • If the freezer door stays open, it indicates that the appliance needs to be tilted backwards a little further. Refer to section "Installing your new appliance".
Self close not working.	<ul style="list-style-type: none"> • Check if your appliance has self closing hinges as not all models do. • It indicates that the appliance needs to be tilted backwards a little further. Refer to section "Installing your new appliance".
Door not sealing properly	<ul style="list-style-type: none"> • Ensure there is nothing that is preventing the door from closing such as appliance contents or items placed near the appliance. • Ensure that the crisper/freezer bin is closed completely. Refit if required as referred to in the section "Using your refrigerator". • Ensure the appliance is set up as per recommendations.
Door difficult to open and close	<ul style="list-style-type: none"> • If the door is difficult to open just after you have closed it this is due to the pressure equalising, the door will open normally after a few minutes.

If you still require service

If you have a problem, and the problem persists after you have made the checks mentioned, contact your nearest Electrolux approved Service Centre or the dealer you bought the refrigerator from. Be ready to quote the model number, the 9-digit PNC and 8-digit serial number, which is stated on the label inside the refrigerator compartment.

11. NOISES

Appliance noise

Your new refrigerator may make sounds that your old one didn't make. Because the sounds are new to you, you might be concerned about them. Most of the new sounds are normal. Hard surfaces, like the floor, walls and cabinets, can make the sounds seem louder than they actually are. The following describes the kinds of sounds and what may be making them.

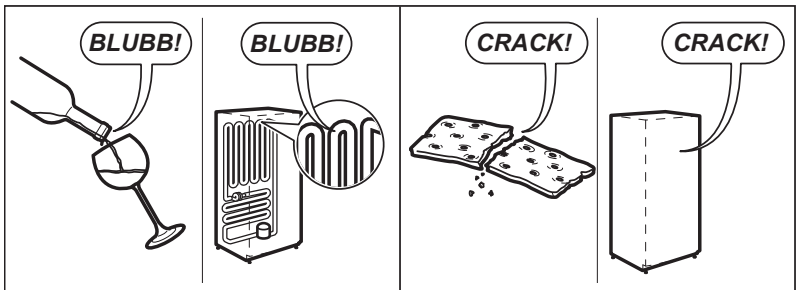
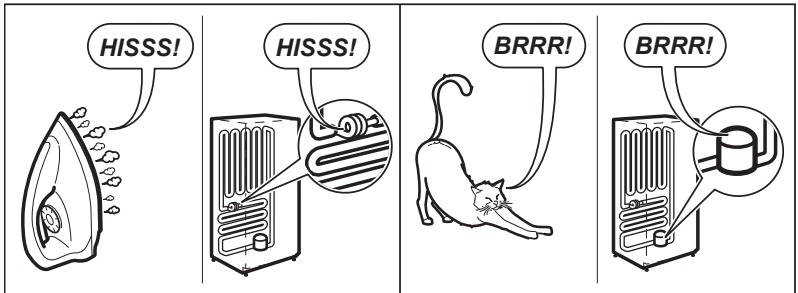
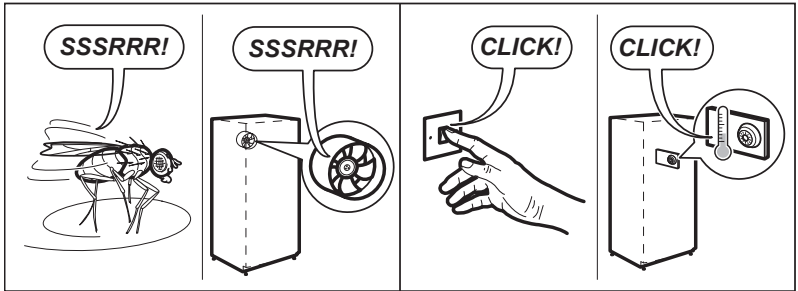
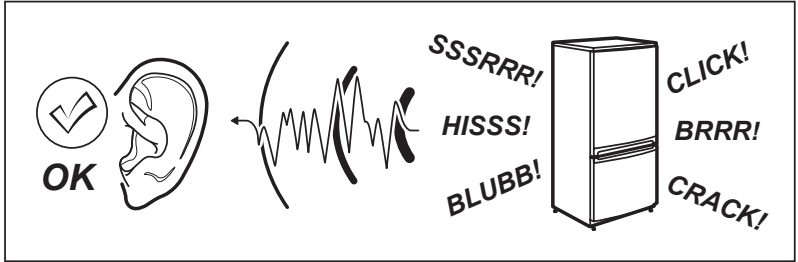



FOR SALES IN AUSTRALIA AND NEW ZEALAND
 APPLIANCE: WESTINGHOUSE REFRIGERATORS AND FREEZERS

This document sets out the terms and conditions of the product warranties for Westinghouse Appliances. It is an important document. Please keep it with your proof of purchase documents in a safe place for future reference should there be a manufacturing defect in your Appliance. This warranty is in addition to other rights you may have under the Australian Consumer Law.

1. In this warranty:

- (a) 'ACL' or 'Australian Consumer Law' means Schedule 2 to the Competition and Consumer Act 2010;
- (b) 'Appliance' means any Electrolux product purchased by you and accompanied by this document;
- (c) 'ASC' means Electrolux's authorised serviced centres;
- (d) 'Westinghouse' is the brand controlled by Electrolux Home Products Pty Ltd of 163 O'Riordan Street, Mascot NSW 2020, ABN 51 004 762 341 in respect of Appliances purchased in Australia and Electrolux (NZ) Limited (collectively "Electrolux") of 3-5 Niall Burgess Road, Mount Wellington, in respect of Appliances purchased in New Zealand;
- (e) 'Warranty Period' means the period specified in clause 3 of this warranty;
- (f) 'you' means the purchaser of the Appliance not having purchased the Appliance for re-sale, and 'your' has a corresponding meaning.

2. Application: This warranty only applies to new Appliances, purchased and used in Australia or New Zealand and is in addition to (and does not exclude, restrict, or modify in any way) other rights and remedies under a law to which the Appliances or services relate, including any non-excludable statutory guarantees in Australia and New Zealand.

3. Warranty Period: Subject to these terms and conditions, this warranty continues for in Australia for a period of 24 months and in New Zealand for a period of 24 months, following the date of original purchase of the Appliance. Specific components are warranted against manufacturing defects in Australia and New Zealand for the periods listed below;

- Compressor – Further 3 years parts only,
- External Condenser – Further 3 years parts only
- Evaporator – Further 3 years parts only
- Drier – Further 3 years parts only

4. Repair or replace warranty: During the Warranty Period, Electrolux or its ASC will, at no extra charge if your Appliance is readily accessible for service, without special equipment and subject to these terms and conditions, repair or replace any parts which it considers to be defective. Electrolux may, in its absolute discretion, choose whether the remedy offered for a valid warranty claim is repair or replacement. Electrolux or its ASC may use refurbished parts to repair your Appliance. You agree that any replaced Appliances or parts become the property of Electrolux.

5. Travel and transportation costs: Subject to clause 7, Electrolux will bear the reasonable cost of transportation, travel and delivery of the Appliance to and from Electrolux or its ASC. Travel and transportation will be arranged by Electrolux as part of any valid warranty claim.

6. Proof of purchase is required before you can make a claim under this warranty.

7. Exclusions: You may not make a claim under this warranty unless the defect claimed is due to faulty or defective parts or workmanship. This warranty does not cover:

- (a) light globes, batteries, filters or similar perishable parts;
- (b) parts and Appliances not supplied by Electrolux;
- (c) cosmetic damage which does not affect the operation of the Appliance;
- (d) damage to the Appliance caused by:
 - (i) negligence or accident
 - (ii) misuse or abuse, including failure to properly maintain or service;
 - (iii) improper, negligent or faulty servicing or repair works done by anyone other than an Electrolux authorised repairer or ASC;
 - (iv) normal wear and tear
 - (v) power surges, electrical storm damage or incorrect power supply;
 - (vi) incomplete or improper installation;
 - (vii) insect, improper or inappropriate operation;
 - (viii) insect or vermin infestation
 - (ix) failure to comply with any additional instructions supplied with the Appliance;

In addition, Electrolux is not liable under this warranty if:

- (a) the Appliance has been, or Electrolux reasonably believes that the Appliance has been, used for purposes other than those for which the Appliance was intended, including where the Appliance has been used for any non-domestic purpose;
- (b) the Appliance is modified without authority from Electrolux in writing;
- (c) the Appliance's serial number or warranty seal has been removed or defaced.

8. How to claim under this warranty: To enquire about claiming under this warranty, please follow these steps:

- (a) carefully check the operating instructions, user manual and the terms of this warranty;
- (b) have the model and serial number of the Appliance available;
- (c) have the proof of purchase (e.g. an invoice) available;
- (d) telephone the numbers shown below.

9. Australia: For Appliances and services provided by Electrolux in Australia: Electrolux goods come with guarantees that cannot be excluded under the Australian Consumer Law. You are entitled to a replacement or refund for a major failure and for compensation for any other reasonably foreseeable loss or damage. You are also entitled to have the Appliance repaired or replaced if the Appliance fails to be of acceptable quality and the failure does not amount to a major failure. 'Acceptable quality' and 'major failure' have the same meaning as referred to in the ACL.

10. New Zealand: For Appliances and services provided by Electrolux in New Zealand, the Appliances come with a guarantee by Electrolux pursuant to the provisions of the Consumer Guarantees Act, the Sale of Goods Act and the Fair Trading Act. Where the Appliance was purchased in New Zealand for commercial purposes the Consumer Guarantee Act does not apply.

11. Confidentiality: You accept that if you make a warranty claim, Electrolux and its agents including ASC may exchange information in relation to you to enable Electrolux to meet its obligations under this warranty.

Important Notice

Before calling for service, please ensure that the steps listed in clause 8 above have been followed.

<p>FOR SERVICE or to find the address of your nearest authorised service centre in Australia PLEASE CALL 13 13 49 <small>For the cost of a local call (Australia only)</small></p>	<p>AUSTRALIA ELECTROLUX HOME PRODUCTS 163 O'Riordan Street, Mascot NSW 2020 electrolux.com.au</p>	<p>FOR SPARE PARTS or to find the address of your nearest spare parts centre in Australia PLEASE CALL 13 13 50 <small>For the cost of a local call (Australia only)</small></p>
<p>FOR SERVICE or to find the address of your nearest authorised service centre in New Zealand PLEASE CALL 0800 10 66 10 <small>(New Zealand only)</small></p>	<p>NEW ZEALAND ELECTROLUX (NZ) Limited 3-5 Niall Burgess Road, Mount Wellington electrolux.co.nz</p>	<p>FOR SPARE PARTS or to find the address of your nearest spare parts centre in New Zealand PLEASE CALL 0800 10 66 20 <small>(New Zealand only)</small></p>

For more information on all Westinghouse appliances, or for dimension and installation information, call into your retailer, phone or email our customer care team or visit our website:

AUSTRALIA

phone: 1300 363 640
fax: 1800 350 067
email: customercare@electrolux.com.au
web: westinghouse.com.au

NEW ZEALAND

phone: 0800 436 245
fax: 0800 225 088
email: customercare@electrolux.co.nz
web: westinghouse.co.nz

TOP SERVICE

Top Service encompasses the after sales service provided by The Electrolux Group to consumers including delivery, home service and spare parts.

 and WESTINGHOUSE are trademarks of Westinghouse Electric Corporation. Used under license. All Rights Reserved.