



# HP EliteBook Folio 1030 G1 Notebook PC

## Maintenance and Service Guide

© Copyright 2016 HP Development Company, L.P.

AMD is a trademark of Advanced Micro Devices, Inc. Bluetooth is a trademark owned by its proprietor and used by HP Inc. under license. Intel, Celeron, and Pentium are trademarks of Intel Corporation in the U.S. and other countries. Microsoft and Windows are trademarks of the Microsoft group of companies.

The following applies to HP systems with Intel Skylake or next-generation silicon chip-based system shipping with Windows 7, Windows 8, Windows 8.1 or Windows 10 Pro systems downgraded to Windows 7 Professional, Windows 8 Pro, or Windows 8.1: This version of Windows running with the processor or chipsets used in this system has limited support from Microsoft. For more information about Microsoft's support, please see Microsoft's Support Lifecycle FAQ at <https://support.microsoft.com/lifecycle>

The information contained herein is subject to change without notice. The only warranties for HP products and services are set forth in the express warranty statements accompanying such products and services. Nothing herein should be construed as constituting an additional warranty. HP shall not be liable for technical or editorial errors or omissions contained herein.

First Edition: May 2016

Document Part Number: 839679-001

### **Product notice**

This user guide describes features that are common to most models. Some features may not be available on your computer.

Not all features are available in all editions of Windows. This computer may require upgraded and/or separately purchased hardware, drivers and/or software to take full advantage of Windows functionality. Go to <http://www.microsoft.com> for details.

### **Software terms**

By installing, copying, downloading, or otherwise using any software product preinstalled on this computer, you agree to be bound by the terms of the HP End User License Agreement (EULA). If you do not accept these license terms, your sole remedy is to return the entire unused product (hardware and software) within 14 days for a full refund subject to the refund policy of your seller.

For any further information or to request a full refund of the price of the computer, please contact your seller.

This computer may require upgraded and/ or separately purchased hardware and/or a DVD drive to install the Windows 7 software and take full advantage of Windows 7 functionality. See <http://windows.microsoft.com/en-us/windows7/get-know-windows-7> for details.

## Safety warning notice

---

 **WARNING!** To reduce the possibility of heat-related injuries or of overheating the device, do not place the device directly on your lap or obstruct the device air vents. Use the device only on a hard, flat surface. Do not allow another hard surface, such as an adjoining optional printer, or a soft surface, such as pillows or rugs or clothing, to block airflow. Also, do not allow the AC adapter to contact the skin or a soft surface, such as pillows or rugs or clothing, during operation. The device and the AC adapter comply with the user-accessible surface temperature limits defined by the International Standard for Safety of Information Technology Equipment (IEC 60950-1).

---



---

# Table of contents

<b>1 Product description .....</b>	<b>1</b>
<b>2 External component identification .....</b>	<b>4</b>
Display .....	4
Top .....	5
TouchPad .....	5
Lights .....	6
Buttons, speakers, and fingerprint reader .....	7
Keys .....	8
Left .....	9
Right .....	10
Bottom .....	11
Service tag .....	12
<b>3 Illustrated parts catalog .....</b>	<b>13</b>
Computer major components .....	13
Bracket Kit .....	15
NFC Cable Kit .....	16
Mass storage devices .....	17
Miscellaneous parts .....	17
<b>4 Removal and replacement procedures preliminary requirements .....</b>	<b>20</b>
Tools required .....	20
Service considerations .....	20
Plastic parts .....	20
Cables and connectors .....	20
Grounding guidelines .....	20
Electrostatic discharge damage .....	20
Packaging and transporting guidelines .....	21
Workstation guidelines .....	22
<b>5 Removal and replacement procedures for Authorized Service Provider parts .....</b>	<b>24</b>
Component replacement procedures .....	24
Bottom cover .....	24
Keyboard .....	27
Solid-state drive .....	31

WLAN module .....	33
Display assembly .....	35
RTC battery .....	39
Heat sink .....	41
Battery .....	43
Fingerprint reader board .....	45
NFC module .....	46
ForcePad (Touchpad) .....	47
System board .....	48
Speaker assembly .....	51

## **6 Computer Setup (BIOS), TPM, and HP Sure Start in Windows 7 ..... 52**

Using Computer Setup .....	52
Starting Computer Setup .....	52
Navigating and selecting in Computer Setup .....	52
Restoring factory settings in Computer Setup .....	53
Updating the BIOS .....	53
Determining the BIOS version .....	53
Downloading a BIOS update .....	54
Changing the boot order using the f9 prompt .....	55
TPM BIOS settings (select products only) .....	55
Using HP Sure Start (select products only) .....	55

## **7 Computer Setup (BIOS), TPM, and HP Sure Start in Windows 10 ..... 56**

Using Computer Setup .....	56
Starting Computer Setup .....	56
Navigating and selecting in Computer Setup .....	56
Restoring factory settings in Computer Setup .....	57
Updating the BIOS .....	57
Determining the BIOS version .....	57
Downloading a BIOS update .....	58
Changing the boot order using the f9 prompt .....	59
TPM BIOS settings (select products only) .....	59
Using HP Sure Start (select products only) .....	59

## **8 Using HP PC Hardware Diagnostics (UEFI) ..... 60**

Downloading HP PC Hardware Diagnostics (UEFI) to a USB device .....	60
---	----

## **9 Backup and recovery in Windows 7 ..... 62**

Creating recovery media and backups .....	62
---	----

Guidelines .....	62
Creating recovery media with HP Recovery Disc Creator .....	62
Creating recovery media .....	63
Backing up your information .....	63
Performing a system recovery .....	64
Using the Windows recovery tools .....	64
Using f11 recovery tools (select products only) .....	65
Using Windows 7 operating system media .....	65
<b>10 Backup and recovery in Windows 10 .....</b>	<b>67</b>
Creating recovery media and backups .....	67
Creating HP Recovery media (select products only) .....	67
Using Windows tools .....	68
Restore and recovery .....	69
Recovering using HP Recovery Manager .....	69
What you need to know before you get started .....	69
Using the HP Recovery partition (select products only) .....	70
Using HP Recovery media to recover .....	70
Changing the computer boot order .....	71
Removing the HP Recovery partition (select products only) .....	71
<b>11 Specifications .....</b>	<b>72</b>
Computer specifications .....	72
33.78-cm (13.3-in) display specifications .....	73
M.2 solid-state drive specifications .....	74
<b>12 Statement of memory volatility .....</b>	<b>75</b>
Nonvolatile memory usage .....	79
Questions and answers .....	81
Using HP Sure Start (select models only) .....	82
<b>13 Power cord set requirements .....</b>	<b>83</b>
Requirements for all countries .....	83
Requirements for specific countries and regions .....	83
<b>14 Recycling .....</b>	<b>85</b>
<b>Index .....</b>	<b>86</b>





# 1 Product description

Category	Description
<b>Product Name</b>	HP EliteBook Folio 1030 G1 Notebook PC
<b>Processors</b>	6th generation Intel® Core® M processors: <ul style="list-style-type: none"><li>• 6Y75, 1.2-GHz (max turbo frequency 3.1-GHz), 4-MB L3 Cache, 4.5W</li><li>• 6Y57, 1.1-GHz (max turbo frequency 2.8-GHz), 4-MB L3 Cache, 4.5W</li><li>• 6Y54, 1.1-GHz (max turbo frequency 2.7-GHz), 4-MB L3 Cache, 4.5W</li></ul>
<b>Chipset</b>	Mobile Intel CM236 chipset Integrated with processor
<b>Graphics</b>	Intel UMA Graphics (GT2) with shared video memory Intel HD Graphics 515
<b>Panels</b>	<b>33.78-cm</b> (13.3-in), eDP 1.3 Full high-definition (FHD), 1920×1080, non-touch display, 300 nits Quad high-definition (QHD+), 3200×1800, touch display, 300 nits
<b>Memory</b>	On-board (soldered) memory LPDDR3, 1866 MHz, dual channel support Supports 8 GB or 16 GB of total system memory
<b>Primary storage</b>	Supports the following M.2 SSDs: <ul style="list-style-type: none"><li>• 512-GB SATA-3, TLC</li><li>• 256-GB SATA-3, TLC</li><li>• 256-GB, SATA-3, SS SED, MLC, OPAL 2</li><li>• 256-GB, PCIe-3x4 NVMe SS MLC</li><li>• 240-GB, SATA-3 MLC</li><li>• 180-GB, SATA-3 SS SED, MLC</li><li>• 180-GB, SATA-3, SS MLC</li><li>• 128-GB, SATA-3, SS TLC</li></ul>
<b>Audio and video</b>	Two stereo speakers Intel Smart Sound Technology HD audio with DTS Studio Sound Integrated 720p webcam Integrated dual-array microphone
<b>Ethernet</b>	No direct Ethernet support. Ethernet available from accessory dongle.
<b>Wireless</b>	<b>WPAN Bluetooth</b> Bluetooth 4.2 supported with combo card

Category	Description
	<p><b>WLAN options via M.2</b></p> <p>Two WLAN antennas built into display assembly</p> <p>Bluetooth Disabled IOPT</p> <p>Support for the following WLAN formats:</p> <ul style="list-style-type: none"> <li>Intel Dual Band Wireless-AC 8260; 802.11ac, 2x2 + Bluetooth 4.2</li> </ul> <p>Supports no WLAN option</p>
	<p><b>NFC</b></p> <p>Integrated NFC module</p> <p>Supports "No NFC" option</p> <p>NFC antenna configured with NFC option</p>
<b>Ports</b>	<p>Headphone/microphone combo</p> <p>HDMI</p> <p>Docking connector</p> <p>Multi-Pin AC port, 4.5 mm</p> <p>(1) USB-C 3.0 charging port (15W)</p> <p>(2) USB 3.0 charging ports</p>
<b>Docking</b>	HP Docking Station
<b>Keyboard/pointing devices</b>	<p><b>Keyboard</b></p> <p>DuraKeys, backlit</p> <p>Spill-resistant with drain</p> <p><b>TouchPad</b></p> <p>Gestures enabled by default: two-finger scrolling, two-finger pinch-zoom</p> <p>Taps enabled by default</p> <p>Supports 2-way scroll</p> <p>Glass with chemical etched surface</p>
<b>Power requirements</b>	<p><b>AC adapters</b></p> <p>45-W HP Smart AC adapter</p> <p>45-W, 2-prong AC adapter</p> <p>65-W HP Smart AC adapter</p> <p>65-W Slim AC adapter</p> <p><b>Power cords</b></p> <p>2-wire plug (4.5 mm) (1.0 m)(only available with 45-W 2-prong adapter)</p> <p>3-wire plug with ground pin (4.5 mm) (1.0 m)</p> <p>3-wire plug with ground pin (4.5 mm) (1.8 m)</p> <p><b>Battery</b></p> <p>4-cell, 40-Whr, 2.4 Ahr long life polymer battery</p>

Category	Description
<b>Security</b>	<p>Security lock</p> <p>Fingerprint reader</p> <p>Trusted Platform Module (TPM) 1.2/2.0 (Infineon, soldered down)</p> <p>Drive encryption preboot (password, fingerprint, and select smart cards)</p> <p>Preboot authentication (password and fingerprint)</p>
<b>Operating system</b>	<p><b>Preinstalled</b></p> <ul style="list-style-type: none"> <li>• Windows 7 Professional 64</li> <li>• Windows 10 Pro 64</li> <li>• Windows 10 Home 64 Chinese Market CPPP</li> <li>• Windows 10 Home 64 High-end</li> <li>• Windows 10 Home 64 High-end Single Language</li> <li>• Windows 10 Professional 64 Downgrade Windows 7 64</li> <li>• Windows 10 Pro 64 StF MSNA High-end</li> <li>• Windows 10 Pro 64 Downgrade Win 7 64 StF MSNA High-end</li> <li>• Windows 10 Pro 64 StF MSNA Strategic</li> <li>• Windows 10 Pro 64 Downgrade Windows 7 64 StF MSNA Strategic</li> <li>• Windows 7 Pro 64 StF MSNA Strategic</li> <li>• FreeDOS 2.0</li> </ul> <p><b>Restore media—DR-DVD</b></p> <ul style="list-style-type: none"> <li>• Windows 7 (32 &amp; 64 bit)</li> <li>• Windows 10</li> </ul> <p><b>Restore media—OS-DVD</b></p> <ul style="list-style-type: none"> <li>• Windows 10 Pro 64</li> <li>• Windows 7 Pro 64</li> </ul> <p><b>Certified</b></p> <ul style="list-style-type: none"> <li>• Microsoft WHQL: Windows 7 64 and Windows 10 64</li> </ul> <p><b>Web-only support</b></p> <ul style="list-style-type: none"> <li>• Windows 10 Enterprise</li> <li>• Windows 8.1 Enterprise 64</li> <li>• Windows 7 Professional 32</li> <li>• Windows 7 Enterprise 64</li> <li>• Windows 7 Enterprise 32</li> </ul>
<b>Serviceability</b>	<p>End user replaceable parts:</p> <ul style="list-style-type: none"> <li>• AC adapter</li> </ul>

## 2 External component identification

### Display

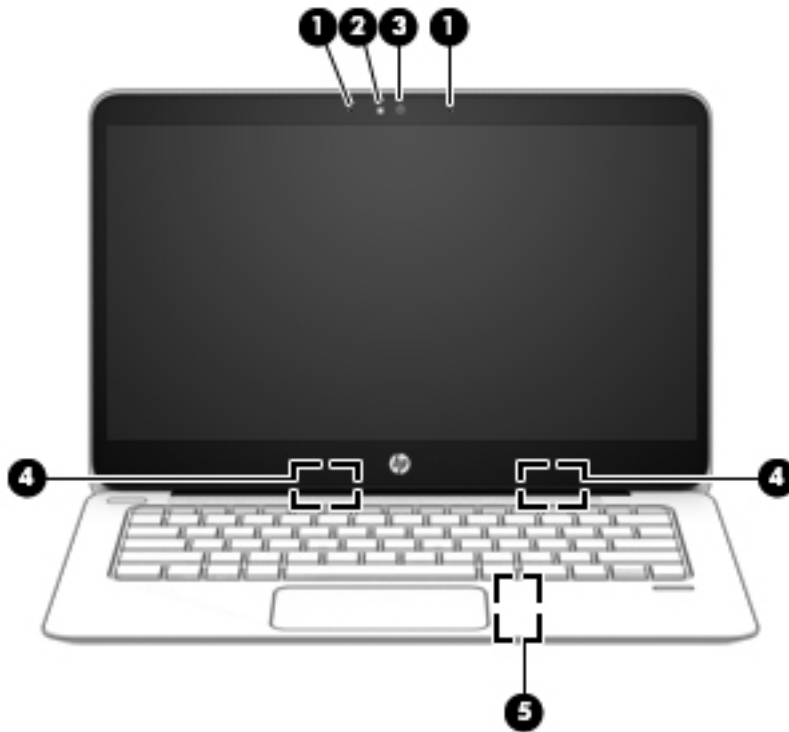

Component	Description
(1) Internal microphones (2)	Record sound.
(2) Webcam light	On: The webcam is in use.
(3) Webcam	Records video and captures photographs. Some models allow you to video conference and chat online using streaming video.  To use the webcam in Windows 10: <ul style="list-style-type: none"><li>▲ Type <code>camera</code> in the taskbar search box, and then select <b>Camera</b>.</li></ul> To use the webcam in Windows 7, select <b>Start &gt; All Programs &gt; Communication and Chat &gt; HP WebCam</b> .
(4) WLAN antennas* (2) (select products only)	Send and receive wireless signals to communicate with wireless local area networks (WLANs).
(5) Near Field Communication (NFC) antenna* (select products only)	Sends and receives wireless signals to communicate and transfer data/info to and from your NFC-compatible devices.

\*The antennas are not visible from the outside of the computer. For optimal transmission, keep the areas immediately around the antennas free from obstructions.

Component	Description
	For wireless regulatory notices, see the section of the <i>Regulatory, Safety, and Environmental Notices</i> that applies to your country or region.
	To access this guide in Windows 10:
1.	Type <code>support</code> in the taskbar search box, and then select the <b>HP Support Assistant</b> app.
	– or –
	Click the question mark icon in the taskbar.
2.	Select <b>My PC</b> , select the <b>Specifications</b> tab, and then select <b>User Guides</b> .
	To access the user guides in Windows 7, select <b>Start &gt; All Programs &gt; HP Help and Support &gt; HP Documentation</b> .

## Top



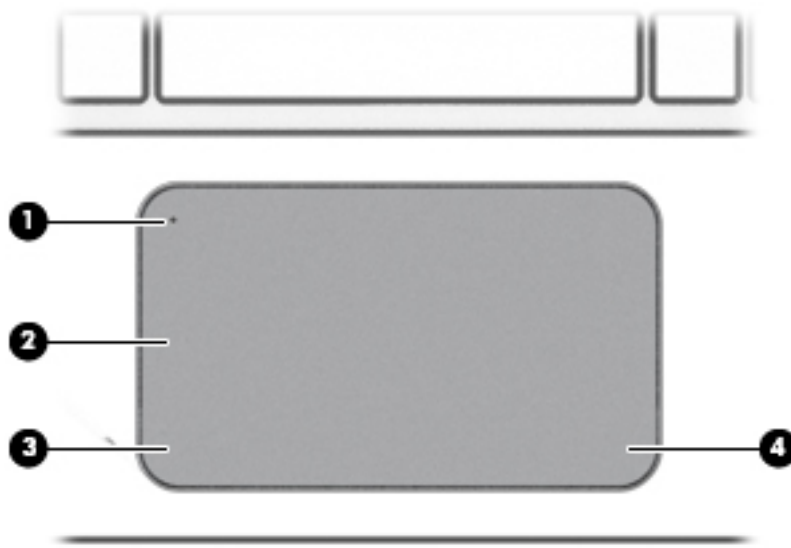

### TouchPad

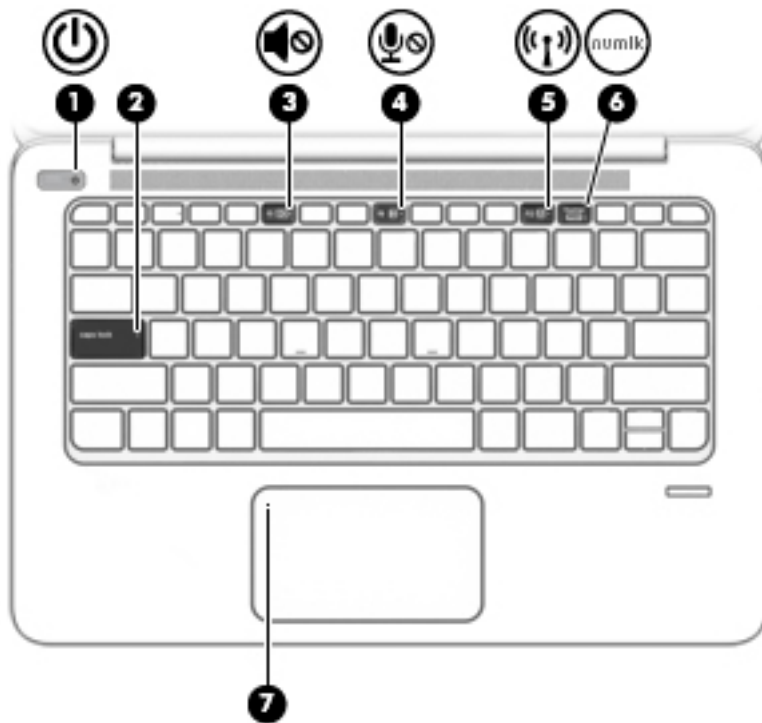

Component	Description
(1)	TouchPad on/off button Turns the TouchPad on and off.
(2)	TouchPad zone Reads your finger gestures to move the pointer or activate items on the screen. <b>NOTE:</b> The TouchPad detects the force of the finger pressure being applied while using gestures. Press your fingers down on the TouchPad with force while gesturing to accelerate the gesture motion.
(3)	Left TouchPad button Functions like the left button on an external mouse.
(4)	Right TouchPad button Functions like the right button on an external mouse.

## Lights



Component	Description
<b>(1)</b>  Power light	<ul style="list-style-type: none"> <li>On: The computer is on.</li> <li>Blinking: The computer is in the Sleep state, a power-saving state. The computer shuts off power to the display and other unneeded components.</li> <li>Off: The computer is off or in Hibernation. Hibernation is a power-saving state that uses the least amount of power.</li> </ul>
<b>(2)</b> Caps lock light	On: Caps lock is on, which switches the key input to all capital letters.
<b>(3)</b>  Mute light	<ul style="list-style-type: none"> <li>Amber: Computer sound is off.</li> <li>Off: Computer sound is on.</li> </ul>
<b>(4)</b>  Microphone mute light	<ul style="list-style-type: none"> <li>Amber: microphone sound is off.</li> <li>Off: microphone sound is on.</li> </ul>
<b>(5)</b>  Wireless light	<ul style="list-style-type: none"> <li>White: An integrated wireless device, such as a wireless local area network (WLAN) device and/or a Bluetooth® device, is on.</li> <li>Amber: All wireless devices are off.</li> </ul>
<b>(6)</b>  Num lock light	On: Num lock is on.
<b>(7)</b> TouchPad light	<ul style="list-style-type: none"> <li>Amber: The TouchPad is off.</li> <li>Off: The TouchPad is on.</li> </ul>

## Buttons, speakers, and fingerprint reader

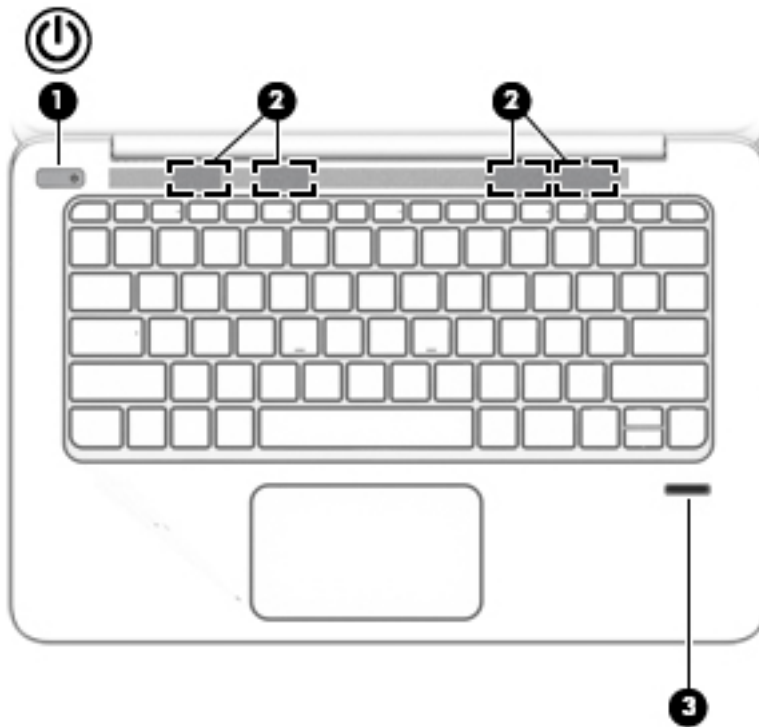



Component	Description
(1)  Power button	<ul style="list-style-type: none"><li>• When the computer is off, press the button to turn on the computer.</li><li>• When the computer is on, press the button briefly to initiate Sleep.</li><li>• When the computer is in the Sleep state, press the button briefly to exit Sleep.</li><li>• When the computer is in Hibernation, press the button briefly to exit Hibernation.</li></ul> <p><b>CAUTION:</b> Pressing and holding down the power button results in the loss of unsaved information.</p> <p>If the computer has stopped responding and Windows® shutdown procedures are ineffective, press and hold the power button for at least 5 seconds to turn off the computer.</p> <p>To learn more about your power settings in Windows 10, see your power options.</p> <ul style="list-style-type: none"><li>▲ Type <code>power</code> in the taskbar search box, and then select <b>Power and sleep settings</b>.</li></ul> <p>– or –</p> <p>Right-click the <b>Start</b> button, and then select <b>Power Options</b>.</p> <p>To learn more about your power settings in Windows 7, select <b>Start &gt; Control Panel &gt; System and Security &gt; Power Options</b>.</p>

Component	Description
(2) Speakers (4)	Produce sound.
(3) Fingerprint reader	Allows a fingerprint logon to Windows, instead of a password logon.

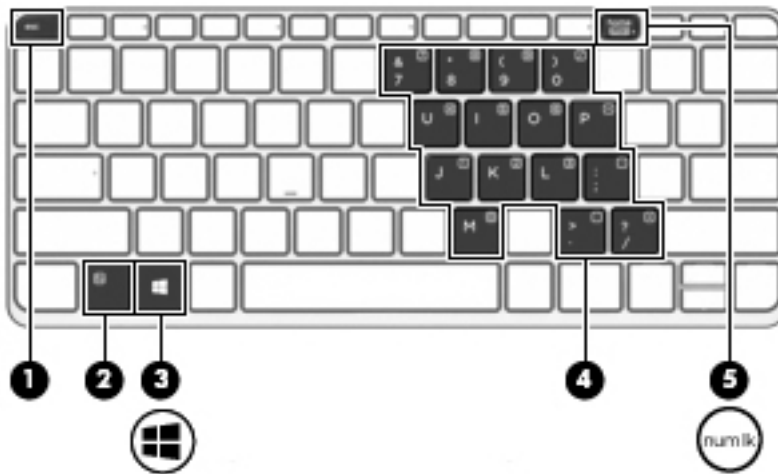
## Keys







Component	Description
(1) <b>esc</b> key	Displays system information when pressed in combination with the <b>fn</b> key.
(2) <b>fn</b> key	Executes frequently used system functions when pressed in combination with a function key, the <b>num lock</b> key, or the <b>esc</b> key.
(3)  Windows key	Windows 10: Opens the <b>Start</b> menu. <b>NOTE:</b> Pressing the Windows key again will close the <b>Start</b> menu. Windows 7: Displays the Windows Start menu.
(4) Embedded numeric keypad	A numeric keypad superimposed over the keyboard alphabet keys that enables you to add, subtract, and perform other numeric tasks. When <b>num lock</b> is on, the keypad can be used like an external numeric keypad.
(5)  <b>num lock</b> key	Turns the embedded numeric keypad on and off.

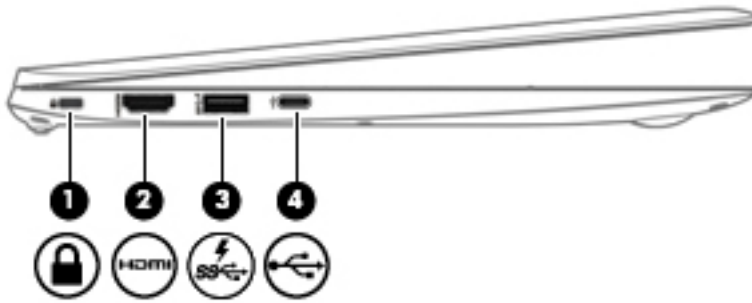



# Left

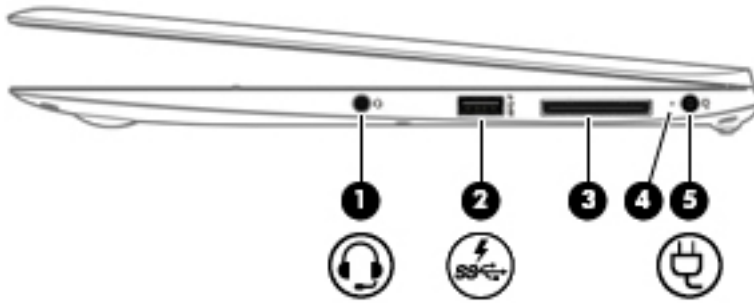

Component	Description
(1)  Security cable slot	Attaches an optional security cable to the computer. <b>NOTE:</b> The security cable is designed to act as a deterrent, but it may not prevent the computer from being mishandled or stolen.
(2)  HDMI port	Connects an optional video or audio device, such as a high-definition television, any compatible digital or audio component, or a high-speed High Definition Multimedia Interface (HDMI) device.
(3)  USB 3.0 charging (powered) port	Connects an optional USB device, such as a keyboard, mouse, external drive, printer, scanner or USB hub. Standard USB ports will not charge all USB devices or will charge using a low current. Some USB devices require power and require you to use a powered port. <b>NOTE:</b> USB charging ports can also charge select models of cell phones and MP3 players, even when the computer is off.
(4)  USB Type-C (charging) port	Connects any USB device with a Type-C connector. <b>NOTE:</b> USB Type-C ports charge products such as cell phones, laptops, tablets, and MP3 players, even when the computer is off. Also, some USB Type-C ports connect DisplayPort, VGA, HDMI, Thunderbolt and other video devices to provide video output. <b>NOTE:</b> Adapters (purchased separately) may be required.

# Right



Component	Description
<b>(1)</b>  Audio-out (headphone)/Audio-in (microphone) combo jack	<p>Connects optional powered stereo speakers, headphones, earbuds, a headset, or a television audio cable. Also connects an optional headset microphone. This jack does not support optional microphone-only devices.</p> <p><b>WARNING!</b> To reduce the risk of personal injury, adjust the volume before putting on headphones, earbuds, or a headset. For additional safety information, refer to the <i>Regulatory, Safety, and Environmental Notices</i>.</p> <p>To access this guide in Windows 10:</p> <ol style="list-style-type: none"> <li>Type <b>support</b> in the taskbar search box, and then select the <b>HP Support Assistant</b> app.</li> <li>– or –</li> <li>Click the question mark icon in the taskbar.</li> <li>Select <b>My PC</b>, select the <b>Specifications</b> tab, and then select <b>User Guides</b>.</li> </ol> <p>To access the user guides, select <b>Start &gt; All Programs &gt; HP Help and Support &gt; HP Documentation</b>.</p> <p><b>NOTE:</b> When a device is connected to the jack, the computer speakers are disabled.</p>
<b>(2)</b>  USB 3.0 charging (powered) port	<p>Connects an optional USB device, such as a keyboard, mouse, external drive, printer, scanner or USB hub. Standard USB ports will not charge all USB devices or will charge using a low current. Some USB devices require power and require you to use a powered port.</p> <p><b>NOTE:</b> USB charging ports can also charge select models of cell phones and MP3 players, even when the computer is off.</p> <p><b>NOTE:</b> The battery can be depleted quickly if you charge multiple devices while operating on battery power.</p>
<b>(3)</b> Docking connector	Connects an optional docking device.
<b>(4)</b> Battery light	<p>When AC power is connected:</p> <ul style="list-style-type: none"> <li>White: The battery charge is greater than 90 percent.</li> <li>Amber: The battery charge is from 0 to 90 percent.</li> <li>Off: The battery is not charging.</li> </ul> <p>When AC power is disconnected (battery not charging):</p>

Component	Description
(5)	<ul style="list-style-type: none"> <li>Blinking amber: The battery has reached a low battery level. When the battery has reached a critical battery level, the battery light begins blinking rapidly.</li> <li>Off: The battery is not charging.</li> </ul>
	Power connector
	Connects an AC adapter.

## Bottom

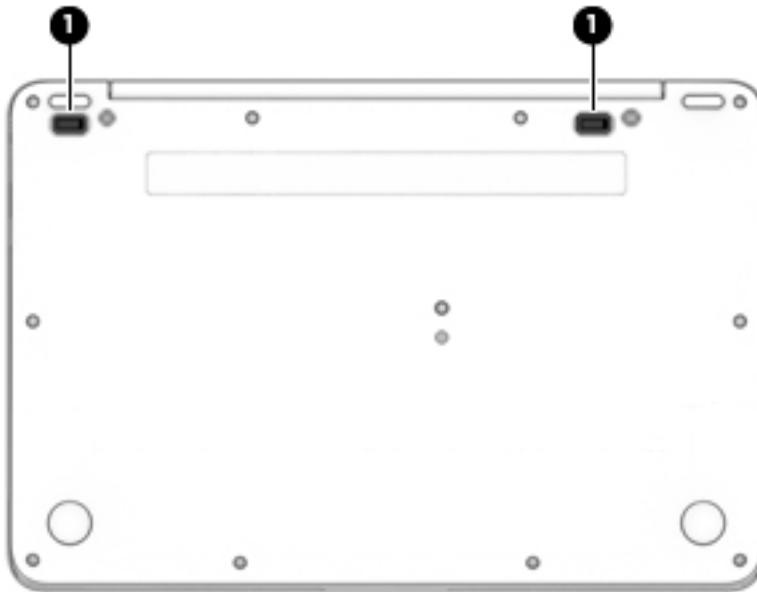

Component	Description	Description
(1)	Docking device receptors (2)	Connects an optional docking device.

## Service tag

When ordering parts or requesting information, provide the computer serial number and model number provided on the service tag.

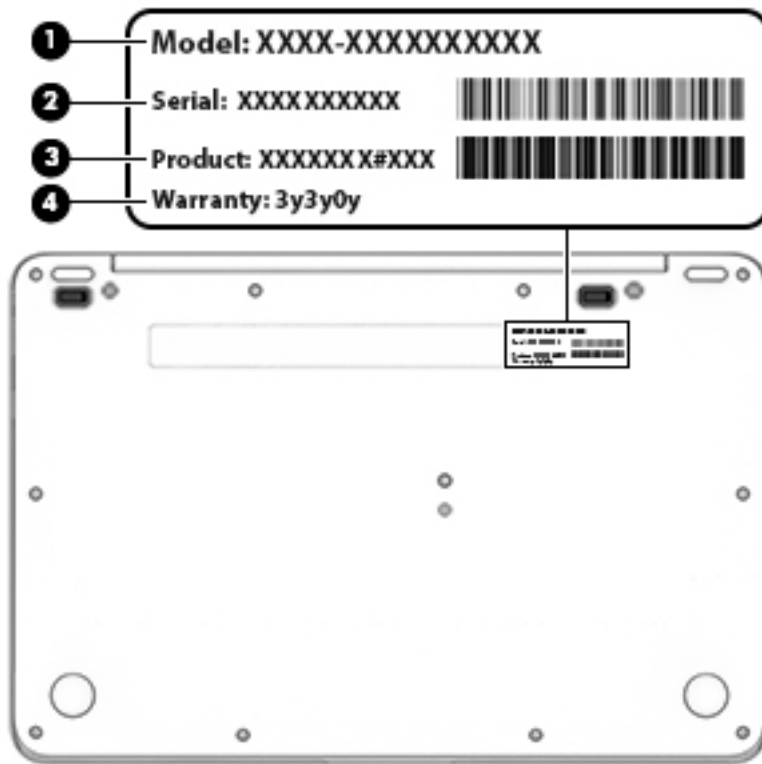

Item	Description	Function
(1)	Product name	This is the product name affixed to the front of the computer.
(2)	Serial number (s/n)	This is an alphanumeric identifier that is unique to each product.
(3)	Part number/Product number (p/n)	This number provides specific information about the product's hardware components. The part number helps a service technician to determine what components and parts are needed.
(4)	Warranty period	This number describes the duration of the warranty period for the computer.

# 3 Illustrated parts catalog

## Computer major components

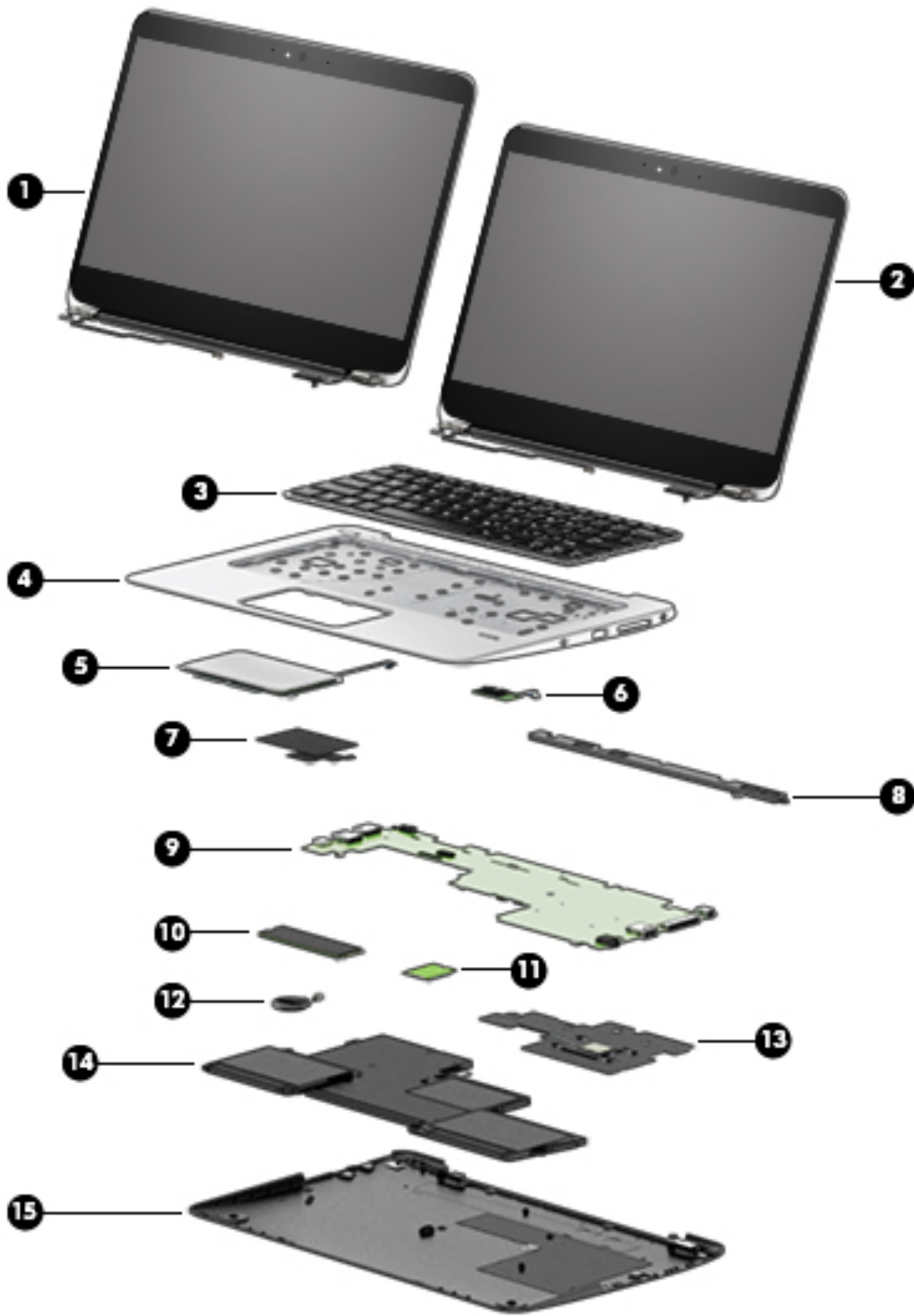

Item	Component	Spare part number
(1)	<b>Display assembly</b> , touch screen, QHD+  <b>NOTE:</b> Touch displays are only spared as full hinge-ups. Individual components are not spared for touch screen displays.	842280-001
(2)	<b>Display assembly</b> , non-touch screen, FHD  <b>NOTE:</b> Non-touch displays are only spared as full hinge-ups. Individual components are not spared for non-touch screen displays.	850931-001
(3)	<b>Keyboard</b> (backlit; includes keyboard cable and backlight cable):  <b>NOTE:</b> For a detailed list of keyboard country codes, see <a href="#">Keyboard on page 27</a> .	842324-xx1
(4)	<b>Top cover</b> (includes power button)	842284-001
(5)	<b>ForcePad (Touchpad)</b>  The ForcePad cable is available in the Cable Kit using spare part number 842293-001.	842287-001
(6)	<b>Fingerprint reader board</b> (includes bracket and cable)	790074-001
(7)	<b>NFC module</b>	790069-001
	<b>NFC Cable Kit</b> , includes:	842323-001
	NFC module antenna	
	NFC module cable	
(8)	<b>Speakers</b> (includes cable)	837352-001
(9)	<b>System board</b> (includes processor and replacement thermal material):  All system boards use the following part numbers:  xxxxxx-001: Windows 7 or non-Windows operating systems  xxxxxx-601: Windows 10 operating system	
	Equipped with 16 GB of system memory and an Intel Core M7-6Y75 processor	842326-xxx
	Equipped with 16 GB of system memory and an Intel Core M5-6Y57 processor	842328-xxx
	Equipped with 8 GB of system memory and an Intel Core M5-6Y57 processor	842327-xxx
	Equipped with 8 GB of system memory and an Intel Core M5-6Y54 processor	842325-xxx
(10)	<b>Solid-state drive, M.2</b>	
	512-GB, MLC	842300-001
	256-GB, SED, OPAL2	842298-001
	256-GB, TLC	842610-001
	256-GB, PCIe, NVMe, MLC	842299-001
	240-GB, MLC	842611-001
	180-GB, MLC	842296-001
	180-GB, SED, OPAL2	842297-001
	128-GB, TLC	842295-001
(11)	<b>WLAN module</b>	

Item	Component	Spare part number
	Intel Dual Band Wireless-AC 8260; 802.11ac, 2x2 + Bluetooth 4.2	806721-005
(12)	<b>RTC battery</b> (includes double-sided tape)	702853-001
(13)	<b>Heat sink/thermal module</b> (includes replacement thermal material):	842301-001
(14)	<b>Battery</b> (4-cell, 40-Wh, 2.6-Ah, li ion)	826038-005
(15)	<b>Bottom cover</b>	842283-001

## Bracket Kit

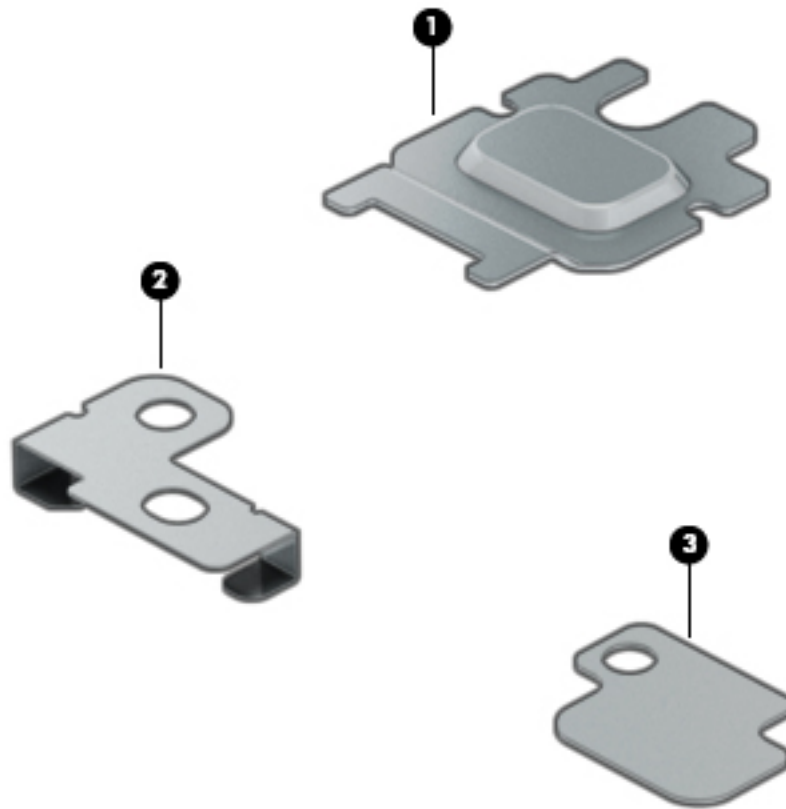

Item	Component	Spare part number
	<b>Bracket Kit</b>	842302-001
(1)	Fingerprint reader bracket	
(2)	Left display (QHD) bracket	
(3)	Right display (QHD) bracket/clip	
	Top cable clip (left and right; not illustrated)	

## NFC Cable Kit

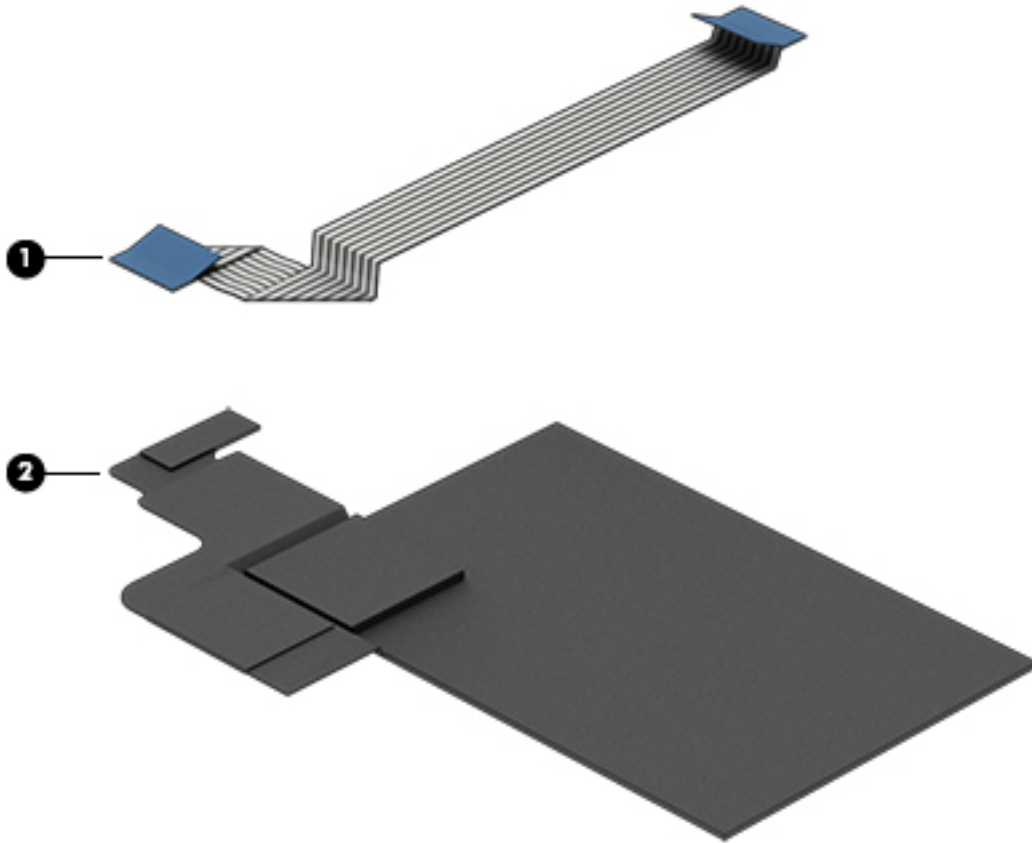

Item	Component	Spare part number
	<b>NFC Cable Kit</b>	842323-001
(1)	NFC cable	
(2)	NFC antenna	



## Mass storage devices

Description	Spare part number
<b>Solid-State Drive M.2</b>	
512-GB, MLC	842300-001
256-GB, SED, OPAL2	842298-001
256-GB, TLC	842610-001
256-GB, PCIe, NVMe, MLC	842299-001
240-GB, MLC	842611-001
180-GB, MLC	842296-001
180-GB, SED, SED, OPAL2	842297-001
128-GB, TLC	842295-001
<b>External optical drive (DVD±RW Double Layer Drive)</b>	747080-001

## Miscellaneous parts

Component	Spare part number
<b>AC adapter:</b>	
45-W HP Smart AC adapter (non-PFC) – non-slim	741727-001
45-W AC adapter (non-PFC), 2-prong	742436-001
65-W HP Smart AC adapter, 4.5 mm, EM	714657-001
65-W HP Smart AC travel adapter	693716-001
Use spare part number 736697-001, "Cable, detachable, with tips (4.5 mm and 7.4 mm tips)" with this adapter.	
<b>Smart AC adapter dongle, 7.4mm</b>	734734-001
<b>Power cord (3-pin, C5, black, 1.83-m), for use in:</b>	
Argentina	401300-001
Australia	213356-001
Brazil	438722-001
Denmark	213353-001
Europe (Austria, Belgium, Finland, France, Germany, the Netherlands, Norway and Sweden)	213350-001
India	404827-001
Israel	398063-001
Italy	213352-001
Japan	349756-001
North America	213349-001

<b>Component</b>	<b>Spare part number</b>
People's Republic of China	286497-001
South Africa	361240-001
South Korea	267836-001
Switzerland	213354-001
Taiwan	393313-001
United Kingdom and Singapore	213351-001
<b>Power cord (3-pin, C5, black, 1.00-m), for use in:</b>	
Argentina	401300-007
Australia	213356-008
Brazil	438722-004
Denmark	213353-008
Europe (Austria, Belgium, Finland, France, Germany, the Netherlands, Norway and Sweden)	213350-009
India	404827-003
Israel	398063-003
Italy	213352-008
Japan	349756-002
North America	213349-009
People's Republic of China	286497-008
South Africa	361240-002
South Korea	267836-008
Switzerland	213354-008
Taiwan	393313-003
Thailand	285096-006
United Kingdom and Singapore	213351-008
<b>Power cord (C7, black, 1.00-m), for use in:</b>	
Japan	190548-003
<b>Screw Kit</b>	842285-001
<b>Plastics Kit</b> (includes system board clip)	860705-001
<b>Cable, detachable, with tips</b> (4.5 mm and 7.4 mm tips)	736697-001
For use with 65-W HP Smart AC travel adapter, spare part number 693716-001.	
<b>Docking station cable lock</b>	575921-001
<b>Lock</b> , HP UltralSlim Keyed Cable Lock	703372-001
<b>Mouse:</b>	
HP USB optical travel mouse	757770-001

<b>Component</b>	<b>Spare part number</b>
HP Comfort Grip wireless mouse	691922-001
HP USB laser mouse	674318-001
<b>Top load case</b>	679921-001
<b>HP professional slim top load case</b>	703888-001
<b>HP business backpack</b>	718548-001
<b>Adapters</b>	
HDMI to DVI-D adapter	691227-001
Docking connector to ethernet (RJ-45)/VGA	797848-001
HDMI to VGA	701943-001
HP USB-C to USB 3.0 adapter	814618-001

---

# 4 Removal and replacement procedures preliminary requirements

## Tools required

You will need the following tools to complete the removal and replacement procedures:

- Flat-bladed screw driver
- Torx T8 screw driver
- Phillips P0 and P1 screw drivers
- Non-marking pry tool

## Service considerations

The following sections include some of the considerations that you must keep in mind during disassembly and assembly procedures.



**NOTE:** As you remove each subassembly from the computer, place the subassembly (and all accompanying screws) away from the work area to prevent damage.

---

## Plastic parts



**CAUTION:** Using excessive force during disassembly and reassembly can damage plastic parts. Use care when handling the plastic parts. Apply pressure only at the points designated in the maintenance instructions.

---

## Cables and connectors



**CAUTION:** When servicing the computer, be sure that cables are placed in their proper locations during the reassembly process. Improper cable placement can damage the computer.

---

Cables must be handled with extreme care to avoid damage. Apply only the tension required to unseat or seat the cables during removal and insertion. Handle cables by the connector whenever possible. In all cases, avoid bending, twisting, or tearing cables. Be sure that cables are routed in such a way that they cannot be caught or snagged by parts being removed or replaced. Handle flex cables with extreme care; these cables tear easily.

## Grounding guidelines

### Electrostatic discharge damage

Electronic components are sensitive to electrostatic discharge (ESD). Circuitry design and structure determine the degree of sensitivity. Networks built into many integrated circuits provide some protection, but in many cases, ESD contains enough power to alter device parameters or melt silicon junctions.

A discharge of static electricity from a finger or other conductor can destroy static-sensitive devices or microcircuitry. Even if the spark is neither felt nor heard, damage may have occurred.

An electronic device exposed to ESD may not be affected at all and can work perfectly throughout a normal cycle. Or the device may function normally for a while, then degrade in the internal layers, reducing its life expectancy.

**CAUTION:** To prevent damage to the computer when you are removing or installing internal components, observe these precautions:

Keep components in their electrostatic-safe containers until you are ready to install them.

Before touching an electronic component, discharge static electricity by using the guidelines described in this section.

Avoid touching pins, leads, and circuitry. Handle electronic components as little as possible.

If you remove a component, place it in an electrostatic-safe container.

The following table shows how humidity affects the electrostatic voltage levels generated by different activities.

**CAUTION:** A product can be degraded by as little as 700 V.

Typical electrostatic voltage levels			
Event	Relative humidity		
	10%	40%	55%
Walking across carpet	35,000 V	15,000 V	7,500 V
Walking across vinyl floor	12,000 V	5,000 V	3,000 V
Motions of bench worker	6,000 V	800 V	400 V
Removing DIPs from plastic tube	2,000 V	700 V	400 V
Removing DIPs from vinyl tray	11,500 V	4,000 V	2,000 V
Removing DIPs from Styrofoam	14,500 V	5,000 V	3,500 V
Removing bubble pack from PCB	26,500 V	20,000 V	7,000 V
Packing PCBs in foam-lined box	21,000 V	11,000 V	5,000 V

## Packaging and transporting guidelines

Follow these grounding guidelines when packaging and transporting equipment:

- To avoid hand contact, transport products in static-safe tubes, bags, or boxes.
- Protect ESD-sensitive parts and assemblies with conductive or approved containers or packaging.
- Keep ESD-sensitive parts in their containers until the parts arrive at static-free workstations.
- Place items on a grounded surface before removing items from their containers.
- Always be properly grounded when touching a component or assembly.
- Store reusable ESD-sensitive parts from assemblies in protective packaging or nonconductive foam.
- Use transporters and conveyors made of antistatic belts and roller bushings. Be sure that mechanized equipment used for moving materials is wired to ground and that proper materials are selected to avoid static charging. When grounding is not possible, use an ionizer to dissipate electric charges.

## Workstation guidelines

Follow these grounding workstation guidelines:

- Cover the workstation with approved static-shielding material.
- Use a wrist strap connected to a properly grounded work surface and use properly grounded tools and equipment.
- Use conductive field service tools, such as cutters, screw drivers, and vacuums.
- When fixtures must directly contact dissipative surfaces, use fixtures made only of static-safe materials.
- Keep the work area free of nonconductive materials, such as ordinary plastic assembly aids and Styrofoam.
- Handle ESD-sensitive components, parts, and assemblies by the case or PCM laminate. Handle these items only at static-free workstations.
- Avoid contact with pins, leads, or circuitry.
- Turn off power and input signals before inserting or removing connectors or test equipment.

## Equipment guidelines

Grounding equipment must include either a wrist strap or a foot strap at a grounded workstation.

- When seated, wear a wrist strap connected to a grounded system. Wrist straps are flexible straps with a minimum of one megohm  $\pm 10\%$  resistance in the ground cords. To provide proper ground, wear a strap snugly against the skin at all times. On grounded mats with banana-plug connectors, use alligator clips to connect a wrist strap.
- When standing, use foot straps and a grounded floor mat. Foot straps (heel, toe, or boot straps) can be used at standing workstations and are compatible with most types of shoes or boots. On conductive floors or dissipative floor mats, use foot straps on both feet with a minimum of one megohm resistance between the operator and ground. To be effective, the conductive must be worn in contact with the skin.

The following grounding equipment is recommended to prevent electrostatic damage:

- Antistatic tape
- Antistatic smocks, aprons, and sleeve protectors
- Conductive bins and other assembly or soldering aids
- Nonconductive foam
- Conductive tabletop workstations with ground cords of one megohm resistance
- Static-dissipative tables or floor mats with hard ties to the ground
- Field service kits
- Static awareness labels
- Material-handling packages
- Nonconductive plastic bags, tubes, or boxes
- Metal tote boxes
- Electrostatic voltage levels and protective materials

The following table lists the shielding protection provided by antistatic bags and floor mats.

<b>Material</b>	<b>Use</b>	<b>Voltage protection level</b>
Antistatic plastics	Bags	1,500 V
Carbon-loaded plastic	Floor mats	7,500 V
Metallized laminate	Floor mats	5,000 V

# 5 Removal and replacement procedures for Authorized Service Provider parts

 **CAUTION:** Components described in this chapter should only be accessed by an authorized service provider. Accessing these parts can damage the computer or void the warranty.

## Component replacement procedures

 **NOTE:** Details about your computer, including model, serial number, product key, and length of warranty, are on the service tag at the bottom of your computer. See [Service tag on page 12](#) for details.

This chapter provides removal and replacement procedures.

There are as many as 47 screws that must be removed, replaced, or loosened when servicing Authorized Service Provider only parts. Make special note of each screw size and location during removal and replacement.

### Bottom cover

Description	Spare part number
Bottom cover	842283-001

Before removing the bottom cover, follow these steps:

1. Turn off the computer. If you are unsure whether the computer is off or in Hibernation, turn the computer on, and then shut it down through the operating system.
2. Disconnect the power from the computer by unplugging the power cord from the computer.
3. Disconnect all external devices from the computer.

Remove the bottom cover:

1. Remove the seven Torx T8M2.0×5.0 screws **(1)** and the four Torx T8M2.0×3.5 screws **(2)** that secure the bottom cover to the computer.



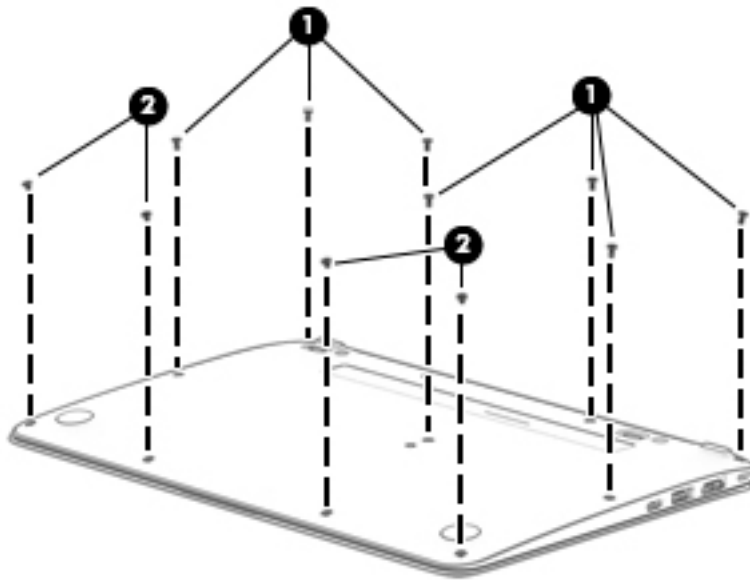

2. Pry up on the top (near the display hinge) of the bottom cover to disengage it from the computer.

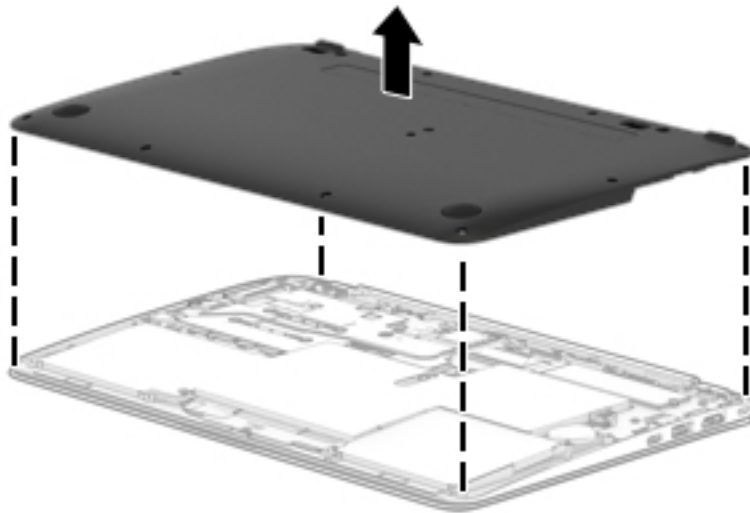

Reverse the removal procedures to install the bottom cover.

When replacing the bottom cover, use the following image to determine the correct screw replacement order. Replacing the screws in the correct order makes sure the bottom cover installs evenly on the computer.

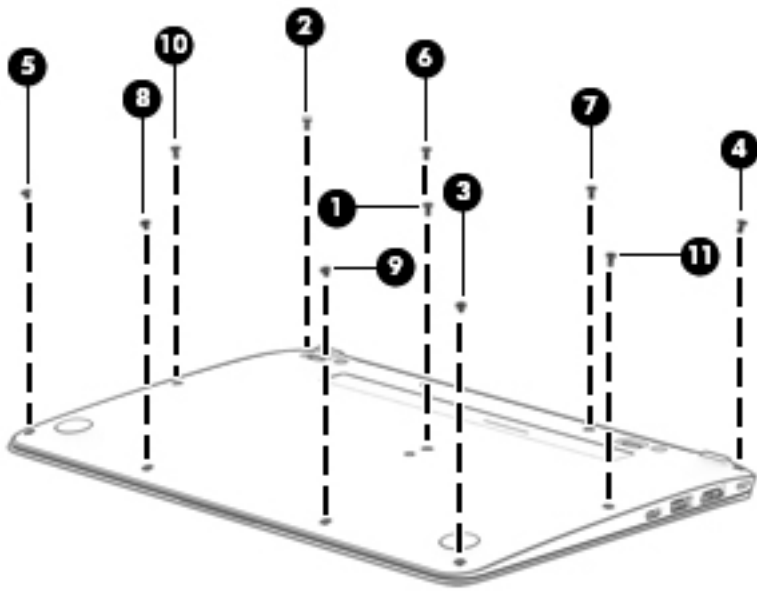

## Keyboard

In this section, the first table provides the main spare part number for the keyboard. The second table provides the country codes.

Description	Spare part number
Keyboard (backlit; includes keyboard cable and backlight cable)	842324-xx1

For use in country or region	Spare part number	For use in country or region	Spare part number	For use in country or region	Spare part number
Belgium	-A41	India	-D61	Saudi Arabia	-171
Brazil	-201	Israel	-BB1	Slovenia	-BA1
Bulgaria	-261	Italy	-061	South Korea	-AD1
Canada	-DB1	Japan	-291	Spain	-071
Czech Republic and Slovakia	-FL1	Latin America	-161	Sweden and Finland	-B71
Denmark	-081	The Netherlands	-B31	Switzerland	-BG1
Denmark, Finland, and Norway	-DH1	Northern Africa	-FP1	Taiwan	-AB1
France	-051	Norway	-091	Thailand	-281
Germany	-041	Portugal	-131	Turkey	-141
Greece	-151	Romania	-271	United Kingdom	-031
Hungary	-211	Russia	-251	United States	-001
Iceland	-DD1				

Before removing the keyboard, follow these steps:

1. Turn off the computer. If you are unsure whether the computer is off or in Hibernation, turn the computer on, and then shut it down through the operating system.
2. Disconnect the power from the computer by unplugging the power cord from the computer.
3. Disconnect all external devices from the computer.
4. Remove the bottom cover (see [Bottom cover on page 24](#)).

5. Disconnect the battery cable.

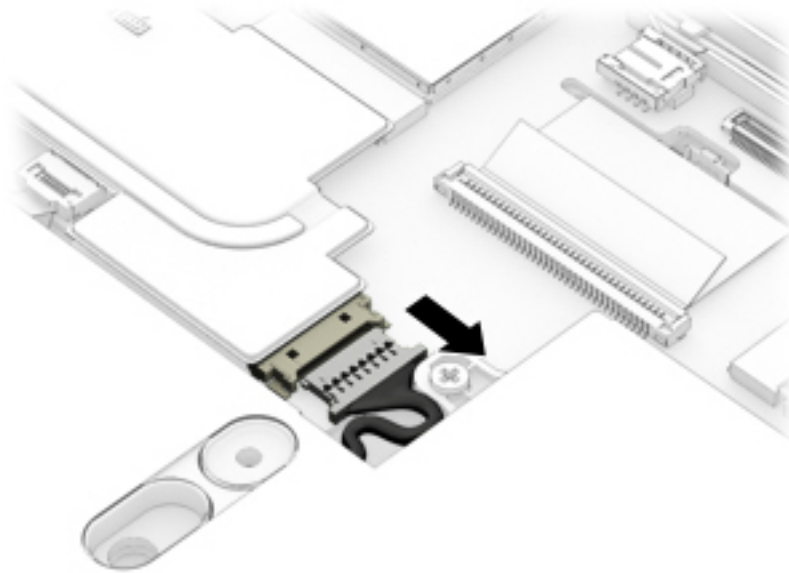

Remove the keyboard:

1. Remove the Phillips PM2.0×2.0 broadhead screw **(1)** that secures the keyboard to the computer.
2. Disconnect the keyboard backlight cable from the system board **(2)**.

3. Disconnect the main keyboard cable from the system board (3).

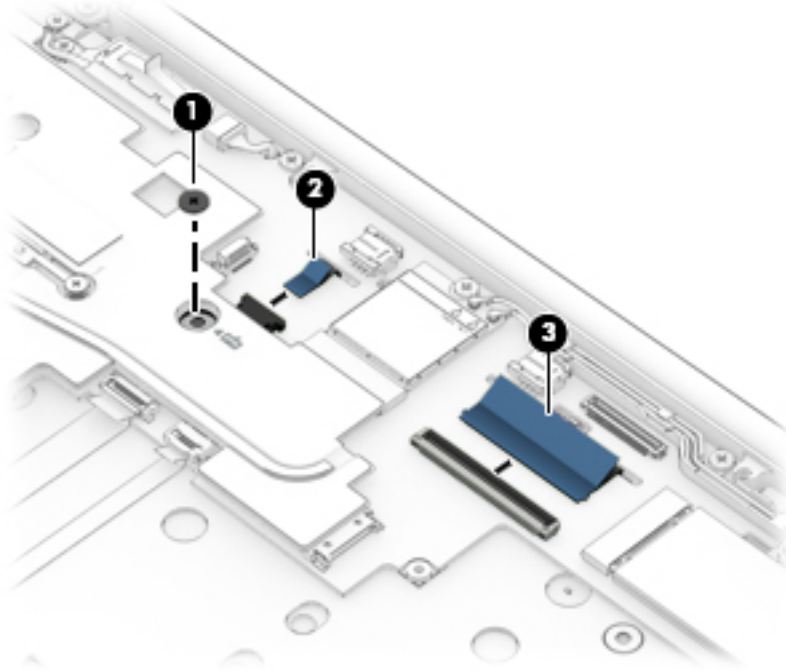

4. Position the computer on its side and open.
5. Insert a screwdriver or similar thin tool into the screw boss of the screw removed in the previous step, and then press on the back of the keyboard until it disengages from the computer.

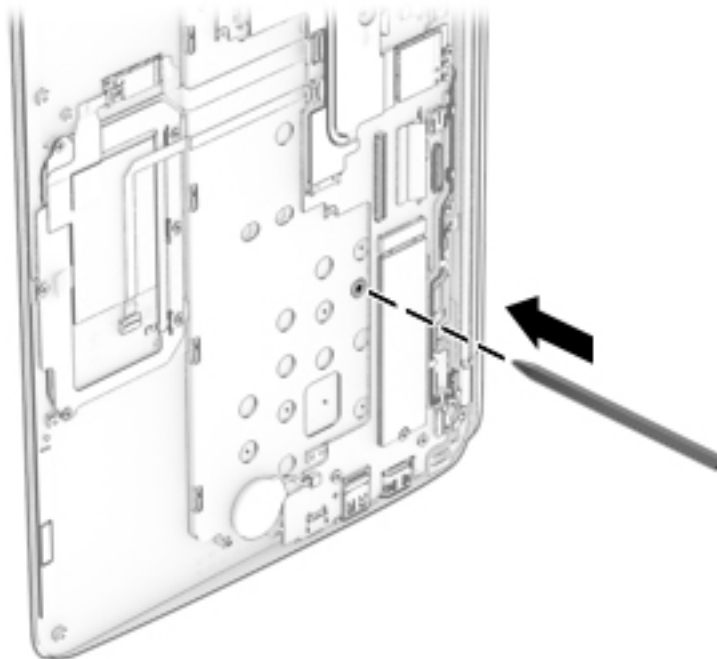

6. Lift the main keyboard cable **(1)** and the keyboard backlight cable **(2)** from the slits in the computer, and then remove the keyboard **(3)**.



Reverse this procedure to install the keyboard.

## Solid-state drive

Description	Spare part number
<b>Solid-state drive, M.2</b>	
512-GB, MLC	842300-001
256-GB, SED, OPAL2	842298-001
256-GB, TLC	842610-001
256-GB, PCIe, NVMe, MLC	842299-001
240-GB, MLC	842611-001
180-GB, MLC	842296-001
180-GB, SED, OPAL2	842297-001
128-GB, TLC	842295-001

Before removing the solid-state drive, follow these steps:

1. Turn off the computer. If you are unsure whether the computer is off or in Hibernation, turn the computer on, and then shut it down through the operating system.
2. Disconnect the power from the computer by unplugging the power cord from the computer.
3. Disconnect all external devices from the computer.
4. Remove the bottom cover (see [Bottom cover on page 24](#)).

5. Disconnect the battery cable.

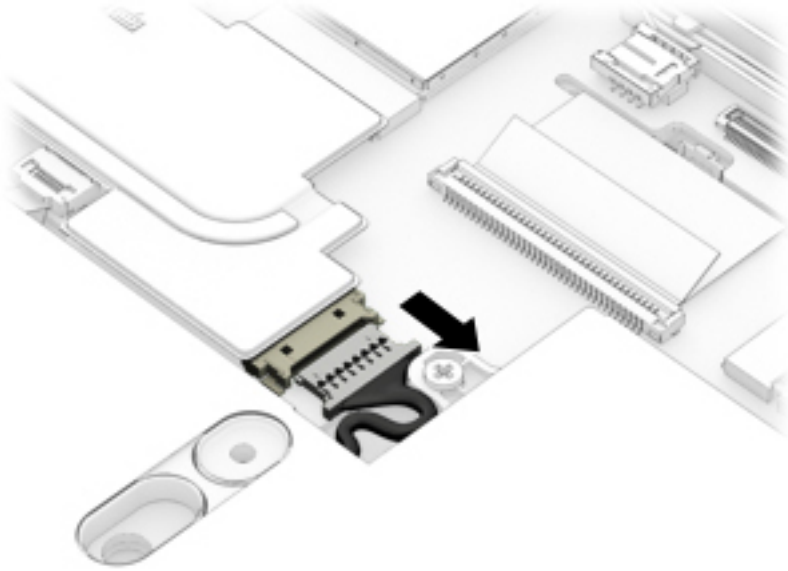

Remove the solid-state drive:

1. Remove the Phillips PM2.0×2.0 screw (1) that secures the drive to the system board.
2. Remove the drive (2) by pulling it away from the connector.

 **NOTE:** Solid-state drive drives are designed with notches to prevent incorrect insertion.

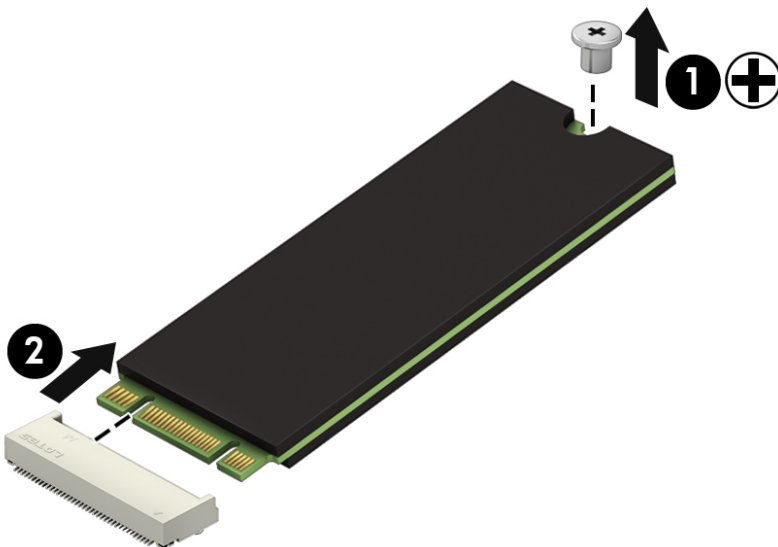

Reverse this procedure to reassemble and install the solid-state drive.



## WLAN module

Description	Spare part number
Intel Dual Band Wireless-AC 8260; 802.11ac, 2x2 + Bluetooth 4.2	806721-005

**CAUTION:** To prevent an unresponsive system, replace the wireless module only with a wireless module authorized for use in the computer by the governmental agency that regulates wireless devices in your country or region. If you replace the module and then receive a warning message, remove the module to restore device functionality, and then contact technical support.

Before removing the WLAN module, follow these steps:

1. Turn off the computer. If you are unsure whether the computer is off or in Hibernation, turn the computer on, and then shut it down through the operating system.
2. Disconnect the power from the computer by unplugging the power cord from the computer.
3. Disconnect all external devices from the computer.
4. Remove the bottom cover (see [Bottom cover on page 24](#)).
5. Disconnect the battery cable.

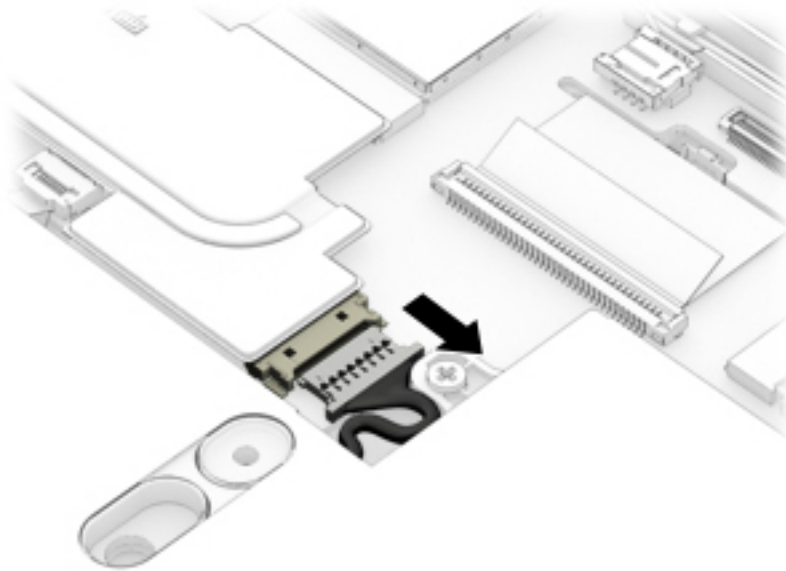

Remove the WLAN module:

1. Disconnect the WLAN antenna cables **(1)** from the terminals on the WLAN module.

---

 **NOTE:** The WLAN antenna cable labeled “1” connects to the WLAN module “Main” terminal labeled “1”. The WLAN antenna cable labeled “2” connects to the WLAN module “Aux” terminal labeled “2”. If the computer is equipped with an 802.11a/b/g/n WLAN module, the yellow WLAN antenna cable connects to the middle terminal on the WLAN module.

---

2. Remove the Phillips PM2.0×1.8 screw **(2)** that secures the WLAN module to the system board. (The WLAN module tilts up.)
3. Remove the WLAN module **(3)** by pulling the module away from the slot at an angle.

---

 **NOTE:** WLAN modules are designed with a notch to prevent incorrect insertion.

---

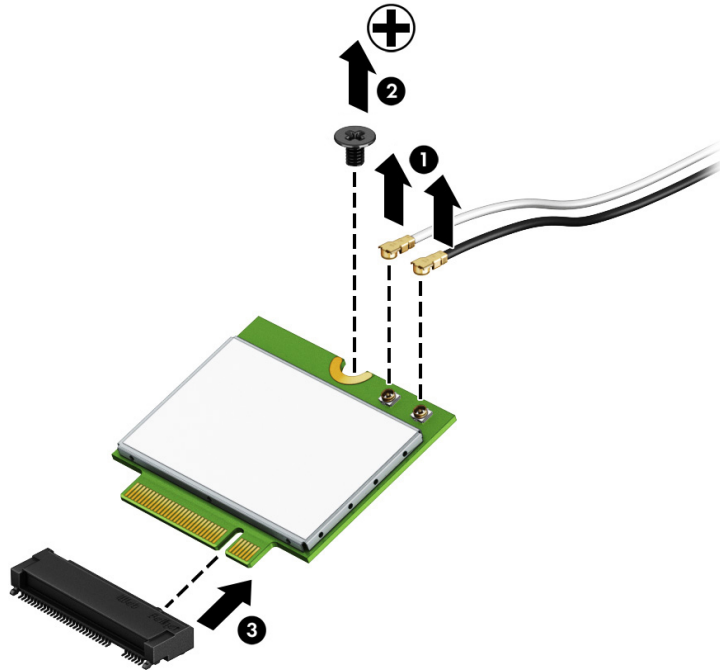

---

 **NOTE:** If the WLAN antennas are not connected to the terminals on the WLAN module, the protective sleeves must be installed on the antenna connectors, as shown in the following illustration.

---

Reverse this procedure to install the WLAN module.

## Display assembly

This section describes removing components that require you to completely remove the display panel. You can remove the display bezel, webcam, and display panel without removing the entire display hinge-up from the computer.

Before removing the display assembly, follow these steps:

1. Turn off the computer. If you are unsure whether the computer is off or in Hibernation, turn the computer on, and then shut it down through the operating system.
2. Disconnect the power from the computer by unplugging the power cord from the computer.
3. Disconnect all external devices from the computer.
4. Remove the bottom cover (see [Bottom cover on page 24](#)).
5. Disconnect the battery cable.

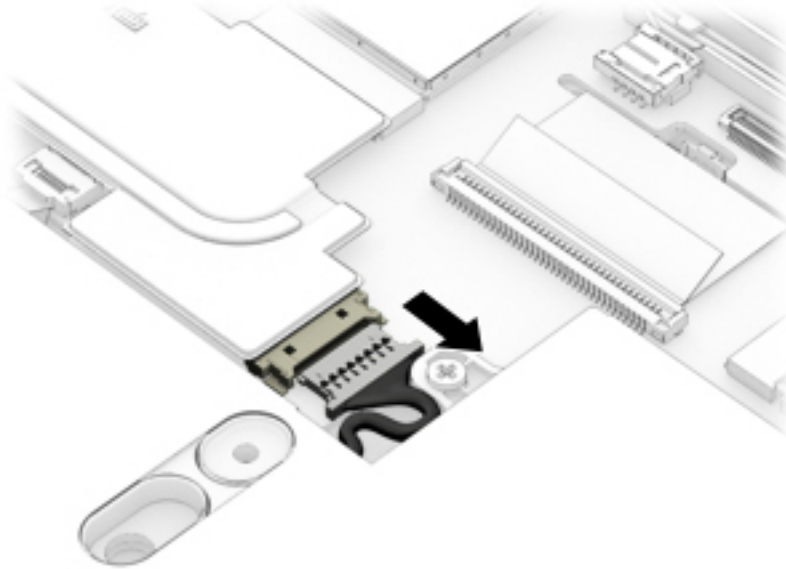

Remove the display assembly:

1. Open the computer and position it with the base enclosure on a table and the display hanging down.
2. To remove the left display bracket, remove the cable from the bracket **(1)**.

3. Remove the two Phillips PM2.5×4.0 screws **(2)** that secure the bracket on the left side of the computer, and then remove the bracket **(3)**.

The display brackets are available in the Bracket Kit using spare part number 842302-001.

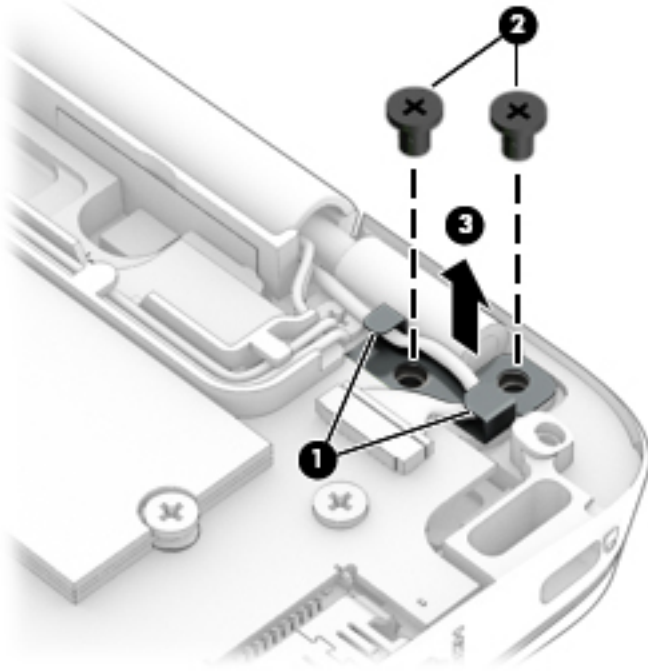

4. To remove the right display bracket, remove the Phillips PM2.0×2.0 screw **(1)** that secures the display bracket to the right side of the computer, and then remove the bracket **(2)**.

The display brackets are available in the Bracket Kit using spare part number 842302-001.

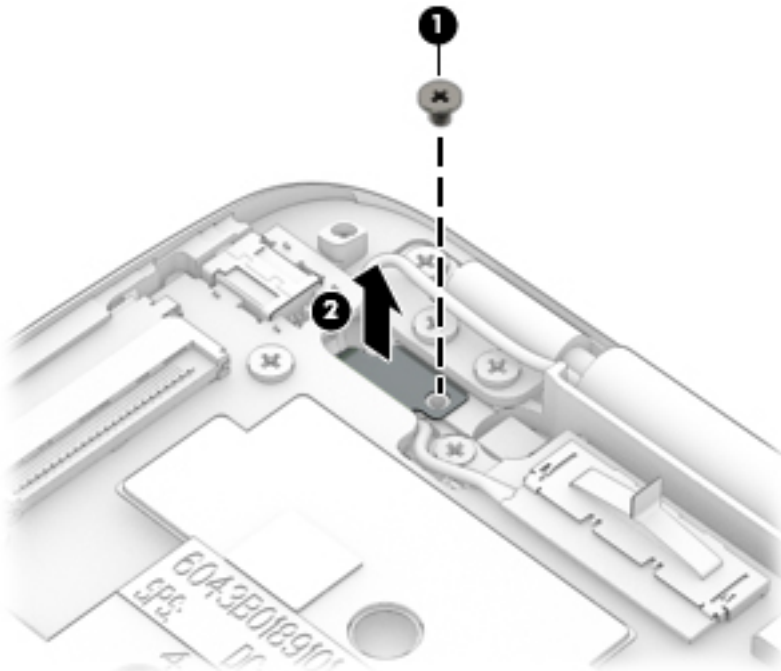

5. Disconnect the display cable from the system board **(1)**.

6. Disconnect the antennas from the WLAN module (2).
7. Remove the WLAN antenna from the clips and routing path built into the computer (3).
8. Disconnect the webcam cable from the system board (4).

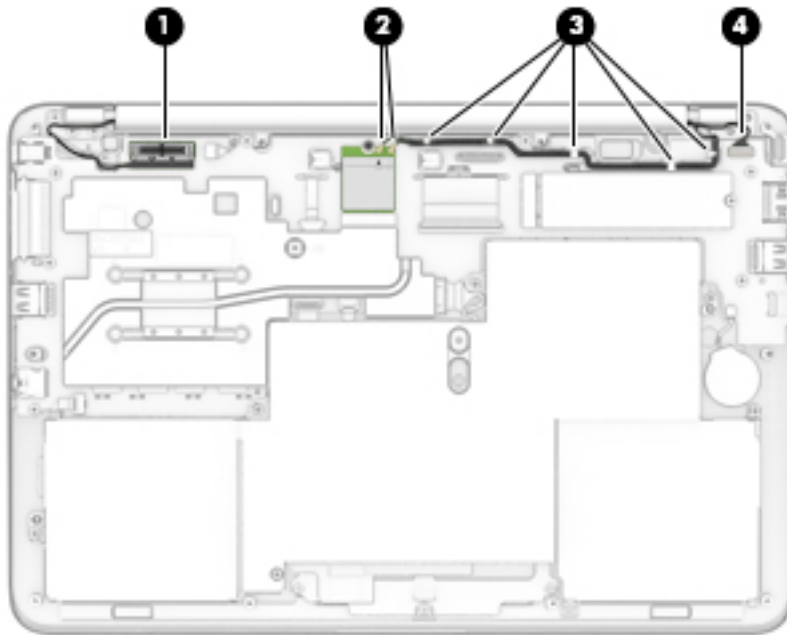

9. Remove the four Phillips PM2.5×4.0 screws (1) that secure the display to the computer.
10. Open the computer so the display is at an approximate 90 degree angle (2).

11. Remove the computer from the display assembly (3).

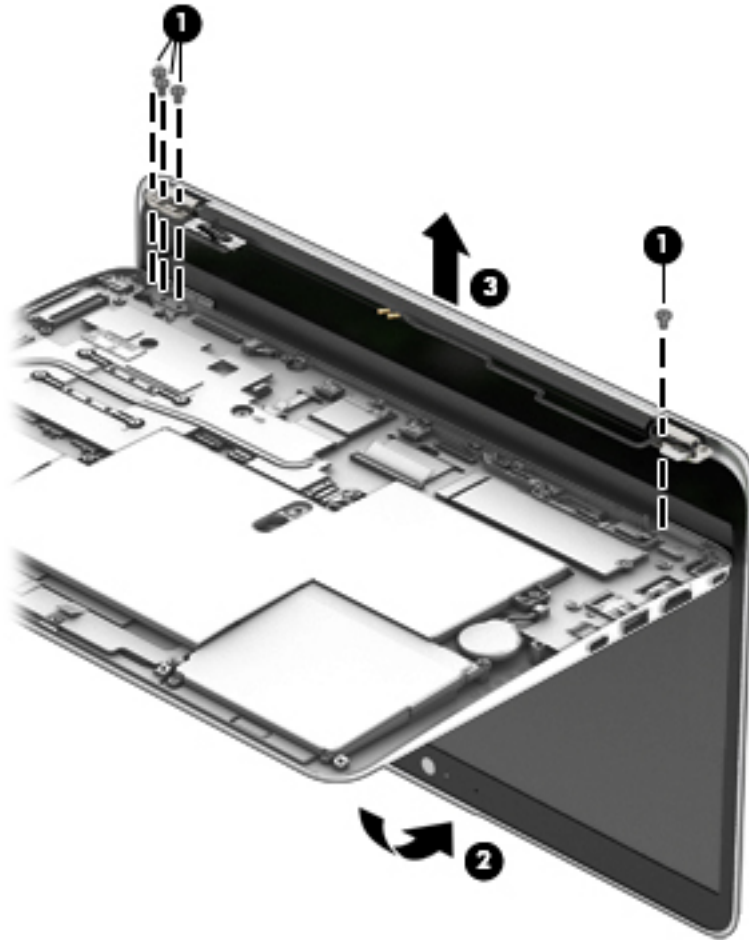

Reverse this procedure to reassemble and install the display assembly.

## RTC battery

Description	Spare part number
RTC battery (includes double-sided tape)	702853-001

Before removing the RTC battery, follow these steps:

1. Turn off the computer. If you are unsure whether the computer is off or in Hibernation, turn the computer on, and then shut it down through the operating system.
2. Disconnect the power from the computer by unplugging the power cord from the computer.
3. Disconnect all external devices from the computer.
4. Remove the bottom cover (see [Bottom cover on page 24](#)).
5. Disconnect the battery cable.

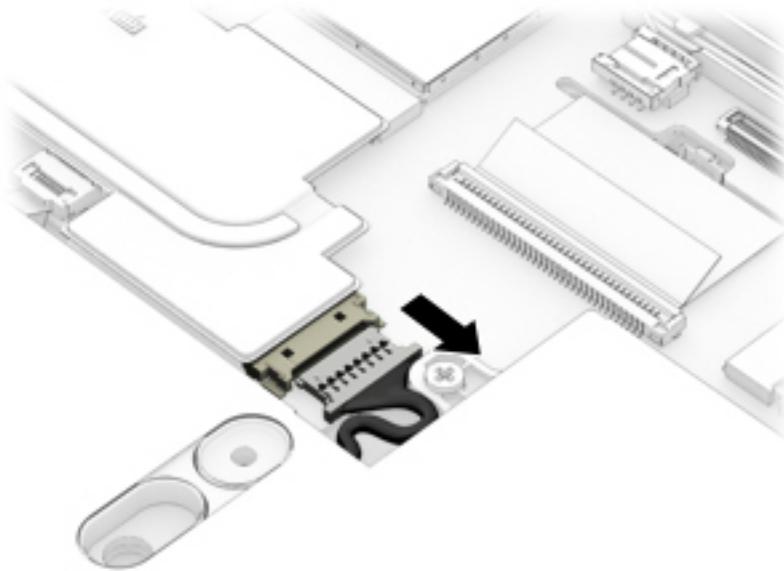

Remove the RTC battery:

1. Disconnect the RTC battery cable **(1)** from the system board.

2. Detach the RTC battery (2) from the computer.

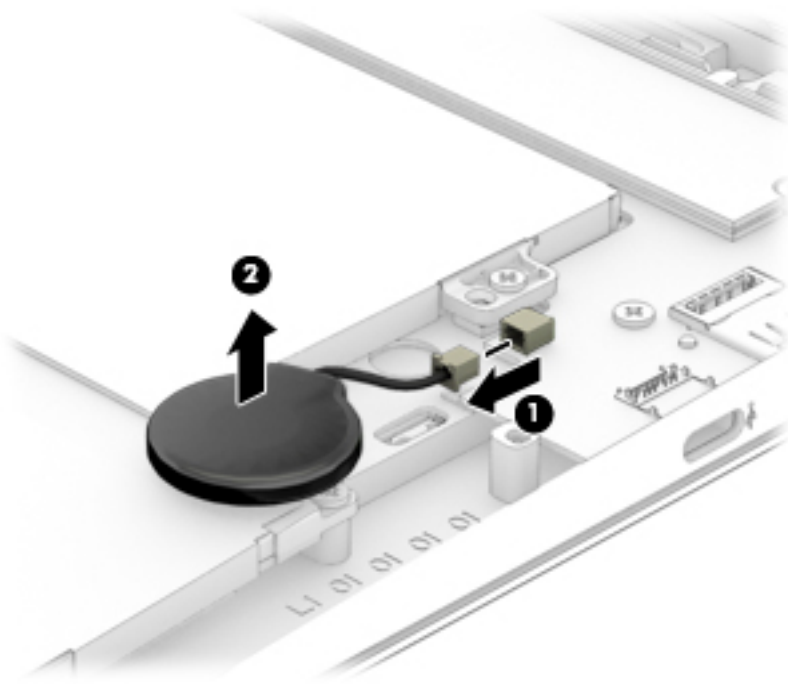

Reverse this procedure to install the RTC battery.



## Heat sink



**NOTE:** The heat sink assembly spare part kit includes replacement thermal material.

Description	Spare part number
Heat sink assembly	842301-001

Before removing the heat sink, follow these steps:

1. Turn off the computer. If you are unsure whether the computer is off or in Hibernation, turn the computer on, and then shut it down through the operating system.
2. Disconnect the power from the computer by unplugging the power cord from the computer.
3. Disconnect all external devices from the computer.
4. Remove the bottom cover (see [Bottom cover on page 24](#)).
5. Disconnect the battery cable.

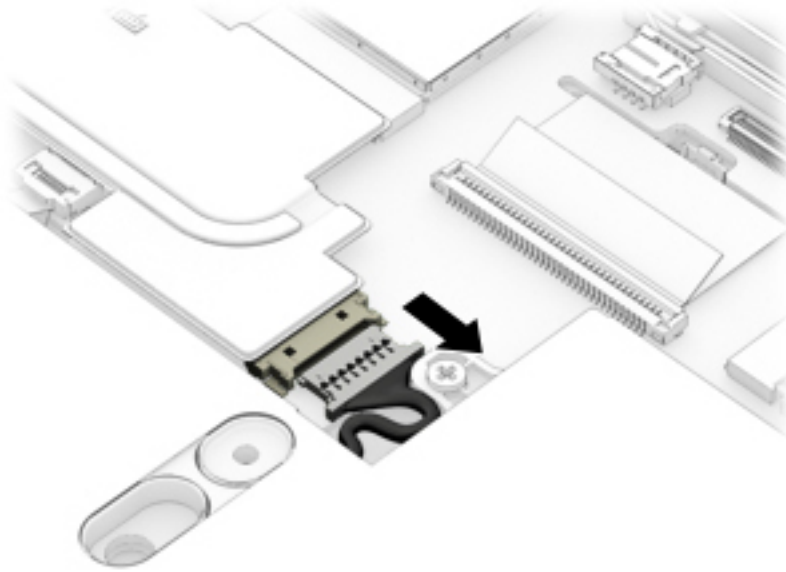

Remove the heat sink:

1. Following the sequence stamped into the heat sink, loosen the four captive Phillips screws **(1)** that secure the heat sink to the system board.

2. Remove the heat sink (2).

**CAUTION:** Take extreme care when removing the heat sink. The heatpipe is very fragile and can be easily damaged and bent during removal.

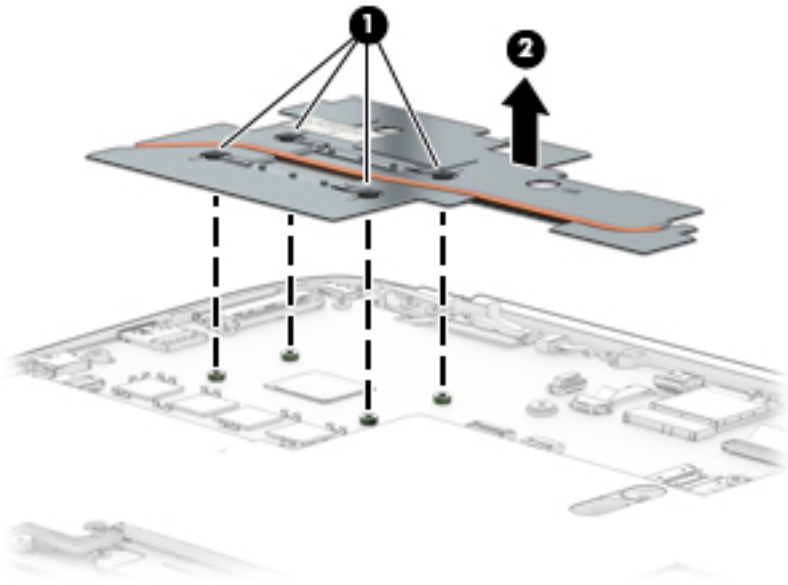

**NOTE:** The thermal material must be thoroughly cleaned from the surfaces of the heat sink and the system board components each time the heat sink is removed. Replacement thermal material is included with the heat sink, processor, and system board spare part kits.

The following illustration shows the replacement thermal material locations. Thermal paste is used on the processor (1) and the heat sink (2).

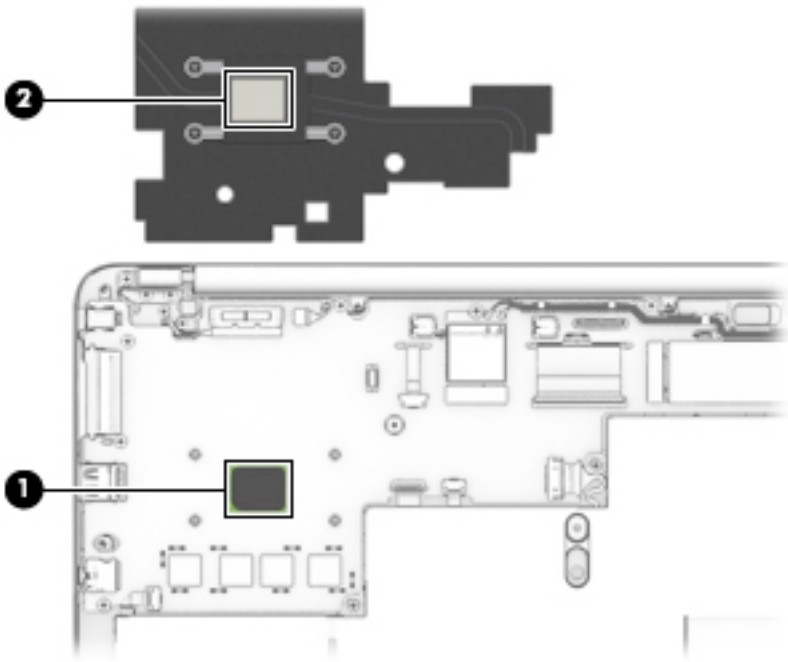

Reverse this procedure to install the heat sink assembly.

## Battery

Description	Spare part number
4-cell, 40-Wh, 2.6-Ah, Li ion battery	826038-005

Before disassembling the computer, follow these steps:

1. Turn off the computer. If you are unsure whether the computer is off or in Hibernation, turn the computer on, and then shut it down through the operating system.
2. Disconnect the power from the computer by unplugging the power cord from the computer.
3. Disconnect all external devices from the computer.
4. Remove the bottom cover (see [Bottom cover on page 24](#)).

Remove the battery:

1. Disconnect the battery cable from the system board.

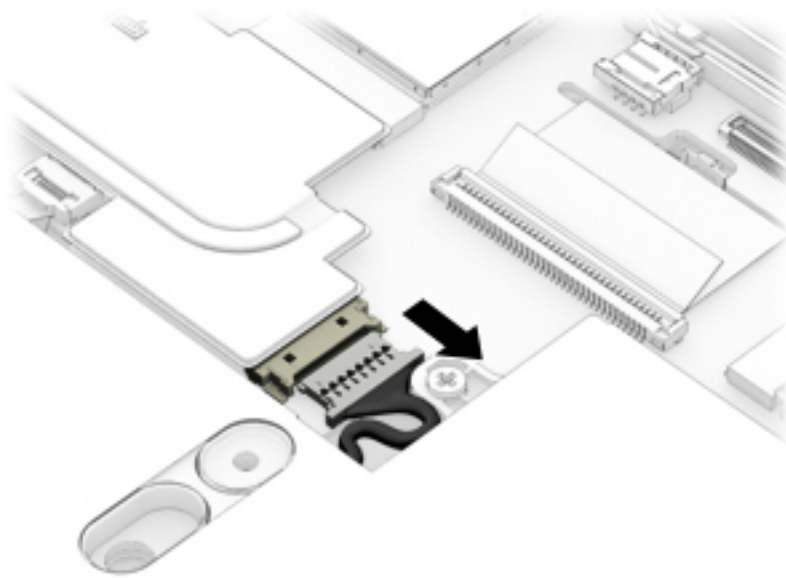

2. Remove the six Phillips PM2.0×4.0 screws **(1)** that secure the battery to the computer.

3. Lift the battery out of the computer (2).

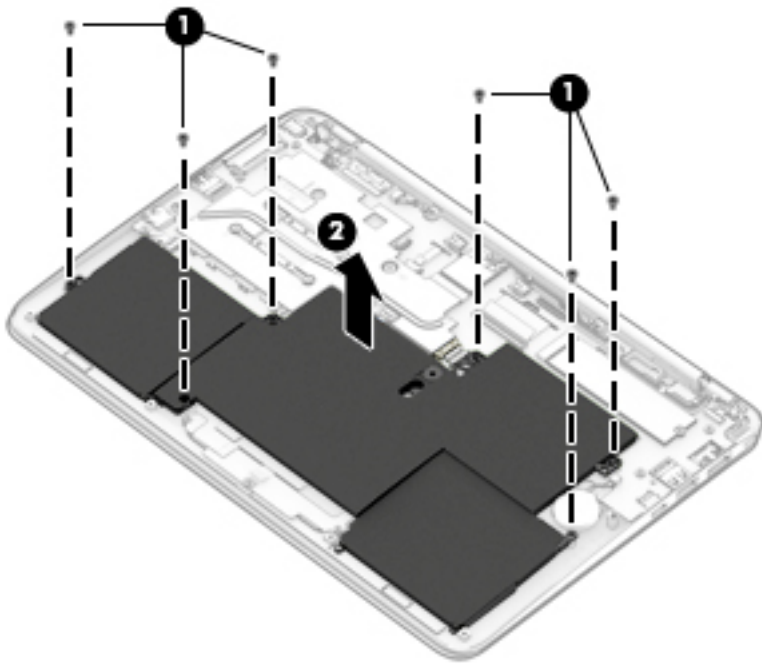

## Fingerprint reader board

Description	Spare part number
Fingerprint reader board (includes cable)	790074-001

Before removing the fingerprint reader board, follow these steps:

1. Turn off the computer. If you are unsure whether the computer is off or in Hibernation, turn the computer on, and then shut it down through the operating system.
2. Disconnect the power from the computer by unplugging the power cord from the computer.
3. Disconnect all external devices from the computer.
4. Remove the bottom cover (see [Bottom cover on page 24](#)).
5. Remove the battery (see [Battery on page 43](#)).

Remove the fingerprint reader board:

1. Disconnect the cable from the system board (1).
2. Remove the Phillips PM2.0×2.0 broadhead screw (2) that secures the assembly to the computer.
3. Remove the bracket from atop the fingerprint reader board (3).  
The fingerprint reader bracket is available in the Bracket Kit using spare part number 842302-001.
4. Remove the fingerprint reader board and cable from the computer (4).

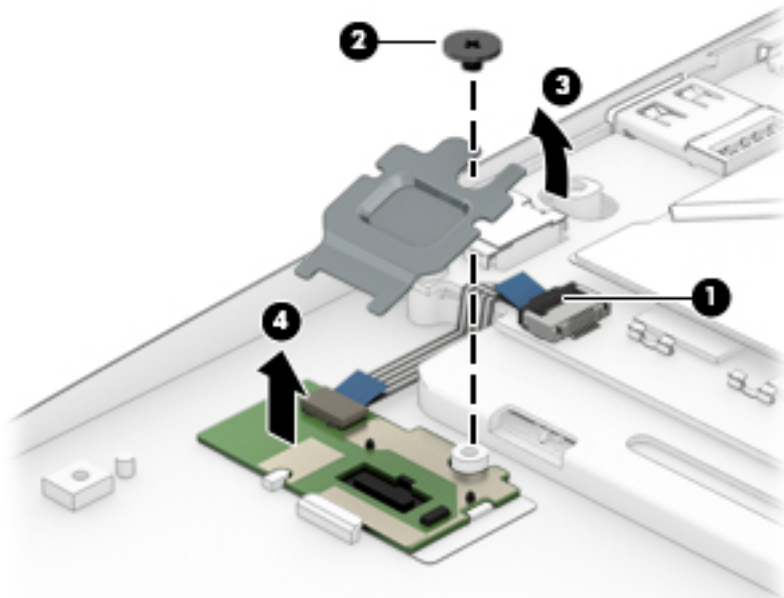

Reverse this procedure to install the fingerprint reader board.

## NFC module

Description	Spare part number
NFC (Near Field Communication) module	790069-001
NFC cable kit (includes NFC cable and antenna)	842323-001

Before removing the NFC module, follow these steps:

1. Turn off the computer. If you are unsure whether the computer is off or in Hibernation, turn the computer on, and then shut it down through the operating system.
2. Disconnect the power from the computer by unplugging the power cord from the computer.
3. Disconnect all external devices from the computer.
4. Remove the bottom cover (see [Bottom cover on page 24](#)).
5. Remove the battery (see [Battery on page 43](#)).

Remove the NFC module:

1. Disconnect the cable from the NFC module **(1)**.
2. Disconnect the antenna from the NFC module **(2)**.
3. Use a flat tool to pry the module up **(3)**, and the lift it from the computer **(4)**.



**NOTE:** The NFC module cable and NFC antenna are available in the NFC Cable Kit, spare part number 842323-001.

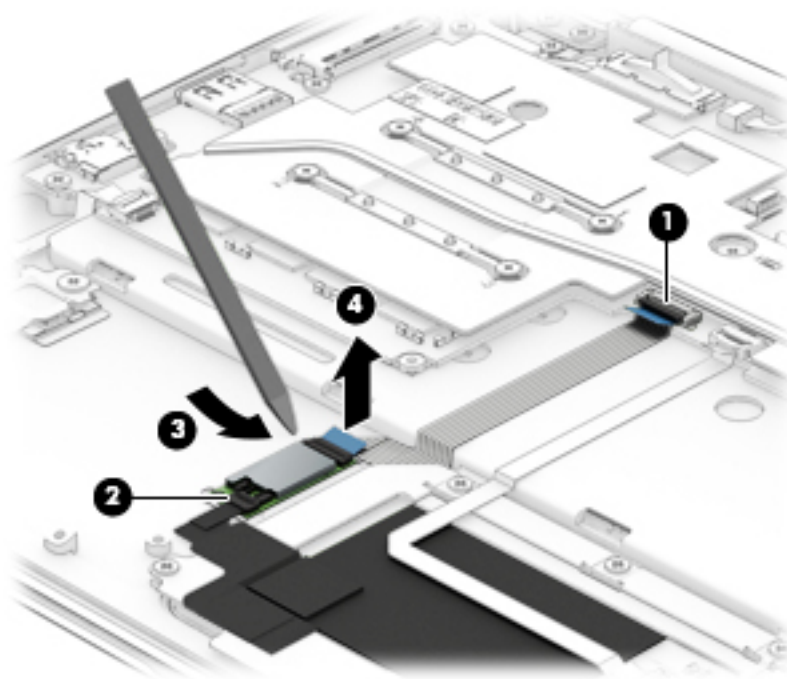

Reverse the removal procedures to install the NFC module.

## ForcePad (Touchpad)

Description	Spare part number
ForcePad	842287-001
Cable Kit	842293-001

Before removing the ForcePad, follow these steps:

1. Turn off the computer. If you are unsure whether the computer is off or in Hibernation, turn the computer on, and then shut it down through the operating system.
2. Disconnect the power from the computer by unplugging the power cord from the computer.
3. Disconnect all external devices from the computer.
4. Remove the bottom cover (see [Bottom cover on page 24](#)).
5. Remove the battery (see [Battery on page 43](#)).

Remove the ForcePad:

1. Disconnect the ForcePad cable **(1)** from the system board.
2. Disconnect the NFC module antenna cable **(2)** from the ForcePad.
3. Remove the six Phillips PM2.0×2.0 broadhead screws **(3)** that secure the ForcePad to the computer, and then lift the ForcePad from the computer **(4)**.

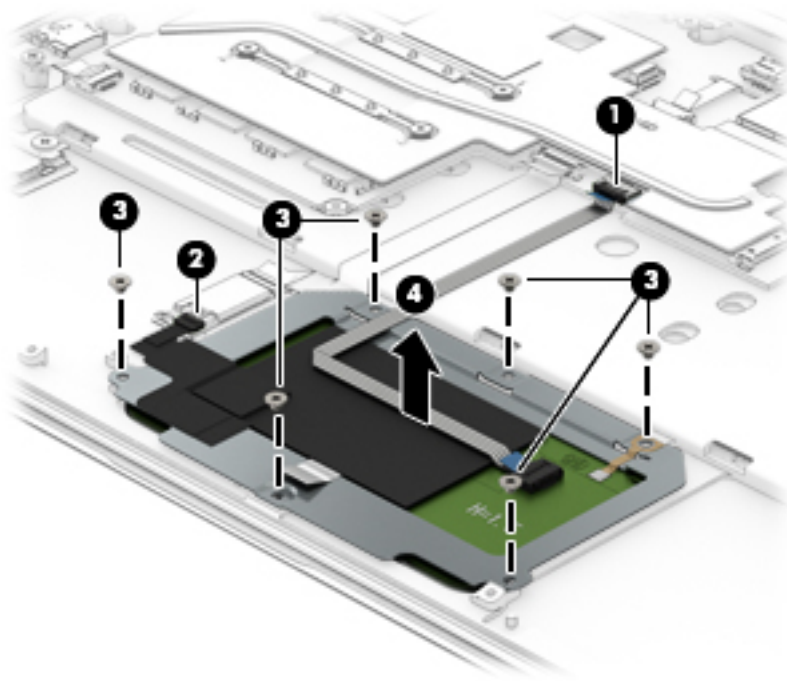

Reverse the removal procedures to install the ForcePad.

## System board



**NOTE:** The system board spare part kit includes replacement thermal material.

All system boards use the following part numbers:

xxxxxx-001: Windows 7 or non-Windows operating systems

xxxxxx-601: Windows 10 operating system

Description	Spare part number
System board equipped with Intel Core M7-6Y75 processor	842326-xxx
System board equipped with Intel Core M5-6Y57 processor	842328-xxx
System board equipped with 8 GB of system memory and an Intel Core M5-6Y57 processor	842327-xxx
System board equipped with 8 GB of system memory and an Intel Core M5-6Y54 processor	842325-xxx
Plastics Kit (includes system board clip)	860705-001

Before removing the system board, follow these steps:

1. Turn off the computer. If you are unsure whether the computer is off or in Hibernation, turn the computer on, and then shut it down through the operating system.
2. Disconnect the power from the computer by unplugging the power cord from the computer.
3. Disconnect all external devices from the computer.
4. Remove the bottom cover (see [Bottom cover on page 24](#)).
5. Remove the battery (see [Battery on page 43](#)).
6. When replacing the system board, be sure that the following components are removed from the defective system board and installed on the replacement system board:
  - Solid-state drive (see [Solid-state drive on page 31](#))
  - WLAN module (see [WLAN module on page 33](#))
  - Heat sink (see [Heat sink on page 41](#))

Remove the system board:

1. Disconnect the following cables:
  - (1): Display panel
  - (2): Speaker
  - (3): Keyboard (backlight)
  - (4): Wireless antennas
  - (5): Keyboard (primary)
  - (6): Webcam
  - (7): Fingerprint reader
  - (8): NFC module
  - (9): ForcePad



**(10):** RTC battery

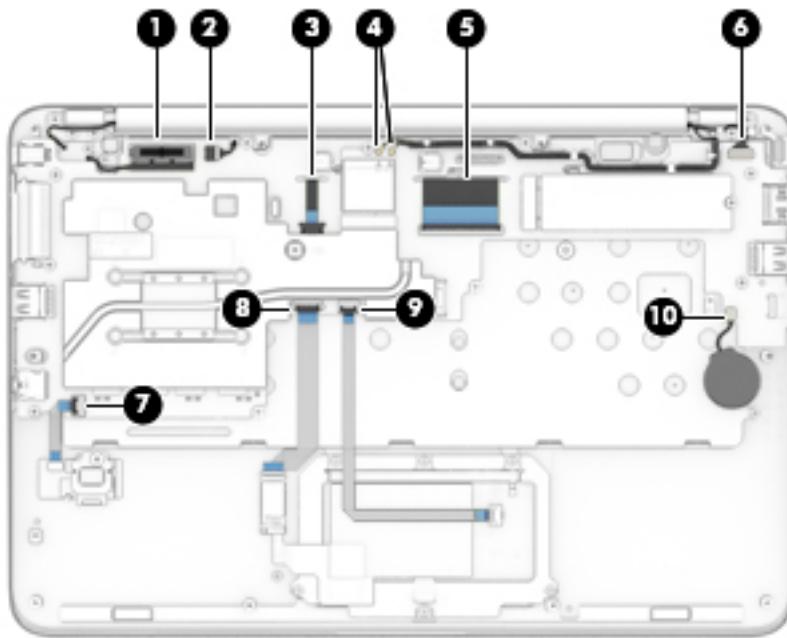

2. Remove the WLAN antenna from the routing channel on the system board **(1)**.
3. Remove the seven Phillips PM2.0×4.0 screws **(2)** that secure the system board to the computer.

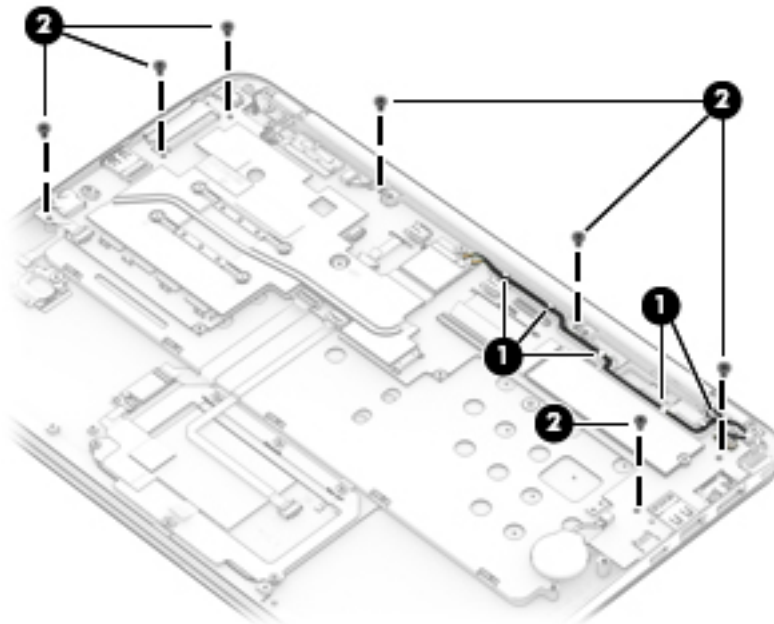

4. Lift the right side of the system board up at an angle **(1)**.

**⚠ CAUTION:** To avoid damaging or breaking the system board, use two hands when removing the board. Do not lift up on the narrow end of the board.

5. Pull the system board away from and out of the computer **(2)**, making sure the connectors on the side of the board are clear of the computer.

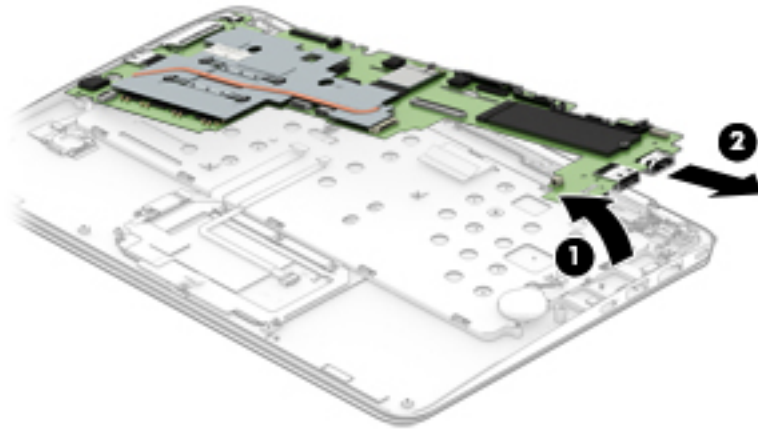

Reverse this procedure to install the system board.

## Speaker assembly

Description	Spare part number
Speaker assembly (includes cable)	837352-001

Before removing the speaker assembly, follow these steps:

1. Turn off the computer. If you are unsure whether the computer is off or in Hibernation, turn the computer on, and then shut it down through the operating system.
2. Disconnect the power from the computer by unplugging the power cord from the computer.
3. Disconnect all external devices from the computer.
4. Remove the bottom cover (see [Bottom cover on page 24](#)).
5. Remove the battery (see [Battery on page 43](#)).
6. Remove the system board (see [System board on page 48](#)).

Remove the speaker assembly:

1. Remove the three Phillips PM2.0×3.0 screws **(1)** that secure the speaker to the computer.
2. Remove the speaker **(2)** from the computer.

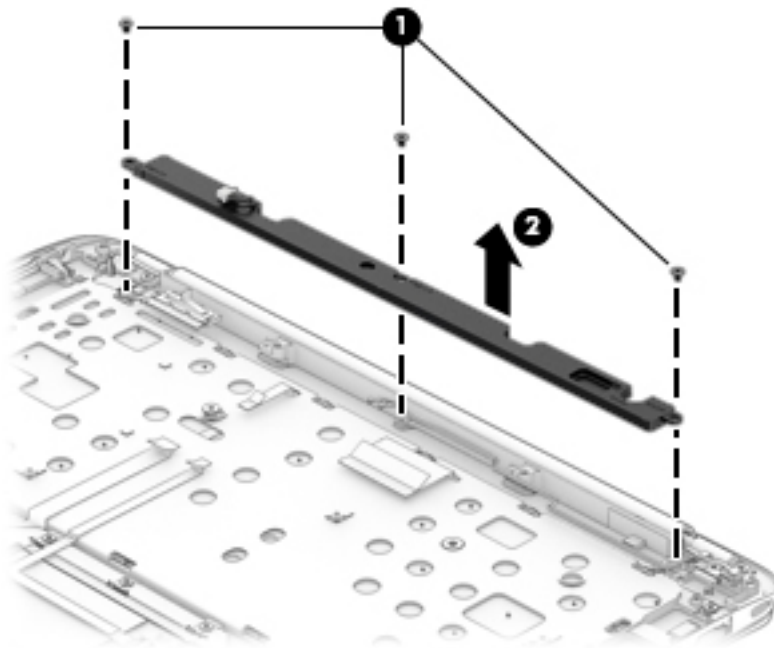

Reverse this procedure to install the speaker.

---

# 6 Computer Setup (BIOS), TPM, and HP Sure Start in Windows 7

## Using Computer Setup

Computer Setup, or Basic Input/Output System (BIOS), controls communication between all the input and output devices on the system (such as disk drives, display, keyboard, mouse, and printer). Computer Setup includes settings for the types of devices installed, the startup sequence of the computer, and the amount of system and extended memory.

---

 **NOTE:** Use extreme care when making changes in Computer Setup. Errors can prevent the computer from operating properly.

---

## Starting Computer Setup

---

 **NOTE:** An external keyboard or mouse connected to a USB port can be used with Computer Setup only if USB legacy support is enabled.

---

To start Computer Setup, follow these steps:

- ▲ Start Computer Setup.
  - Computers or tablets with keyboards:
    - ▲ Turn on or restart the computer, and when the HP logo appears, press **F10** to enter Computer Setup.
  - Tablets without keyboards:
    - ▲ Turn off the tablet. Press the power button in combination with the volume down button until the Startup menu is displayed, and then tap **F10** to enter Computer Setup.

## Navigating and selecting in Computer Setup

- To select a menu or a menu item, use the **tab** key and the keyboard arrow keys and then press **enter**, or use a pointing device to select the item.

---

 **NOTE:** On tablets without keyboards, you can use your finger to make selections.

---

- To scroll up and down, select the up arrow or the down arrow in the upper-right corner of the screen, or use the up arrow key or the down arrow key on the keyboard.
- To close open dialog boxes and return to the main Computer Setup screen, press **esc**, and then follow the on-screen instructions.

To exit Computer Setup menus, choose one of the following methods:

- To exit Computer Setup menus without saving your changes:  
Select the **Exit** icon in the lower-right corner of the screen, and then follow the on-screen instructions.  
– or –  
Select **Main**, select **Ignore Changes and Exit**, and then press [enter](#).
- To save your changes and exit Computer Setup menus:  
Select the **Save** icon in the lower-right corner of the screen, and then follow the on-screen instructions.  
– or –  
Select **Main**, select **Save Changes and Exit**, and then press [enter](#).

Your changes go into effect when the computer restarts.

## Restoring factory settings in Computer Setup

---

 **NOTE:** Restoring defaults will not change the hard drive mode.

---

To return all settings in Computer Setup to the values that were set at the factory, follow these steps:

1. Start Computer Setup. See [Starting Computer Setup on page 52](#).
2. Select **Main**, and then select **Apply Factory Defaults and Exit**.

---

 **NOTE:** On select products, the selections may display **Restore Defaults** instead of **Apply Factory Defaults and Exit**.

---

3. Follow the on-screen instructions.
4. To save your changes and exit, select the **Save** icon in the lower-right corner of the screen, and then follow the on-screen instructions.  
– or –  
Select **Main**, select **Save Changes and Exit**, and then press [enter](#).

Your changes go into effect when the computer restarts.

---

 **NOTE:** Your password settings and security settings are not changed when you restore the factory settings.

---

## Updating the BIOS

Updated versions of the BIOS may be available on the HP website.

Most BIOS updates on the HP website are packaged in compressed files called *SoftPaqs*.

Some download packages contain a file named *Readme.txt*, which contains information regarding installing and troubleshooting the file.

## Determining the BIOS version

To decide whether you need to update Computer Setup (BIOS), first determine the BIOS version on your computer.

BIOS version information (also known as *ROM date* and *System BIOS*) can be accessed by pressing [fn+esc](#) (if you are already in Windows) or by using Computer Setup.

1. Start Computer Setup. See [Starting Computer Setup on page 52](#).
2. Select **Main**, and then select **System Information**.
3. To exit Computer Setup without saving your changes, select the **Exit** icon in the lower-right corner of the screen, and then follow the on-screen instructions.

– or –

Select **Main**, select **Ignore Changes and Exit**, and then press **enter**.

To check for later BIOS versions, see [Downloading a BIOS update on page 54](#).

## Downloading a BIOS update

---

 **CAUTION:** To reduce the risk of damage to the computer or an unsuccessful installation, download and install a BIOS update only when the computer is connected to reliable external power using the AC adapter. Do not download or install a BIOS update while the computer is running on battery power, docked in an optional docking device, or connected to an optional power source. During the download and installation, follow these instructions:

Do not disconnect power on the computer by unplugging the power cord from the AC outlet.

Do not shut down the computer or initiate Sleep.

Do not insert, remove, connect, or disconnect any device, cable, or cord.

---

1. Access Help and Support by selecting **Start > All Programs > HP Help and Support > HP Support Assistant**.
2. Make the selection for updates.
3. Follow the on-screen instructions.
4. At the download area, follow these steps:
  - a. Identify the most recent BIOS update and compare it to the BIOS version currently installed on your computer. Make a note of the date, name, or other identifier. You may need this information to locate the update later, after it has been downloaded to your hard drive.
  - b. Follow the on-screen instructions to download your selection to the hard drive.

Make a note of the path to the location on your hard drive where the BIOS update is downloaded. You will need to access this path when you are ready to install the update.

---

 **NOTE:** If you connect your computer to a network, consult the network administrator before installing any software updates, especially system BIOS updates.

---

BIOS installation procedures vary. Follow any instructions that are revealed on the screen after the download is complete. If no instructions are revealed, follow these steps:

1. Select **Start > Computer**.
2. Select your hard drive designation. The hard drive designation is typically Local Disk (C:).
3. Using the hard drive path you recorded earlier, open the folder that contains the update.
4. Double-click the file that has an .exe extension (for example, *filename.exe*).  
The BIOS installation begins.
5. Complete the installation by following the on-screen instructions.



---

**NOTE:** After a message on the screen reports a successful installation, you can delete the downloaded file from your hard drive.

---

## Changing the boot order using the f9 prompt

To dynamically choose a boot device for the current startup sequence, follow these steps:

1. Access the Boot Device Options menu:
  - Computers or tablets with keyboards:
    - ▲ Turn on or restart the computer, and when the HP logo appears, press **f9** to enter the Boot Device Options menu.
  - Tablets without keyboards:
    - ▲ Turn off the tablet. Press the power button in combination with the volume down button until the Startup menu is displayed, and then tap **F9** to enter the Boot Device Options menu.
2. Select a boot device, then press **enter**.

## TPM BIOS settings (select products only)



---

**IMPORTANT:** Before enabling Trusted Platform Module (TPM) functionality on this system, you must ensure that your intended use of TPM complies with relevant local laws, regulations and policies, and approvals or licenses must be obtained if applicable. For any compliance issues arising from your operation/usage of TPM which violates the above mentioned requirement, you shall bear all the liabilities wholly and solely. HP will not be responsible for any related liabilities.

---

TPM provides additional security for your computer. You can modify the TPM settings in Computer Setup (BIOS).



---

**NOTE:** If you change the TPM setting to Hidden, TPM is not visible in the operating system.

---

To access TPM settings in Computer Setup:

1. Start Computer Setup. See [Starting Computer Setup on page 52](#).
2. Select **Security**, select **TPM Embedded Security**, and then follow the on-screen instructions.

## Using HP Sure Start (select products only)

Select computer models are configured with HP Sure Start, a technology that continuously monitors the computer's BIOS for attacks or corruption. If the BIOS becomes corrupted or is attacked, HP Sure Start automatically restores the BIOS to its previously safe state, without user intervention.

HP Sure Start is configured and already enabled so that most users can use the HP Sure Start default configuration. The default configuration can be customized by advanced users.

To access the latest documentation on HP Sure Start, go to <http://www.hp.com/support>, and select your country. Select **Drivers & Downloads**, and then follow the on-screen instructions.

---

# 7 Computer Setup (BIOS), TPM, and HP Sure Start in Windows 10

## Using Computer Setup

Computer Setup, or Basic Input/Output System (BIOS), controls communication between all the input and output devices on the system (such as disk drives, display, keyboard, mouse, and printer). Computer Setup includes settings for the types of devices installed, the startup sequence of the computer, and the amount of system and extended memory.

---

 **NOTE:** Use extreme care when making changes in Computer Setup. Errors can prevent the computer from operating properly.

---

## Starting Computer Setup

---

 **NOTE:** An external keyboard or mouse connected to a USB port can be used with Computer Setup only if USB legacy support is enabled.

---

To start Computer Setup, follow these steps:

- ▲ Start Computer Setup.
  - Computers or tablets with keyboards:
    - ▲ Turn on or restart the computer, and when the HP logo appears, press **F10** to enter Computer Setup.
  - Tablets without keyboards:
    - ▲ Turn off the tablet. Press the power button in combination with the volume down button until the Startup menu is displayed, and then tap **F10** to enter Computer Setup.

## Navigating and selecting in Computer Setup

- To select a menu or a menu item, use the **tab** key and the keyboard arrow keys and then press **enter**, or use a pointing device to select the item.

---

 **NOTE:** On tablets without keyboards, you can use your finger to make selections.

---

- To scroll up and down, select the up arrow or the down arrow in the upper-right corner of the screen, or use the up arrow key or the down arrow key on the keyboard.
- To close open dialog boxes and return to the main Computer Setup screen, press **esc**, and then follow the on-screen instructions.



To exit Computer Setup menus, choose one of the following methods:

- To exit Computer Setup menus without saving your changes:  
Select the **Exit** icon in the lower-right corner of the screen, and then follow the on-screen instructions.  
– or –  
Select **Main**, select **Ignore Changes and Exit**, and then press [enter](#).
- To save your changes and exit Computer Setup menus:  
Select the **Save** icon in the lower-right corner of the screen, and then follow the on-screen instructions.  
– or –  
Select **Main**, select **Save Changes and Exit**, and then press [enter](#).

Your changes go into effect when the computer restarts.

## Restoring factory settings in Computer Setup

---

 **NOTE:** Restoring defaults will not change the hard drive mode.

---

To return all settings in Computer Setup to the values that were set at the factory, follow these steps:

1. Start Computer Setup. See [Starting Computer Setup on page 52](#).
2. Select **Main**, and then select **Apply Factory Defaults and Exit**.

---

 **NOTE:** On select products, the selections may display **Restore Defaults** instead of **Apply Factory Defaults and Exit**.

---

3. Follow the on-screen instructions.
4. To save your changes and exit, select the **Save** icon in the lower-right corner of the screen, and then follow the on-screen instructions.  
– or –  
Select **Main**, select **Save Changes and Exit**, and then press [enter](#).

Your changes go into effect when the computer restarts.

---

 **NOTE:** Your password settings and security settings are not changed when you restore the factory settings.

---

## Updating the BIOS

Updated versions of the BIOS may be available on the HP website.

Most BIOS updates on the HP website are packaged in compressed files called *SoftPaqs*.

Some download packages contain a file named *Readme.txt*, which contains information regarding installing and troubleshooting the file.

## Determining the BIOS version

To decide whether you need to update Computer Setup (BIOS), first determine the BIOS version on your computer.

BIOS version information (also known as *ROM date* and *System BIOS*) can be accessed by pressing [fn+esc](#) (if you are already in Windows) or by using Computer Setup.

1. Start Computer Setup. See [Starting Computer Setup on page 52](#).
2. Select **Main**, and then select **System Information**.
3. To exit Computer Setup without saving your changes, select the **Exit** icon in the lower-right corner of the screen, and then follow the on-screen instructions.

– or –

Select **Main**, select **Ignore Changes and Exit**, and then press **enter**.

To check for later BIOS versions, see [Downloading a BIOS update on page 58](#).

## Downloading a BIOS update

---

 **CAUTION:** To reduce the risk of damage to the computer or an unsuccessful installation, download and install a BIOS update only when the computer is connected to reliable external power using the AC adapter. Do not download or install a BIOS update while the computer is running on battery power, docked in an optional docking device, or connected to an optional power source. During the download and installation, follow these instructions:

Do not disconnect power on the computer by unplugging the power cord from the AC outlet.

Do not shut down the computer or initiate Sleep.

Do not insert, remove, connect, or disconnect any device, cable, or cord.

---

1. Type `support` in the taskbar search box, and then select the HP Support Assistant app.  
– or –  
Select the question mark icon in the taskbar.
2. Select **Updates**, and then select **Check for updates and messages**.
3. Follow the on-screen instructions.
4. At the download area, follow these steps:
  - a. Identify the most recent BIOS update and compare it to the BIOS version currently installed on your computer. Make a note of the date, name, or other identifier. You may need this information to locate the update later, after it has been downloaded to your hard drive.
  - b. Follow the on-screen instructions to download your selection to the hard drive.  
  
Make a note of the path to the location on your hard drive where the BIOS update is downloaded. You will need to access this path when you are ready to install the update.

---

 **NOTE:** If you connect your computer to a network, consult the network administrator before installing any software updates, especially system BIOS updates.

---

BIOS installation procedures vary. Follow any instructions that are revealed on the screen after the download is complete. If no instructions are revealed, follow these steps:

1. Type `file` in the taskbar search box, and then select **File Explorer**.
2. Select your hard drive designation. The hard drive designation is typically Local Disk (C:).
3. Using the hard drive path you recorded earlier, open the folder that contains the update.
4. Double-click the file that has an `.exe` extension (for example, `filename.exe`).  
  
The BIOS installation begins.
5. Complete the installation by following the on-screen instructions.



---

**NOTE:** After a message on the screen reports a successful installation, you can delete the downloaded file from your hard drive.

---

## Changing the boot order using the f9 prompt

To dynamically choose a boot device for the current startup sequence, follow these steps:

1. Access the Boot Device Options menu:
  - Computers or tablets with keyboards:
    - ▲ Turn on or restart the computer, and when the HP logo appears, press **f9** to enter the Boot Device Options menu.
  - Tablets without keyboards:
    - ▲ Turn off the tablet. Press the power button in combination with the volume down button until the Startup menu is displayed, and then tap **F9** to enter the Boot Device Options menu.
2. Select a boot device, then press **enter**.

## TPM BIOS settings (select products only)



---

**IMPORTANT:** Before enabling Trusted Platform Module (TPM) functionality on this system, you must ensure that your intended use of TPM complies with relevant local laws, regulations and policies, and approvals or licenses must be obtained if applicable. For any compliance issues arising from your operation/usage of TPM which violates the above mentioned requirement, you shall bear all the liabilities wholly and solely. HP will not be responsible for any related liabilities.

---

TPM provides additional security for your computer. You can modify the TPM settings in Computer Setup (BIOS).



---

**NOTE:** If you change the TPM setting to Hidden, TPM is not visible in the operating system.

---

To access TPM settings in Computer Setup:

1. Start Computer Setup. See [Starting Computer Setup on page 52](#).
2. Select **Security**, select **TPM Embedded Security**, and then follow the on-screen instructions.

## Using HP Sure Start (select products only)

Select computer models are configured with HP Sure Start, a technology that continuously monitors the computer's BIOS for attacks or corruption. If the BIOS becomes corrupted or is attacked, HP Sure Start automatically restores the BIOS to its previously safe state, without user intervention.

HP Sure Start is configured and already enabled so that most users can use the HP Sure Start default configuration. The default configuration can be customized by advanced users.

To access the latest documentation on HP Sure Start, go to <http://www.hp.com/support>, and select your country. Select **Drivers & Downloads**, and then follow the on-screen instructions.

---

## 8 Using HP PC Hardware Diagnostics (UEFI)

HP PC Hardware Diagnostics is a Unified Extensible Firmware Interface (UEFI) that allows you to run diagnostic tests to determine whether the computer hardware is functioning properly. The tool runs outside the operating system so that it can isolate hardware failures from issues that are caused by the operating system or other software components.

When HP PC Hardware Diagnostics (UEFI) detects a failure that requires hardware replacement, a 24-digit Failure ID code is generated. This ID code can then be provided to support to help determine how to correct the problem.

---

 **NOTE:** To start diagnostics on a convertible computer, your computer must be in notebook mode and you must use the keyboard attached.

---

To start HP PC Hardware Diagnostics (UEFI), follow these steps:

1. Turn on or restart the computer, and quickly press *esc*.
2. Press *f2*.

The BIOS searches three places for the diagnostic tools, in the following order:

- a. Connected USB drive

---

 **NOTE:** To download the HP PC Hardware Diagnostics (UEFI) tool to a USB drive, see [Downloading HP PC Hardware Diagnostics \(UEFI\) to a USB device on page 60](#).

---

- b. Hard drive

- c. BIOS

3. When the diagnostic tool opens, select the type of diagnostic test you want to run, and then follow the on-screen instructions.

---

 **NOTE:** If you need to stop a diagnostic test, press *esc*.

---

## Downloading HP PC Hardware Diagnostics (UEFI) to a USB device

---

 **NOTE:** The HP PC Hardware Diagnostics (UEFI) download instructions are provided in English only, and you must use a Windows computer to download and create the HP UEFI support environment because only .exe files are offered.

---

There are two options to download HP PC Hardware Diagnostics to a USB device.

### Download the latest UEFI version

1. Go to <http://www.hp.com/go/techcenter/pcdiags>. The HP PC Diagnostics home page is displayed.
2. In the HP PC Hardware Diagnostics section, click the **Download** link, and then select **Run**.

### Download any version of UEFI for a specific product

1. Go to <http://www.hp.com/support>, and then select your country. The HP Support page is displayed.
2. Click **Drivers & Downloads**.

3. Use the categories listed to find your product.

– or –

Click **Find Now** to let HP automatically detect your product.

4. Select your computer, and then select your operating system.

5. In the **Diagnostic** section, follow the on-screen instructions to select and download the UEFI version you want.

---

## 9 Backup and recovery in Windows 7

Your computer includes HP and Windows tools to help you safeguard your information and retrieve it if you ever need to. These tools will help you return your computer to a proper working state, all with simple steps. This section provides information about the following processes:

- Creating recovery media and backups
- Restoring and recovering your system

### Creating recovery media and backups

Recovery after a system failure is only as good as your most recent backup.

1. After you successfully set up the computer, create HP Recovery media. This step creates a Windows 7 operating system DVD and a *Driver Recovery* DVD. The Windows DVD can be used to reinstall the original operating system in cases where the hard drive is corrupted or has been replaced. The *Driver Recovery* DVD installs specific drivers and applications. See [Creating recovery media with HP Recovery Disc Creator on page 62](#).
2. Use Windows Backup and Recovery tools to perform the following:
  - Back up individual files and folders
  - Back up your entire hard drive (select products only)
  - Create system repair discs (select products only) with the installed optical drive (select products only) or an optional external optical drive
  - Create system restore points

---

 **NOTE:** This guide describes an overview of backing up, restoring, and recovering options. For more details about the tools provided, see Help and Support. To access Help and Support, select **Start > Help and Support**.

 **NOTE:** HP recommends that you print the recovery procedures and save them for later use, in case of system instability.

---

In case of system failure, you can use the backup files to restore the contents of your computer. See [Backing up your information on page 63](#).

### Guidelines

- When creating recovery media or backing up to discs, use any of the following types of discs (purchased separately): DVD+R, DVD+R DL, DVD-R, DVD-R DL, or DVD±RW. The discs you use will depend on the type of optical drive you are using.
- Be sure that the computer is connected to AC power before you start the recovery media creation process or the backup process.

### Creating recovery media with HP Recovery Disc Creator

HP Recovery Disc Creator is a software program that offers an alternative way to create recovery media. After you successfully set up the computer, you can create recovery media using HP Recovery Disc Creator. This recovery media allows you to reinstall your original operating system as well as select drivers and

applications if the hard drive becomes corrupted. HP Recovery Disc Creator can create two kinds of recovery DVDs:

- Windows 7 operating system DVD—Installs the operating system without additional drivers or applications.
- *Driver Recovery* DVD—Installs specific drivers and applications only, in the same way that the HP Software Setup utility installs drivers and applications.

## Creating recovery media

---

 **NOTE:** The Windows 7 operating system DVD can be created only once. Thereafter, the option to create that media will not be available after you create a Windows DVD.

---

To create the Windows DVD:

1. Select **Start > All Programs > Productivity and Tools > HP Recovery Disc Creator**.
2. Select **Windows disk**.
3. From the drop-down menu, select the drive for burning the recovery media.
4. Click the **Create** button to start the burning process.

After the Windows 7 operating system DVD has been created, create the *Driver Recovery* DVD:

1. Select **Start > All Programs > Productivity and Tools > HP Recovery Disc Creator**.
2. Select **Driver disk**.
3. From the drop-down menu, select the drive for burning the recovery media.
4. Click the **Create** button to start the burning process.

## Backing up your information

You should create system repair media and your initial backup immediately after initial system setup. As you add new software and data files, you should continue to back up your system on a regular basis to maintain a reasonably current backup. You should also create Windows system repair media (select products only) which can be used to start up (boot) the computer and repair the operating system in case of system instability or failure. Your initial and subsequent backups allow you to restore your data and settings if a failure occurs.

You can back up your information to an optional external hard drive, a network drive, or discs.

Note the following when backing up:

- Store personal files in the Documents library, and back it up regularly.
- Back up templates that are stored in their associated directories.
- Save customized settings that appear in a window, toolbar, or menu bar by taking a screen shot of your settings. The screen shot can be a time-saver if you have to reset your preferences.
- When backing up to discs, number each disc after removing it from the drive.

---

 **NOTE:** For detailed instructions on various backup and restore options, perform a search for these topics in Help and Support. To access Help and Support, select **Start > Help and Support**.

 **NOTE:** Windows includes the User Account Control feature to improve the security of your computer. You may be prompted for your permission or password for tasks such as installing software, running utilities, or changing Windows settings. Refer to Help and Support. To access Help and Support, select **Start > Help and Support**.

---

To create a backup using Windows Backup and Restore:

---

 **NOTE:** The backup process may take over an hour, depending on file size and the speed of the computer.

---

1. Select **Start > All Programs > Maintenance > Backup and Restore**.
2. Follow the on-screen instructions to set up your backup, create a system image (select products only), or create system repair media (select products only).

## Performing a system recovery

In case of system failure or instability, the computer provides the following tools to recover your files:

- Windows recovery tools: You can use Windows Backup and Restore to recover information you have previously backed up. You can also use Windows Startup Repair to fix problems that might prevent Windows from starting correctly.
- f11 recovery tools (select products only): You can use the f11 recovery tools to recover your original hard drive image. The image includes the Windows operating system and software programs installed at the factory.

---

 **NOTE:** If you are unable to boot (start up) your computer and you cannot use the system repair media you previously created (select products only), you must purchase Windows 7 operating system media to reboot the computer and repair the operating system. For additional information, see [Using Windows 7 operating system media on page 65](#).

---

## Using the Windows recovery tools

Using the Windows recovery tools, you can:

- Recover individual files
- Restore the computer to a previous system restore point
- Recover information using recovery tools

---

 **NOTE:** For detailed instructions on various recovery and restore options, perform a search for these topics in Help and Support. To access Help and Support, select **Start > Help and Support**.

 **NOTE:** Windows includes the User Account Control feature to improve the security of your computer. You may be prompted for your permission or password for tasks such as installing software, running utilities, or changing Windows settings. Refer to Help and Support. To access Help and Support, select **Start > Help and Support**.

---

To recover information you previously backed up:

1. Select **Start > All Programs > Maintenance > Backup and Restore**.
2. Follow the on-screen instructions to recover your system settings, your computer (select products only), or your files.

To recover your information using Startup Repair, follow these steps:

---

 **CAUTION:** Some Startup Repair options will completely erase and reformat the hard drive. All files you have created and any software installed on the computer are permanently removed. When reformatting is complete, the recovery process restores the operating system, as well as the drivers, software, and utilities from the backup used for recovery.

---



1. If possible, back up all personal files.
2. If possible, check for the presence of the Windows partition.

To check for the Windows partition, select **Start > Computer**.



**NOTE:** If the Windows partition is not listed, you must recover your operating system and programs using the Windows 7 operating system DVD and the *Driver Recovery* media. For additional information, see [Using Windows 7 operating system media on page 65](#).

3. If the Windows partition is listed, restart the computer, and then press **f8** before the Windows operating system loads.
4. Select **Startup Repair**.
5. Follow the on-screen instructions.



**NOTE:** For additional information on recovering information using the Windows tools, select **Start > Help and Support**.

## Using f11 recovery tools (select products only)



**CAUTION:** Using **f11** completely erases hard drive contents and reformats the hard drive. All files that you have created and any software that you have installed on the computer are permanently removed. The **f11** recovery tool reinstalls the operating system and HP programs and drivers that were installed at the factory. Software not installed at the factory must be reinstalled.

To recover the original hard drive image using **f11**:

1. If possible, back up all personal files.
2. If possible, check for the presence of the HP Recovery partition: click **Start**, right-click **Computer**, click **Manage**, and then click **Disk Management**.



**NOTE:** If the HP Recovery partition is not listed, you must recover your operating system and programs using the Windows 7 operating system media and the *Driver Recovery* media. For additional information, see [Using Windows 7 operating system media on page 65](#).

3. If the HP Recovery partition is listed, restart the computer, and then press **f11** before the Windows operating system loads.
4. Follow the on-screen instructions.

## Using Windows 7 operating system media

If you cannot use the recovery media you previously created using the HP Recovery Disc Creator (select products only), you must purchase a Windows 7 operating system DVD to reboot the computer and repair the operating system.

To order a Windows 7 operating system DVD, go to the HP website. For U.S. support, go to <http://www.hp.com/support>. For worldwide support, go to [http://welcome.hp.com/country/us/en/wwcontact\\_us.html](http://welcome.hp.com/country/us/en/wwcontact_us.html). You can also order the DVD by calling support. For contact information, see the *Worldwide Telephone Numbers* booklet included with the computer.



**CAUTION:** Using a Windows 7 operating system DVD completely erases hard drive contents and reformats the hard drive. All files that you have created and any software that you have installed on the computer are permanently removed. When reformatting is complete, the recovery process helps you restore the operating system, as well as drivers, software, and utilities.

To initiate recovery using a Windows 7 operating system DVD:



---

**NOTE:** This process takes several minutes.

---

1. If possible, back up all personal files.
2. Restart the computer, and then insert the Windows 7 operating system DVD into the optical drive before the Windows operating system loads.
3. When prompted, press any keyboard key.
4. Follow the on-screen instructions.
5. Click **Next**.
6. Select **Repair your computer**.
7. Follow the on-screen instructions.

After the repair is completed:

1. Eject the Windows 7 operating system DVD and then insert the *Driver Recovery* DVD.
2. Install the Hardware Enabling Drivers first, and then install Recommended Applications.

---

# 10 Backup and recovery in Windows 10

This chapter provides information about the following processes. The information in the chapter is standard procedure for most products.

- Creating recovery media and backups
- Restoring and recovering your system

For additional information, refer to the HP support assistant app.

▲ Type `support` in the taskbar search box, and then select the **HP Support Assistant** app.

– or –

Click the question mark icon in the taskbar.

---

 **IMPORTANT:** If you will be performing recovery procedures on a tablet, the tablet battery must be at least 70% charged before you start the recovery process.

**IMPORTANT:** For a tablet with a detachable keyboard, connect the keyboard to the keyboard dock before beginning any recovery process.

---

## Creating recovery media and backups

The following methods of creating recovery media and backups are available on select products only. Choose the available method according to your computer model.

- Use HP Recovery Manager to create HP Recovery media after you successfully set up the computer. This step creates a backup of the HP Recovery partition on the computer. The backup can be used to reinstall the original operating system in cases where the hard drive is corrupted or has been replaced. For information on creating recovery media, see [Creating HP Recovery media \(select products only\) on page 67](#). For information on the recovery options that are available using the recovery media, see [Using Windows tools on page 68](#).
- Use Windows tools to create system restore points and create backups of personal information.

For more information, see [Recovering using HP Recovery Manager on page 69](#).

---

 **NOTE:** If storage is 32 GB or less, Microsoft System Restore is disabled by default.

---

## Creating HP Recovery media (select products only)

If possible, check for the presence of the Recovery partition and the Windows partition. From the **Start** menu, select **File Explorer**, and then select **This PC**.

- If your computer does not list the Windows partition and the Recovery partition, you can obtain recovery media for your system from support. See the *Worldwide Telephone Numbers* booklet included with the computer. You can also find contact information on the HP website. Go to <http://www.hp.com/support>, select your country or region, and follow the on-screen instructions.

You can use Windows tools to create system restore points and create backups of personal information, see [Using Windows tools on page 68](#).

- If your computer does list the Recovery partition and the Windows partition, you can use HP Recovery Manager to create recovery media after you successfully set up the computer. HP Recovery media can be used to perform system recovery if the hard drive becomes corrupted. System recovery reinstalls the original operating system and software programs that were installed at the factory and then configures the settings for the programs. HP Recovery media can also be used to customize the system or restore the factory image if you replace the hard drive.
  - Only one set of recovery media can be created. Handle these recovery tools carefully, and keep them in a safe place.
  - HP Recovery Manager examines the computer and determines the required storage capacity for the media that will be required.
  - To create recovery discs, your computer must have an optical drive with DVD writer capability, and you must use only high-quality blank DVD-R, DVD+R, DVD-R DL, or DVD+R DL discs. Do not use rewritable discs such as CD±RW, DVD±RW, double-layer DVD±RW, or BD-RE (rewritable Blu-ray) discs; they are not compatible with HP Recovery Manager software. Or, instead, you can use a high-quality blank USB flash drive.
  - If your computer does not include an integrated optical drive with DVD writer capability, but you would like to create DVD recovery media, you can use an external optical drive (purchased separately) to create recovery discs. If you use an external optical drive, it must be connected directly to a USB port on the computer; the drive cannot be connected to a USB port on an external device, such as a USB hub. If you cannot create DVD media yourself, you can obtain recovery discs for your computer from HP. See the *Worldwide Telephone Numbers* booklet included with the computer. You can also find contact information on the HP website. Go to <http://www.hp.com/support>, select your country or region, and follow the on-screen instructions.
  - Be sure that the computer is connected to AC power before you begin creating the recovery media.
  - The creation process can take an hour or more. Do not interrupt the creation process.
  - If necessary, you can exit the program before you have finished creating all of the recovery DVDs. HP Recovery Manager will finish burning the current DVD. The next time you start HP Recovery Manager, you will be prompted to continue.

To create HP Recovery media:



---

**IMPORTANT:** For a tablet with a detachable keyboard, connect the keyboard to the keyboard dock before beginning these steps.

---

1. Type `recovery` in the taskbar search box, and then select **HP Recovery Manager**.
2. Select **Create recovery media**, and then follow the on-screen instructions.

If you ever need to recover the system, see [Recovering using HP Recovery Manager on page 69](#).

## Using Windows tools

You can create recovery media, system restore points, and backups of personal information using Windows tools.



---

**NOTE:** If storage is 32 GB or less, Microsoft System Restore is disabled by default.

---

For more information and steps, see the Get started app.

- ▲ Select the **Start** button, and then select the **Get started** app.

# Restore and recovery

There are several options for recovering your system. Choose the method that best matches your situation and level of expertise:

 **IMPORTANT:** Not all methods are available on all products.

- Windows offers several options for restoring from backup, refreshing the computer, and resetting the computer to its original state. For more information see the Get started app.
  - ▲ Select the **Start** button, and then select the **Get started** app.
- If you need to correct a problem with a preinstalled application or driver, use the Reinstall drivers and/or applications option (select products only) of HP Recovery Manager to reinstall the individual application or driver.
  - ▲ Type `recovery` in the taskbar search box, select **HP Recovery Manager**, select **Reinstall drivers and/or applications**, and then follow the on-screen instructions.
- If you want to recover the Windows partition to original factory content, you can choose the System Recovery option from the HP Recovery partition (select products only) or use the HP Recovery media. For more information, see [Recovering using HP Recovery Manager on page 69](#). If you have not already created recovery media, see [Creating HP Recovery media \(select products only\) on page 67](#).
- On select products, if you want to recover the computer's original factory partition and content, or if you have replaced the hard drive, you can use the Factory Reset option of HP Recovery media. For more information, see [Recovering using HP Recovery Manager on page 69](#).
- On select products, if you want to remove the recovery partition to reclaim hard drive space, HP Recovery Manager offers the Remove Recovery Partition option.

For more information, see [Removing the HP Recovery partition \(select products only\) on page 71](#).

## Recovering using HP Recovery Manager

HP Recovery Manager software allows you to recover the computer to its original factory state by using the HP Recovery media that you either created or that you obtained from HP, or by using the HP Recovery partition (select products only). If you have not already created recovery media, see [Creating HP Recovery media \(select products only\) on page 67](#).

### What you need to know before you get started

- HP Recovery Manager recovers only software that was installed at the factory. For software not provided with this computer, you must either download the software from the manufacturer's website or reinstall the software from the media provided by the manufacturer.

 **IMPORTANT:** Recovery through HP Recovery Manager should be used as a final attempt to correct computer issues.

- HP Recovery media must be used if the computer hard drive fails. If you have not already created recovery media, see [Creating HP Recovery media \(select products only\) on page 67](#).
- To use the Factory Reset option (select products only), you must use HP Recovery media. If you have not already created recovery media, see [Creating HP Recovery media \(select products only\) on page 67](#).
- If your computer does not allow the creation of HP Recovery media or if the HP Recovery media does not work, you can obtain recovery media for your system from support. See the *Worldwide Telephone Numbers* booklet included with the computer. You can also find contact information from the HP

website. Go to <http://www.hp.com/support>, select your country or region, and follow the on-screen instructions.

---

 **IMPORTANT:** HP Recovery Manager does not automatically provide backups of your personal data. Before beginning recovery, back up any personal data you want to retain.

---

Using HP Recovery media, you can choose from one of the following recovery options:

---

 **NOTE:** Only the options available for your computer display when you start the recovery process.

---

- System Recovery—Reinstalls the original operating system, and then configures the settings for the programs that were installed at the factory.
- Factory Reset—Restores the computer to its original factory state by deleting all information from the hard drive and re-creating the partitions. Then it reinstalls the operating system and the software that was installed at the factory.

The HP Recovery partition (select products only) allows System Recovery only.

## Using the HP Recovery partition (select products only)

The HP Recovery partition allows you to perform a system recovery without the need for recovery discs or a recovery USB flash drive. This type of recovery can be used only if the hard drive is still working.

To start HP Recovery Manager from the HP Recovery partition:

---

 **IMPORTANT:** For a tablet with a detachable keyboard, connect the keyboard to the keyboard dock before beginning these steps (select products only).

---

1. Type `recovery` in the taskbar search box, select **Recovery Manager**, and then select **HP Recovery Environment**.

- or -

For computers or tablets with keyboards attached, press **f11** while the computer boots, or press and hold **f11** as you press the power button.

For tablets without keyboards:

Turn on or restart the tablet, and then quickly hold down the volume down button; then select **f11**.

- or -

Turn on or restart the tablet, and then quickly hold down the Windows button; then select **f11**.

2. Select **Troubleshoot** from the boot options menu.
3. Select **Recovery Manager**, and then follow the on-screen instructions.

## Using HP Recovery media to recover

You can use HP Recovery media to recover the original system. This method can be used if your system does not have an HP Recovery partition or if the hard drive is not working properly.

1. If possible, back up all personal files.
2. Insert the HP Recovery media, and then restart the computer.

---

 **NOTE:** If the computer does not automatically restart in HP Recovery Manager, change the computer boot order. See [Changing the computer boot order on page 71](#).

---

3. Follow the on-screen instructions.

## Changing the computer boot order

If your computer does not restart in HP Recovery Manager, you can change the computer boot order, which is the order of devices listed in BIOS where the computer looks for startup information. You can change the selection to an optical drive or a USB flash drive.

To change the boot order:

---

 **IMPORTANT:** For a tablet with a detachable keyboard, connect the keyboard to the keyboard dock before beginning these steps.

---

1. Insert the HP Recovery media.
2. Access BIOS:

For computers or tablets with keyboards attached:

- ▲ Turn on or restart the computer or tablet, quickly press **esc**, and then press **f9** for boot options.

For tablets without keyboards:

- ▲ Turn on or restart the tablet, and then quickly hold down the volume down button; then select **f9**.  
- or -

Turn on or restart the tablet, and then quickly hold down the Windows button; then select **f9**.

3. Select the optical drive or USB flash drive from which you want to boot.
4. Follow the on-screen instructions.

## Removing the HP Recovery partition (select products only)

HP Recovery Manager software allows you to remove the HP Recovery partition to free up hard drive space.

---

 **IMPORTANT:** After you remove the HP Recovery partition, you will not be able to perform System Recovery or create HP recovery media from the HP Recovery partition. So before you remove the Recovery partition, create HP Recovery media; see [Creating HP Recovery media \(select products only\) on page 67](#).

---

 **NOTE:** The Remove Recovery Partition option is only available on products that support this function.

---

Follow these steps to remove the HP Recovery partition:

1. Type `recovery` in the taskbar search box, and then select **HP Recovery Manager**.
2. Select **Remove Recovery Partition**, and then follow the on-screen instructions.

# 11 Specifications

## Computer specifications

	Metric	U.S.
<b>Dimensions</b>		
Width	<b>31.0 cm</b>	12.2 in
Depth	<b>21.0 cm</b>	8.27 in
Height	<b>1.57 cm</b>	0.62 in
<b>Weight</b>		
FHD (no touch), 8 GB, M.2 128 GB SSD, fingerprint reader, camera, no NFC, WLAN	<b>1.20 kg</b>	2.64 lbs
QHD+ (with touch), 8 GB, M.2 128 GB SSD, fingerprint reader, camera, no NFC, WLAN	<b>1.21 kg</b>	2.67 lbs
<b>Input power</b>		
Operating voltage and current	18.5 V dc @ 3.5 A - 65 W – or – 19.0 V dc @ 4.74 A - 90 W	
<b>Temperature</b>		
Operating	5°C to 35°C	41°F to 95°F
Nonoperating	-20°C to 60°C	-4°F to 140°F
<b>Relative humidity</b> (noncondensing)		
Operating	10% to 90%	
Nonoperating	5% to 95%	
<b>Maximum altitude</b> (unpressurized)		
Operating	<b>-15 m to 3,048 m</b>	-50 ft to 10,000 ft
Nonoperating	<b>-15 m to 12,192 m</b>	-50 ft to 40,000 ft
<b>NOTE:</b> Applicable product safety standards specify thermal limits for plastic surfaces. The device operates well within this range of temperatures.		



## 33.78-cm (13.3-in) display specifications

	<b>Metric</b>	<b>U.S.</b>
<b>Dimensions</b>		
Height	<b>17.0 cm</b>	6.69 in
Width	<b>29.0 cm</b>	11.42 in
Diagonal	<b>33.78 cm</b>	13.3 in
<b>Brightness</b>	300 nits	
<b>Resolution</b>		
FHD	1920 × 1080	
QHD+	3200 × 1800	
<b>Viewing angle</b>	UWVA	
<b>Backlight</b>	WLED	
<b>Graphics adapter</b>	eDP 1.3	
<b>Thickness</b>	3.0 mm	
<b>Screen type</b>	FHD: non-touch QHD+: touch	

## M.2 solid-state drive specifications

	128-GB*	180-GB*	240-GB*	256-GB*	512-GB*
<b>Dimensions</b>					
Height	1 mm	1 mm	1 mm	1 mm	1 mm
Length	50.8 mm	50.8 mm	50.8 mm	50.8 mm	50.8 mm
Width	28.9 mm	28.9 mm	28.9 mm	28.9 mm	28.9 mm
Weight	< 10 g	< 10 g	< 10 g	< 10 g	< 10 g
<b>Interface type</b>	ATA-7	ATA-7	ATA-7	ATA-7	ATA-7
<b>Transfer rate</b>					
Sequential Read	Up to 160 MB/s	Up to 380 MB/s	Up to 540 MB/s	Up to 490 MB/s	Up to 500 MB/s
Random Read	Up to 128 MB/s	Up to 180 MB/s	Up to 41K IOPs	Up to 480 MB/s	Up to 84K IOPs
Sequential Write	Up to 115 MB/s	Up to 80 MB/s	Up to 490 MB/s	Up to 250 MB/s	Up to 455 MB/s
Random Write	Up to 16 MB/s	Up to 40 MB/s	Up to 80K IOPs	Up to 100 MB/s	Up to 59K IOPs
<b>Ready time, Maximum (to not busy)</b>	2.0 s	4.0 s	1.0 s	4.0 s	3.0 s
<b>Access times</b>					
Logical	0.1 ms	0.1 ms	0.1 ms	0.1	0.1
<b>Total logical sectors</b>	117,905,264	352,533,296	468,862,128	500,118,192	1,000,215,216
<b>Operating temperature</b>					
Operating	0° to 70°C (32°F to 158°F)	0° to 70°C (32°F to 158°F)	0° to 70°C (32°F to 158°F)	0° to 70°C (32°F to 158°F)	0° to 70°C (32°F to 158°F)
Non-operating	-55° to 95°C (-67°F to 203°F)	-40° to 80°C (-40°F to 176°F)	-40° to 85°C (-40°F to 185°F)	-40° to 80°C (-40°F to 176°F)	-40° to 85°C (-40°F to 185°F)
*1 GB = 1 billion bytes when referring to hard drive storage capacity. Actual accessible capacity is less.					
<b>NOTE:</b> Certain restrictions and exclusions apply. Contact technical support for details.					

# 12 Statement of memory volatility

The purpose of this chapter is to provide general information regarding nonvolatile memory in HP Business PCs. This chapter also provides general instructions for restoring nonvolatile memory that can contain personal data after the system has been powered off and the hard drive has been removed.

HP Business PC products that use Intel®-based or AMD®-based system boards contain volatile DDR memory. The amount of nonvolatile memory present in the system depends upon the system configuration. Intel-based and AMD-based system boards contain nonvolatile memory subcomponents as originally shipped from HP, assuming that no subsequent modifications have been made to the system and assuming that no applications, features, or functionality have been added to or installed on the system.

Following system shutdown and removal of all power sources from an HP Business PC system, personal data can remain on volatile system memory (DIMMs) for a finite period of time and will also remain in nonvolatile memory. Use the steps below to remove personal data from the PC, including the nonvolatile memory found in Intel-based and AMD-based system boards.

---

 **NOTE:** If your tablet has a keyboard base, connect to the keyboard base before beginning steps in this chapter.

---

## Current BIOS steps

1. Follow steps (a) through (f) below to restore the nonvolatile memory that can contain personal data. Restoring or reprogramming nonvolatile memory that does not store personal data is neither necessary nor recommended.
  - a. Turn on or restart the computer, and then press **esc** while the "Press the ESC key for Startup Menu" message is displayed at the bottom of the screen.

---

 **IMPORTANT:** If the **Main** menu displays **Restore Defaults** instead of **Apply Factory Defaults and Exit**, go to [Legacy BIOS Steps on page 76](#).

 **NOTE:** If the system has a BIOS administrator password, enter the password at the prompt.
  - b. Select **Main**, select **Apply Factory Defaults and Exit**, and then select **Yes** to load defaults.  
The computer will reboot.
  - c. During the reboot, press **esc** while the "Press the ESC key for Startup Menu" message is displayed at the bottom of the screen.

---

 **NOTE:** If the system has a BIOS administrator password, enter the password at the prompt.
  - d. Select the **Security** menu, select **Restore Security Settings to Factory Defaults**, and then select **Yes** to restore security level defaults.  
The computer will reboot.
  - e. During the reboot, press **esc** while the "Press the ESC key for Startup Menu" message is displayed at the bottom of the screen.

---

 **NOTE:** If the system has a BIOS administrator password, enter the password at the prompt.
  - f. If an asset or ownership tag is set, select the **Security** menu and scroll down to the **Utilities** menu. Select **System IDs**, and then select **Asset Tracking Number**. Clear the tag, and then make the selection to return to the prior menu.

- g. If a DriveLock password is set, select the **Security** menu, and scroll down to **Hard Drive Utilities** under the **Utilities** menu. Select **Hard Drive Utilities**, select **DriveLock**, then uncheck the checkbox for **DriveLock password on restart**. Select **OK** to proceed.
- h. Select the **Main** menu, and then select **Reset BIOS Security to factory default**. Click **Yes** at the warning message.  
The computer will reboot.
- i. During the reboot, press **esc** while the “Press the ESC key for Startup Menu” message is displayed at the bottom of the screen.

---

 **NOTE:** If the system has a BIOS administrator password, enter the password at the prompt.

---

- j. Select the **Main** menu, select **Apply Factory Defaults and Exit**, select **Yes** to save changes and exit, and then select **Shutdown**.
  - k. Reboot the system. If the system has a Trusted Platform Module (TPM) and/or fingerprint reader, one or two prompts will appear—one to clear the TPM and the other to Reset Fingerprint Sensor; press or tap **F1** to accept or **F2** to reject.
  - l. Remove all power and system batteries for at least 24 hours.
2. Complete one of the following:
- Remove and retain the storage drive.
  - or –
  - Clear the drive contents by using a third party utility designed to erase data from an SSD.
  - or –
  - Clear the contents of the drive by using the following BIOS Setup Secure Erase command option steps:

---

 **IMPORTANT:** If you clear data using Secure Erase, it cannot be recovered.

---

- a. Turn on or restart the computer, and then press **esc** while the “Press the ESC key for Startup Menu” message is displayed at the bottom of the screen.
- b. Select the **Security** menu and scroll down to the **Utilities** menu.
- c. Select **Hard Drive Tools**.
- d. Under **Utilities**, select **Secure Erase**, select the hard drive storing the data you want to clear, and then follow the on-screen instructions to continue.

## Legacy BIOS Steps

Use the steps for older versions of BIOS.

---

 **NOTE:** If you already completed the steps in [Current BIOS steps on page 75](#), skip this section.

---

1. Follow steps (a) through (i) below to restore the nonvolatile memory that can contain personal data. Restoring or reprogramming nonvolatile memory that does not store personal data is neither necessary nor recommended.

---

 **NOTE:** If you have not already done so, access the BIOS menu.

- Turn on or restart the computer, and then press **esc** while the “Press the ESC key for Startup Menu” message is displayed at the bottom of the screen.

 **NOTE:** If the system has a BIOS administrator password, enter the password at the prompt.

---

- a. Select **Main**, select **Restore Defaults**, and then select **Yes** to load defaults.
  - b. Select the **Security** menu, select **Restore Security Level Defaults**, and then select **Yes** to restore security level defaults.
  - c. If an asset or ownership tag is set, select the **Security** menu and scroll down to the **Utilities** menu. Select **System IDs**, and then select **Asset Tracking Number**. Clear the tag, and then make the selection to return to the prior menu.
  - d. If a DriveLock password is set, select the **Security** menu, and scroll down to **Hard Drive Tools** under the **Utilities** menu. Select **Hard Drive Tools**, select **DriveLock**, then uncheck the checkbox for **DriveLock password on restart**. Select **OK** to proceed.
  - e. If an Automatic DriveLock password is set, select the **Security** menu, scroll down to **Hard Drive Tools** under the **Utilities** menu. Select **Hard Drive Tools**, scroll down to **Automatic DriveLock**, then select the desired hard drive and disable protection. At the automatic drive lock warning screen, select **Yes** to continue. Repeat this procedure if more than one hard drive has an Automatic DriveLock password.
  - f. Select the **Main** menu, and then select **Reset BIOS Security to factory default**. Click **Yes** at the warning message.
  - g. Select the **Main** menu, select **Save Changes and Exit**, select **Yes** to save changes and exit, and then select **Shutdown**.
  - h. Reboot the system. If the system has a Trusted Platform Module (TPM) and/or fingerprint reader, one or two prompts will appear—one to clear the TPM and the other to Reset Fingerprint Sensor; press or tap **F1** to accept or **F2** to reject.
  - i. Remove all power and system batteries for at least 24 hours.
2. Complete one of the following:
- Remove and retain the storage drive.
  - or –
  - Clear the drive contents by using a third party utility designed to erase data from an SSD.
  - or –
  - Clear the contents of the drive by using the following BIOS Setup Secure Erase command option steps:

 **IMPORTANT:** If you clear data using Secure Erase, it cannot be recovered.

---

- a. Turn on or restart the computer, and then press **esc** while the "Press the ESC key for Startup Menu" message is displayed at the bottom of the screen.
  - b. Select the **Security** menu and scroll down to the **Utilities** menu.
  - c. Select **Hard Drive Tools**.
  - d. Under **Utilities**, select **Secure Erase**, select the hard drive storing the data you want to clear, and then follow the on-screen instructions to continue.
- or –
- Clear the contents of the drive by using the following Disk Sanitizer command steps:

 **IMPORTANT:** If you clear data using Disk Sanitizer, it cannot be recovered.

---

 **NOTE:** The amount of time it takes for Disk Sanitizer to run can take several hours. Plug the computer into an AC outlet before starting.

---

- a. Turn on or restart the computer, and then press **esc** while the "Press the ESC key for Startup Menu" message is displayed at the bottom of the screen.
- b. Select the **Security** menu and scroll down to the **Utilities** menu.
- c. Select **Hard Drive Tools**.
- d. Under **Utilities**, select **Disk Sanitizer**, select the hard drive storing the data you want to clear, and then follow the on-screen instructions to continue.

## Nonvolatile memory usage

Nonvolatile Memory Type	Amount (Size)	Does this memory store customer data?	Does this memory retain data when power is removed?	What is the purpose of this memory?	How is data input into this memory?	How is this memory write-protected?
HP Sure Start flash (select models only)	2 MBytes	No	Yes	Provides protected backup of critical System BIOS code, EC firmware, and critical PC configuration data for select platforms that support HP Sure Start.  For more information, see <a href="#">Using HP Sure Start (select models only)</a> on page 82.	Data cannot be written to this device via the host processor. The content is managed solely by the HP Sure Start Embedded Controller.	This memory is protected by the HP Sure Start Embedded Controller.
Real Time Clock (RTC) battery backed-up CMOS configuration memory	256 Bytes	No	Yes	Stores system date and time and noncritical data.	RTC battery backed-up CMOS is programmed using the Computer Setup (BIOS), or changing the Microsoft Windows date & time.	This memory is not write-protected.
Controller (NIC) EEPROM	64 KBytes (not customer accessible)	No	Yes	Stores NIC configuration and NIC firmware.	NIC EEPROM is programmed using a utility from the NIC vendor that can be run from DOS.	A utility is required to write data to this memory and is available from the NIC vendor. Writing data to this ROM in an inappropriate manner will render the NIC non-functional.
DIMM Serial Presence Detect (SPD) configuration data	256 Bytes per memory module, 128 Bytes programmable (not customer accessible)	No	Yes	Stores memory module information.	DIMM SPD is programmed by the memory vendor.	Data cannot be written to this memory when the module is installed in a PC. The specific write-protection method varies by memory vendor.
System BIOS	4 MBytes to 5 MBytes	Yes	Yes	Stores system BIOS code and PC configuration data.	System BIOS code is programmed at the factory. Code is updated when the system BIOS is updated. Configuration data and settings are input using the Computer Setup (BIOS) or a custom utility.	<b>NOTE:</b> Writing data to this ROM in an inappropriate manner can render the PC non-functional.  A utility is required for writing data to this memory and is available on the HP website; go to <a href="http://www.hp.com/support">http://www.hp.com/support</a> . Select <b>Find your product</b> , and then follow

Nonvolatile Memory Type	Amount (Size)	Does this memory store customer data?	Does this memory retain data when power is removed?	What is the purpose of this memory?	How is data input into this memory?	How is this memory write-protected?
Intel Management Engine Firmware (present in only specific ZBook and EliteBook models. For more information, go to <a href="http://www.hp.com/support">http://www.hp.com/support</a> . Select <b>Find your product</b> , and then follow the on-screen instructions.)	1.5 MBytes or 5 MBytes	Yes	Yes	Stores Management Engine Code, Settings, Provisioning Data and iAMT third-party data store.	Management Engine Code is programmed at the factory. Code is updated via Intel secure firmware update utility. Unique Provisioning Data can be entered at the factory or by an administrator using the Management Engine (MEBx) setup utility. The third party data store contents can be populated by a remote management console or local applications that have been registered by an administrator to have access to the space.	the on-screen instructions.  The Intel chipset is configured to enforce hardware protection to block all direct read/write access to this area. An Intel utility is required for updating the firmware. Only firmware updates digitally signed by Intel can be applied using this utility.
Bluetooth flash	2 Mbit	No	Yes	Stores Bluetooth configuration and firmware.	Bluetooth flash is programmed at the factory. Tools for writing data to this memory are not publicly available but can be obtained from the silicon vendor.	A utility is required for writing data to this memory and is made available through newer versions of the driver whenever the flash requires an upgrade.
802.11 WLAN EEPROM	4 Kbit to 8 Kbit	No	Yes	Stores configuration and calibration data.	802.11 WLAN EEPROM is programmed at the factory. Tools for writing data to this memory are not made public.	A utility is required for writing data to this memory and is typically not made available to the public unless a firmware upgrade is necessary to address a unique issue.
Web camera	64 Kbit	No	Yes	Stores webcam configuration and firmware.	Webcam memory is programmed using a utility from the device manufacturer that can be run from Windows.	A utility is required for writing data to this memory and is typically not made available to the public unless a firmware upgrade is necessary to address a unique issue.
Fingerprint reader	512 KByte flash	Yes	Yes	Stores fingerprint templates.	Fingerprint reader memory is programmed by user enrollment in HP ProtectTools Security Manager.	Only a digitally signed application can make the call to write to the flash.



# Questions and answers

## 1. How can the BIOS settings be restored (returned to factory settings)?



**IMPORTANT:** Restore defaults does not securely erase any data on your hard drive. See question and answer 6 for steps to securely erase data.

Restore defaults does not reset the Custom Secure Boot keys. See question and answer 7 for information about resetting the keys.

- a. Turn on or restart the computer, and then press **esc** while the "Press the ESC key for Startup Menu" message is displayed at the bottom of the screen.
- b. Select **Main**, and then select **Restore defaults**.
- c. Follow the on-screen instructions.
- d. Select **Main**, select **Save Changes and Exit**, and then follow the on-screen instructions.

## 2. What is a UEFI BIOS, and how is it different from a legacy BIOS?

The Unified Extensible Firmware Interface (UEFI) BIOS is an industry-standard software interface between the platform firmware and an operating system (OS). It is a replacement for the older BIOS architecture, but supports much of the legacy BIOS functionality.

Like the legacy BIOS, the UEFI BIOS provides an interface to display the system information and configuration settings and to change the configuration of your computer before an OS is loaded. BIOS provides a secure run-time environment that supports a Graphic User Interface (GUI). In this environment, you can use either a pointing device (Touchscreen, TouchPad, pointing stick, or USB mouse) or the keyboard to navigate and make menu and configuration selections. The UEFI BIOS also contains basic system diagnostics.

The UEFI BIOS provides functionality beyond that of the legacy BIOS. In addition, the UEFI BIOS works to initialize the computer's hardware before loading and executing the OS; the run-time environment allows the loading and execution of software programs from storage devices to provide more functionality, such as advanced hardware diagnostics (with the ability to display more detailed system information) and advanced firmware management and recovery software.

HP has provided options in Computer Setup (BIOS) to allow you to run in legacy BIOS, if required by the operating system. Examples of this requirement would be if you upgrade or downgrade the OS.

## 3. Where does the UEFI BIOS reside?

The UEFI BIOS resides on a flash memory chip. A utility is required to write to the chip.

## 4. What kind of configuration data is stored on the DIMM Serial Presence Detect (SPD) memory module? How would this data be written?

The DIMM SPD memory contains information about the memory module, such as size, serial number, data width, speed/timing, voltage, and thermal information. This information is written by the module manufacturer and stored on an EEPROM. This EEPROM cannot be written to when the memory module is installed in a PC. Third-party tools do exist that can write to the EEPROM when the memory module is not installed in a PC. Various third-party tools are available to read SPD memory.

## 5. What is meant by "Restore the nonvolatile memory found in Intel-based system boards"?

This message relates to clearing the Real Time Clock (RTC) CMOS memory that contains PC configuration data.

## 6. How can the BIOS security be reset to factory defaults and data erased?

---

 **IMPORTANT:** Resetting will result in the loss of information.

These steps will not reset Custom Secure Boot Keys. See question and answer 7 for information about resetting the keys.

---

- a. Turn on or restart the computer, and then press **esc** while the "Press the ESC key for Startup Menu" message is displayed at the bottom of the screen.
- b. Select **Main**, and then select **Reset BIOS Security to Factory Default**.
- c. Follow the on-screen instructions.
- d. Select **Main**, select **Save Changes and Exit**, and then follow the on-screen instructions.

#### 7. How can the Custom Secure Boot Keys be reset?

Secure Boot is a feature to ensure that only authenticated code can start on a platform. If you enabled Secure Boot and created Custom Secure Boot Keys, simply disabling Secure Boot will not clear the keys. You must also select to clear the Custom Secure Boot Keys. Use the same Secure Boot access procedure you used to create the Custom Secure Boot Keys, but make the selection to clear or delete all Secure Boot Keys.

- a. Turn on or restart the computer, and then press **esc** while the "Press the ESC key for Startup Menu" message is displayed at the bottom of the screen.
- b. Select the **Security** menu, select **Secure Boot Configuration**, and then follow the on-screen instructions.
- c. At the **Secure Boot Configuration** window, select **Secure Boot**, select **Clear Secure Boot Keys**, and then follow the on-screen instructions to continue.

## Using HP Sure Start (select models only)

Select computer models are configured with HP Sure Start, a technology that continuously monitors your computer's BIOS for attacks or corruption. If the BIOS becomes corrupted or is attacked, HP Sure Start restores the BIOS to its previously safe state, without user intervention. Those select computer models ship with HP Sure Start configured and enabled. HP Sure Start is configured and already enabled so that most users can use the HP Sure Start default configuration. The default configuration can be customized by advanced users.

To access the latest documentation on HP Sure Start, go to <http://www.hp.com/support>. Select **Find your product**, and then follow the on-screen instructions.

# 13 Power cord set requirements

The wide-range input feature of the computer permits it to operate from any line voltage from 100 to 120 volts AC, or from 220 to 240 volts AC.

The 3-conductor power cord set included with the computer meets the requirements for use in the country or region where the equipment is purchased.

Power cord sets for use in other countries and regions must meet the requirements of the country or region where the computer is used.

## Requirements for all countries

The following requirements are applicable to all countries and regions:

- The length of the power cord set must be at least **1.5 m** (5.0 ft) and no more than **2.0 m** (6.5 ft).
- All power cord sets must be approved by an acceptable accredited agency responsible for evaluation in the country or region where the power cord set will be used.
- The power cord sets must have a minimum current capacity of 10 amps and a nominal voltage rating of 125 or 250 V AC, as required by the power system of each country or region.
- The appliance coupler must meet the mechanical configuration of an EN 60 320/IEC 320 Standard Sheet C13 connector for mating with the appliance inlet on the back of the computer.

## Requirements for specific countries and regions

Country/region	Accredited agency	Applicable note number
Australia	EANSW	1
Austria	OVE	1
Belgium	CEBC	1
Canada	CSA	2
Denmark	DEMKO	1
Finland	FIMKO	1
France	UTE	1
Germany	VDE	1
Italy	IMQ	1
Japan	METI	3
The Netherlands	KEMA	1
Norway	NEMKO	1
The People's Republic of China	COC	5
South Korea	EK	4

Country/region	Accredited agency	Applicable note number
Sweden	SEMKO	1
Switzerland	SEV	1
Taiwan	BSMI	4
The United Kingdom	BSI	1
The United States	UL	2

1. The flexible cord must be Type H05VV-F, 3-conductor, 1.0-mm<sup>2</sup> conductor size. Power cord set fittings (appliance coupler and wall plug) must bear the certification mark of the agency responsible for evaluation in the country or region where it will be used.
2. The flexible cord must be Type SPT-3 or equivalent, No. 18 AWG, 3-conductor. The wall plug must be a two-pole grounding type with a NEMA 5-15P (15 A, 125 V) or NEMA 6-15P (15 A, 250 V) configuration.
3. The appliance coupler, flexible cord, and wall plug must bear a “T” mark and registration number in accordance with the Japanese Dentori Law. The flexible cord must be Type VCT or VCTF, 3-conductor, 1.00-mm<sup>2</sup> conductor size. The wall plug must be a two-pole grounding type with a Japanese Industrial Standard C8303 (7 A, 125 V) configuration.
4. The flexible cord must be Type RVV, 3-conductor, 0.75-mm<sup>2</sup> conductor size. Power cord set fittings (appliance coupler and wall plug) must bear the certification mark of the agency responsible for evaluation in the country or region where it will be used.
5. The flexible cord must be Type VCTF, 3-conductor, 0.75-mm<sup>2</sup> conductor size. Power cord set fittings (appliance coupler and wall plug) must bear the certification mark of the agency responsible for evaluation in the country or region where it will be used.

---

## 14 Recycling

When a non-rechargeable or rechargeable battery has reached the end of its useful life, do not dispose of the battery in general household waste. Follow the local laws and regulations in your area for battery disposal.

HP encourages customers to recycle used electronic hardware, HP original print cartridges, and rechargeable batteries. For more information about recycling programs, see the HP Web site at <http://www.hp.com/recycle>.

# Index

- A**
  - AC adapter, spare part numbers 17
  - audio, product description 1
  - audio-out (headphone)/audio-in (microphone) combo jack, identifying 10
- B**
  - Backup and Restore 64
  - backup tools 62
  - backups 67
    - creating 63
    - recovering 64
  - battery
    - removal 43
    - spare part numbers 15, 43
  - battery light 10
  - BIOS
    - determining version 53, 57
    - downloading an update 54, 58
    - updating 53, 57
  - boot order
    - changing 71
  - bottom cover
    - removal 24
    - spare part number 15
  - Bracket Kit
    - components 15
    - spare part number 15, 16
  - buttons
    - left TouchPad 5
    - power 7
    - right TouchPad 5
- C**
  - cables, service considerations 20
  - caps lock light, identifying 6
  - chipset, product description 1
  - components
    - bottom 11
    - display 4
    - left side 9
    - right side 10
    - top 5
  - computer major components 13
  - Computer Setup
    - navigating and selecting 52, 56
    - restoring factory settings 53, 57
  - computer specifications 72
  - connector, power 11
  - connectors, service considerations 20
- D**
  - display assembly
    - removal 35
  - display bracket, illustrated 15
  - display panel
    - product description 1
  - display specifications 73
  - docking
    - product description 2
  - docking connector, identifying 10
  - docking device receptors, identifying 11
  - Driver Recovery DVD,
    - creating 62
    - using for restore 65
- E**
  - electrostatic discharge 20
  - embedded numeric keypad, identifying 8
  - equipment guidelines 22
  - esc key, identifying 8
  - Ethernet, product description 1
- F**
  - f11 recovery 65
  - fingerprint reader board
    - removal 45
    - spare part number 14, 45
  - fingerprint reader bracket, illustrated 15
  - fingerprint reader, identifying 8
  - fn key, identifying 8
  - ForcePad
    - removal 47
    - spare part number 14, 47
- G**
  - graphics, product description 1
  - grounding guidelines 20
  - guidelines
    - equipment 22
    - grounding 20
    - packaging 21
    - transporting 21
    - workstation 22
- H**
  - hard drive cover
    - spare part number 24
  - hard drive recovery 65
  - HDMI port, identifying 9
  - heat sink
    - removal 41
    - spare part numbers 15, 41
  - HP PC Hardware Diagnostics (UEFI) using 60
  - HP Recovery Disc Creator, using 62
  - HP Recovery Manager
    - correcting boot problems 71
    - starting 70
  - HP Recovery media
    - creating 67
    - recovery 70
  - HP Recovery partition
    - checking for presence 65
    - recovery 70
    - removing 71
    - using for recovery 65
  - HP Sure Start 82
- I**
  - integrated webcam light, identifying 4
  - internal microphones, identifying 4
- J**
  - jacks
    - audio-out (headphone)/audio-in (microphone) combo 10

## K

- keyboard
  - product description 2
  - removal 27
  - spare part numbers 14, 27
- keypad
  - embedded numeric 8
- keys
  - esc 8
  - fn 8
  - Windows key 8

## L

- legacy support, USB 52, 56
- lights
  - battery 10
  - caps lock 6
  - microphone mute 6
  - num lock 6
  - power 6
  - TouchPad 6
  - webcam 4
  - wireless 6

## M

- M.2 solid-state drive
  - specifications 74
- mass storage device
  - illustrated 17
  - spare part numbers 17
- memory
  - nonvolatile 75
  - volatile 75
- memory module
  - product description 1
- microphone
  - product description 1
- microphone mute light, identifying 6
- minimized image recovery 70
- minimized image, creating 69
- model name 1
- mouse, spare part numbers 18

## N

- near field communication antenna, identifying 4
- NFC antenna illustrated 16
- NFC antenna, identifying 4
- NFC Cable Kit
  - components 16

- NFC cable, illustrated 16
- NFC module
  - removal 14, 46
  - spare part number 46
- nonvolatile memory 75
- num lock light 6

## O

- operating system, product
  - description 3
- optical drive
  - spare part number 17
- original system recovery 69

## P

- packaging guidelines 21
- plastic parts, service
  - considerations 20
- Plastics Kit, spare part number 18, 48
- pointing device, product
  - description 2
- ports
  - HDMI 9
  - product description 2
  - USB 3.0 charging (powered) 9, 10
  - USB Type-C (charging) 9
- power button, identifying 7
- power connector, identifying 11
- power cord
  - set requirements 83
  - spare part numbers 17, 18
- power lights 6
- power requirements, product
  - description 2
- primary storage
  - product description 1
- processor
  - product description 1
- product description
  - audio 1
  - chipset 1
  - display panel 1
  - docking 2
  - Ethernet 1
  - graphics 1
  - keyboard 2
  - memory module 1
  - microphone 1

- operating system 3
- pointing device 2
- ports 2
- power requirements 2
- primary storage 1
- processors 1
- product name 1
- security 3
- serviceability 3
- video 1
- wireless 1
- product name 1

## R

- recover
  - options 69
- recovery
  - discs 68, 70
  - HP Recovery Manager 69
  - media 70
  - starting 70
  - supported discs 68
  - system 69
  - USB flash drive 70
  - using HP Recovery media 68
- recovery media
  - creating 67
  - creating using HP Recovery Manager 68
- recovery media, creating 62
- recovery media, using for restore 65
- recovery partition 65
  - removing 71
- recovery tools 62
- recovery tools, Windows 64
- recovery, system 64
- removal/replacement
  - procedures 24
- removing personal data from volatile system memory 75
- restoring the hard drive 65
- RTC battery
  - removal 39
  - spare part number 15, 39
- rubber antenna cover, illustrated 15

## S

- Screw Kit, spare part number 18
- security cable slot, identifying 9

- security, product description 3
- service considerations
  - cables 20
  - connectors 20
  - plastic parts 20
- service tag 12
- serviceability, product description 3
- setup utility
  - navigating and selecting 52, 56
  - restoring factory settings 53, 57
- slots
  - security cable 9
- solid-state drive
  - removal 31
  - spare part numbers 14, 17, 31
- speaker assembly
  - removal 51
  - spare part number 14, 51
- speaker, identifying 8
- specifications
  - computer 72
  - display 73
  - M.2 solid-state drive 74
- Startup Repair, using 64
- supported discs, recovery 68
- Sure Start
  - using 55, 59
- system board
  - removal 48
  - spare part numbers 14, 48
- system memory, removing personal data from volatile 75
- system recovery 69
- system restore point
  - creating 68
- system restore point, creating 67

## T

- tools required 20
- top cover
  - spare part number 14
- TouchPad
  - buttons 5
- Touchpad
  - removal 47
  - spare part number 47
- TouchPad light, identifying 6
- TouchPad zone
  - identifying 5
- TPM settings 55, 59

- transporting guidelines 21

## U

- USB 3.0 charging (powered), identifying 9, 10
- USB legacy support 52, 56
- USB Type-C (charging) port, identifying 9

## V

- video, product description 1

## W

- webcam 4
- webcam light, identifying 4
- webcam, identifying 4
- Windows
  - system restore point 67, 68
- Windows 7 operating system DVD
  - creating 62
  - using for restore 65
- Windows 7 operating system media
  - creating 62
  - using for restore 65
- Windows key, identifying 8
- Windows Startup Repair, using 64
- Windows tools
  - using 68
- wireless light 6
- wireless, product description 1
- WLAN antennas, identifying 4
- WLAN module
  - removal 33
  - spare part numbers 14, 33
- workstation guidelines 22