

PROPANE CONVERSION INSTRUCTIONS

⚠ WARNING Explosion Hazard

Death or serious injury can result from failure to follow these instructions.

- Service by a qualified service technician only.
- Shut off gas supply and disconnect power before servicing.
- Reconnect all grounding devices after service.
- Replace all parts and panels before operating.

The pressure regulator and the burner orifices are set for natural gas. To use propane gas, the regulator and burner orifices must be converted.

⚠ WARNING

Do not operate the cooktop or oven burners of this range when using propane (bottled) gas before converting the pressure regulator and burner orifices for propane gas use. Failure to do so could cause high flames and toxic fumes which can result in serious injury.

The propane orifices for the cooktop burners are shipped on the back of the range in the location shown.

Propane Conversion Kit

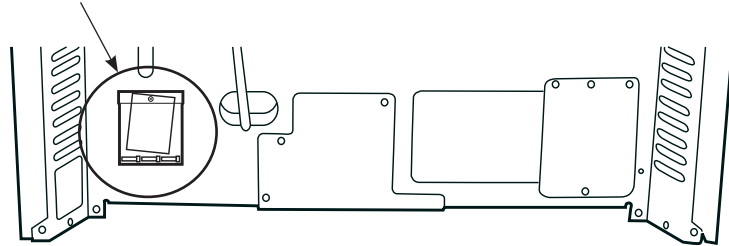

TOOLS REQUIRED:

- Adjustable wrench
- Socket wrench with 1/2" socket and extension
- Phillips head screwdriver
- Flat bladed screwdriver (blade approximately 3/32" across)
- Nut drivers: 1/4", 9/32" or 7mm

To adjust your range for use with propane gas, follow these instructions:

1. Disconnect all electrical power, at the main circuit breaker or fuse box.
2. Shut off the gas supply to the range by closing the manual shut-off valve.

CONVERTING THE PRESSURE REGULATOR

Remove the drawer and panel behind drawer. The pressure regulator is located in the lower, left hand rear corner of the range as viewed from the front.

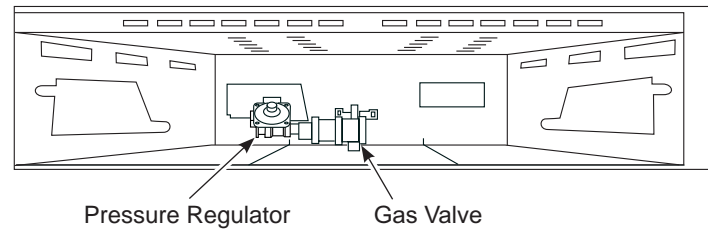

1. Use an adjustable wrench to unscrew the hex-nut cap from the pressure regulator.
2. Completely remove the protective plastic cap off the threaded metal cap.

Rotate cap counter-clockwise to loosen

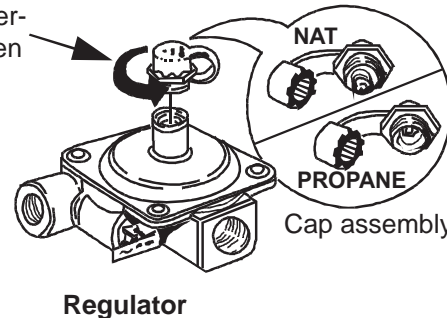

3. Turn the metal cap so the type of gas being converted to is displayed and replace the protective plastic cover.
4. Screw the hex-nut cap back into the regulator. **(Do not over tighten)**

CONVERTING THE COOKTOP BURNERS

- A. Remove the top grates, burner caps and burner heads.
- B. Using a 7 mm or 9/32" nut driver, remove the top burner orifices. These may be accessed through the burner opening in the base.

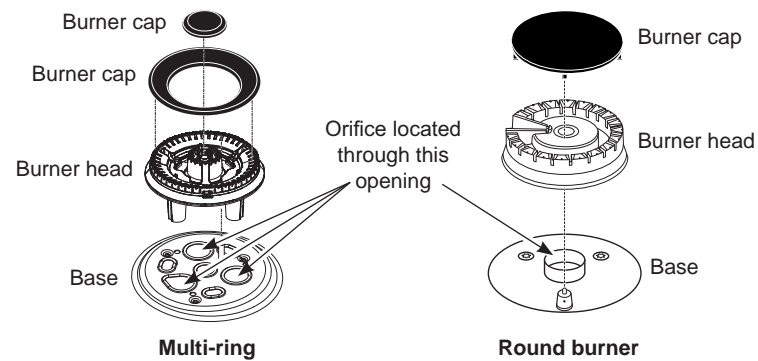

NOTICE:

Save these orifices for future conversion back to natural gas.

- C. Remove the propane orifices from the box provided. The propane orifices have the letter "L" on the top. To aid in identifying the proper location for the propane orifices during conversion from Natural Gas to Propane Gas, color codes have been added to the side or top of the orifice. See the chart below. Each orifice may also show a series of engraved marks (I, II, III . . .) located on the top.

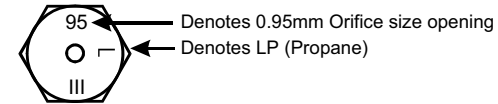

BURNER OUTPUT RATINGS: BTU/HR				
Propane Gas 10" W.C.P.				
BURNER	BTU RATE	ORIFICE SIZE (in)	COLOR	MARKING
LF	18,000			
LF1	N/A	0.027	None	69L
LF2	N/A	0.027	None	69L
LF3	N/A	0.027	None	69L
LFC	N/A	0.016	None	40L
LR	5,000	0.026	Red/Yellow	66L
RF	18,000	0.049	None	125L
RR	9,500	0.0365	Orange/Light Blue	92L
C	8,000	0.034	Orange/Green	86L

- D. Install the propane orifices in their precise locations.

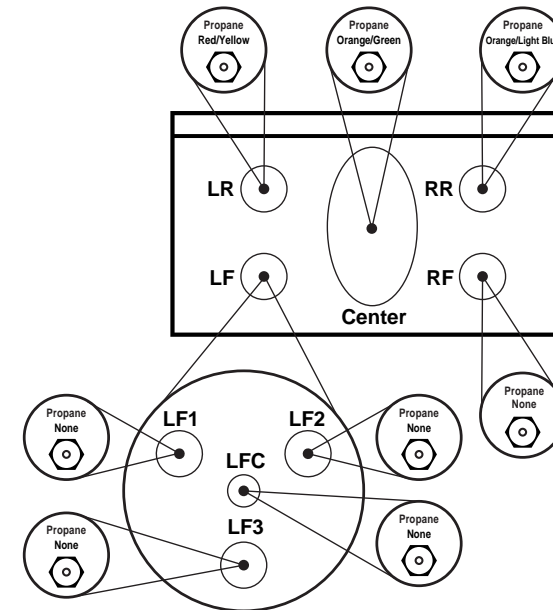

To prevent leakage, make sure the orifice spuds are securely screwed into the gas supply tubes.

- E. Install the old orifice spuds into the metal box or bracket along with these instructions, and replace onto the back of the range for possible future conversion.

CHECK SURFACE BURNERS

Push and turn a knob to the LITE position. A clicking sound indicates proper operation of the ignition system. When lighting any burner, sparks will appear at all burners but gas flows from only the one selected. Once air is purged from the supply line, burner should light within 4 seconds. After burner lights, rotate the knob out of the LITE position. Try each burner in succession until all burners have been checked.

Quality of Flames

Determine the quality of flames visually. Normal burner flames should look like (A) or (B).

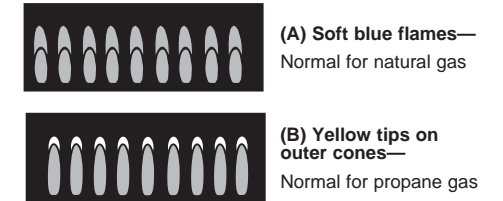

Long, bright yellow flames are not normal. Normal flames may show signs of an orange tint when well heated or signs of flickering orange due to particles in the gas or air.

ADJUSTING LOW FLAME SETTING ON COOKTOP BURNERS

Low setting adjustments must be made with other burners in operation on a medium setting. This procedure prevents the low flame from being set too low, resulting in the flame being extinguished when other burners are turned on.

- Turn on all surface burners to medium setting.
- Turn the knob on the burner being adjusted to "LO".
- Remove the knob and insert a small, flat blade screwdriver into the valve shaft and/or side adjustment screw(s) as shown and turn clockwise to fully tighten down the bypass screw(s). Repeat for all valves.
- If flame appears too low or unstable, slowly turn bypass screw counterclockwise until a stable flame exists for each burner. Remember, other burners must be turned on to medium.

SPECIALTY BURNERS

Multi-Ring Burner – The outer ring of flames should be adjusted with the knob at the MED by adjusting the set screw in the center valve shaft. The flames should be adjusted so that they barely curl over the top edge of the burner cap. The center ring of flames should be adjusted with the knob at the LO setting by adjusting the set screw to the right of the valve shaft.

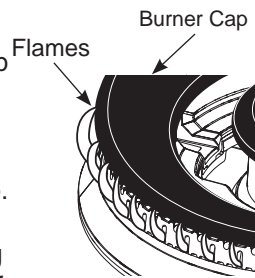

- Additionally, for each burner being adjusted, quickly open and close the oven door while observing flame. If flame is extinguished, continue adjusting bypass screw for a larger flame. Repeat door openings until flame is stable.

- Replace the knob.

Adjustment screw for outer ring

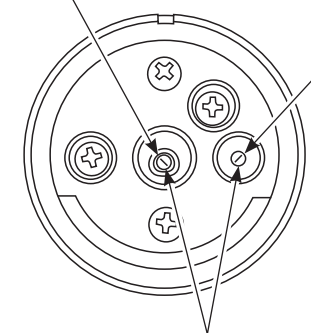

Adjustment screw for center ring

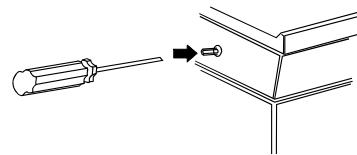

Center adjustment screw

Adjustment screws for multi-ring burner only

SPECIAL NOTE:

To convert the oven back to natural gas, reverse the instructions given in making propane adjustments.

NOTICE:

Once the conversion is complete and confirmed, fill out the propane sticker and include your name, organization and date conversion was made. Apply the sticker to the range near the regulator to alert others in the future that this appliance has been converted to propane. If converting back to natural gas from propane, please remove the sticker so others know the appliance is set to use natural gas.

ADDITIONAL INFORMATION

BURNER OUTPUT RATINGS: BTU/HR

NG (Natural) Gas 5" W.C.P.

BURNER	BTU RATE	ORIFICE SIZE (in)	COLOR	MARKING
LF	21,000			
LF1	N/A	0.045	None	114N
LF2	N/A	0.045	None	114N
LF3	N/A	0.045	None	114N
LFC	N/A	0.025	None	63N
LR	5,000	0.040	White/Purple	101N
RF	18,000	0.078	Purple	198N
RR	9,500	0.0555	Yellow	141N
C	10,000	0.055	Yellow	140N

