

ME17R7021ES

1.7 cu. ft. Over-the-Range Microwave

SAMSUNG



Signature Features

1.7 cu. ft. Capacity

- The 1.7 cu. ft. capacity of this microwave accommodates a variety of snacks and meal items and lets you prepare foods quickly and easily.





Fingerprint Resistant

- Special coated exterior ensures your microwave remains spotless even with daily use.

300 CFM Ventilation System

- Powerful 300 CFM ventilation fan quickly and quietly eliminates food odors.

Available Colors

-  Fingerprint Resistant Stainless Steel (shown)
-  Fingerprint Resistant Black Stainless Steel
-  White
-  Black

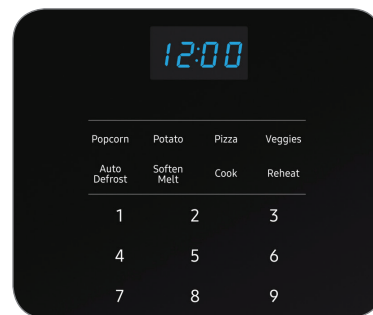

LED Display



300 CFM Ventilation System

Features

- 1000 Watts of Cooking Power
- LED Display
- Charcoal/Grease Vent Filter
- 10 Power Levels
- Two-Stage Programmable Cooking
- Auto Defrost/Auto Reheat
- Auto Cook
- Microwave Distribution System: Turntable

Convenience

- Kitchen Timer
- Clock (12 hr/24 hr) with Daylight Saving Time Adjustment
- Child Safety Lock
- Reminder End Signal
- Interior Light: Incandescent (1)
- Cooktop Lighting: High/Low/Off
- Vent Fan Control: High/Low/Off
- Sound On/Off
- Eco Mode (Reduces Standby Power)

ME17R7021ES

1.7 cu. ft. Over-the-Range Microwave

SAMSUNG

Dimensions

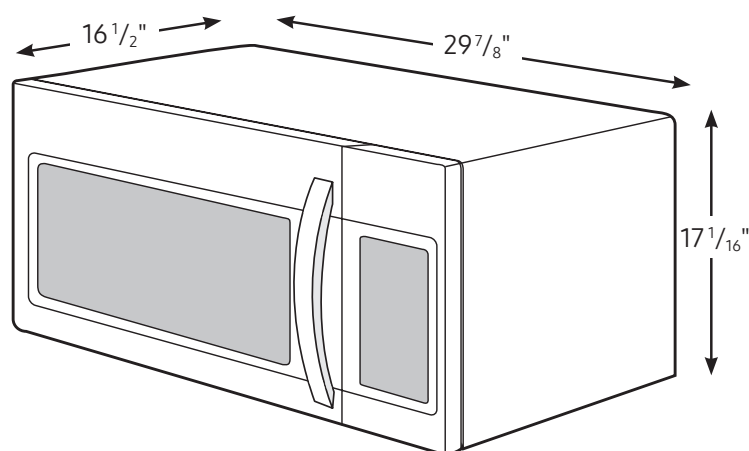

Installing Your Microwave

- This microwave oven is designed for adaptation to the following three types of ventilation:
 - A. Outside Top Exhaust (Vertical Duct)
 - B. Recirculating (Non-Vented Ductless)
 - C. Outside Back Exhaust (Horizontal Duct)
- The space between the cabinets must be 30" wide and free of obstructions.
- This microwave oven is for installation over ranges up to 36" wide.
- The microwave must be level. Use a level to make sure the cabinet bottom is level. If the cabinets have a front overhang only, with no back or side frame, install the mounting plate down the same distance as the front overhang depth. This will keep the microwave level.

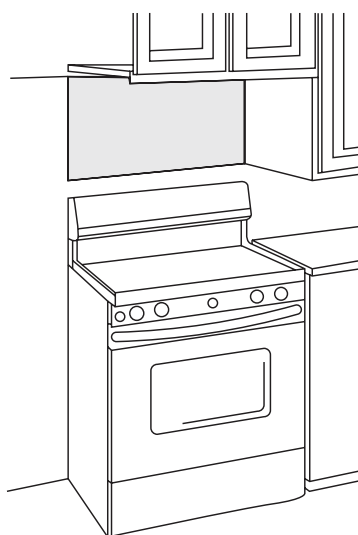

Specifications

- Oven Cavity: 1.7 cu. ft.
- Power Output: 1000W
- Power Consumption: 1580W/13.5 A
- Power Source: 120V/60 Hz
- Control Method: Digital (Membrane Touch)
- Display: LED
- Cooking Control: 10 Power Levels Including Defrost
- Cooking Timer: Digital, up to 99 Minutes, 99 Seconds
- Microwave Distribution System: Turntable
- Glass Turntable Diameter: 11 1/2"
- Vent Fan: 300 CFM
- Vent Fan Control: High/Low/Off
- Cooktop Lighting: High/Low/Off

Warranty

One (1) Year Parts and Labor
Ten (10) Years Parts on Magnetron

Product Dimensions & Weight (WxHxD)

Cavity Dimensions: 19⁵/₁₆" x 9⁵/₈" x 14³/₈"
Outside Net Dimensions: 29⁷/₈" x 17¹/₁₆" x 16¹/₂"
Weight: 48.3 lbs. (Fingerprint Resistant Stainless Steel,
Fingerprint Resistant Black Stainless Steel)
47.0 lbs. (White, Black)

Shipping Dimensions & Weight (WxHxD)

Dimensions: 33³/₈" x 20¹³/₁₆" x 19³/₈"
Weight: 55.1 lbs. (Fingerprint Resistant Stainless Steel,
Fingerprint Resistant Black Stainless Steel)
54.0 lbs. (White, Black)

Color	Model #	UPC Code
Fingerprint Resistant Stainless Steel	ME17R7021ES	887276348049
Fingerprint Resistant Black Stainless Steel	ME17R7021EG	887276390024
White	ME17R7021EW	887276348636
Black	ME17R7021EB	887276348612

FOR EASIER INSTALLATION AND PERSONAL SAFETY, WE RECOMMEND THAT TWO PEOPLE INSTALL THIS MICROWAVE OVEN. IMPORTANT: Do not grip or use handle during installation.

NOTE: If your cabinet is metal, use the nylon grommet around the power cord hole to prevent cutting of the cord.

NOTE: We recommend using filler blocks if the cabinet front hangs below the cabinet bottom shelf.

IMPORTANT: If filler blocks are not used, case damage may occur from overtightening screws.

NOTE: When mounting the microwave oven, thread power cord through hole in bottom of top cabinet. Do not pinch cord or lift oven by pulling cord.